



BROMED
INSTRUMENTS

Das Instrument.

Veterinärchirurgie | nachtrag

Chirurgie vétérinaire | ajout

Cirurgía veterinaria | anexo

Chirurgia veterinaria | aggiunta



Veterinary Surgery | addendum

Laringoscopio
MC INTOSH



AA-B100
2,5 Volt
300 mA

Für Spatel **AA-100**
For blades **AA-100**
Per lama **AA-100**
Para hojas **AA-100**
Pour spatules **AA-100**



AA-B101
2,5 Volt
300 mA

Für Spatel **AA-101 + AA-104**
For blades **AA-101 + AA-104**
Per lame **AA-101 + AA-104**
Para hojas **AA-101 + AA-104**
Pour spatules **AA-101 + AA-104**

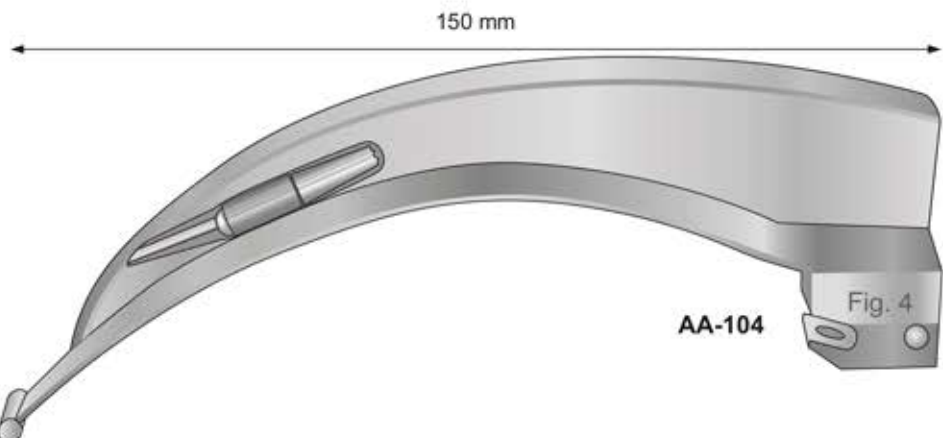
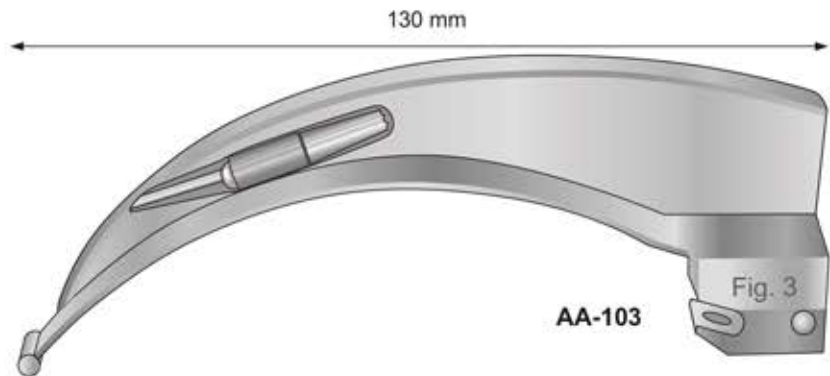
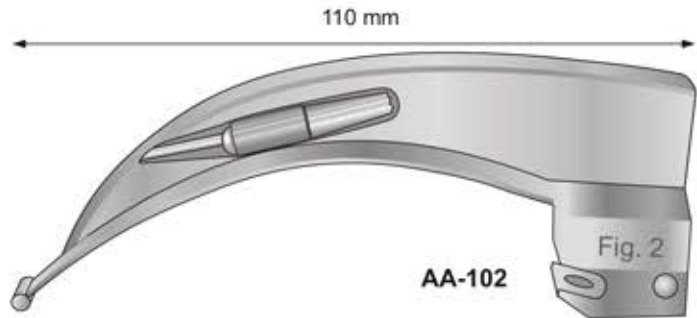
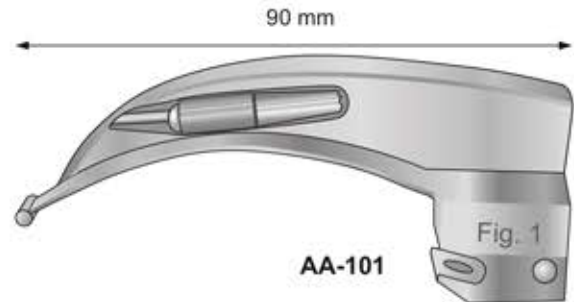
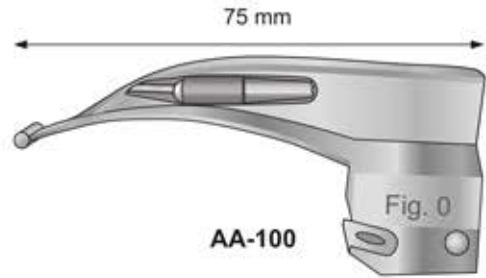

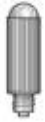
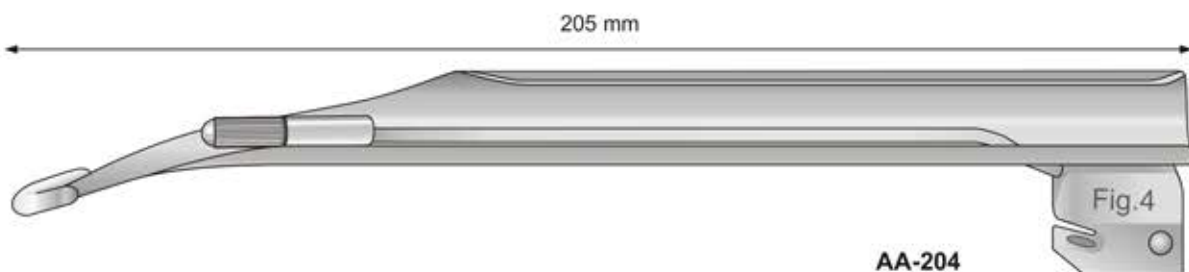
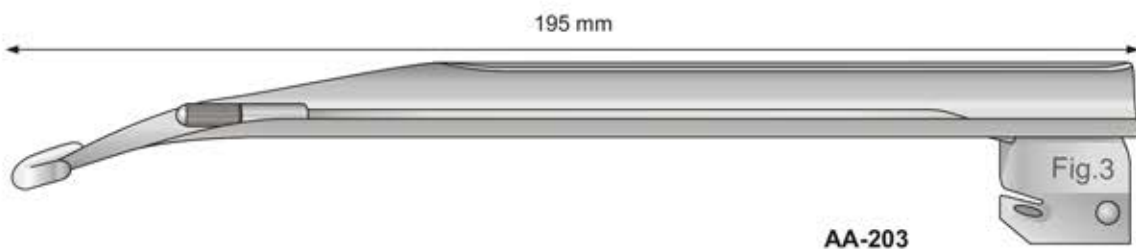
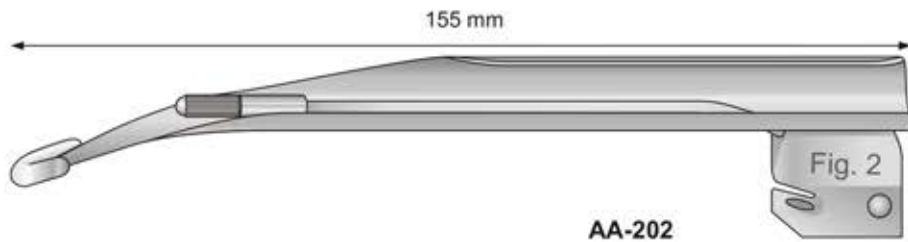
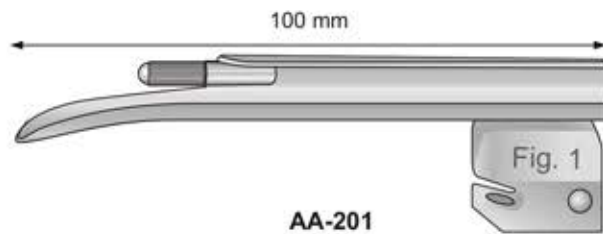
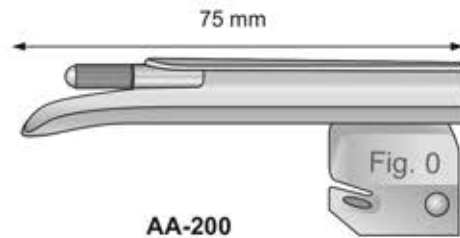
Laringoscopio
MILLER**AA-B100**2,5 Volt
300 mAFür Spatel **AA-200 + AA-203**
For blades **AA-200 + AA-203**
Per lame **AA-200 + AA-203**
Para hojas **AA-200 + AA-203**
Pour spatules **AA-200 + AA-203****AA-B101**2,5 Volt
300 mAFür Spatel **AA-204**
For blades **AA-204**
Per lama **AA-204**
Para hojas **AA-204**
Pour spatules **AA-204**

Laringoscopio
NEGUS - GUEDEL



AA-B100

2,5 Volt
300 mA

Für Spatel **AA-401**
For blades **AA-401**
Per lama **AA-401**
Para hojas **AA-401**
Pour spatules **AA-401**

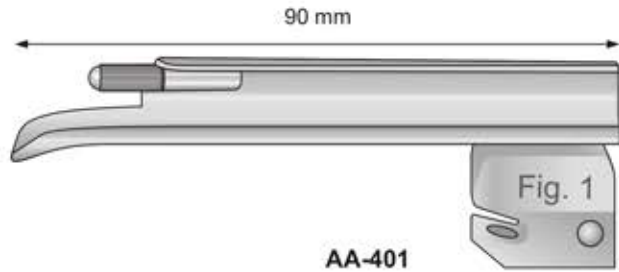

AA-401



AA-B101

2,5 Volt
300 mA

Für Spatel **AA-402 + AA-404**
For blades **AA-402 + AA-404**
Per lame **AA-402 + AA-404**
Para hojas **AA-402 + AA-404**
Pour spatules **AA-402 + AA-404**

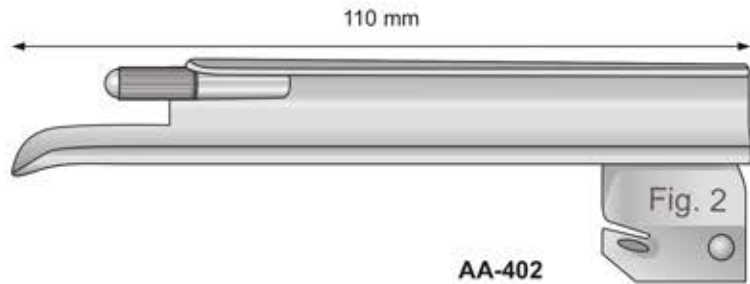

AA-402

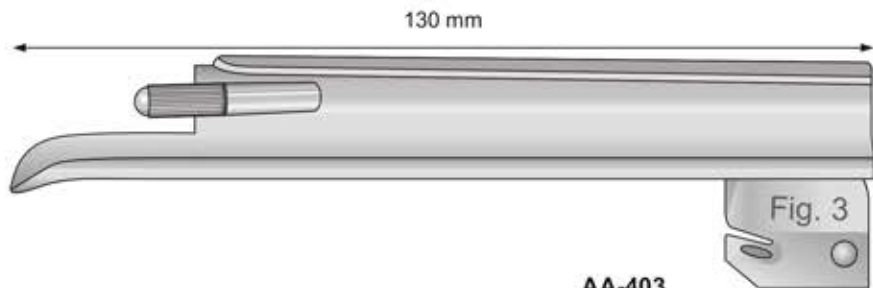

AA-403

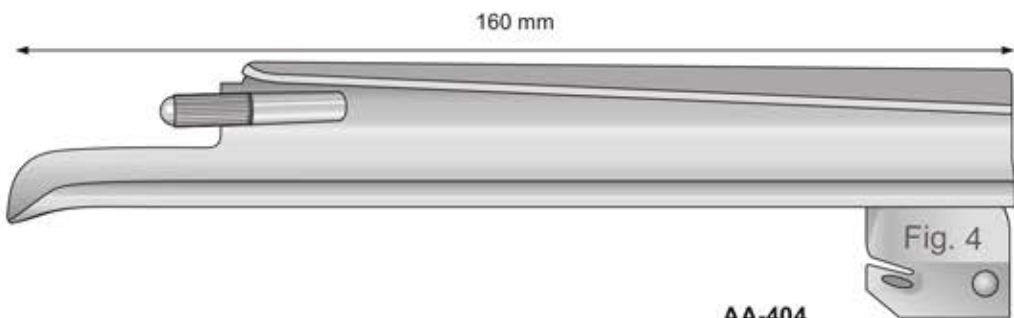

AA-404

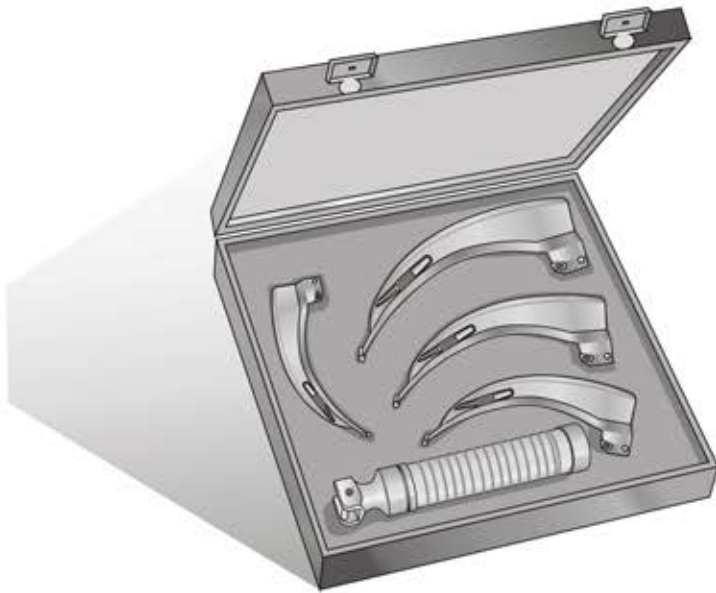

Mc INTOSH
AA-S103 - Set 3 lame
AA-S104 - Set 4 lame
AA-S105 - Set 5 lame

MILLER
AA-S203 - Set 3 lame
AA-S204 - Set 4 lame
AA-S205 - Set 5 lame

NEGUS-GUEDEL
AA-S403 - Set 3 lame
AA-S404 - Set 4 lame

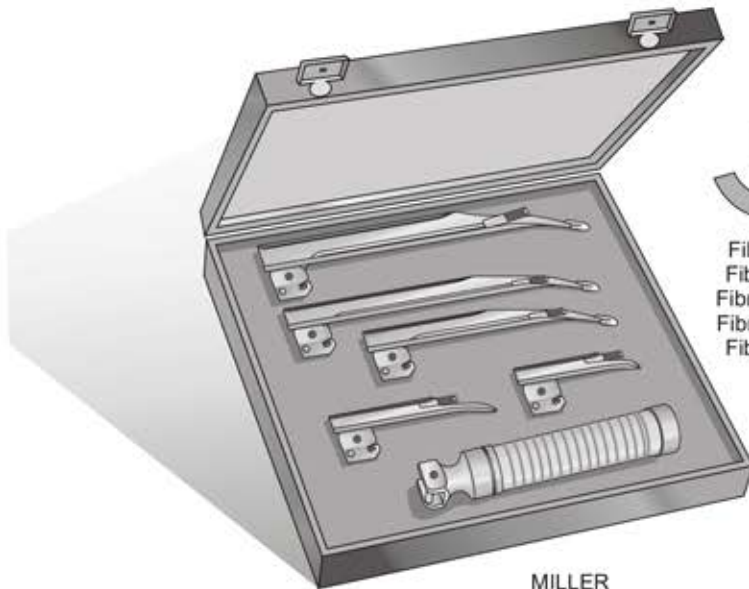

Fiberoptik
 Fiber optic
 Fibre ottiche
 Fibra Óptica
 Fibre optic

MILLER
AA-S255

MILLER
Fibre ottiche
AA-S253 - Set 3 lame
AA-S254 - Set 4 lame
AA-S255 - Set 5 lame

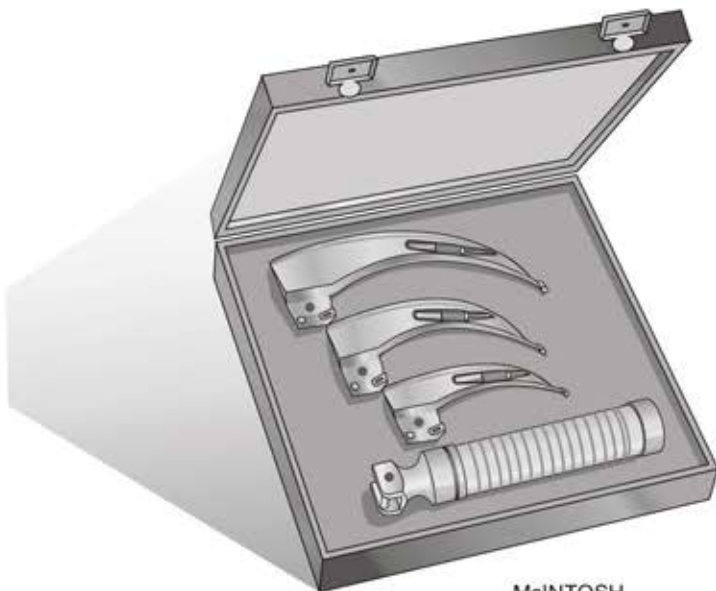

Fiberoptik
 Fiber optic
 Fibre ottiche
 Fibra Óptica
 Fibre optic

McINTOSH
AA-S503

Mc INTOSH
Fibre ottiche
AA-S503 - Set 3 lame
AA-S504 - Set 4 lame
AA-S505 - Set 5 lame



AA-T60
Ø 30 mm

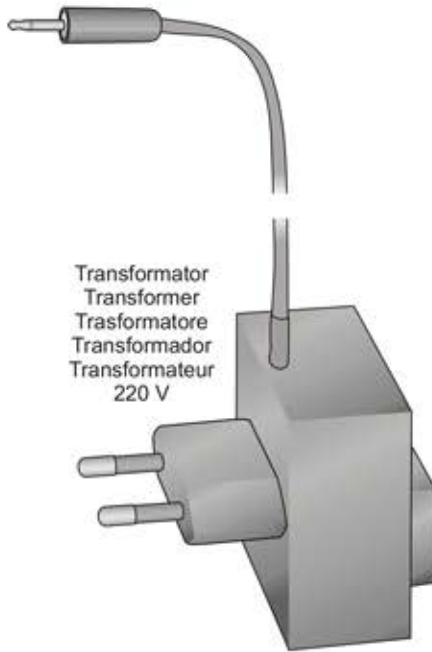

Transformator
Transformer
Trasformatore
Transformador
Transformateur
220 V

AA-151

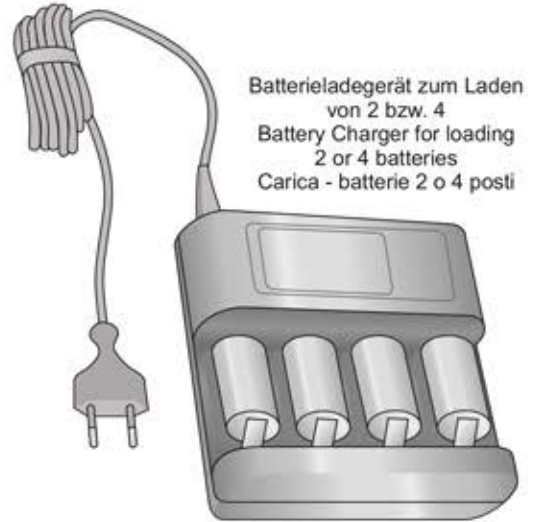

Batterieladegerät zum Laden
von 2 bzw. 4
Battery Charger for loading
2 or 4 batteries
Carica - batterie 2 o 4 posti

AA-153

Halogenlampe - Halogen lamp
Lampada alogene - Lâmpara Houlógeno
Lampe halogène



AA-130
640 mA



AA-B100
2,5 Volt
300 mA



AA-B101
2,5 Volt
300 mA

Griffe aus Rostfreiem Edelstahl - Handles of stainless steel - Manico in Acciaio Inossidabile
Manico de acero inoxidable - Manche Acier inoxydable



AA-70
Ø 30 mm



AA-80
Ø 18 mm

Kaltlichtgriff
Fiberoptic Handle
Manico Fibre ottiche
Mango de fibra óptica
Manche fibre optic



AA-90H
Ø 30 mm

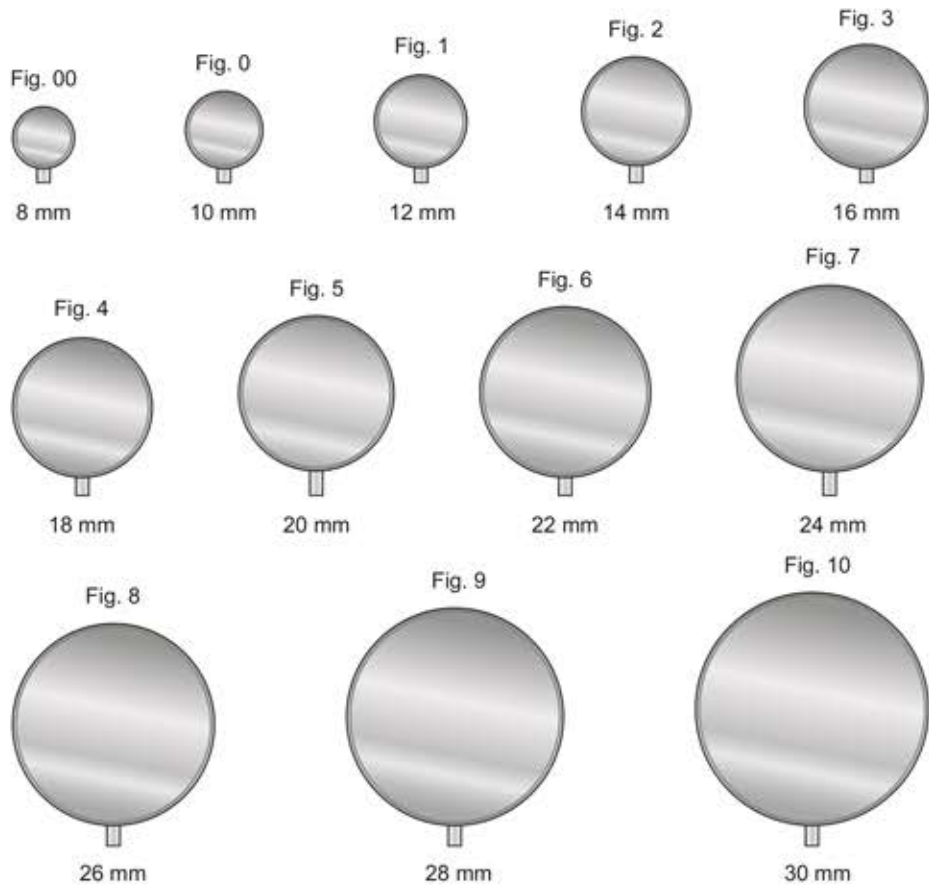

Kehlkopfspiegel mit Sechskantgriff
 Laryngeal mirrors with hexagonal handle
 Specchietto laringeo con manico esagonale
 Espejos laringeos con manico exagonal
 Miroirs laryngiens avec manche hexagonal

Inox

Spiegeldurchmesser - Diameter of mirrors - Diametro dello specchio
 Diámetro de los espejos - Diamètre des miroirs

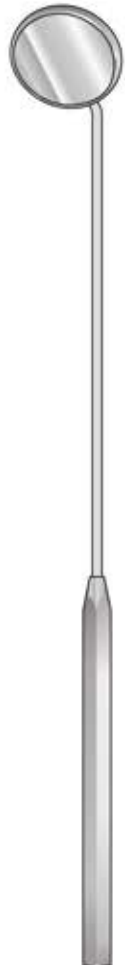

G-8/G-30
180 mm

Spiegelgriff
 Mirrors handle
 Manico per specchietti
 Manico para espejos
 Manche à miroir

Nikel-Chrom



MA-6
120 mm

Kehlkopfspiegel
 Laryngeal mirrors
 Specchietto laringeo
 Espejos laringeos
 Miroirs laryngiens



P-00/P-06
120 mm

	Fig.
G- 8	00
G-10	0
G-12	1
G-14	2
G-16	3
G-18	4
G-20	5
G-22	6
G-24	7
G-26	8
G-28	9
G-30	10

	Fig.
P-00	00
P- 0	0
P-01	1
P-02	2
P-03	3
P-04	4
P-05	5
P-06	6

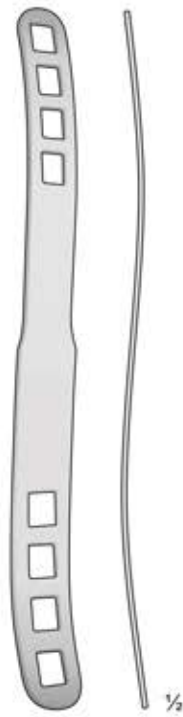

BRUENINGS
OM-04
190 mm

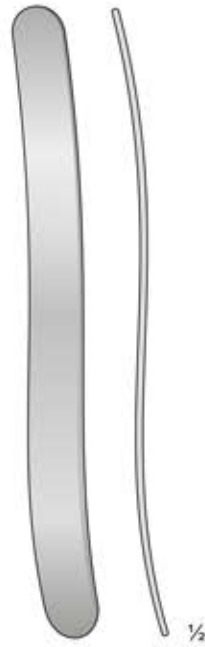

OM-05
145 mm



OM-07
145 mm

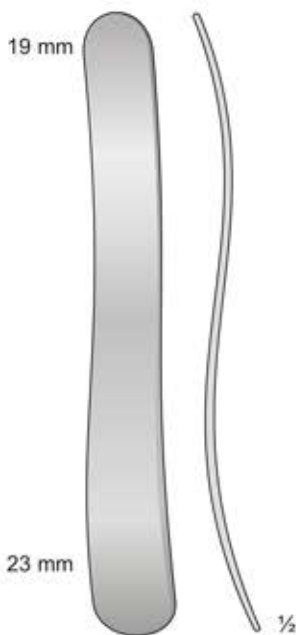

KROENIG
OM-16
150 mm

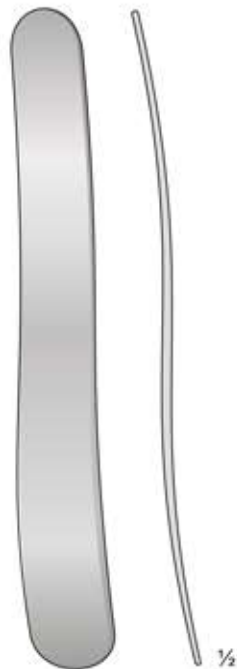

MAYO
OM-17
170 mm

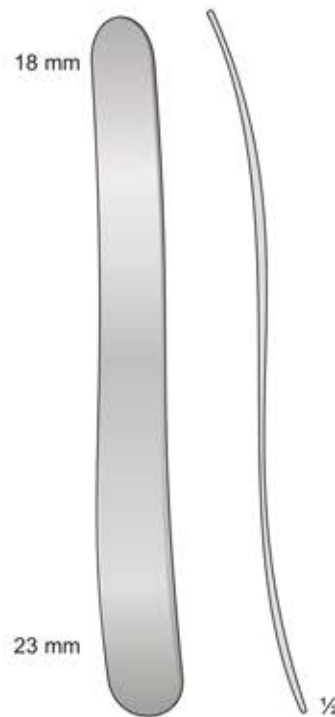

BUCHWALD
OM-18
180 mm

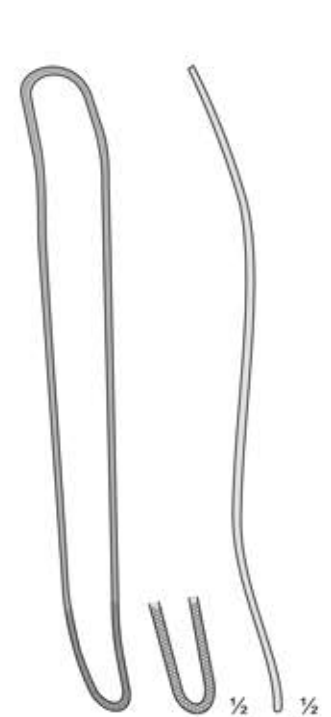

FRENZEL
OM-19
165 mm

Retractor reflectantes
Retratore riflettente

2,2 mm

3,0 mm



FAHRENKRUG
DL-05
190 mm

FAHRENKRUG
DL-06
190 mm

FAHRENKRUG
DL-56
240 mm

Strumento per denti
dei conigli

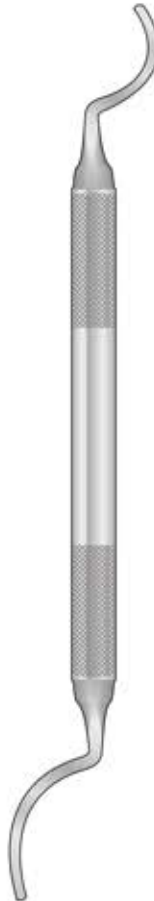

VF-126
160 mm

Zange zum Abkneifen von Ferkeelzähnen
Forceps for trimming teeth for small animals
Pinza per tagliare denti a piccoli animali
Pinza para cortar dientes en pequeños animales

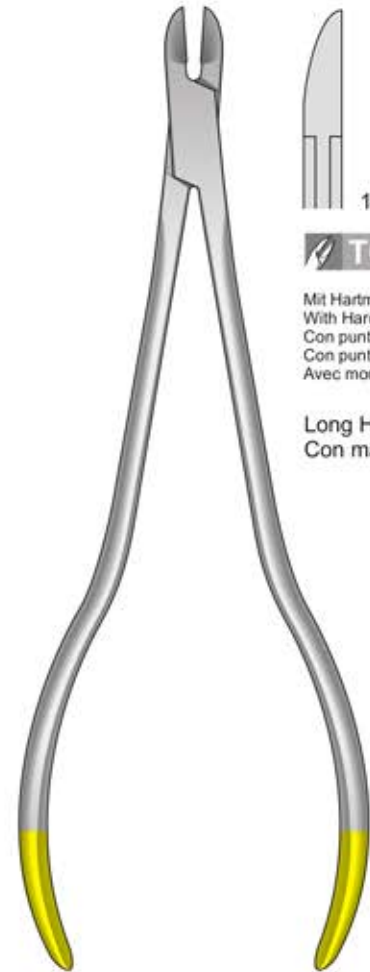

1/1



Mit Hartmetalleinsätzen
With Hard Metal Inserts
Con punte in metallo duro
Con puntas de metal duro
Avec mors en métal dur

Long Handle
Con manici lunghi

LX-98
175 mm

Entrambi lati taglienti

Spitz
Sharp
Acuta
Agudas
Pointu

Stumpf
Blunt
Smussa
Romas
Mousse

Spitz
Sharp
Acuta
Agudas
Pointu

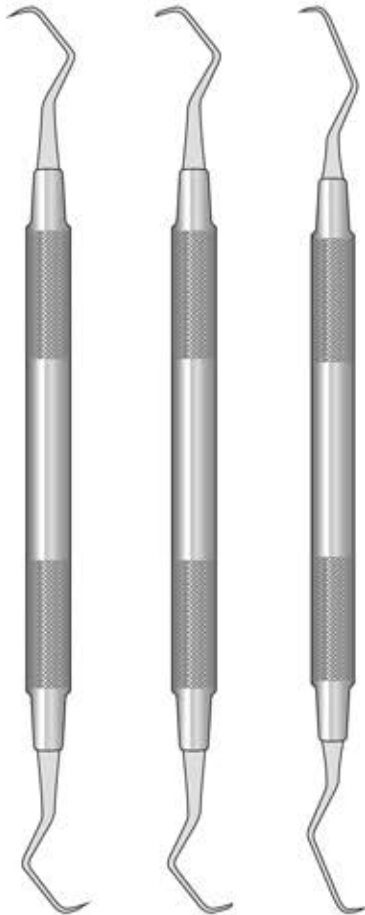

718-M23
165 mm

718-M23A
165 mm

718-M23B
170 mm



SD-M

Cervical Blades
Lame cervicali
Hojas cervical
Lames pour syndesmotome



L-0

L-1

L-2

L-3

L-4

L-5

L-6

L-7

L-8

L-9

L-11

Apical Blades
Lame apicali
Hojas apical



L-21

L-22 L-23

L-24

L-25

L-26

L-27

L-28

L-29

Spitz
Pointed
Acute
Agudas
Pointus

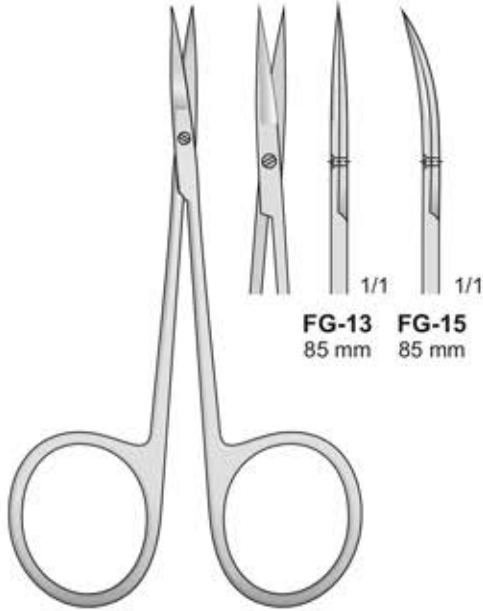

MICRO-IRIS
FG-13/FG-15
85 mm

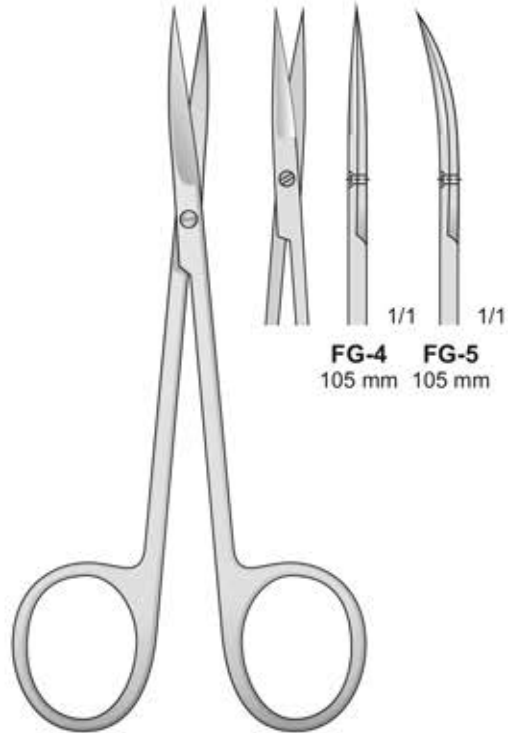

FG-4/FG-5
105 mm

Stumpf - Blunt
Smussa - Romo - Émoussé

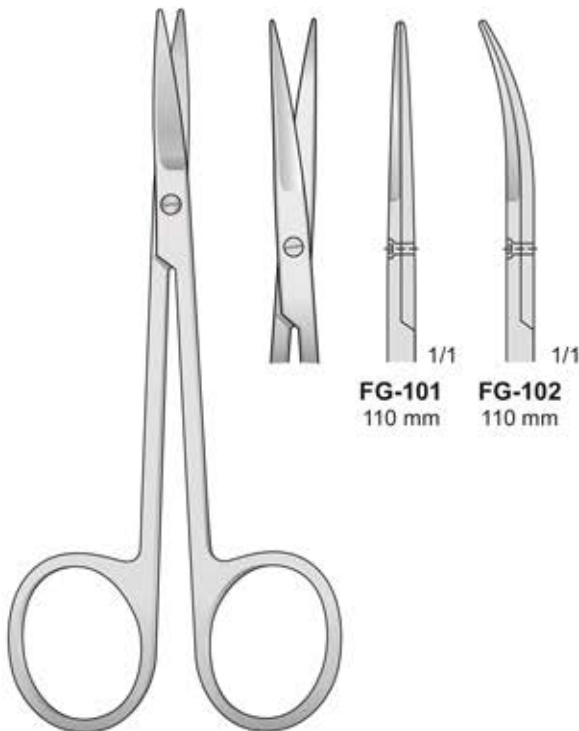

FG-101/FG-102
110 mm

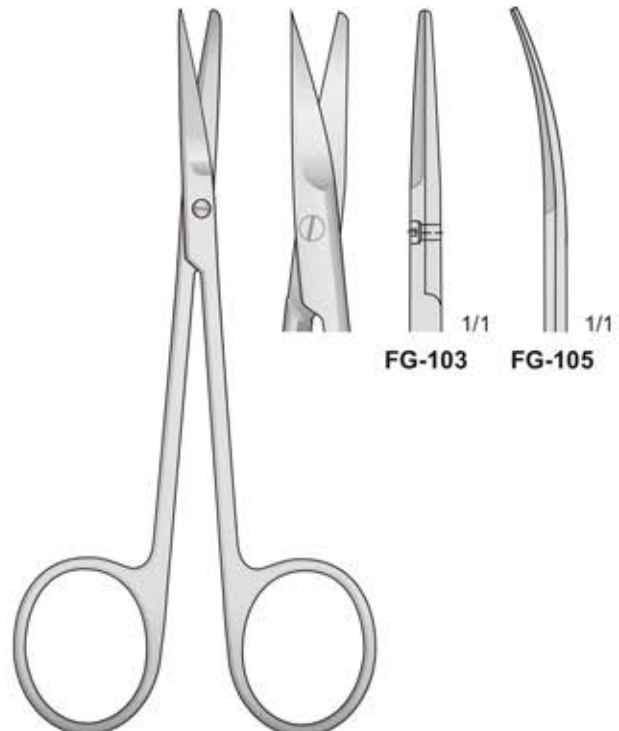

FG-103/FG-105
110 mm

Spitz - Sharp
Acuta - Agudo - Aigu



FM-126

FM-127

METZENBAUM
FM-126/FM-127
145 mm

Spitz
Pointed
Acute
Agudas
Pointus

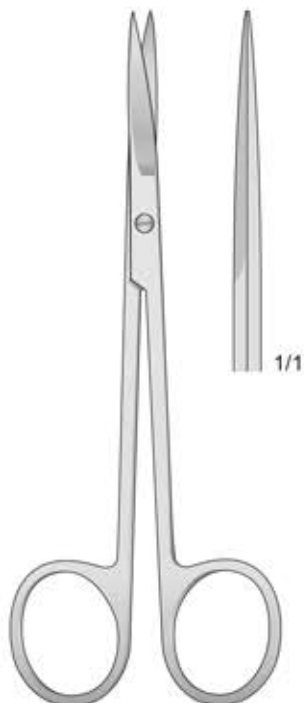

METZENBAUM
FG-28
145 mm

Spitz
Pointed
Acute
Agudas
Pointus

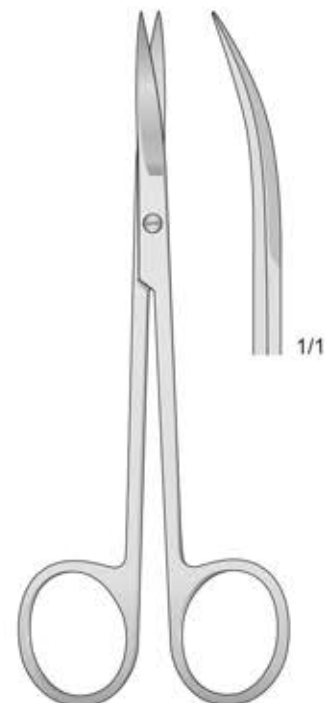

METZENBAUM
FG-14
145 mm

Stumpf - Blunt - Smusse - Romas - Mousses

Spitz - Pointed - Acute - Agudas - Pointus

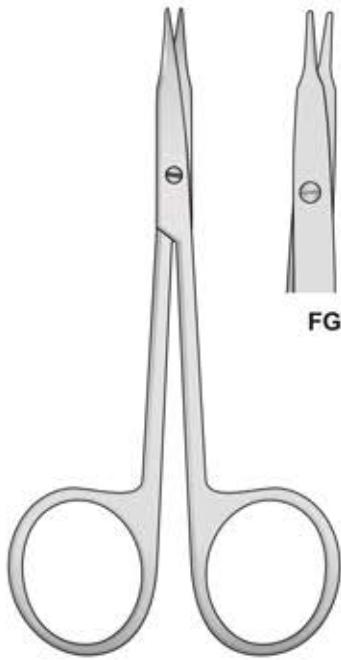

FG-50



FG-51

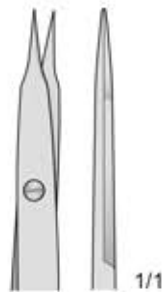

FG-52



FG-53

STEVENS
FG-50/FG-53
110 mm

Stumpf - Blunt - Smussa
Romas - Mousse

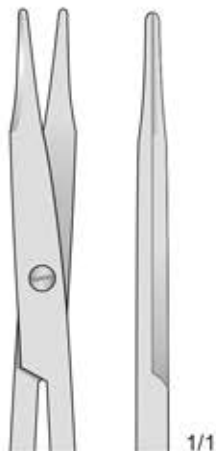
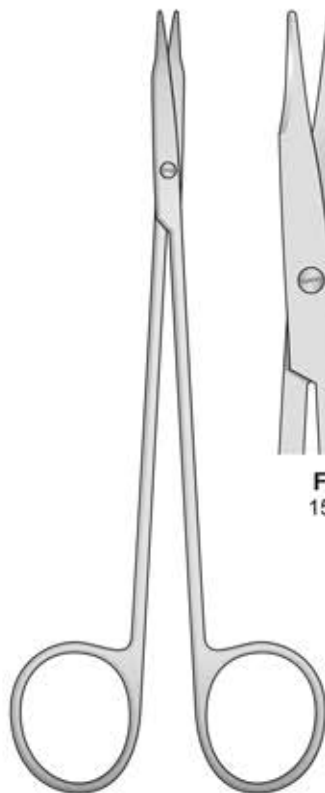

FG-54
150 mm

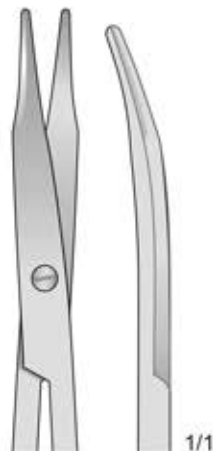

FG-55
150 mm

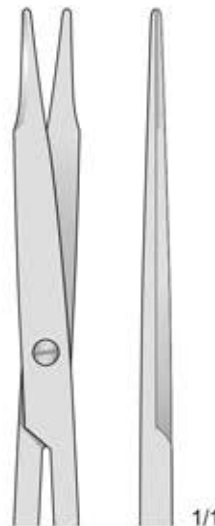

FG-56
180 mm

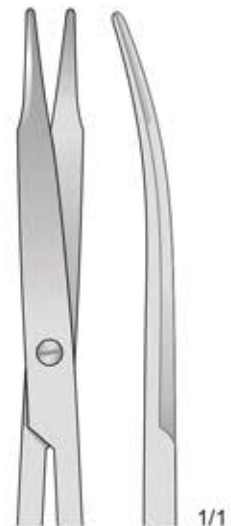

FG-57
180 mm

REYNOLDS
FG-54/FG-57

Mit faden bohrung - With eye for suture
Con occhiello per sutura - Tijeras para ligaduras
Avec oeil pour les sutures

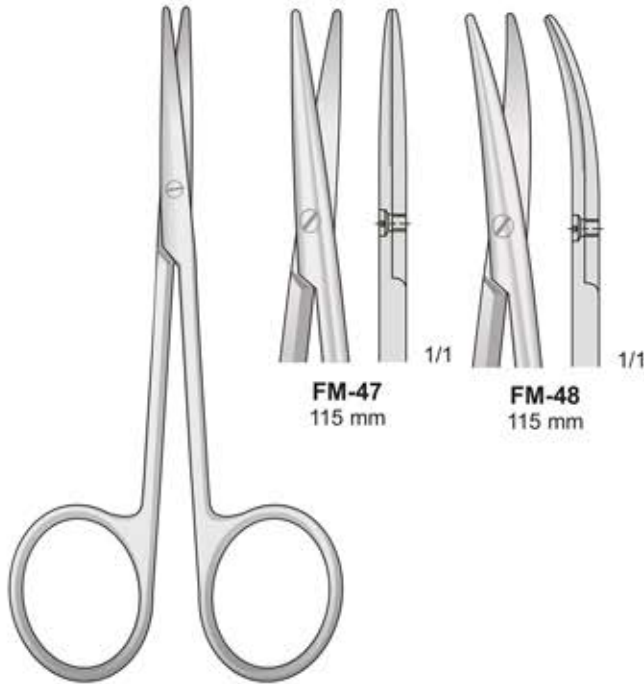

FM-47
115 mm

FM-48
115 mm

BABY - METZENBAUM
FM-47/FM-48
115 mm

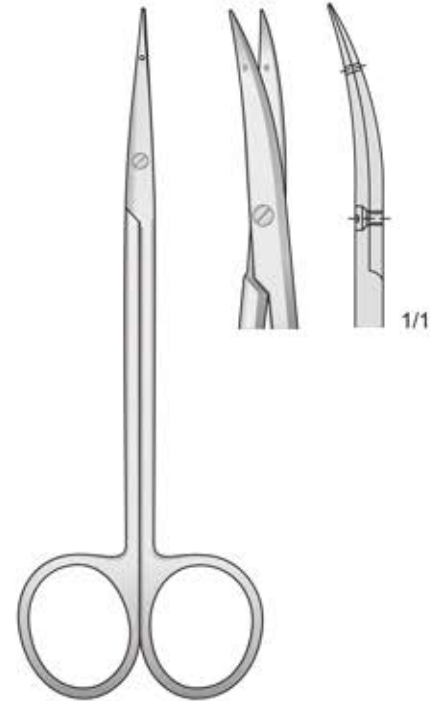

LITTLER
FG-100
120 mm

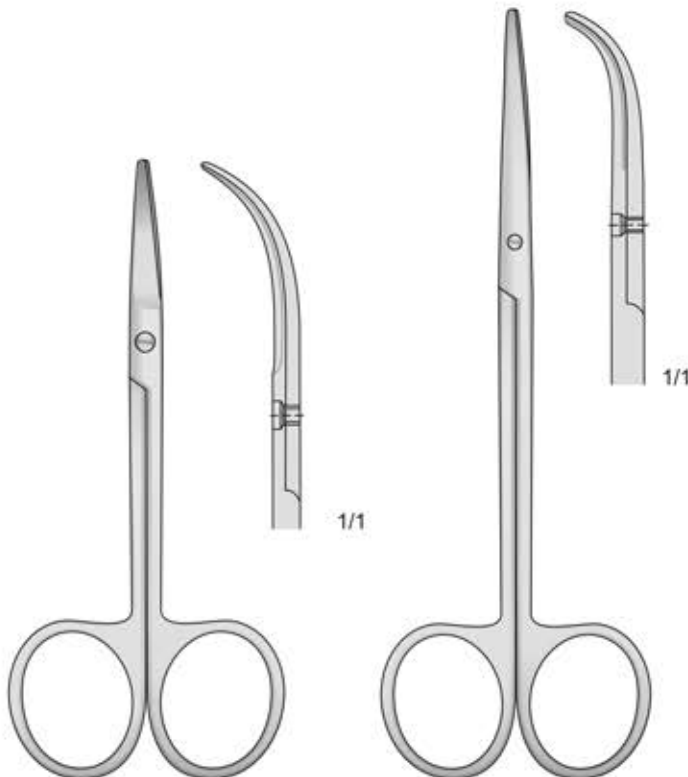

FOMON
FG-43
110 mm

FG-44
140 mm

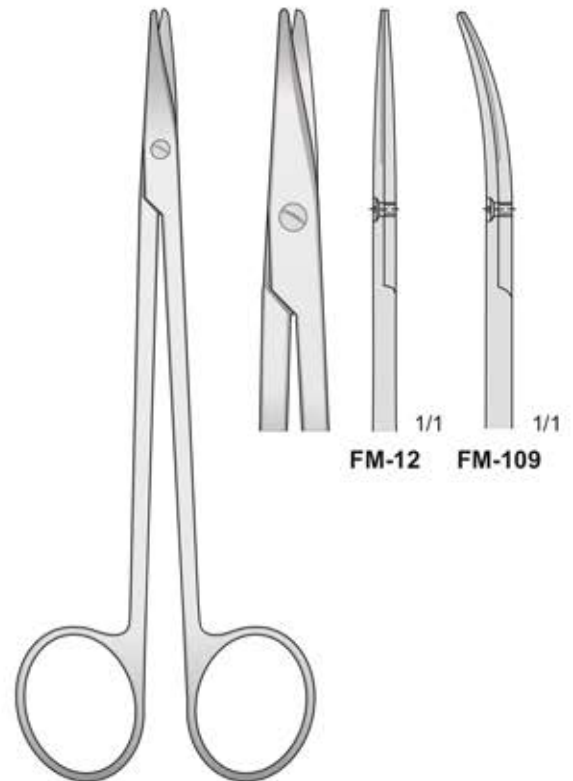

METZENBAUM
FM-12/FM-109
150 mm

Gezahnt - Sawedge - Dentellata - Dentadas - Dentelé

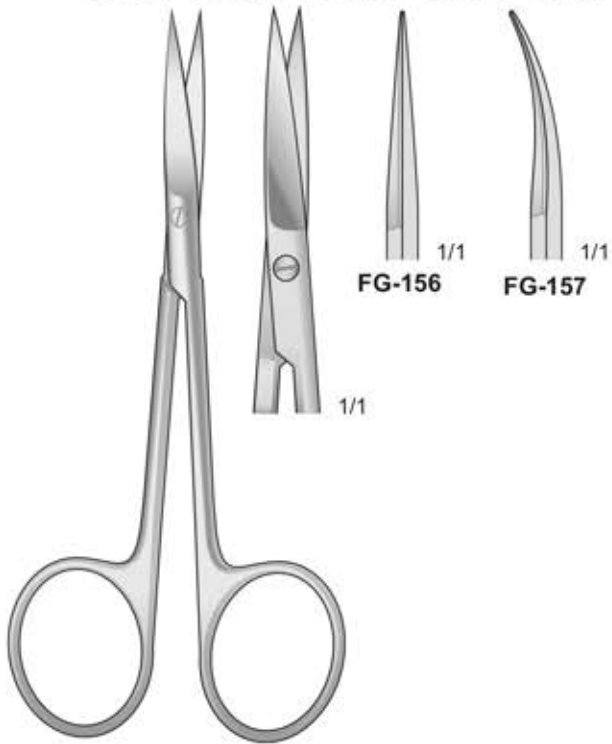

FG-156/FG-157
110 mm

Gezahnt - Sawedge - Dentellata - Dentadas - Dentelé

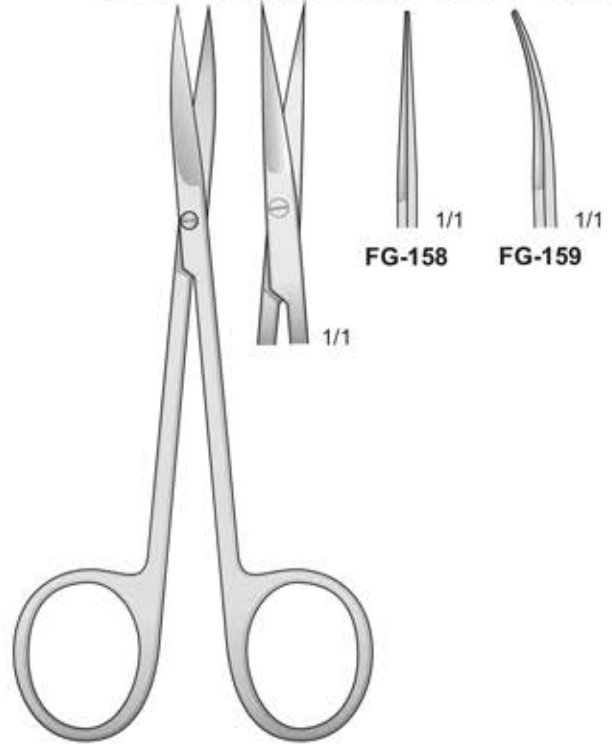

FG-158/FG-159
110 mm

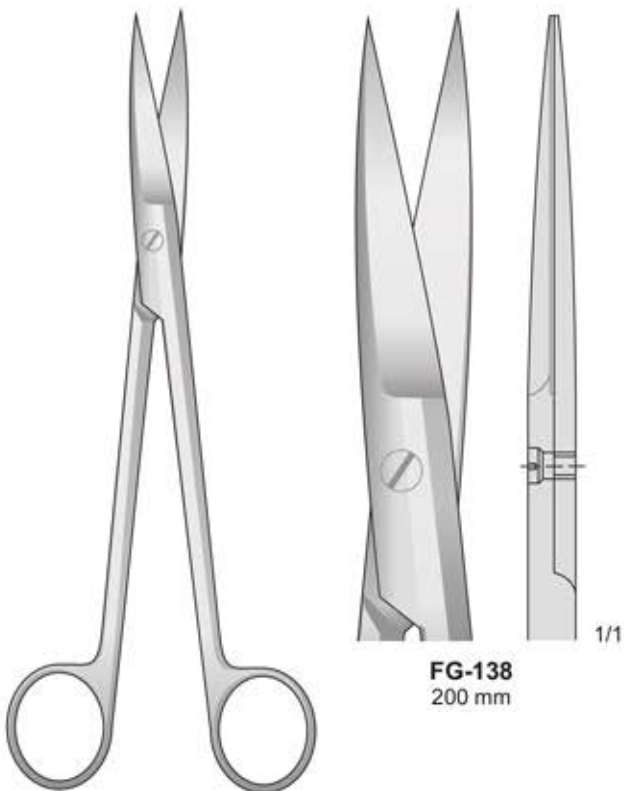

SIMS
FG-138
200 mm

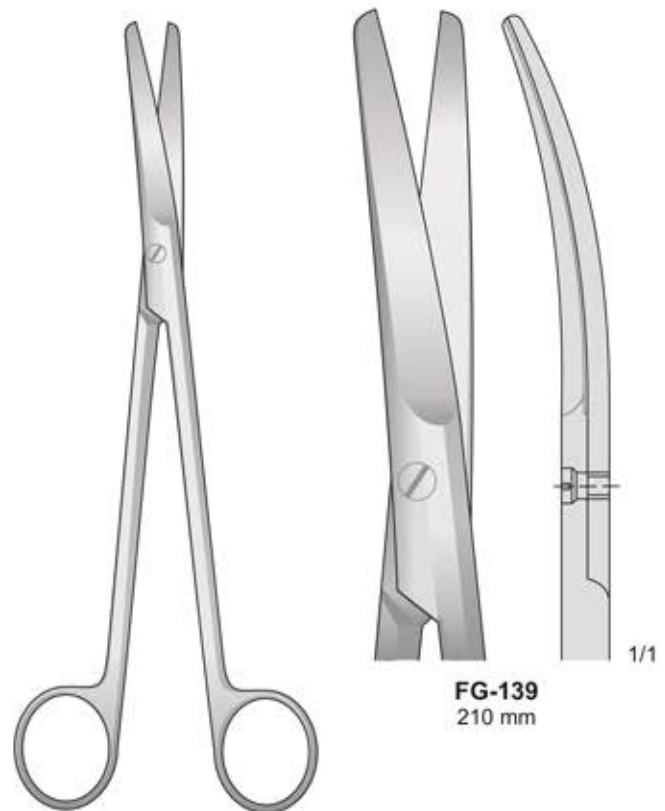

SIMS
FG-139
210 mm

Präparierscheren - Dissecting Scissors
Forbici per dissezione - Tijeras para preparaciones - Ciseaux à dissection

Spitz - Sharp
Acuta - Agudo - Aigu

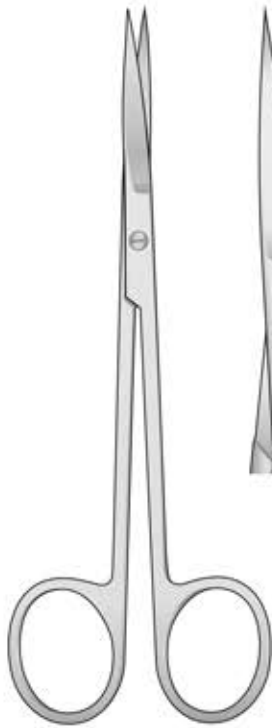

METZENBAUM
FG-28/FG-14
145 mm

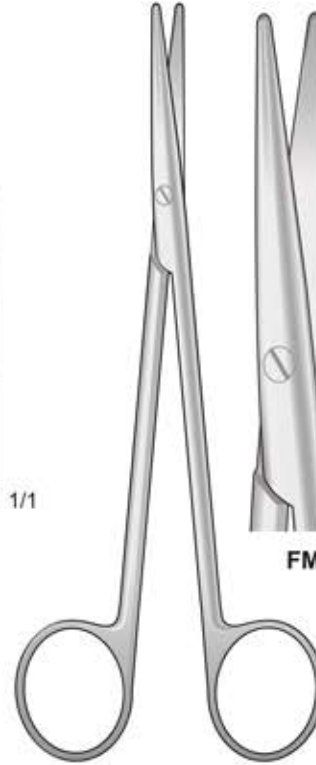
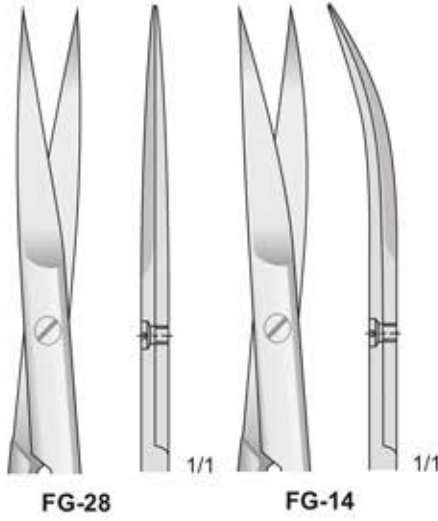

METZENBAUM
FM-74/FM-75
160 mm

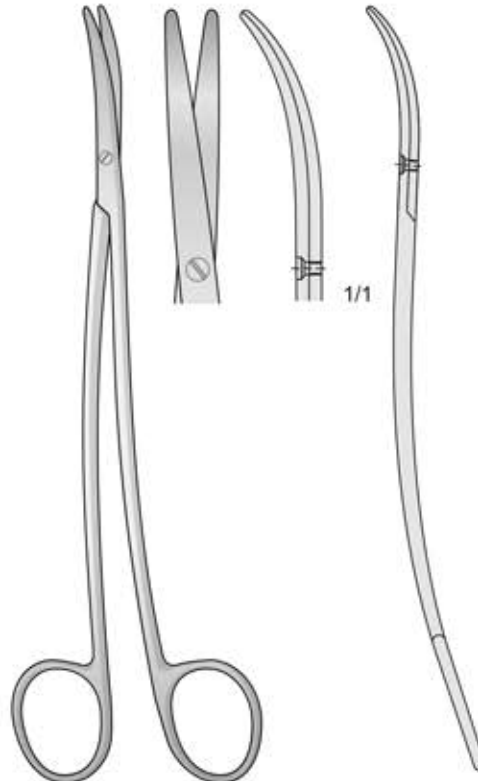
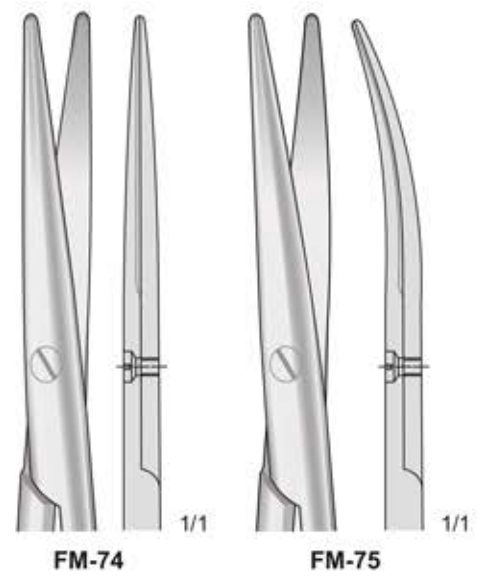

METZENBAUM-FINO
FM-120 - 180 mm
FM-121 - 200 mm
FM-122 - 230 mm

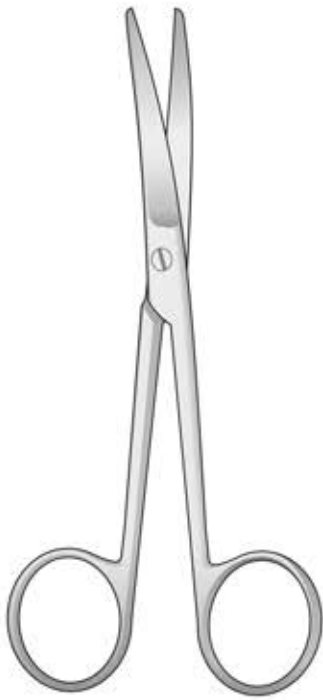

WERTHEIM
FG-140/FG-142



1/1

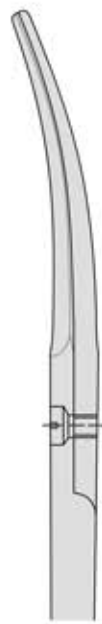

1/1

FG-140
145 mm



1/1

FG-141
200 mm



1/1

FG-142
230 mm

Mit eine Schneide gezahnt
With one blade serrated
Con una lama dentellata
Con una hoja dentada
Avec lame dentèle

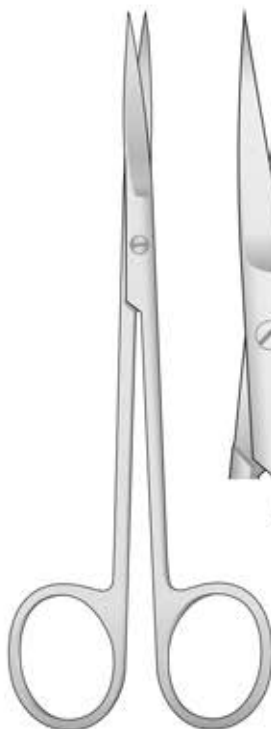

JOSEPH
FG-147/FG-148
150 mm



FG-147
150 mm



1/1



FG-148
150 mm



1/1



FG-116
165 mm



1/1

Präparierscheren - Dissecting Scissors - Forbici per dissezione - Tijeras para preparaciones - Ciseaux à dissection

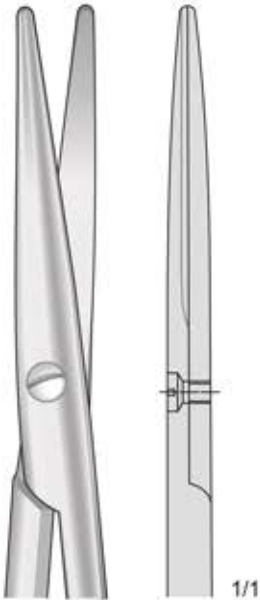

FM-110
150 mm

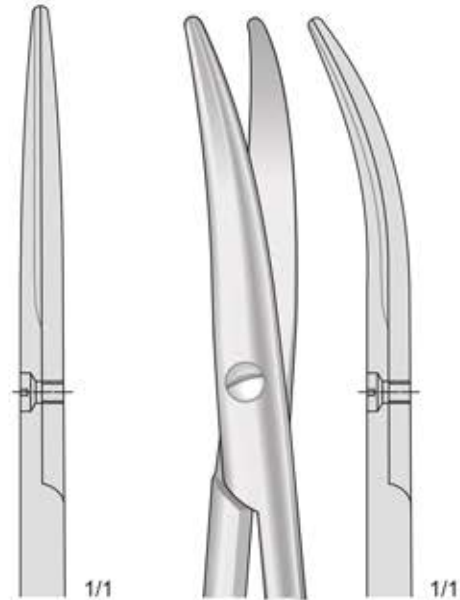

FM-111
150 mm

STILLE
FM-110/FM-111
150 mm

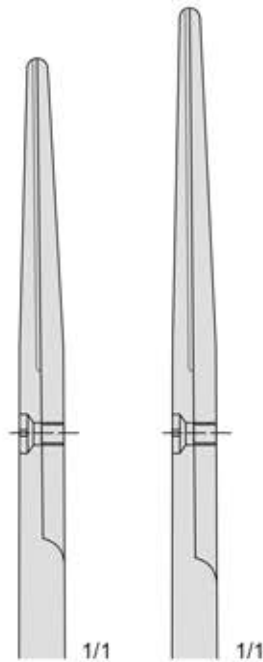
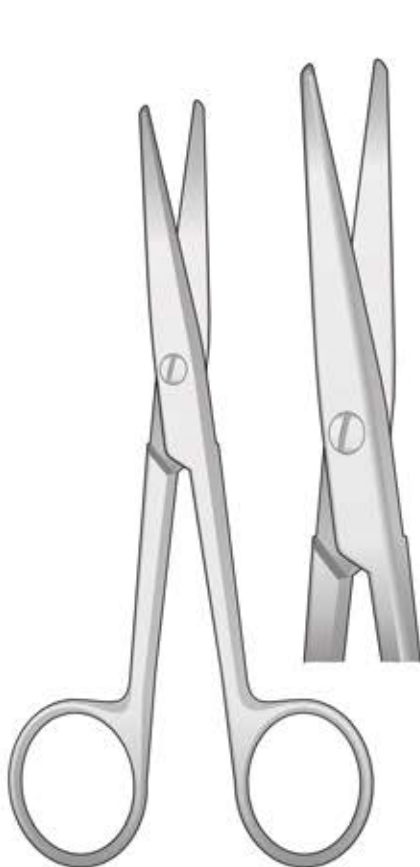

FM-76
140 mm

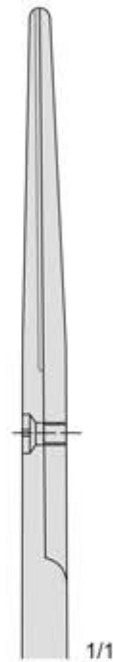

FM-77
170 mm

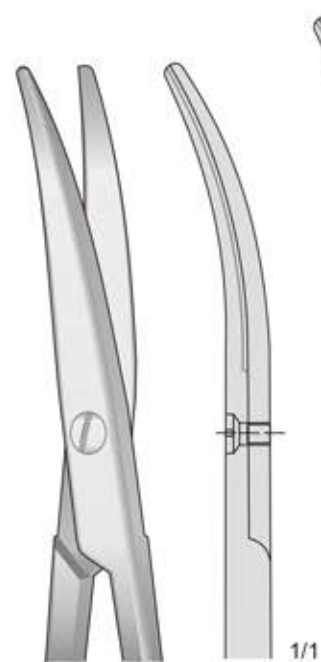

FM-78
140 mm

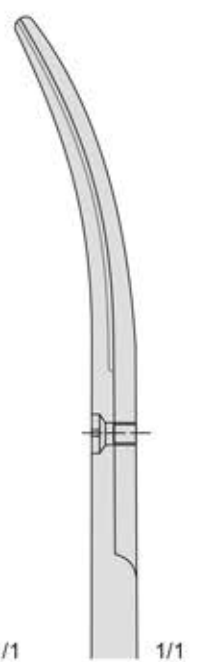

FM-79
170 mm

MAYO-STILLE
FM-76/FM-79

Präparierscheren - Dissecting scissors - Forbici per dissezione - Tijeras para preparaciones - Ciseaux à dissection

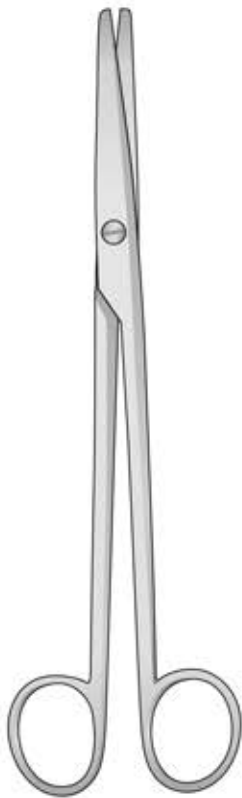
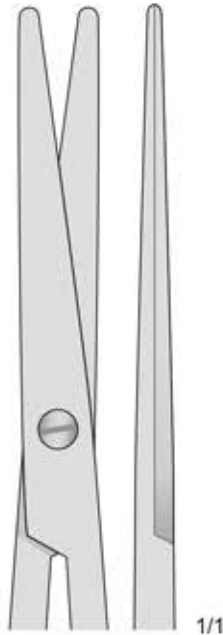
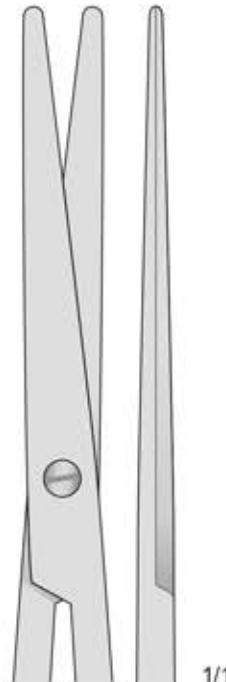
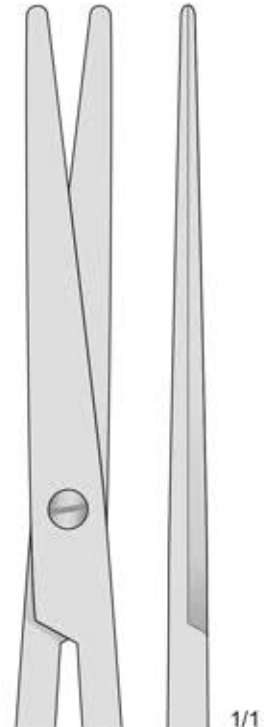
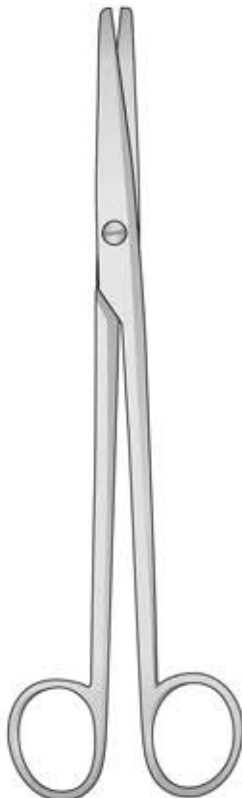
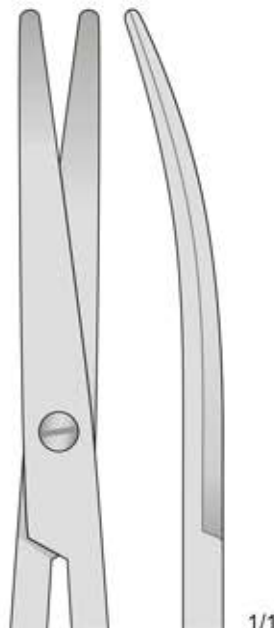
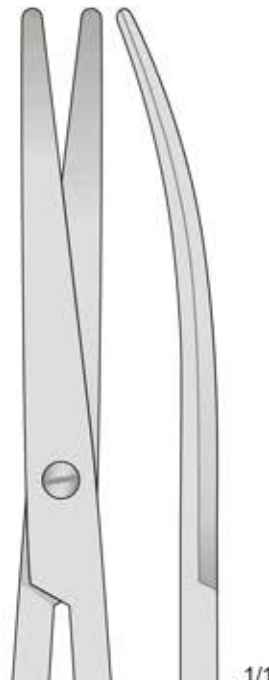
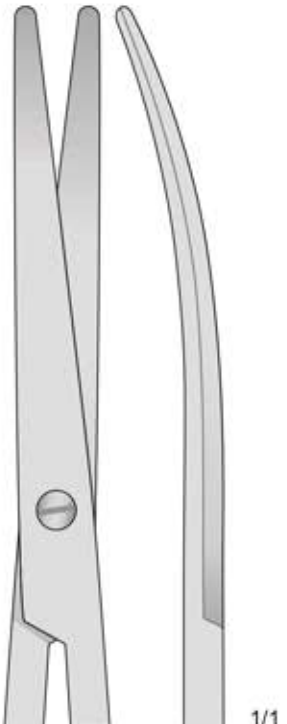
MAYO
FM-80/FM-82FM-80
160 mmFM-81
190 mmFM-82
210 mmMAYO
FM-83/FM-85FM-83
160 mmFM-84
190 mmFM-85
210 mm

Fein - Delicate - Fine - Finas - Fins



LEXER
FM-180/FM-181
165 mm



FM-180



1/1



FM-181



1/1

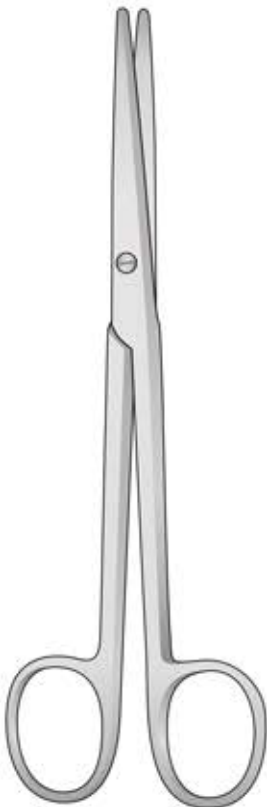

LEXER
FM-86/FM-89



FM-86
160 mm

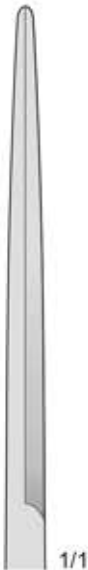

1/1



FM-87
210 mm



1/1



FM-88
160 mm



1/1



FM-89
210 mm



1/1

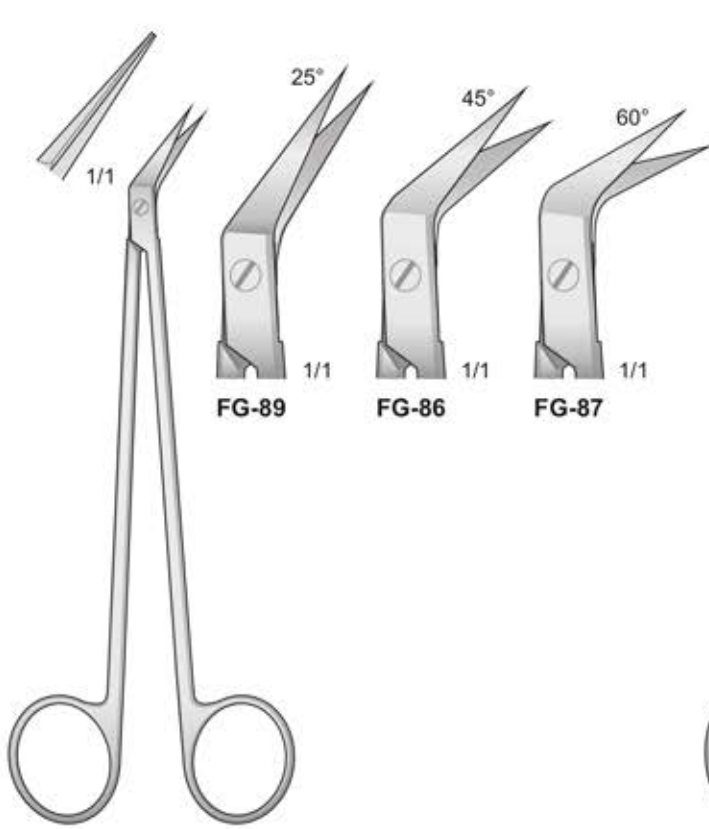

DE BAKEY (POTTS-SMITH)
FG-86/FG-89
 160 mm

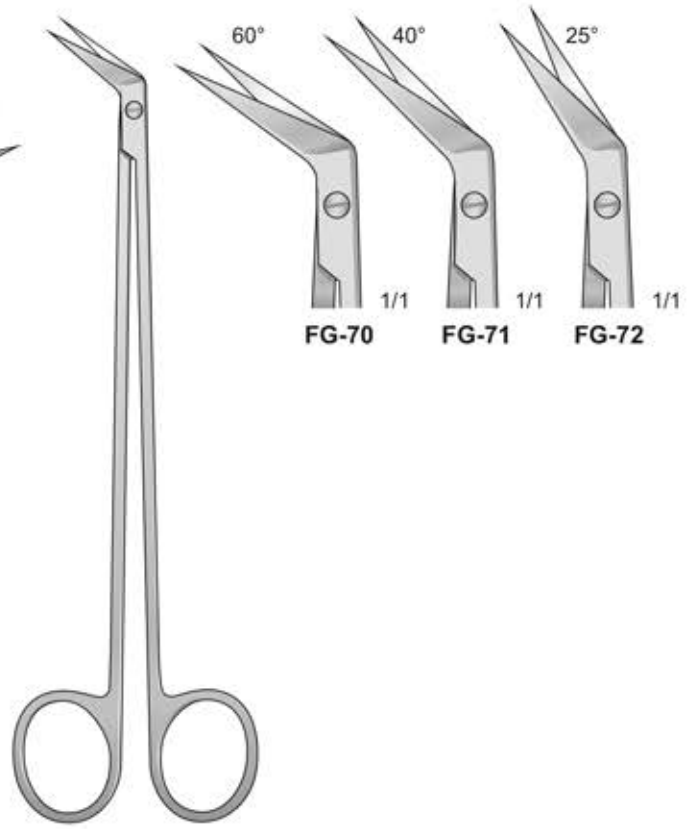

POTTS-SMITH
FG-70/FG-72
 190 mm

Stumpf - Blunt - Smussa
 Romas - Mousse

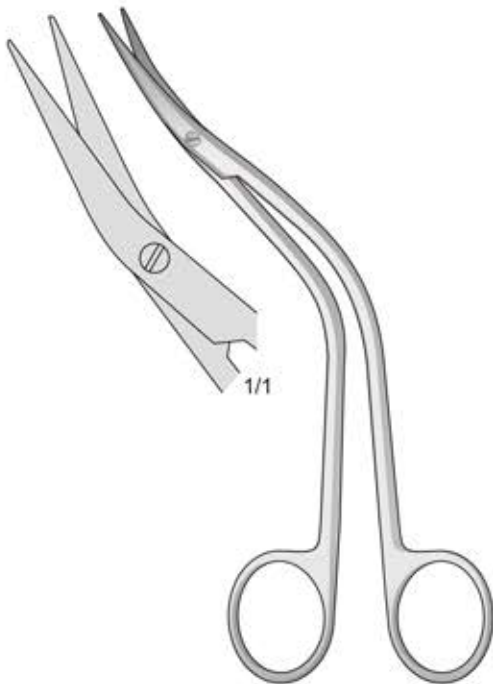

DE BAKEY
FG-78
 155 mm

Spitz - Sharp - Acuta
 Agudas - Pointu

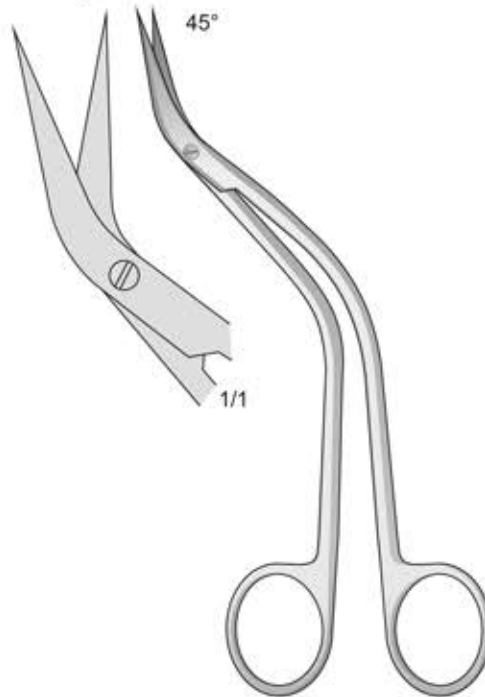

DE BAKEY
FG-79
 155 mm

Episiotomie-Scheren - Episiotomy scissors
 Forbici per episiotomia - Tijeras para episiotomia
 Ciseaux à épisotomie

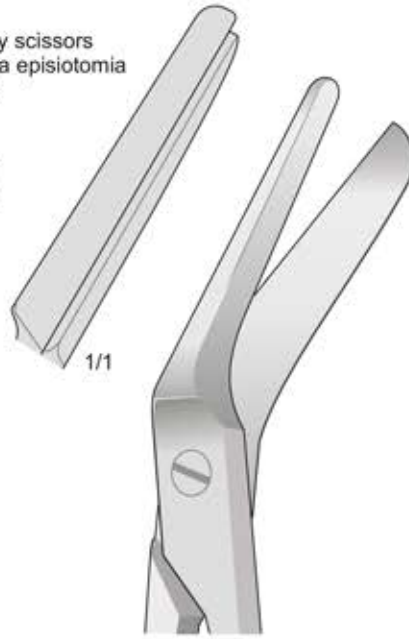

FG-34
145 mm

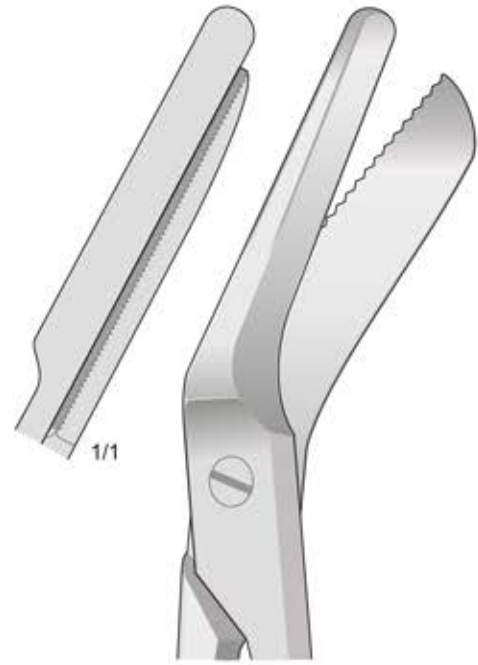

FG-96
200 mm

BRAUN-STADLER
FG-34/FG-96

Nabelschnur Scheren - Umbilical cord scissors
 Forbici per cordone ombelicale - Tijeras umbilicales
 Ciseaux à cordon ombilical

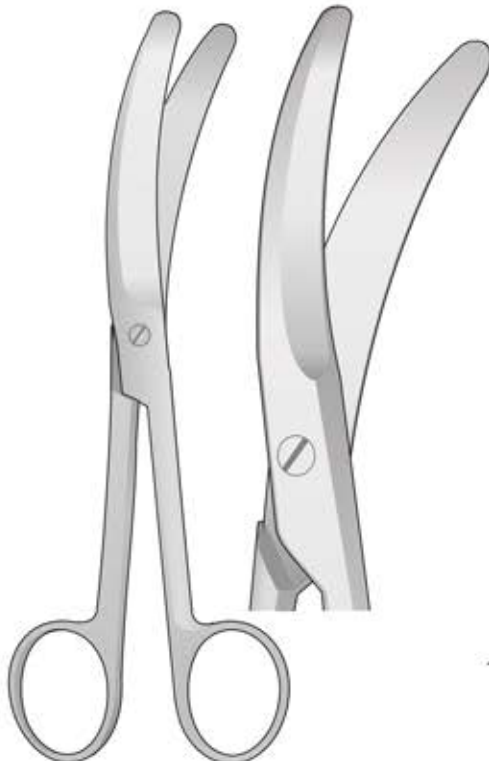

FG-35/FG-97

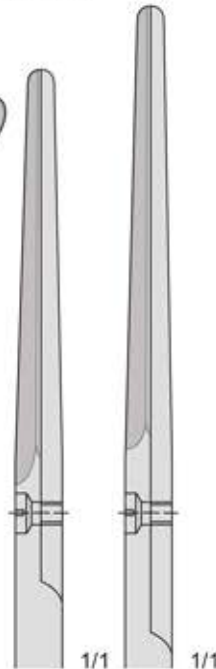

FG-35
160 mm



DUBOIS
FM-26/FM-175

Kephalotomie Scheren - Cephalotomy scissors
 Forbici per cefalotomia - Tijeras para cefalotomia
 Ciseaux à cèphalotomie

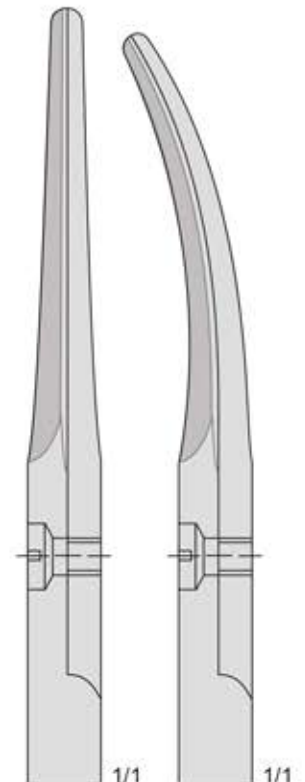

FM-26
270 mm

FM-175
270 mm

L = links
left
mancini
izquierda
gauche

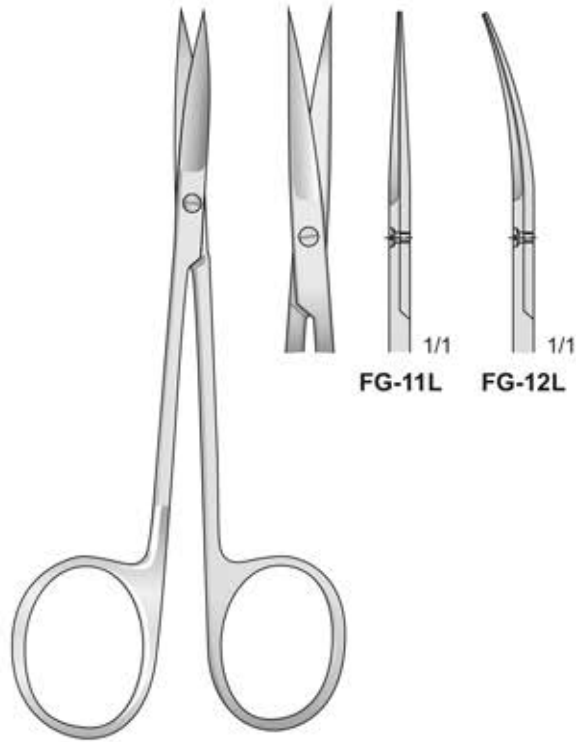

IRIS
FG-11L/FG-12L
110 mm

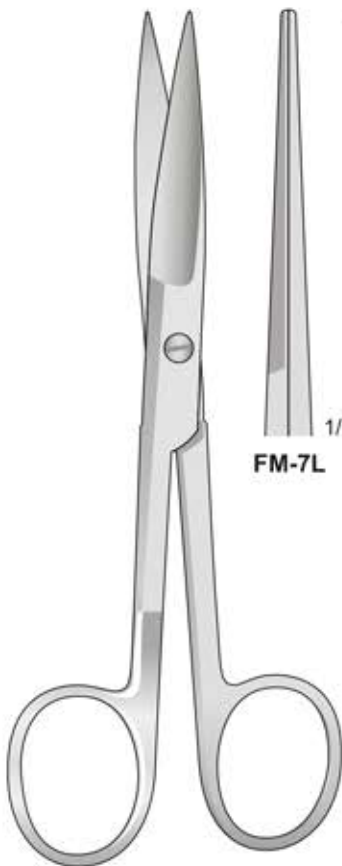

FM-7L/FM-8L
145 mm

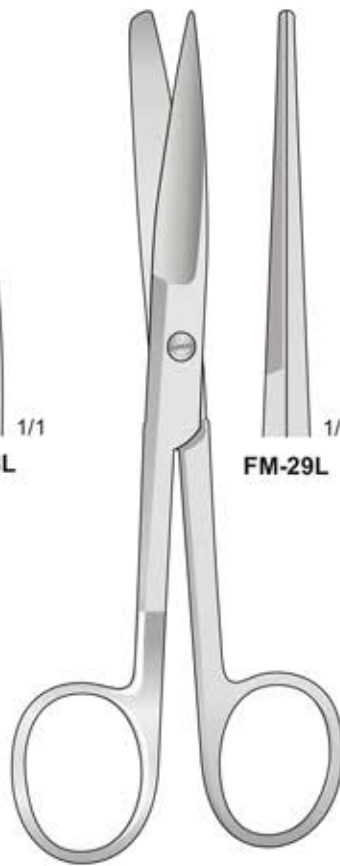

FM-29L/FM-30L
145 mm

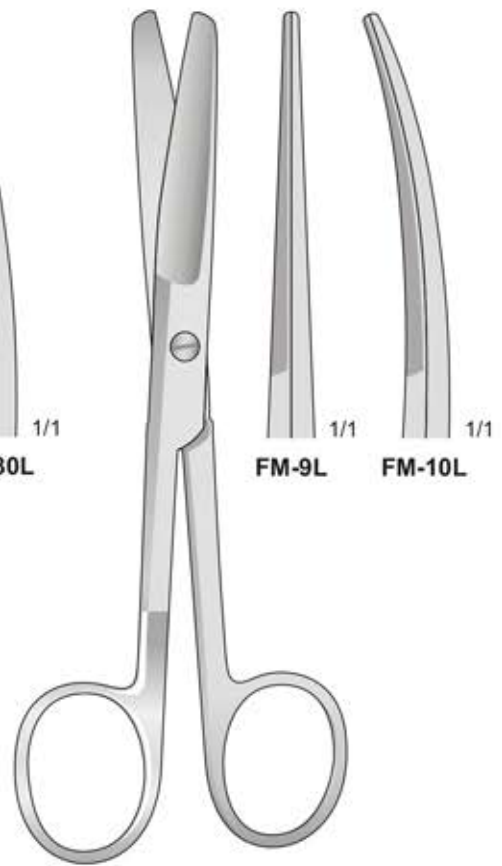

FM-9L/FM-10L
145 mm

Mit Hartmetalleinsätzen - Tungsten-carbide scissors
 Con punta al carburo di tungsteno - Tijeras de tungsteno - Avec plaquettes en carbure de tungstène

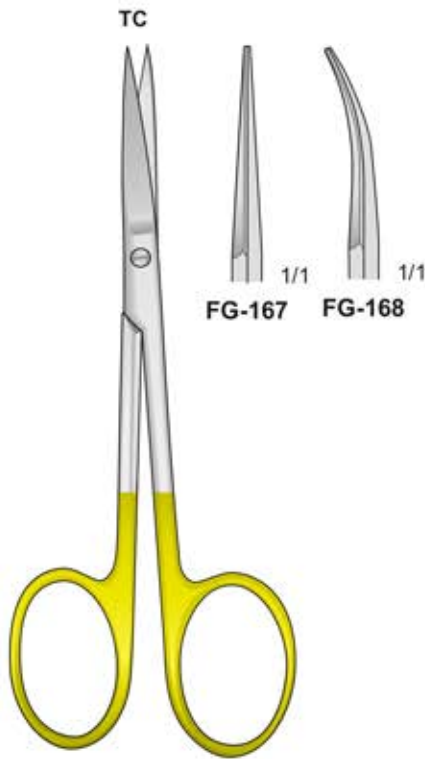

FG-167/FG-168
110 mm

Gezahnt
Serrated
Dentellata
Dentadas
Dentée

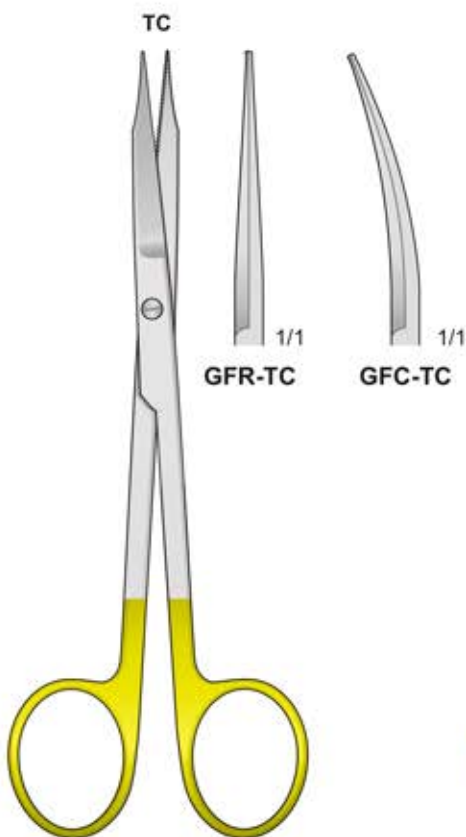

GOLDMAN-FOX
GFR-TC/GFC-TC
135 mm

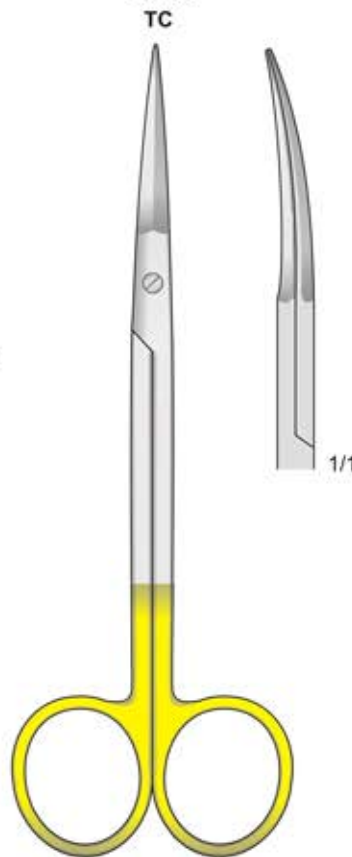

PECK-JOSEPH
FG-92
140 mm

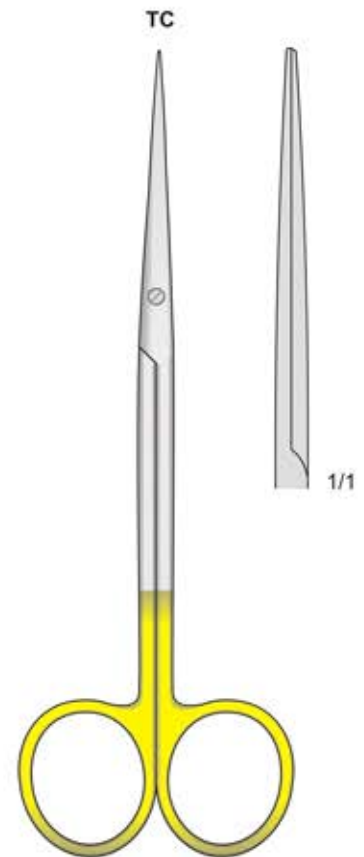

METZENBAUM-FINO
FM-96
140 mm

Mit Hartmetalleinsätzen - Tungsten-carbide scissors
Con punta al carburo di tungsteno - Tijeras de tungsteno - Avec plaquettes en carbure de tungstène

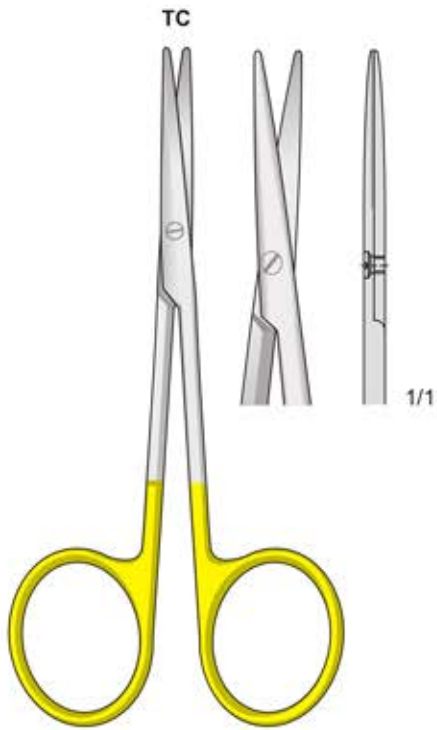

FM-118
115 mm

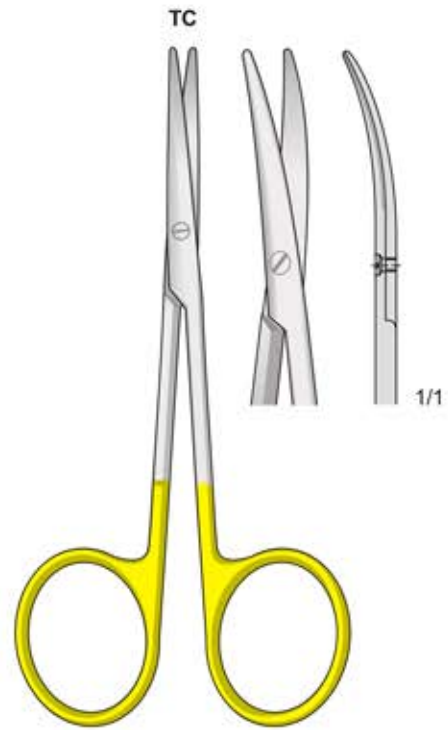

FM-119
115 mm

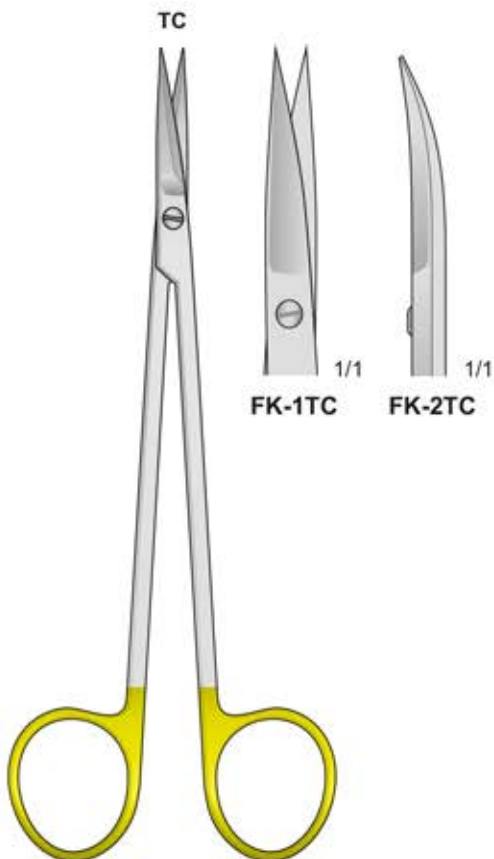

KELLY
FK-1TC/FK-2TC
160 mm

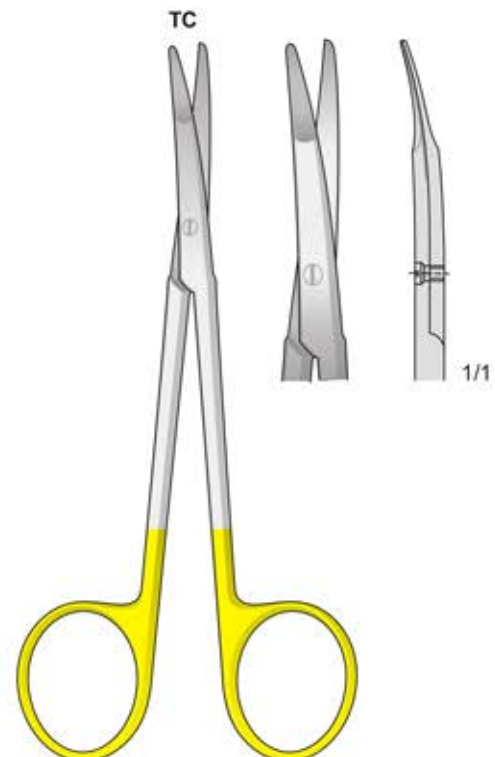

KILNER (RAGNELL)
FM-350
125 mm

Mit Hartmetalleinsätzen - Tungsten-carbide scissors
 Con punta al carburo di tungsteno - Tijeras de tungsteno - Avec plaquettes en carbure de tungstène



FM-145/FM-147

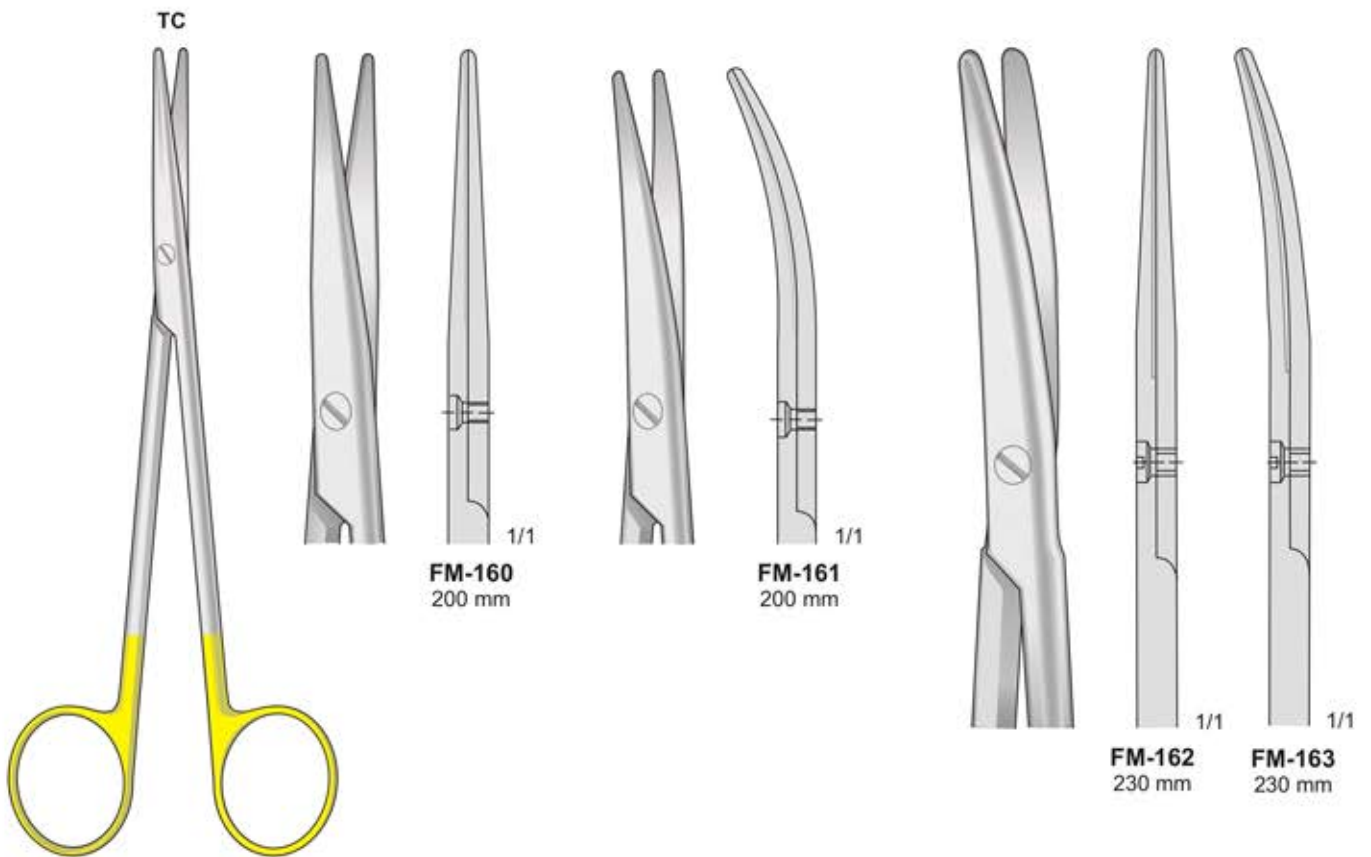

METZENBAUM
 FM-160/FM-163

Mit Hartmetalleinsätzen - Tungsten-carbide scissors
Con punta al carburo di tungsteno - Tijeras de tungsteno - Avec plaquettes en carbure de tungstène

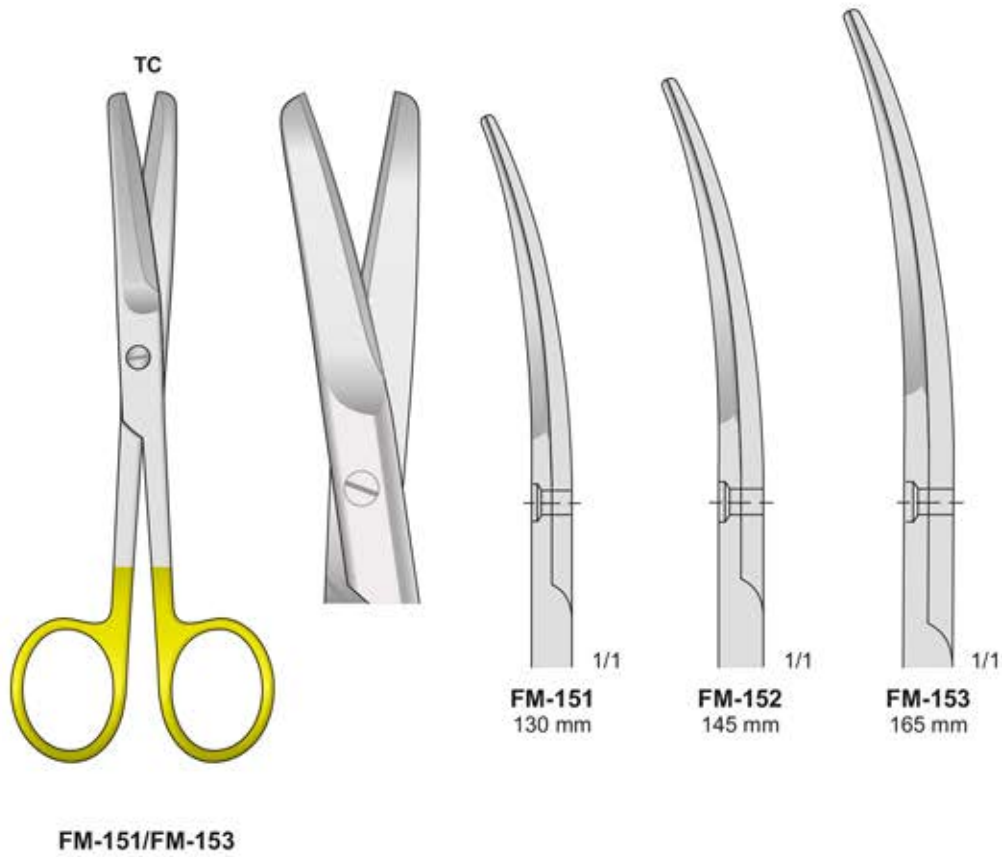

Mit Hartmetalleinsätzen - Tungsten-carbide scissors
 Con punta al carburo di tungsteno - Tijeras de tungsteno - Avec plaquettes en carbure de tungstène

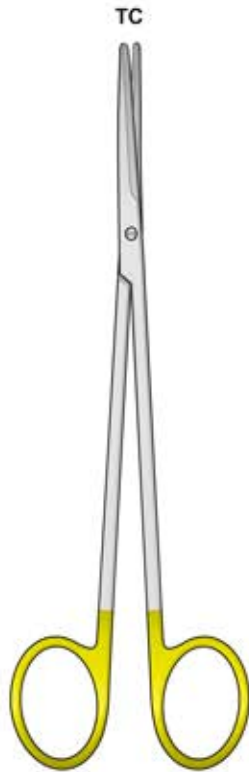

METZENBAUM-FINO
 FM-201/FM-205



FM-201
 140 mm



FM-203
 180 mm

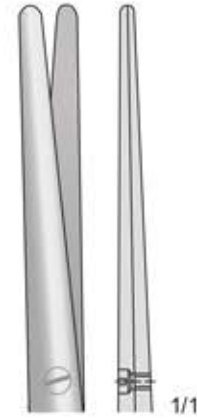

FM-205
 200 mm

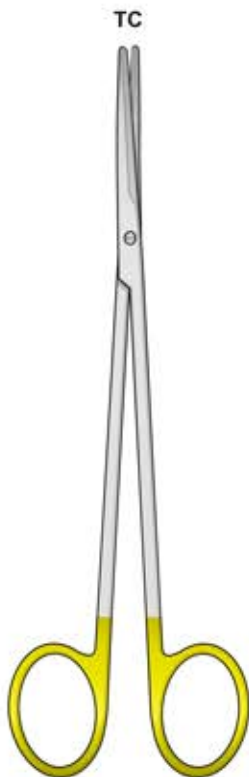

METZENBAUM-FINO
 FM-207/FM-211

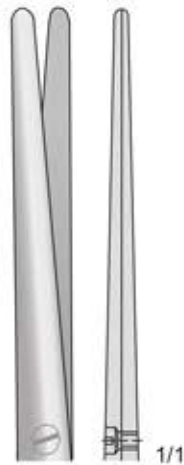

FM-207
 230 mm

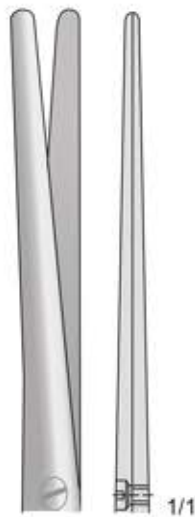

FM-209
 250 mm



FM-211
 280 mm

Mit Hartmetalleinsätzen - Tungsten-carbide scissors
 Con punta al carburo di tungsteno - Tijeras de tungsteno - Avec plaquettes en carbure de tungstène

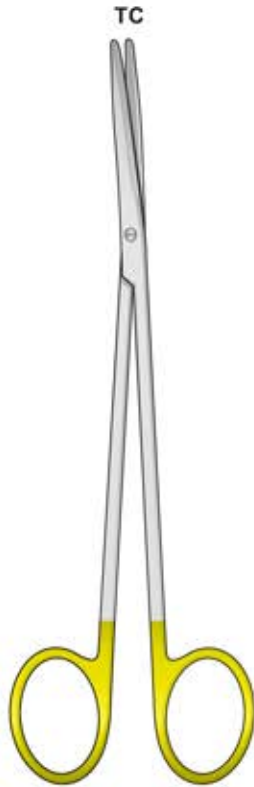

METZENBAUM-FINO
 FM-202/FM-206

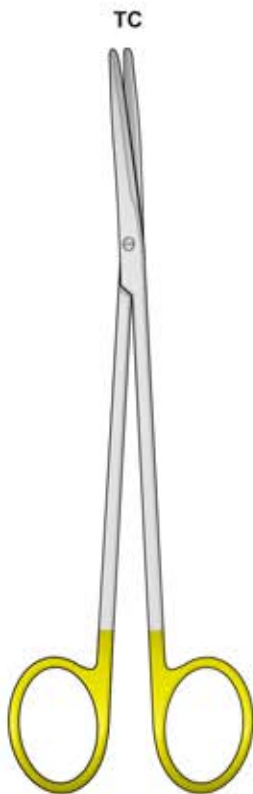
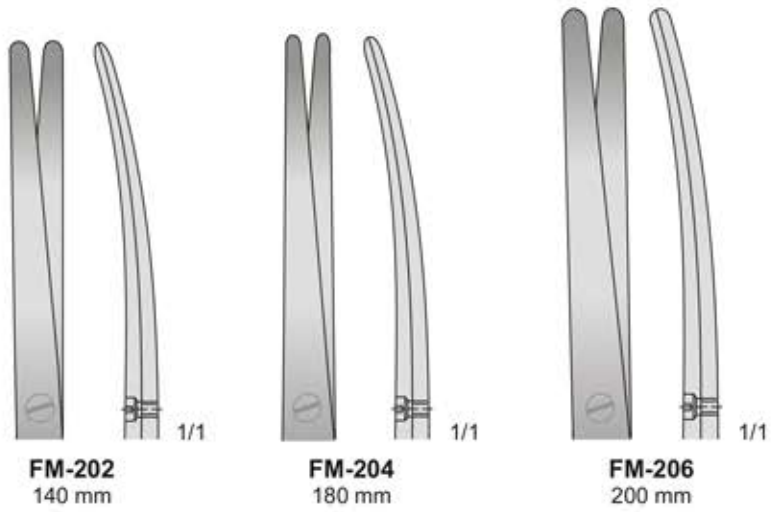

METZENBAUM-FINO
 FM-208/FM-212

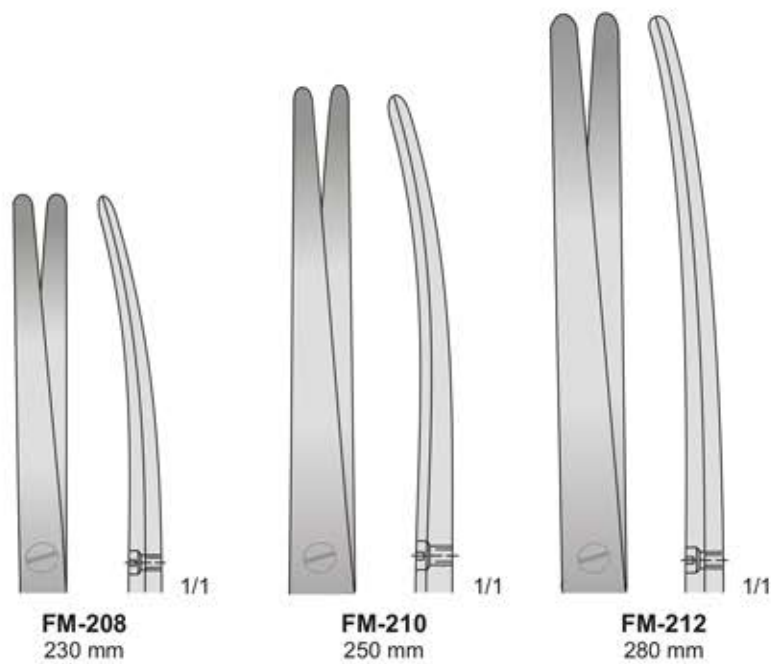

Mit Hartmetalleinsätzen - Tungsten-carbide scissors - Con punta al carburo di tungsteno
Tijeras de tungsteno - Avec plaquettes en carbure de tungstène

TC



MAYO-STILLE
FM-130/FM-131



FM-130
140 mm



FM-131
170 mm

TC

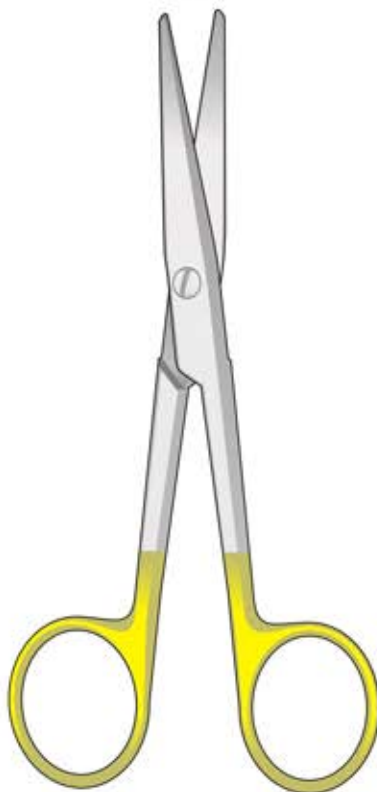

MAYO-STILLE
FM-132/FM-133

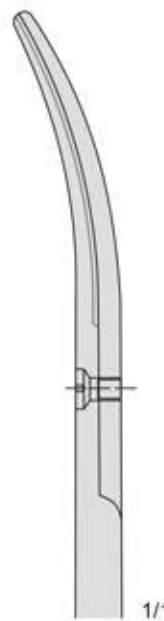

FM-132
140 mm

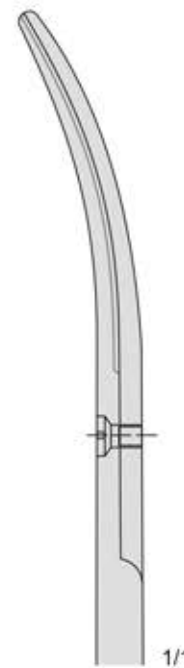

FM-133
170 mm

TC

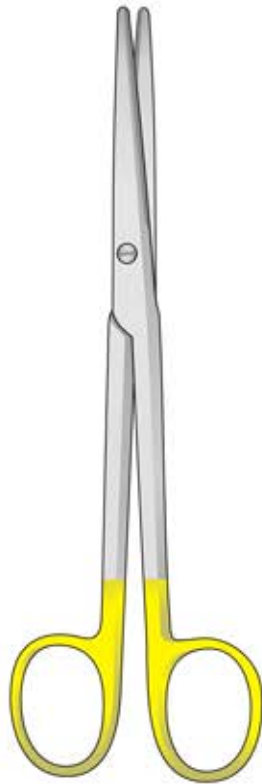
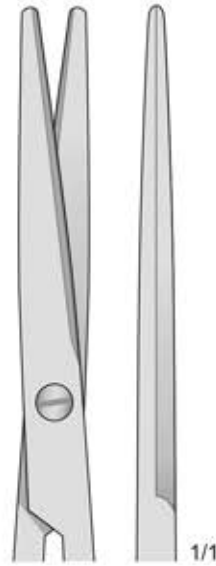
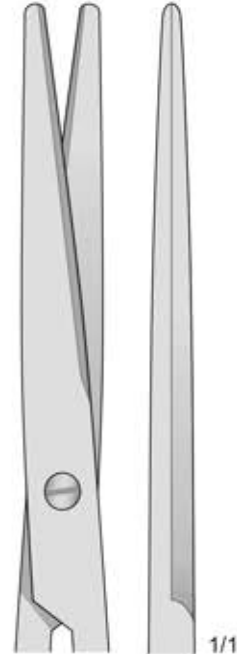
Mit Hartmetalleinsätzen - Tungsten-carbide scissors
Con punta al carburo di tungsteno - Tijeras de tungsteno - Avec plaquettes en carbure de tungstèneLEXER
FM-134/FM-135FM-134
160 mmFM-135
210 mm

TC

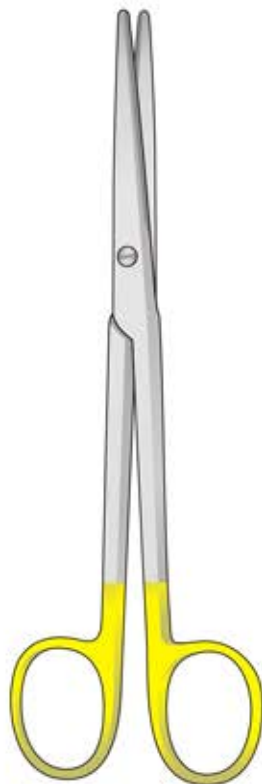
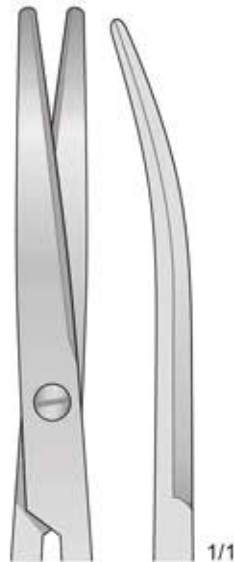
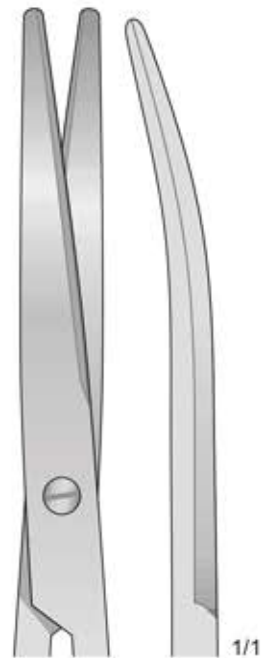
LEXER
FM-136/FM-137FM-136
160 mmFM-137
210 mm

Mit Hartmetalleinsätzen - Tungsten-carbide scissors
 Con punta al carburo di tungsteno - Tijeras de tungsteno - Avec plaquettes en carbure de tungstène

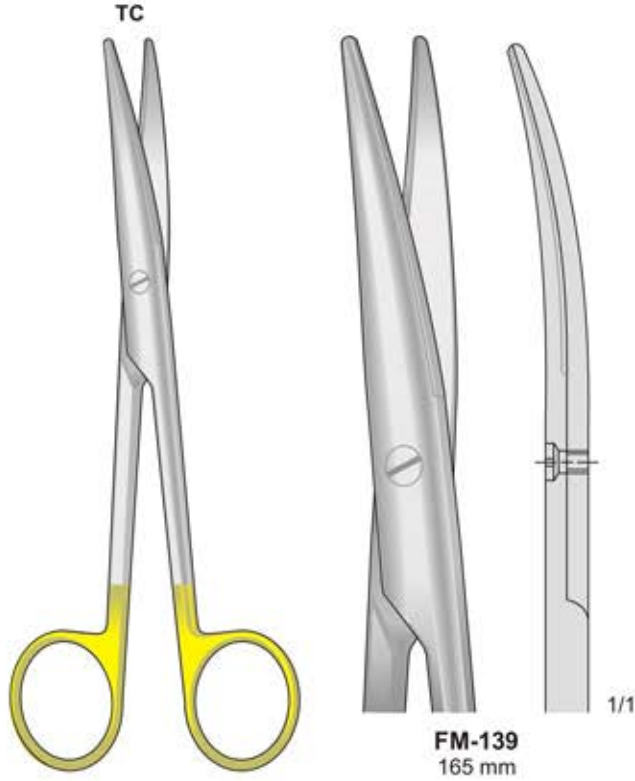

MAYO-LEXER
FM-139
 165 mm

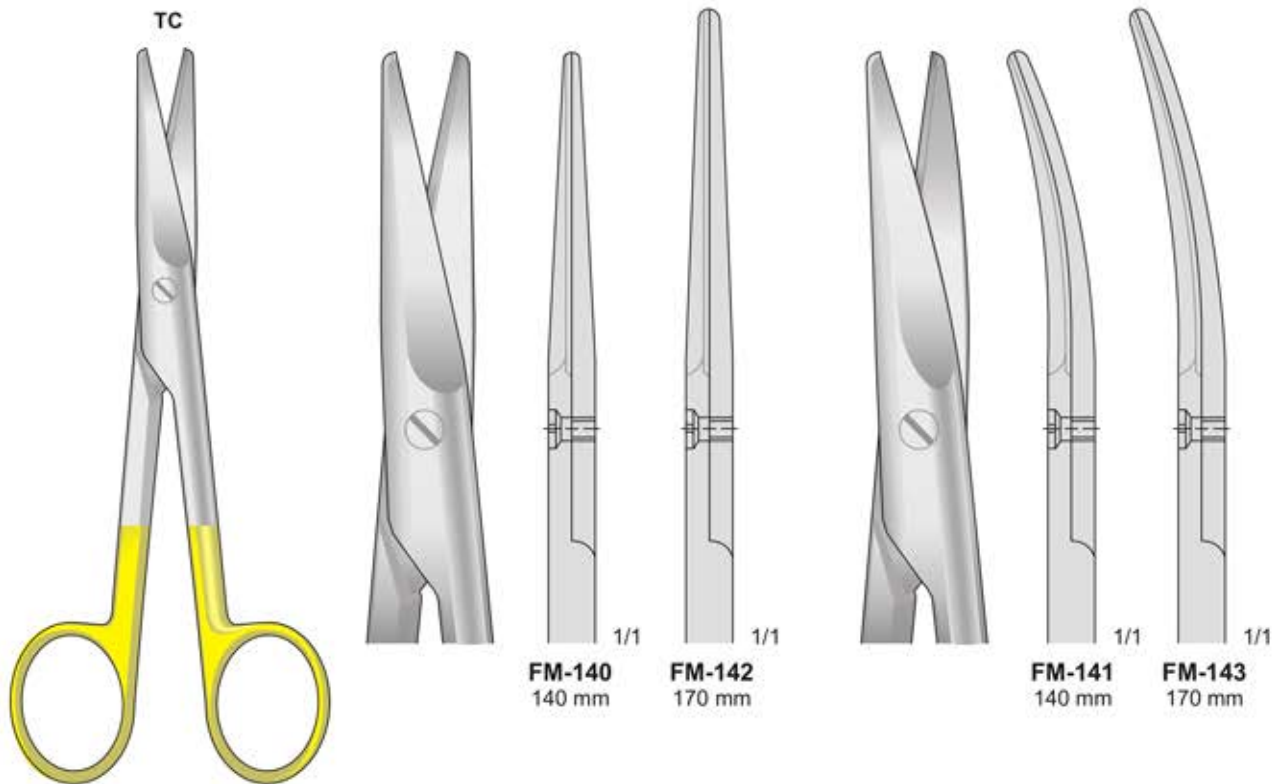

MAYO
FM-140/FM-143

TC

Mit Hartmetalleinsätzen - Tungsten-carbide scissors
 Con punta al carburo di tungsteno - Tijeras de tungsteno
 Avec plaquettes en carbure de tungstène



NELSON-METZENBAUM
 FM-154/FM-155



1/1

FM-154
 260 mm



1/1

FM-155
 280 mm

TC

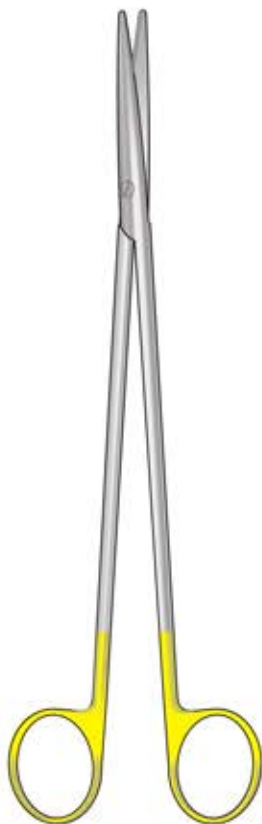

NELSON-METZENBAUM
 FM-156/FM-159



1/1

FM-156
 230 mm



1/1

FM-157
 230 mm



1/1

FM-159
 300 mm

Mit Hartmetalleinsätzen - Tungsten-carbide scissors
 Con punta al carburo di tungsteno - Tijeras de tungsteno
 Avec plaquettes en carbure de tungstène

Scheren mit wellenschliff auf einer Schnittfläche
 Scissors cut one serrated cutting edge
 Forbici con taglio ondulato su una lama
 Tijeras con ondas afilados
 Ciseaux avec affutage spécial ont une lame dentée

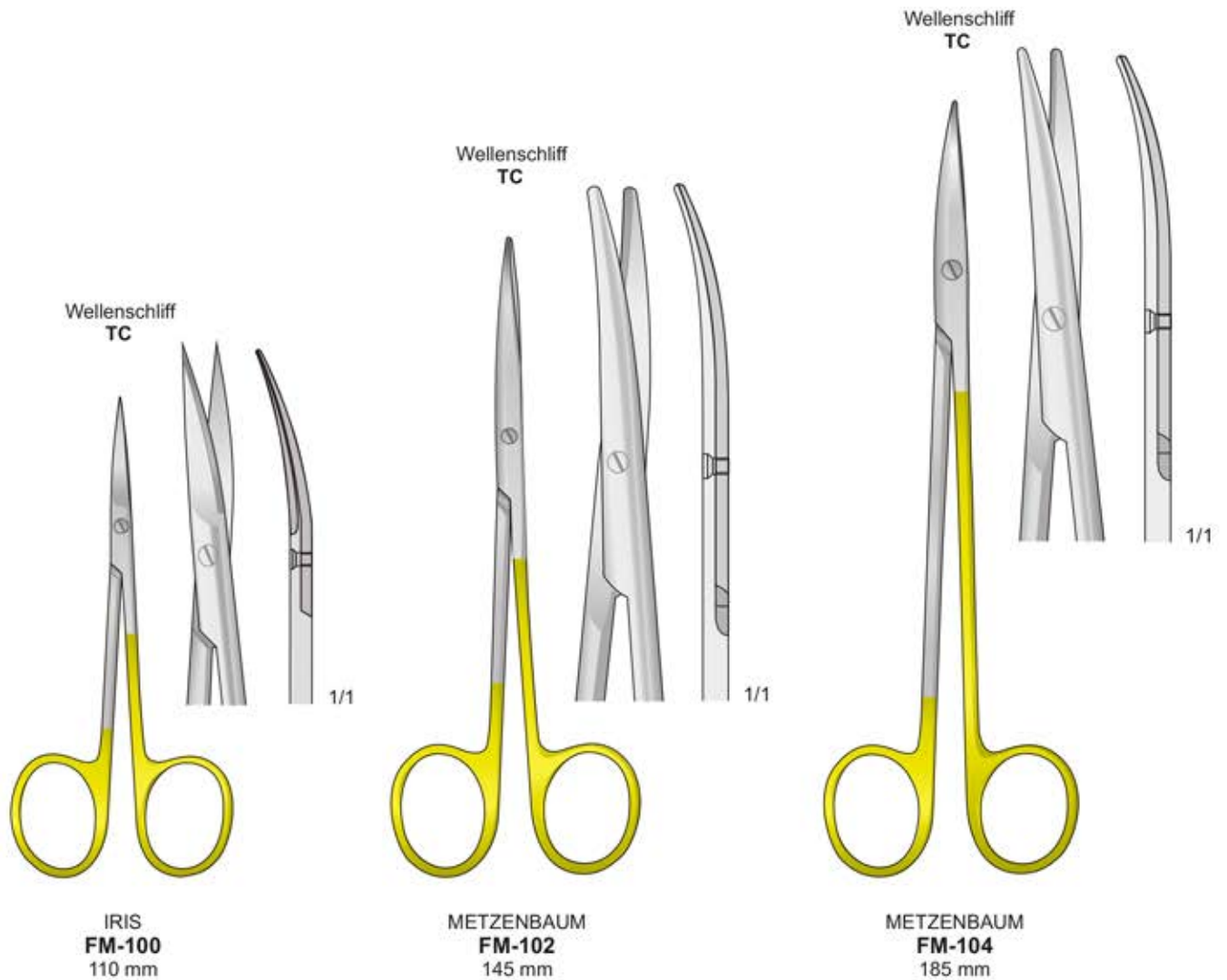
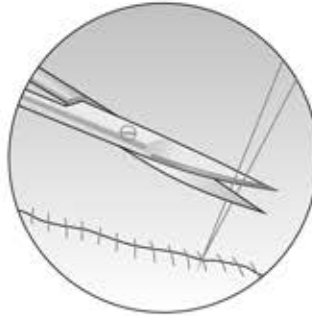

Mit Hartmetalleinsätzen
Tungsten-carbide scissors
Con punta al carburo di tungsteno
Tijeras de tungsteno
Avec plaquettes en carbure de tungstène

Wire Cutter
TC

Wire Cutter
TC

TC

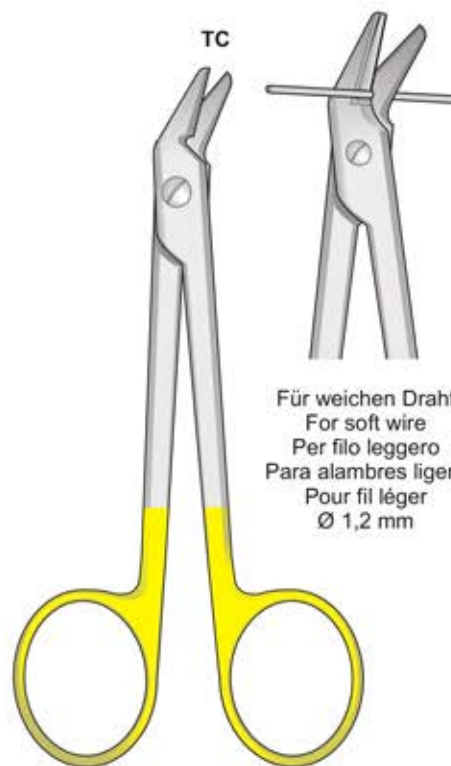
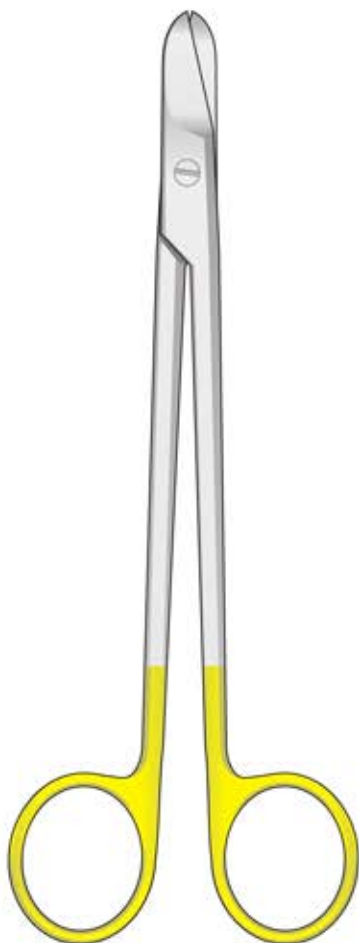

SMITH
FG-160
160 mm

SMITH
FG-161
160 mm

DP-120
120 mm

Für weichen Draht
For soft wire
Per filo leggero
Para alambres ligero
Pour fil léger
Ø 1,2 mm

Schmal - Narrow - Strette - Estrechas - Étroites

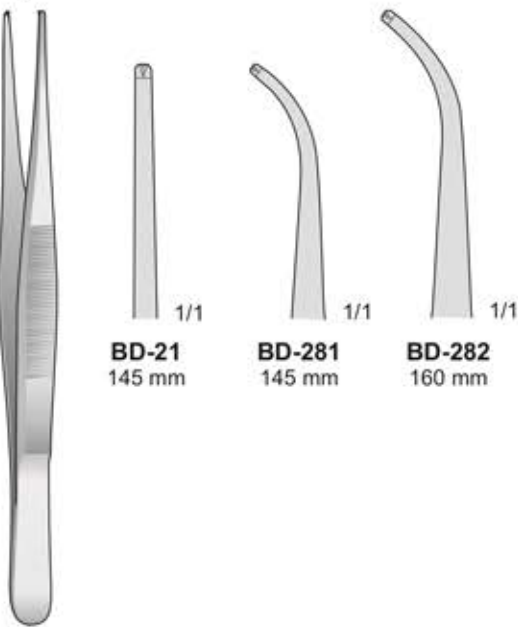

BD-21
145 mm

BD-281
145 mm

BD-282
160 mm

Fein - Delicate - Fine - Finas - Fines

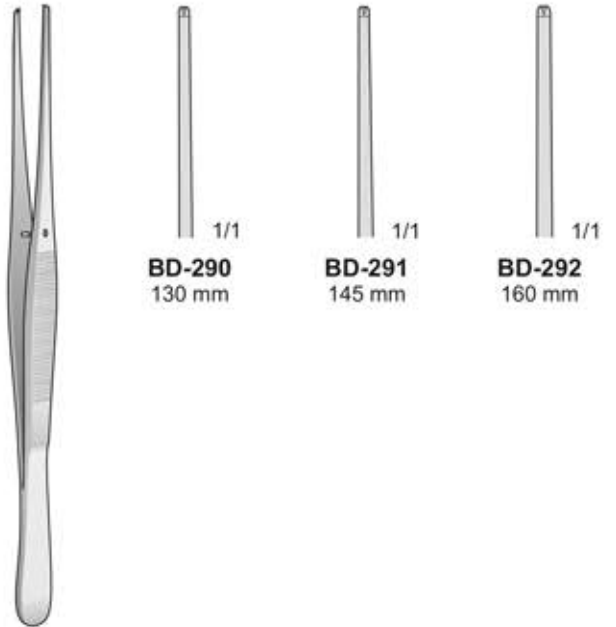

BD-290
130 mm

BD-291
145 mm

BD-292
160 mm

BD-21/BD-282

BD-290/BD-292

1 x 2 Zähne
1 x 2 Teeth
1 x 2 Denti
1 x 2 Dientes
1 x 2 Dents

1 x 2 Zähne
1 x 2 Teeth
1 x 2 Denti
1 x 2 Dientes
1 x 2 Dents

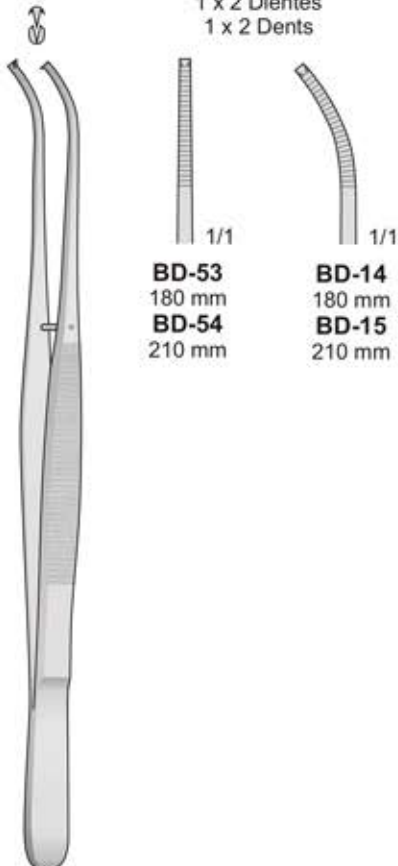

BD-53
180 mm
BD-54
210 mm

BD-14
180 mm
BD-15
210 mm

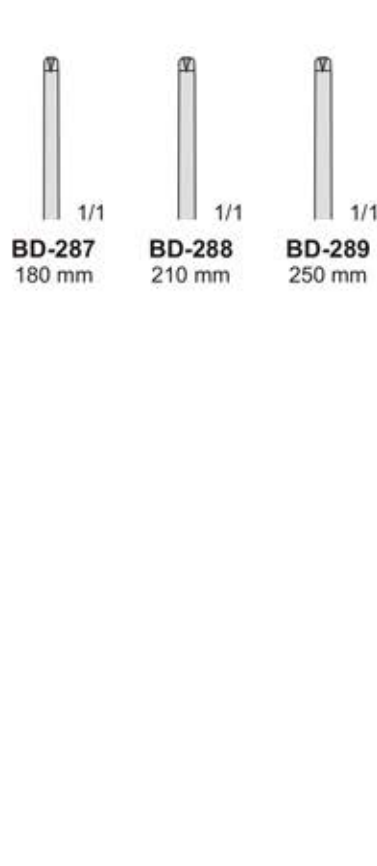

BD-287
180 mm

BD-288
210 mm

BD-289
250 mm

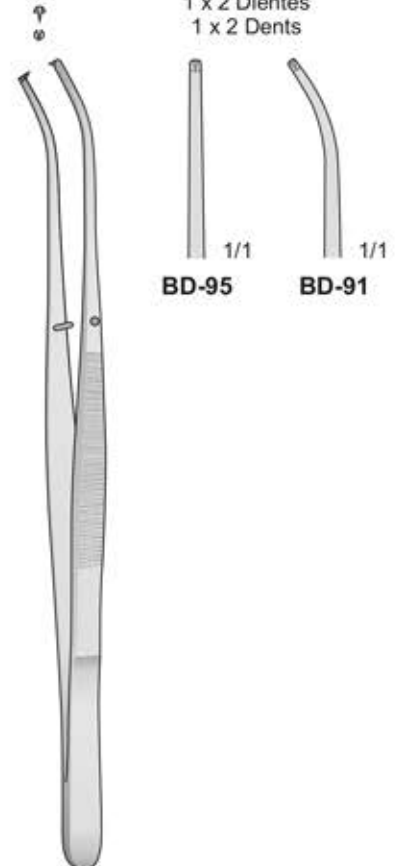

BD-95

BD-91

POTTS-SMITH
BD-14/BD-54

POTTS-SMITH
BD-287/BD-289

SEMKEN
BD-91/BD-95
150 mm

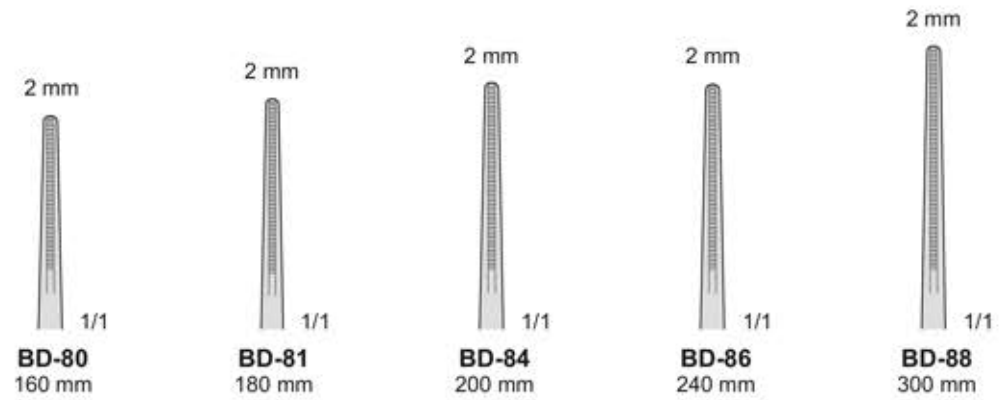
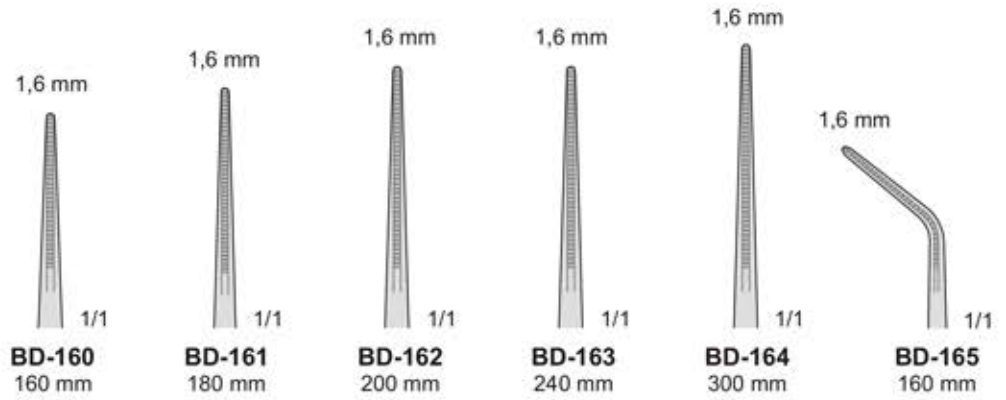

Atraumatische pinzetten
Non-traumatic vascular tissue forceps
Pinzette atraumatiche
Pinzas atraumaticas
Pinces atraumatiques



DE BAKEY
BD-80/BD-164

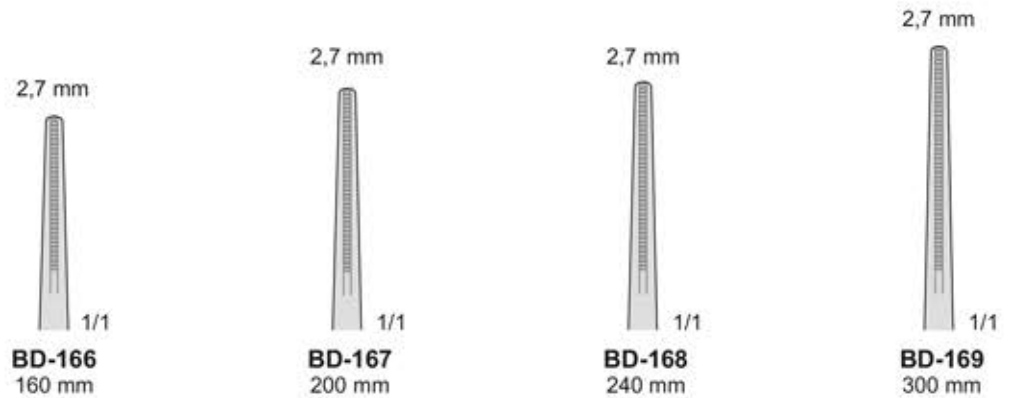
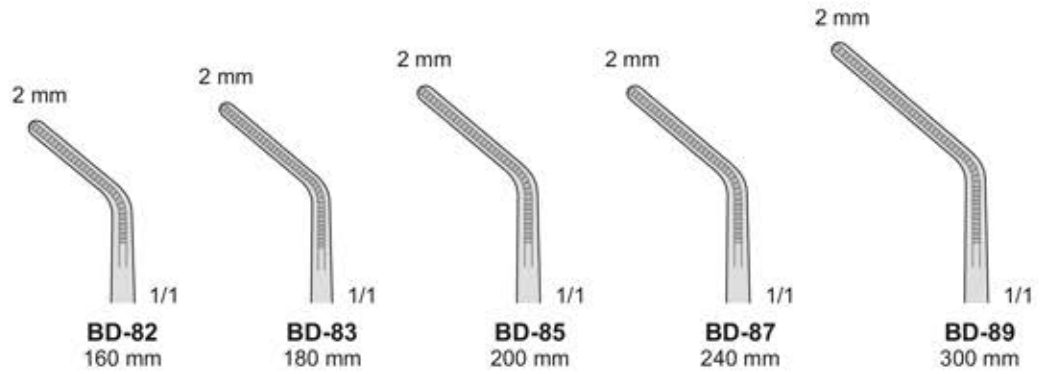

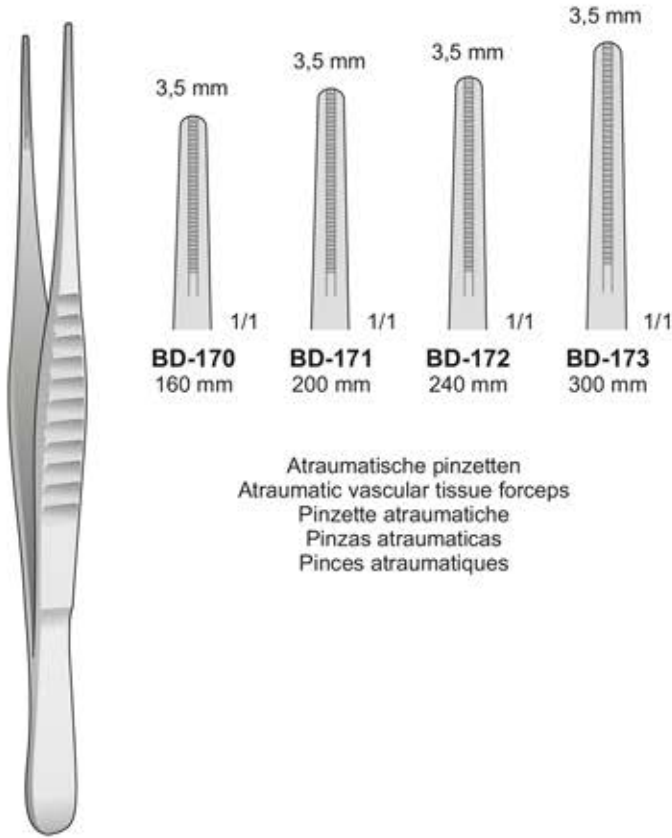

BD-170
160 mm

BD-171
200 mm

BD-172
240 mm

BD-173
300 mm

Atraumatische pinzetten
Atraumatic vascular tissue forceps
Pinzette atraumatiche
Pinzas atraumaticas
Pinces atraumatiques

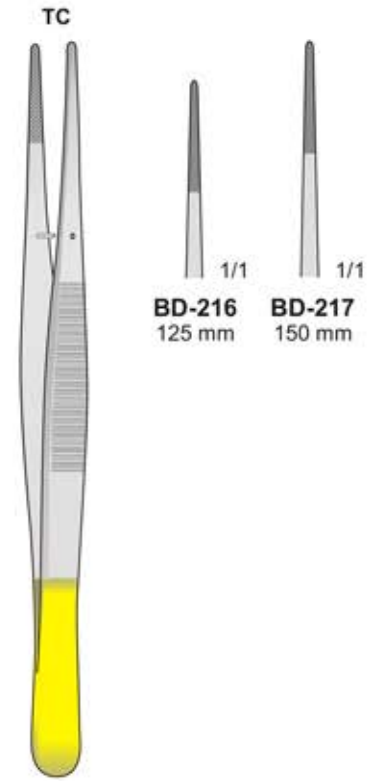

BD-216
125 mm

BD-217
150 mm

DE BAKEY
BD-165/BD-173

SEMKEN
BD-216/BD-217

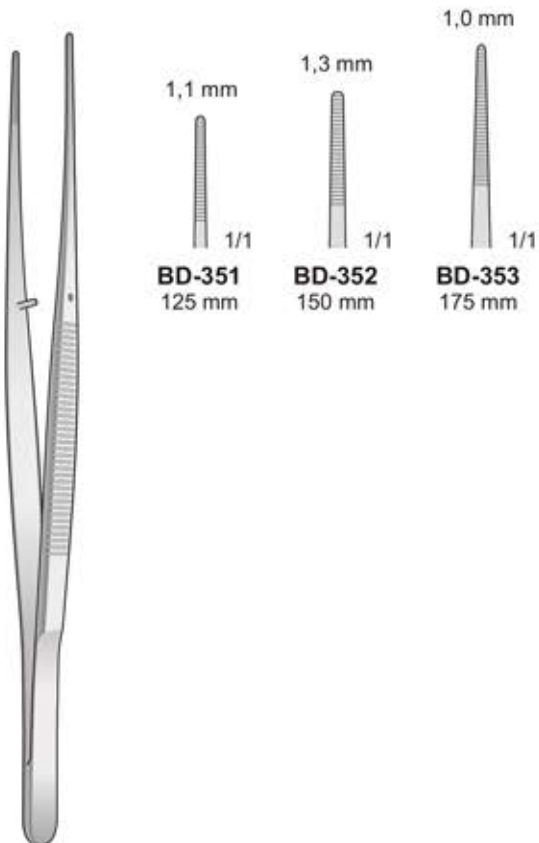

BD-351
125 mm

BD-352
150 mm

BD-353
175 mm

BD-351/BD-353

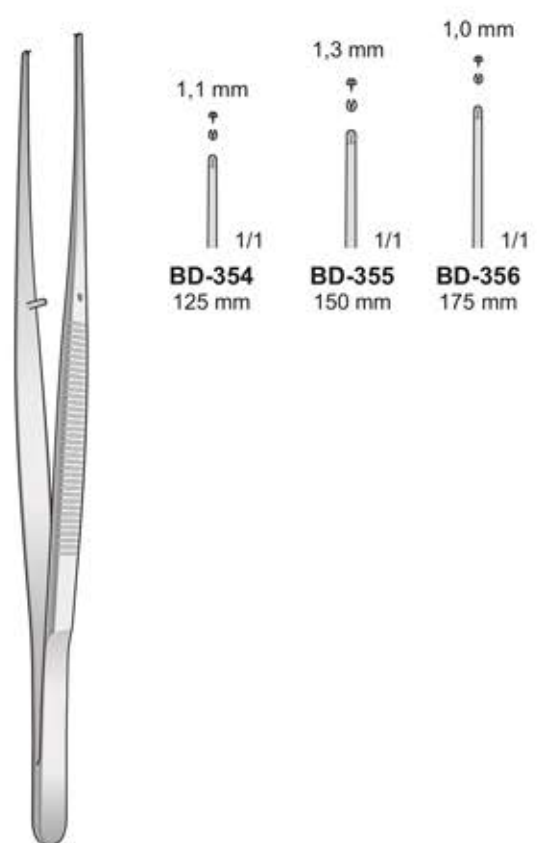

BD-354
125 mm

BD-355
150 mm

BD-356
175 mm

BD-354/BD-355

Mit Hartmetalleinsätzen - Tungsten-carbide scissors
 Con punta al carburo di tungsteno - Tijeras de tungsteno - Avec plaquettes en carbure de tungstène

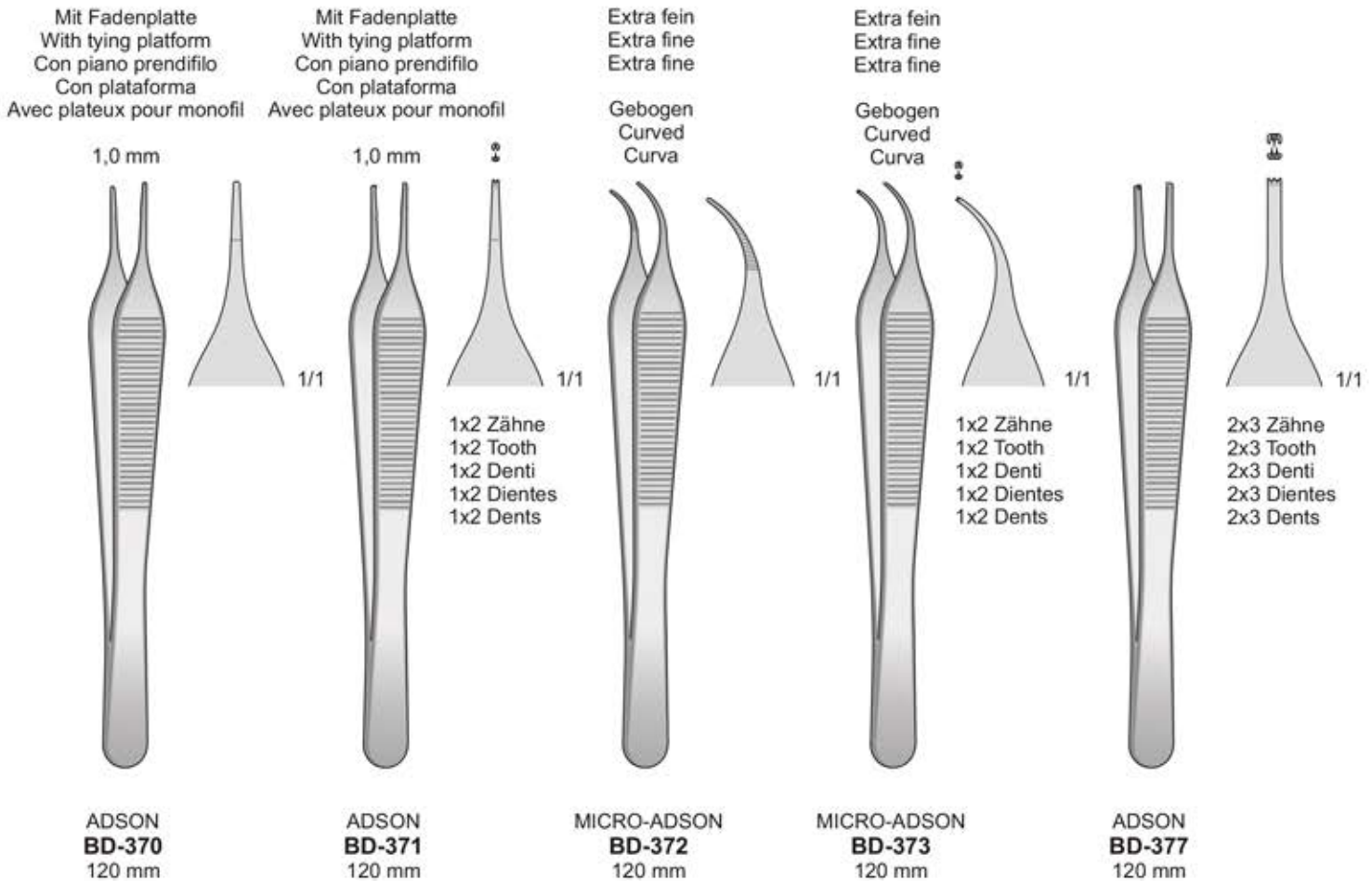
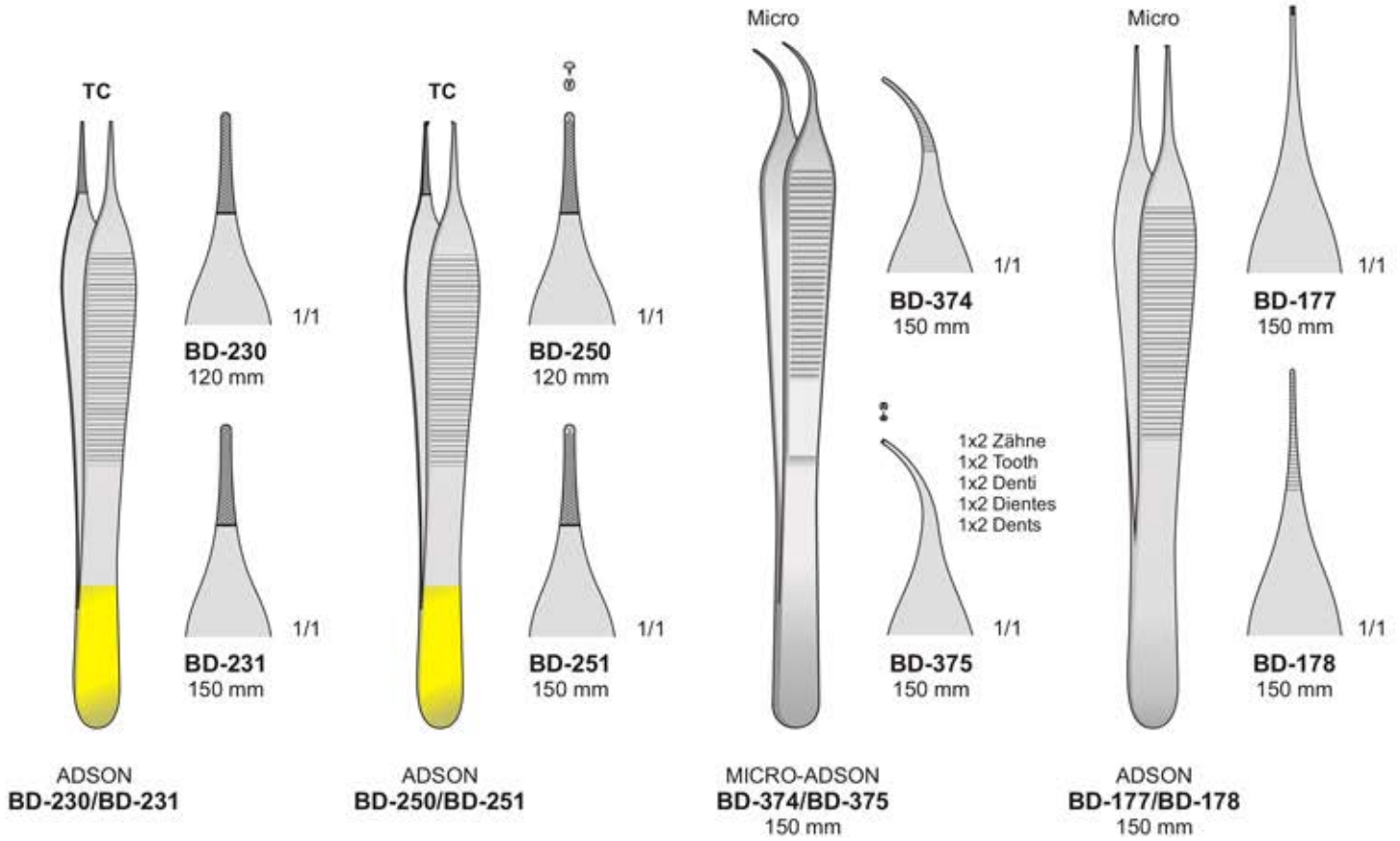

TC



BD-210/BD-215

Standard

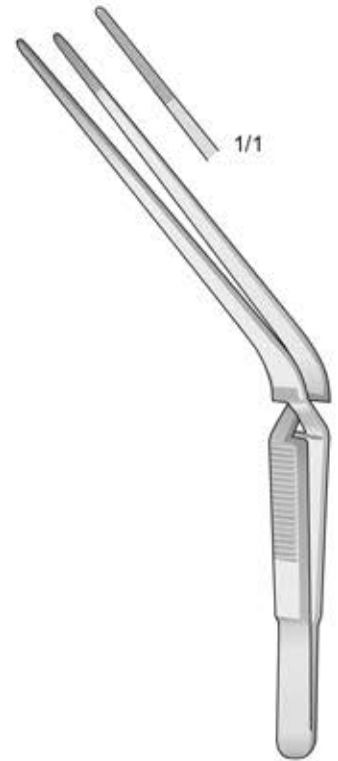
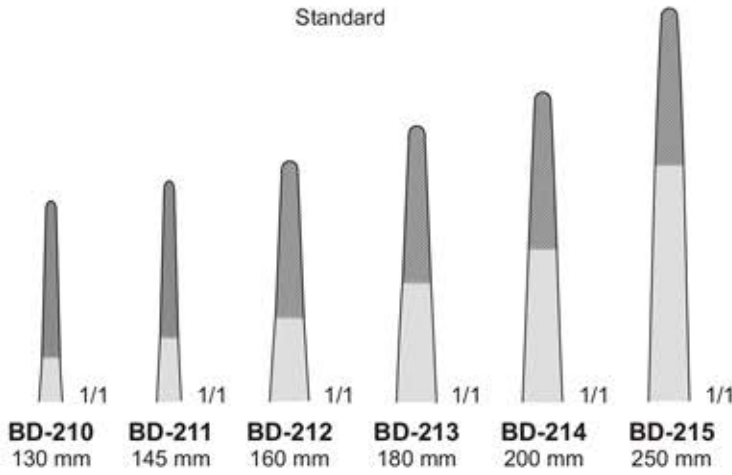

TROELTSCH
BD-179
130 mm

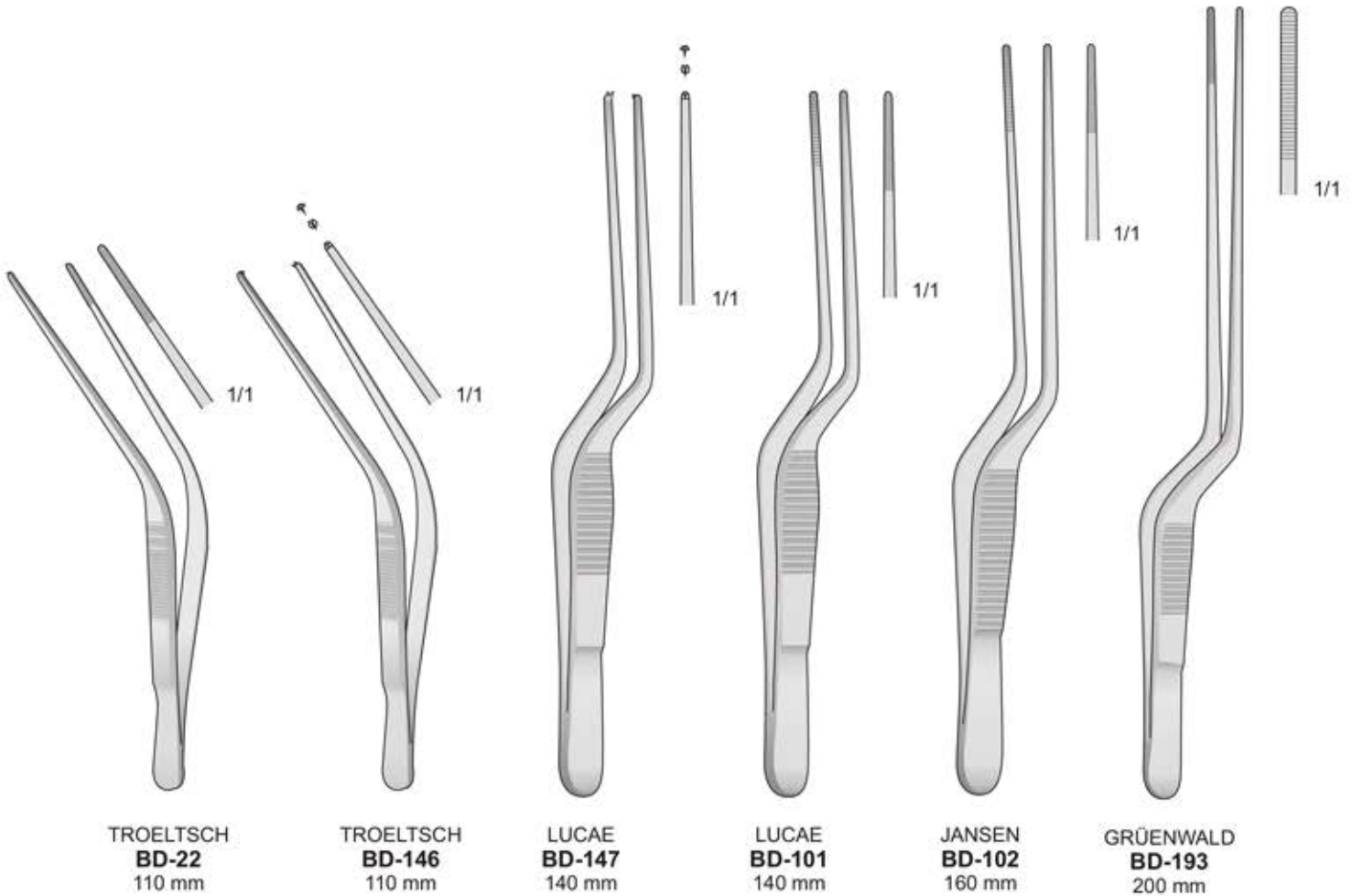

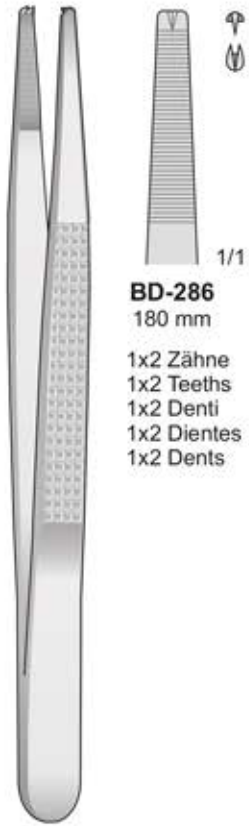

BD-286
180 mm
1x2 Zähne
1x2 Teeths
1x2 Denti
1x2 Dientes
1x2 Dents

BONNEY
BD-286
180 mm



BD-293
150 mm
1x2 Zähne
1x2 Teeths
1x2 Denti
1x2 Dientes
1x2 Dents

LANE
BD-293/BD-295



BD-294
150 mm
2x3 Zähne
2x3 Teeths
2x3 Denti
2x3 Dientes
2x3 Dents

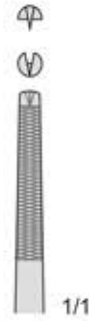

BD-295
175 mm
1x2 Zähne
1x2 Teeths
1x2 Denti
1x2 Dientes
1x2 Dents

DUVAL
BD-198/BD-199



BD-198
140 mm

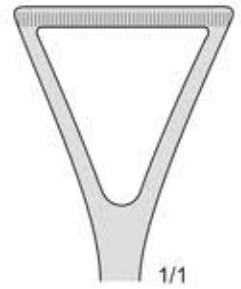

BD-199
200 mm

Darmpinzetten
Intestinal forceps
Pinze intestinali
Pinzas intestinales
Pincas pour préhension de l'intestin

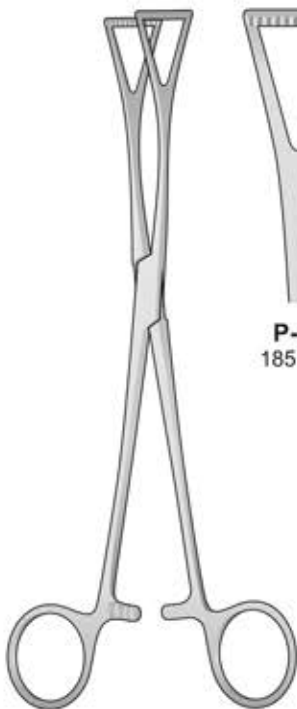

P-99
185 mm

DUVAL
P-99/P-224

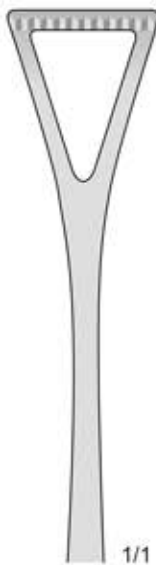

P-224
230 mm

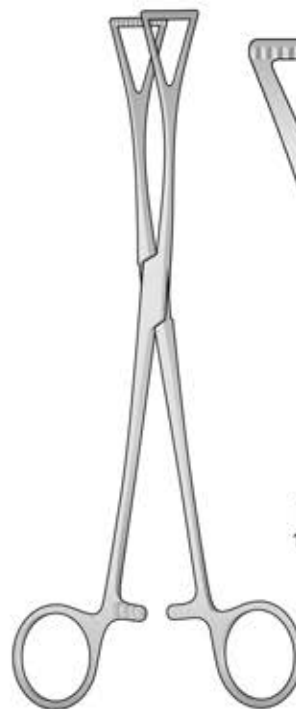

P-225
195 mm

DUVAL-COLLIN
P-225/P-226

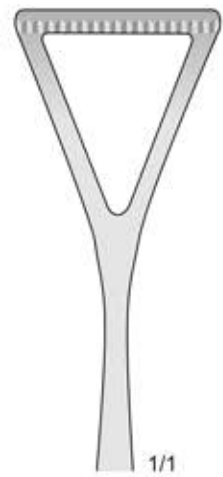

P-226
200 mm

4 x 5 zähne
4 x 5 teeth
4 x 5 denti
4 x 5 dientes
4 x 5 dents

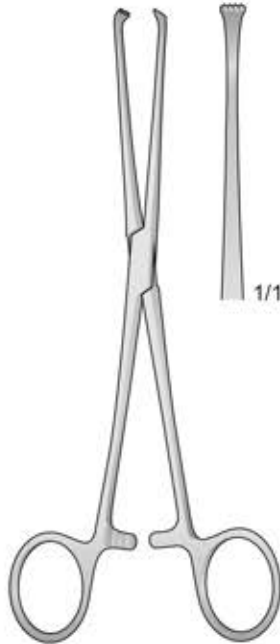

BABY-ALLIS
P-100
130 mm

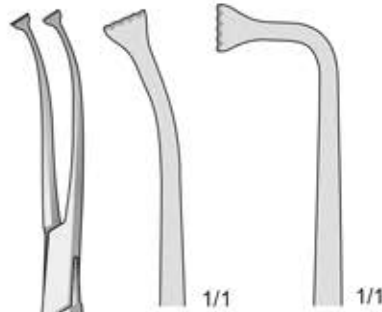

P-51
150 mm

P-53
145 mm

ALLIS
P-51/P-53

5 x 6 zähne
5 x 6 teeth
5 x 6 denti
5 x 6 dientes
5 x 6 dents

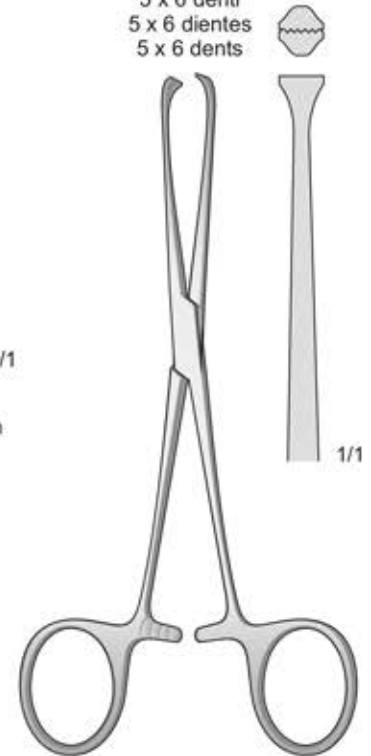

BOYS-ALLIS
P-129
150 mm

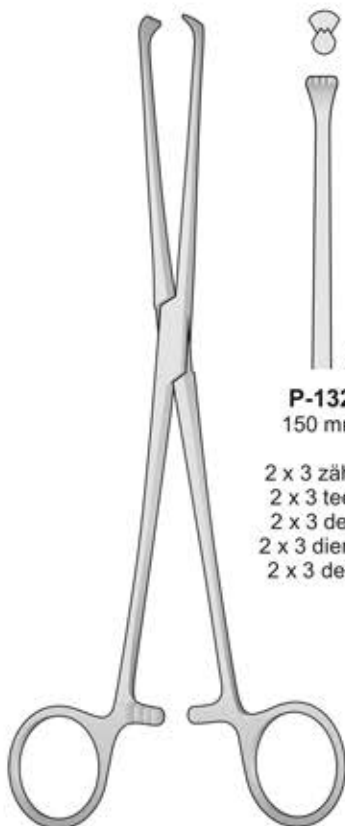

ALLIS
P-50/P-118

P-132 150 mm	P-133 150 mm	P-134 150 mm	P-50 160 mm	P-115 200 mm	P-119 220 mm	P-118 250 mm	
2 x 3 zähne 2 x 3 teeth 2 x 3 denti 2 x 3 dientes 2 x 3 dents	3 x 4 zähne 3 x 4 teeth 3 x 4 denti 3 x 4 dientes 3 x 4 dents	4 x 5 zähne 4 x 5 teeth 4 x 5 denti 4 x 5 dientes 4 x 5 dents	5 x 6 zähne 5 x 6 teeth 5 x 6 denti 5 x 6 dientes 5 x 6 dents	5 x 6 zähne 5 x 6 teeth 5 x 6 denti 5 x 6 dientes 5 x 6 dents	5 x 6 zähne 5 x 6 teeth 5 x 6 denti 5 x 6 dientes 5 x 6 dents	5 x 6 zähne 5 x 6 teeth 5 x 6 denti 5 x 6 dientes 5 x 6 dents	5 x 6 zähne 5 x 6 teeth 5 x 6 denti 5 x 6 dientes 5 x 6 dents

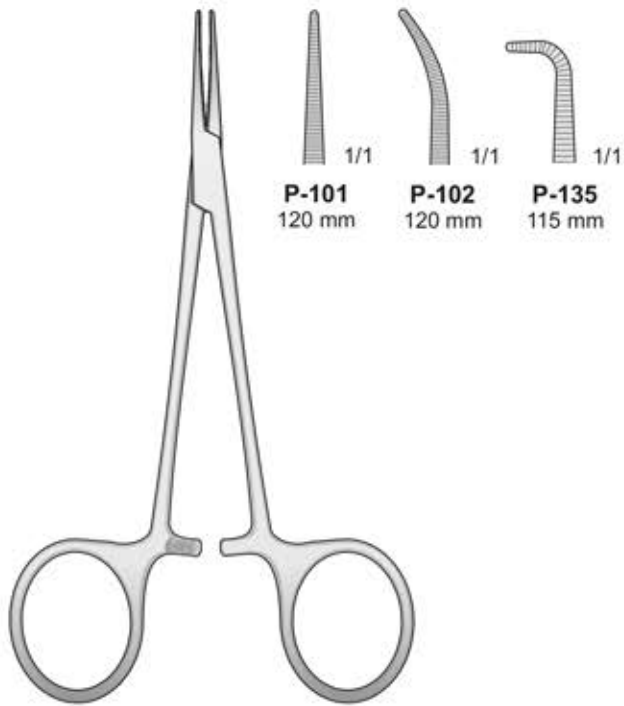

MICRO-HALSTED
P-101/P-135

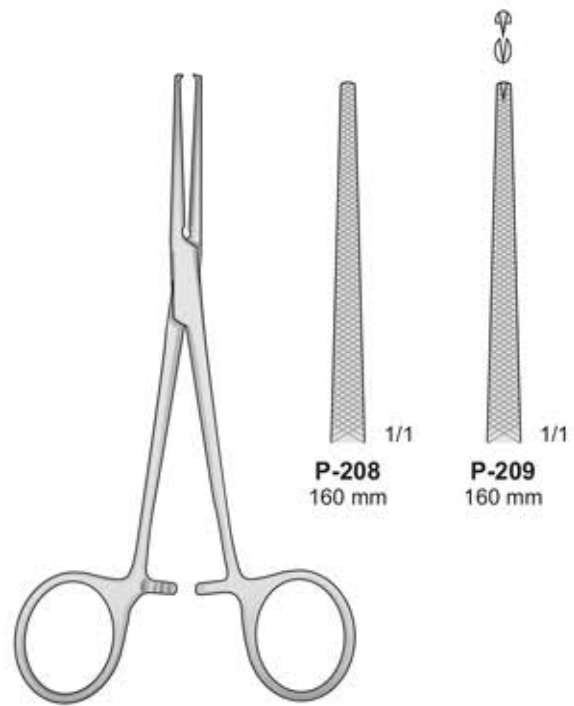

DIXON-LOVELACE
P-208/P-209

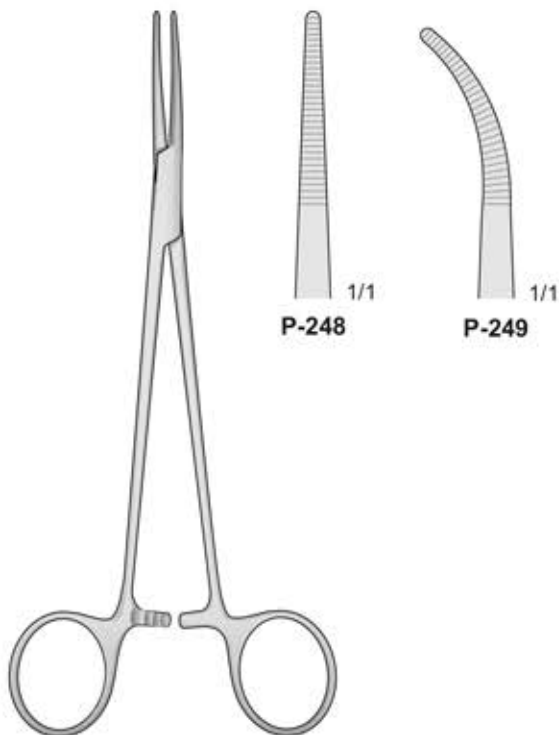

BIRKETT
P-248/P-249
180 mm

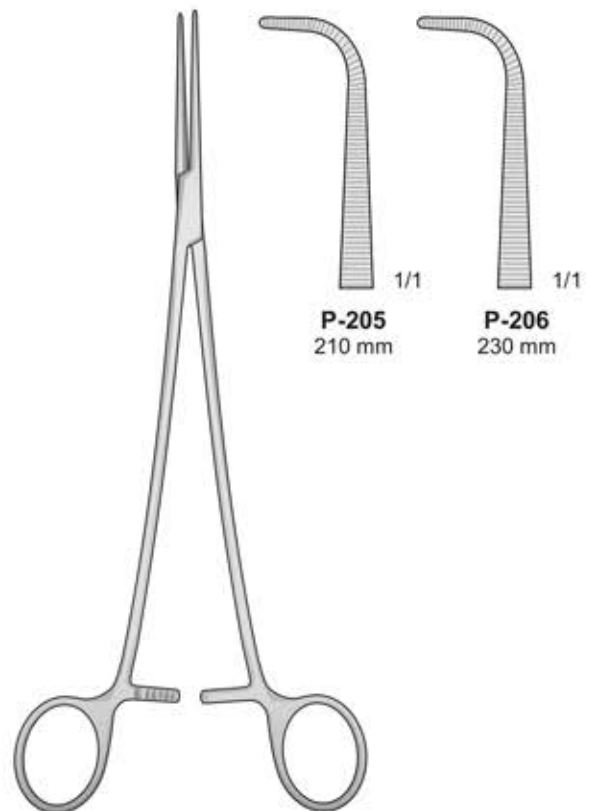

BENGOLEA
P-205/P-206

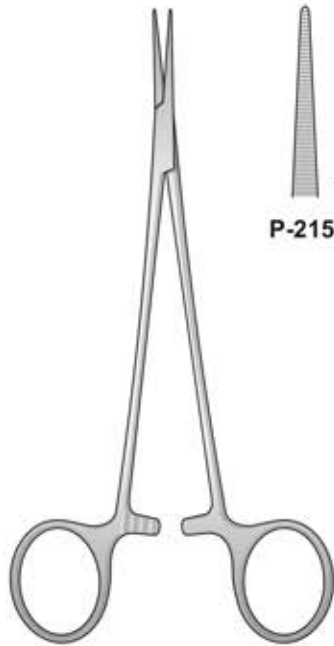

P-215/P-217
160 mm

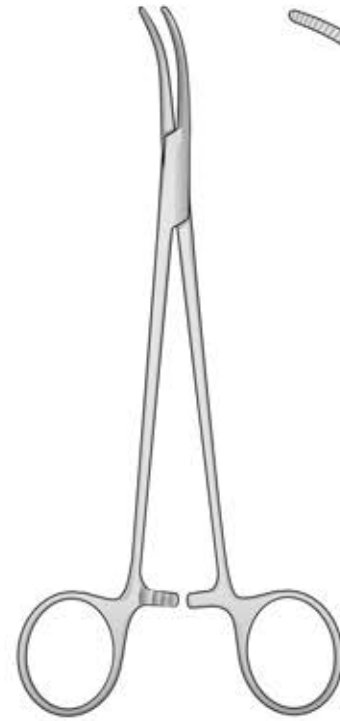
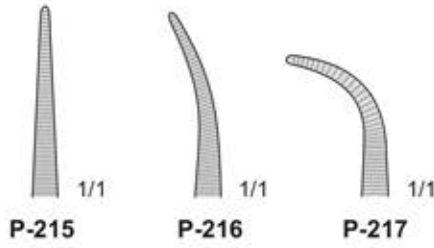

ROCHESTER-PEAN
P-210
180 mm

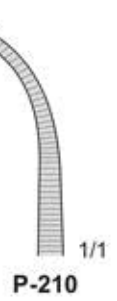

GEMINI
P-191/P-197

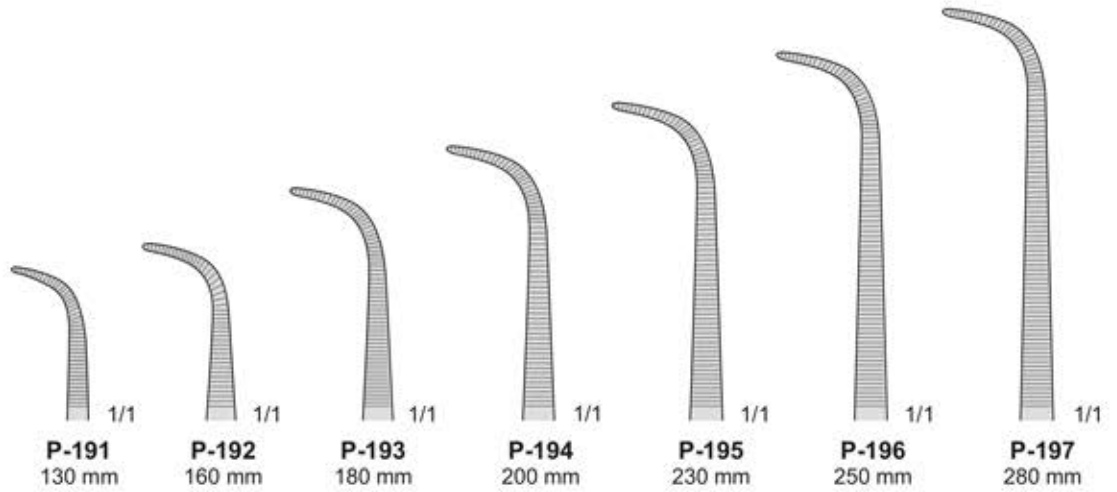

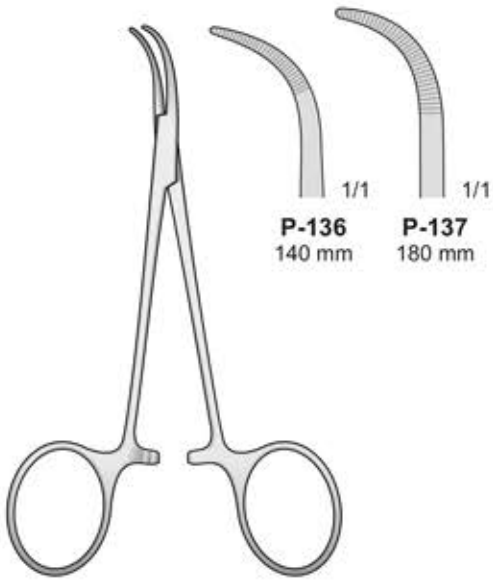

BABY-MIXTER
P-136/P-137

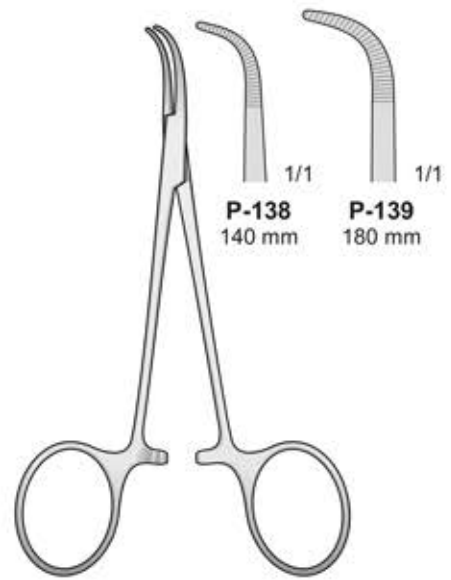

BABY-ADSON
P-138/P-139

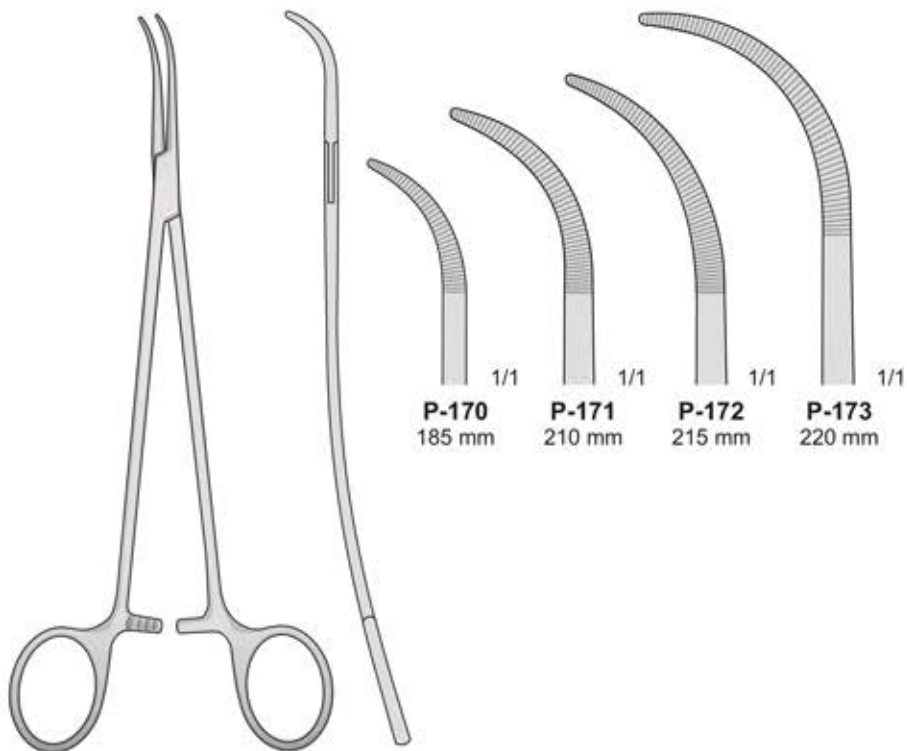

P-170/P-173

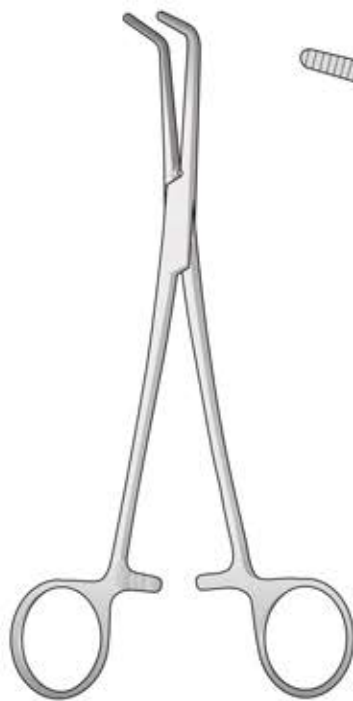

MIXTER
P-123/P-125

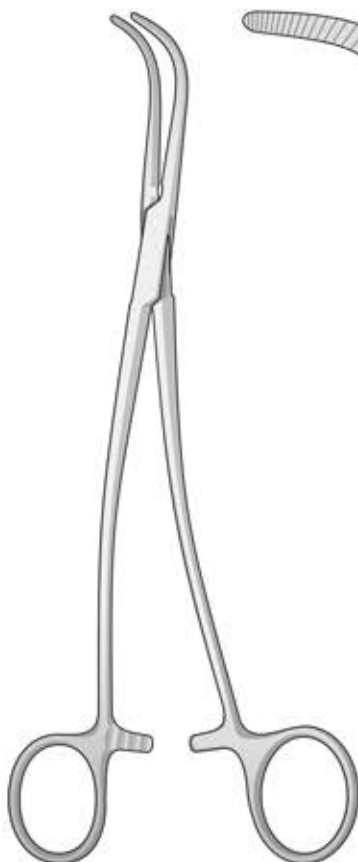
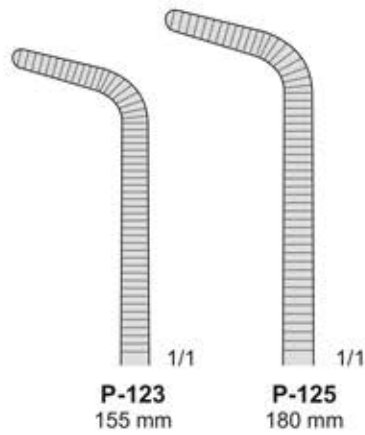

GRAY
P-179/P-180
220 mm

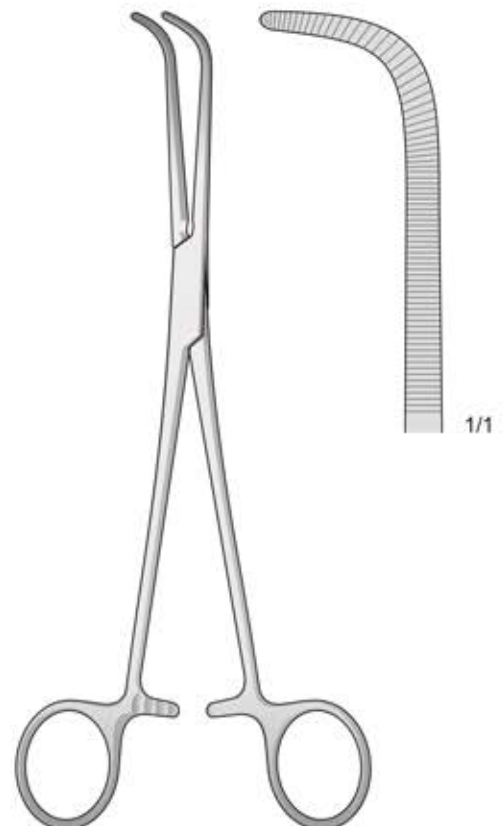
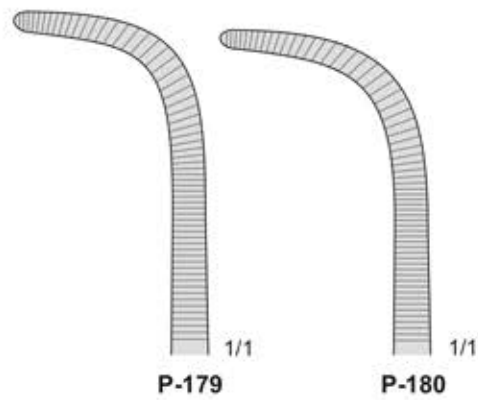

WIKSTROEM
P-181
205 mm

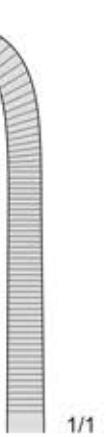

Atraumatische - Atraumatic
Atraumatiche - Atraumáticas - Atraumatiques

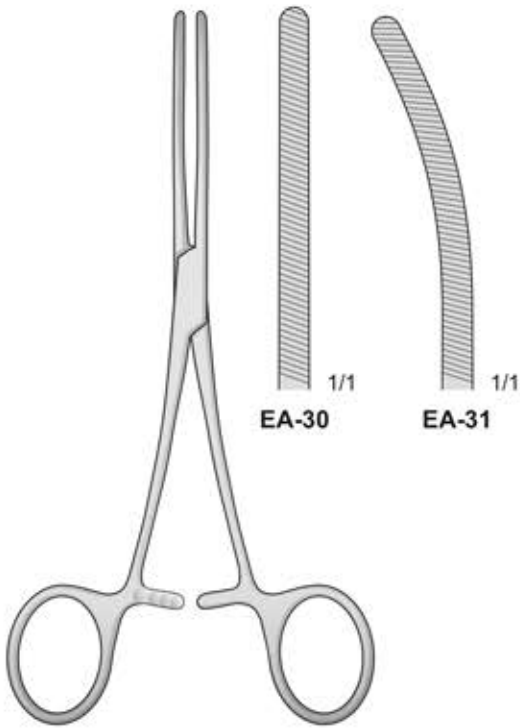

DOYEN
EA-30/EA-31
170 mm

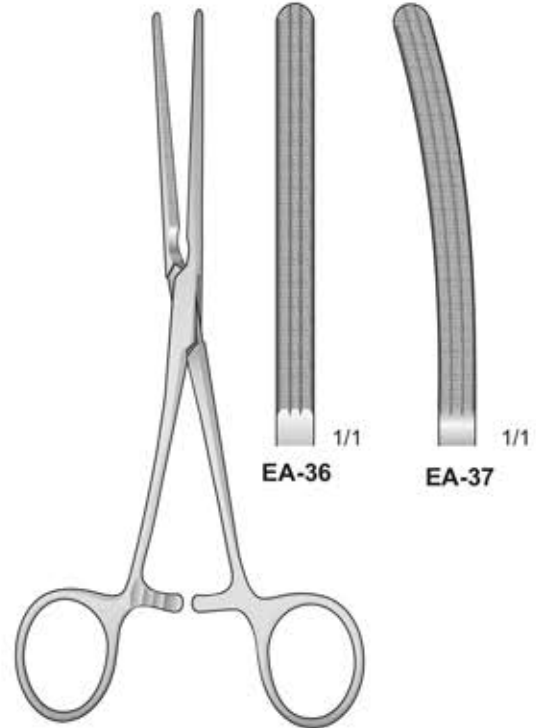

DOYEN
EA-36/EA-37
170 mm

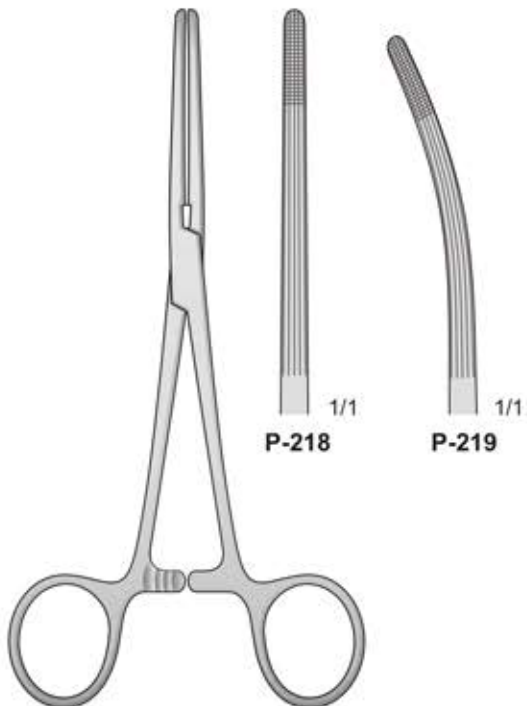

ROCHESTER-CARMALT
P-218/P-219
160 mm

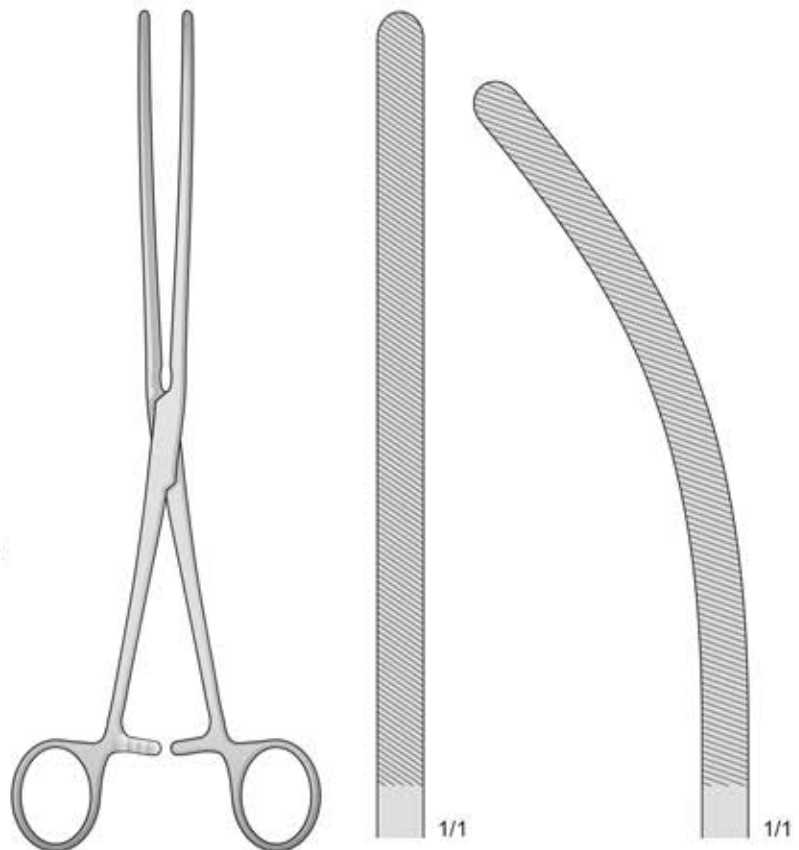

DOYEN
EA-32/EA-33
230 mm

Atraumatische - Atraumatic
Atraumatische - Atraumáticas - Atraumatiques

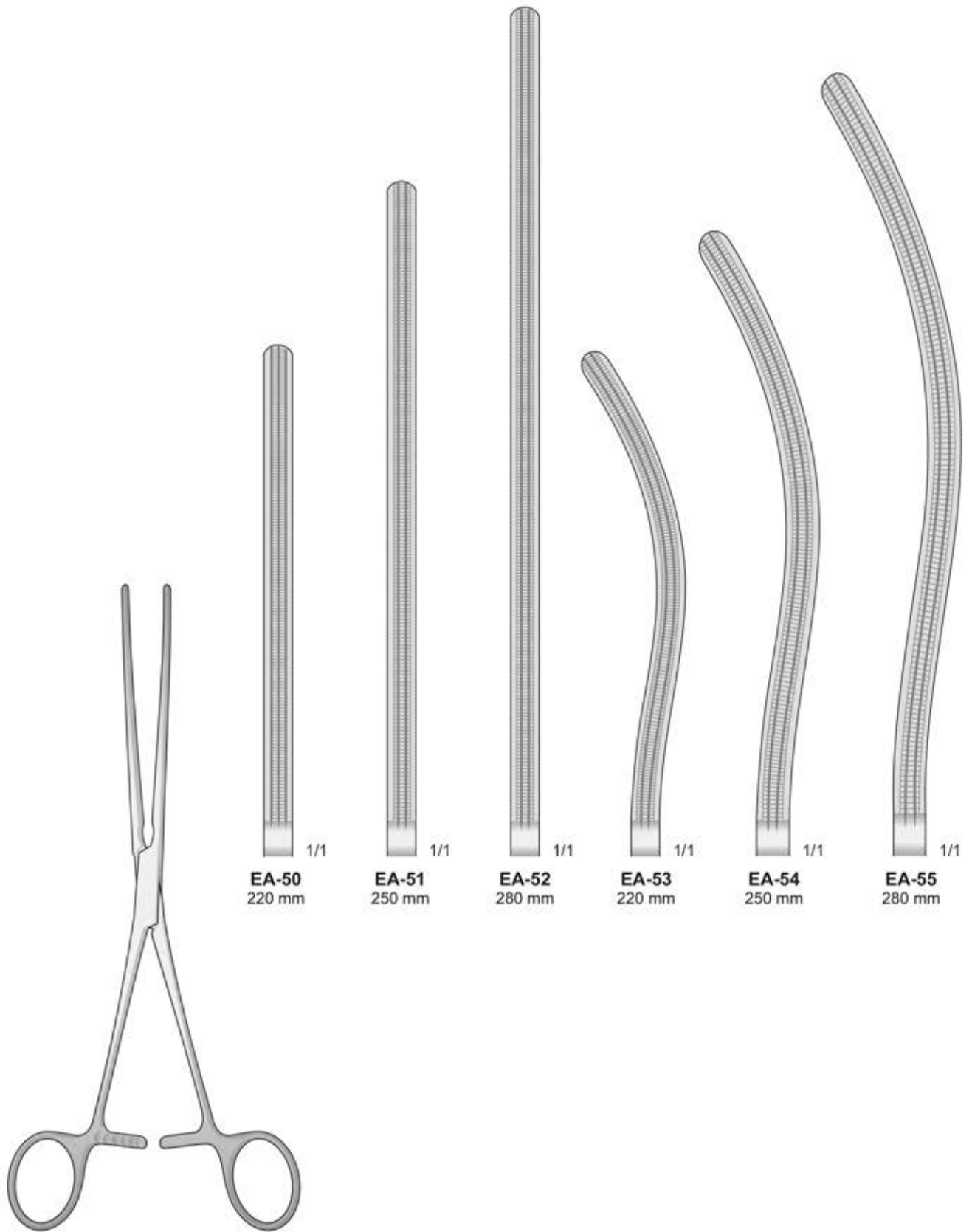

EA-50
220 mm

EA-51
250 mm

EA-52
280 mm

EA-53
220 mm

EA-54
250 mm

EA-55
280 mm

KOCHER
EA-50/EA55



Atraumatische
Atraumatic
Atraumatiche
Atraumáticas
Atraumatiques



CASTANEDA
FB-236/FB-239
155 mm

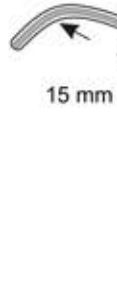

FB-236
48 mm



FB-237
52 mm



FB-238
56 mm

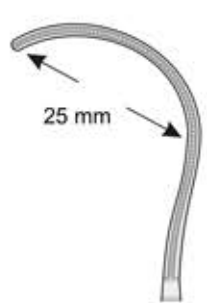

FB-239
50 mm



FB-251

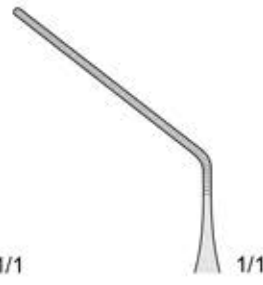

FB-252



FB-253

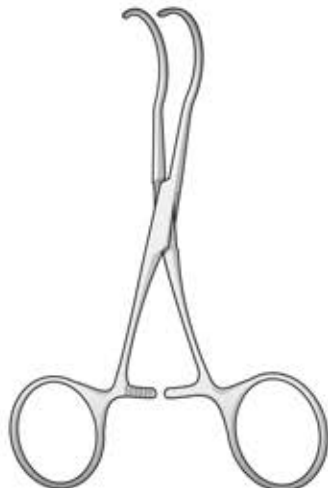

CASTANEDA
FB-251/FD-257
120 mm



FB-254



FB-255

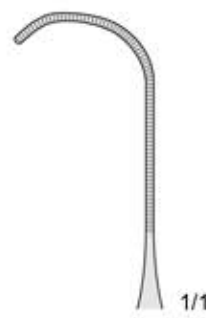

FB-256



FB-257

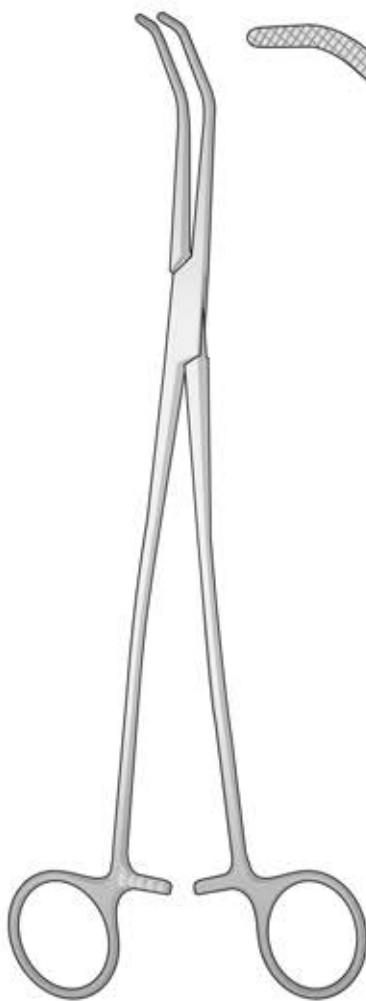

SATINSKY
FB-88/FB-89
260 mm

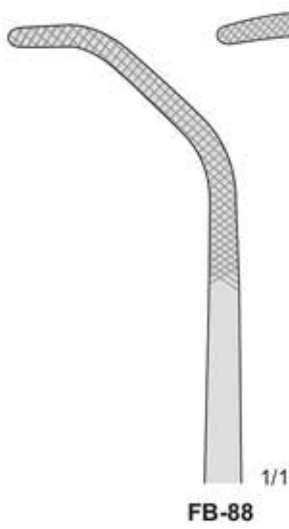

FB-88

1/1

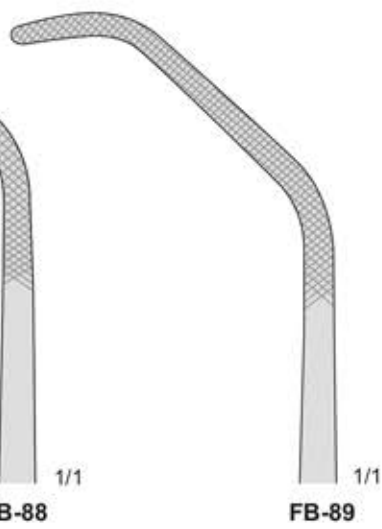

FB-89

1/1

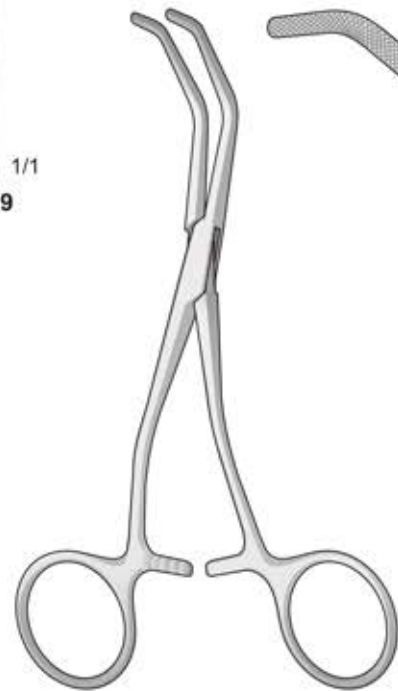

BABY-SATINSKY
FB-46
150 mm

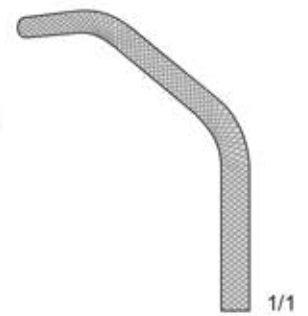

1/1

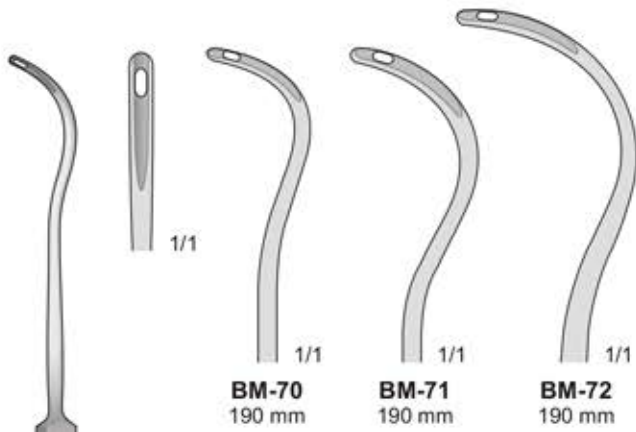

BM-70
190 mm

BM-71
190 mm

BM-72
190 mm

Biigsam
Flexible
Malleabile
Maleable
Souple

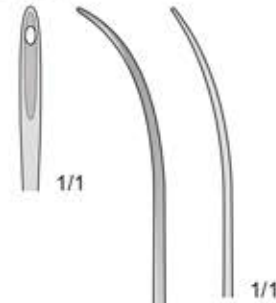

KOCHER
BM-70/BM-72
190 mm

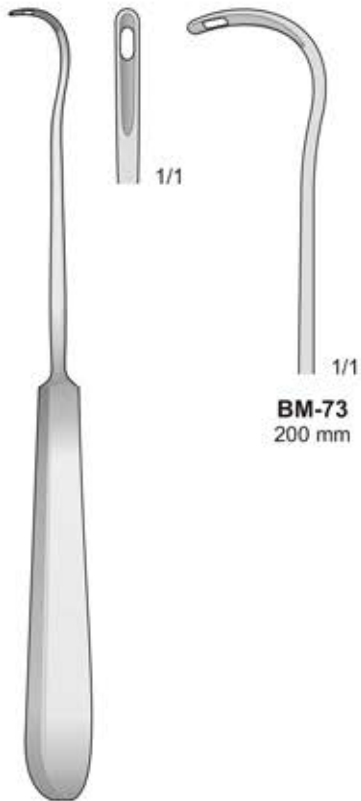

BM-73
200 mm

COOPER
BM-73
200 mm

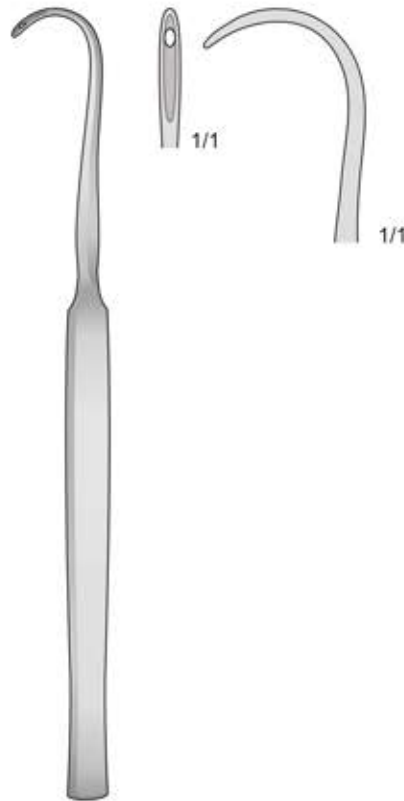

COOPER
BM-29
190 mm

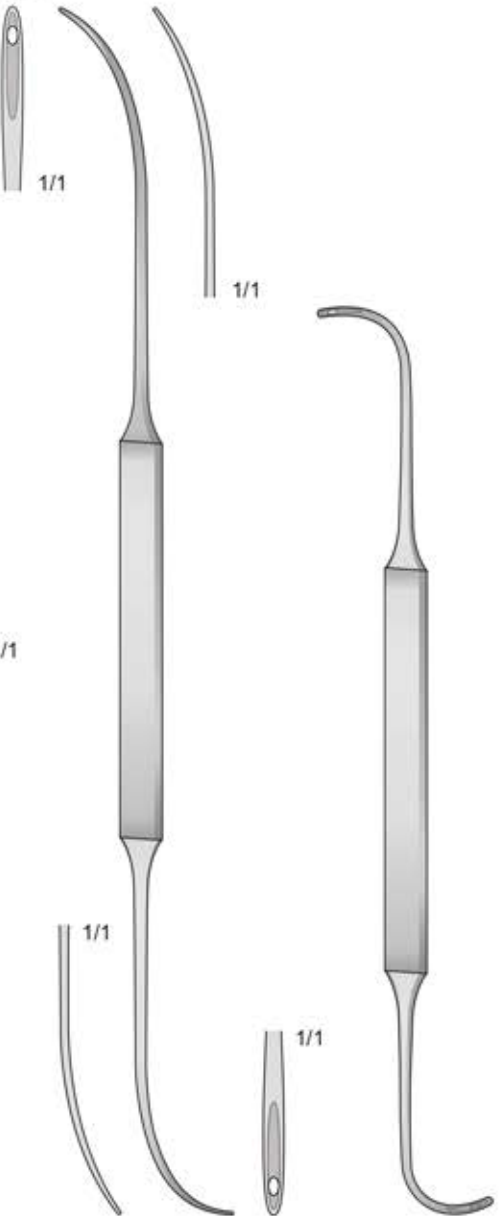

SCHMIEDEN-DICK
BM-17
320 mm

SCHMIEDEN
BM-18
210 mm

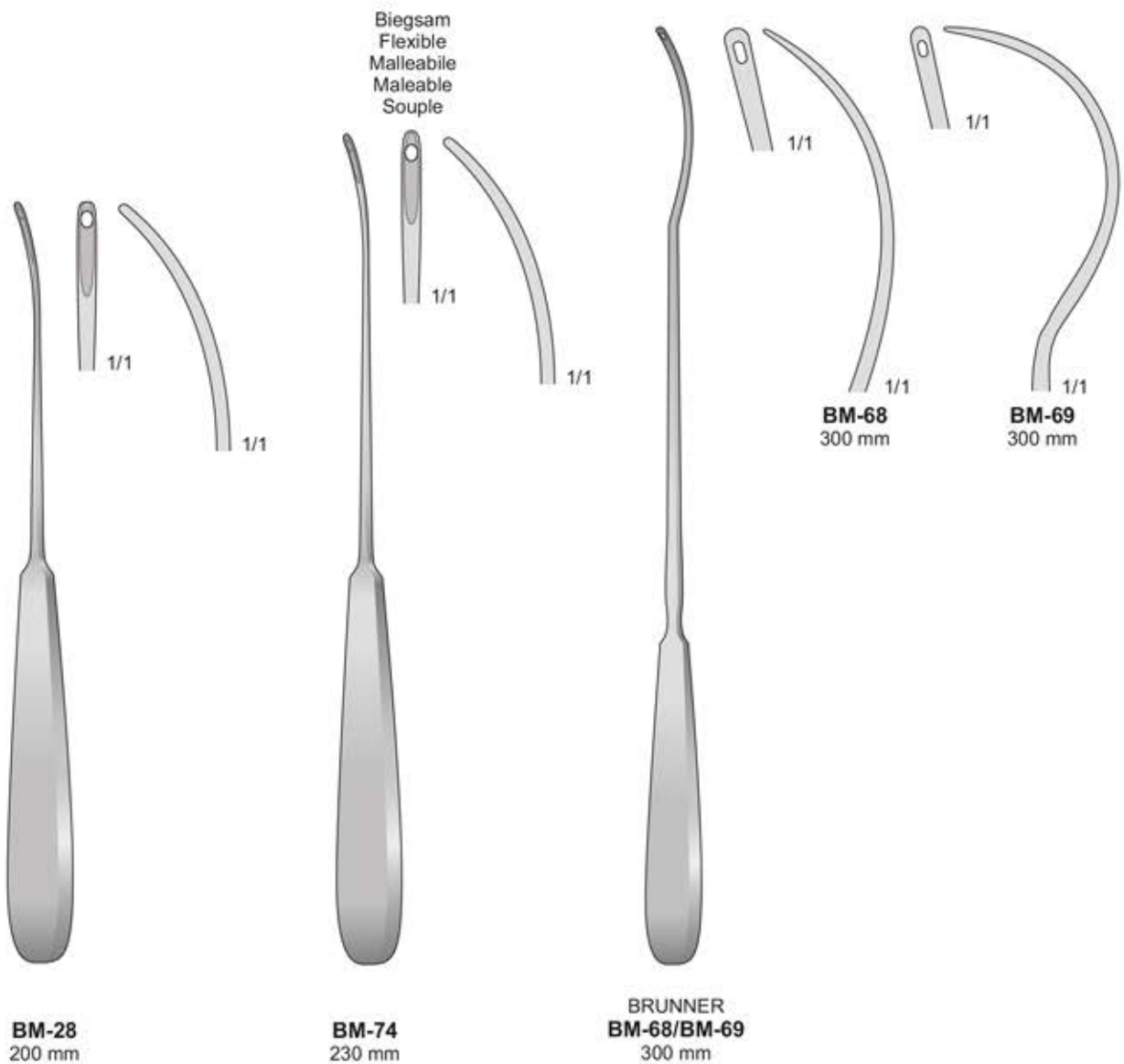

Nadelhalter mit Hartmetalleinlagen
 Needle Holders with tungsten-carbide inserts
 Portaghi con inserti al tungsteno
 Portaagujas con plaquitas de carburo de tungsteno
 Porte aiguilles avec plaquettes en carbure de tungstène

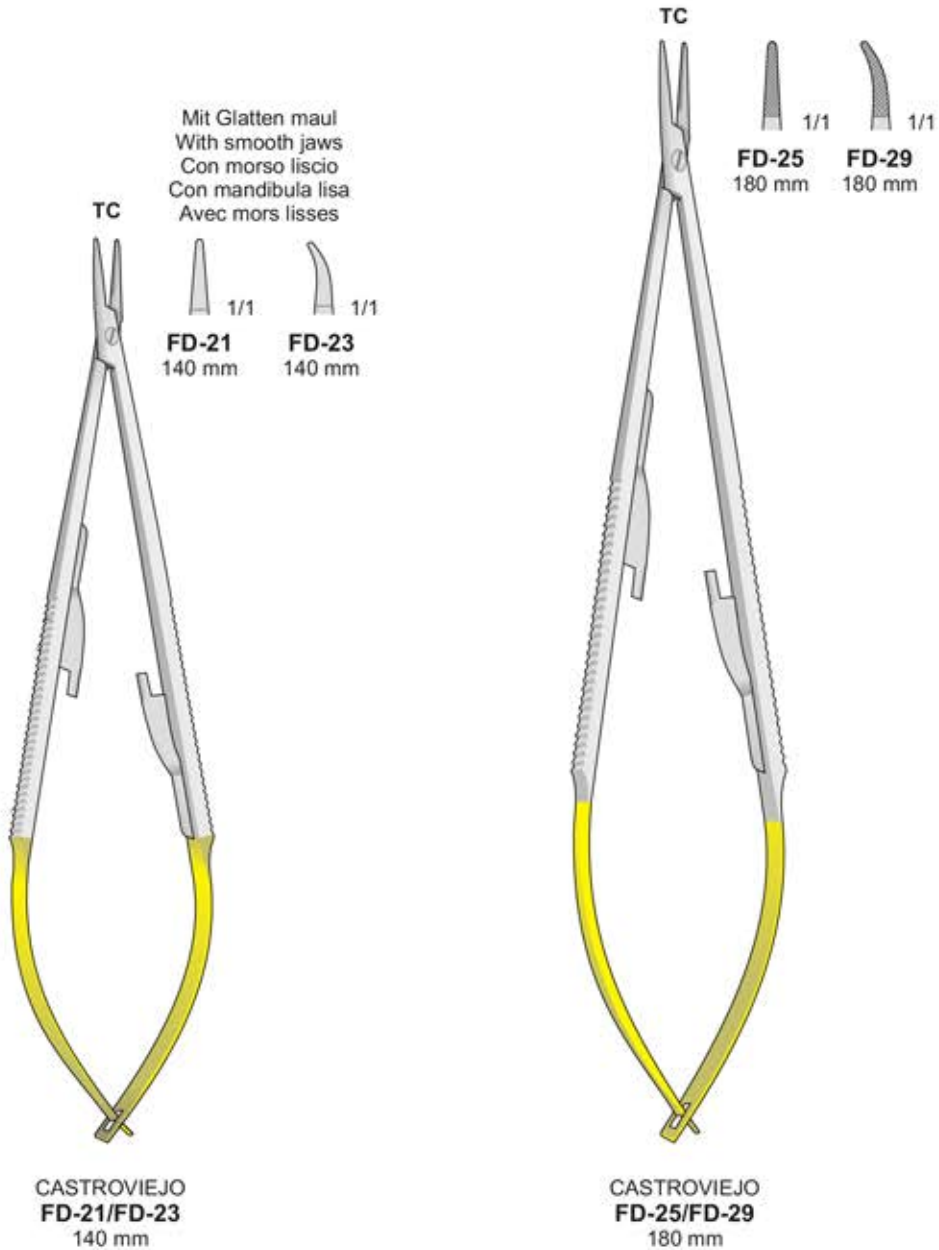

Mit Schere - With Scissors
 Con Forbice - Con Tijeras
 Avec Ciseaux



OLSEN-MATHIEU
 PO-95/PO-100



1/1

PO-95
 140 mm



1/1

PO-98
 170 mm



1/1

PO-100
 200 mm



MATHIEU
 PO-46/PO-48



PO-46
 140 mm



PO-47
 170 mm



PO-48
 200 mm



MATHIEU
 PO-50/PO-52



PO-50
 140 mm



PO-51
 170 mm



PO-52
 200 mm



MATHIEU
 PO-66
 200 mm



1/1

Mit Glatten maul
 With smooth jaws
 Con morso liscio
 Con mandibula lisa
 Avec mors lisses

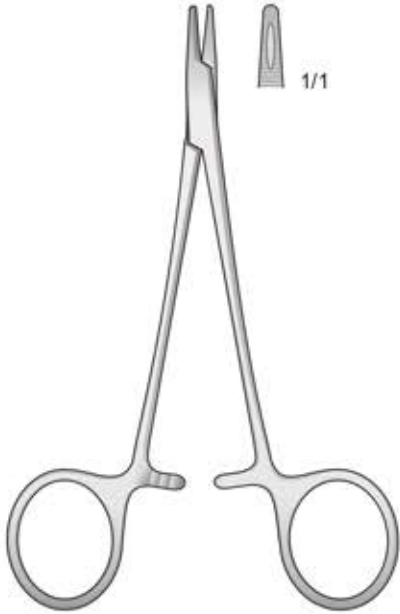

DERF
PH-39
 125 mm

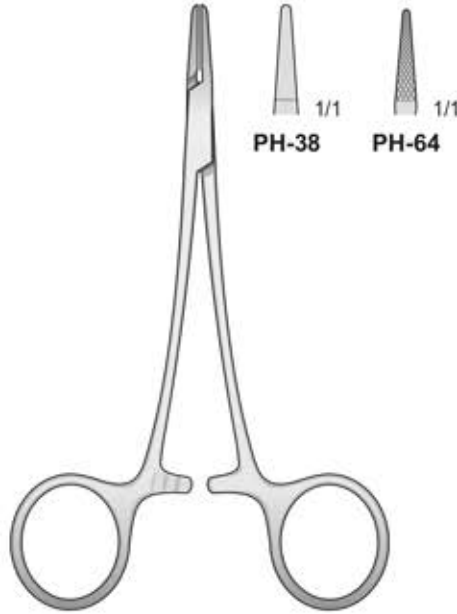

PH-38/PH-64
 120 mm

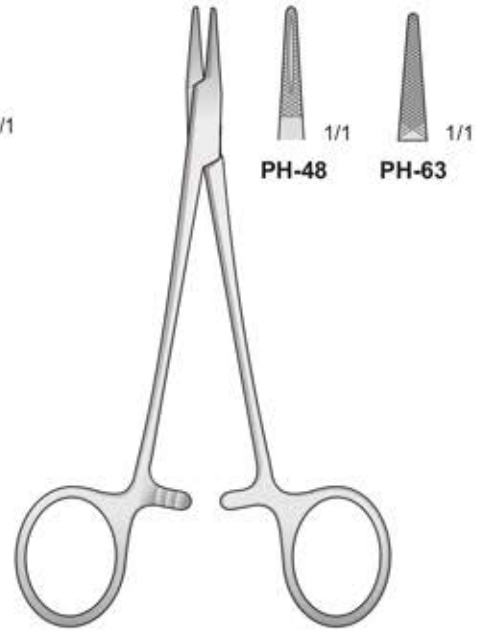

HALSEY
PH-48/PH-63
 130 mm



HEANEY (HEGAR)
PH-52
 200 mm

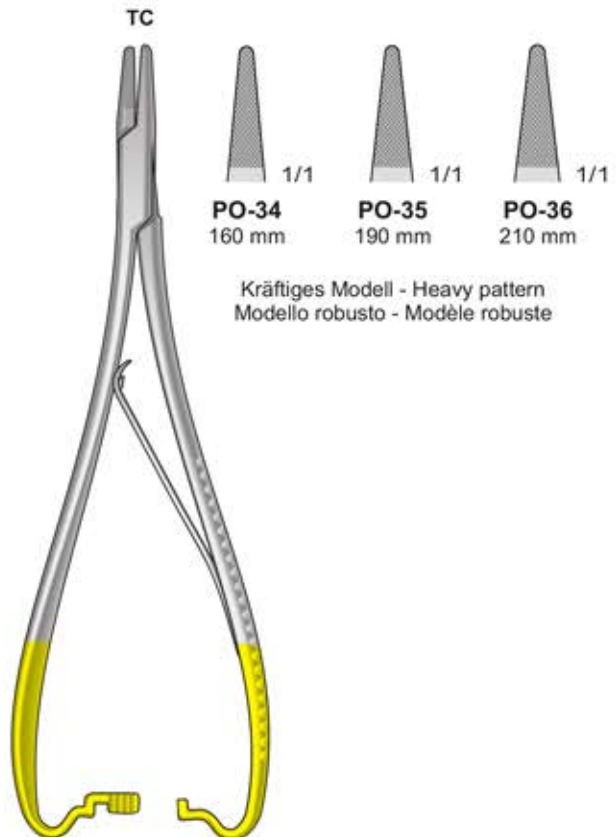

MATHIEU
PO-34/PO-36

Kräftiges Modell - Heavy pattern
 Modello robusto - Modèle robuste

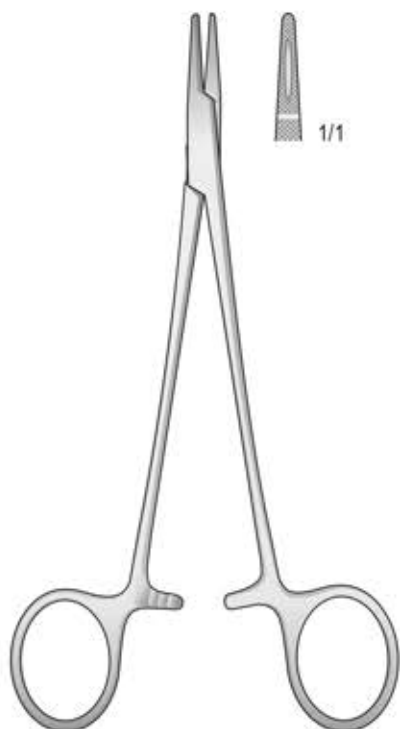

CRILE-WOOD
PH-61
150 mm

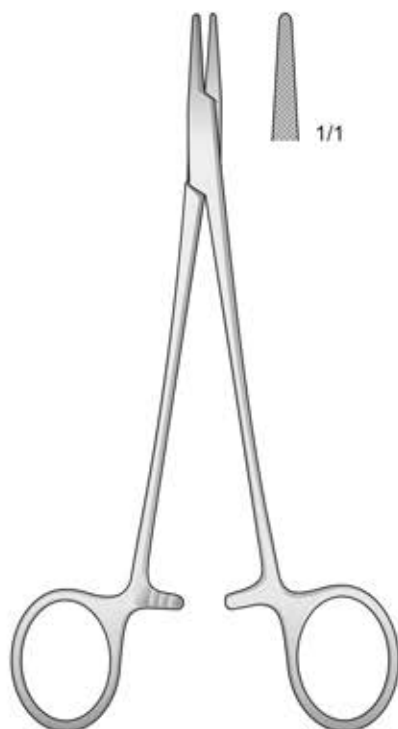

CRILE-MURRAY
PH-62
150 mm

Schlankesmodell - Delicate pattern - Modello fine
Modelo delegado - Modèle fin

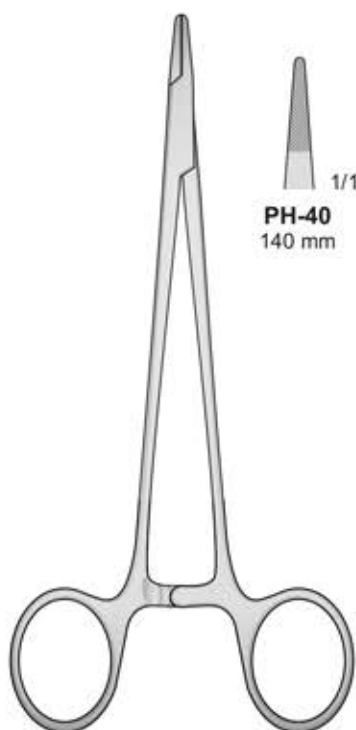

MAYO-HEGAR
PH-40/PH-45

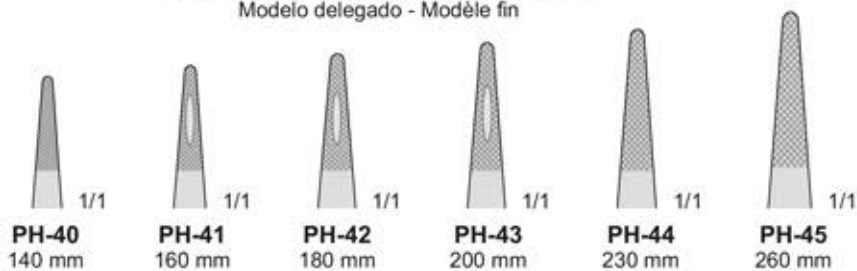

Nadelhalter mit Schere - Needle holders with scissors - Port'aghi con forbici - Portaagujas con tijeras - Porte aiguilles avec ciseaux



MINI-OLSEN-HEGAR
BM-61
120 mm



OLSEN-HEGAR
BM-62
140 mm



OLSEN-HEGAR
BM-63
170 mm



OLSEN-HEGAR
BM-64
190 mm

Nadelhalter mit Hartmetalleinlagen - Needle Holders with tungsten-carbide inserts
 Portaghi con inserti al tungsteno - Portaagujas con plaquitas de carburo de tungsteno
 Porte aiguilles avec plaquettes en carbure de tungstène

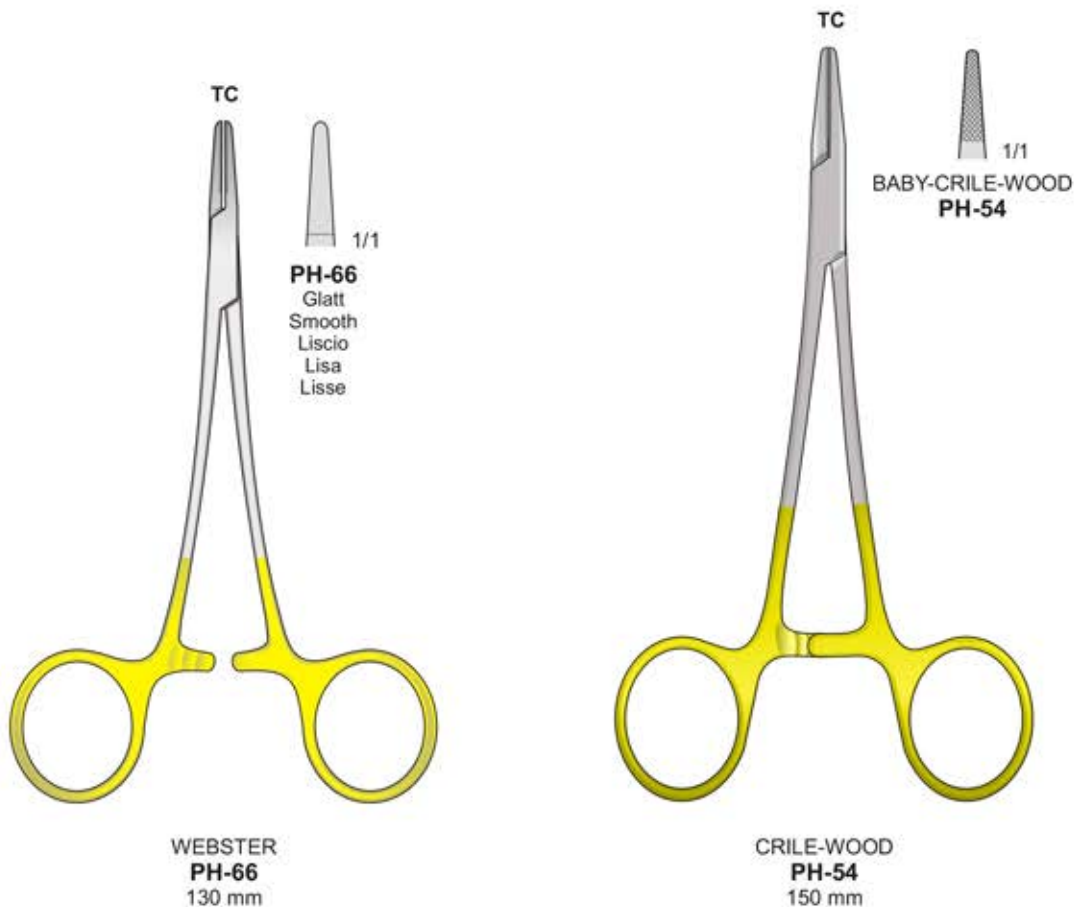
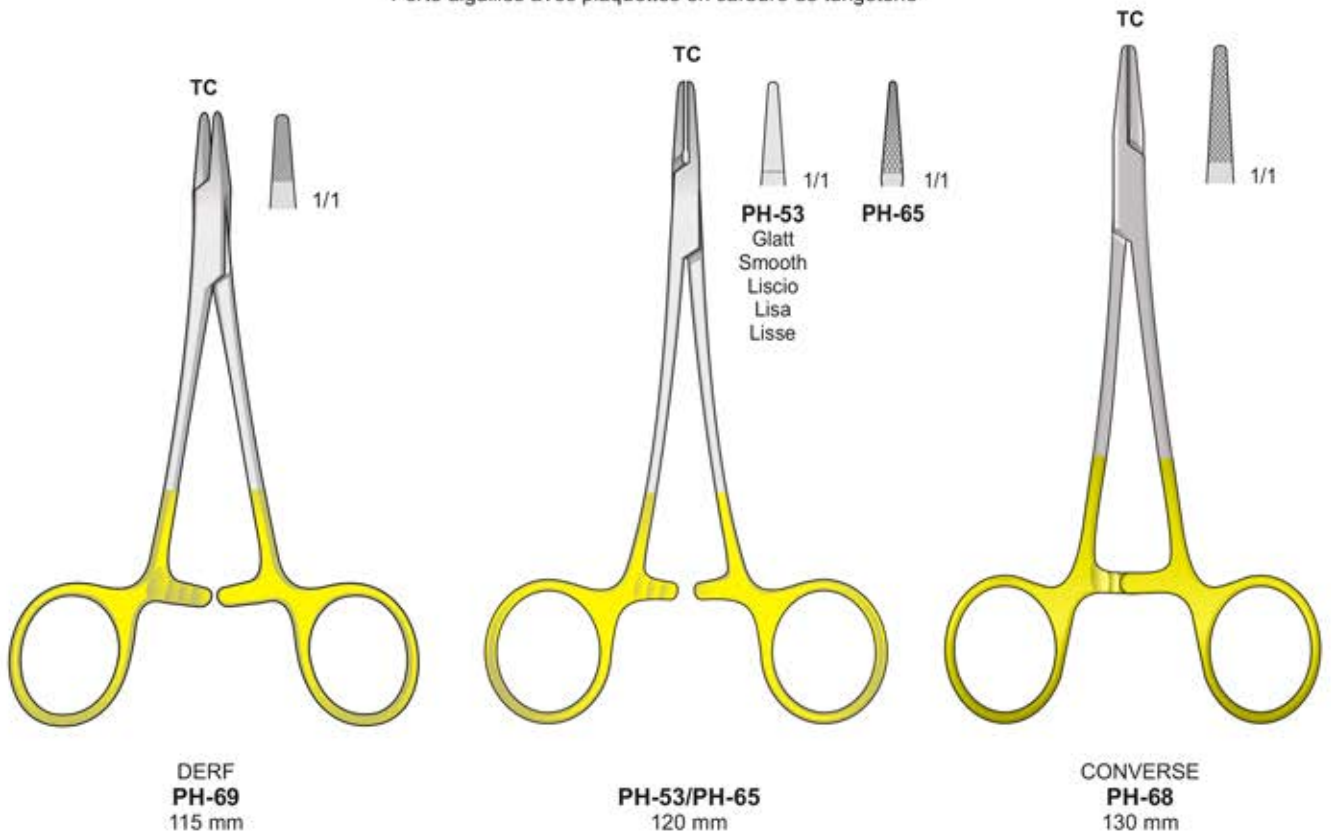

Nadelhalter mit Hartmetalleinlagen - Needle Holders with tungsten-carbide inserts
 Portaghi con inserti al tungsteno - Portaagujas con plaquitas de carburo de tungsteno
 Porte aiguilles avec plaquettes en carbure de tungstène

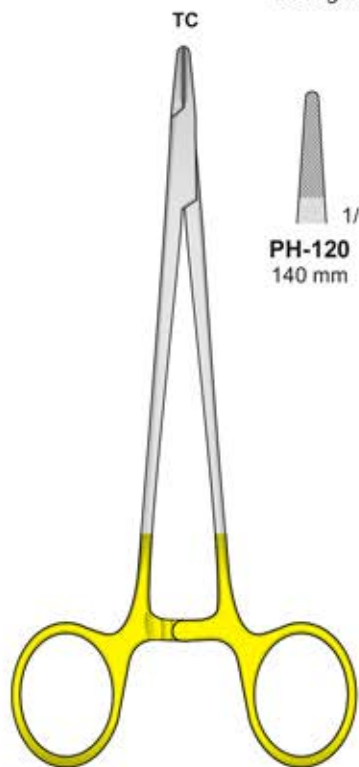

MAYO-HEGAR
PH-120/PH-125

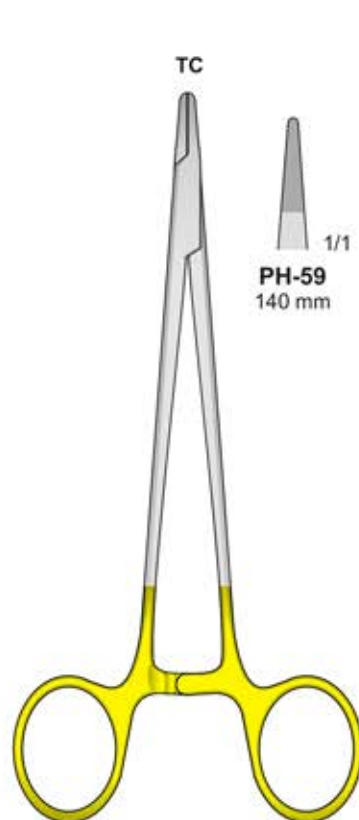
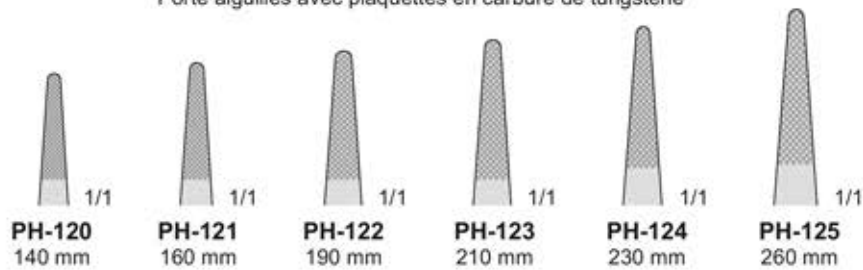

HEGAR
PH-59

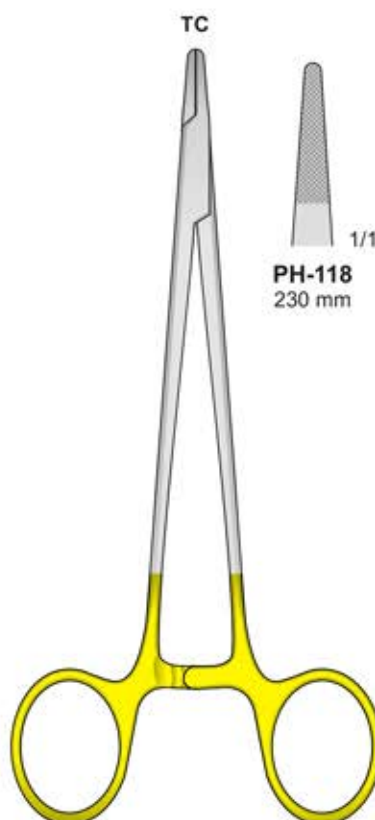

MAYO-HEGAR
PH-117/PH-119

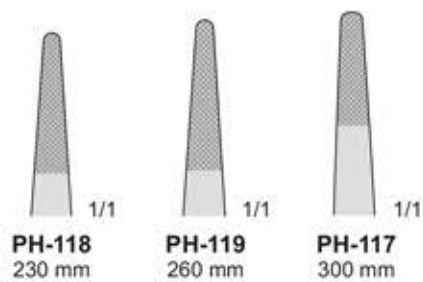

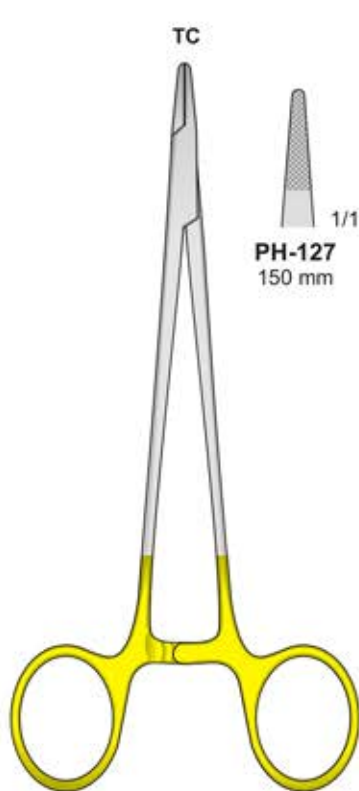

MAYO-HEGAR-FINO
PH-127/PH-129

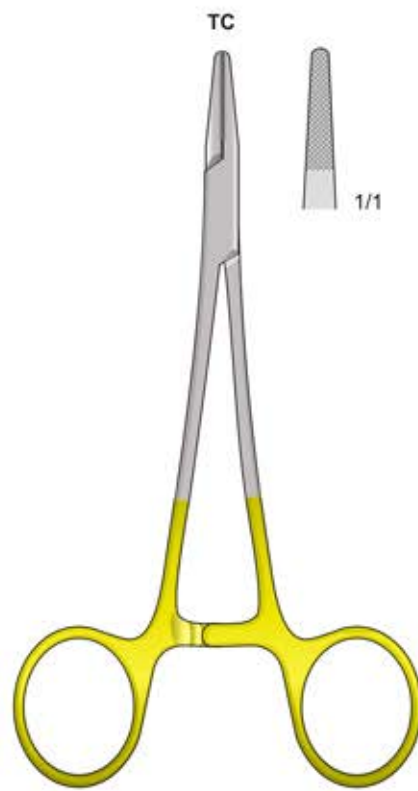
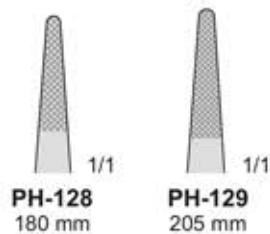

CRILE-WOOD
PH-77
180 mm

Nadelhalter, Draht-Zangen
Needle holder, wire forceps
Port'aghi, pinze per fili d'acciaio
Porta agujas, pinzas para hilos
Porte-aiguilles, pincès à saisir

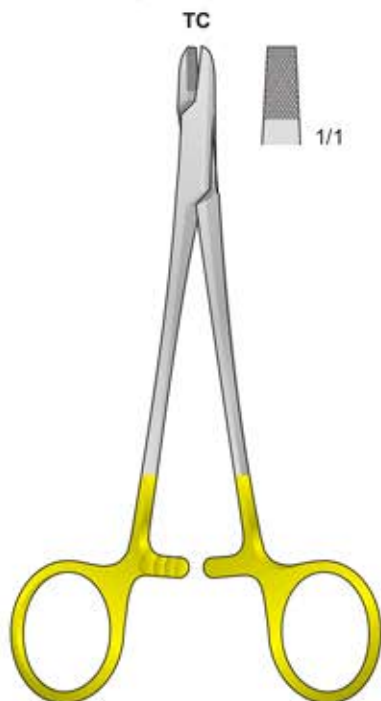

PH-58
150 mm



HEGAR-MAYO-SEELEY
PH-130
200 mm

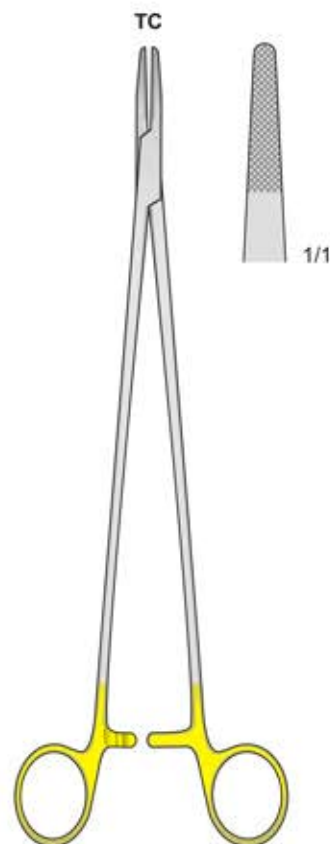

WANGENSTEEN
PH-131
270 mm

Nadelhalter mit Hartmetalleinlagen - Needle Holders with tungsten-carbide inserts
 Portaghi con inserti al tungsteno - Portaagujas con plaquitas de carburo de tungsteno
 Porte aiguilles avec plaquettes en carbure de tungstène

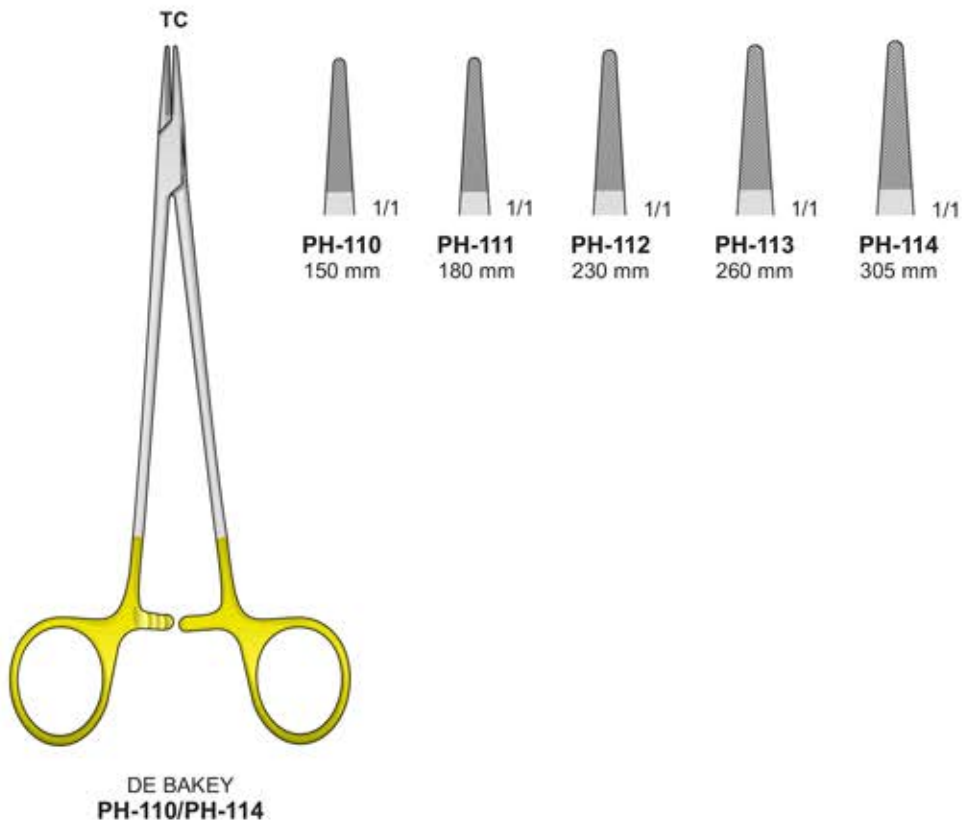
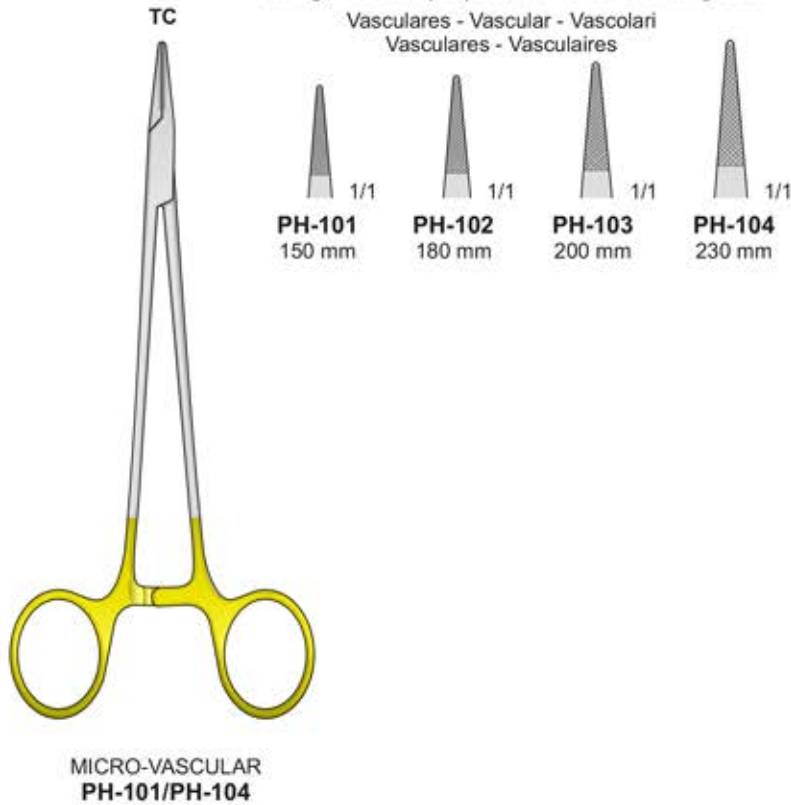

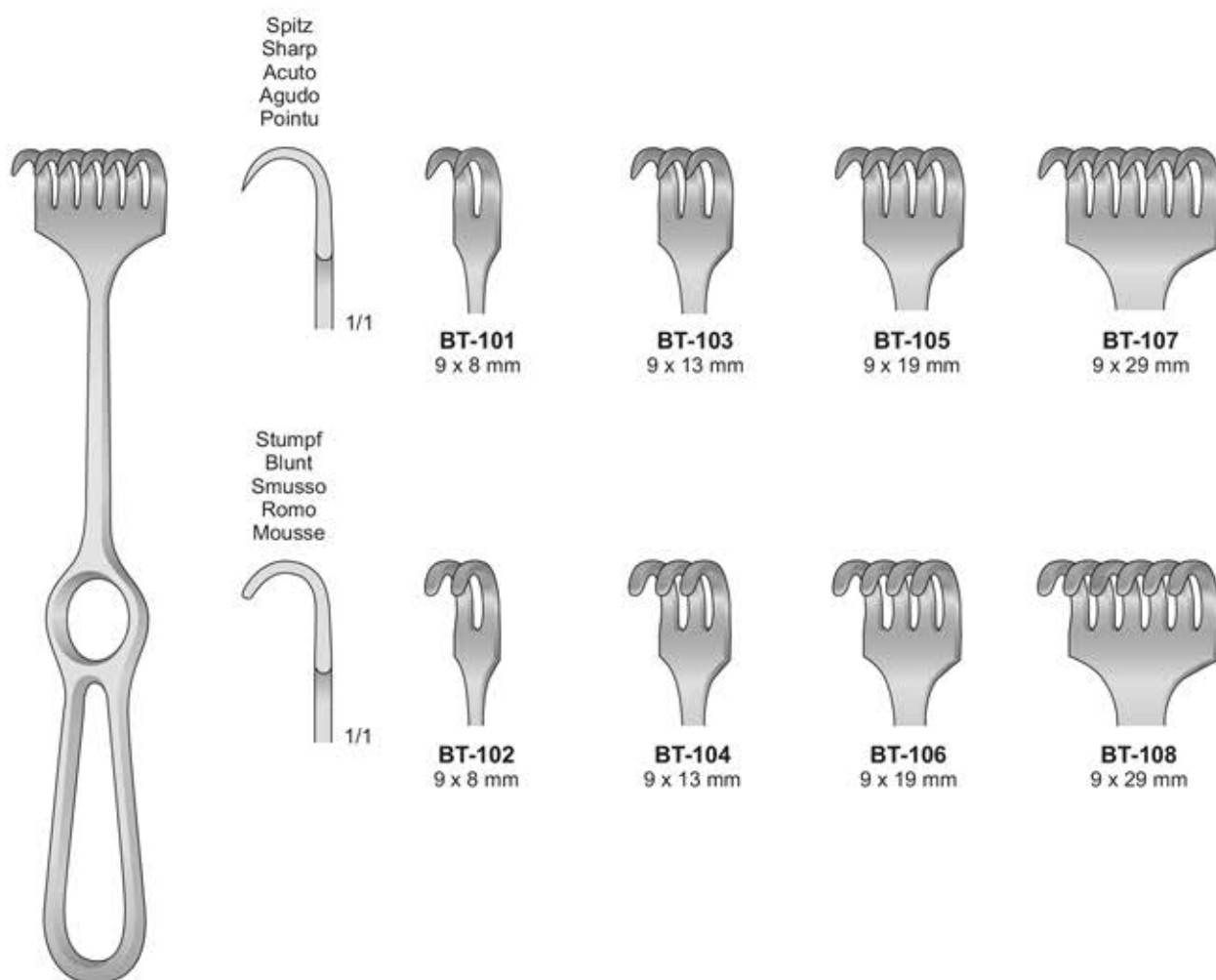

Spitz
Sharp
Acuto
Agudo
Pointu

Stumpf
Blunt
Smusso
Romo
Mousse

BT-101
9 x 8 mm

BT-103
9 x 13 mm

BT-105
9 x 19 mm

BT-107
9 x 29 mm

BT-102
9 x 8 mm

BT-104
9 x 13 mm

BT-106
9 x 19 mm

BT-108
9 x 29 mm

VOLKMANN
BT-101/BT-108
220 mm

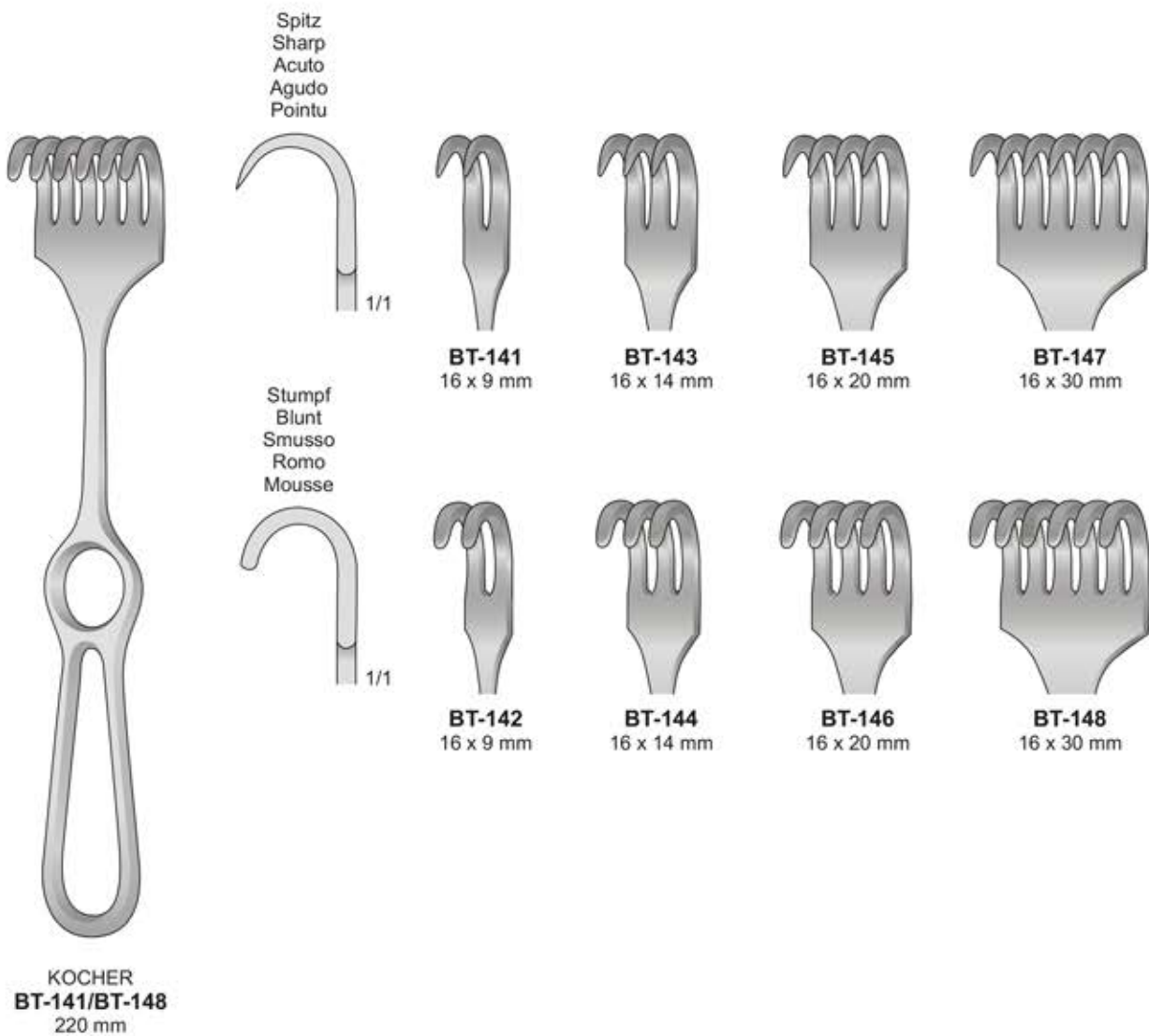

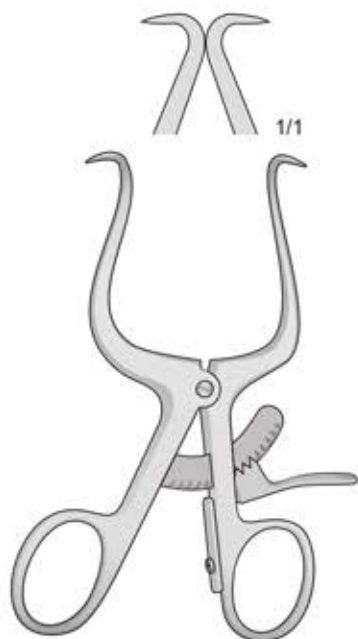

GELPI
BV-14
90 mm

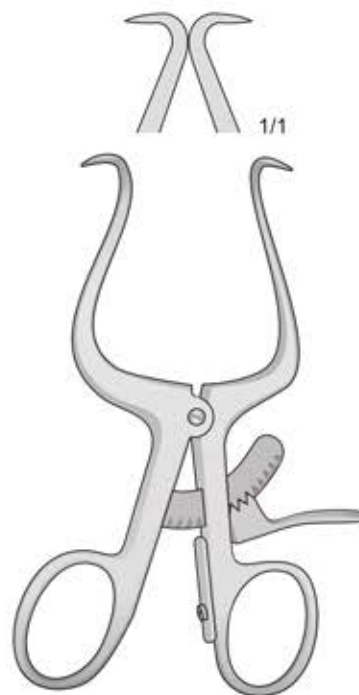

GELPI
BV-15
110 mm

Spitz - Sharp - Acuto
Agudas - Pointu

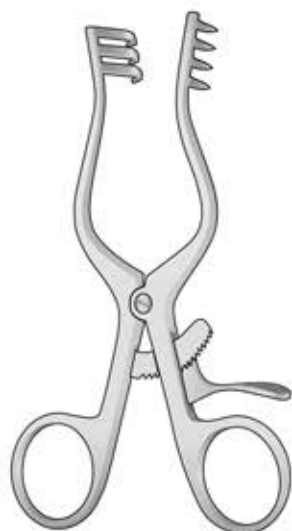

WEITLANER
BV-55
135 mm

Stumpf - Blunt - Smusso
Romas - Mousse

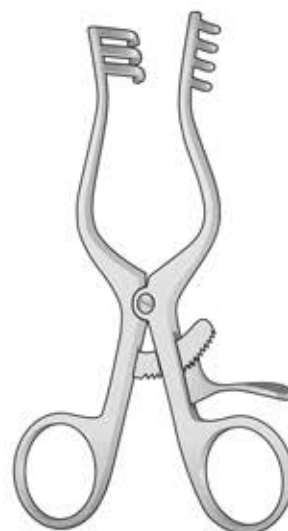

WEITLANER
BV-56
135 mm

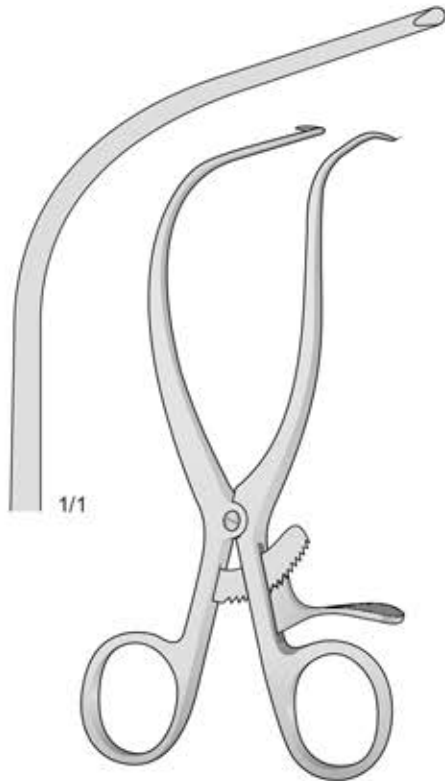

GELPI-SELETZ
BV-11
165 mm

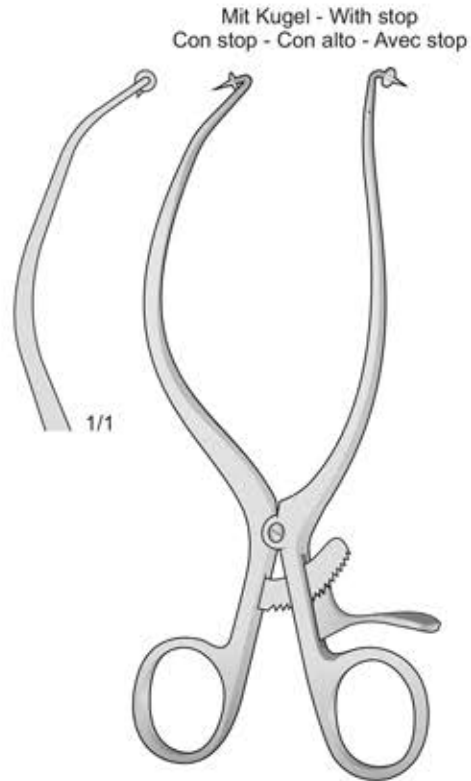

GELPI-LOKTITE
BV-13
190 mm

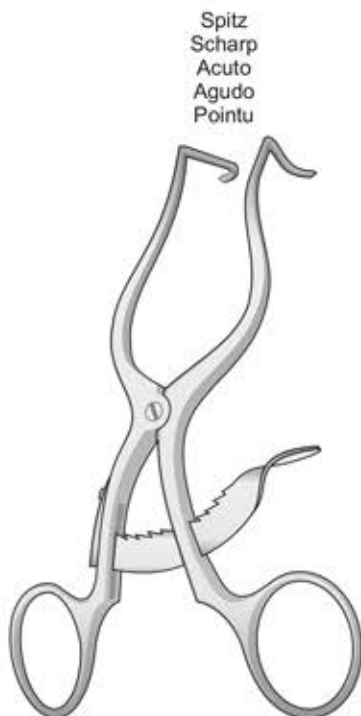

CLOWARD-CONTOUR
BV-108
140 mm

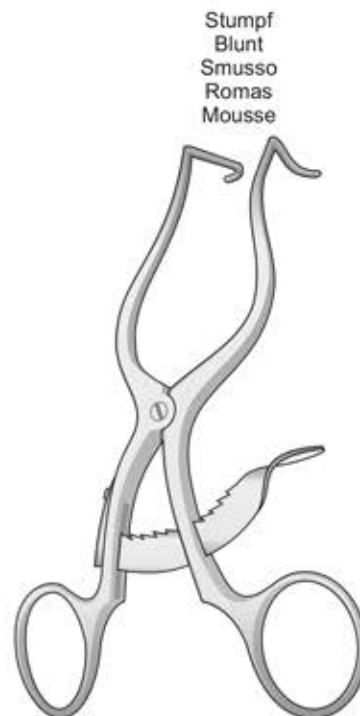

CLOWARD-CONTOUR
BV-109
140 mm

Spitz
Scharp
Acuto
Agudo
Pointu



1/1

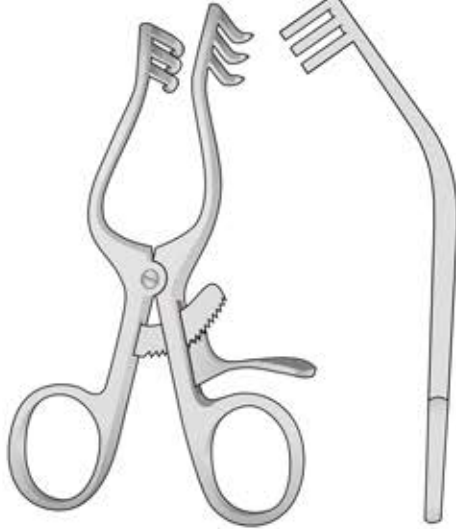

WULLSTEIN
BV-111
105 mm

Stumpf
Blunt
Smusso
Romas
Mousse



1/1

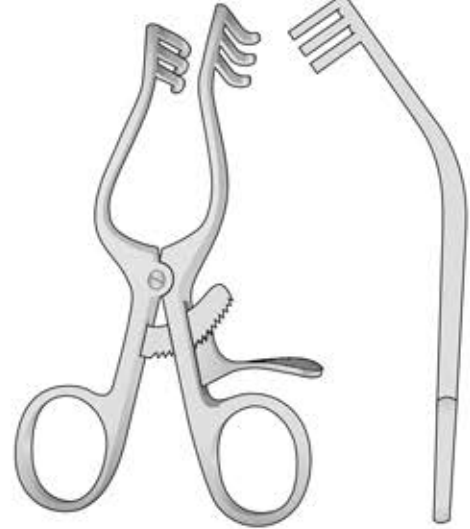

WULLSTEIN
BV-112
105 mm

Spitz
Scharp
Acuto
Agudo
Pointu



1/1



WEITLANER
BV-07
110 mm

Stumpf
Blunt
Smusso
Romas
Mousse



1/1

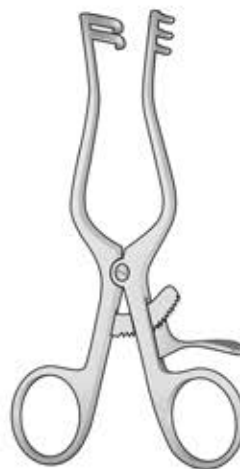

WEITLANER
BV-09
110 mm



1/1

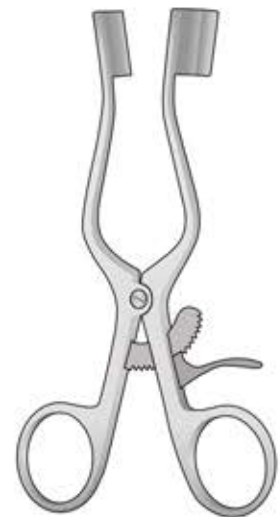

BABY-WEITLANER
BV-26
140 mm

Halbscharf - Sharp - Semi acuto
Agudas - Semi Pointu

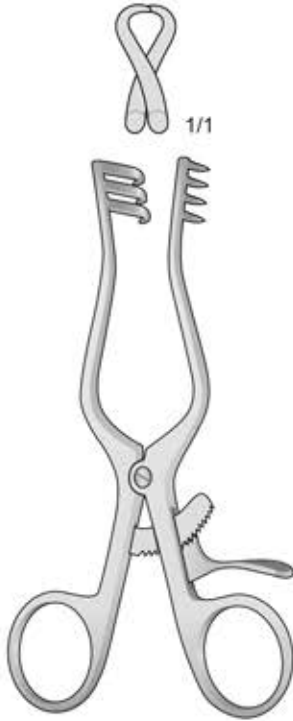

WEITLANER
BV-19
165 mm

Spitz - Sharp - Acuto
Agudas - Pointu

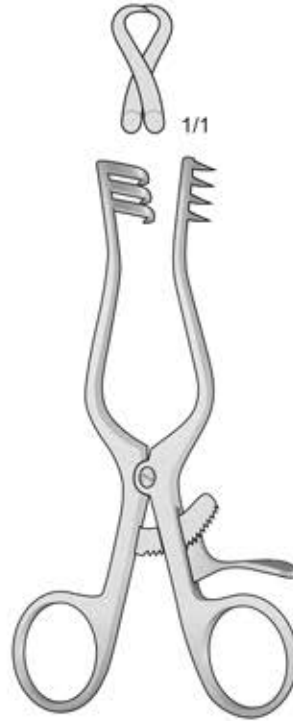

WEITLANER
BV-21
165 mm

Stumpf - Blunt - Smusso
Romas - Mousse

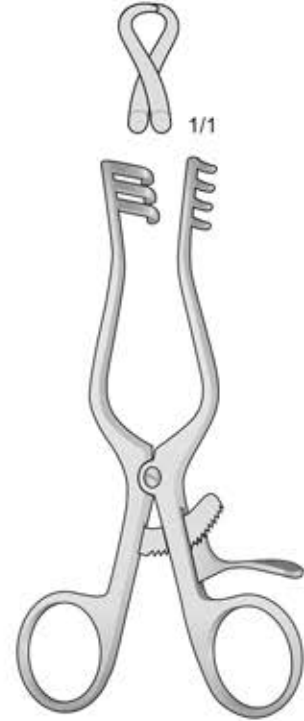

WEITLANER
BV-23
165 mm

Spitz - Sharp - Acuto
Agudas - Pointu

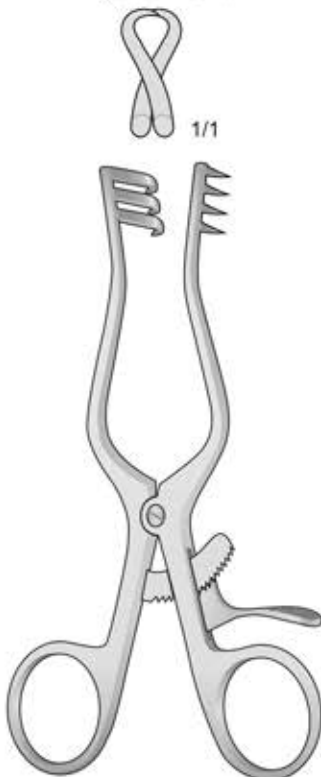

WEITLANER
BV-24
200 mm

Stumpf - Blunt - Smusso
Romas - Mousse

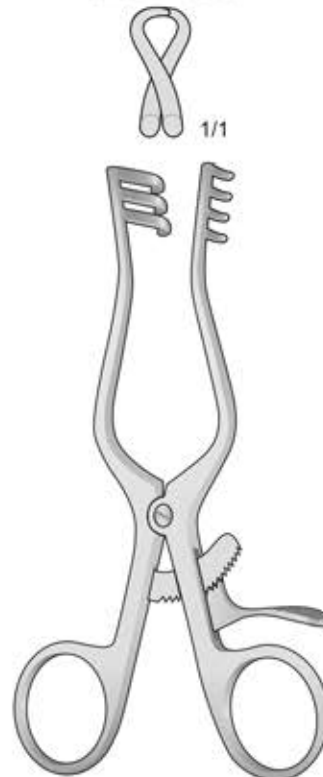

WEITLANER
BV-25
200 mm

Spitz - Sharp - Acuto
Agudas - Pointu

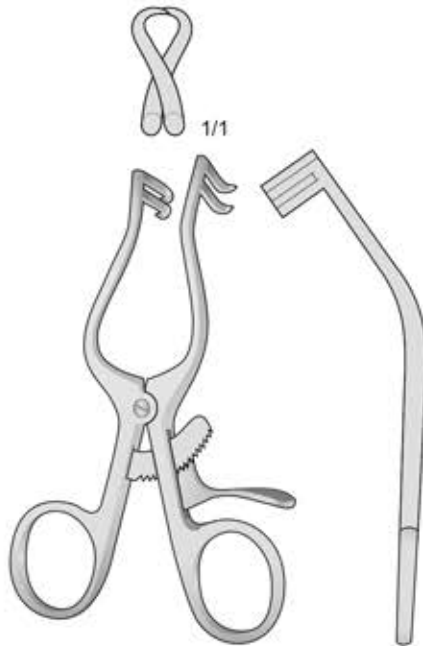

PLESTER
BV-90
110 mm

Stumpf - Blunt - Smusso
Romas - Mousse

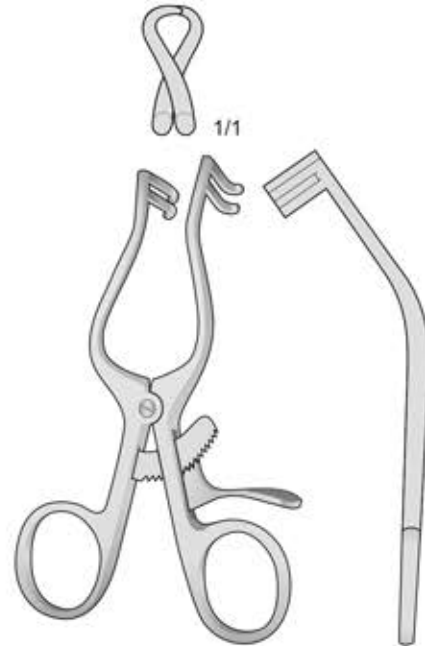

PLESTER
BV-91
110 mm

Spitz - Sharp - Acuto
Agudas - Pointu

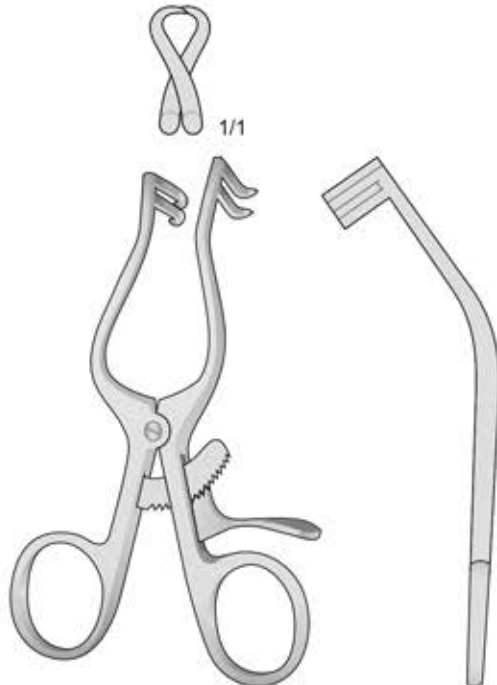

PLESTER
BV-92
135 mm

Stumpf - Blunt - Smusso
Romas - Mousse

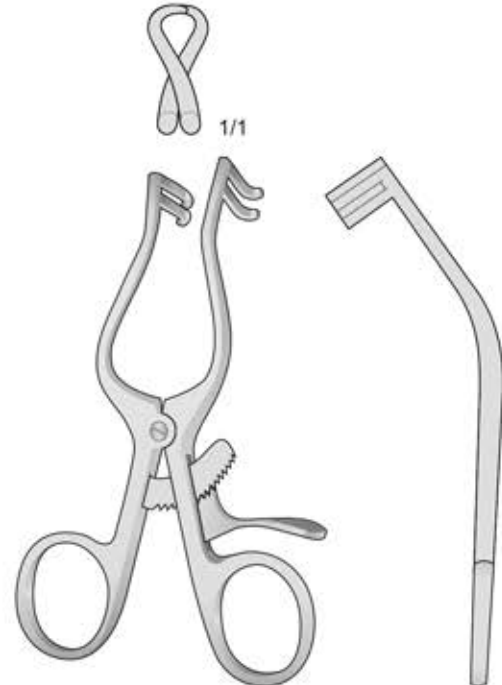

PLESTER
BV-93
135 mm

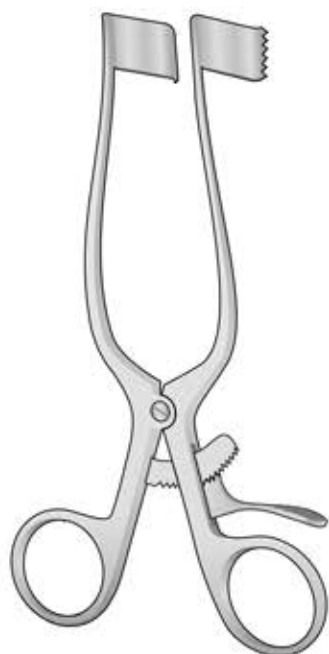

MEYERDING
BV-76 - 32 x 25 mm
BV-77 - 60 x 25 mm
BV-78 - 54 x 25 mm
BV-79 - 60 x 20 mm
 180 mm

Spitz - Sharp - Acuto
 Agudas - Pointu



BV-117

Stumpf - Blunt - Smusso
 Rome - Mousse



BV-118

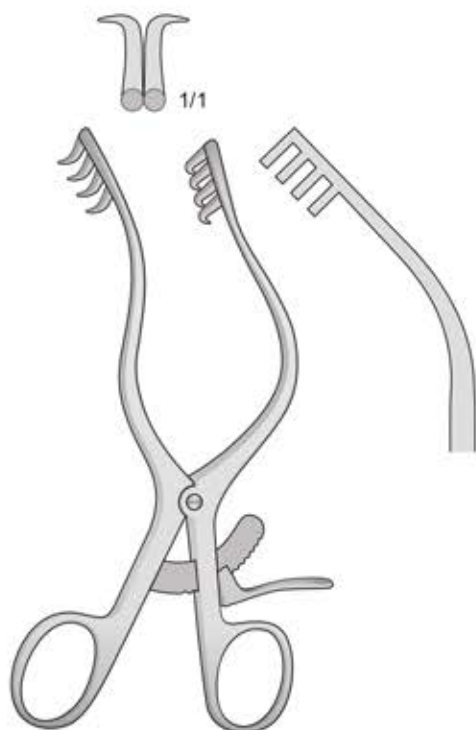

MOLLISON
BV-110
 160 mm



ANDERSON-ADSON
BV-117/BV-118
 200 mm

Spitz - Sharp - Acuto
Agudo - Pointu

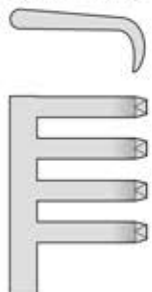

BV-119

Stumpf - Blunt - Smusso
Rome - Mousse

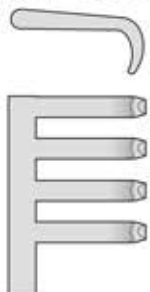

BV-120

4 x 4 Zähne
4 x 4 Teeth
4 x 4 Denti
4 x 4 Dientes
4 x 4 Dents

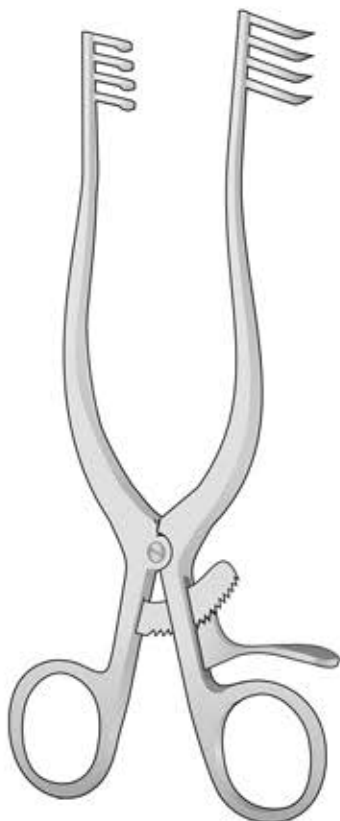

**ADSON
BV-119/BV-120
200 mm**

Spitz - Sharp - Acuto
Agudo - Pointu

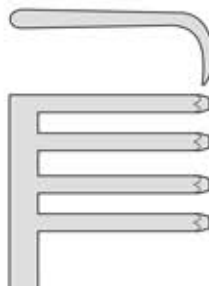

BV-27

Stumpf - Blunt - Smusso
Rome - Mousse

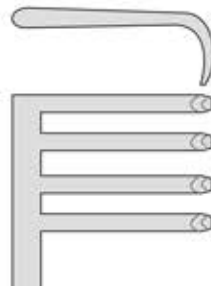

BV-28

4 x 4 Zähne
4 x 4 Teeth
4 x 4 Denti
4 x 4 Dientes
4 x 4 Dents

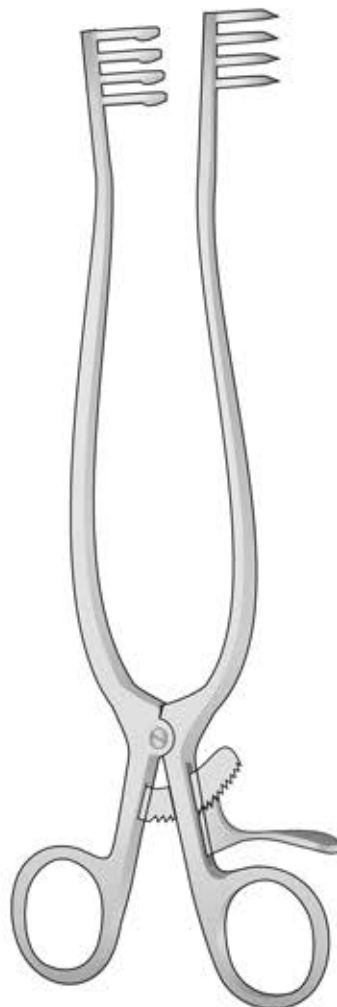

**WEITLANER
BV-27/BV-28
250 mm**

Spitz
Scharp
Acuto
Agudo
Pointu



BV-68
140 mm

Stumpf
Blunt
Smusso
Romas
Mousse

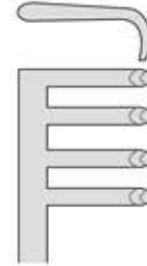

BV-70
140 mm

3 x 4 Zähne
3 x 4 Teeth
3 x 4 Denti
3 x 4 Dientes
3 x 4 Dents

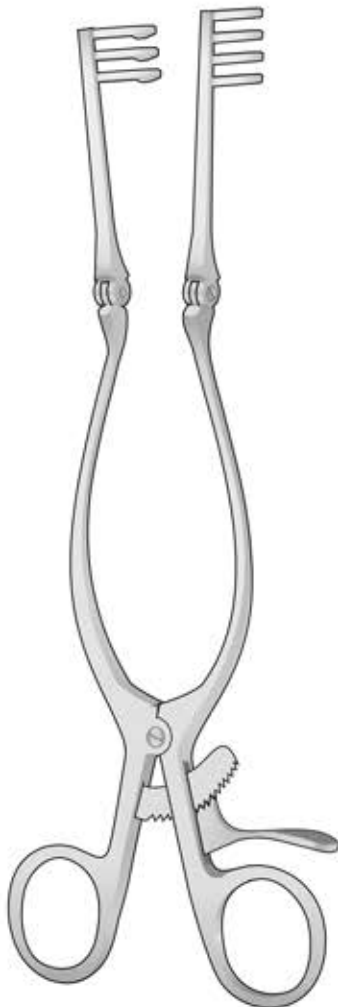

ADSON
BV-68/BV-75



BV-69
165 mm



BV-71
165 mm

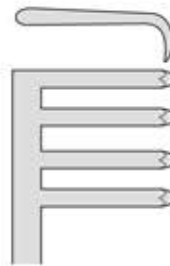

BV-72
200 mm

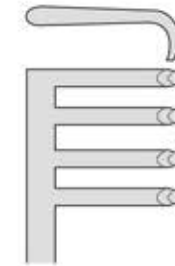

BV-73
200 mm

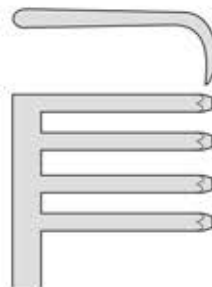

BV-74
250 mm

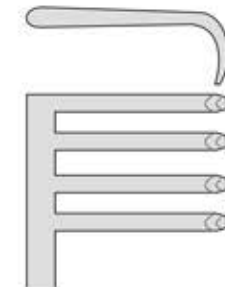

BV-75
250 mm

Spreizer allein
 Retractor without blades
 Solo divaricatore senza valva
 Separador sin valvas
 Ecarteur sans valves

Spitz
 Scharp
 Acuto
 Agudo
 Pointu

Stumpf
 Blunt
 Smusso
 Romas
 Mousse

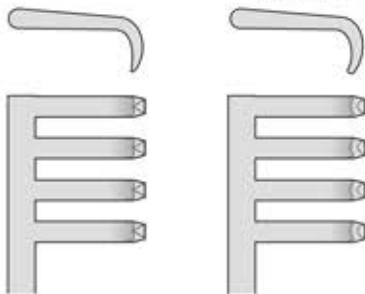

BV-135

BV-136

3 x 4 Zähne
 3 x 4 Teeth
 3 x 4 Denti
 3 x 4 Dientes
 3 x 4 Dents

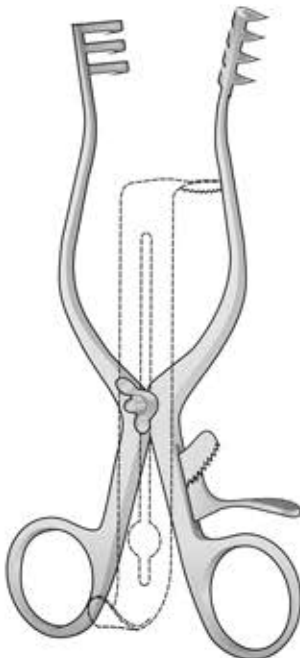

HENLEY
BV-135/BV-136
 165 mm

Mittelblatt
 Center blades
 Valve centrali
 Valvas centrales
 Valves centrale

Fig. 1



BV-137
 16x19 mm

Fig. 2

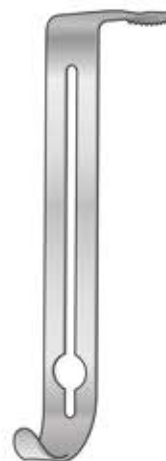

BV-138
 16x25 mm

Fig. 3

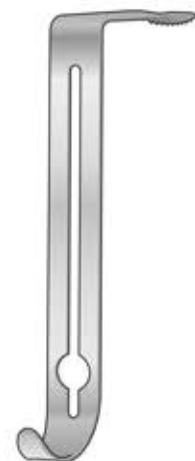

BV-139
 16x32 mm

CLOWARD Modif.
BV-319
 Sperrer, allein
 Retractor, only
 Divaricatore, solo
 Separador, suelto
 Ecarteur, seul

CLOWARD Modif.
BV-317
 Sperrer, allein
 Retractor, only
 Divaricatore, solo
 Separador, suelto
 Ecarteur, seul



BV-321

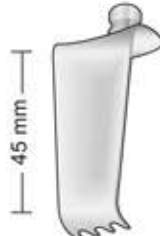

BV-322

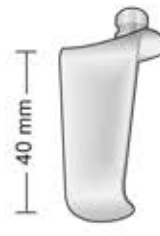

BV-326

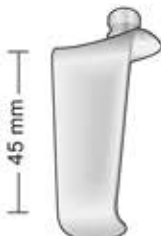

BV-327

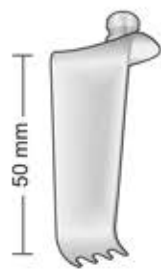

BV-323



BV-324

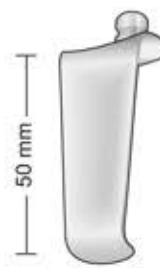

BV-328



BV-329

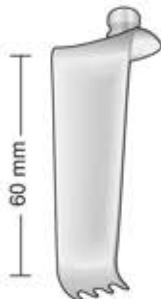

BV-325

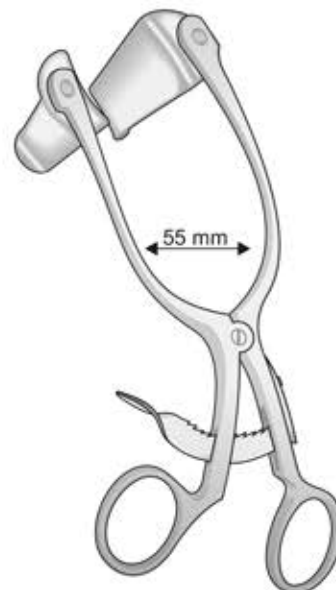

**CLOWARD
 BV-318
 160 mm**

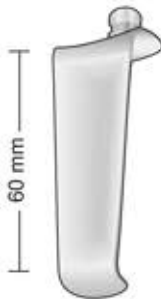

BV-330

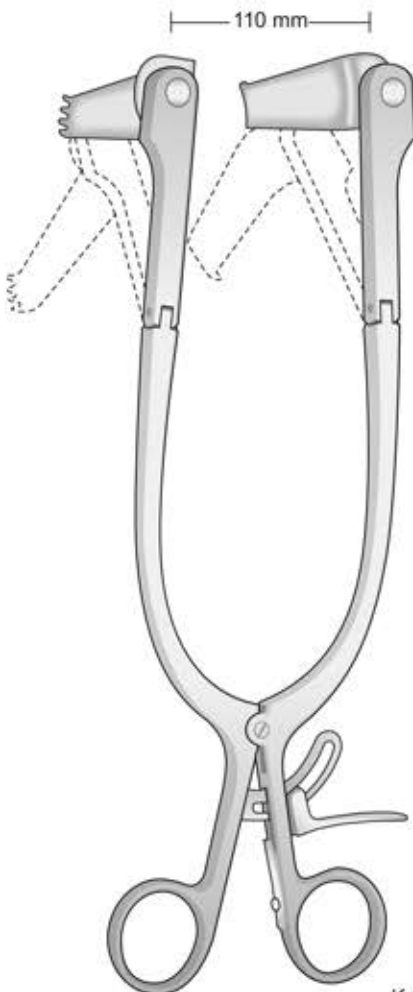

**CLOWARD modif.
 BV-320
 250 mm**

Komplett mit 5 Valven
 Complete with 5 blades
 Completo di 5 valve
 Completo con 5 valvas
 Complet avec 5 valves

Komplett mit 5 Valven
 Complete with 5 blades
 Completo di 5 valve
 Completo con 5 valvas
 Complet avec 5 valves

BV-141

Komplett mit 1 Paar Valven
 Complete with 1 pairs of blades
 Completo con un paio di valve
 Completos con 1 pares de valvas
 Complete avec 1 paires de valves

BV-146

Komplett mit 2 paar valven
 Complete with 2 pairs of blades
 Completo con due paia di valve
 Completos con 2 pares de valvas
 Complete avec 2 paires de valves

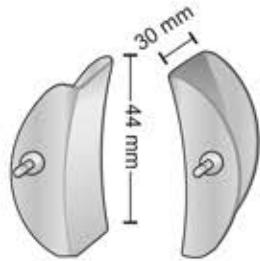

BV-142 20x44 mm

BV-143 30x44 mm

Seitl. Blätter - paar
 Lateral blades - pairs
 Valve laterali - paia
 Valvas laterales - pares
 Valves latérales - paires

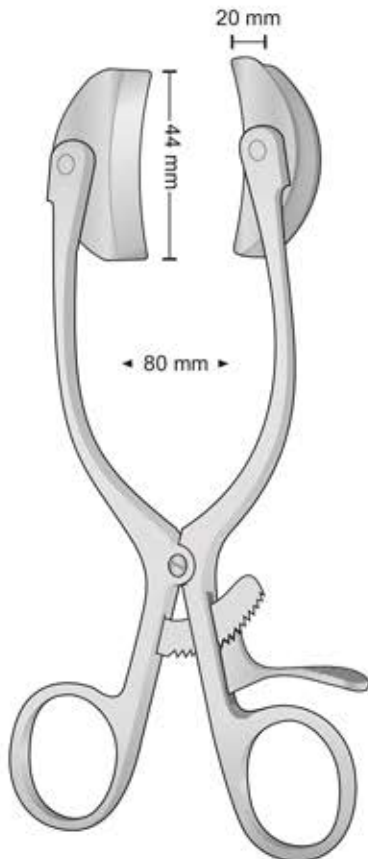

BABY-COLLIN
BV-141
 180 mm

BV-145

Komplett mit 1 Paar Valven
 Complete with 1 pairs of blades
 Completo con un paio di valve
 Completos con 1 pares de valvas
 Complete avec 1 paires de valves

BV-148

Sperrer allein
 Retractor only
 Divaricatore solo
 Separador suelto
 Ecarteur seul

BV-372

32x62 mm
 Seitl.blätter - paar
 Lateral blades - pairs
 Valve laterali - paia
 Valvas laterales - pares
 Valves latérales - paires

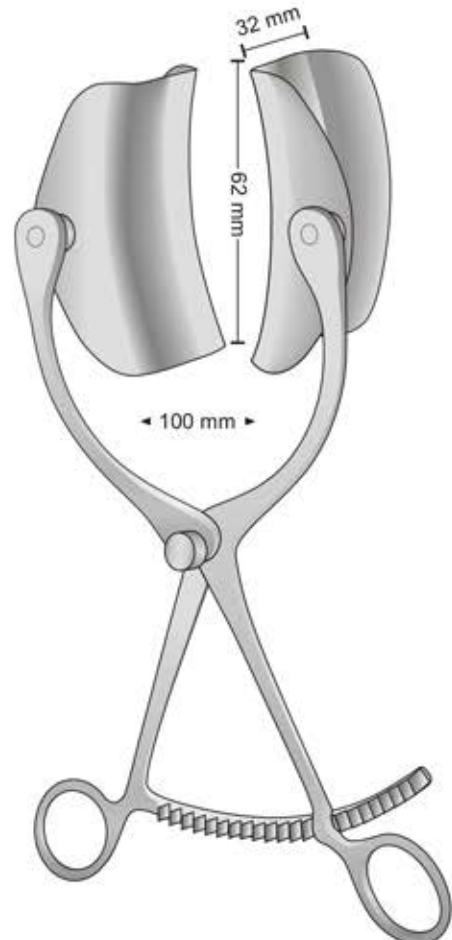

COLLIN
BV-145
 220 mm

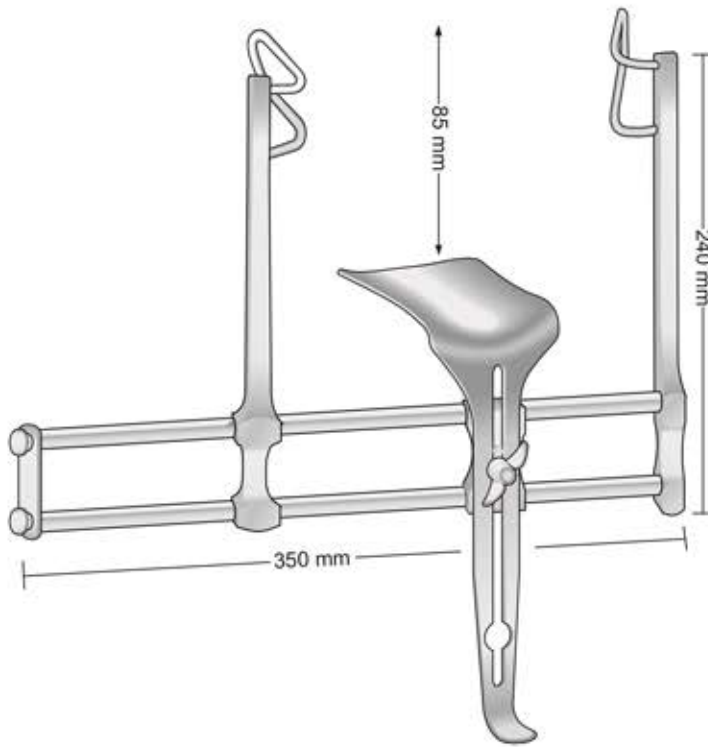

BALFOUR MODIF.
BV-46

45 X 85 mm



BV-150
170 mm

75 X 65 mm



BV-151
230 mm

70 X 100 mm



BV-152
200 mm

Schraubendreher
Screw Driver



CASPAR
FF-206
200 mm

Spezialbohrer
Special Drill
Ø 1,7 mm



CASPAR
FF-203
145 mm

Distraktionsschrauben
Distraction Screw



CASPAR
FF-205
70 mm

- | | |
|---------------------------------|---|
| CASPAR | |
| FF-200M | |
| Distraktor Lang komplett | |
| Distractor Long complete | |
| Distrattore modificato completo | |
| FF-201M | 1 Distraktor Lang allein - 1 Distractor Long only |
| FF-202 | 1 Bohrbüchse - 1 Drilling Guide |
| FF-203 | 1 Spezialbohrer - 1 Special Drill |
| FF-205 | 2 Distraktionsschrauben - 2 Distraction Screws |
| FF-206 | 1 Schraubendreher - 1 Screw Driver |

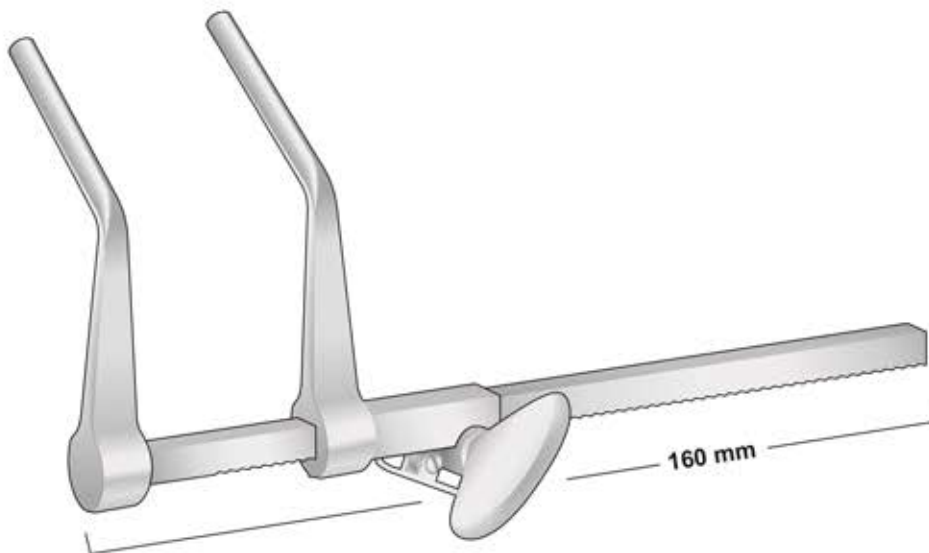

CASPAR
FF-201M
Distraktor Lang Allein
Distractor Long only
Distrattore modificato solo

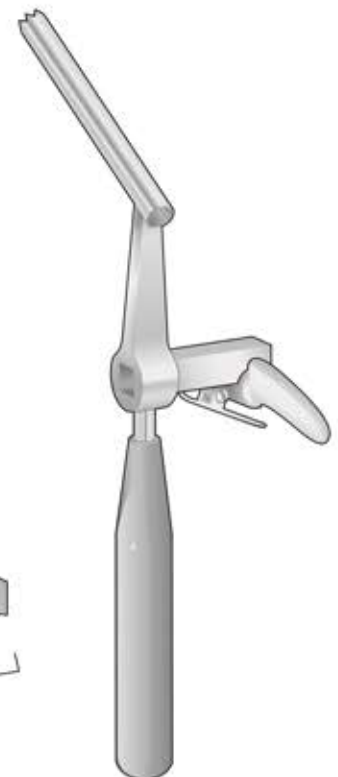

FF-202
Bohrbüchse Allein
Drilling Guide only
Guida punta solo

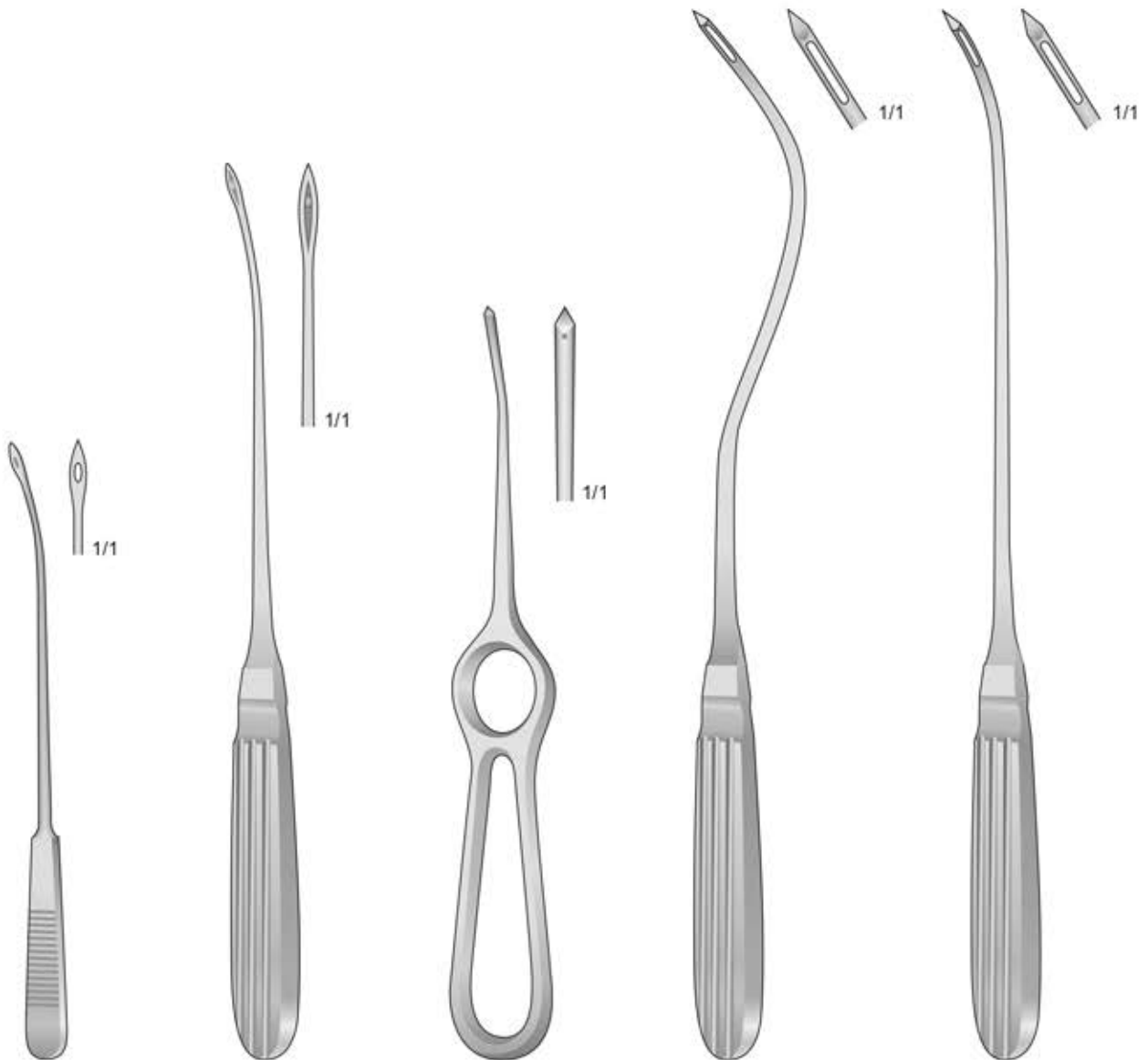

OBWEGESER
DO-30
140 mm

OBWEGESER
DO-31
230 mm

DO-32
180 mm

SANDERS-BROWN
DO-44
290 mm

SANDERS-BROWN
DO-49
300 mm

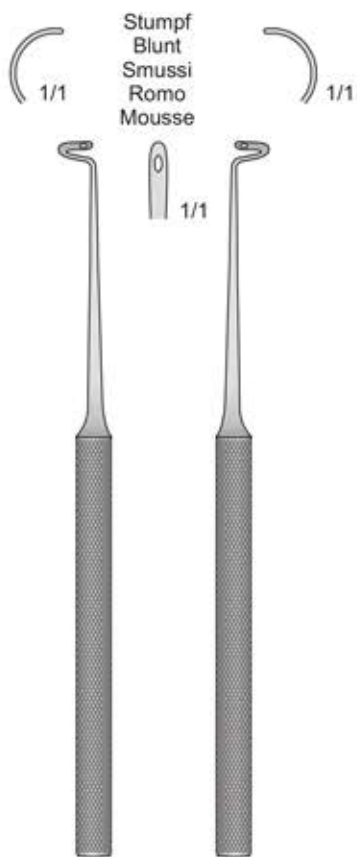

KRONECKER KRONECKER
BM-15 **BM-16**
130 mm 130 mm

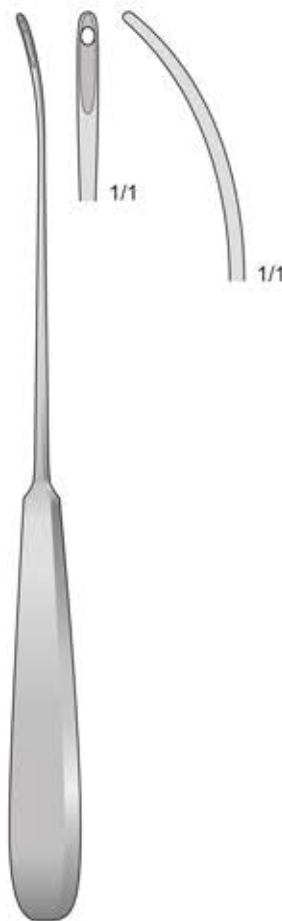

BM-74
230 mm

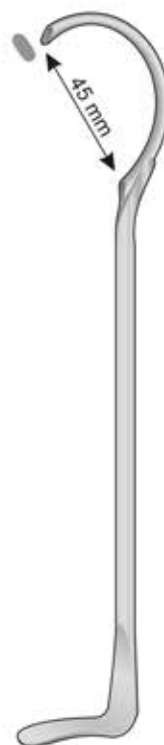

BM-50
185 mm



BM-51
235 mm

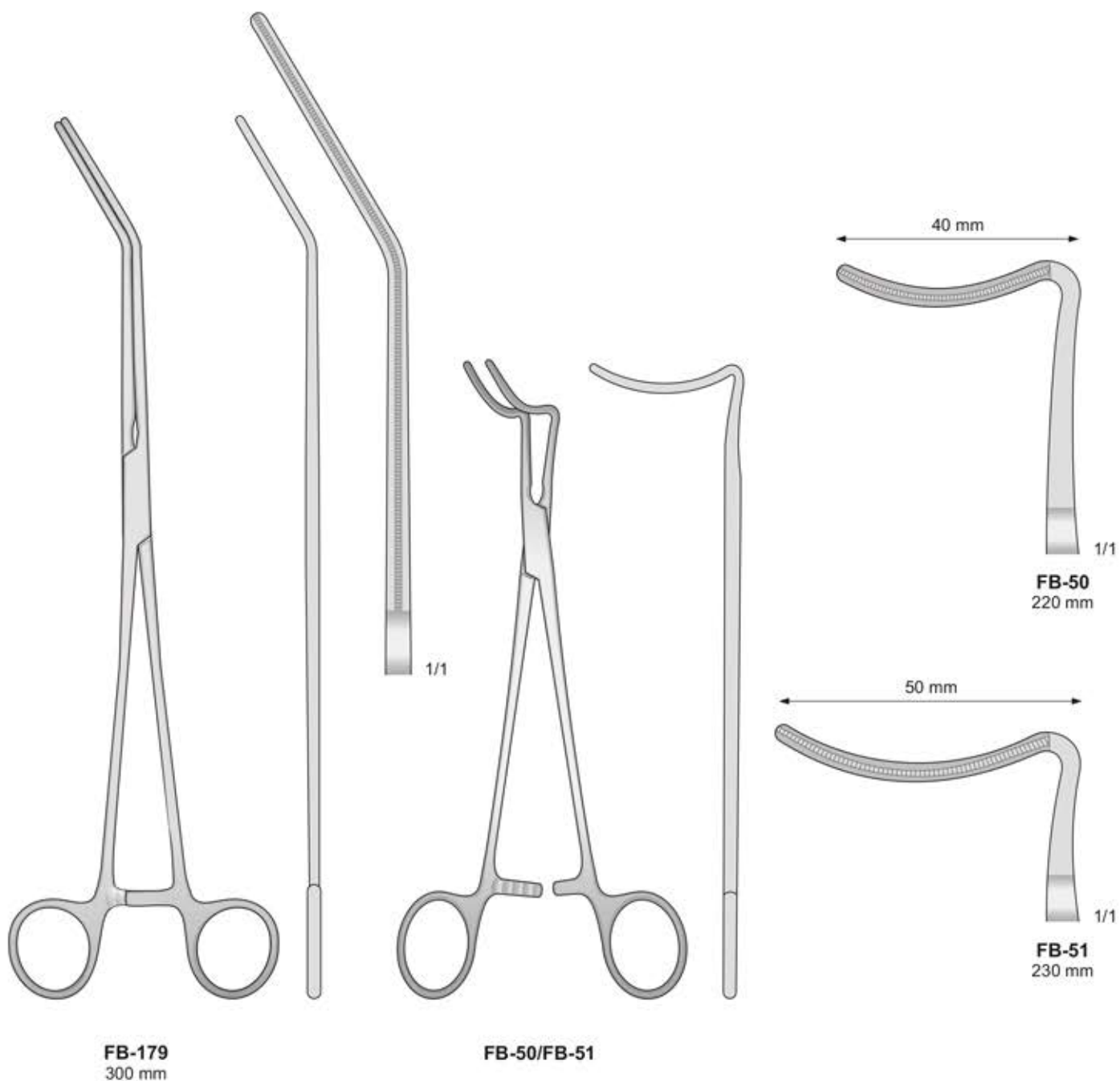

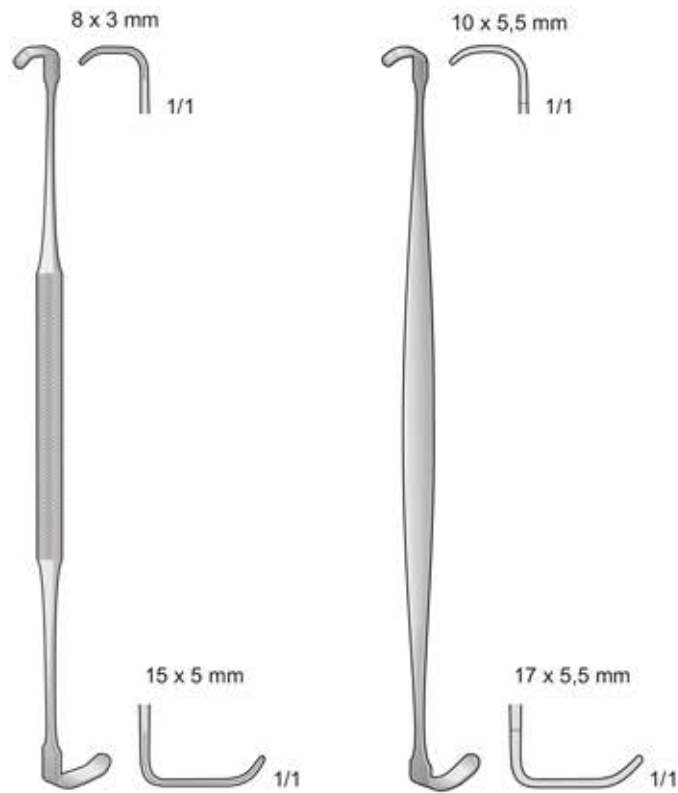

**RAGNELL
BT-27**
140 mm

**RAGNELL-DAVIS
BT-26**
140 mm



**HOWARTH
KO-30**
210 mm



**MC DONALD
KO-38**
190 mm



**MCKENTY
KO-46**
220 mm

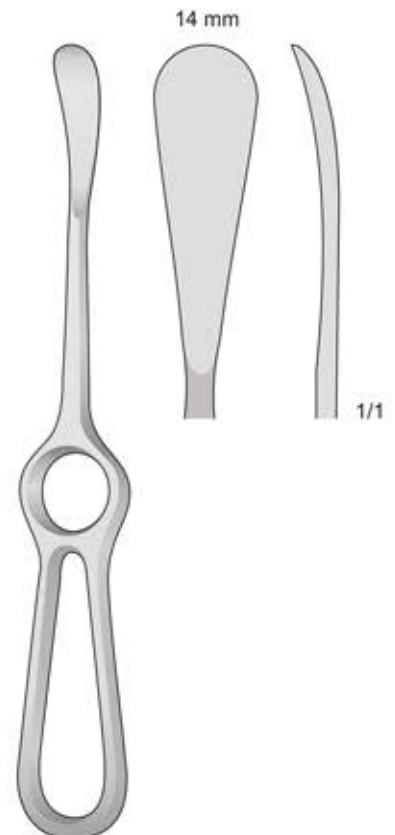

**SEDILLOT
BT-37**
210 mm

15 mm

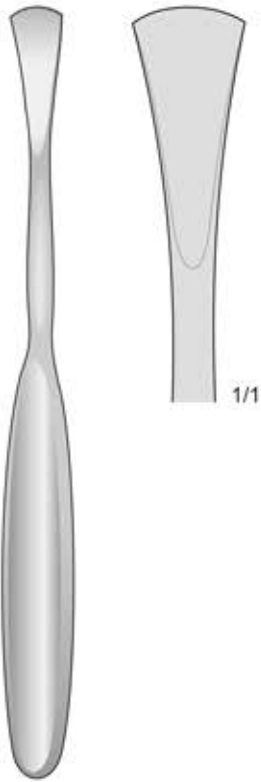

1/1

CUSHING
FK-252
190 mm

8 mm



FK-260

1/1

7 mm



FK-261

1/1

7 mm



FK-262

1/1

7 mm



FK-263

1/1



ADSON
FK-260/FK-263
170 mm

2,5 mm

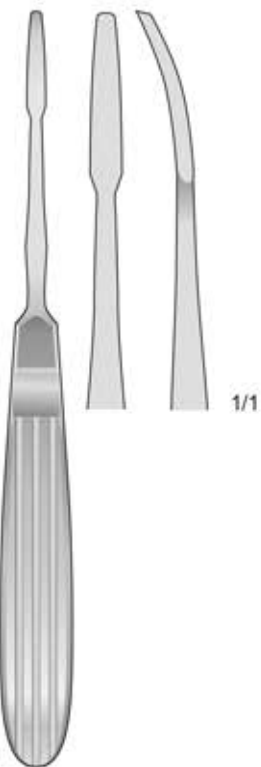

1/1

JOSEPH
FK-80
170 mm

7 mm

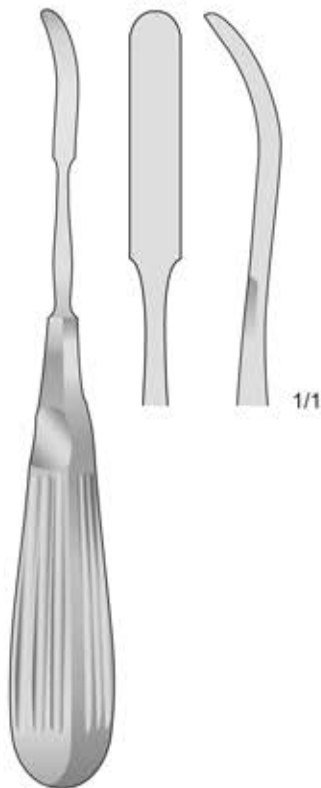

1/1

JOSEPH
FK-82
180 mm

10 mm



MOLT
MO-15
160 mm



HENAHAN
BT-05/BT-07
175 mm

10 mm



BT-05

1/1

12 mm



BT-06

1/1

15 mm



BT-07

1/1

1/1

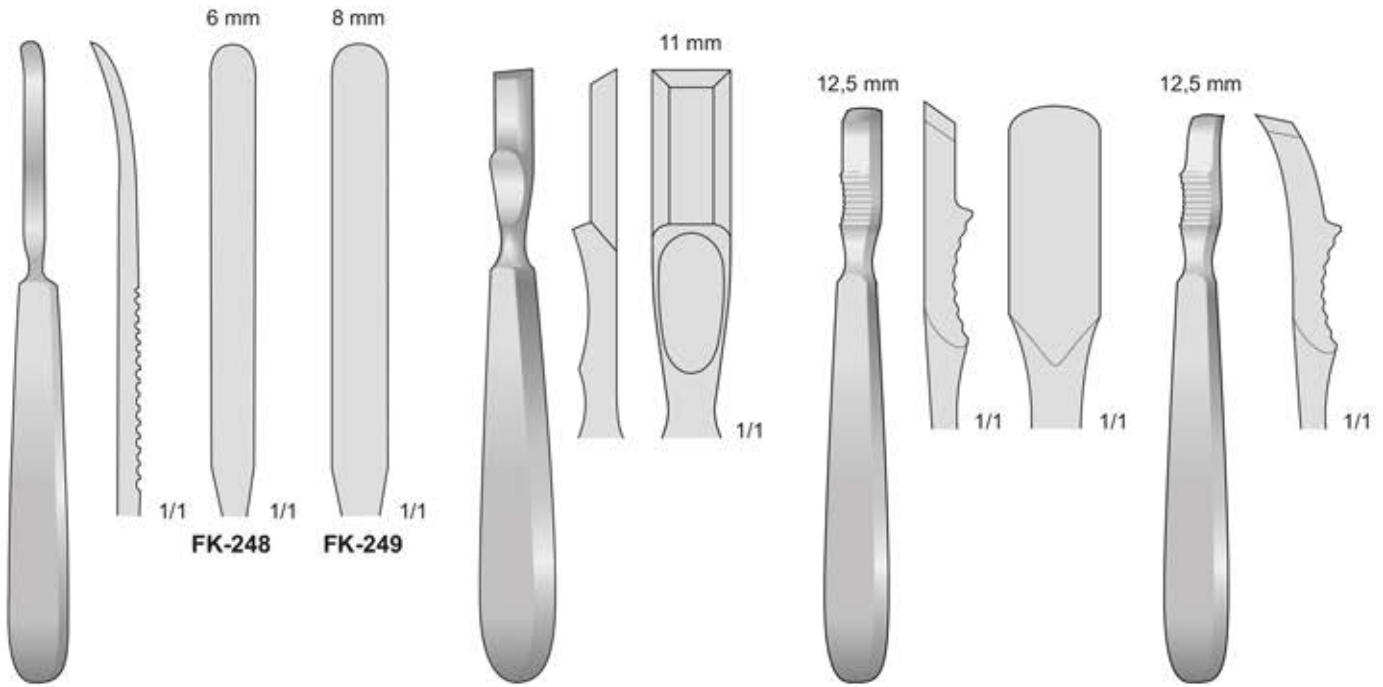

FK-248/FK-249
170 mm

**FARABEUF-COLLIN
FK-247**
160 mm

**FARABEUF
FK-250**
150 mm

**FARABEUF
FK-251**
150 mm

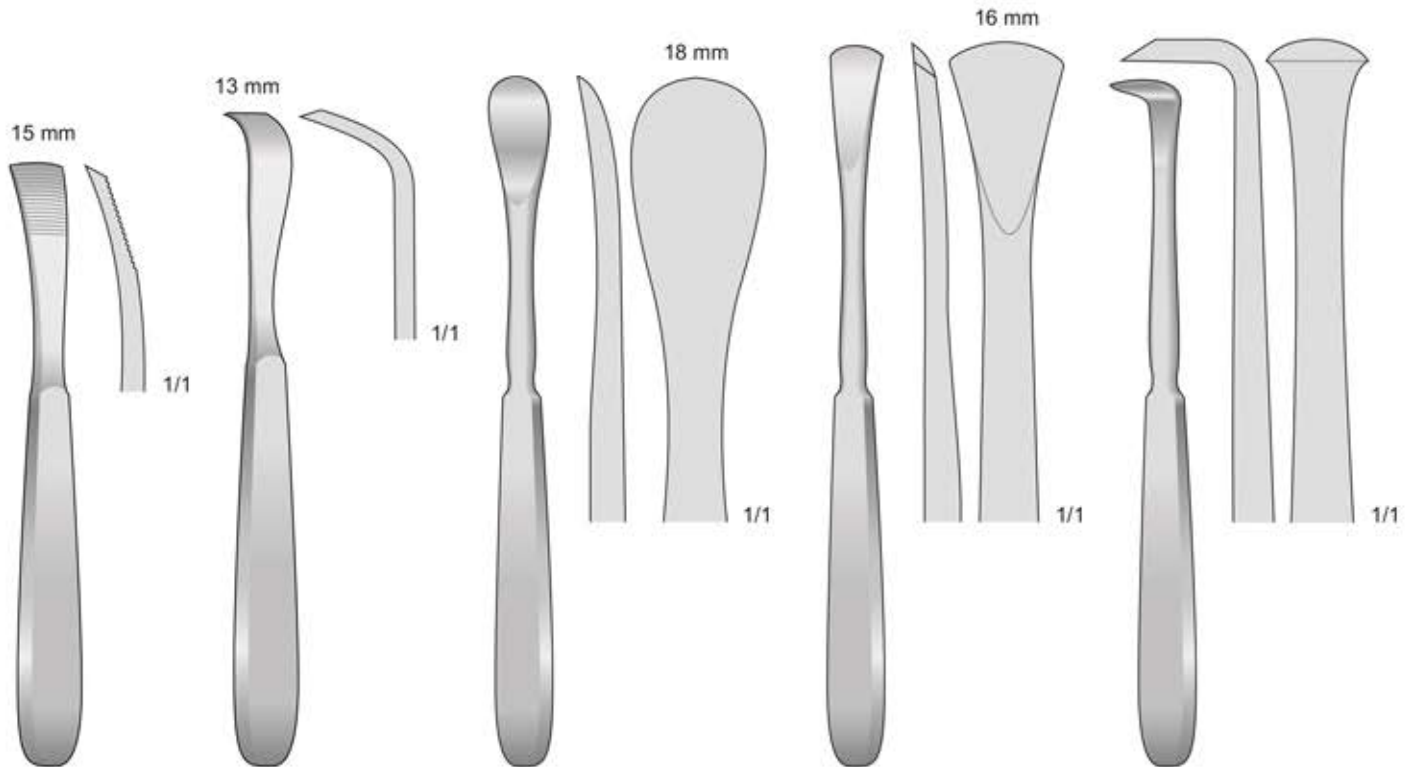

**JANSEN
FK-255**
165 mm

**SCHNEIDER
FK-258**
175 mm

**SEDILLOT
FK-254**
185 mm

**LANGENBECK
FK-256**
190 mm

**LANGENBECK
FK-257**
180 mm

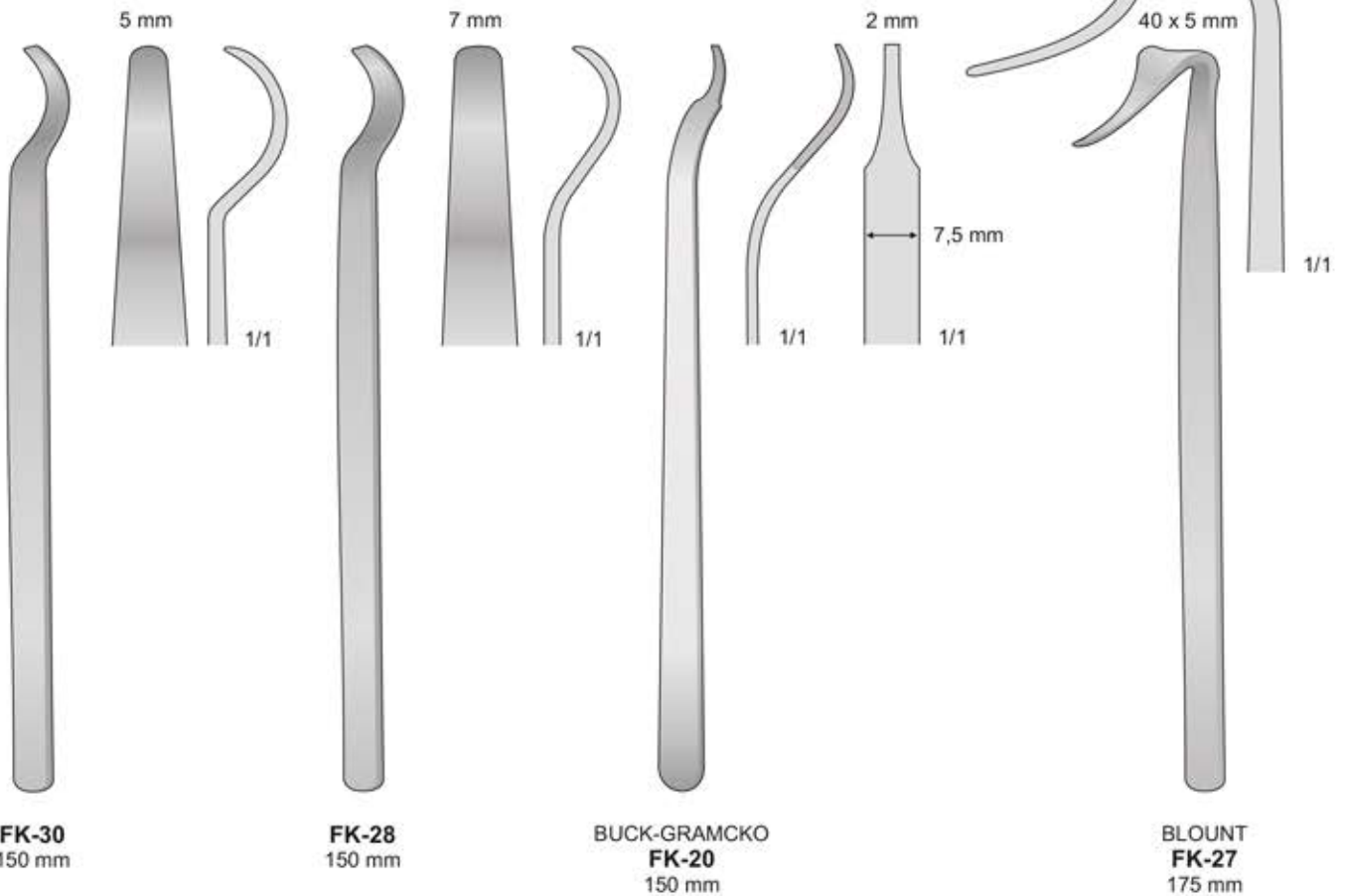

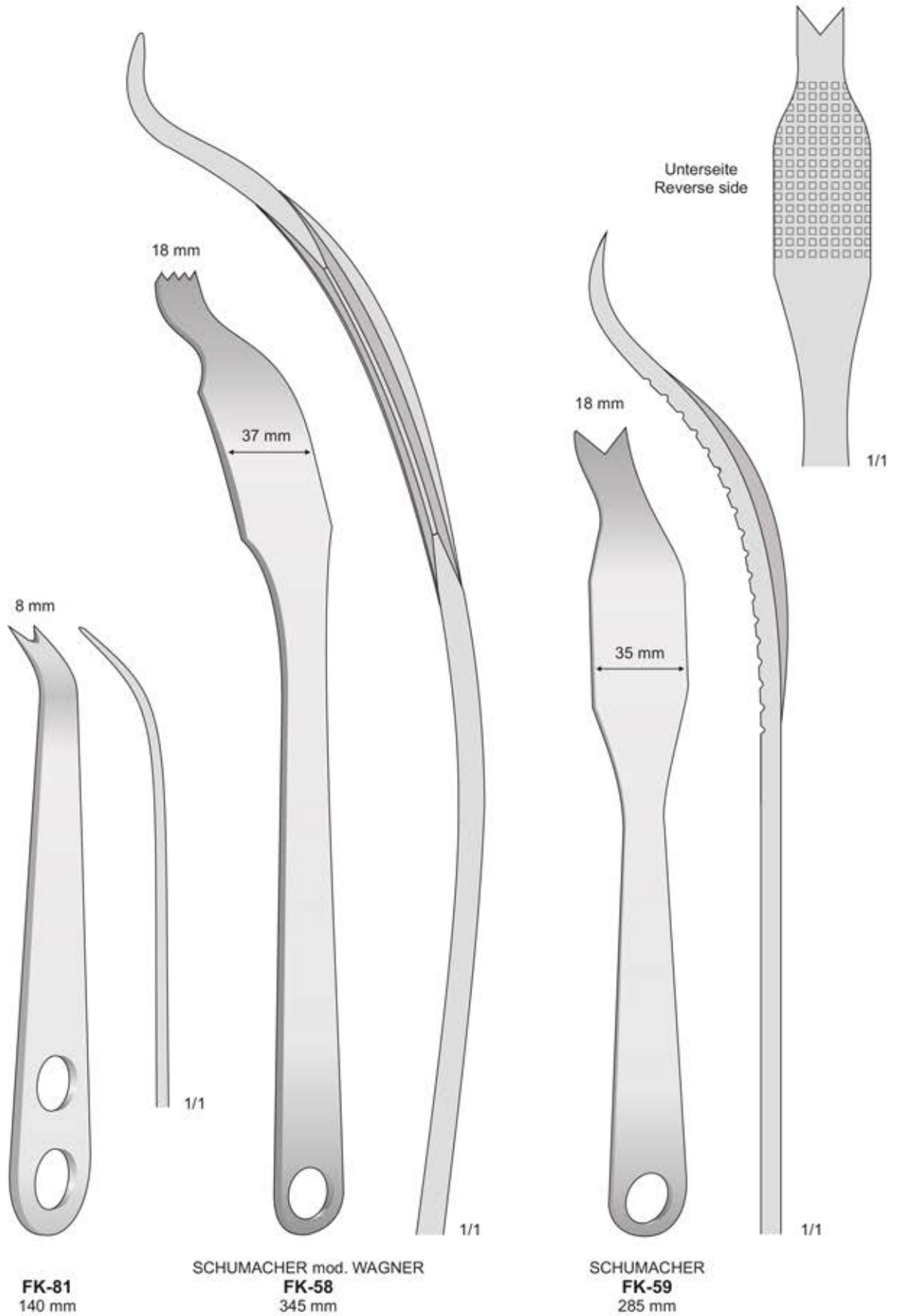

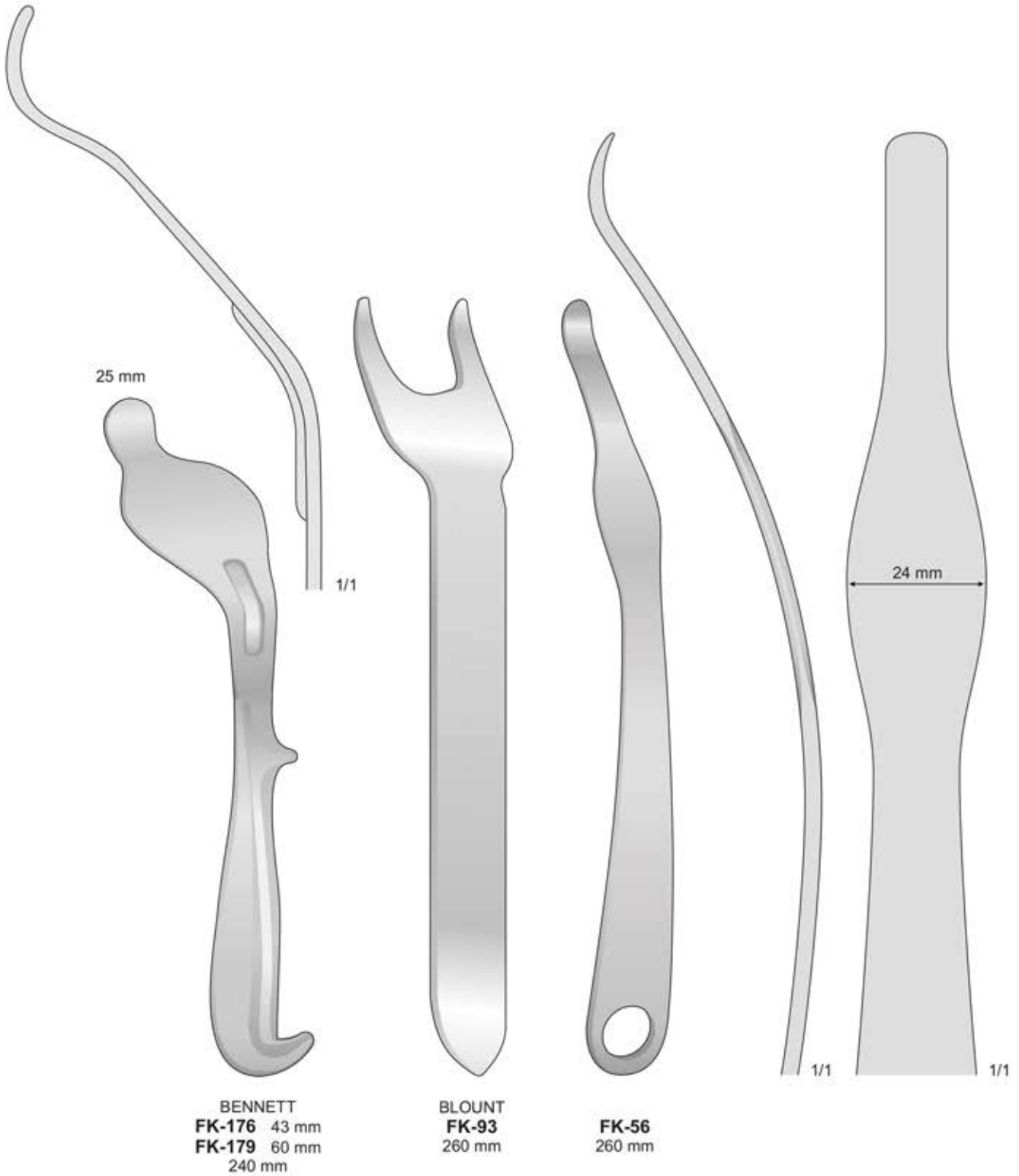

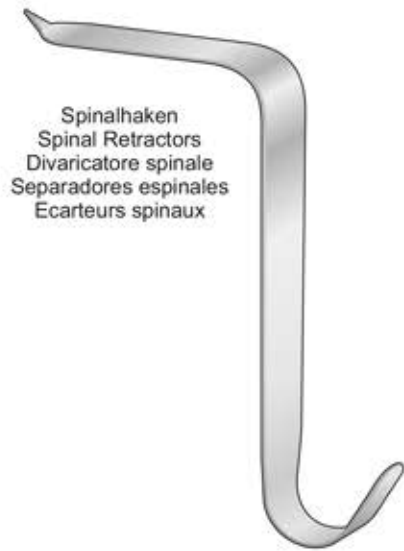

Spinalhaken
Spinal Retractors
Divaricatore spinale
Separadores espinales
Ecarteurs spinaux

TAYLOR
FK-168 75 x 30 mm
FK-169 100 x 30 mm
165 mm

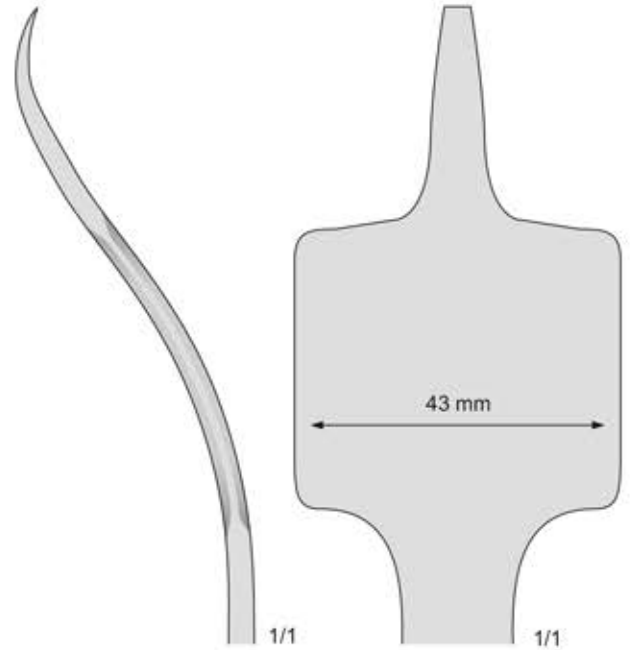

FK-57
240 mm

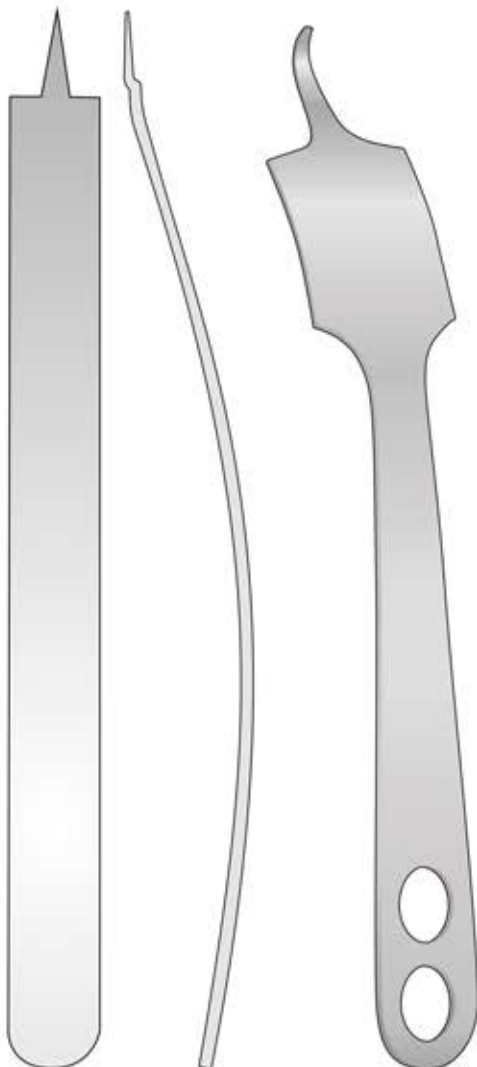

FK-164
250 mm

HOHMANN
FK-47/FK-57
240 mm

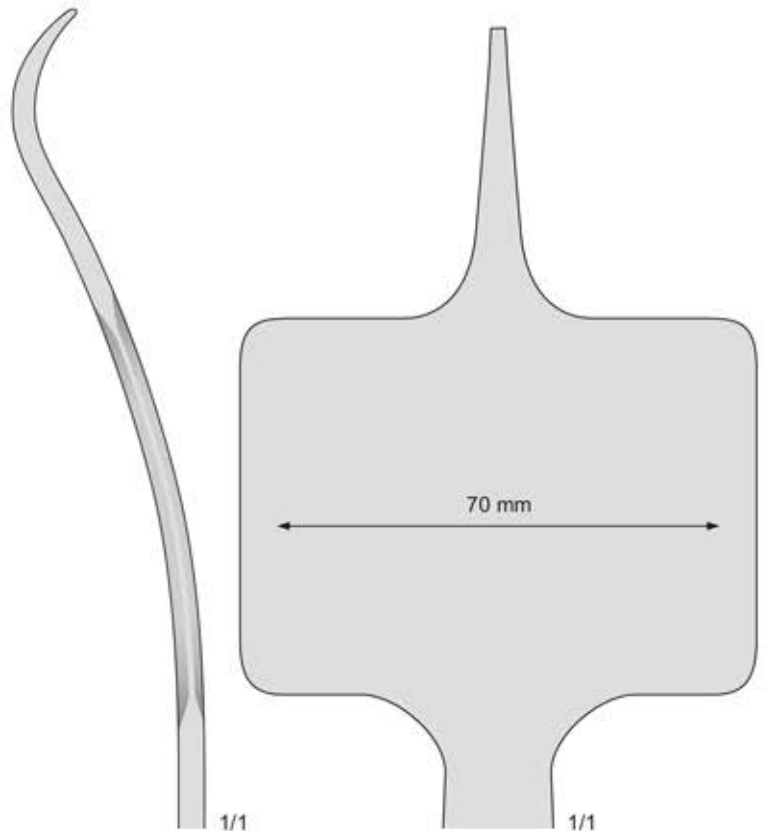

FK-47
240 mm

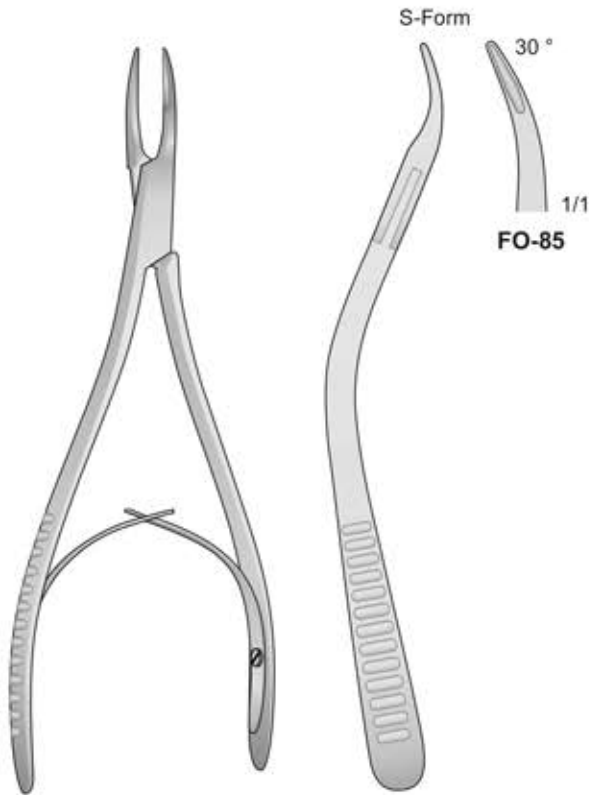

MINI-FRIEDMANN
FO-85
150 mm

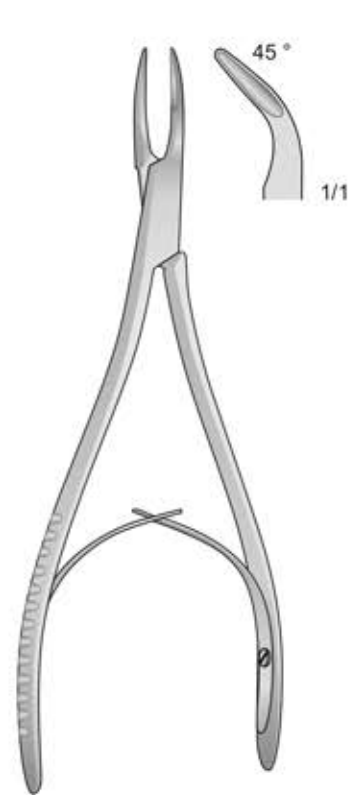

MINI-FRIEDMANN
FO-220
150 mm

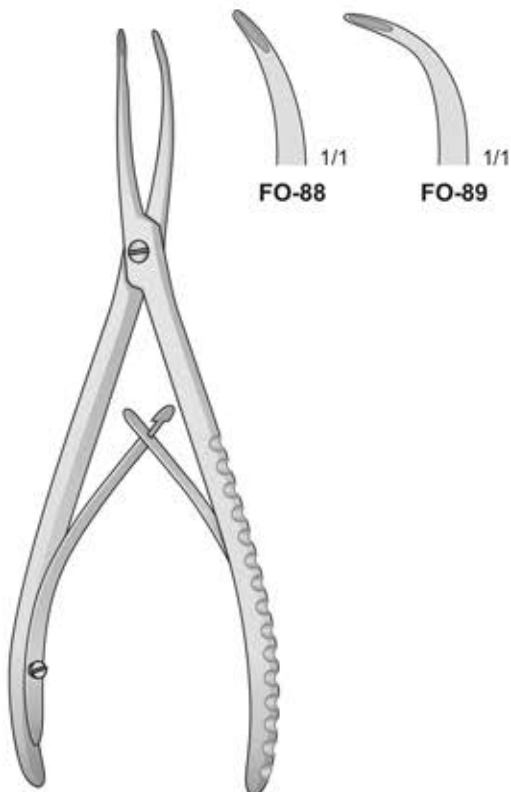

STELLBRINK
FO-88/FO-89
170 mm

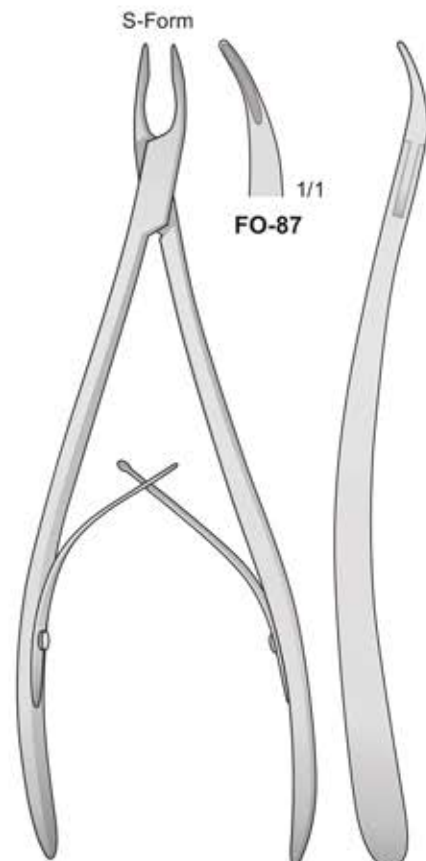

STELLBRINK
FO-87
190 mm

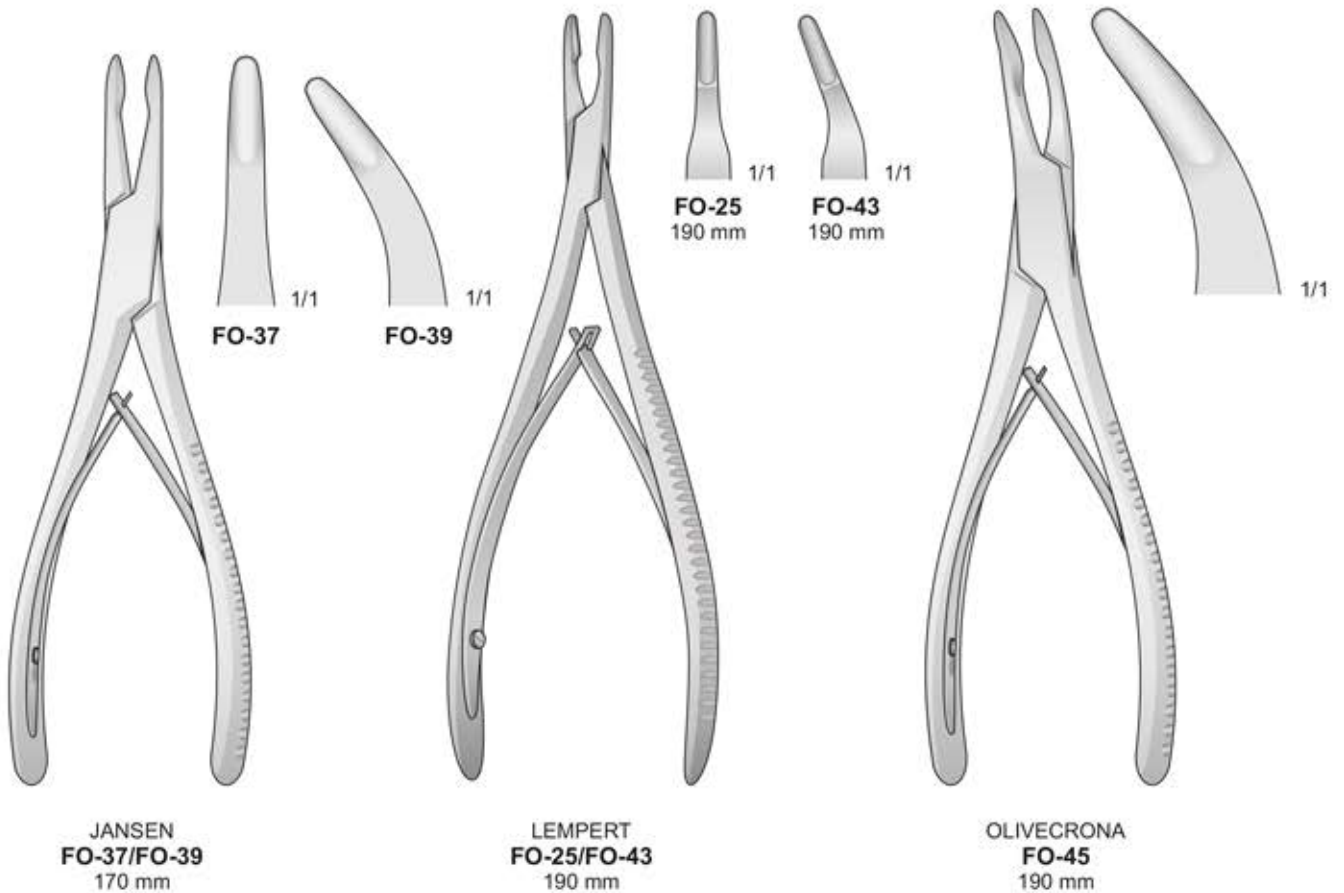

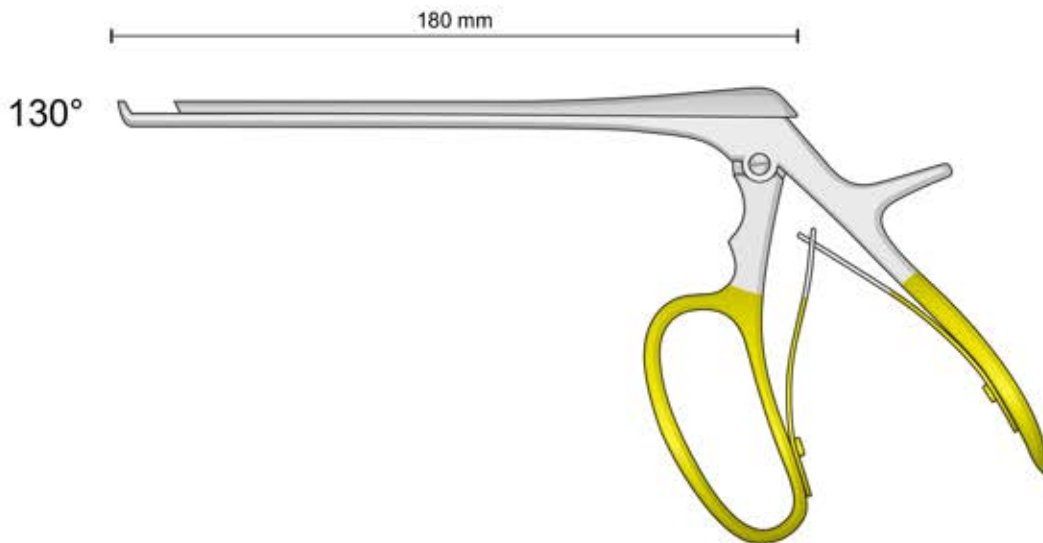
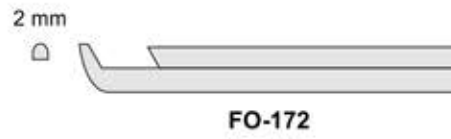

FERRIS - SMITH - KERRISON
FO-171/FO-175

Gerade
Stright
Diritta
Rectas
Droites

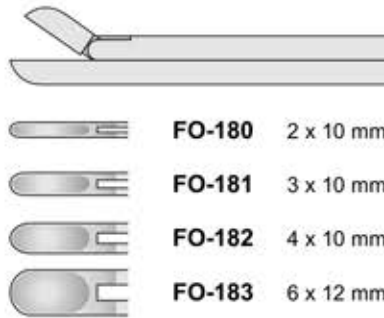

Aufwärtsgebogen
Top curved
Curva verso l'alto
Curvos
Courbe vers le haut

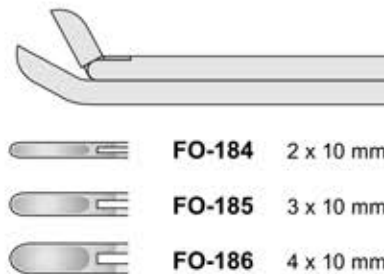

Abwärts gebogen
Bottom curved
Curva verso il basso
Curvos
Courbe vers le bas

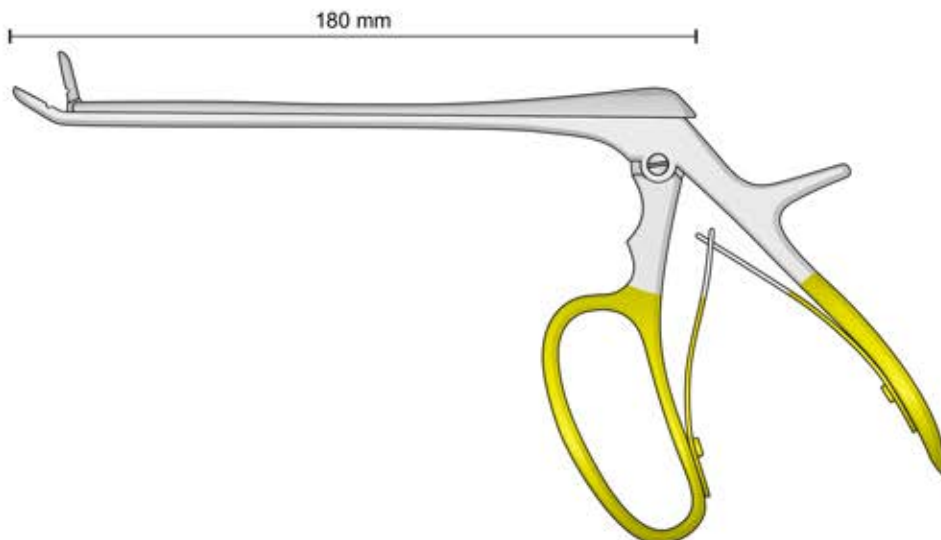
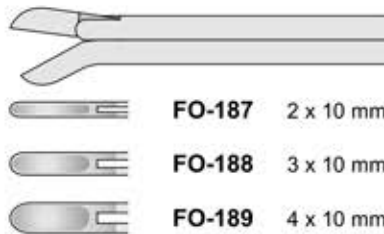

FERRIS - SMITH - CUSHING
FO-180/FO-189

Gerade
Stright
Diritta
Rectas
Droites

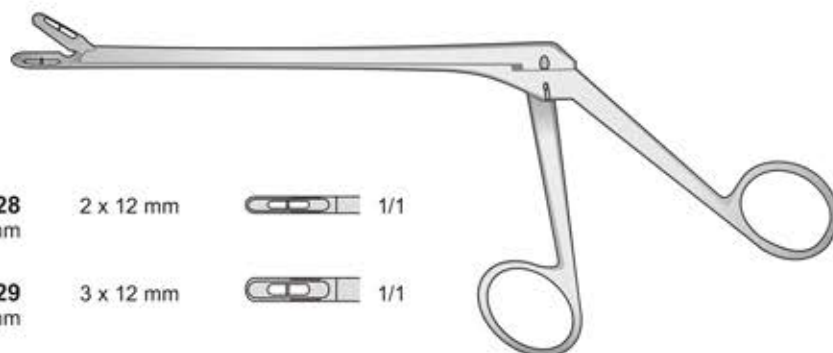

CASPAR

FF-120 140 mm	FF-123 160 mm	FF-128 185 mm	2 x 12 mm		1/1
FF-121 140 mm	FF-124 160 mm	FF-129 185 mm	3 x 12 mm		1/1
FF-122 140 mm	FF-125 160 mm	FF-130 185 mm	4 x 14 mm		1/1
	FF-126 160 mm	FF-131 185 mm	5 x 14 mm		1/1
	FF-127 160 mm	FF-132 185 mm	6 x 16 mm		1/1

CASPAR
FF-120/FF-132

Aufwärtsgebogen
Top curved
Curva verso l'alto
Curvos
Courbe vers le haut

150°

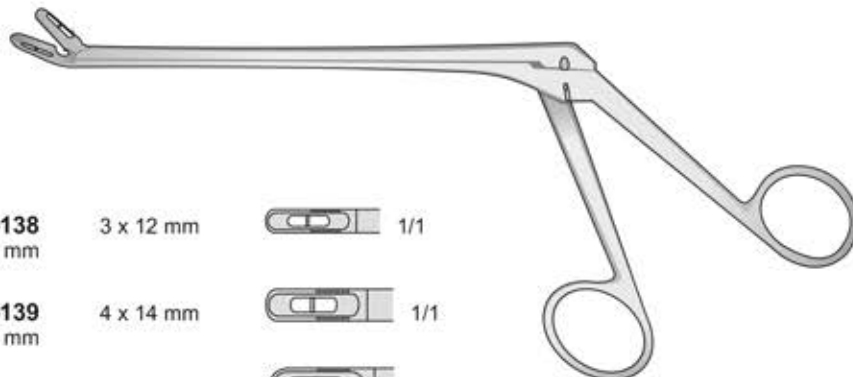

CASPAR

FF-133 140 mm	FF-135 160 mm	FF-138 185 mm	3 x 12 mm		1/1
FF-134 140 mm	FF-136 160 mm	FF-139 185 mm	4 x 14 mm		1/1
	FF-137 160 mm	FF-140 185 mm	5 x 14 mm		1/1

CASPAR
FF-133/FF-140

Abwärts gebogen
Bottom curved
Curva verso il basso
Curvos
Courbe vers le bas

150°

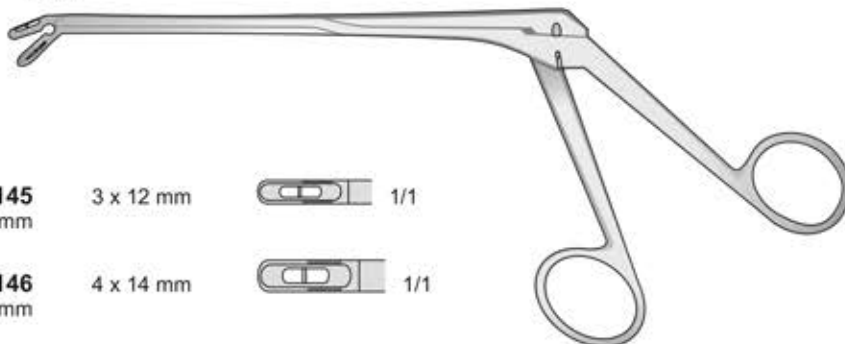

CASPAR

FF-141 140 mm	FF-143 160 mm	FF-145 185 mm	3 x 12 mm		1/1
FF-142 140 mm	FF-144 160 mm	FF-146 185 mm	4 x 14 mm		1/1

CASPAR
FF-141/FF-146

Meniskus und Knorpelfasszangen - Meniscus and cartilage clamp
Pinze per menisco e cartilagine - Pincers à saisir ménisque et cartilages

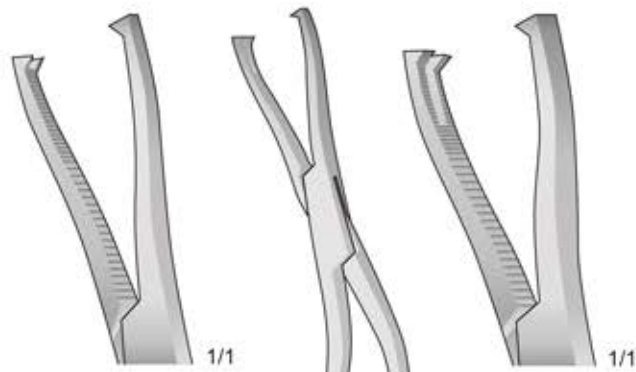

DINGMANN
FO-130

DINGMANN MODIF.
FO-131

DINGMANN
FO-130/FO-131
190 mm

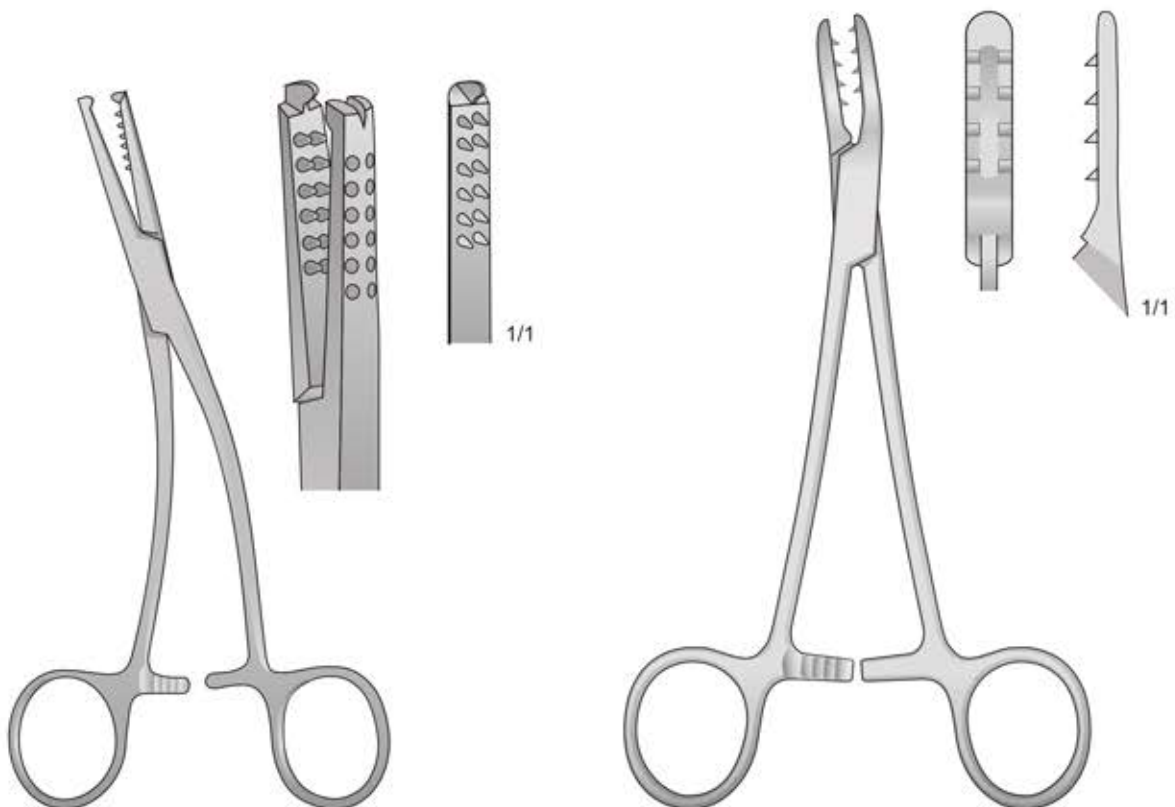

FO-134
185 mm

MARTIN
FO-133
200 mm

Repositionszangen - Reposition forceps
Pinze riposizionatrici di osso - Pinzas para la reducción de huesos

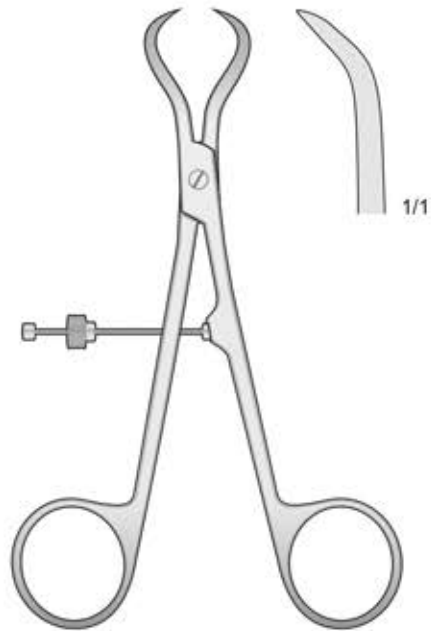

FO-79
140 mm

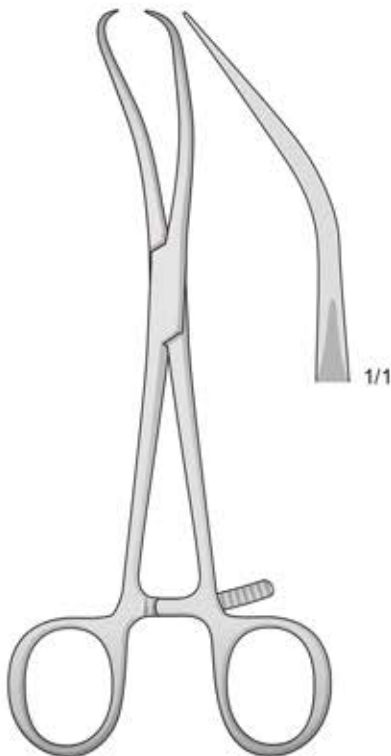

REILL
FO-64
170 mm

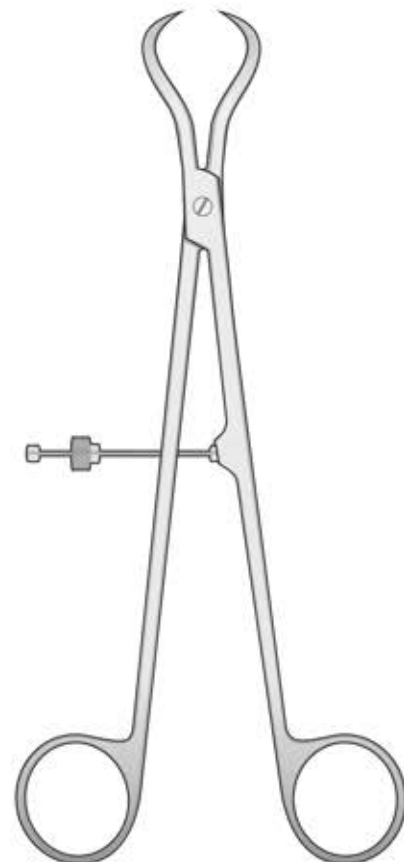

FO-81
210 mm

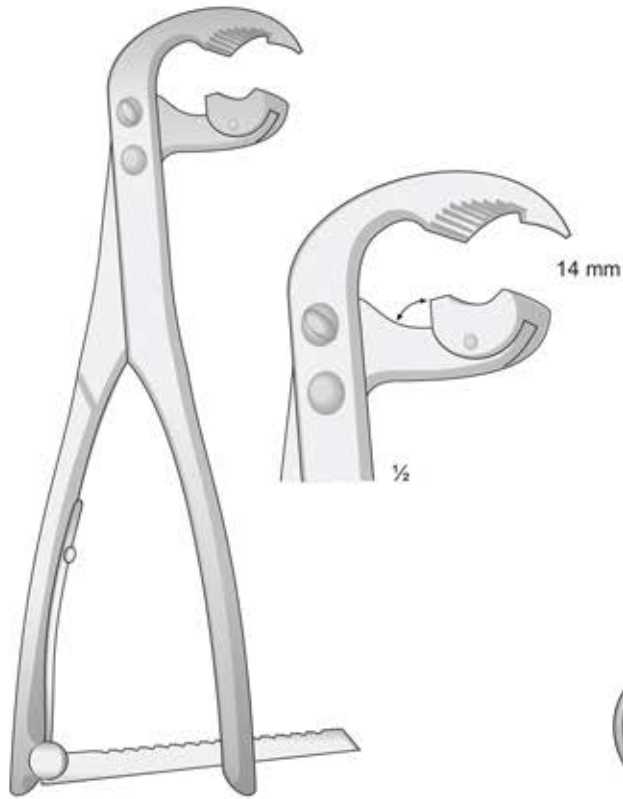

FO-78
215 mm

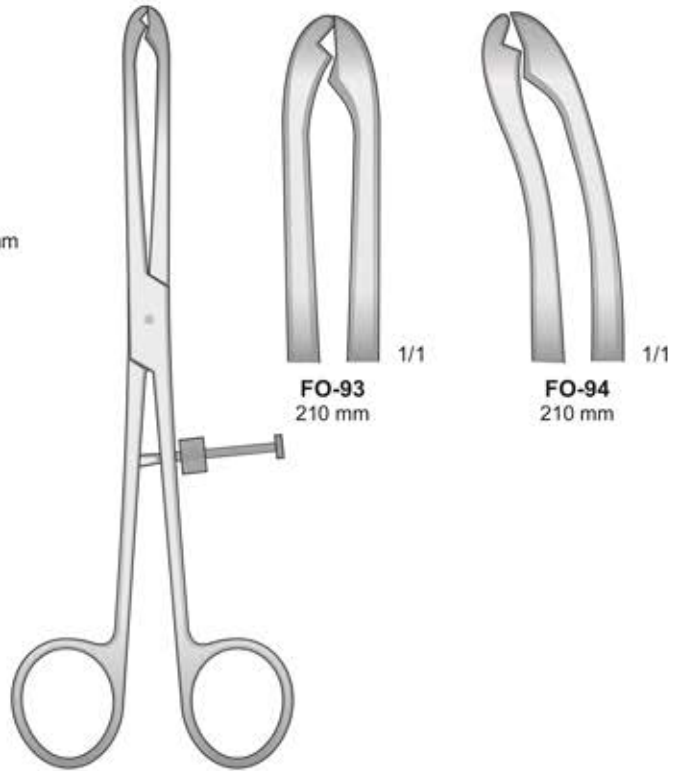

FIBULA
FO-93/FO-94
210 mm



LEWIN
FO-69
180 mm

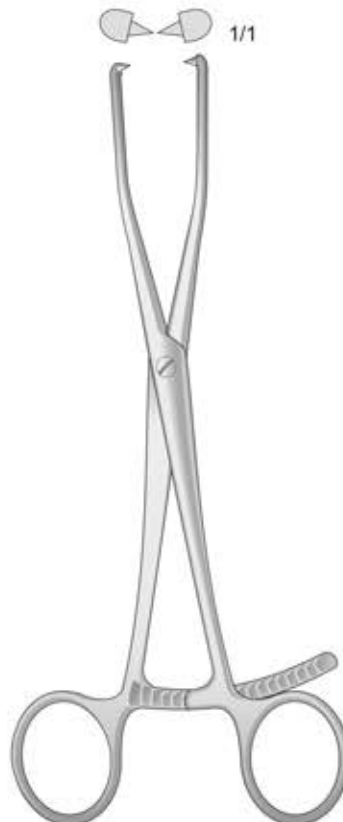

FO-67
210 mm

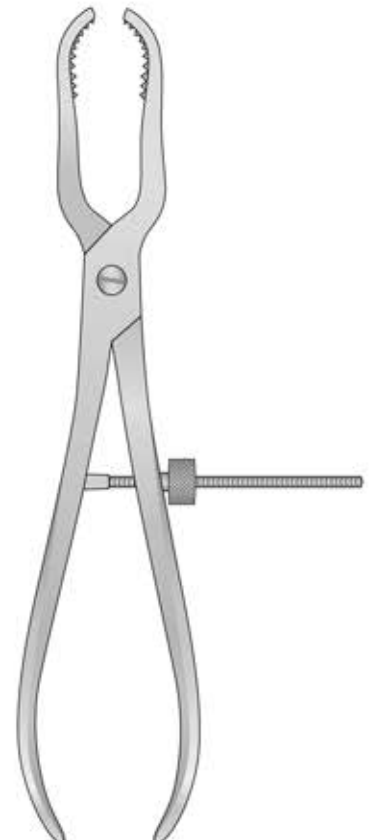

FO-65
230 mm



1/1

FO-62
230 mm

1/1

FO-82
250 mm

1/1

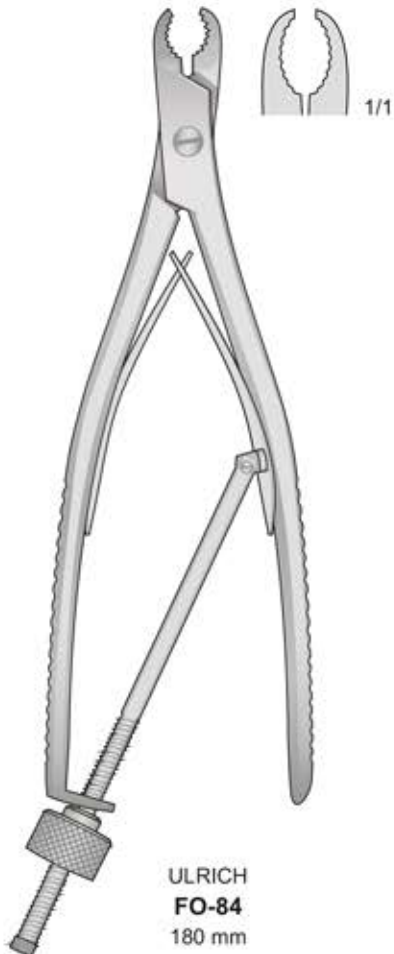
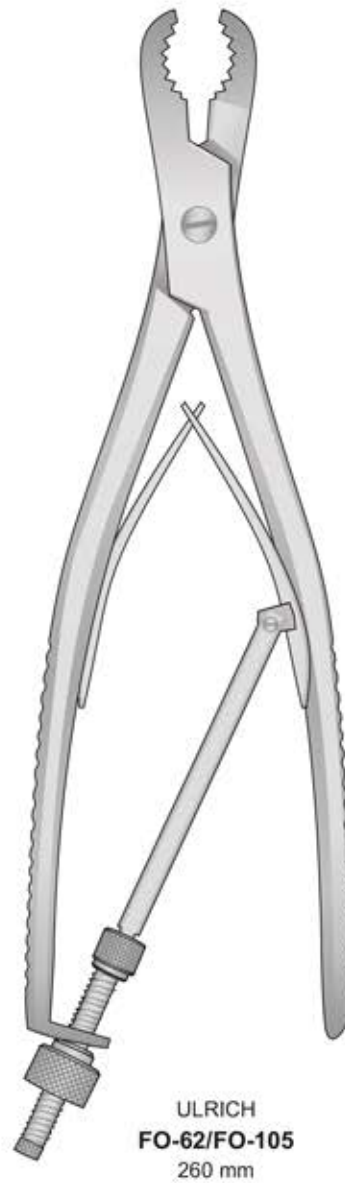
FO-105
280 mm**ULRICH**
FO-84
180 mm**ULRICH**
FO-62/FO-105
260 mm

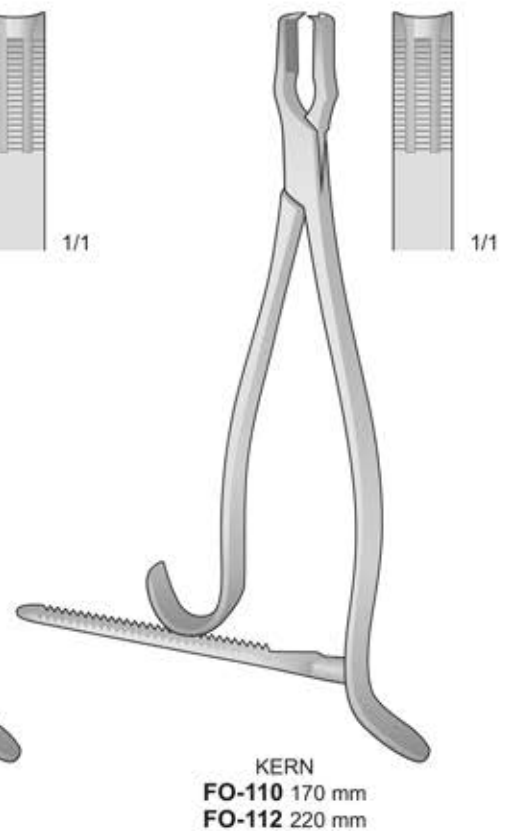
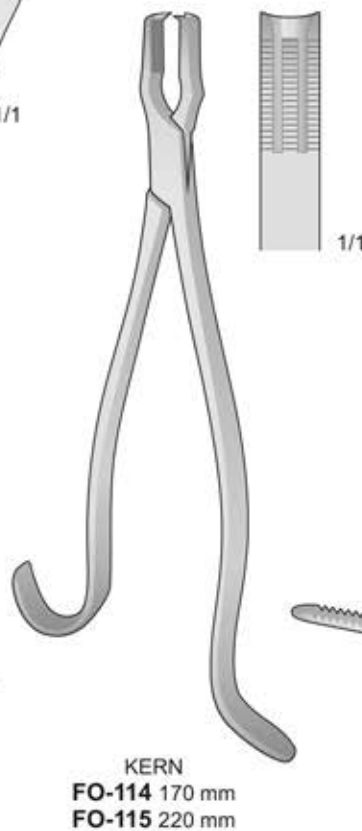
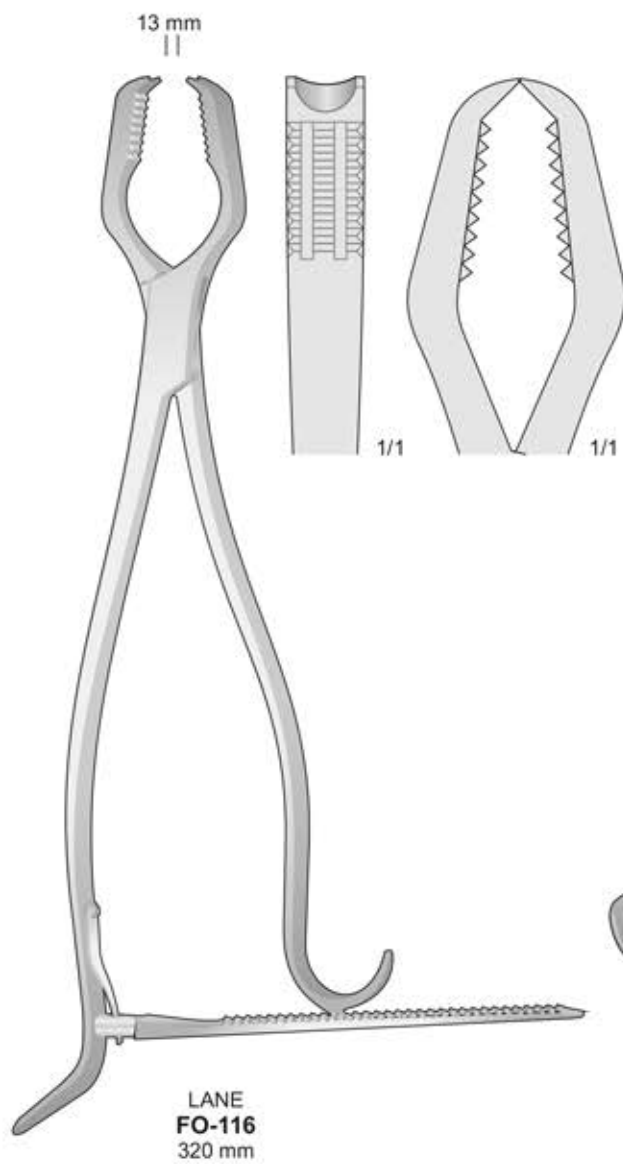

Rongeurs - Rongeur

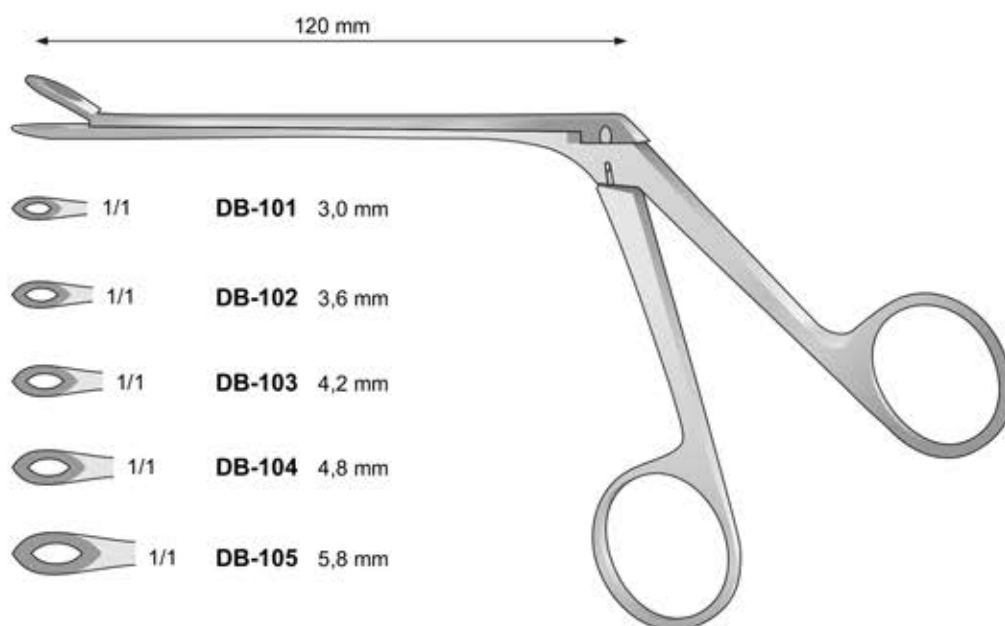

WEIL-BLAKESLEY
DB-101/DB-105
190 mm

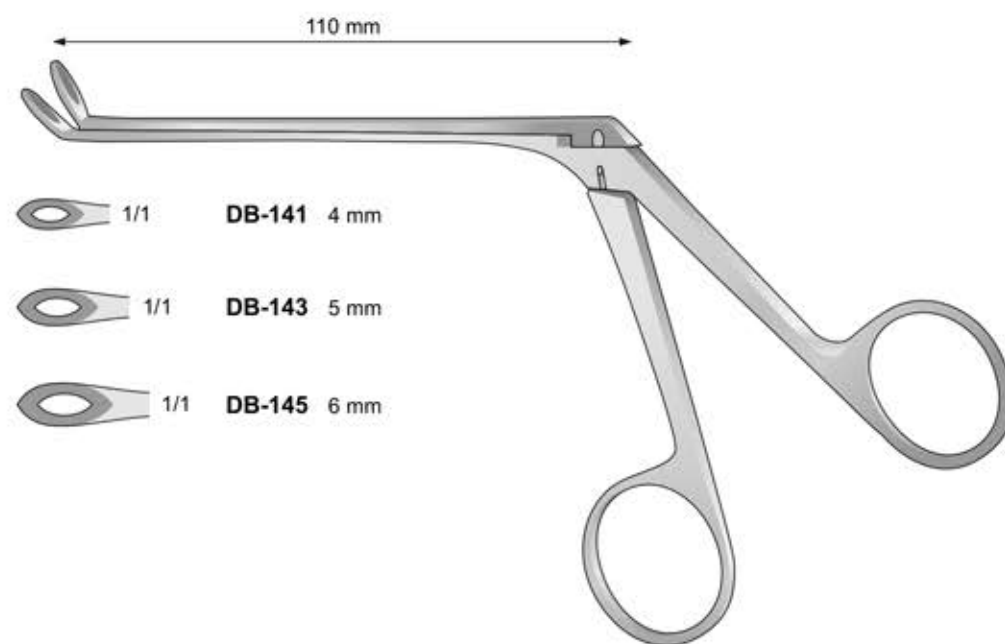

WEIL-BLAKESLEY
DB-141/DB-145
190 mm

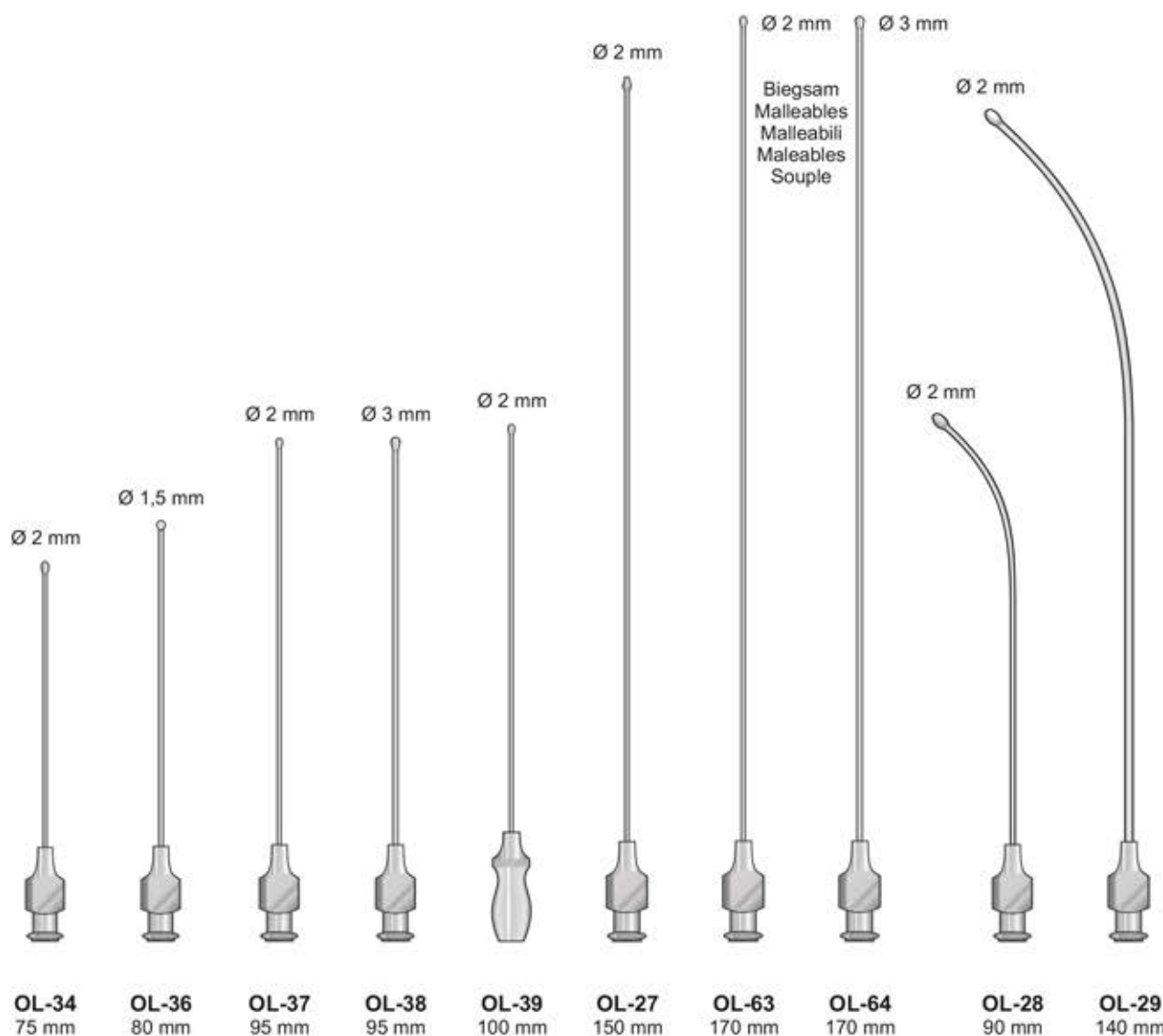
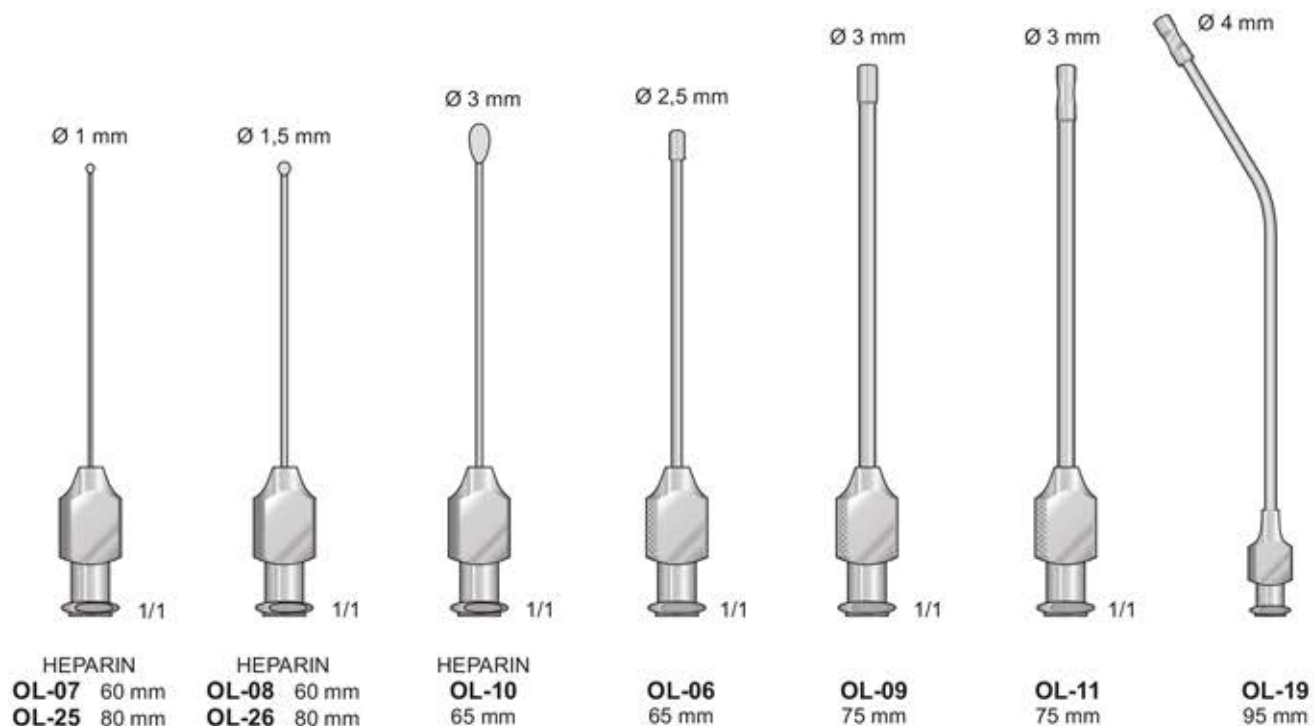

Saug- und Spülinstrumente
 Aspirating and Irrigating instruments
 Strumenti per aspirazione e lavaggio
 Instrumentos de aspiración y de lavado
 Instruments à aspiration et à irrigation

Ø 1 mm



OL-22
50 mm

Ø 2 mm



OL-23
50 mm

Ø 3 mm



OL-24
50 mm

WULLSTEIN Spül- und Saughandgriff mit Luer-Konus,
 passend für WULLSTEIN Spül- oder Saugrohre
 WULLSTEIN Irrigating suction handle, with Luer cone,
 for WULLSTEIN irrigating or Suction tubes

WULLSTEIN manico per aspirazione e lavaggio, con cono Luer,
 per cannule per aspirazione e lavaggio di WULLSTEIN

WULLSTEIN mango irrigador y ispirador, con cono Luer, apropiado
 para los tubos de lavado y de aspiración según WULLSTEIN

WULLSTEIN manche aspirateur et irrigateur, à cône Luer, s'adaptant
 aux tubes aspirateurs/irrigateurs de WULLSTEIN

Gefäß-spülkanülen, biegsam
 Vessel irrigating cannulas, malleable
 Cannule per irrigazione dei vasi, malleabili
 Cânulas de irrigacion para vasos, maleables
 Canules d'irrigation pour vaisseaux, malléables

Ø 3 mm Ø 4 mm Ø 5 mm Ø 6 mm

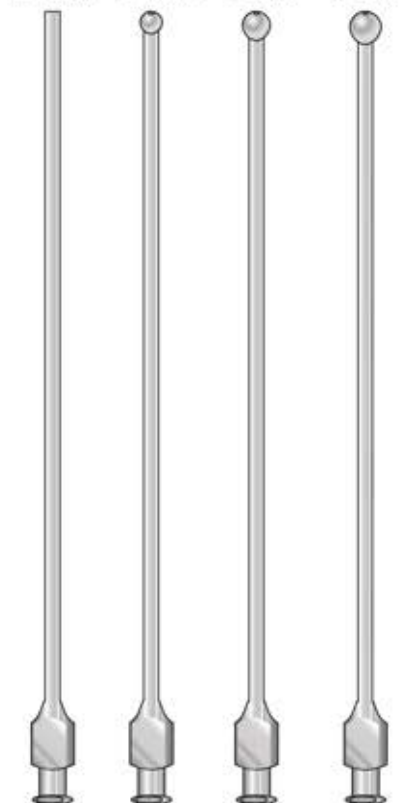

SCHMID **OL-30** 150 mm SCHMID **OL-31** 150 mm SCHMID **OL-32** 150 mm SCHMID **OL-33** 150 mm

Mit LUER-LOCK-Ansatz
 With LUER-LOCK attachment
 Con cono LUER-LOCK
 Con cono LUER-LOCK
 Avec cône LUER-LOCK



WULLSTEIN **GF-64**
120 mm



WULLSTEIN **GF-66**
110 mm



WULLSTEIN **GF-62**
65 mm



ROSEN
OL-16 Ø 0,70 mm
OL-17 Ø 0,90 mm
OL-18 Ø 1,25 mm
 95 mm



ROSEN
OL-13 Ø 0,70 mm
OL-14 Ø 0,90 mm
OL-15 Ø 1,25 mm
 95 mm

Tonsillenkanülen - Tonsil needles - Aghi per tonsille
Aiguilles pour les amygdales - Agujas para amígdalas



OL-01
120 mm



OL-02
110 mm



OL-03
110 mm



SEPTUN-NADEL
OL-04
110 mm



OL-05
110 mm



TUOHY
OL-41/OL-43

- OL-41** - 1,30 x 80 mm
- OL-42** - 1,50 x 80 mm
- OL-43** - 1,65 x 80 mm



QUINCKE
OL-44/OL-49

- OL-44** - 0,70 x 80 mm
- OL-45** - 0,70 x 90 mm
- OL-46** - 1,00 x 80 mm
- OL-47** - 1,00 x 90 mm
- OL-48** - 1,20 x 90 mm
- OL-49** - 1,20 x 100 mm



KLIMA-ROSEGGER
OL-40
1,80 x 35 mm



TUOHY
OL-41



QUINCKE
OL-45

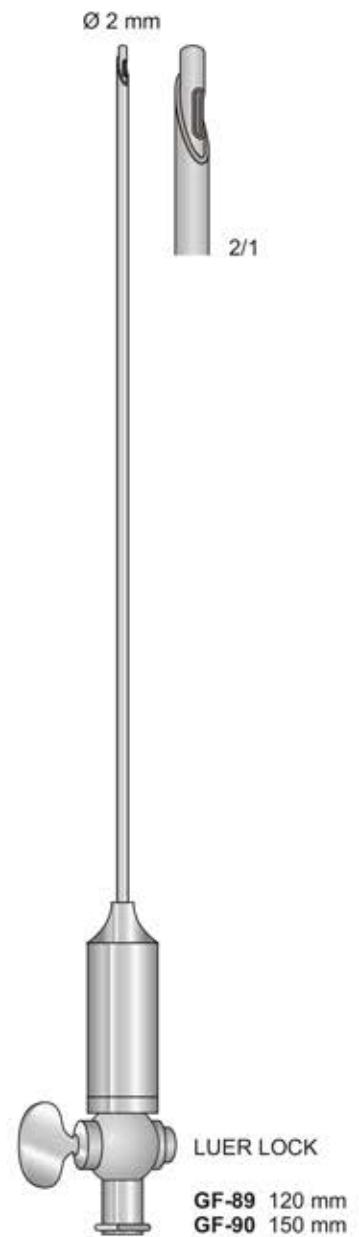

VERESS
GF-89/GF-90

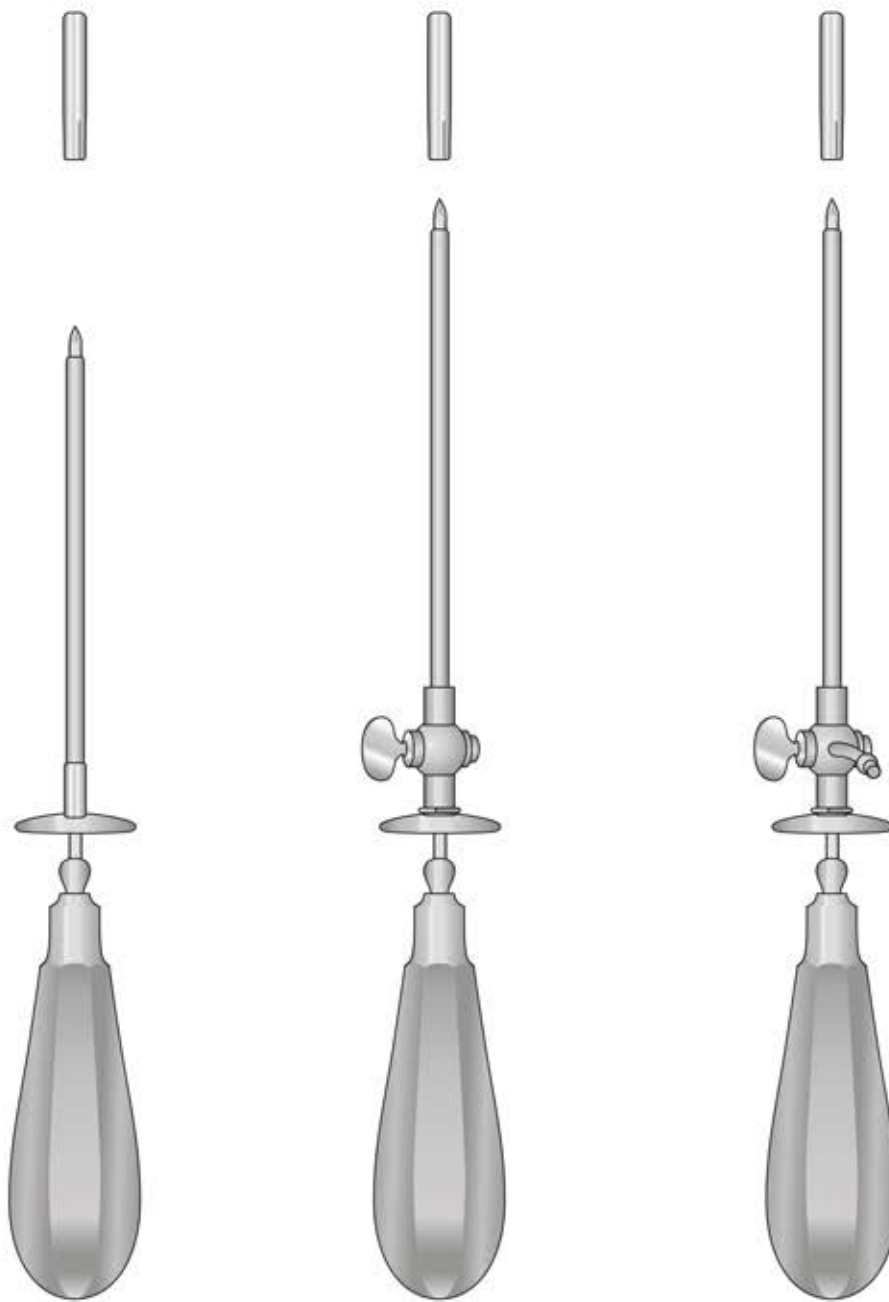

Ø mm Außen
 Outside
 Esterno
 Exterior
 Extérieur

Ø mm Innen
 Inside
 Interno
 Interior
 Intérieur

		STANDARD	STANDARD	STANDARD
3,0	2,0	TR-40	TR-20	TR-51
3,5	2,5	TR-44	TR-21	TR-52
4,0	3,0	TR-41	TR-22	TR-53
4,5	3,5	TR-45	TR-23	TR-54
5,0	4,0	TR-42	TR-24	TR-55
5,5	4,5	TR-46	TR-25	TR-56
6,0	5,0	TR-43	TR-26	TR-57
		110 mm	120 mm	120 mm

Für die gallenblase - For gall bladder - Per vesicula biliare
 Para vesicula biliar - Pour la vésicule biliaire

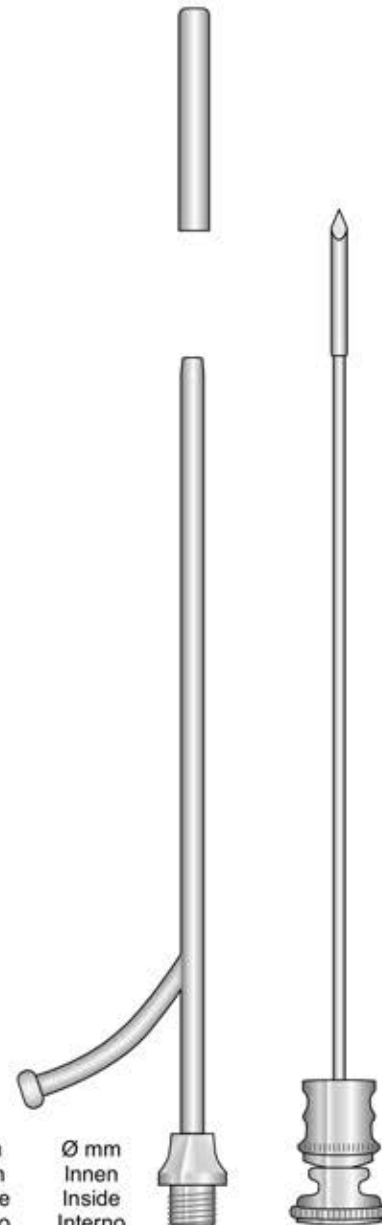
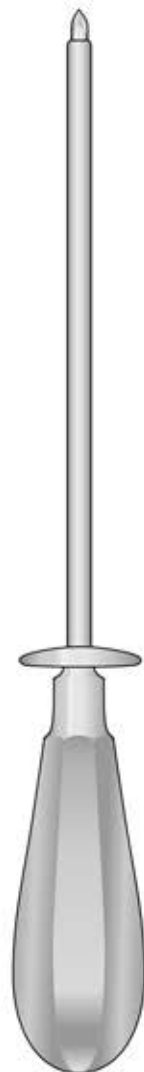
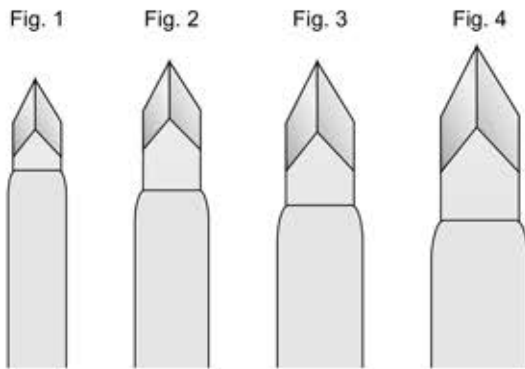

Ø mm Außen Outside Esterno Exterior Extérieur	Ø mm Innen Inside Interno Interior Intérieur		
7,5	6,0	Fig. 1	TR-61
9,5	8,0	Fig. 2	TR-62
11,0	9,5	Fig. 3	TR-63
12,5	11,0	Fig. 4	TR-64
210 mm			

Ø mm Außen Outside Esterno Exterior Extérieur	Ø mm Innen Inside Interno Interior Intérieur	
4,0	3,0	GF-120
4,6	3,6	GF-121
5,3	4,3	GF-122
6,0	5,0	GF-123
210 mm		

Kieferhöhlentrokare
 Antrum puncture trocars
 Trequarti per seno mascellare
 Trócares para punción del seno maxilar
 Trocarts pour sinus maxillaire



LICHTWITZ
TR-30
 190 mm

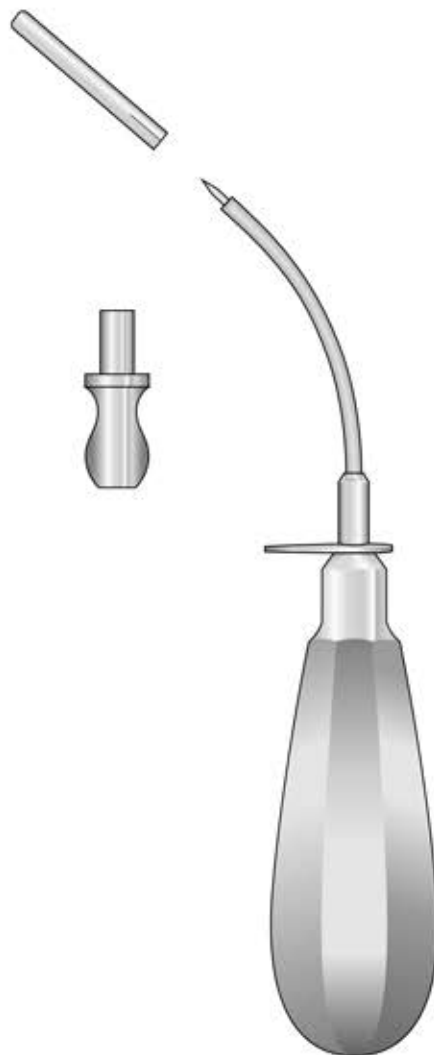

PIERCE
TR-32 Ø 3 mm
TR-33 Ø 4 mm
TR-34 Ø 5 mm
 160 mm

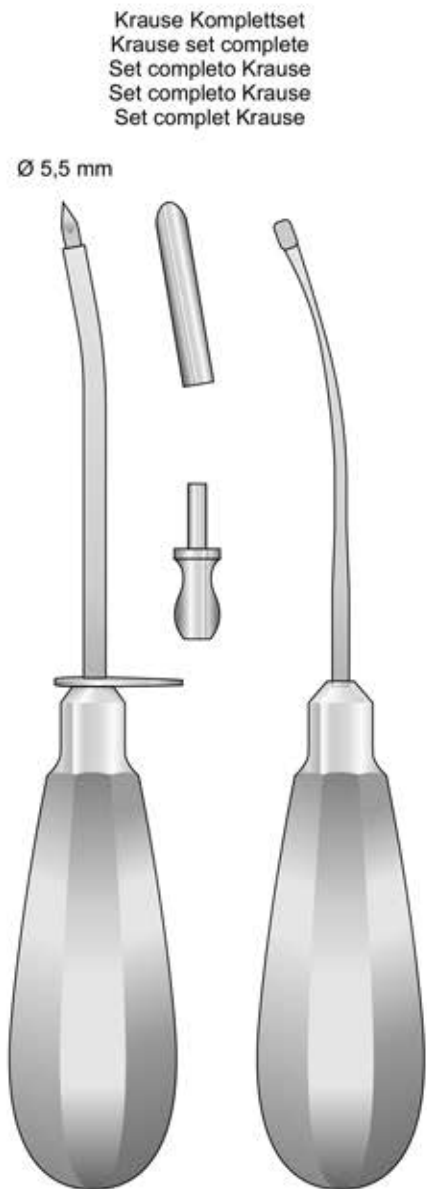

KRAUSE
TR-35
 160 mm

Krause Komplettsset
 Krause set complete
 Set completo Krause
 Set completo Krause
 Set complet Krause

Ø 5,5 mm

Ø 1,8 mm

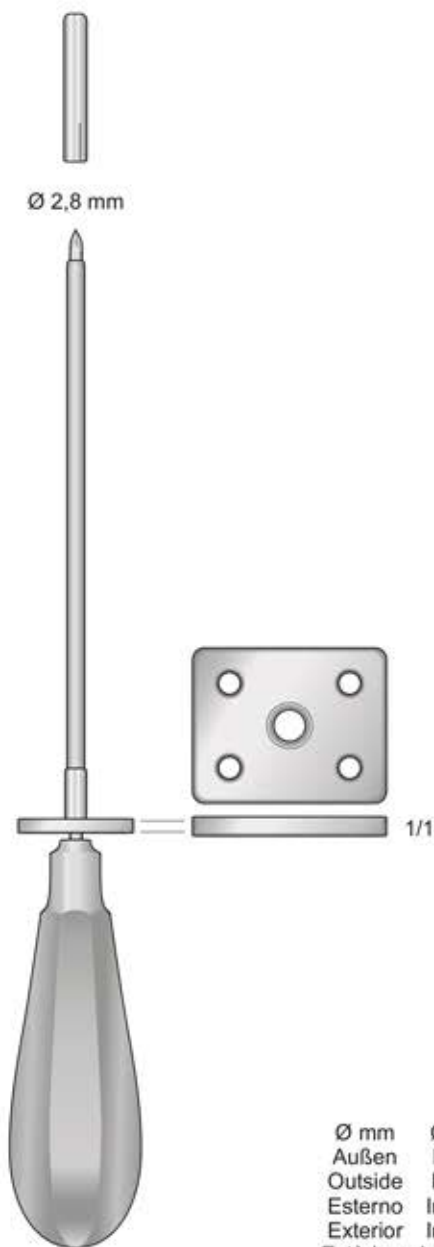

TR-60
250 mm

Ø mm	Ø mm
Außen	Innen
Outside	Inside
Esterno	Interno
Exterior	Interior
Extérieur	Intérieur

8	6,5	TR-68
10	8,5	TR-69
		240 mm

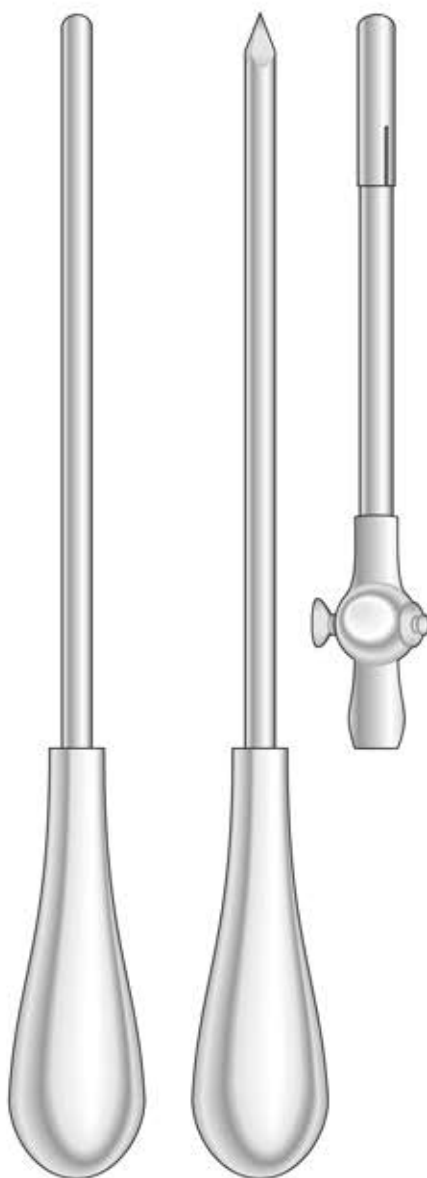

BUELAU

Sternal-Punktionskanülen
Sternal puncture needle
Ago per la puntura dello sterno
Agujas para punción esternal
Aiguilles pour la ponction sternale

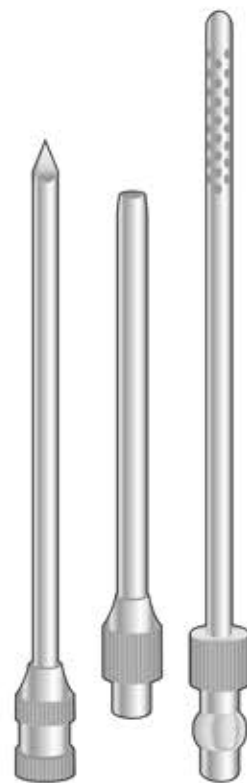

DUKE
GF-106
110 mm - 5,5 mm

Mit Holzgriff
With wooden handle
Manico in legno
Con mango de leña
Avec poignée en bois

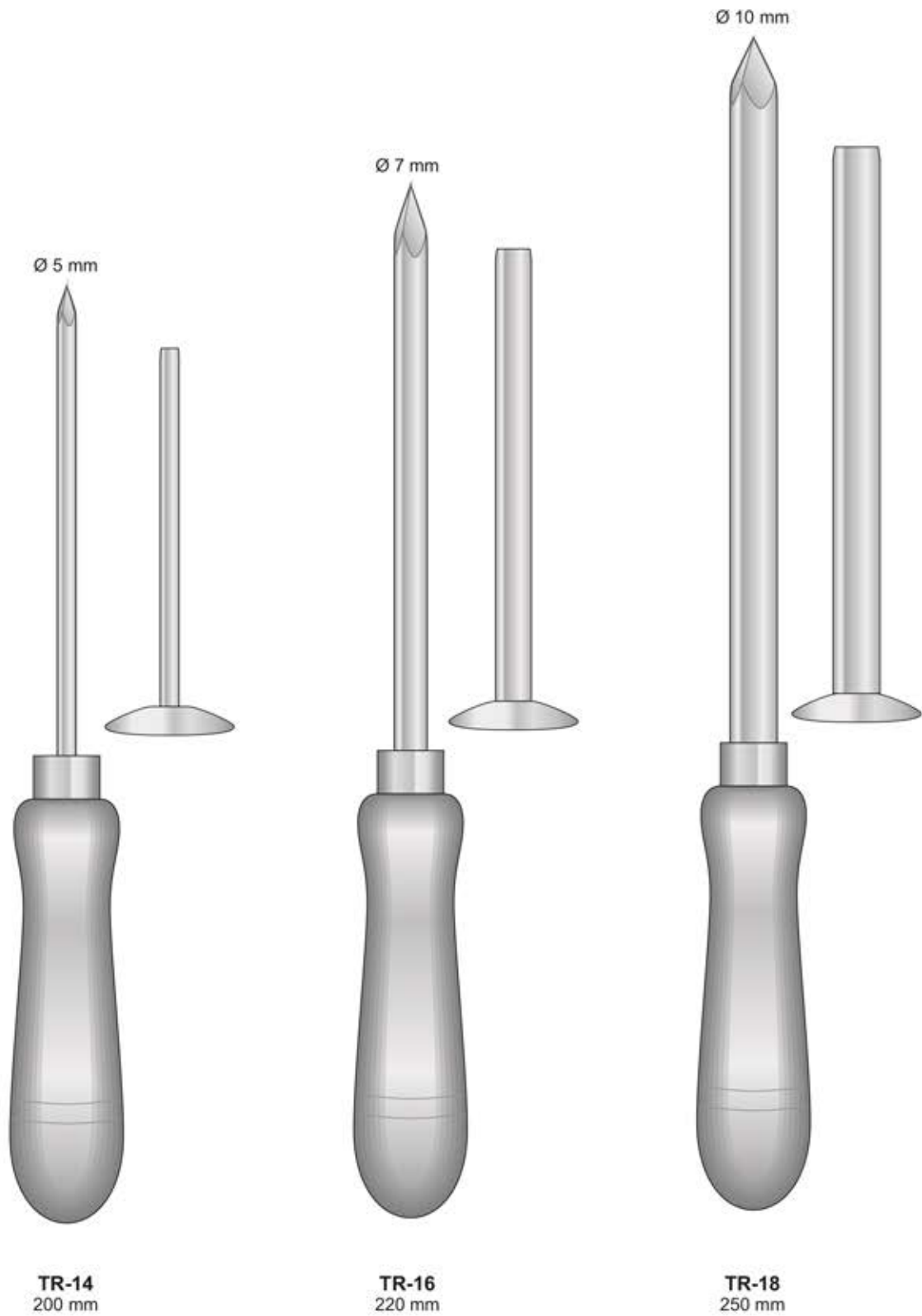



TR-77
140 mm

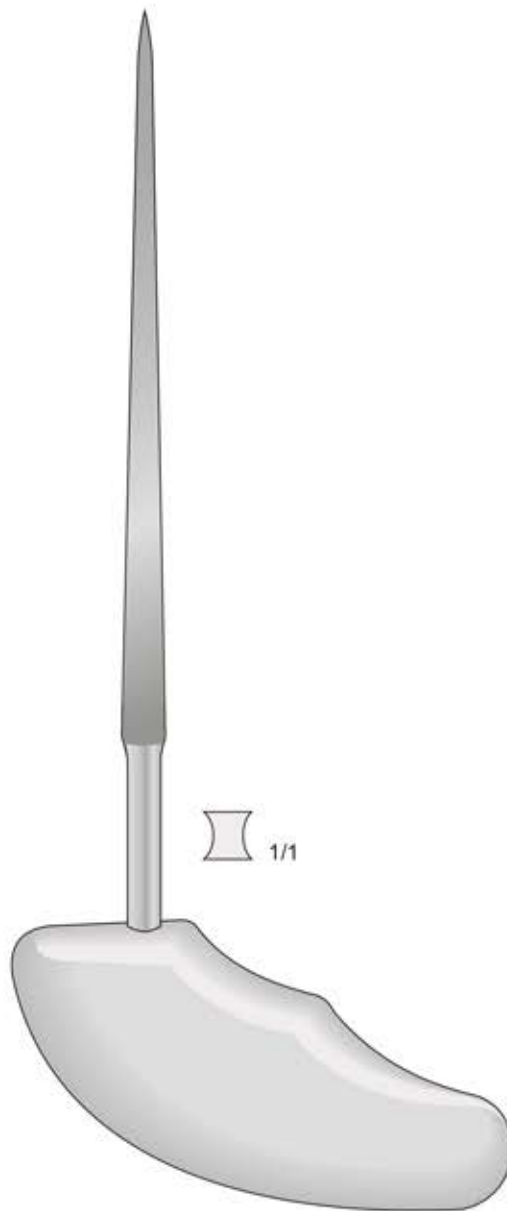

**PERTHES
TR-78**
210 mm

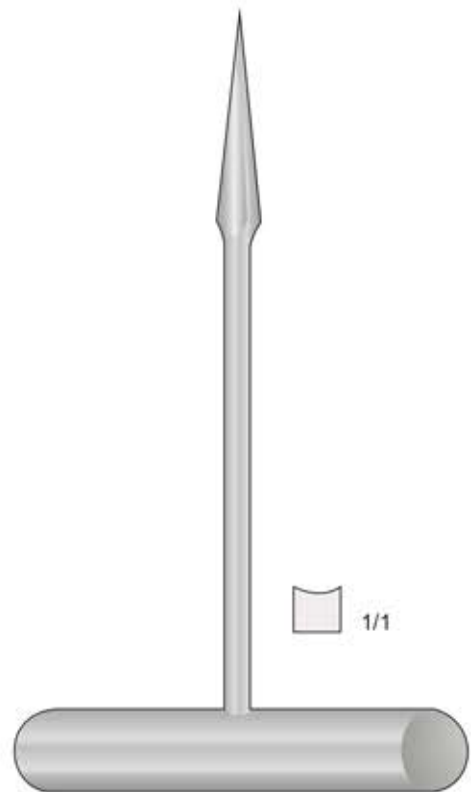

TR-76
140 mm



FK-105

Kompletset mit 4 Teilen
 Set complete with 4 pieces
 Set completo di 4 pezzi
 Set completo con 4 piezas
 Set complet avec 4 pièces

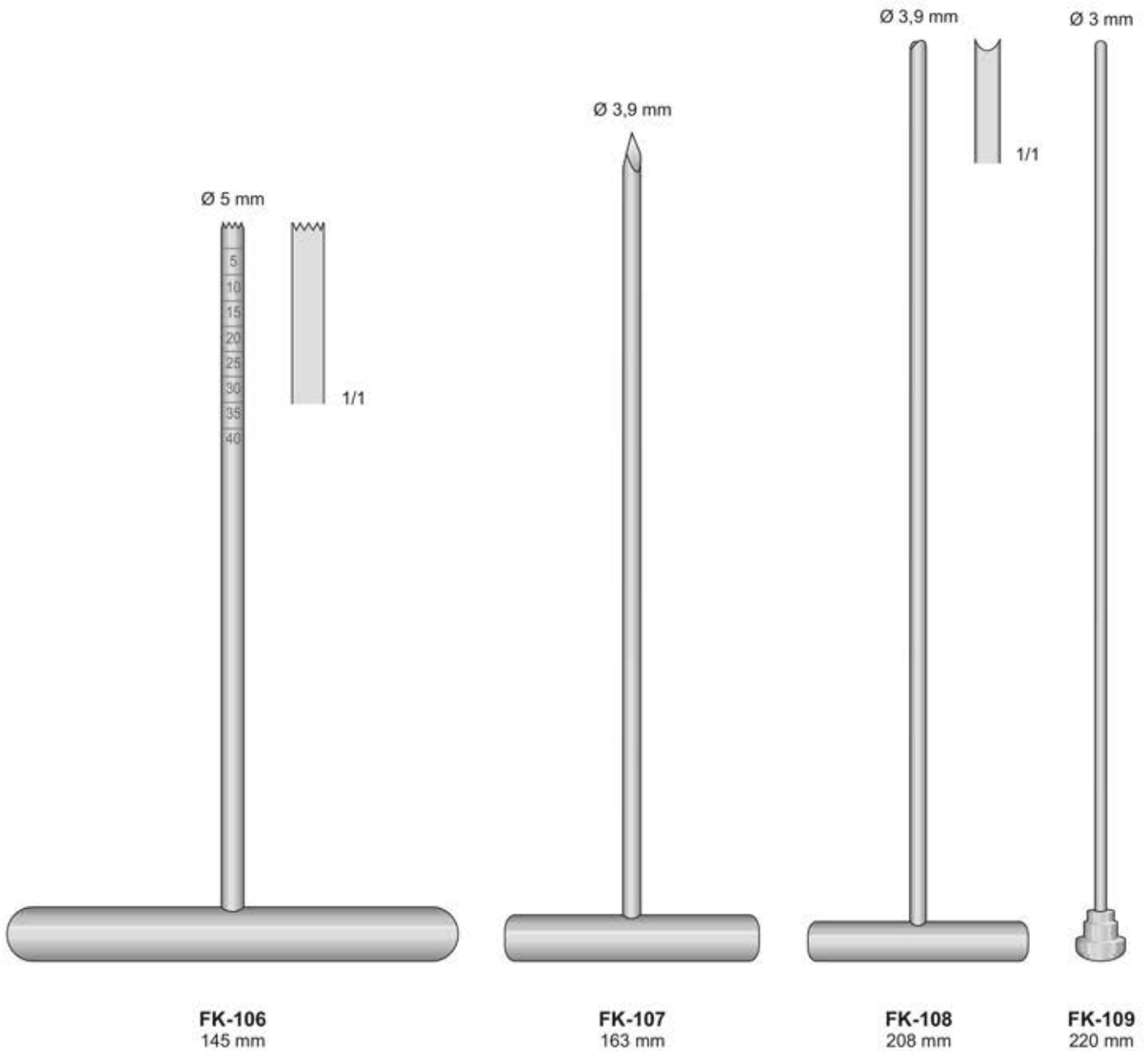

FK-100

Kompletset mit 4 Teilen
 Set complete with 4 pieces
 Set completo di 4 pezzi
 Set completo con 4 piezas
 Set complet avec 4 pièces

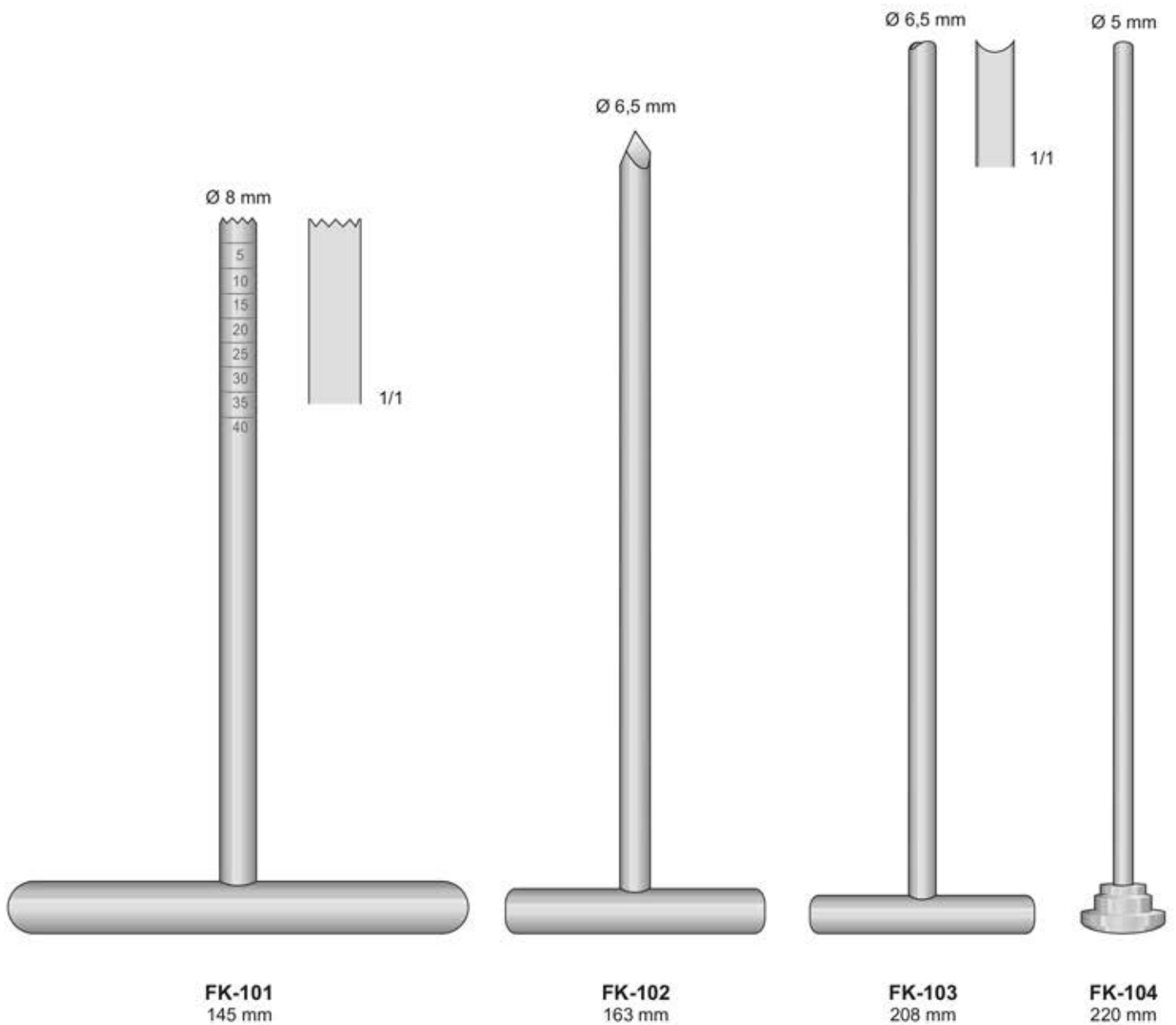

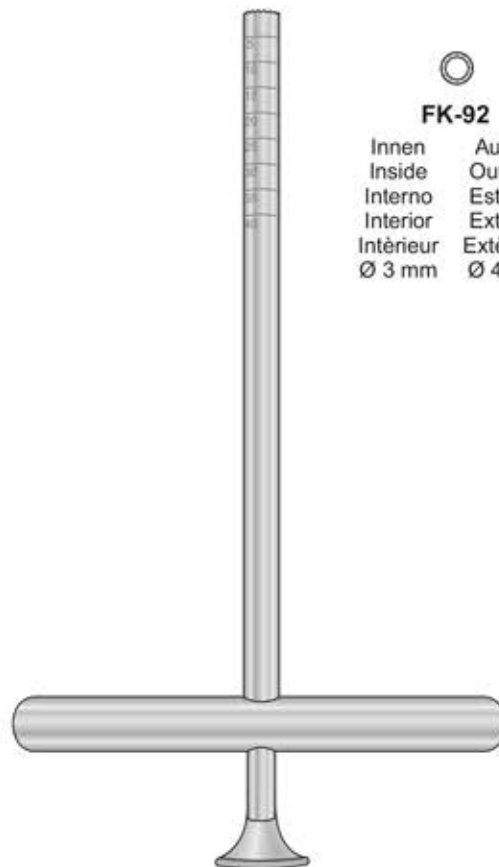
**FK-92**

Innen	Außen
Inside	Outside
Interno	Esterno
Interior	Exterior
Intérieur	Extérieur
Ø 3 mm	Ø 4 mm

FK-92
170 mm

1 Seite flach - 1 Seite convex
1 Side flat - 1 Side convex
1 Lato piatto - 1 Lato convesso
1 Parte plana - 1 Parte convexa
1 Face plate - 1 Face convexe

Ø 30 mm - 240 g



COTTLE
FL-104
185 mm

Ø 30 mm - 300 g



BERGMANN
FL-105
235 mm

Ø 45 mm - 300 g



BERGMANN
FL-106
245 mm



FL-107
240 mm



OMBREDANNE
FL-108
240 mm



HEATH
FL-109
185 mm



FL-112
190 mm

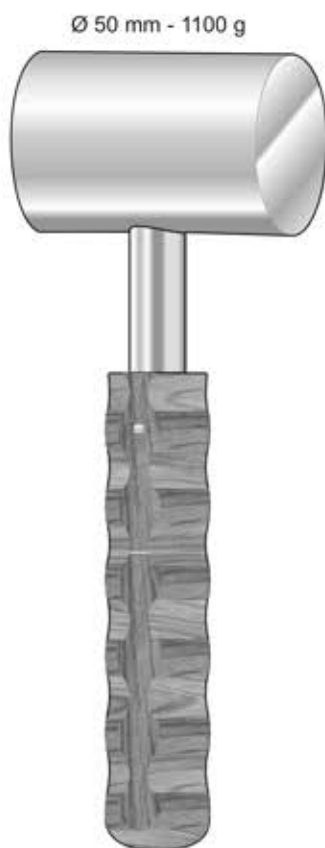

FL-111
200 mm

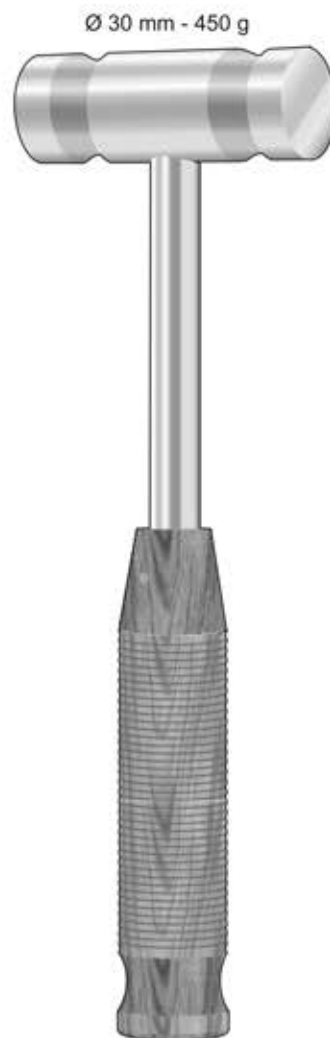

FL-06
260 mm



FL-113
270 mm



FF-147
Ø3 mm

FF-148
Ø5 mm

FF-149
Ø8 mm

CASPAR
FF-147/FF-149
200 mm

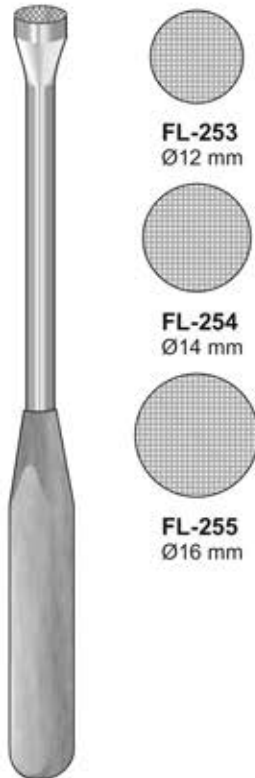

FL-253
Ø12 mm

FL-254
Ø14 mm

FL-255
Ø16 mm

FL-253/FL-255
200 mm



FL-256
3x8 mm

FL-257
4x10 mm

FL-258
5x15 mm

FL-259
6x20 mm

SYPERT
FL-256/FL-259
290 mm

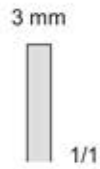

FL-177

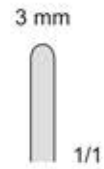

FL-185

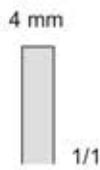

FL-179

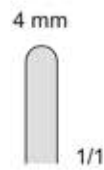

FL-186

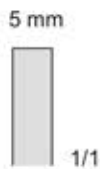

FL-181

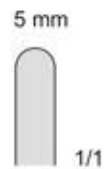

FL-187

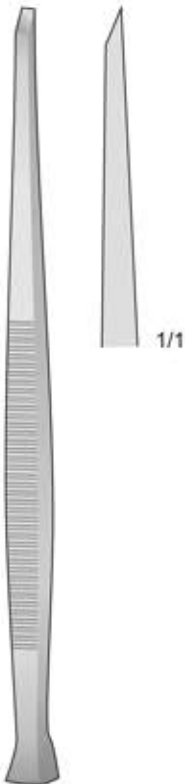

PARTSCH
FL-177/FL-184
170 mm

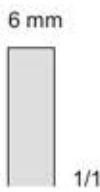

FL-183

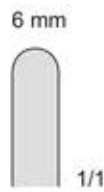

FL-188

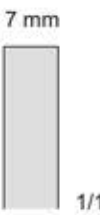

FL-184

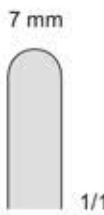

FL-189

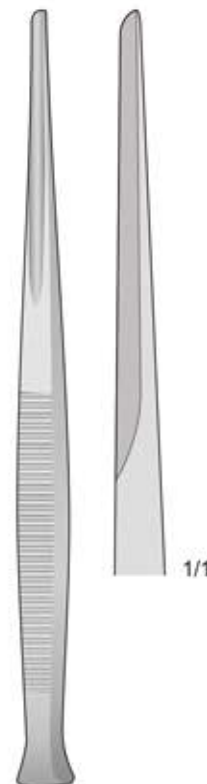

PARTSCH
FL-185/FL-189
170 mm

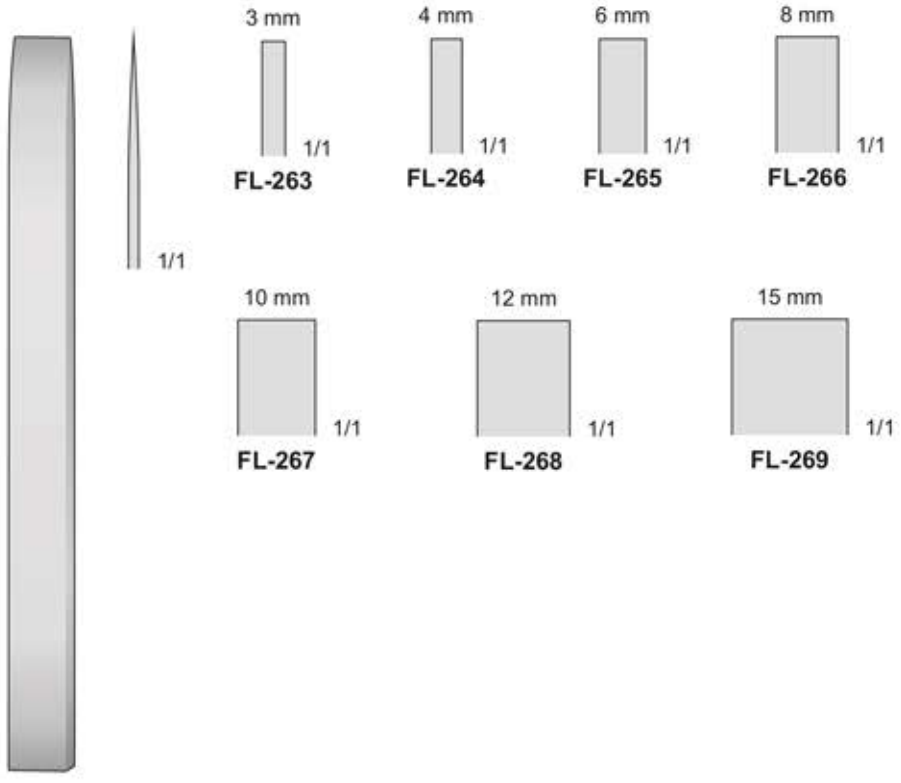

MINI-LAMBOTTE
FL-263/FL-269
170 mm

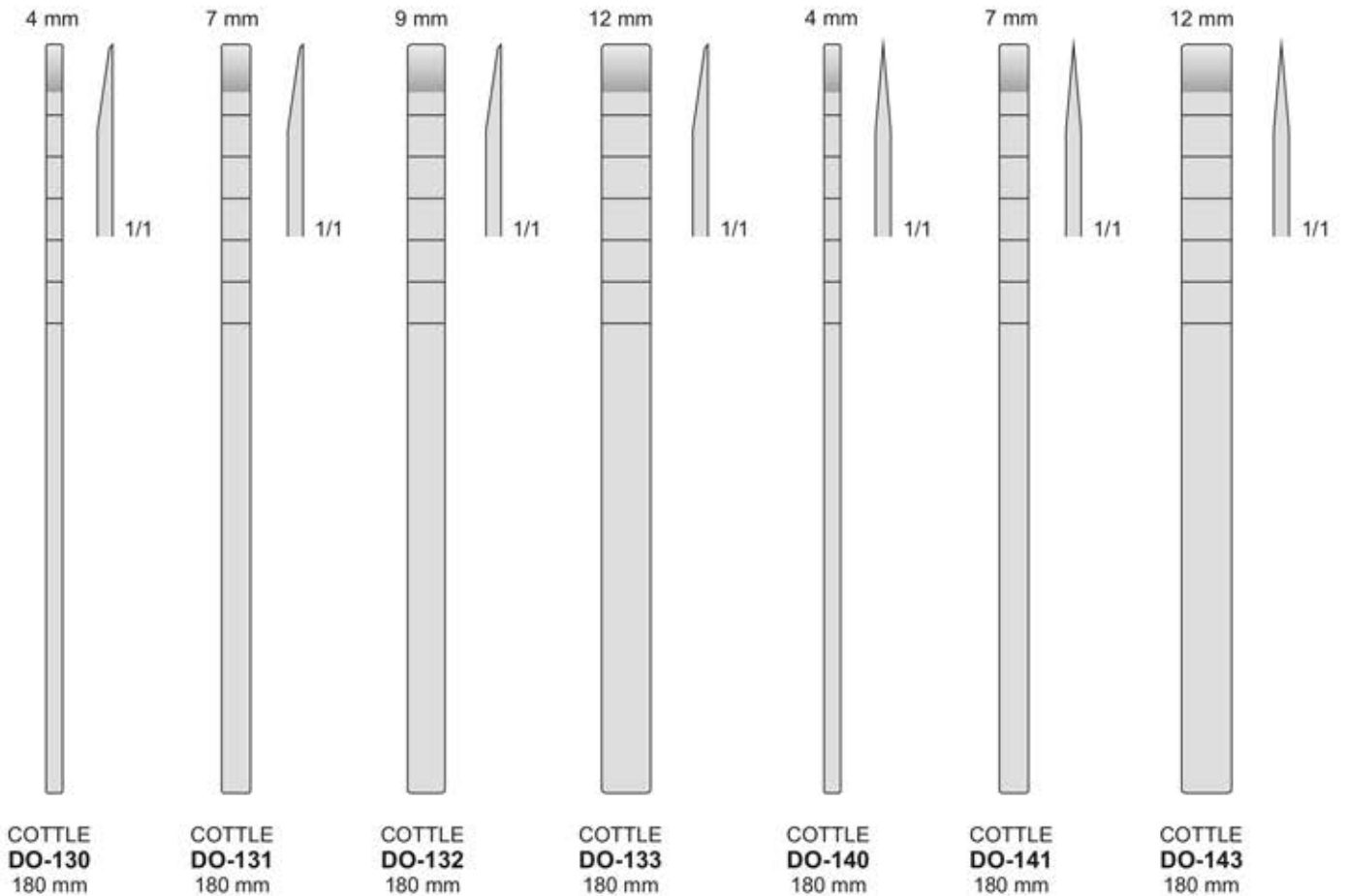

COTTLE
DO-130
180 mm

COTTLE
DO-131
180 mm

COTTLE
DO-132
180 mm

COTTLE
DO-133
180 mm

COTTLE
DO-140
180 mm

COTTLE
DO-141
180 mm

COTTLE
DO-143
180 mm

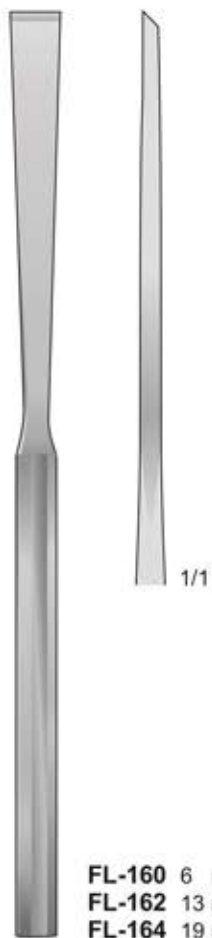

FL-160 6 mm
FL-162 13 mm
FL-164 19 mm

HIBBS
FL-160/FL-164
 230 mm

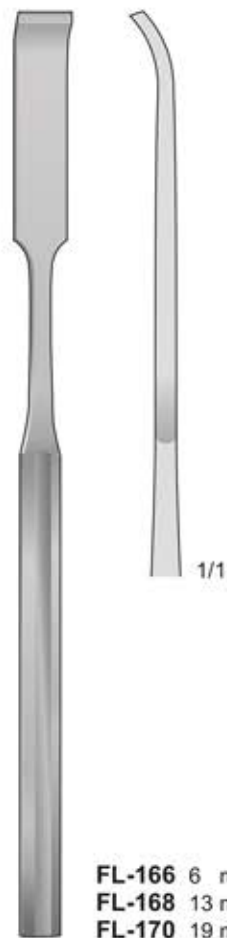

FL-166 6 mm
FL-168 13 mm
FL-170 19 mm

HIBBS
FL-166/FL-170
 230 mm

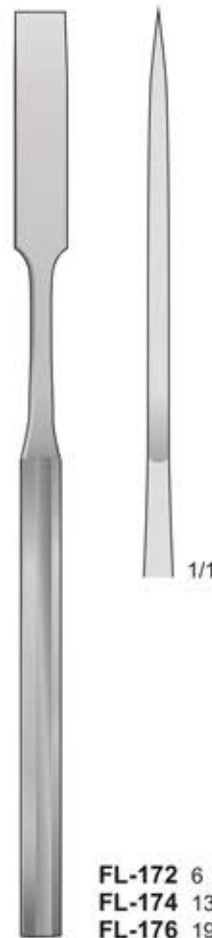

FL-172 6 mm
FL-174 13 mm
FL-176 19 mm

HIBBS
FL-172/FL-176
 230 mm

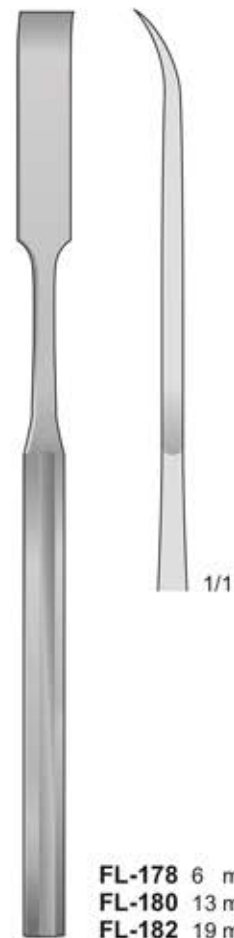

FL-178 6 mm
FL-180 13 mm
FL-182 19 mm

HIBBS
FL-178/FL-182
 230 mm

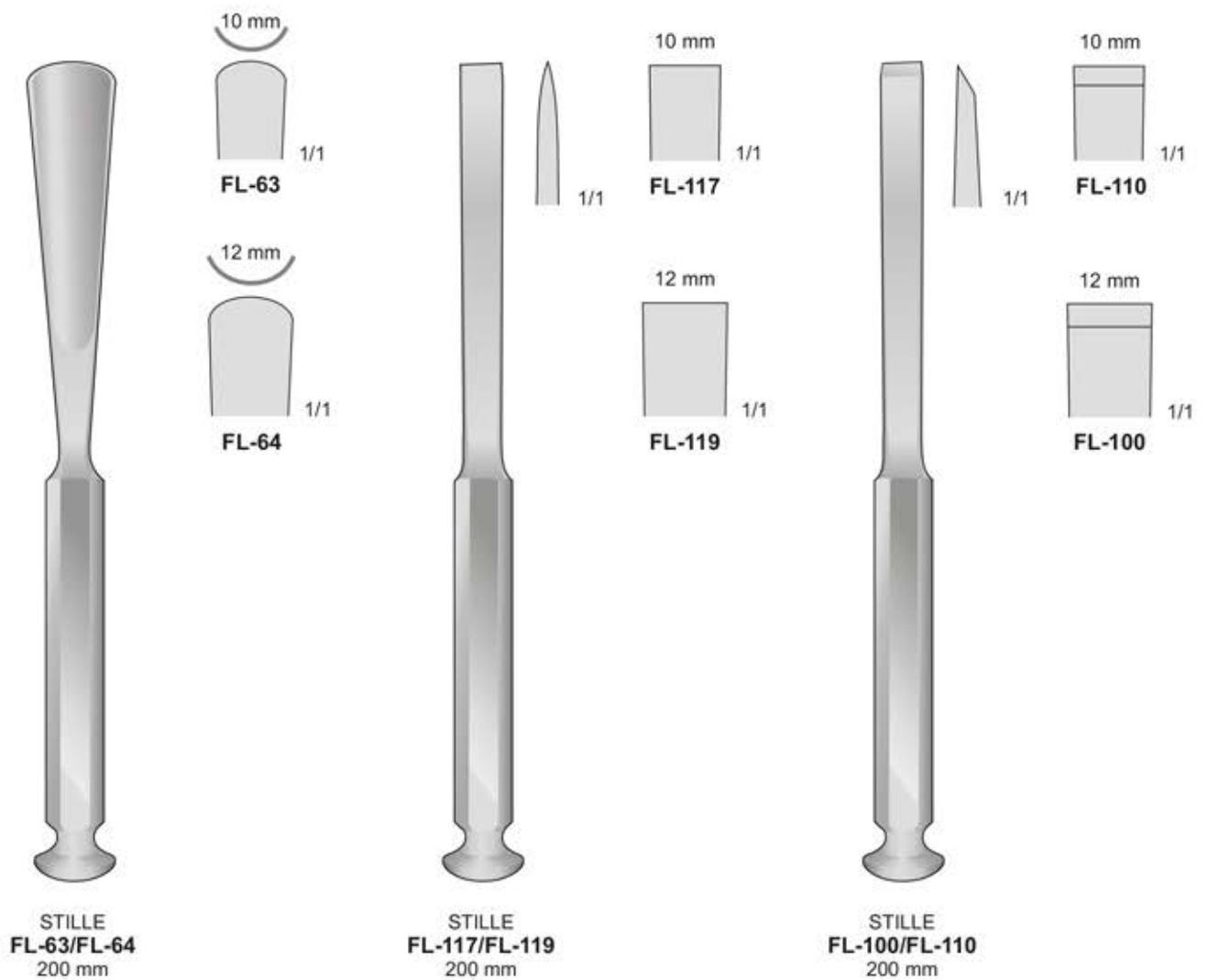

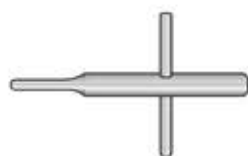

FL-84
90 mm

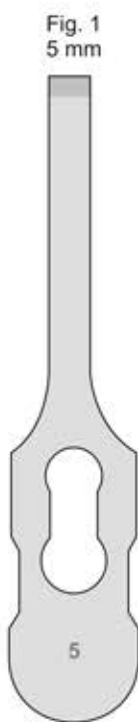

FL-86
85 mm

1/1

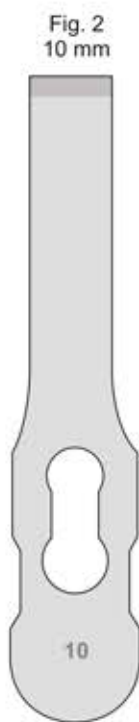

FL-87
85 mm

1/1



FL-88
85 mm

1/1

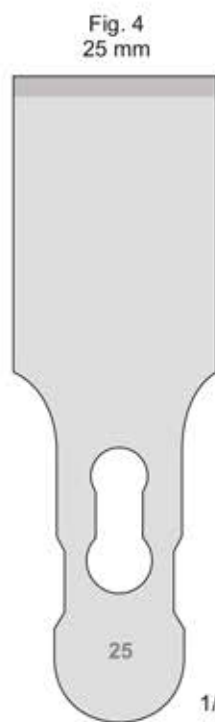

FL-89
85 mm

1/1



Meißel
Chisel
Scalpelli
Cinceles
Ciseaux-burins



FL-85
190 mm

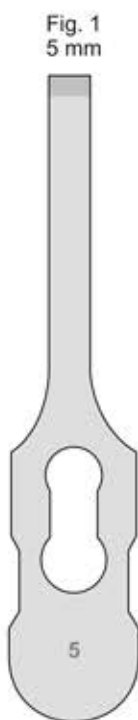

FL-286
85 mm

1/1

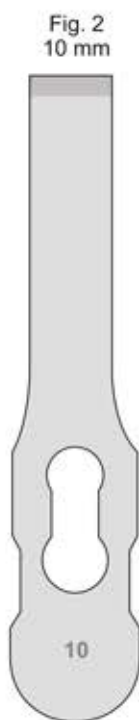

FL-287
85 mm

1/1



FL-288
85 mm

1/1



FL-289
85 mm

1/1



Osteotom
Gouge
Osteotomi
Cubias
Gouges

Meßlehre für Kirschnerdrähte
 Measuring Gauge for nails
 Misuratore per chiodi Kirschner



KI-10

0,5 mm



0,5 mm



0,5 mm



0,5 mm



LS-07
50 mm

LS-08
100 mm

LS-09
150 mm

LS-06
300 mm

Meßbereich: 0 - 15 mm
 Measuring range: 0 - 15 mm
 Campo di misura: 0 - 15 mm
 Alcance de medición: 0 - 15 mm
 Etendue de mesure: 0 - 15 mm

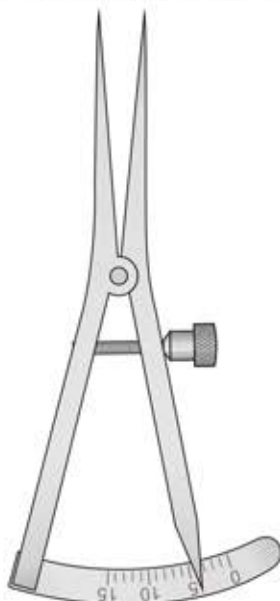

CASTROVIEJO
OR-15
 90 mm

Meßbereich: 0 - 20 mm
 Measuring range: 0 - 20 mm
 Campo di misura: 0 - 20 mm
 Alcance de medición: 0 - 20 mm
 Etendue de mesure: 0 - 20 mm

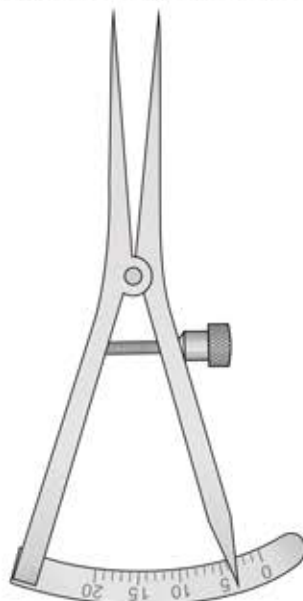

CASTROVIEJO
OR-17
 90 mm

Meßbereich: 0 - 20 mm
 Measuring range: 0 - 20 mm
 Campo di misura: 0 - 20 mm
 Alcance de medición: 0 - 20 mm
 Etendue de mesure: 0 - 20 mm

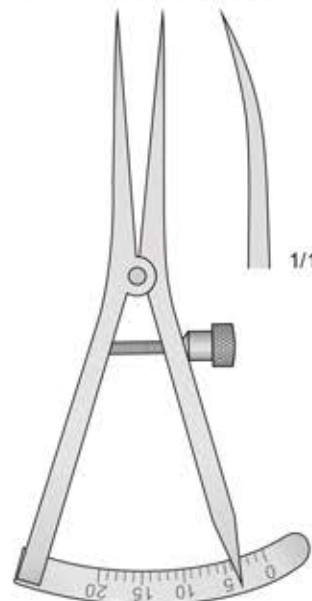

CASTROVIEJO
OR-19
 90 mm

Meßbereich: 0 - 40 mm
 Measuring range: 0 - 40 mm
 Campo di misura: 0 - 40 mm
 Alcance de medición: 0 - 40 mm
 Etendue de mesure: 0 - 40 mm

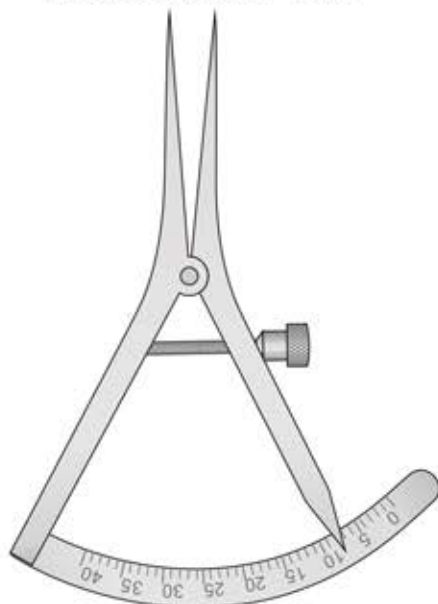

CASTROVIEJO
OR-11
 90 mm

Meßbereich: 0 - 40 mm
 Measuring range: 0 - 40 mm
 Campo di misura: 0 - 40 mm
 Alcance de medición: 0 - 40 mm
 Etendue de mesure: 0 - 40 mm

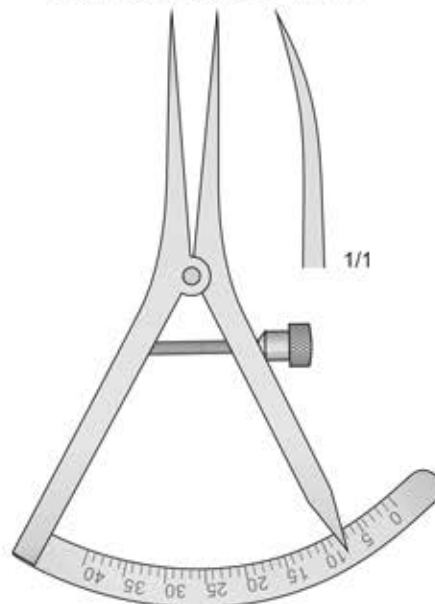

CASTROVIEJO
OR-13
 90 mm

Meßbereich: 0 - 40 mm
 Measuring range: 0 - 40 mm
 Campo di misura: 0 - 40 mm
 Alcance de medición: 0 - 40 mm
 Etendue de mesure: 0 - 40 mm

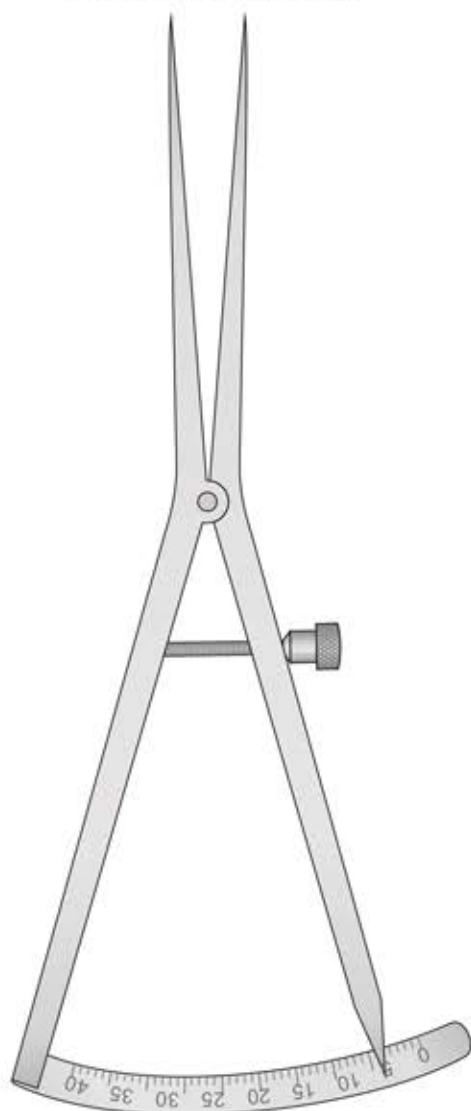

CASTROVIEJO
OR-12
 170 mm

Meßbereich: 0 - 40 mm
 Measuring range: 0 - 40 mm
 Campo di misura: 0 - 40 mm
 Alcance de medición: 0 - 40 mm
 Etendue de mesure: 0 - 40 mm

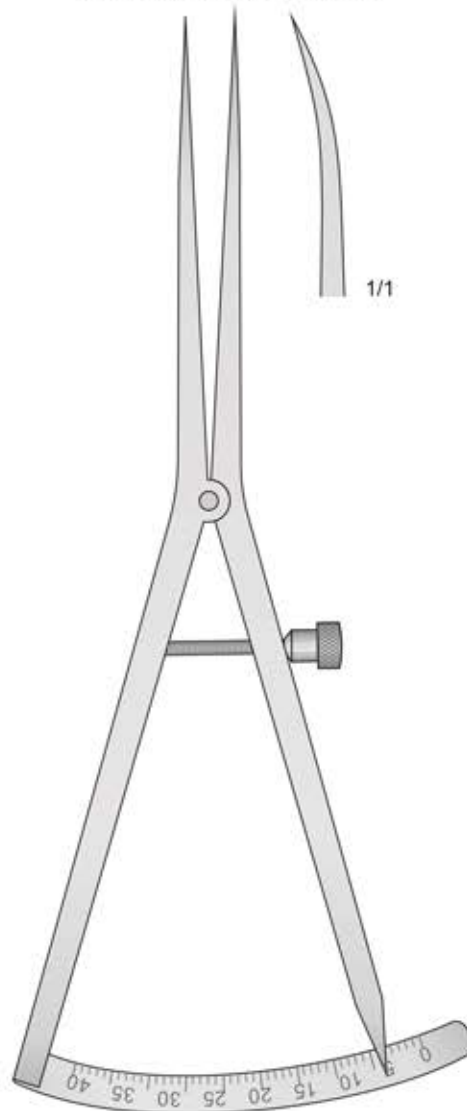

CASTROVIEJO
OR-14
 170 mm

Meßbereich: 0 - 40 mm
 Measuring range: 0 - 40 mm
 Campo di misura: 0 - 40 mm
 Alcance de medición: 0 - 40 mm
 Etendue de mesure: 0 - 40 mm

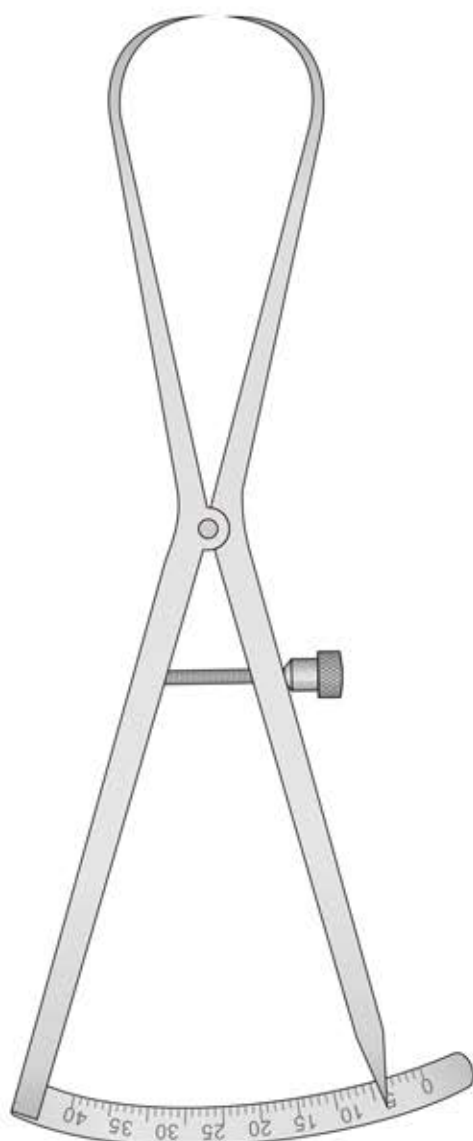

CASTROVIEJO
OR-16
 170 mm

Meßbereich: 0 - 40 mm
 Measuring range: 0 - 40 mm
 Campo di misura: 0 - 40 mm
 Alcance de medición: 0 - 40 mm
 Etendue de mesure: 0 - 40 mm

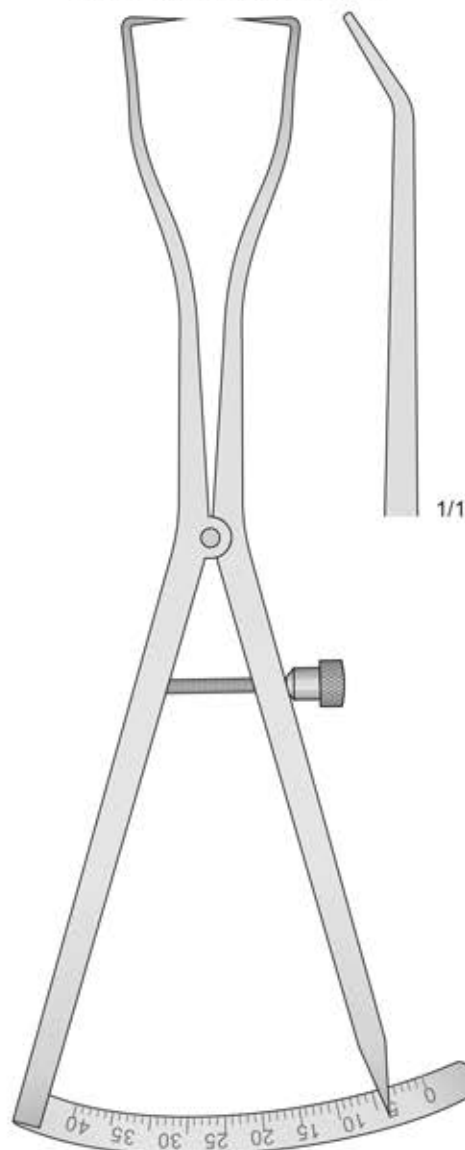

CASTROVIEJO
OR-18
 170 mm

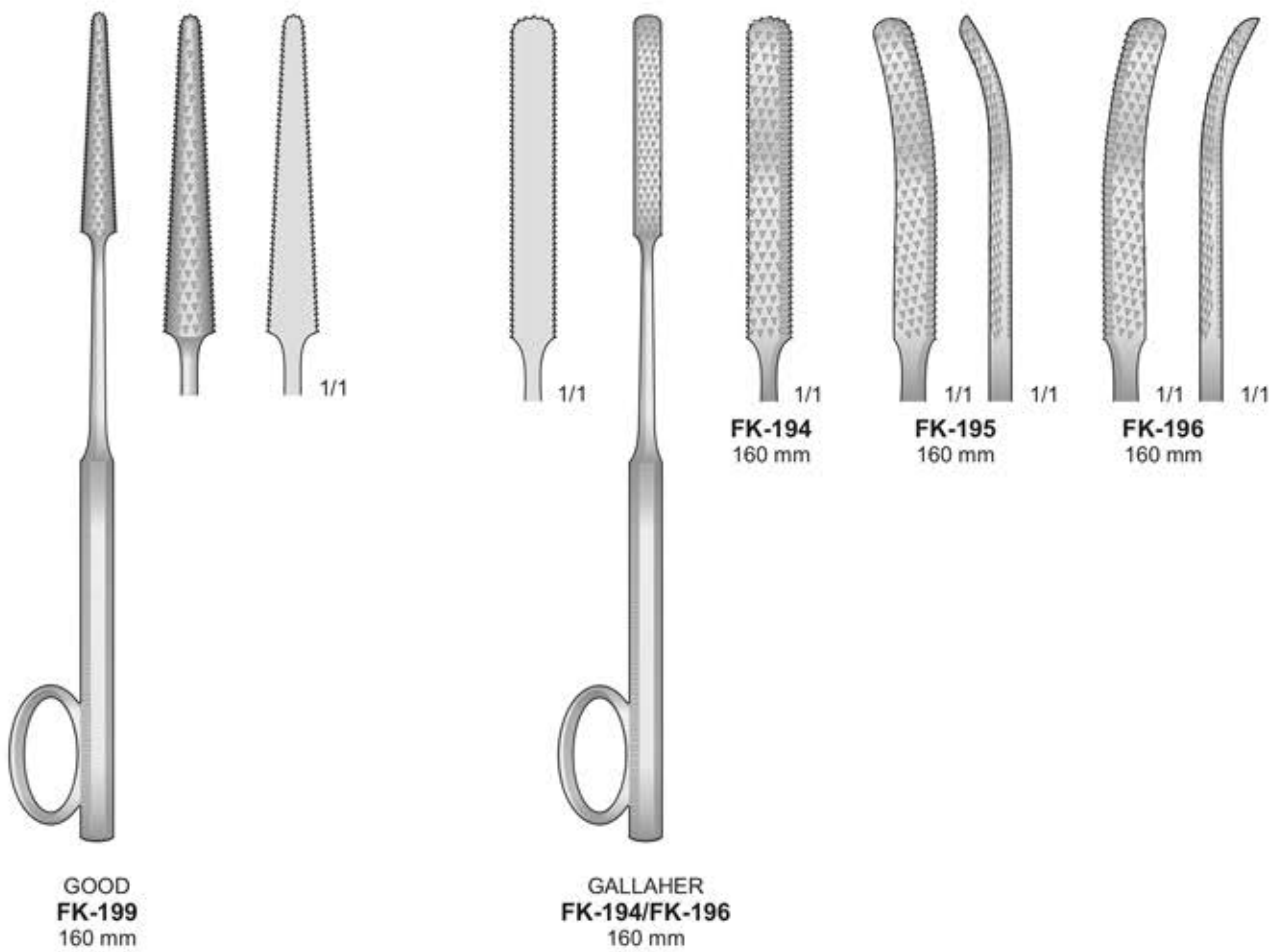



DO-267
190 mm

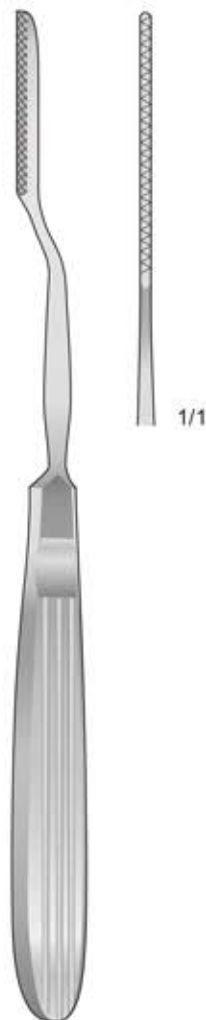

JOSEPH
DO-109
190 mm

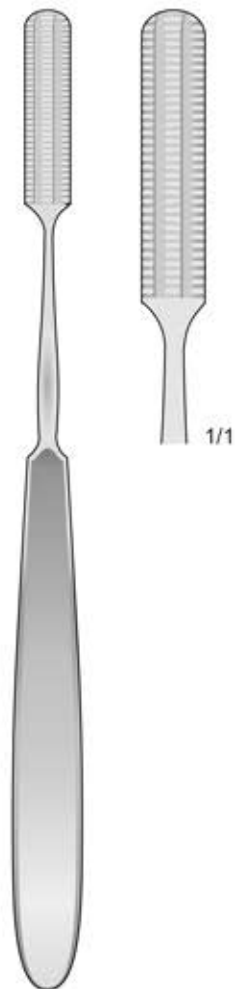

MALTZ
DO-179
180 mm

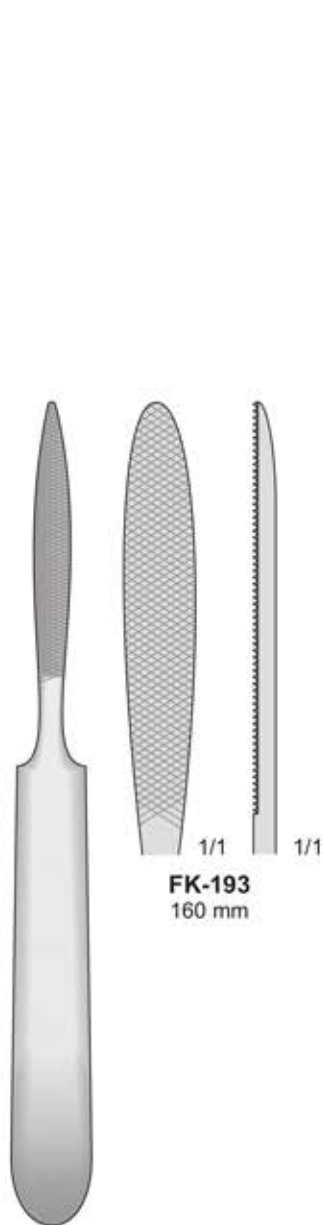

FK-193
160 mm

JOSEPH
FK-193
160 mm



FK-85
295 mm

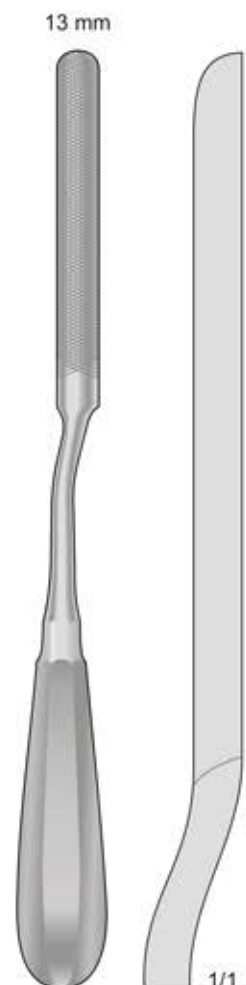

FK-86
240 mm

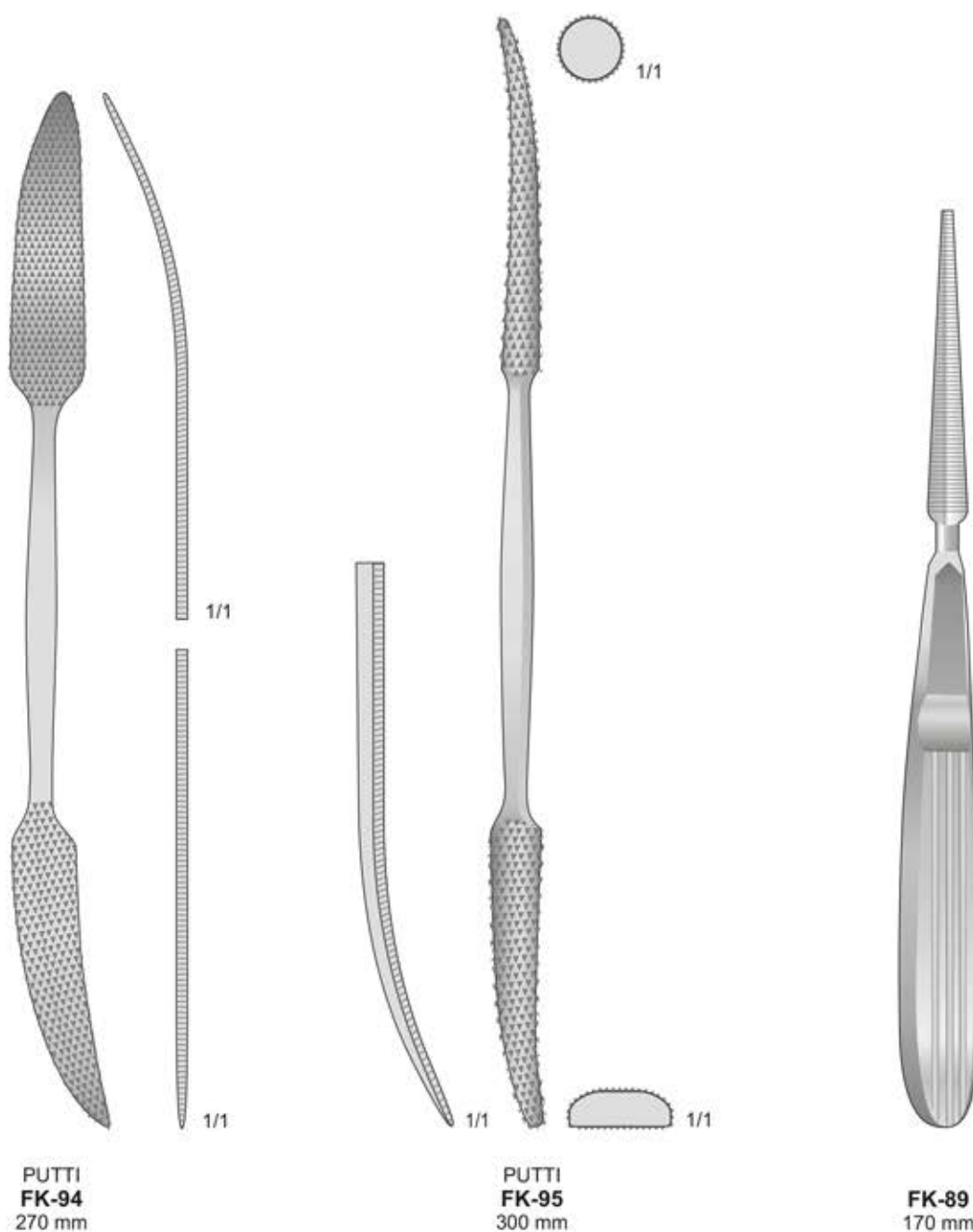

PUTTI
FK-94
270 mm

PUTTI
FK-95
300 mm

FK-89
170 mm

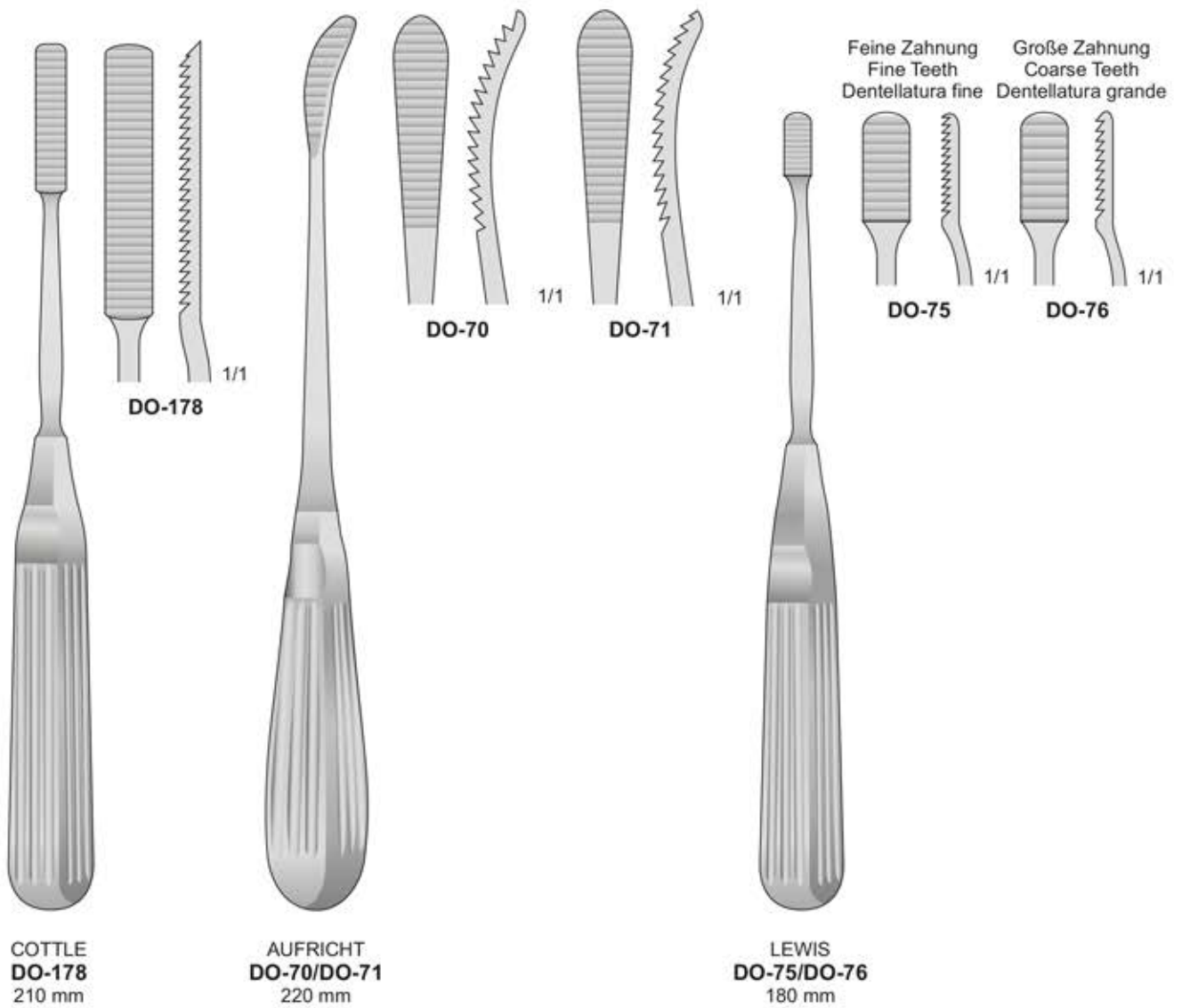

8 mm



8 mm

FK-96
210 mm

2 mm



5 mm

FK-97
210 mm

1/1



1/1

8 mm



8 mm

FK-98
210 mm

8 mm



8 mm

FK-99
210 mm

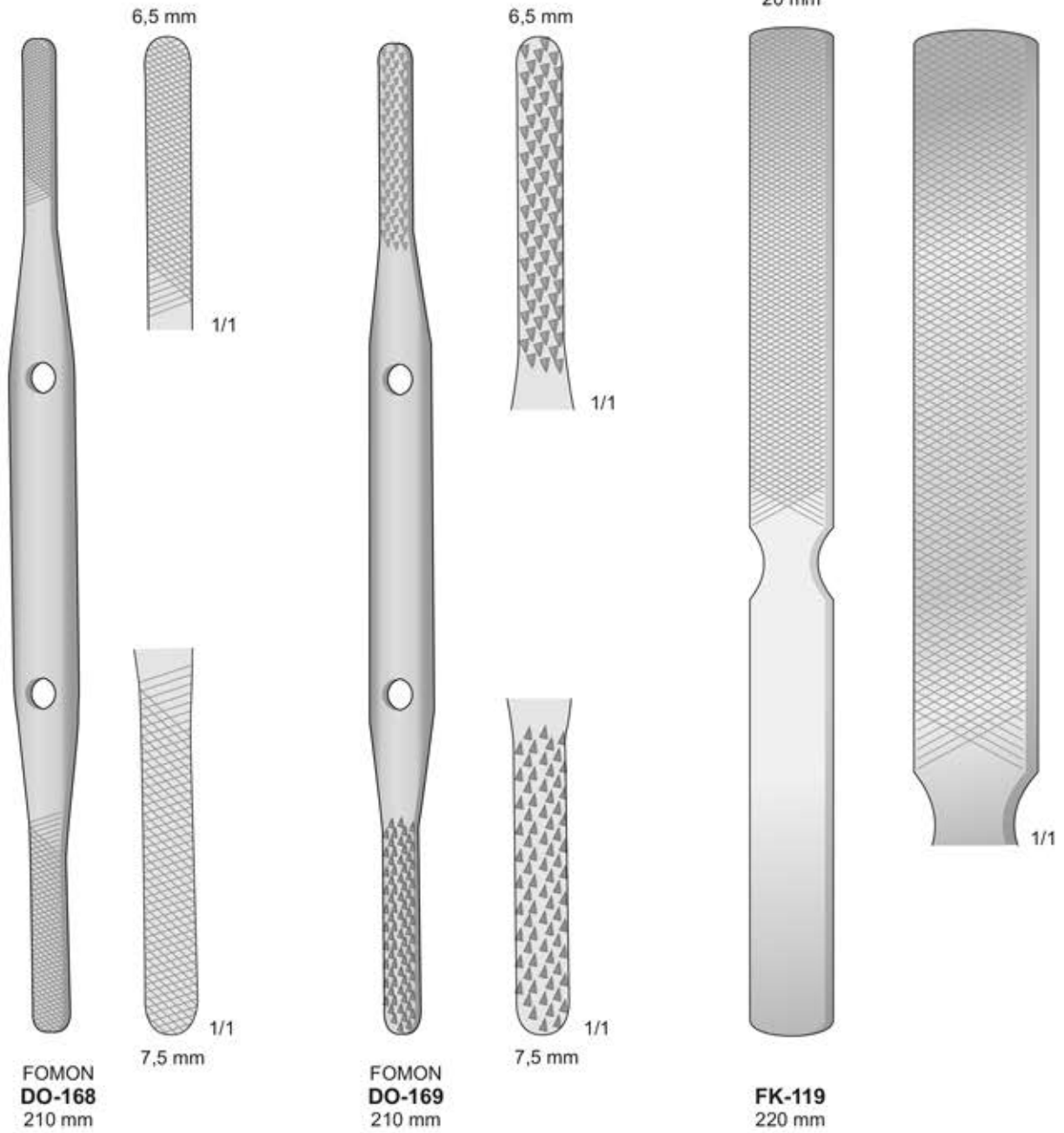

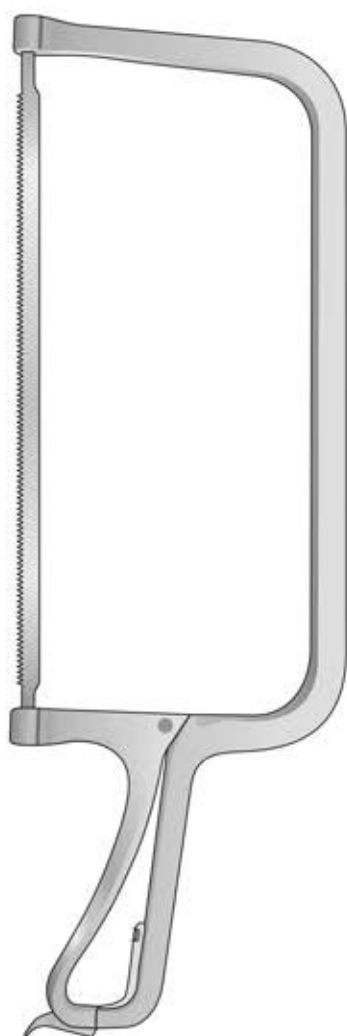

COLLIN
LS-300
390 mm

LS-300
Komplett mit 3 Sägen
Complete with 3 saws
Completa con 3 seghe
Completo con 3 sierras
Complet avec 3 scies

Fig.1



LS-301
280 mm

Fig.2



LS-302
280 mm

Fig.3



LS-303
280 mm



LINDEMANN
FK-243
200 mm



1/1



LANGENBECK
FK-244
235 mm

LS-233
 Komplet mit - Complete with
 Completo con - Completos con
 Completes avec:
 1 LS-236
 1 LS-229
 1 LS-241

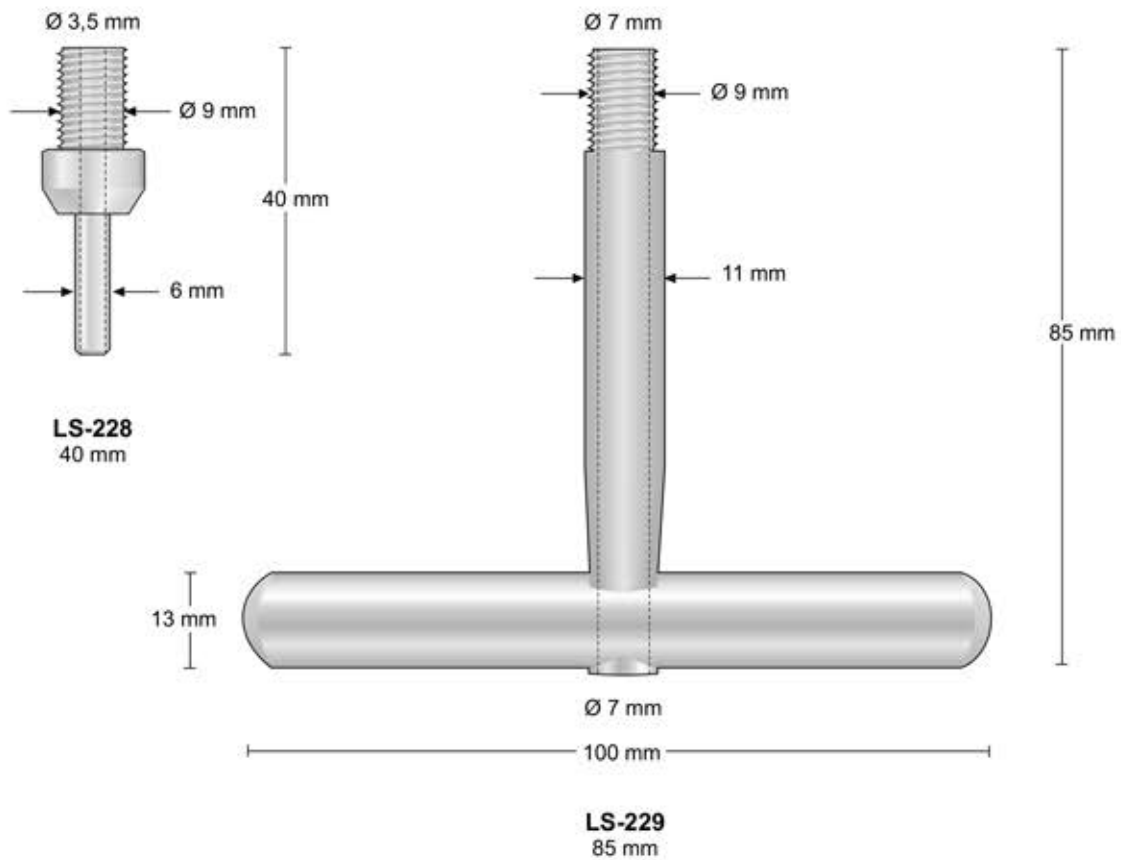
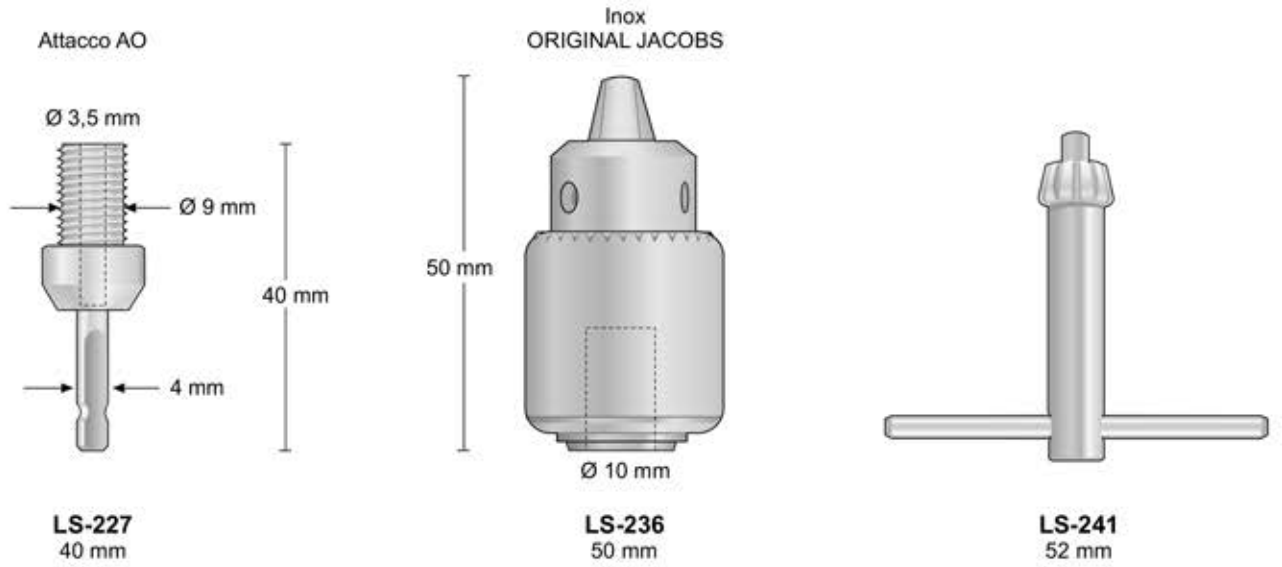

LS-239
 Komplet mit - Complete with
 Completo con - Completos con
 Completes avec:
 1 LS-236
 1 LS-237
 1 LS-238
 1 LS-241

Inox
 ORIGINAL JACOBS

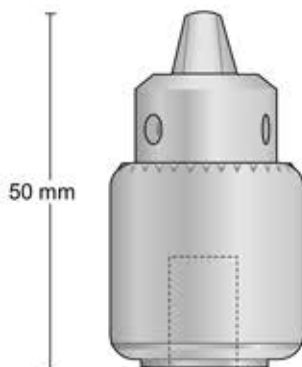

Ø 10 mm
LS-236
 50 mm

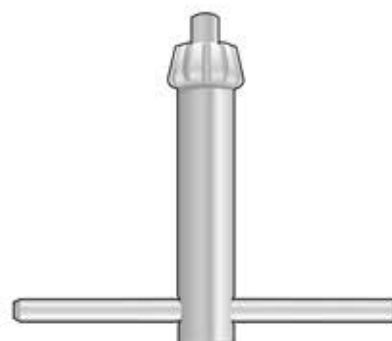

LS-241
 52 mm

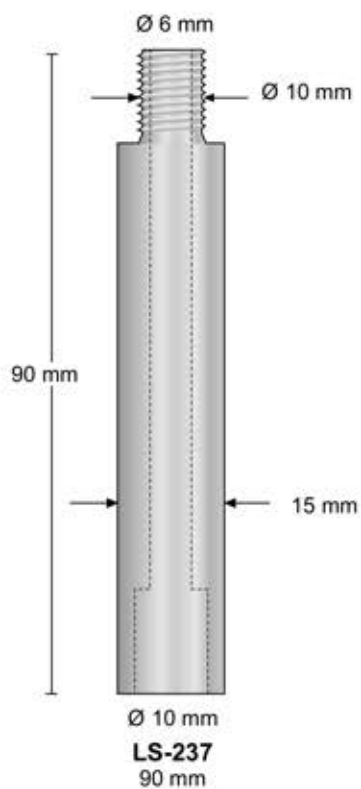

Ø 10 mm
LS-237
 90 mm

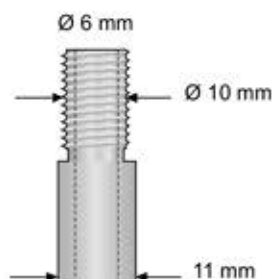

LS-238
 130 mm

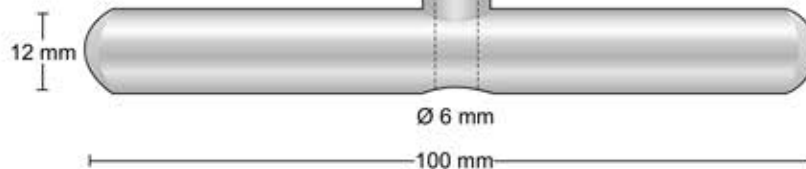

130 mm

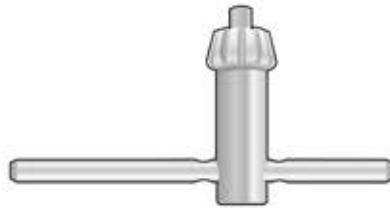

LS-231
32 mm

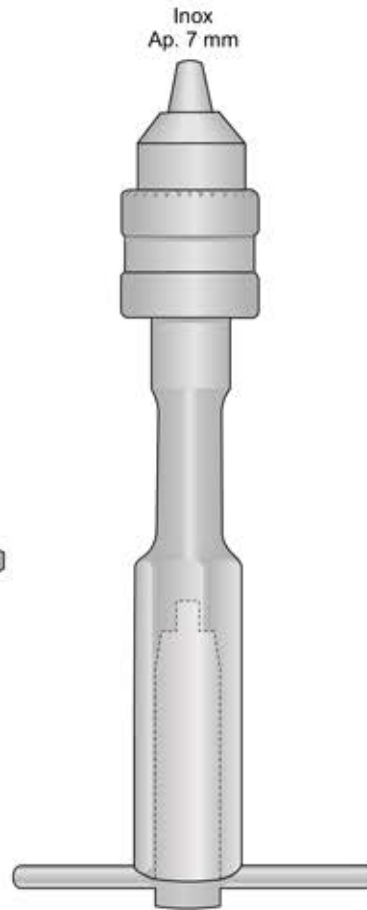

LS-232
130 mm

Von Handt zu spannen
Tightened by hand
Con chiusura a mano



LS-224
Mandrino solo

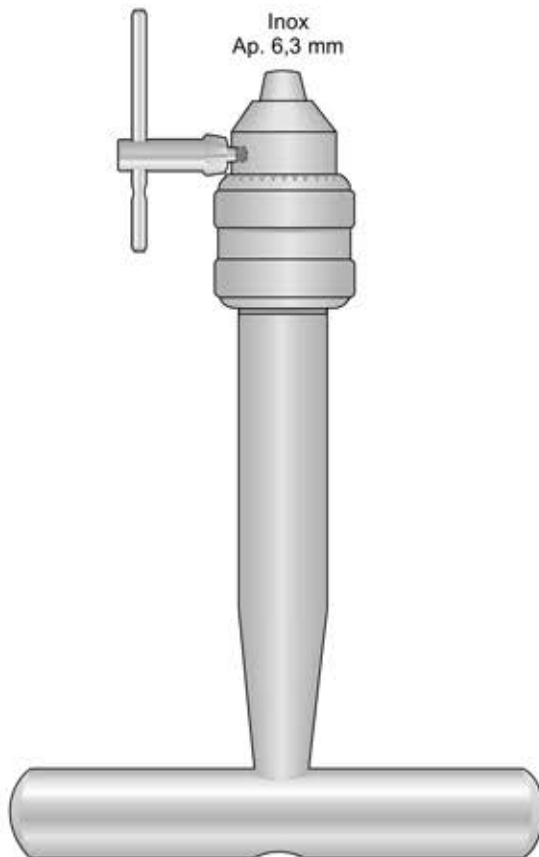

LS-230
130 mm

Von Handt zu spannen
Tightened by hand
Con chiusura a mano

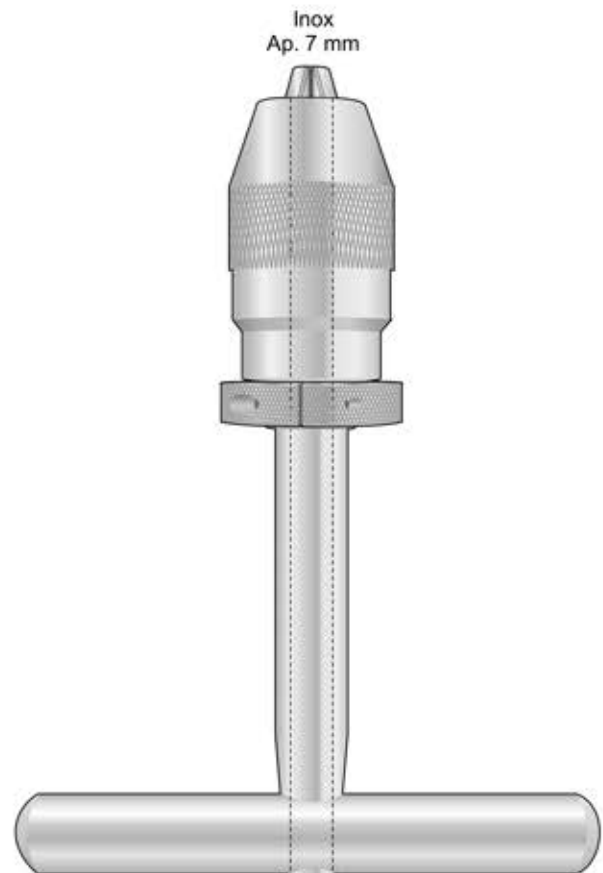

LS-234
135 mm



LS-96

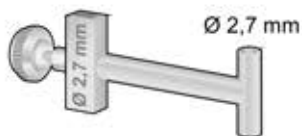

LS-97

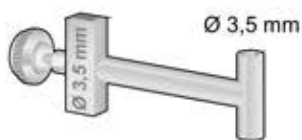

LS-98

Steckbohrbüchsen
Insert-drill
Centrapunte
Manicotto dentato



Ø Außen
Ø Outside
Ø Esterno
Ø Exterior
Ø Extérieur

Ø Für Bohrer
Ø For drills
Ø Per punte
Ø Para agujas
Ø Pour Mèches

Cod. Art.	Ø Außen	Ø Für Bohrer
LS-113	4,5 mm	3,2 mm
LS-114	3,5 mm	2 mm
LS-115	3,5 mm	2,7 mm

Gewebeschutzhülsen
Guida per punte elicoidali

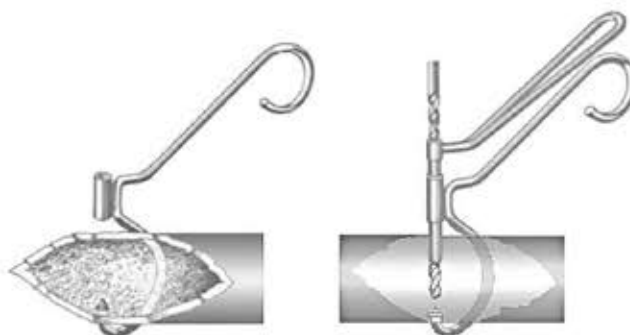

LS-95
Complete with 3 guide
Completo di 3 guide
LS-94+LS-96+LS-97+LS-98

LS-94
Drill guide only
Centratore solo

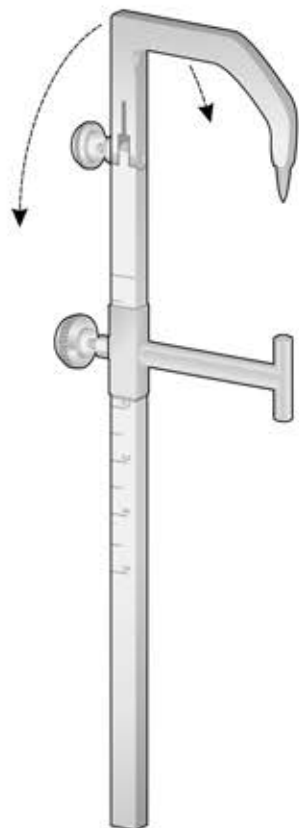

LS-95
145 mm

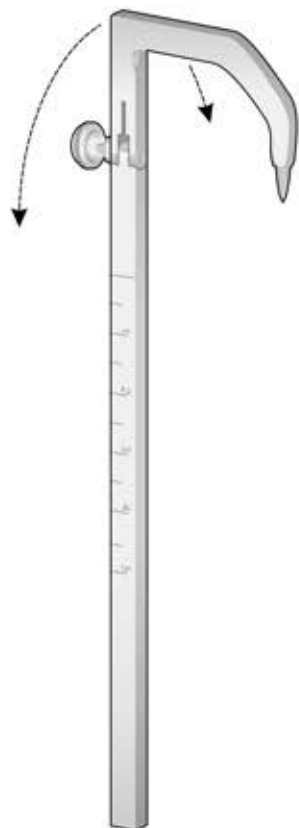

LS-94
145 mm

Innen Ø 6,5 mm
Inside Ø 6,5 mm
Interno Ø 6,5 mm
Interior Ø 6,5 mm
Intérieur Ø 6,5 mm

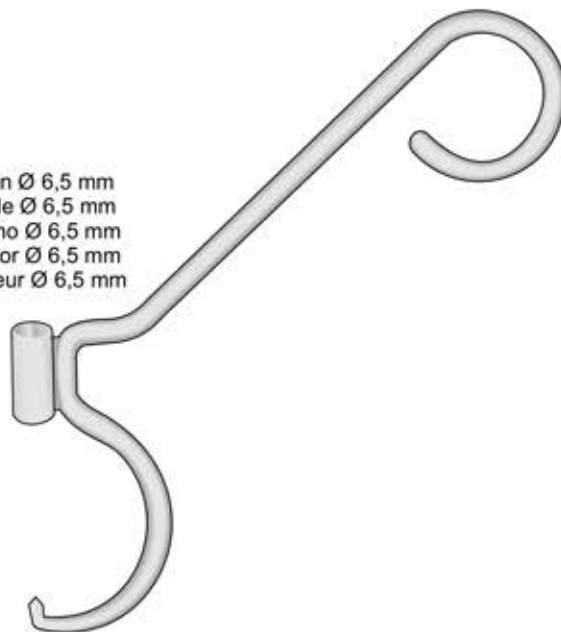

LS-112

Bohrbüchsen zu Knochenplatten - Drill guides - Centratori guida punte - Guide méche

Codificazione del colore

verde = centrico
oro = eccentrico

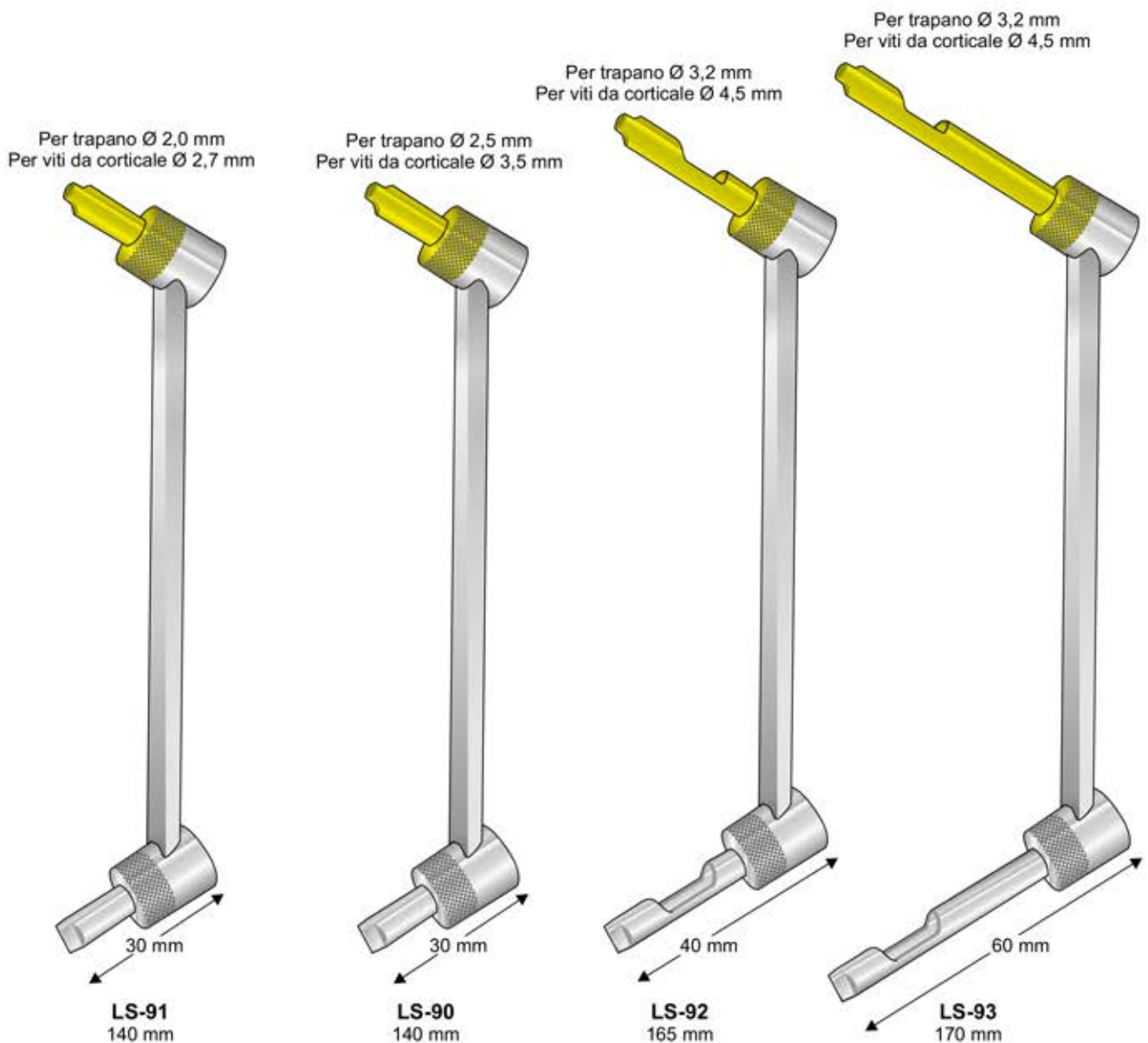

Bohrbüchsen zu Knochenplatten - Drill guides - Centratori guida punte - Guide méche

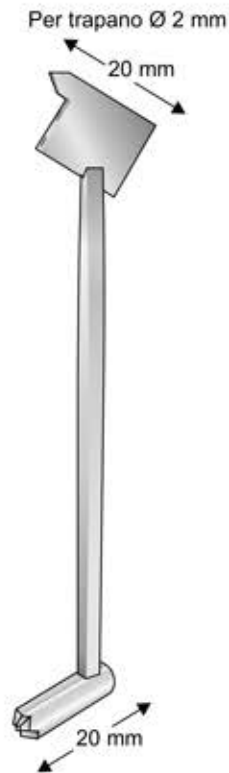

LS-80
110 mm

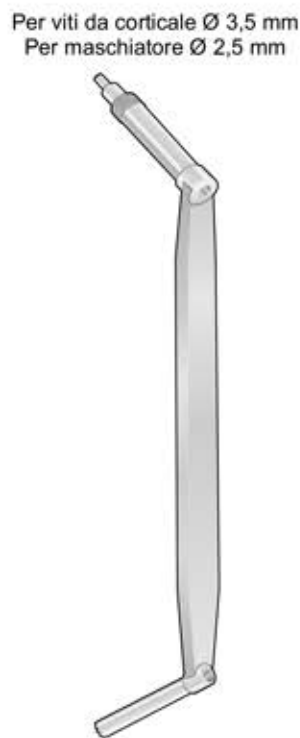

LS-81



LS-82

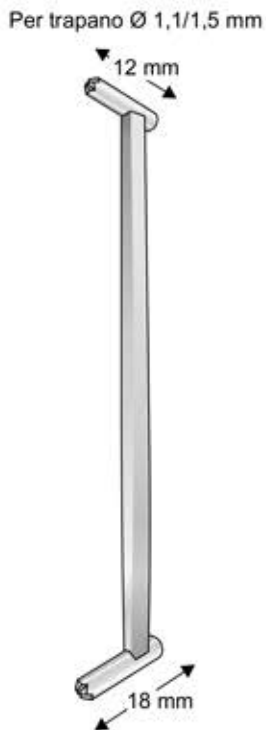

LS-83
105 mm

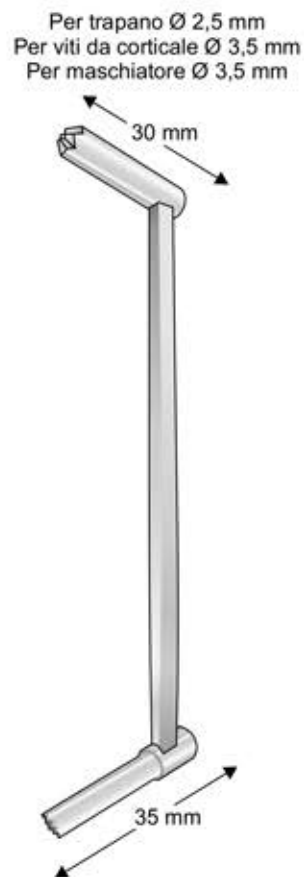

LS-84
125 mm

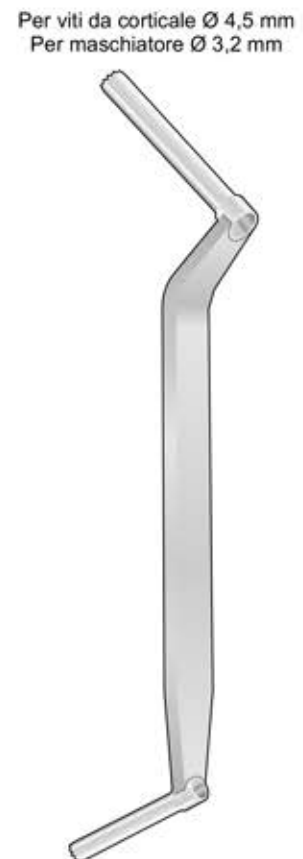

LS-85

Bohrbüchsen zu Knochenplatten - Drill guides - Centrori guida punte - Guide méche

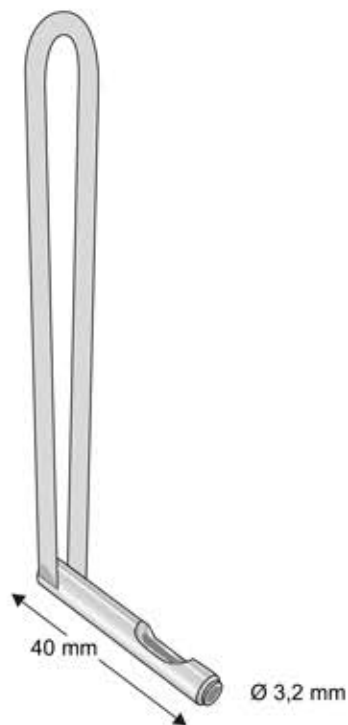

LS-117
125 mm

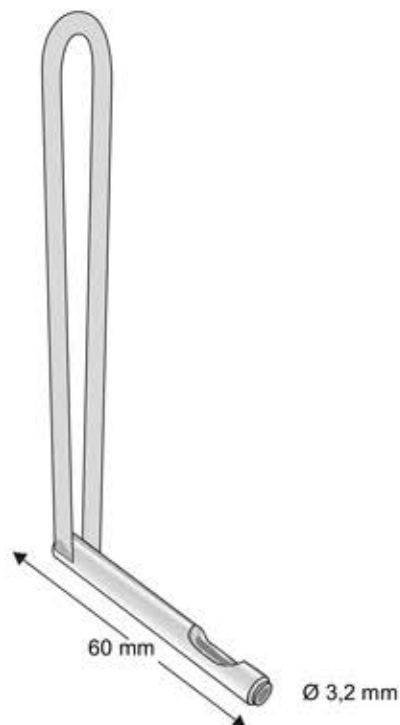

LS-124
125 mm

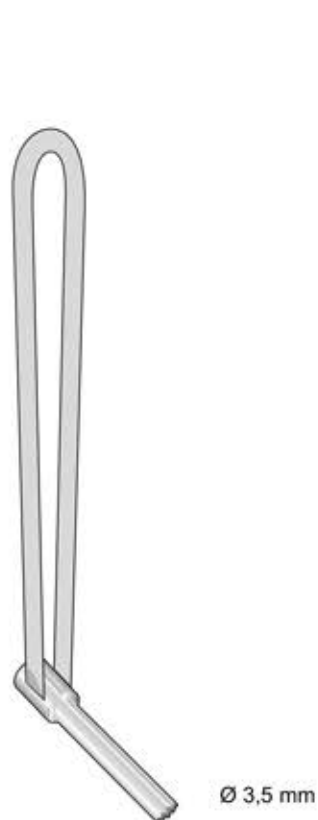

LS-116
125 mm

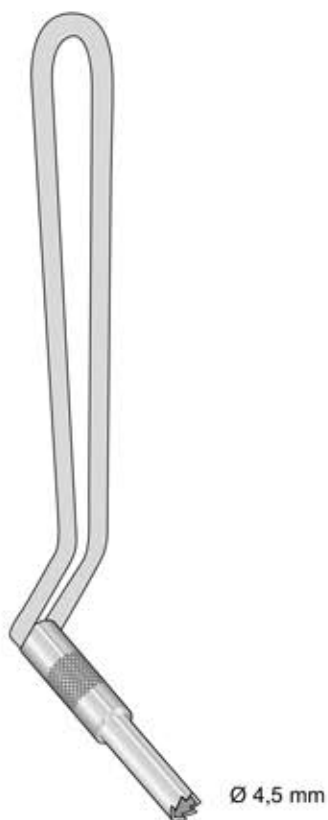

LS-119
150 mm

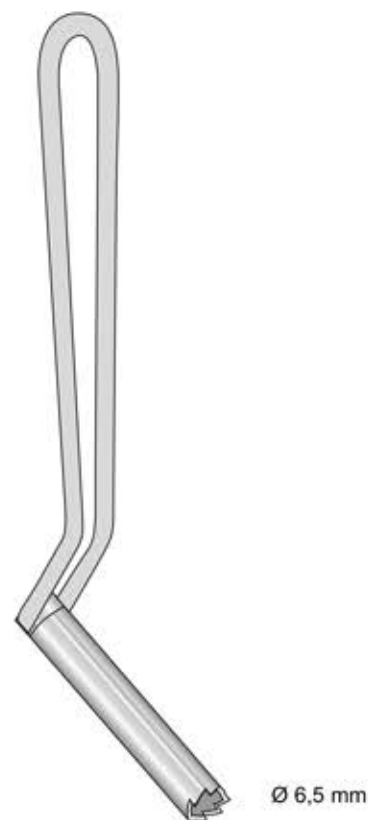

LS-121
150 mm

Handgriffe mit schnellspann futter
Handles with quick-action chuck
Manico con mandrino rapido
Poignées avec mandrins rapides

Ø 4 mm

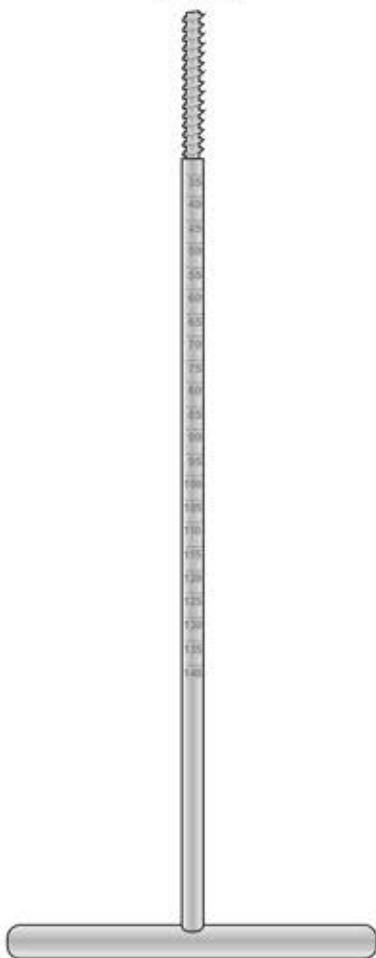

LS-120
260 mm

AO-Schaft



Dental-Schaft



4kant-Schaft



MANICO FERROZELL
LS-242
125 mm



LS-244
110 mm

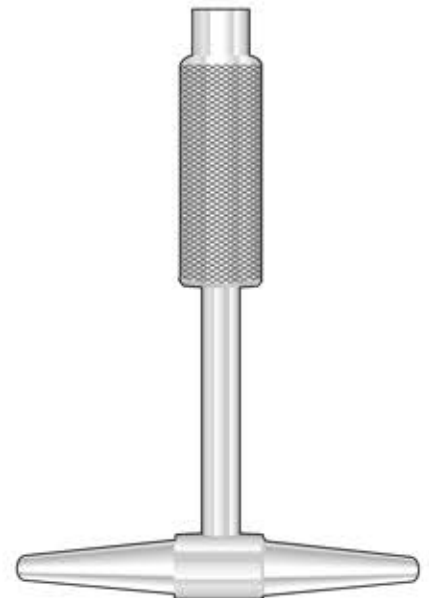

LS-240
80 mm

Fino a Ø 3 mm
Bis Ø 3 mm
Up to Ø 3 mm



WAGNER
LS-106
300 mm

Extraktionshaken
Extraction hooks
Gancio d'estrazione
Ganchos extractores
Crochets d'extraction

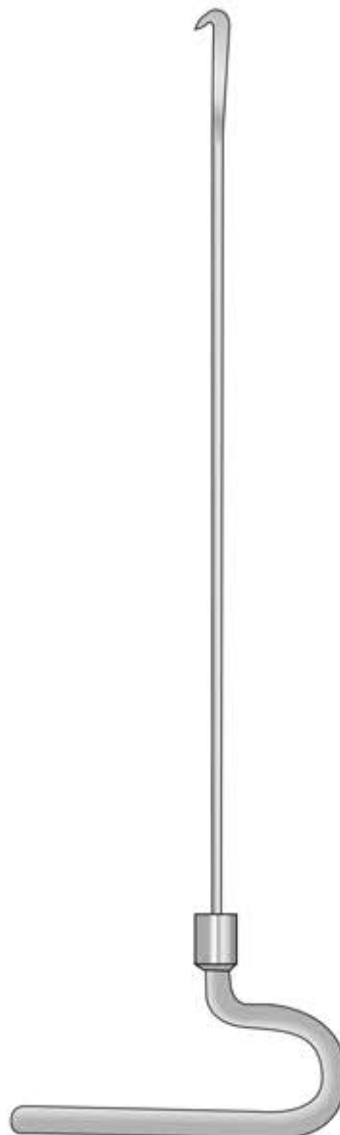

KI-306 - 290 mm
KI-307 - 370 mm
KI-308 - 420 mm



LS-100
120 mm



KÜNTSCHNER
FK-09
210 mm

Screw depth gauges, to select proper length of screw
Misuratore di lunghezza per viti
Instruments de mesure de profondeur pour déterminer la longueur de vis requise



LS-200
165 mm



LS-201
265 mm

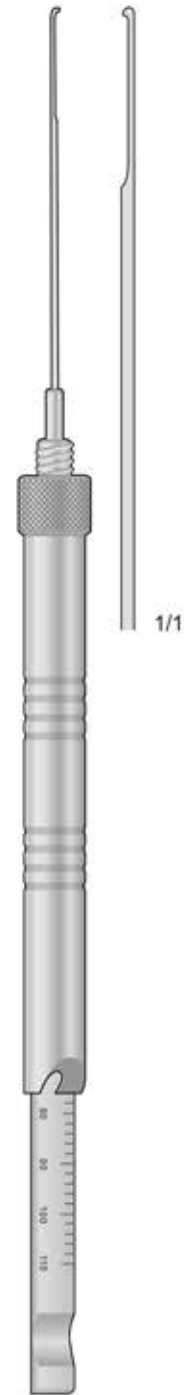

LS-202
280 mm

Schraubenzieher mit Ferrozellgriff
 Screws driver with Ferrozell handle
 Giraviti con manico di Ferrozell
 estornilladores con mango de Ferrozell
 D'Jeu de tournevis avec poignée en Ferrozell

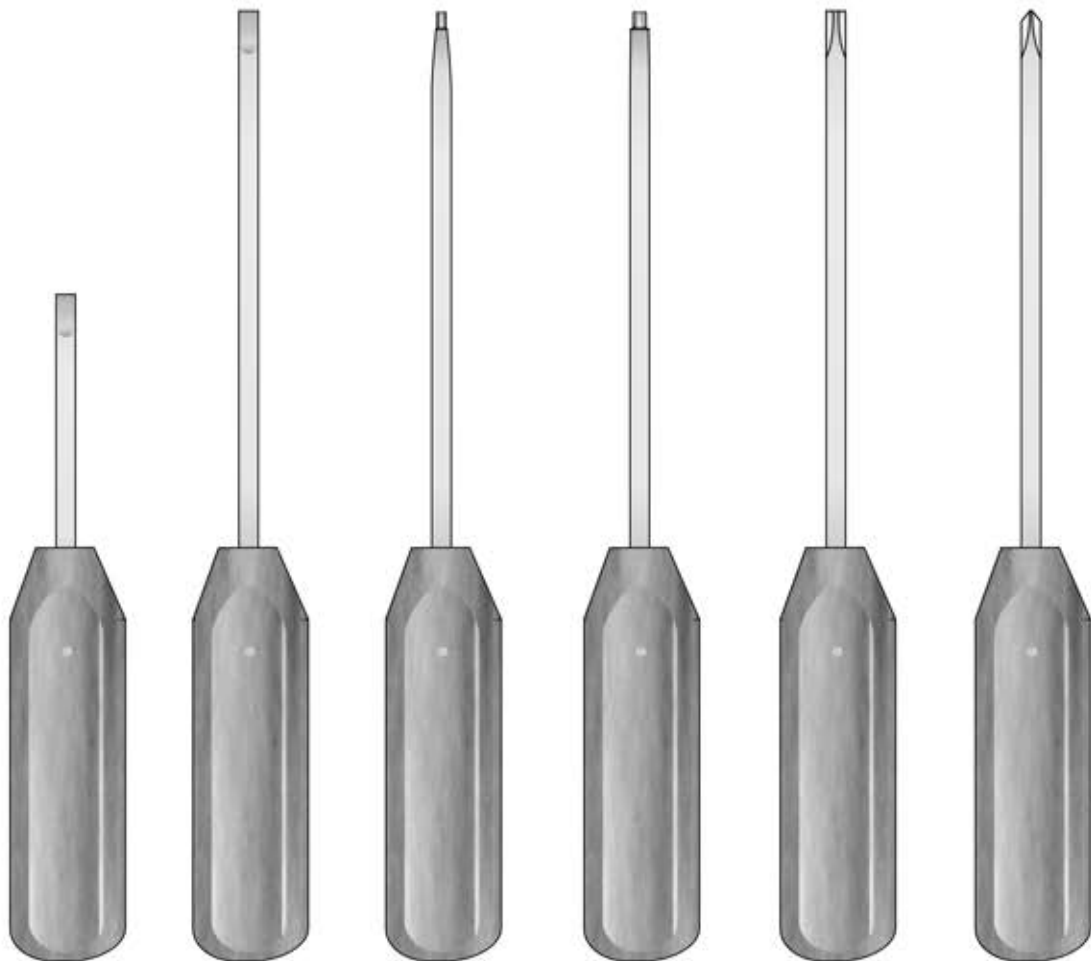
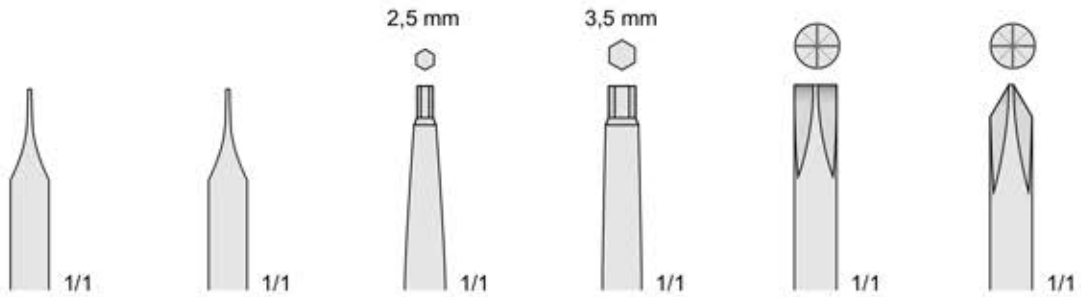

LS-310
170 mm

LANE LS-311
250 mm

LS-312
250 mm

LS-313
250 mm

LS-314
250 mm

PHILIPS LS-315
250 mm

Schraubenzieher, Set mit Etui - Box with screws driver - Scatola con set giraviti
Set destornilladores - Jeu de tournevis, en boîte

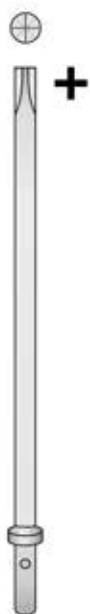

LS-321
140 mm



LS-322
140 mm

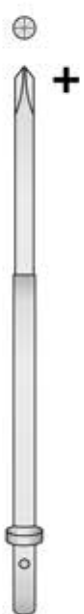

LS-323
140 mm



LS-324
140 mm

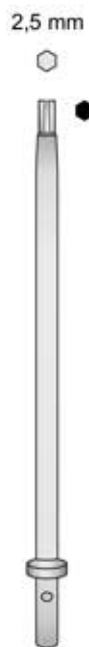

LS-325
140 mm



LS-326
140 mm

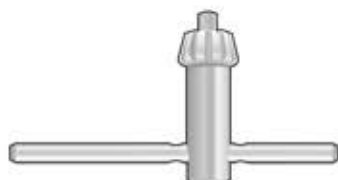

LS-231
32 mm



LS-320
145 mm



**UNIVERSAL
LS-235**
75 mm

LS-330
Schraubenzieher, Set mit Etui - Komplet
Box with screws driver - Complete
Scatola con set giraviti - Completo
Set destornilladores - Completos
Jeu de tournevis, en boîte - Complete

Etui allein
Box only
Solo scatola
Seul boîte



LS-329
200x100x40 mm

Schraubenzieher mit Ferrozellgriff
Screws driver with Ferrozell handle
Giraviti con manico di Ferrozell
estornilladores con mango de Ferrozell
D Jeu de tournevis avec poignée en Ferrozell

1,5 mm



LS-127
35 mm

2,5 mm



LS-128
50 mm

+ 1,5-2,5 mm



LS-316
195 mm

o 1,5 mm



LS-317
195 mm

o 2,5 mm



LS-318
195 mm

Nadelhalter, Stahldrahtzangen - Needle holders, steel wire forceps
 Port'aghi, pinze per fili d'acciaio - Porta agujas, pinzas para hilos de acero
 Porte aiguilles, pinces à saisir fils d'acier

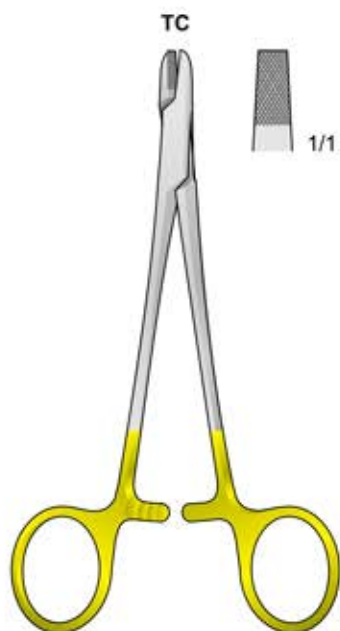

PH-58
150 mm

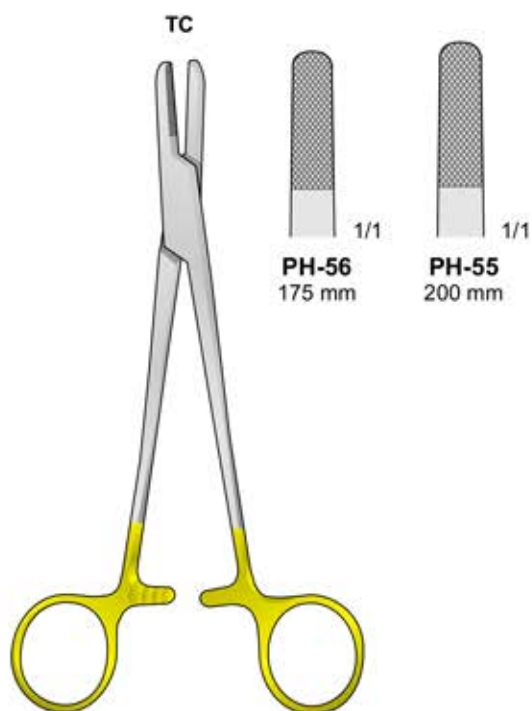

PH-55/PH-56

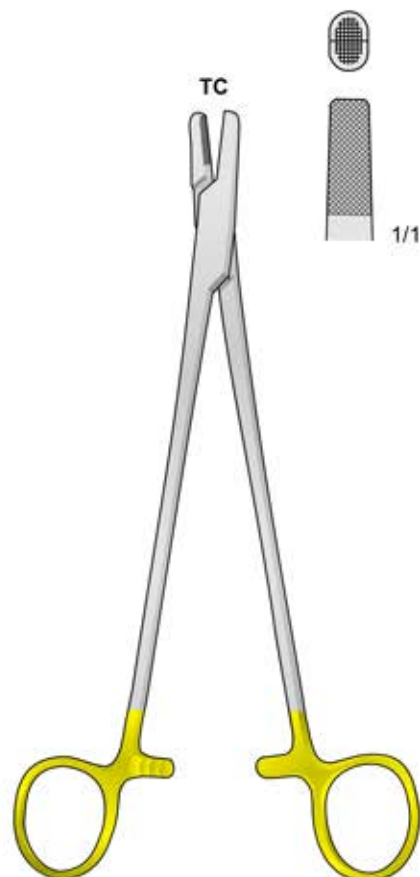

BAUMGARTNER
PH-57
200 mm

Draht-und Bleischere gezahntF - Wire cutting scissor serrated
orbice universale dentellata - Tijeras para cortar hilo de acero dentadas
Ciseaux à couper les fils métalliques

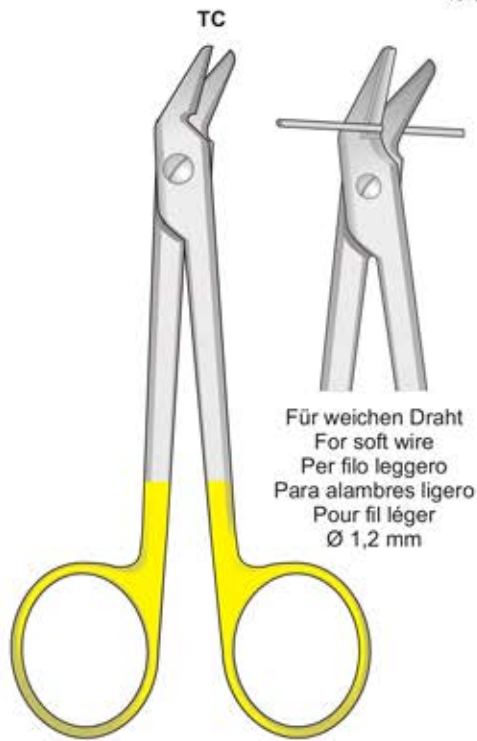

Für weichen Draht
For soft wire
Per filo leggero
Para alambres ligero
Pour fil léger
Ø 1,2 mm

DP-120
120 mm

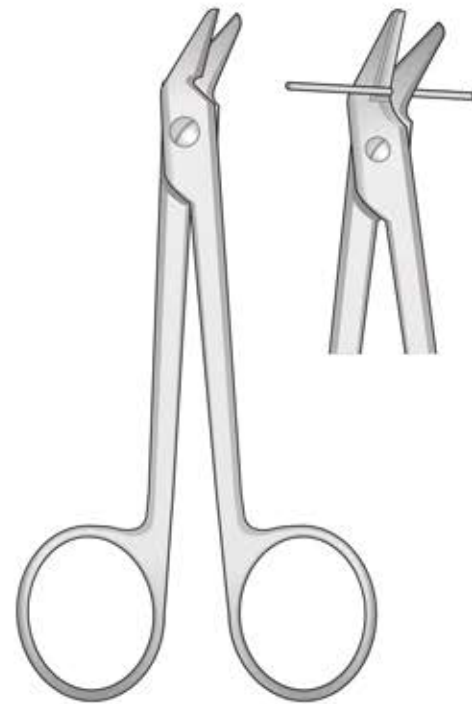

DP-90
120 mm

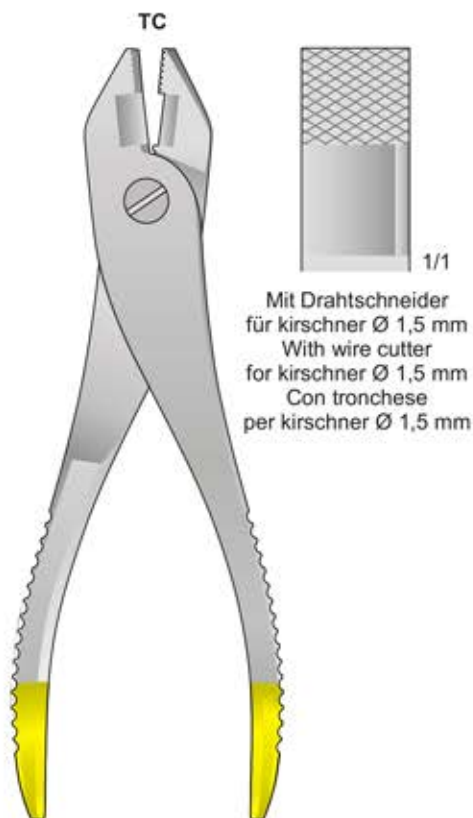

Mit Drahtschneider
für kirschner Ø 1,5 mm
With wire cutter
for kirschner Ø 1,5 mm
Con tronchese
per kirschner Ø 1,5 mm

LX-125
220 mm

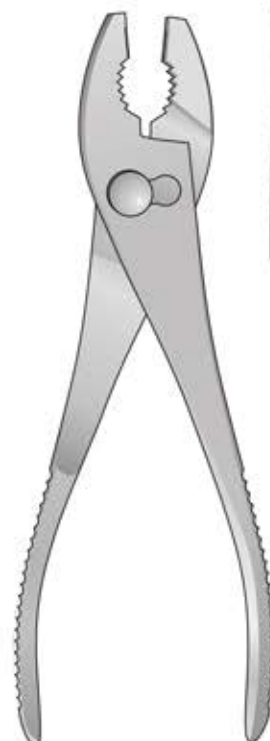

VH-40
200 mm

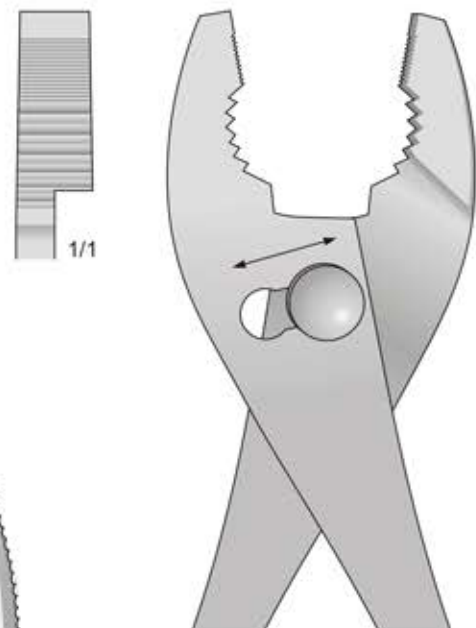

Für harten Draht bis \varnothing 0,4 mm - For hard wire with \varnothing 0,4 mm
 Per fili duri di \varnothing 0,4 mm - Para alambres duros de \varnothing 0,4 mm
 Pour fils durs avec \varnothing 0,4 mm

Für harten Draht bis \varnothing 1 mm - For hard wire with \varnothing 1 mm
 Per filo duro \varnothing 1 mm - Para alambres duro \varnothing 1 mm
 Pour fil dur avec \varnothing 1 mm

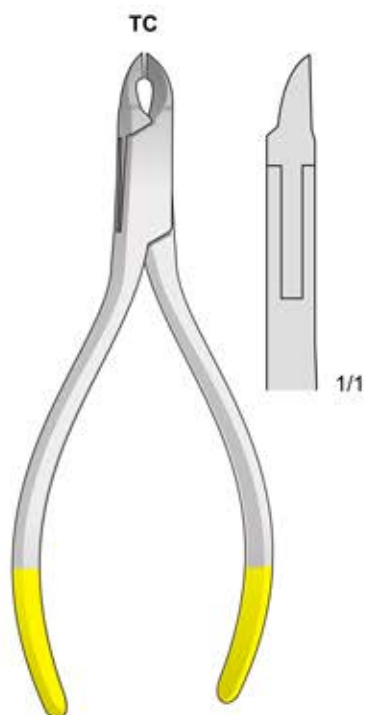

ANGLE
LX-95TC
 130 mm

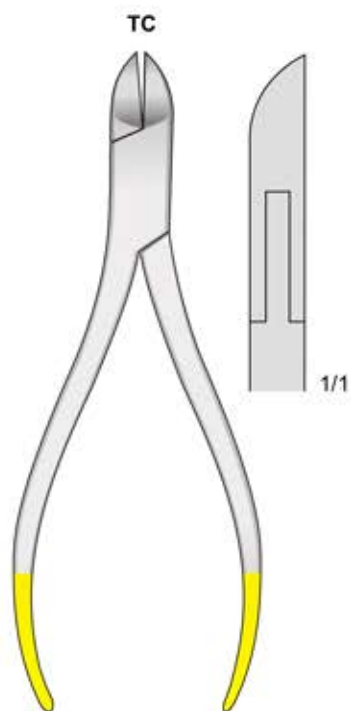

LX-99
 130 mm

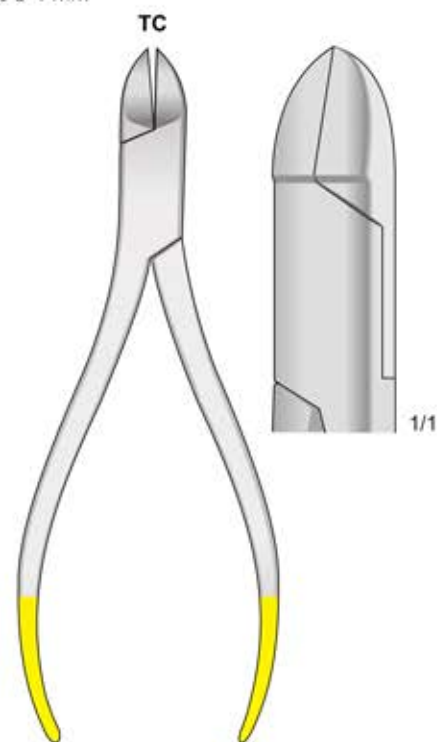

LX-96TC
 150 mm

Für harten Draht bis \varnothing 1 mm - For hard wire with \varnothing 1 mm
 Per filo duro \varnothing 1 mm - Para alambres duro \varnothing 1 mm
 Pour fil dur avec \varnothing 1 mm

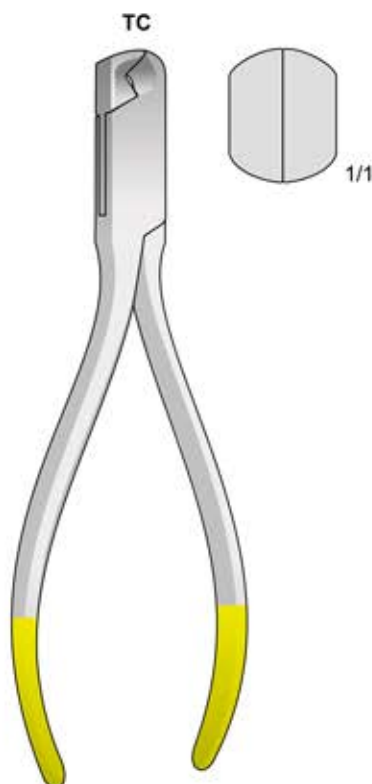

LX-92TC
 145 mm



LX-82
 185 mm

Für harten Draht bis \varnothing 1,7 mm - For hard wire with \varnothing 1,7 mm
 Per filo duro \varnothing 1,7 mm - Para alambres duro \varnothing 1,7 mm
 Pour fil dur avec \varnothing 1,7 mm

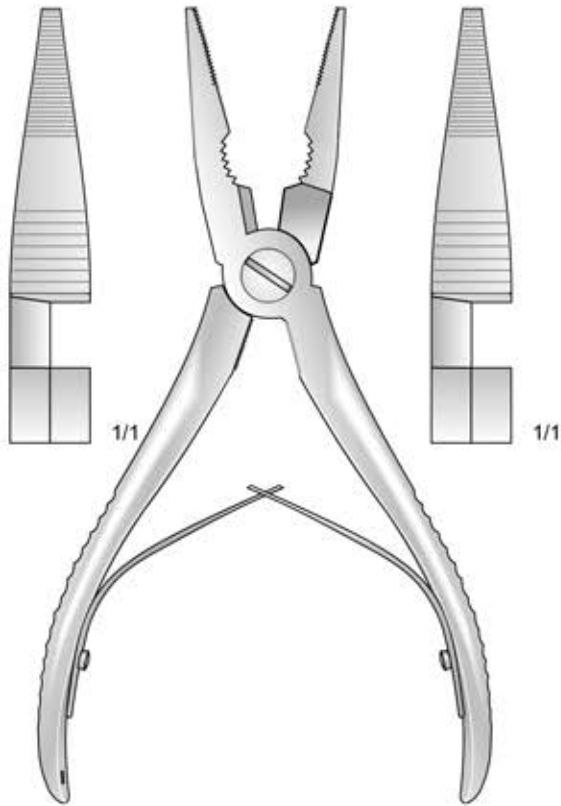

LX-135
175 mm

Parallel-Flachzange - Flat-nosed pliers, parallel
Pinza a branche parallèle - Alicates planos - Pincers plates

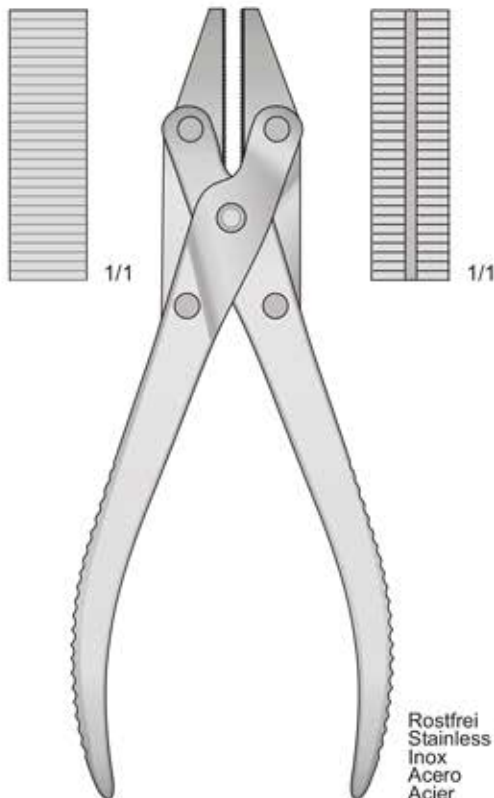

VH-25
185 mm

Rostfrei
Stainless Steel
Inox
Acero
Acier

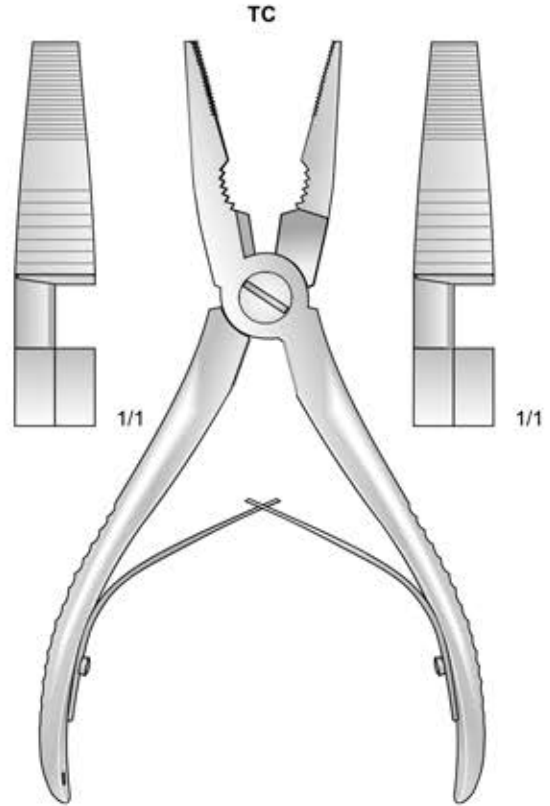

LX-136
165 mm

Parallel-Flachzange mit Seitenschneider
Flat-nose pliers parallel with lateral wire cutter
Pinza a branche parallèle con tronchese

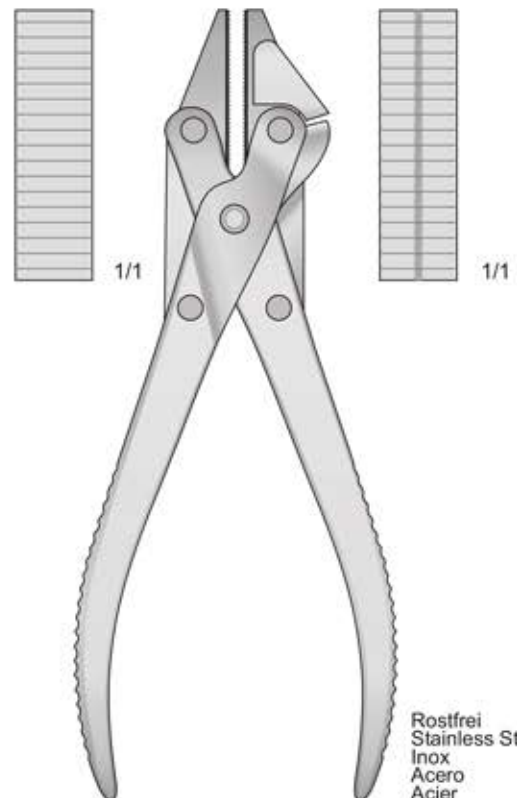

LX-80
185 mm

Rostfrei
Stainless Steel
Inox
Acero
Acier

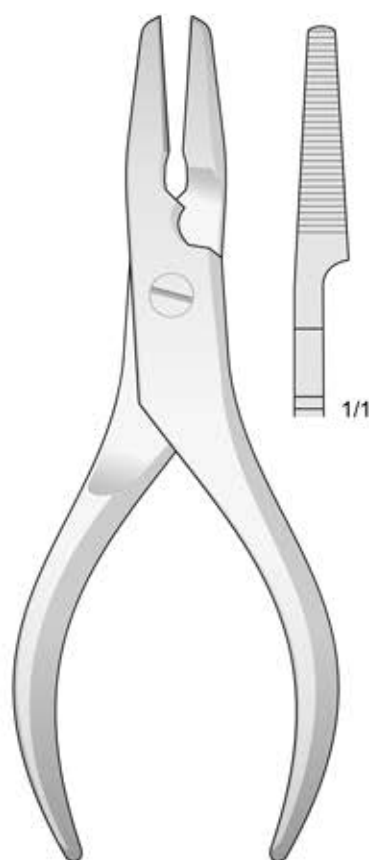

LX-134
160 mm

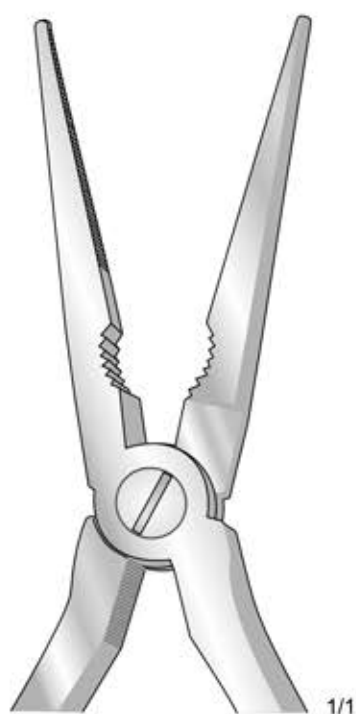

LX-137
200 mm

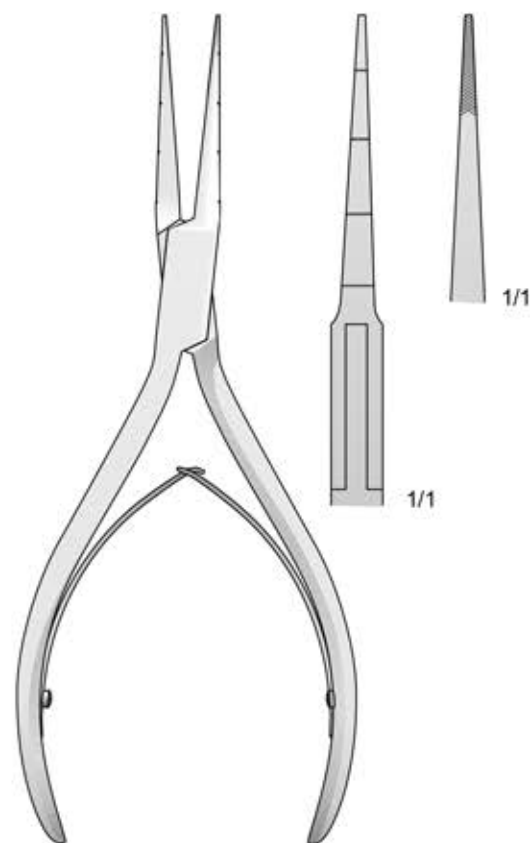

DP-96
150 mm

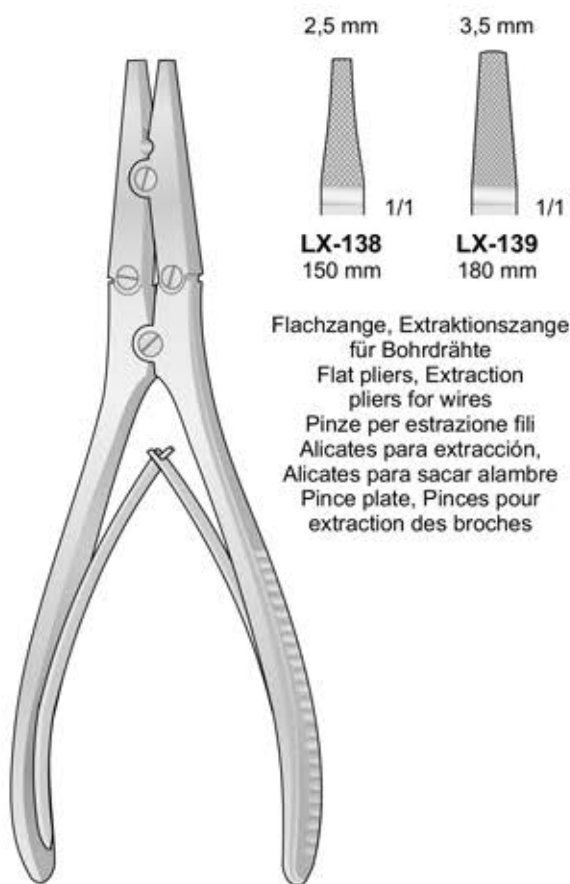

2,5 mm 3,5 mm
1/1 1/1
LX-138 **LX-139**
150 mm 180 mm

Flachzange, Extraktionszange
für Bohrdrähte
Flat pliers, Extraction
pliers for wires
Pinze per estrazione fili
Alicates para extracción,
Alicates para sacar alambre
Pince plate, Pinces pour
extraction des broches

LX-138/LX-139

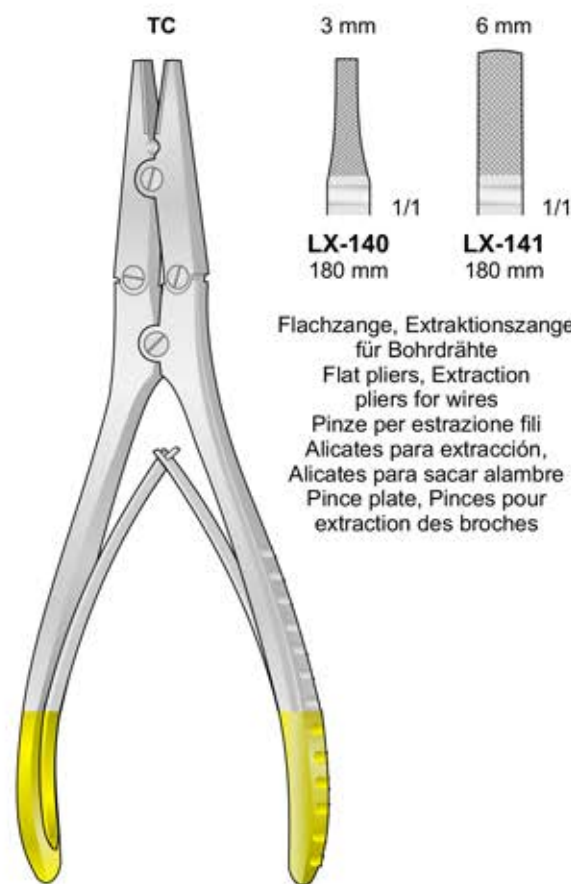

TC 3 mm 6 mm
1/1 1/1
LX-140 **LX-141**
180 mm 180 mm

Flachzange, Extraktionszange
für Bohrdrähte
Flat pliers, Extraction
pliers for wires
Pinze per estrazione fili
Alicates para extracción,
Alicates para sacar alambre
Pince plate, Pinces pour
extraction des broches

LX-140/LX-141

Biegezange - Bending pliers - Pinze piegaplacche - Pinces à plier



LS-405
200 mm



LS-406
240 mm

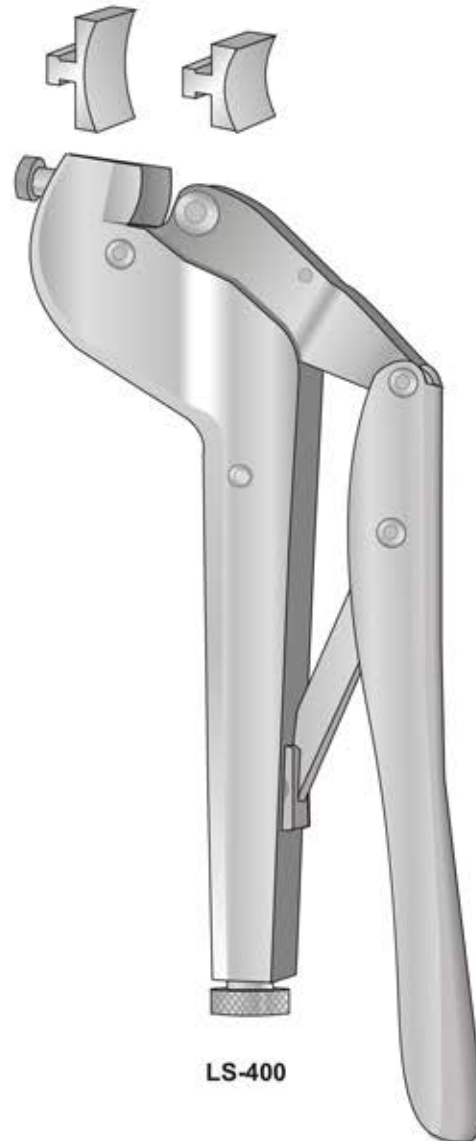

LS-400

Biegepresse - Bending press - Pressa piegaplacche - Presse pour plier

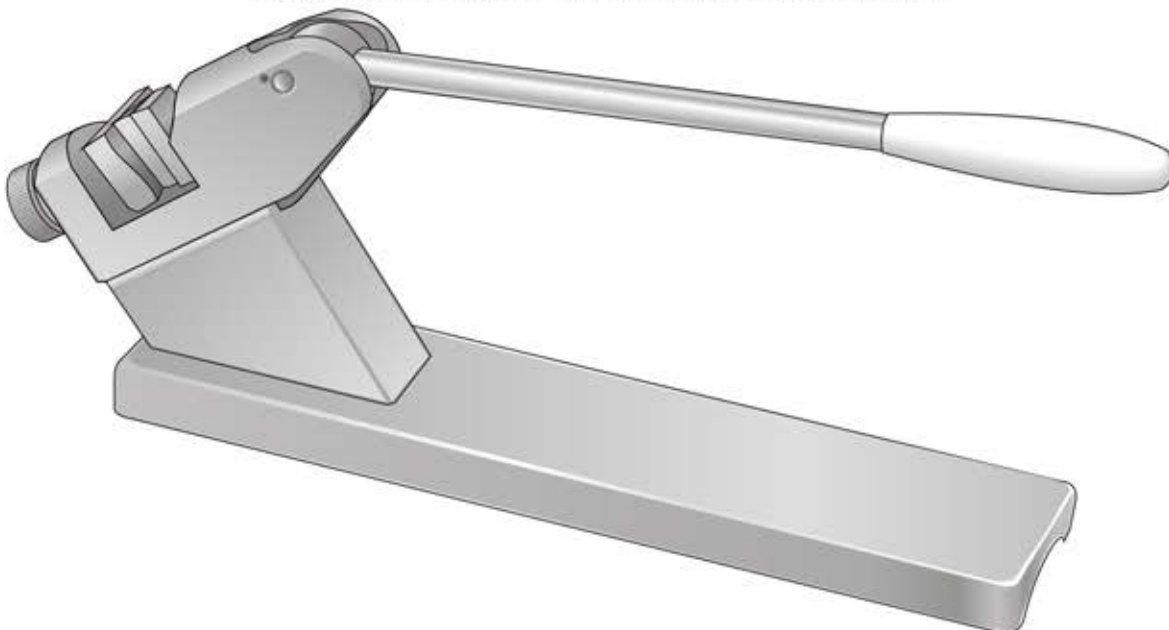

LS-410



KIRSCHNER
Trokarspitze
Trocar point
Punta trequarti
Punta de tròcar
Pointe de Trocart



KIRSCHNER
Trokarspitze
Trocar point
Punta trequarti
Punta de tròcar
Pointe de Trocart



KIRSCHNER
Lanzenspitze
Lance point
Punte lanceolate
Punta lanceolar
Pointe lancette

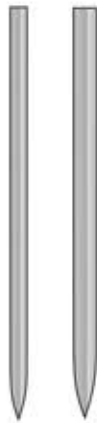

Trokarspitze
Trocar point
Punta trequarti
Punta de tròcar
Pointe de Trocart

310 mm



Rundes ende
Round shaft
Punta rotonda
Punta redonda
Pointe ronde

310 mm



Lanzenspitze
Lance point
Punte lanceolate
Punta lanceolar
Pointe lancette

310 mm

Ø/Diam.	Conf. 10 pz.
0,8 mm	KI-99
1,0 mm	KI-100
1,2 mm	KI-102
1,4 mm	KI-114
1,5 mm	KI-115
1,6 mm	KI-116
1,7 mm	KI-117
1,8 mm	KI-118
2,0 mm	KI-120
2,2 mm	KI-122
2,5 mm	KI-125
3,0 mm	KI-130

Ø/Diam.	Conf. 10 pz.
0,8 mm	KI-00
1,0 mm	KI-01
1,2 mm	KI-02
1,4 mm	KI-14
1,5 mm	KI-15
1,6 mm	KI-16
1,7 mm	KI-17
1,8 mm	KI-18
2,0 mm	KI-20
2,2 mm	KI-22
2,5 mm	KI-25
3,0 mm	KI-30

Ø/Diam.	Conf. 10 pz.
0,8 mm	KI-40
1,0 mm	KI-41
1,2 mm	KI-42
1,5 mm	KI-43
1,6 mm	KI-44
1,8 mm	KI-45
2,0 mm	KI-46
2,2 mm	KI-47
2,5 mm	KI-48
3,0 mm	KI-49



KIRSCHNER
 Trokarspitze
 Trocar point
 Punta trequarti
 Punta de tròcar
 Pointe de Trocart



KIRSCHNER
 Trokarspitze
 Trocar point
 Punta trequarti
 Punta de tròcar
 Pointe de Trocart



KIRSCHNER
 Lanzenspitze
 Lance point
 Punta lanceolate
 Punta lanceolar
 Pointe lancette



Rundes ende
 Round shaft
 Punta rotonda
 Punta redonda
 Pointe ronde

150 mm



Trokarspitze
 Trocar point
 Punta trequarti
 Punta de tròcar
 Pointe de Trocart

150 mm



Lanzenspitze
 Lance point
 Punta lanceolate
 Punta lanceolar
 Pointe lancette

150 mm

Ø/Diam.	Conf. 10 pz.
0,8 mm	KI-69
1,0 mm	KI-70
1,2 mm	KI-72
1,4 mm	KI-74
1,5 mm	KI-75
1,6 mm	KI-76
1,7 mm	KI-77
1,8 mm	KI-78
2,0 mm	KI-80
2,2 mm	KI-82
2,5 mm	KI-85
3,0 mm	KI-90

Ø/Diam.	Conf. 10 pz.
0,8 mm	KI-60
1,0 mm	KI-61
1,2 mm	KI-62
1,4 mm	KI-63
1,6 mm	KI-64
1,8 mm	KI-65
2,0 mm	KI-66
2,2 mm	KI-67
2,5 mm	KI-68
3,0 mm	KI-71

Ø/Diam.	Conf. 10 pz.
0,8 mm	KI-29
1,0 mm	KI-31
1,2 mm	KI-32
1,5 mm	KI-33
1,6 mm	KI-34
1,8 mm	KI-35
2,0 mm	KI-36
2,2 mm	KI-37
2,5 mm	KI-38
3,0 mm	KI-39

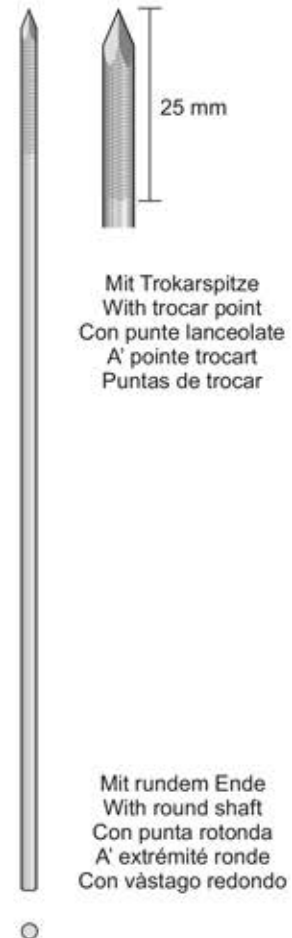

KIRSCHNER			
Codice	Ø mm	Lung.	Lung. filo
KI-220	1,5	150	5
KI-221	1,6	150	15
KI-222	2	150	15
KI-223	2	200	15

KIRSCHNER			
Codice	Ø mm	Lung.	Lung. filo
KI-224	2,5	200	25
KI-225	2,5	230	25
KI-226	2,5	300	25
KI-227	3,0	300	25
KI-228	3,5	300	25
KI-229	4,0	260	25
KI-233	4,5	300	25

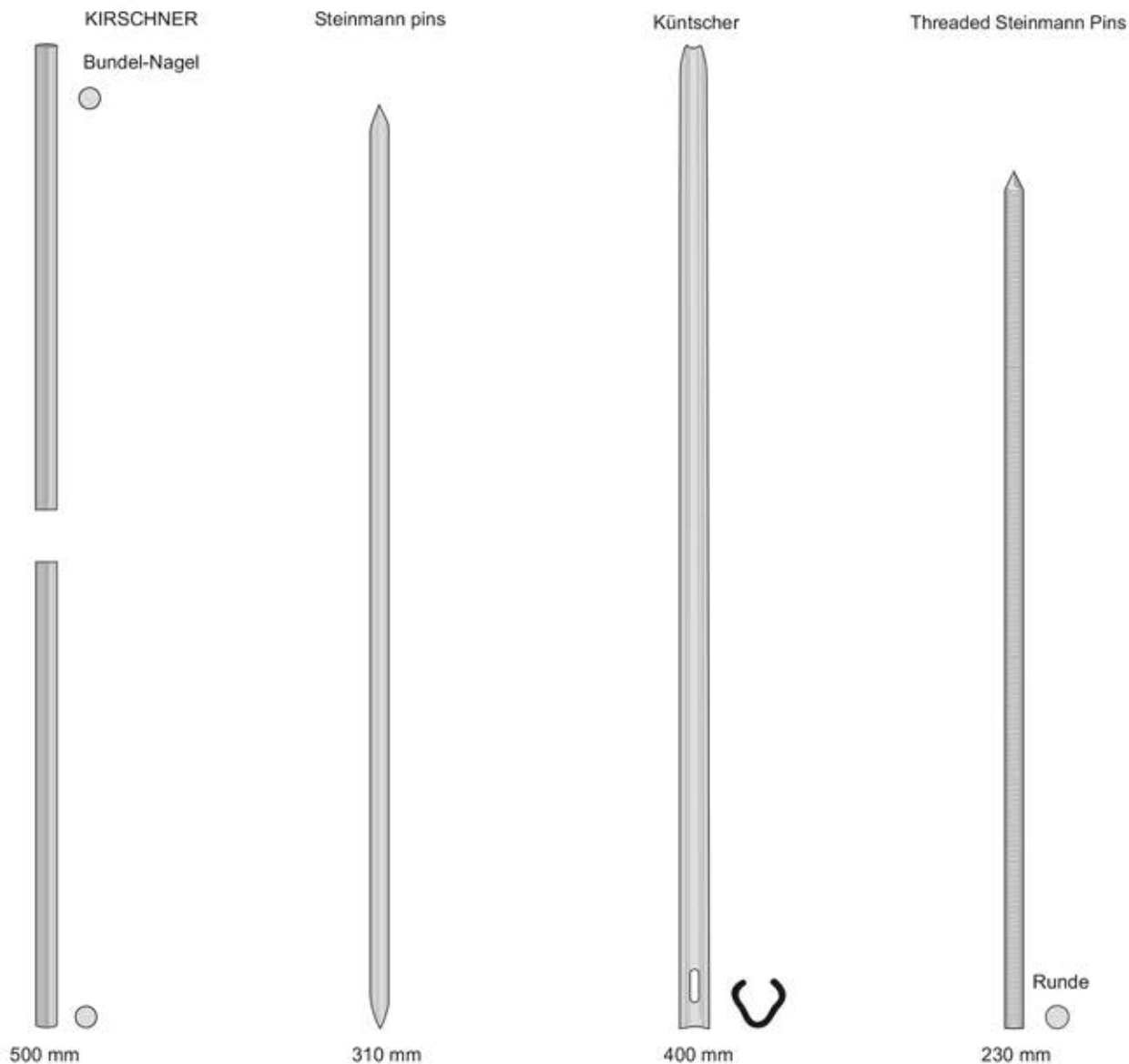

Ø/Diam.	Conf. 10 pz.
2,0 mm	KI-50
2,5 mm	KI-51
3,0 mm	KI-52
3,5 mm	KI-53
4,0 mm	KI-54
4,5 mm	KI-55
5,0 mm	KI-56
5,5 mm	KI-57
6,0 mm	KI-58

Ø/Diam.	Conf. 1 pz.
3,5 mm	KI-280
4,0 mm	KI-282
4,5 mm	KI-284
5,0 mm	KI-286
6,0 mm	KI-288
6,5 mm	KI-290

Ø/Diam.	Conf. 1 pz.
6,0 mm	KI-252
7,0 mm	KI-254
8,0 mm	KI-256
9,0 mm	KI-258
10 mm	KI-260
11 mm	KI-262
12 mm	KI-264

Ø/Diam.	Conf. 1 pz.
2,0 mm	KI-160
2,5 mm	KI-161

Negativo

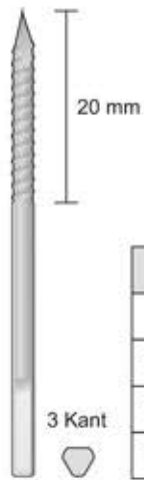

SCHANZ			
Codice	Ø mm	Lung.	Lung. filo
KI-230	3	60	20
KI-231	3	80	20
KI-232	4	60	25

Negativo



SCHANZ			
Codice	Ø mm	Lung.	Lung. filo
KI-293	2	150	50
KI-294	3	150	50
KI-295	3,5	150	50
KI-296	4	150	50
KI-297	4,5	150	50
KI-298	5	150	50

Negativo



SCHANZ			
Codice	Ø mm	Lung.	Lung. filo
KI-238	2	150	50
KI-240	3	150	50
KI-242	3,5	150	50
KI-244	4	150	50
KI-246	4,5	150	50
KI-248	5	150	50

Positivo

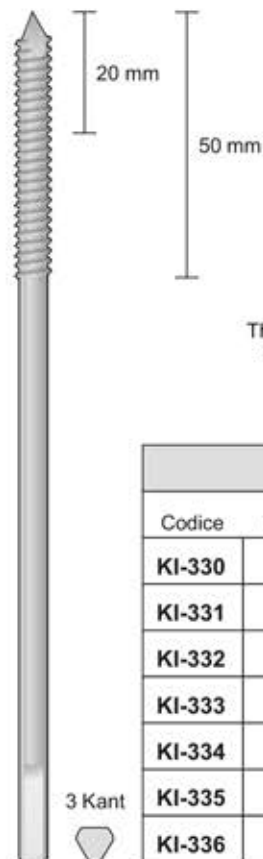

SCHANZ			
Codice	Ø mm	Lung.	Lung. filo
KI-330	2	150	20
KI-331	3	150	20
KI-332	3,5	150	50
KI-333	4	150	25
KI-334	4	150	50
KI-335	4,5	150	50
KI-336	5	150	50

Steinmann Pins with Central Thread with Trocar Point

Bohrdrahtspender
Contenitore per
sterilizzazione Kirschner



Positivo

Thread - Ø is 0,5 mm
more than pin - Ø

3 Kant



STEINMANN PINS		
Codice	Ø mm	Lung.
KI-175	3	150
KI-176	3	180
KI-177	3	200
KI-178	3	230
KI-179	3,5	150
KI-180	3,5	180
KI-181	3,5	200
KI-182	3,5	230
KI-183	4	150
KI-184	4	180
KI-185	4	200
KI-186	4	230
KI-187	4	250
KI-188	4,5	150
KI-189	4,5	180
KI-190	4,5	200
KI-191	4,5	230
KI-192	4,5	250
KI-193	4,5	300
KI-194	5	150
KI-195	5	180
KI-196	5	200
KI-197	5	230
KI-198	5	250
KI-199	5	300

Ø 10 mm



KI-300
320 mm
KI-301
190 mm

Punta elicoidali con innesto rapido

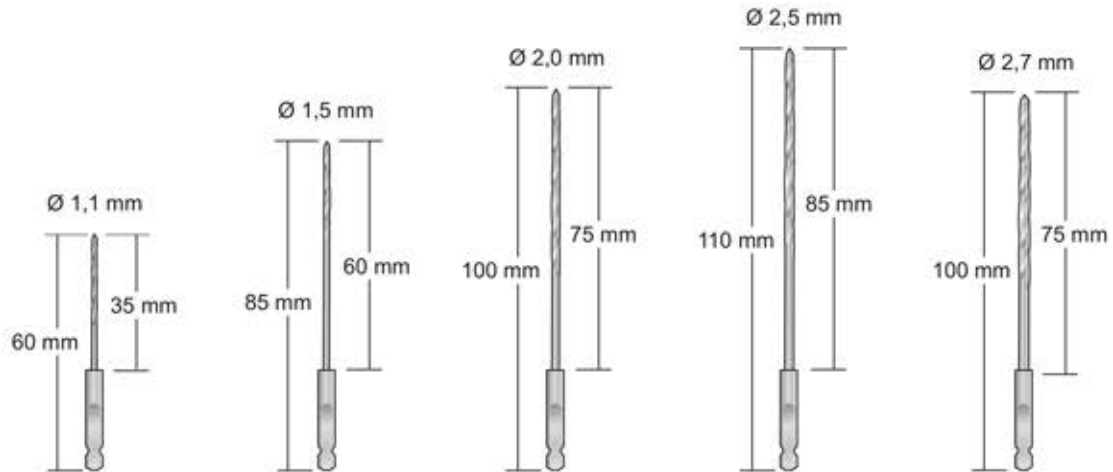
 Mit AO schaft
 Drill bits
 Attacco AO

LS-20

LS-21

LS-22

LS-23

LS-24

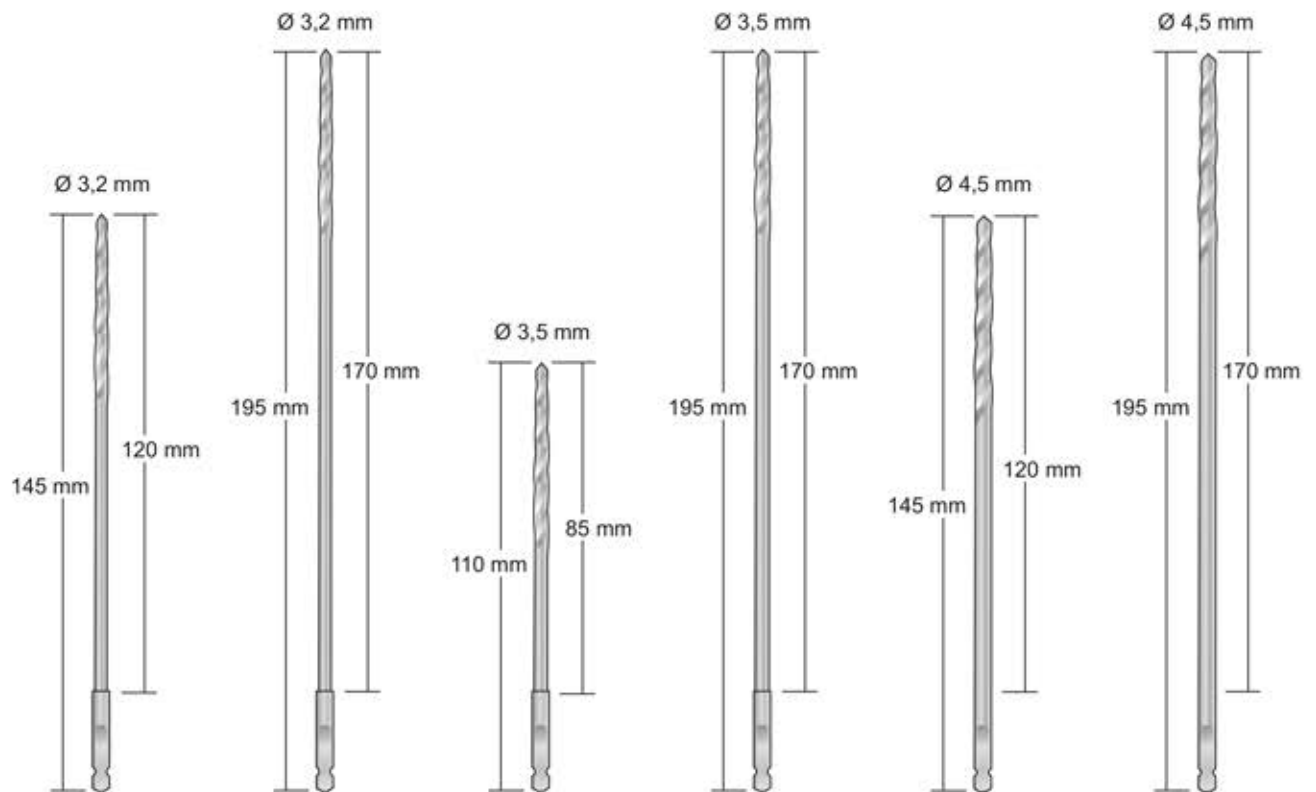

LS-25

LS-26

LS-27

LS-28

LS-29

LS-30

Punte elicoidali

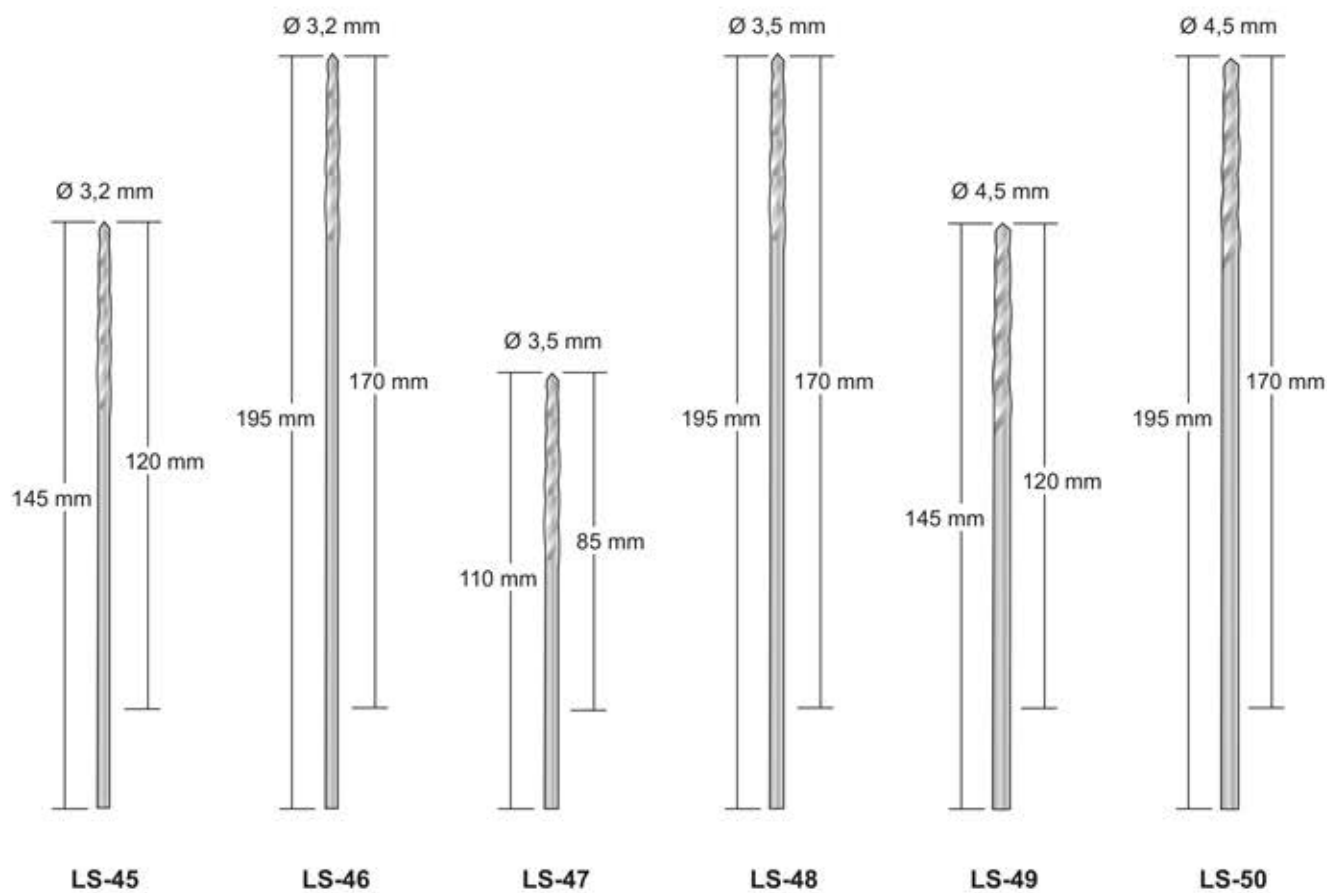
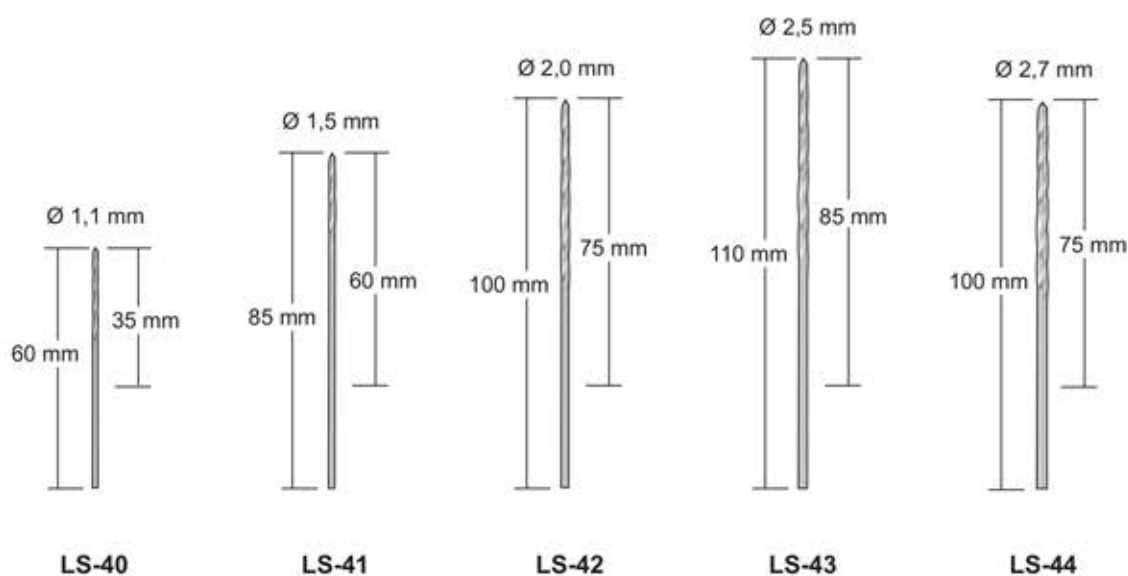
 Mit rundschaft
 Drill bits
 Con attacco rotondo

Mit rundschaft
Drill bits
Con attacco rotondo

Punte elicoidali

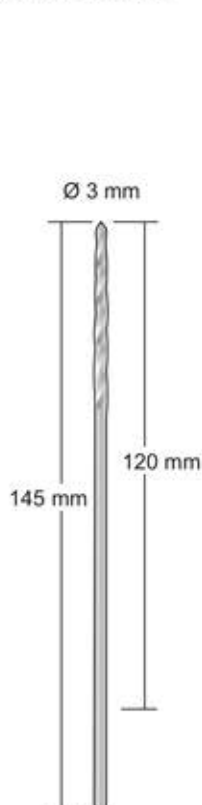

LS-51

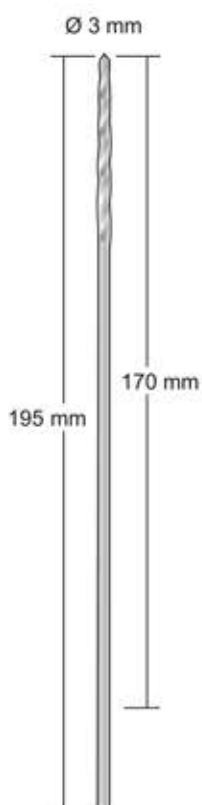

LS-52

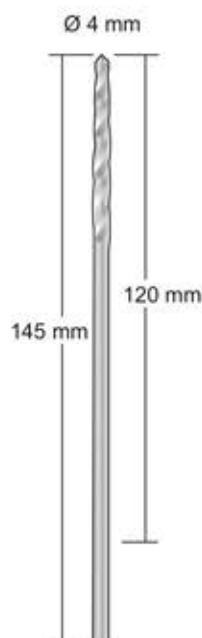

LS-53

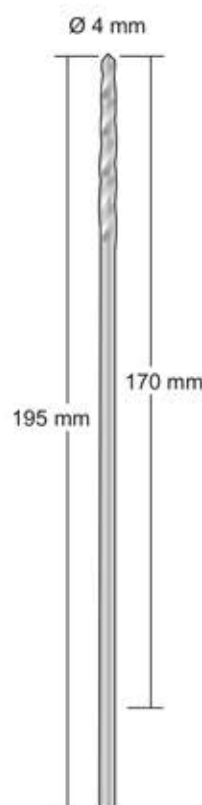

LS-54

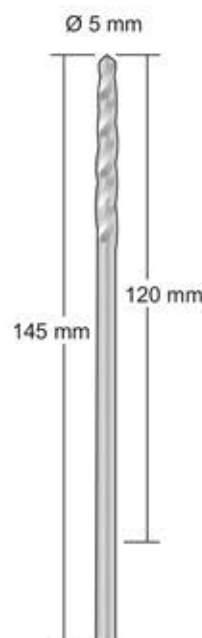

LS-55

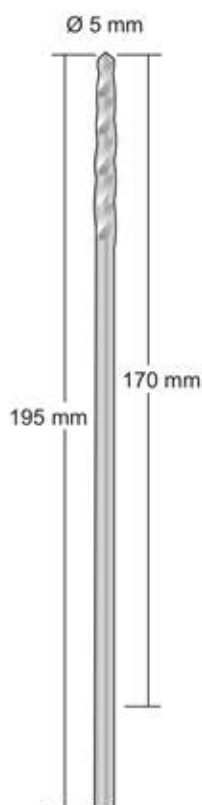

LS-56

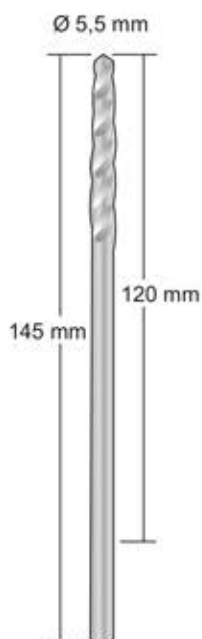

LS-57

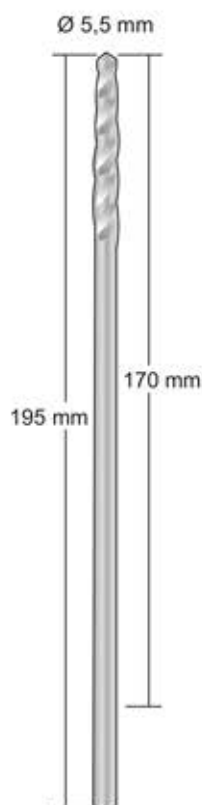

LS-58

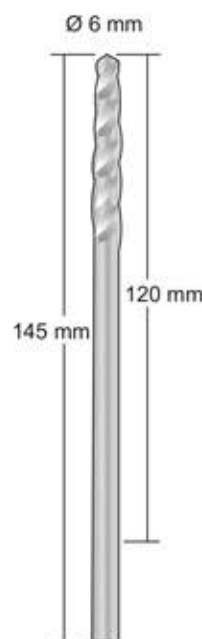

LS-59

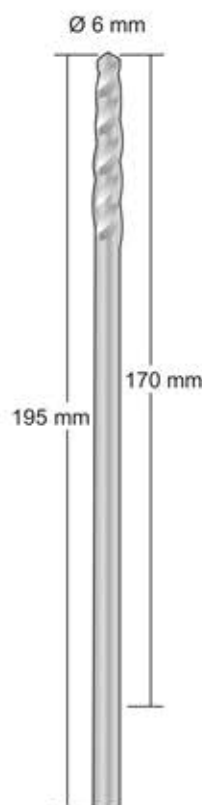

LS-60

Dental schaft
Attacco Dentale

Ø 1,5 mm



LS-32
50 mm

Ø 2,0 mm



LS-33
55 mm

Mit AO schaft
Attacco AO

Ø 1,5 mm



LS-10
65 mm

Ø 2 mm



LS-11
70 mm

Ø 2,7 mm



LS-12
100 mm

Passo della vite
a 1,25 mm

Ø 3,5 mm



LS-13
110 mm

Passo della vite
a 1,75 mm

Ø 3,5 mm



LS-14
110 mm

Ø 4,5 mm



LS-15
130 mm

Ø 4,5 mm



LS-16
130 mm

Ø 6,5 mm



LS-17
170 mm

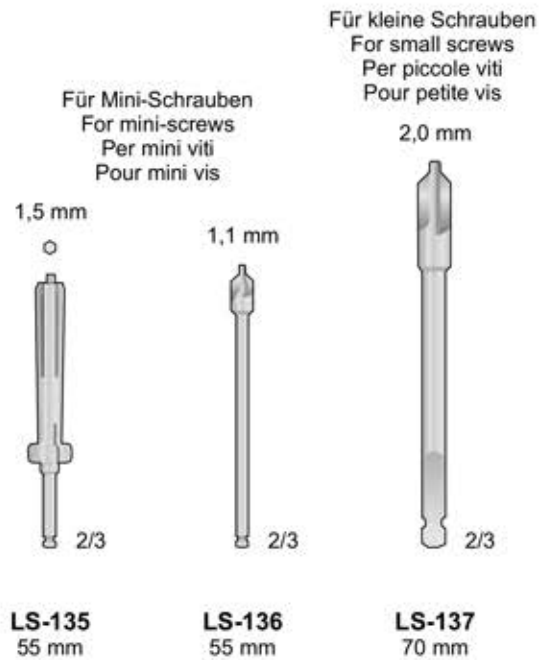

Für Malleolarschrauben
For malleolar screws
Per viti malleolari
Pour vis à malléole

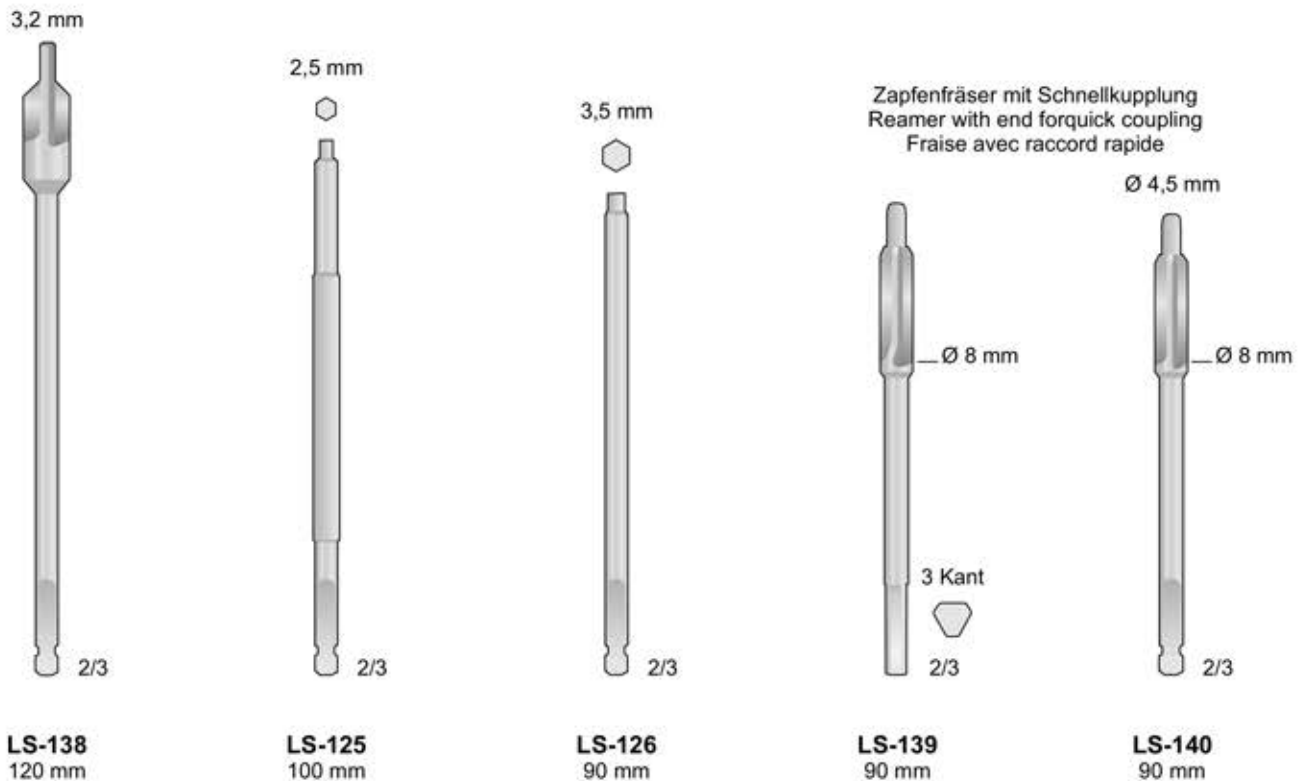

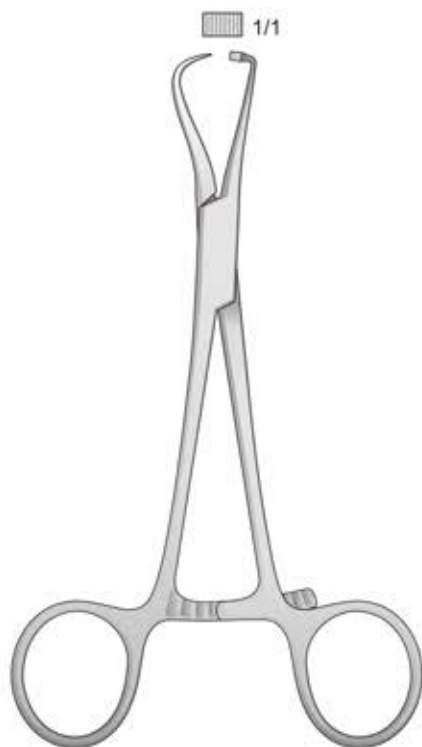

LS-76
120 mm

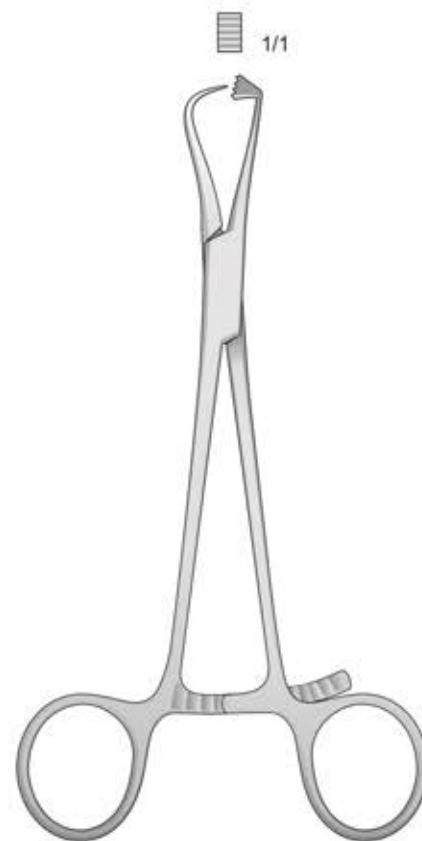

LS-78
125 mm

Ø 3 mm

**FL-20**
155 mm

Ø 5 mm

**FL-21**
155 mm

Ø 7 mm

**FL-22**
155 mm

Ø 2 mm

**FL-30**
155 mm

Ø 4 mm

**FL-31**
155 mm

Ø 3 mm

**FL-33**
155 mm

Ø 5 mm

**FL-35**
155 mm

Für weichen Draht Ø 7 mm
 Für harten Draht Ø 6 mm
 For soft wire Ø 7 mm
 For hard wire Ø 6 mm
 Per filo leggero Ø 7 mm
 Per filo duro Ø 6 mm
 Para alambres ligero Ø 7 mm
 Para alambres duro Ø 6 mm
 Pour fil léger Ø 7 mm
 Pour fil dur Ø 6 mm

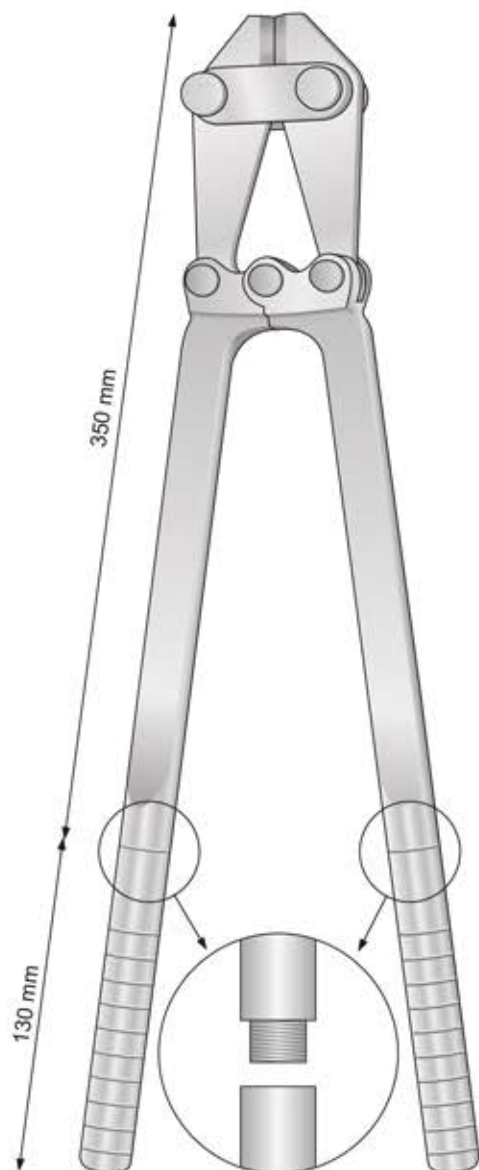

VF-98M
480 mm

Für weichen Draht Ø 5 mm
 Für harten Draht Ø 4,5 mm
 For soft wire Ø 5 mm
 For hard wire Ø 4,5 mm
 Per filo leggero Ø 5 mm
 Per filo duro Ø 4,5 mm
 Para alambres ligero Ø 5 mm
 Para alambres duro Ø 4,5 mm
 Pour fil léger Ø 5 mm
 Pour fil dur Ø 4,5 mm

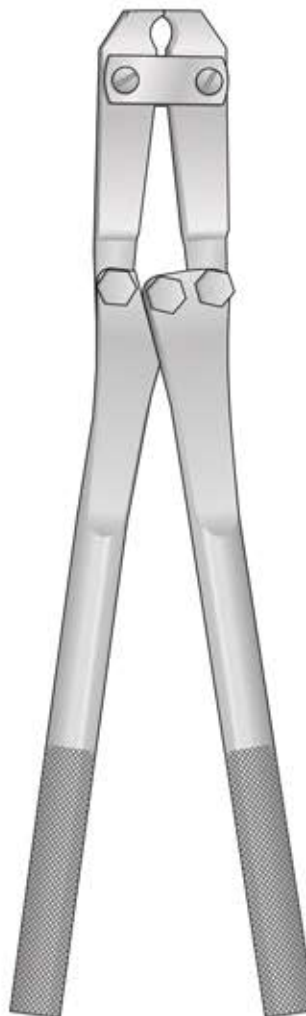

LX-107
375 mm

Ohrhebel - Ear hooks - Uncini

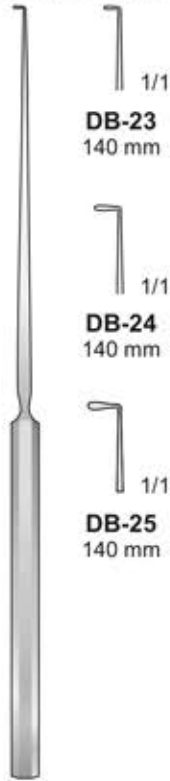

DB-23
140 mm

DB-24
140 mm

DB-25
140 mm

LUCAE
DB-23/DB-25
140 mm

Löffel - Currettes - Curette - Curetas - Curettes

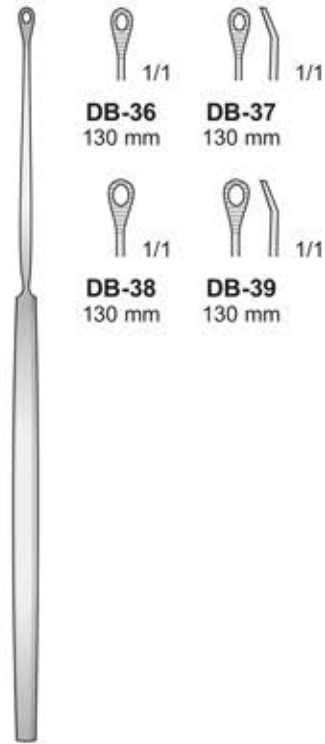

DB-36
130 mm

DB-37
130 mm

DB-38
130 mm

DB-39
130 mm

SHAPLEIGH
DB-36/DB-39
130 mm

Ohrhebel - Ear hooks - Uncini

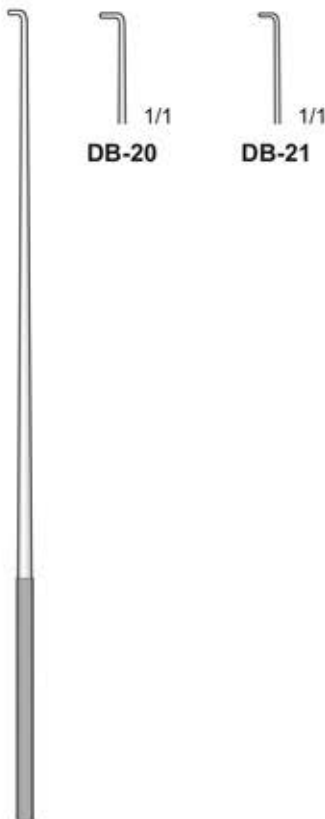

DB-20

DB-21

DAY
DB-20/DB-21
160 mm

Ohrschlingen - Ear loops anses - Anse auricolari - Ansas auriculares

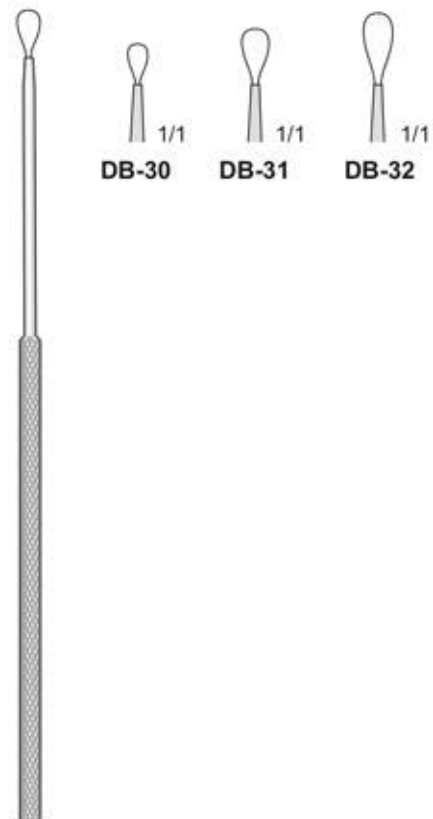

DB-30

DB-31

DB-32

BILLEAU
DB-30/DB-32
160 mm

Spülkanülen
Irrigating cannulas
Cannule di irrigazione
Cánulas de irrigación
Canules d'irrigation



OL-51
45 mm



OL-52
45 mm



OL-50
30 mm



OL-53
35 mm



OL-54
50 mm



**ANEL
OL-55**
30 mm



**ANEL
OL-56**
30 mm

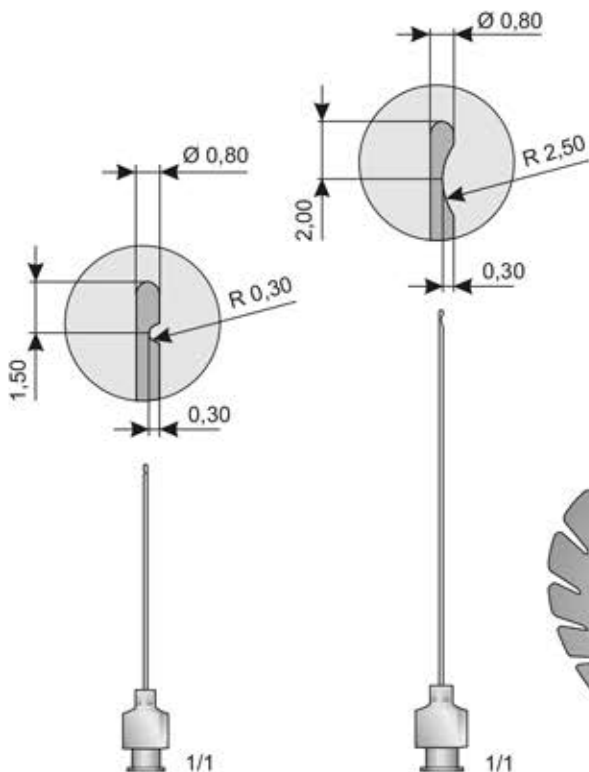

OL-57
40 mm

OL-58
60 mm

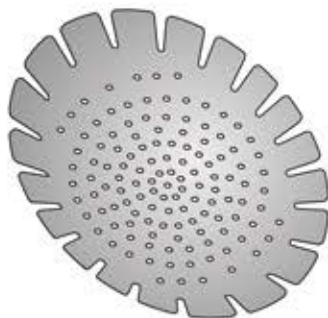

OL-20
75 mm

Lagerungsgestell für 15 Stück Nadeln
Rack for 15 needles
Piastra per 15 aghi oftalmici
150 x 100 x 2 mm



BS-20
150 x 100 x 2 mm

Sperrelevatoren - Eye specula - Blefarostati
Blefarostatos - Blèpharostats

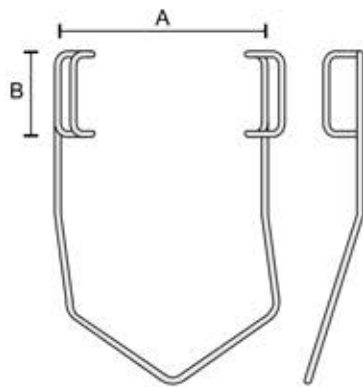

NK-79 A B
27 mm 11 mm



BARRAQUER
NK-83

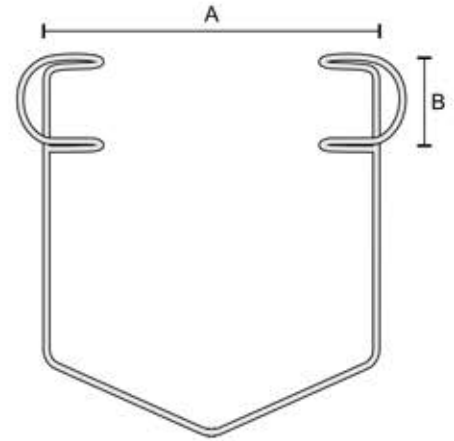

NK-80 A B
27 mm 5 mm
NK-82 34 mm 9 mm
NK-84 42 mm 12 mm
NK-86 42 mm 14 mm

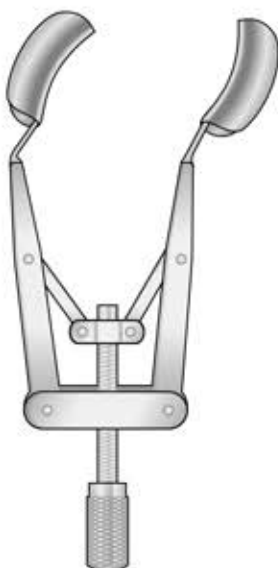

KERSHNER
NK-420

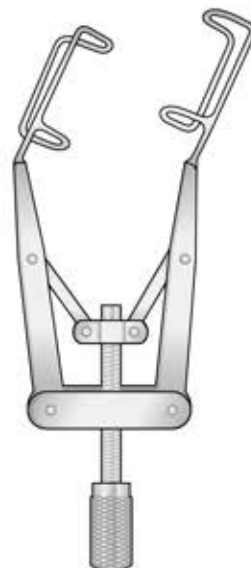

KERSHNER
NK-421

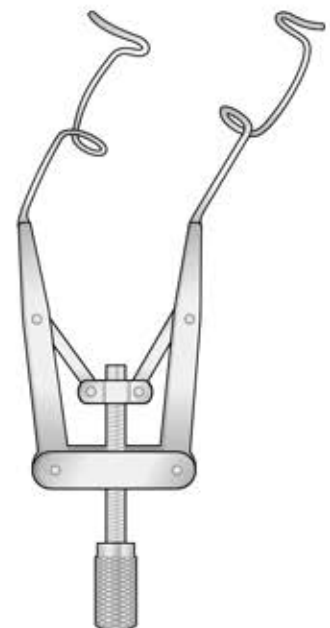

LIEBERMANN-TENNANT
NK-422

Sperrelevatoren - Eye specula - Blefarostati
Blefarostatos - Blèpharostats

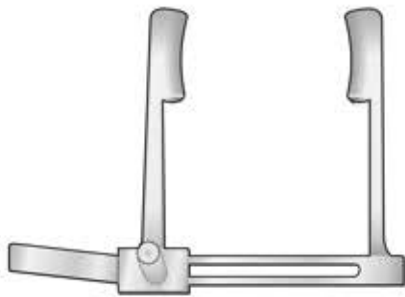

**PROST
NK-92**

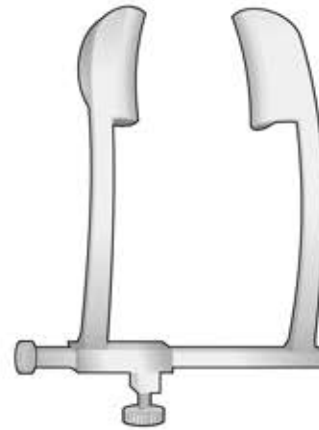

**COOK
NK-131**

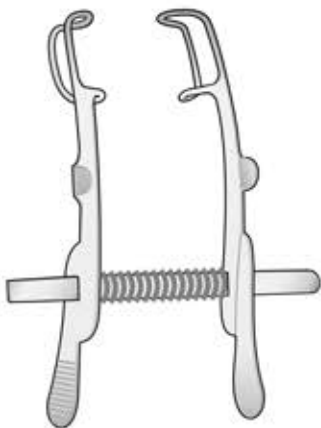

**MELLINGER
BV-02
70 mm**

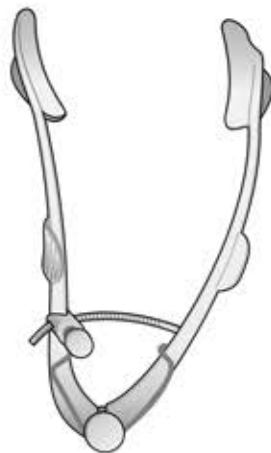

**LISTER-BURCH
BV-04
80 mm**



**CASTROVIEJO
BV-05
80 mm**

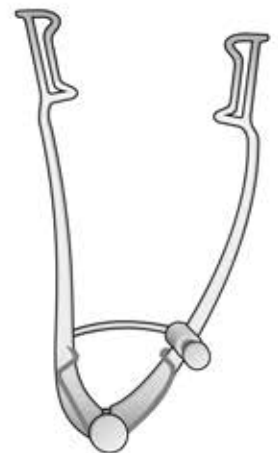

**WILLIAMS
BV-06
80 mm**

Lama ricambio

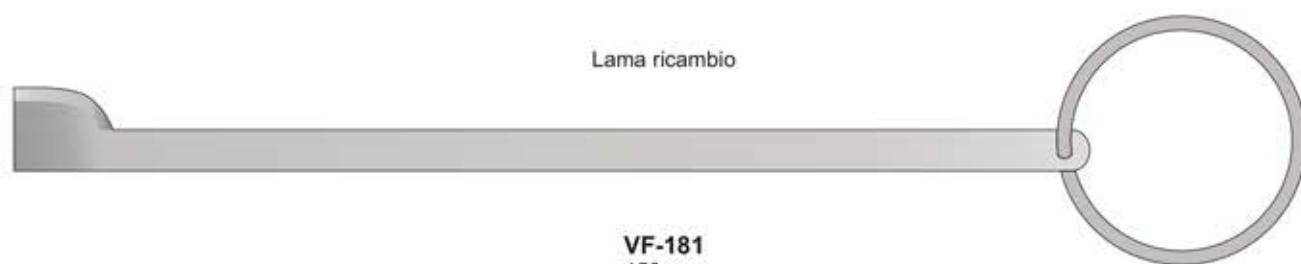

VF-181
150 mm

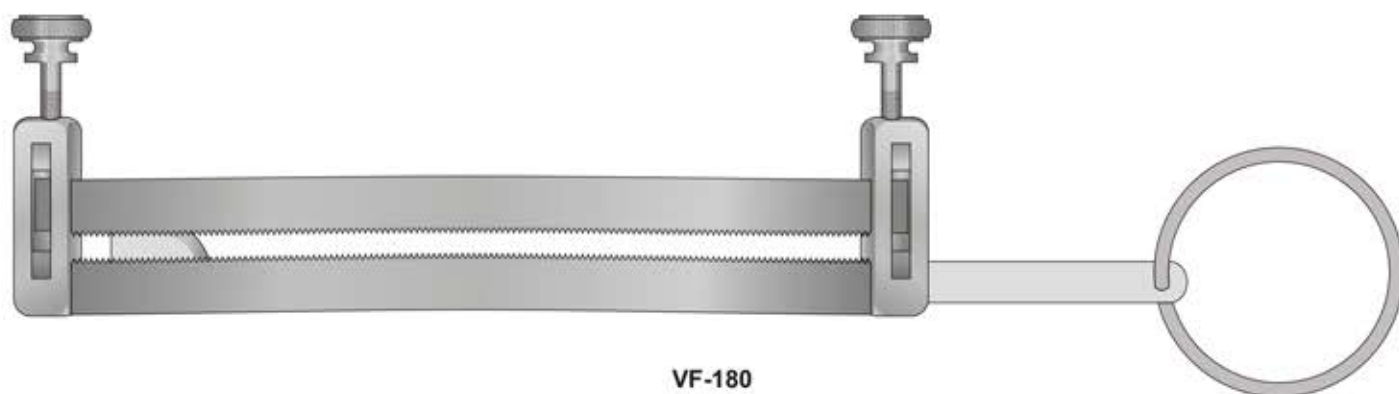

VF-180
130 mm

Canula lacrimale
per cavalli



**TRANA
GF-95**
160 mm



NK-102
160 mm



**CONVERSE
NK-101**
160 mm

Ø 4 mm



VF-102M
170 mm



VH-62
105 mm

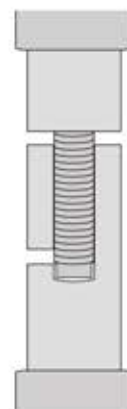

Punch per orecchio

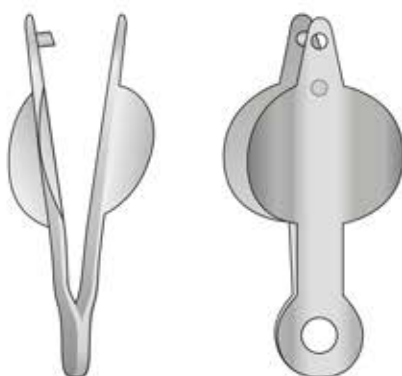

BD-150
50 mm

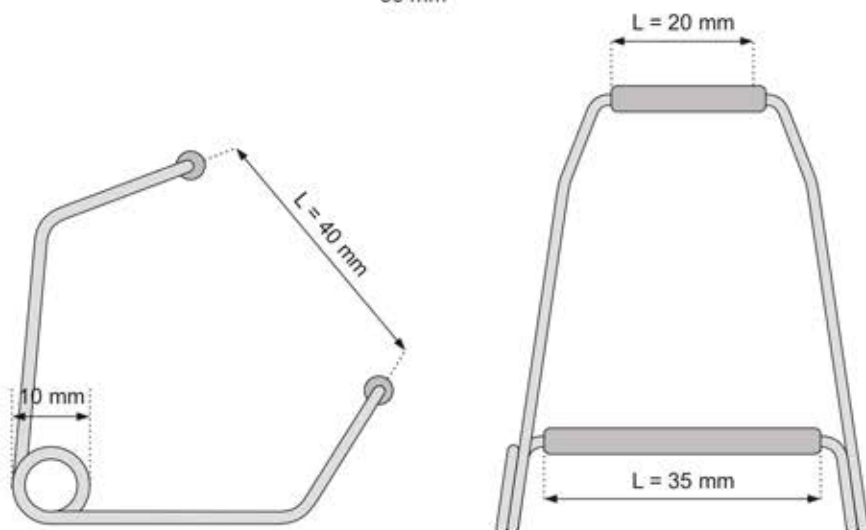

VH-46
35 mm

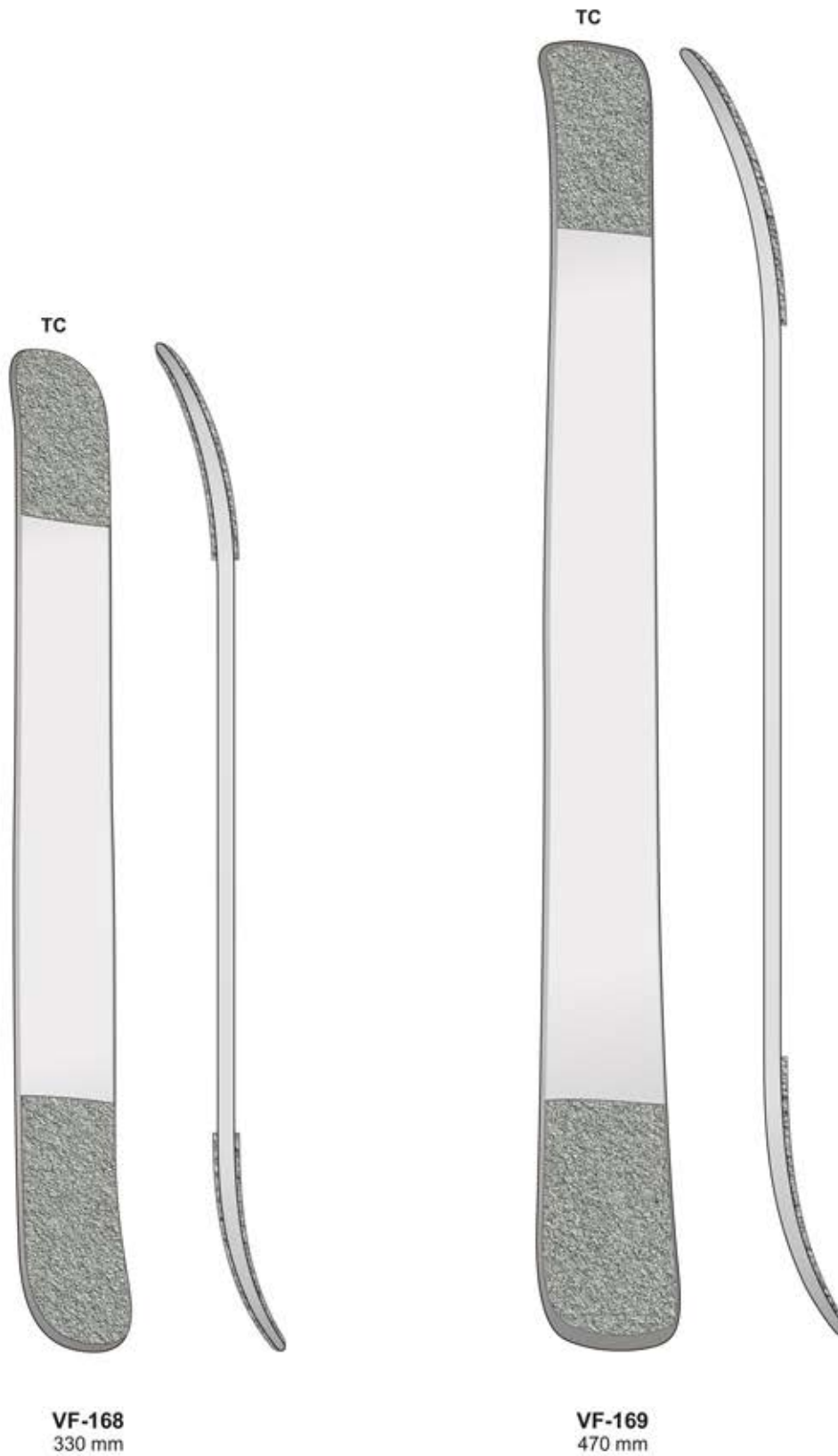

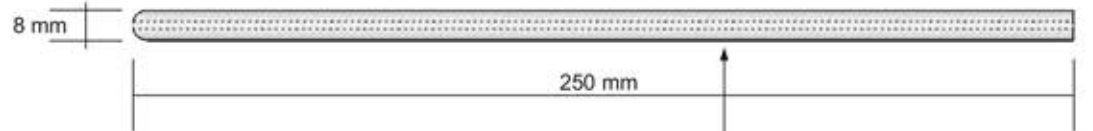
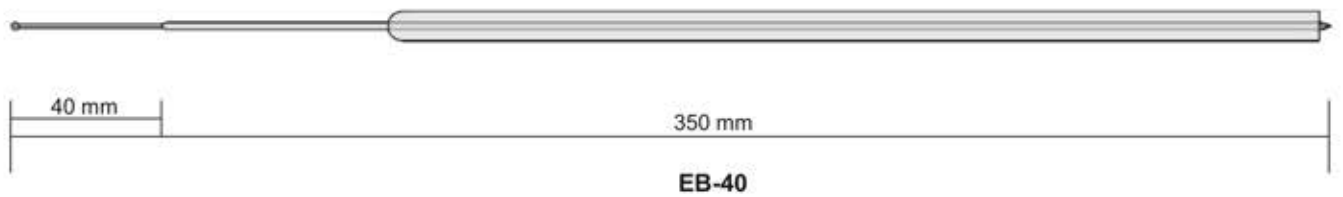

Materiale plastico autolavabile (Teflon)

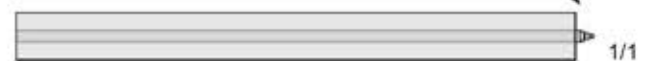
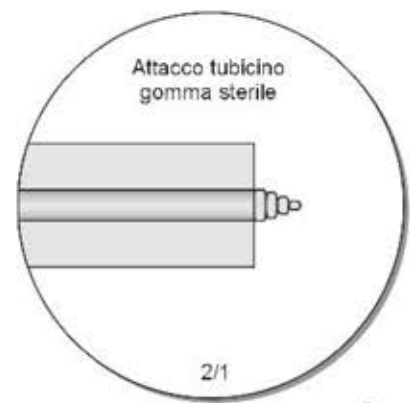
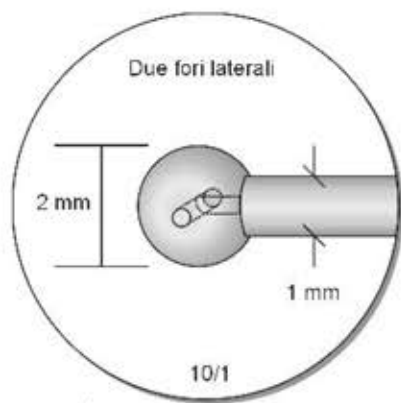

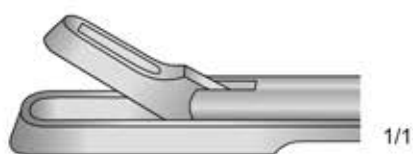

Pinza per biopsia uterina grandi animali

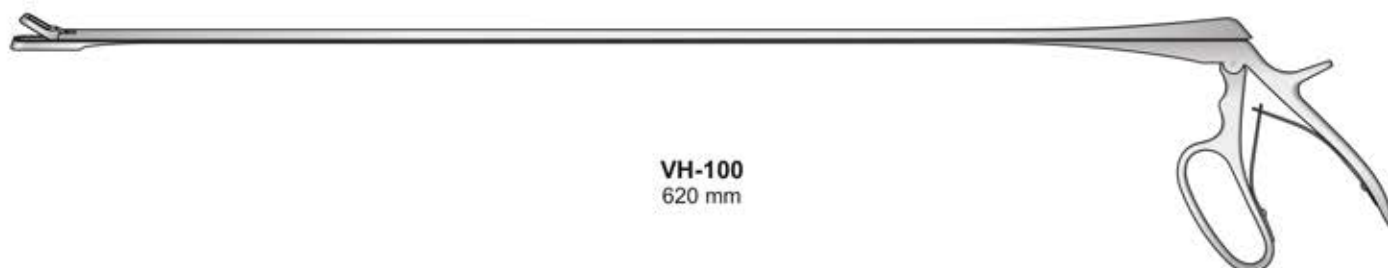

Laccio per suini

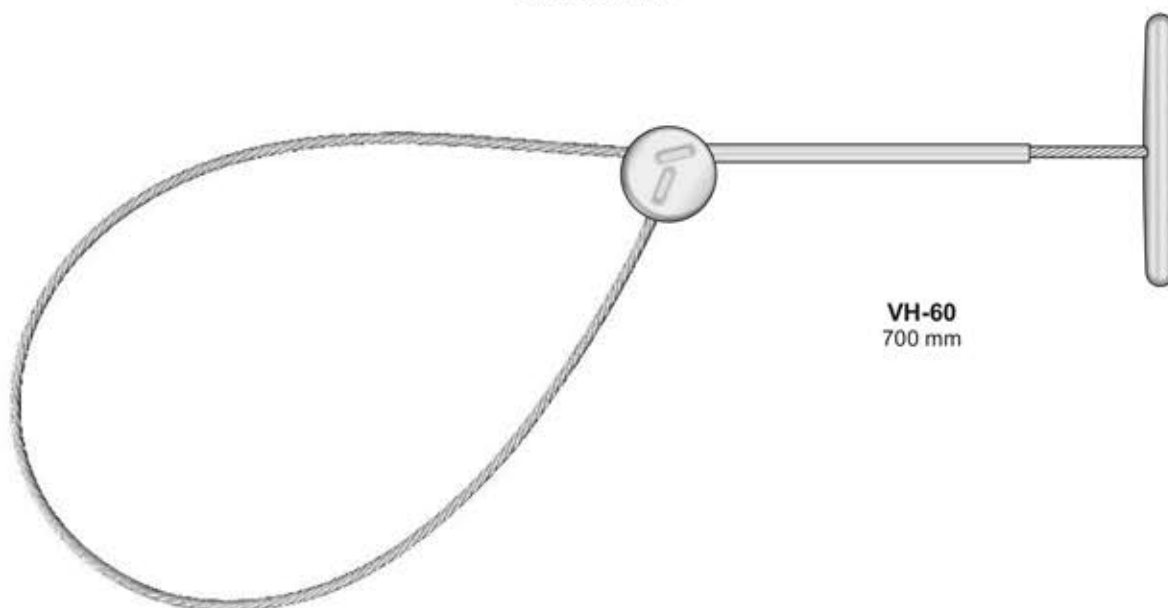

Speculum vaginali
2 valve

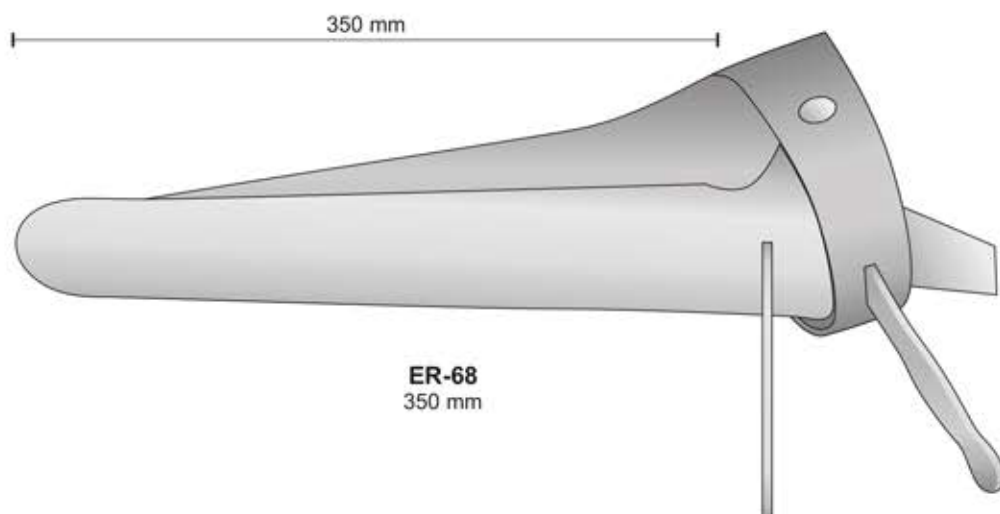
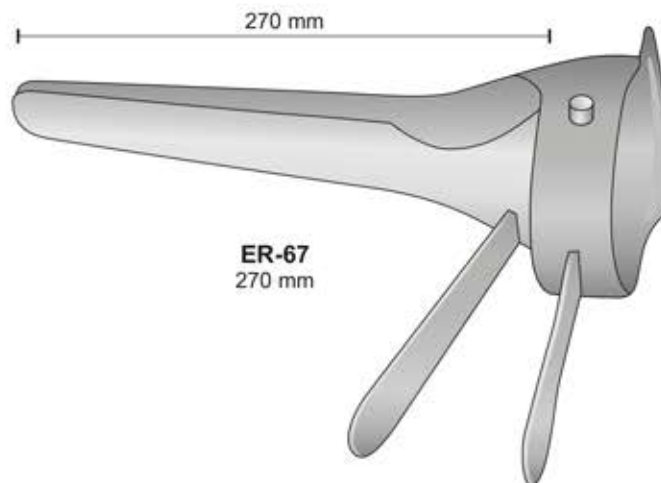

Speculum vaginale 3 valve per grandi animali
Inox

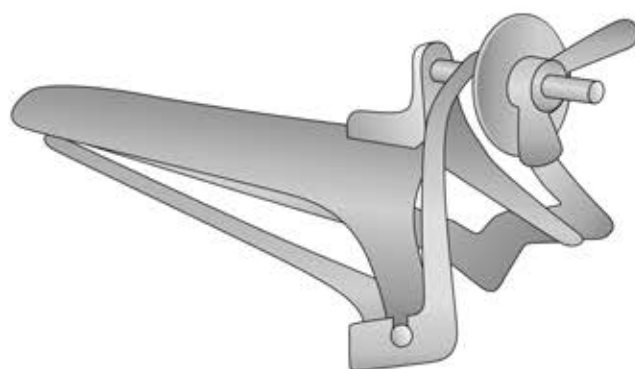

POLANSKY
ER-69
270 mm

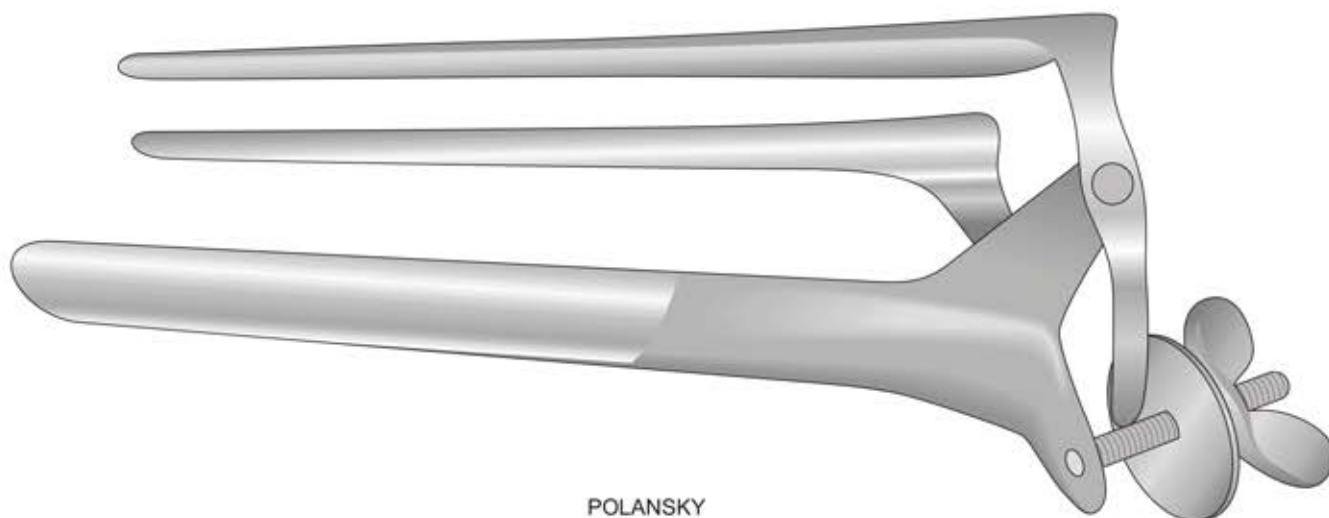

POLANSKY
ER-70

Apribocca per grandi animali

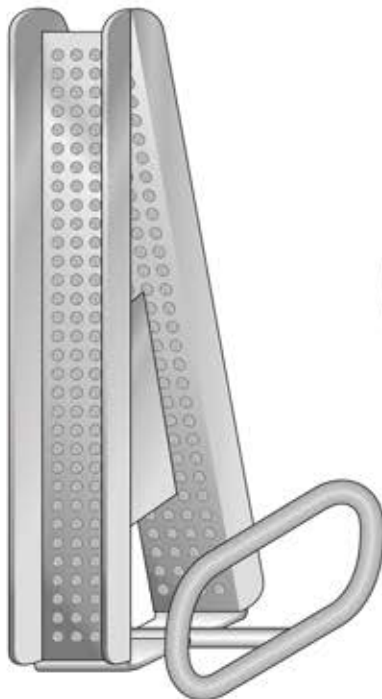

BAYER
VH-72
200 mm

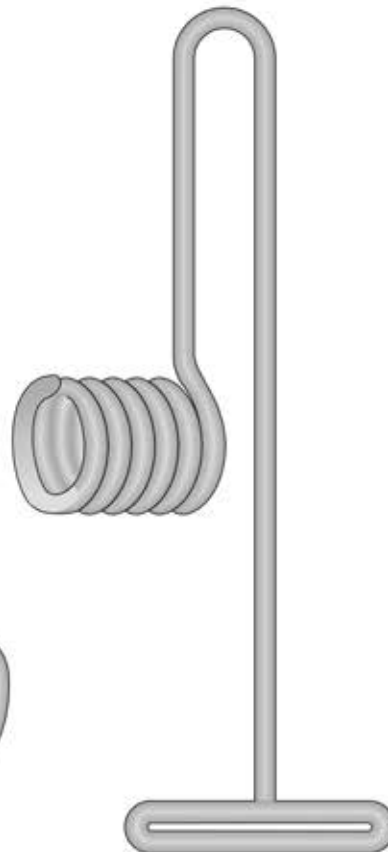

SCHOUPE
VH-74
260 mm

Pinza per denti grandi animali

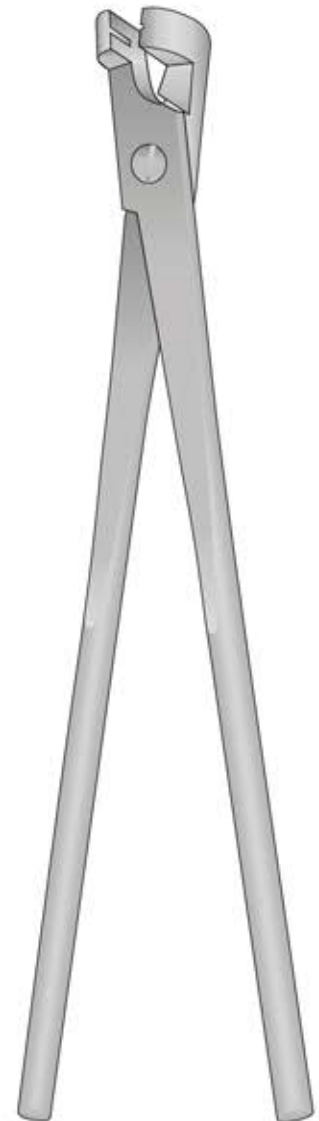

GÜNTHER
VH-80
445 mm

Apribocca per cavalli

MAULGATTER EGGERT ROSTFREI
Inox - Cinghie di cuoio



EGGERT
VH-70

Emasculatori per grandi animali



BERTSCHY
VF-300
360 mm



BERTSCHY MOD.
VF-301
350 mm

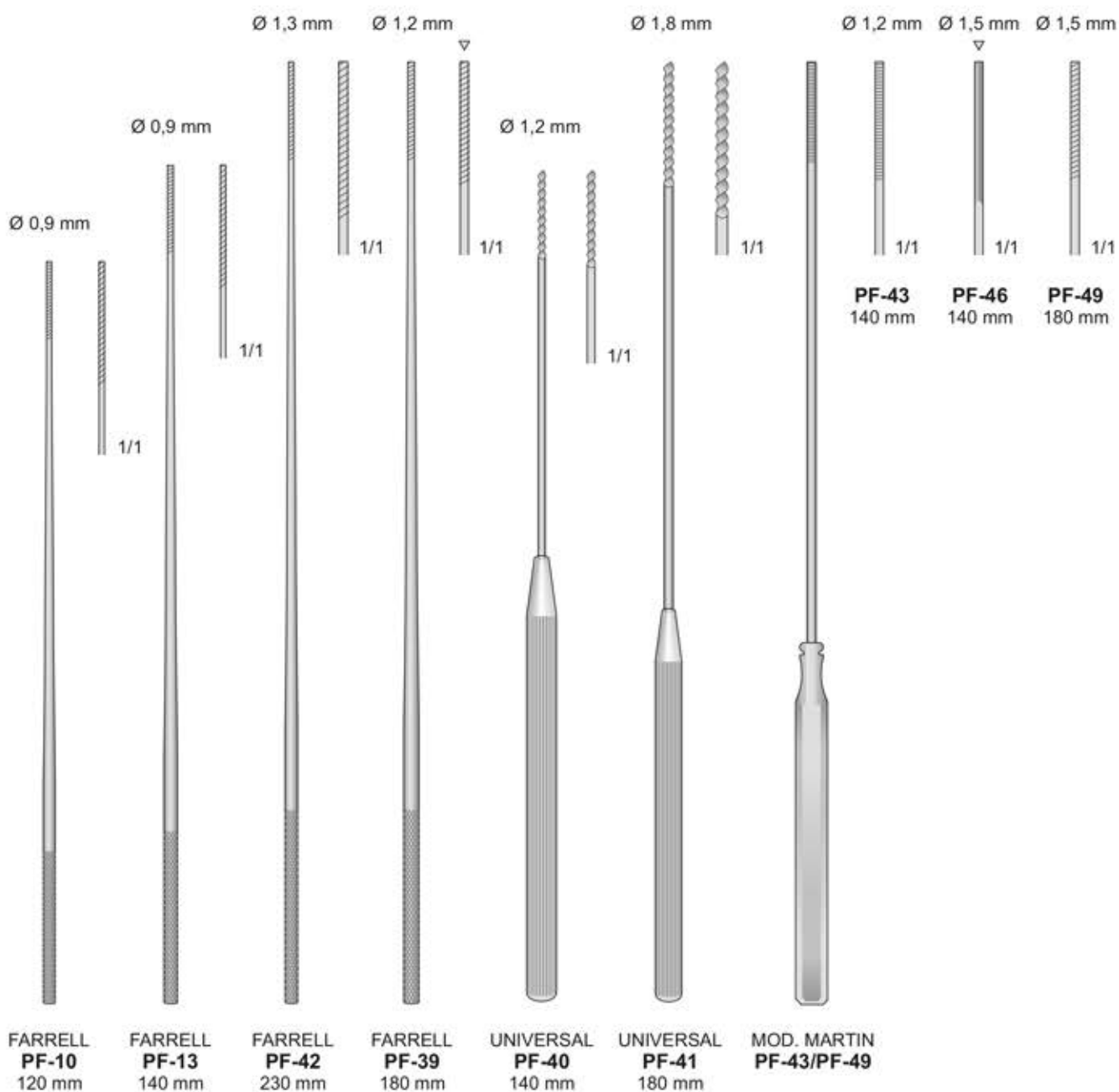

Hohlsonde

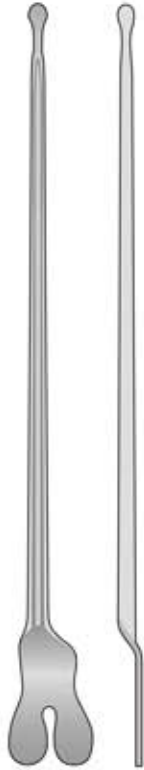

PF-54 145 mm
PF-55 160 mm
PF-19 180 mm
PF-56 200 mm

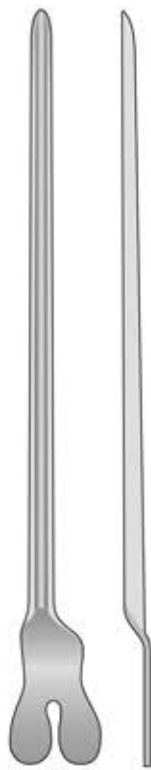

PF-53 130 mm
PF-57 145 mm
PF-58 160 mm
PF-59 180 mm
PF-18 200 mm

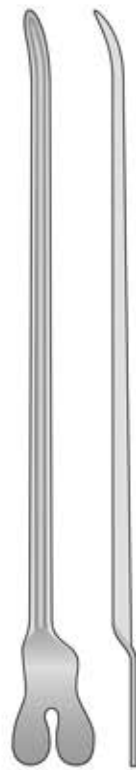

DOYEN
PF-24
 145 mm



NELATON
PF-17
 160 mm

Fistelsonden - Fistula probes - Sonde per fistole - Sondas para fistulas - Sondes pour fistules



LOCHART
PF-80
 170 mm



LOCHART
PF-81
 170 mm



LOCHART
PF-82
 170 mm



LOCHART
PF-83
 170 mm



1/1
 Biagsam
 Malleable
 Malleabile
 Soupe
 Maleable

LOCHART
PF-85
 190 mm

Kanülenreinigungs-bürsten - Cleaning brush for tubes
 Scovolini per pulizia cannule - Cepillo para limpiar cánulas
 Brosse de nettoyage pour canules

Sterilisier bar
 Autoclavable
 Autoclavabile
 Esterilizable
 Stérilisable

Handwaschbürste
 Nail brushes
 Spazzola per unghie
 Cepillos de uñas
 Brosse à ongles



GF-200
 4 x 11 cm



PELTON-CRANE
GF-184
 140 mm

PELTON-CRANE
GF-180
 160 mm



GF-40
 235 mm



GF-188
 220 mm



GF-187
 300 mm



GF-189
 360 mm

RODHOIL

Lubrificant to high density. It assures the perfect utility and fluency of all the surgical instruments. For apply in to loosens, join and in all the parts in subject movement subject to attrition.

RODHOIL

Lubrificante ad alta densità. Assicura la perfetta funzionalità e scorrevolezza di tutti gli strumenti chirurgici. Da applicare negli snodi, giunture e in tutte le parti in movimento soggette ad attrito.

Olio lubrificante per
strumenti chirurgici



DB-OLR
50 cc

**CLEANLACT**

Product concentrated for surgical instruments. It explains an action anti-corrosive, antibacterium and lubricant. It guarantees the perfect maintenance of all the instruments in steel eliminating eventual stains and burnishes to sterilization, disinfection and to washings with hard waters. It used periodically.

CLEANLACT

Prodotto concentrato per strumenti chirurgici. Esplica un azione anticorrosiva batteriostatica e lubrificante. Garantisce il perfetto mantenimento di tutti gli strumenti in acciaio eliminando eventuali macchie, aloni e bruntiture dovute a sterilizzazioni, disinfezioni e a lavaggi con acque dure. Va usato periodicamente.

Lubrificante anticorrosivo
e detergente
per strumenti chirurgici



DB-10M
250 cc

Schleifsteine
Sharpening stones
Pietre di Arkansas per affilatura strumenti
Materiales para afilar
Pierres d'affutage

Schleifstein-Öl
Oil for grinding stones
Olio per affilatura strumenti
Huile d'affutage



DB-299
ARKANSAS
conica n° 299



DB-OL
30 cc



DB-96
ARKANSAS
piatta n° 8



DB-6A
ARKANSAS n° 6A



DB-4
ARKANSAS
piatta n° 4



DB-22A
ARKANSAS

Sterilisierbar
Autoclavable
Autoclavabili

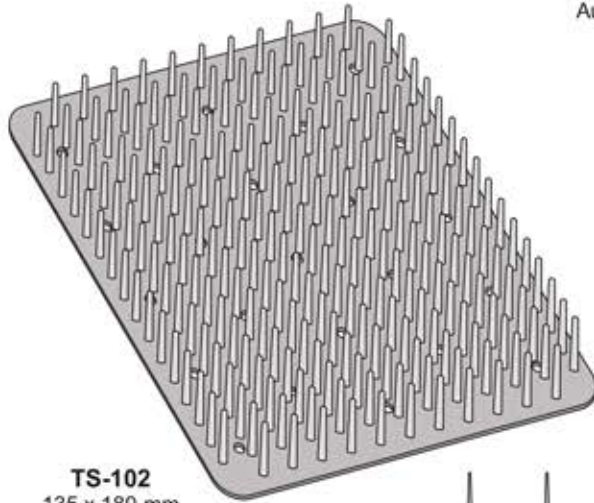

TS-102
135 x 180 mm

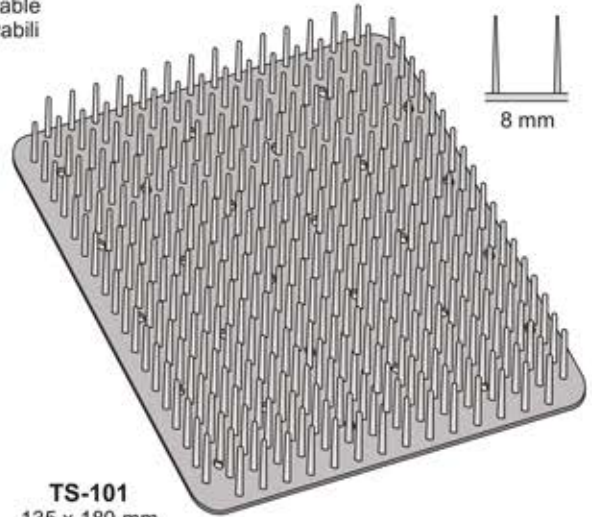
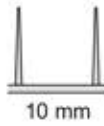

TS-101
135 x 180 mm

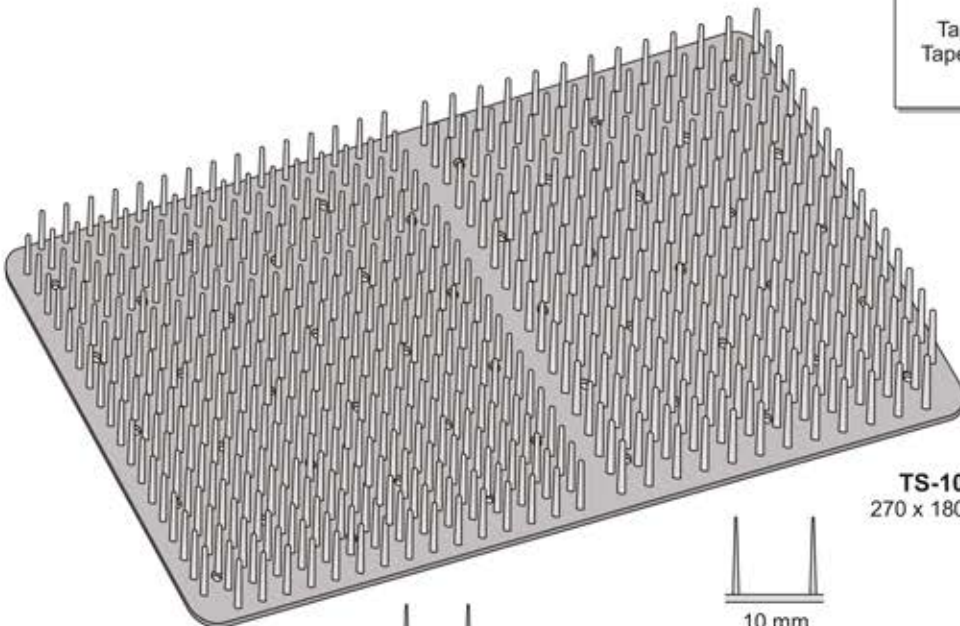
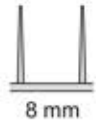

TS-104
270 x 180 mm

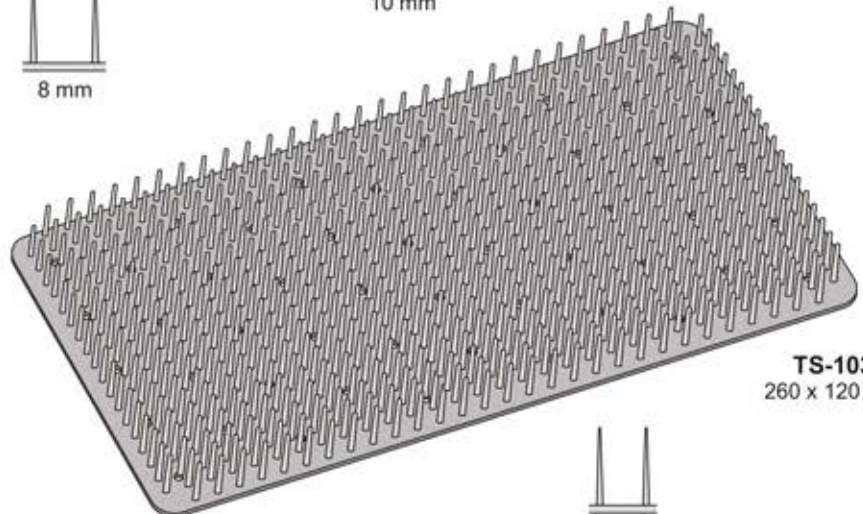
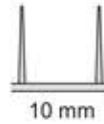

TS-103
260 x 120 mm



Silikon Matten
Matte en silicone
Tappeti in aghi di silicone
Tapete en agujas de silicona
Tapis en Silicone

Rostfrei - Stainless steel - Acciaio Inossidabile
Acero inoxidable - Acier inoxydable

Bacinella a 7 scomparti

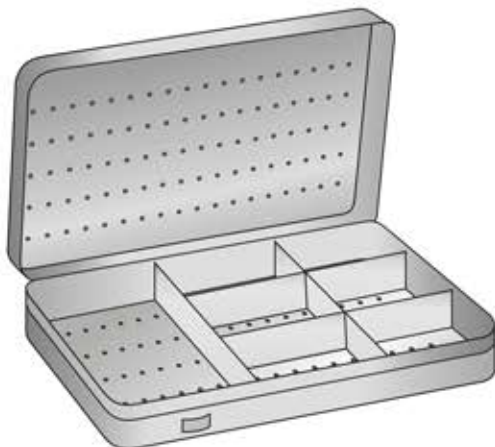

BS-27
150 x 90 x 20 mm

Bacinella a 3 scomparti

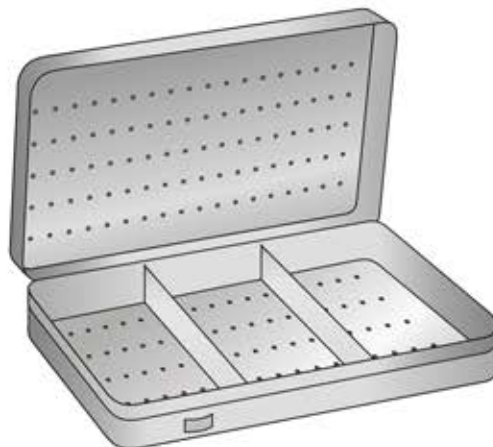

BS-23
150 x 90 x 20 mm

Bacinella a 10 scomparti

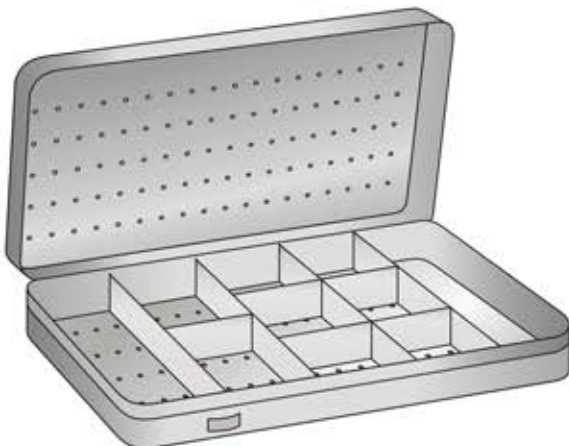

BS-28
220 x 120 x 20 mm

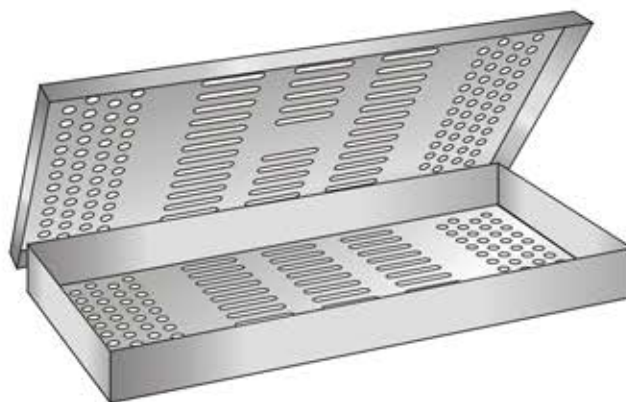

BS-41
275 x 130 x 25 mm

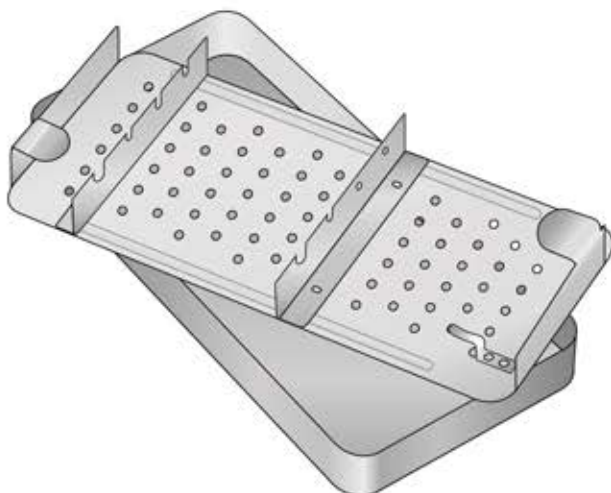

BS-30
180 x 90 x 35 mm 2 ripiani

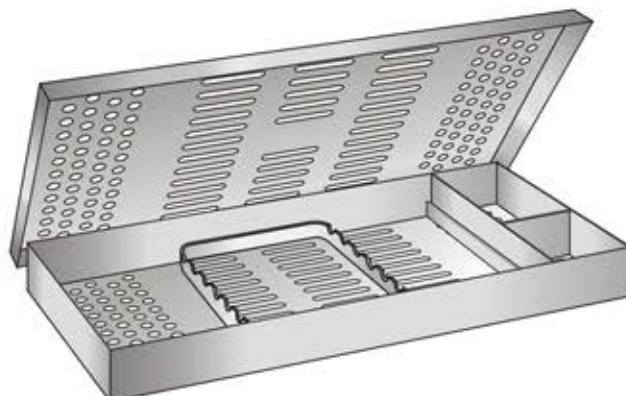

BS-40 275 x 130 x 25 mm Con griglia e scomparti
BS-42 285 x 190 x 25 mm Con griglia e scomparti

Rectangular drum
Cestelli rettangolari
Panier rectangulaire

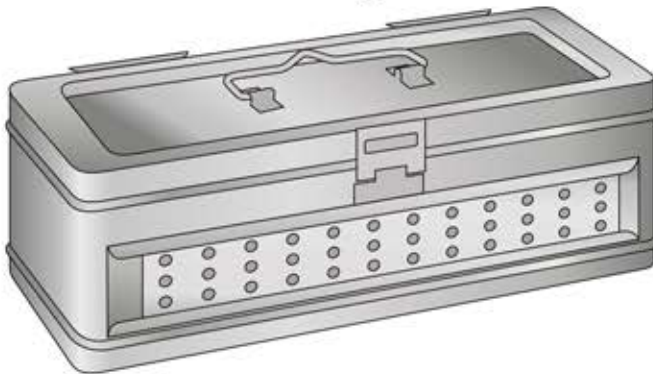

- CS-32** 300 x 150 x 60 mm
- CS-33** 300 x 150 x 90 mm
- CS-34** 300 x 150 x 180 mm

Mit filter
With filter
Cestelli rettangolari con filtro
Con filtros
Avec filtre



- CS-40** 200 x 180 x 120 mm
- CS-41** 200 x 180 x 180 mm
- CS-42** 250 x 250 x 250 mm
- CS-43** 270 x 160 x 160 mm
- CS-44** 290 x 290 x 290 mm
- CS-45** 350 x 230 x 200 mm

Instrumentenkästen
Instrument boxes
Scatole per sterilizzazione a secco
Cajas para instrumentos
Boîtes pour instruments

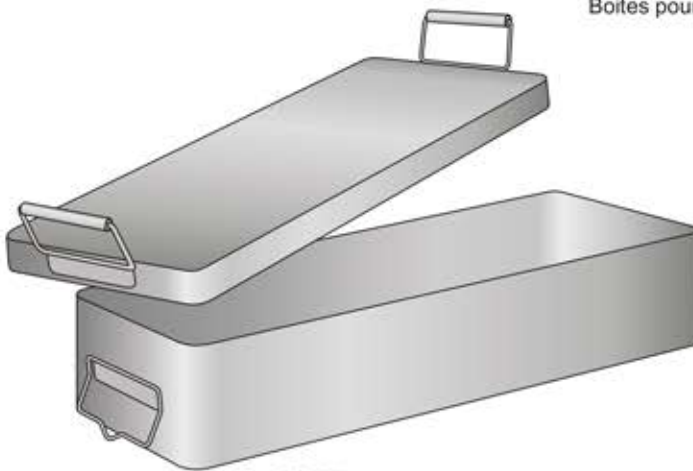

- CS-07** 280 x 140 x 60 mm
- CS-08** 300 x 140 x 60 mm
- CS-09** 360 x 160 x 70 mm



- CS-61** 150 x 90 x 40 mm
- CS-63** 200 x 100 x 60 mm
- CS-65** 250 x 120 x 60 mm
- CS-66** 280 x 140 x 60 mm
- CS-67** 320 x 150 x 60 mm



**STERILTRAY
BS 100**
25,5 X 10,5 X 8,5



**BOXTRAY
BS 101**

Plastica - Autoclavabile



BS-105
350 x 240 x 120 mm

BROMED