



**BROMED**  
INSTRUMENTS

German quality – nothing less



Chirurgia Veterinaria  
Cirugía Veterinaria  
Chirurgie Vétérinaire

Veterinärchirurgie  
**Veterinary Surgery**



Préparation Schere  
 Scissor dissection  
 Forbice per dissezione  
 Tijeras para disección  
 Ciseaux de dissection

Cockpitteile und außen  
 Cutting internal and external  
 Taglio interno ed esterno  
 Acabados interiores y exteriores  
 Garnitures intérieures et extérieures

Gezähnt  
 Serrated  
 Dentellate  
 Dentadas  
 Dentelés

Kurzen Ende  
 Short end  
 Punta corta  
 Punta corta  
 Pointe courte

Fein  
 Delicate  
 Fine  
 Finas  
 Fins

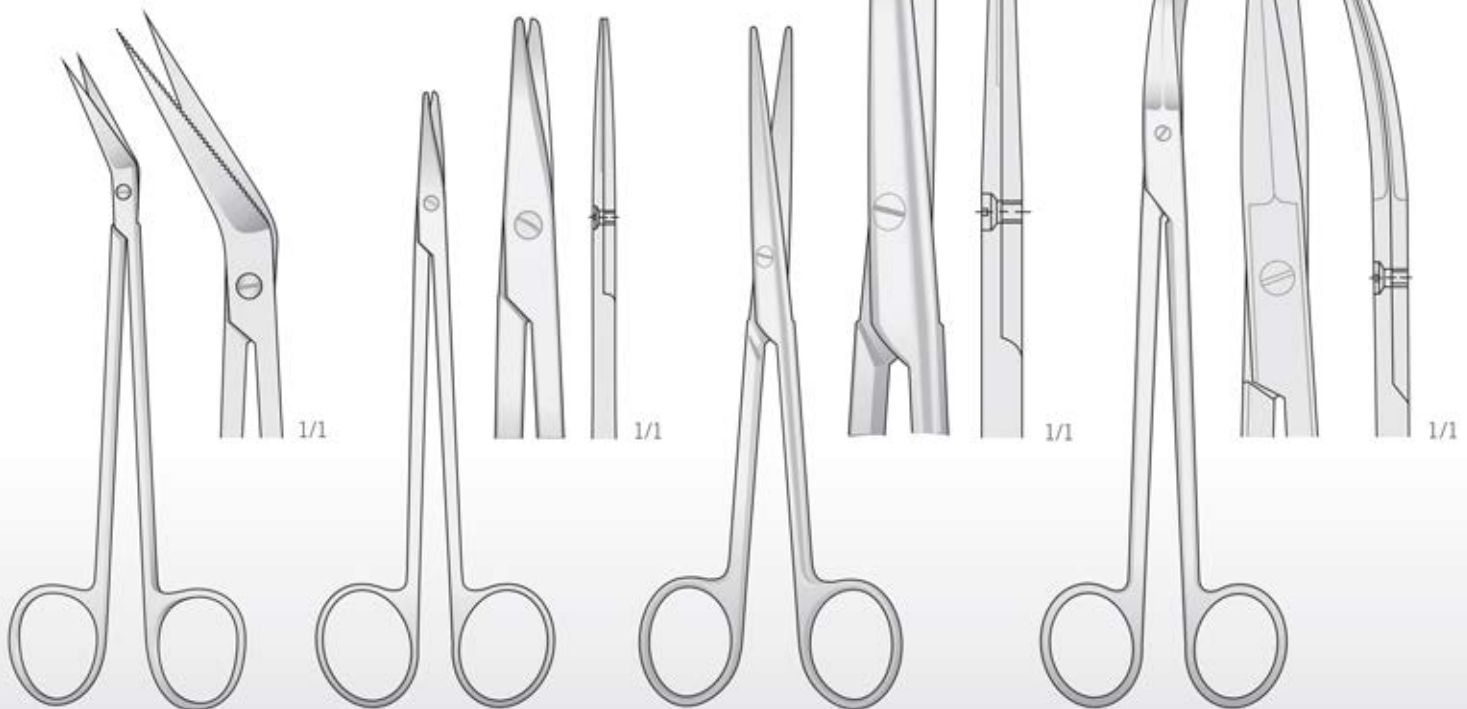

**LOCKLIN**  
**LK-4**  
 160 mm

**METZENBAUM**  
**FM-12**  
 150 mm

**LEXER**  
**FM-180**  
 165 mm

**FG-10**  
 185 mm



**General Surgery**  
Allgemeine Chirurgie  
Chirurgie générale  
Cirugia General  
Chirurgia Generale

Fein - Delicate  
Fine - Finas  
Fins

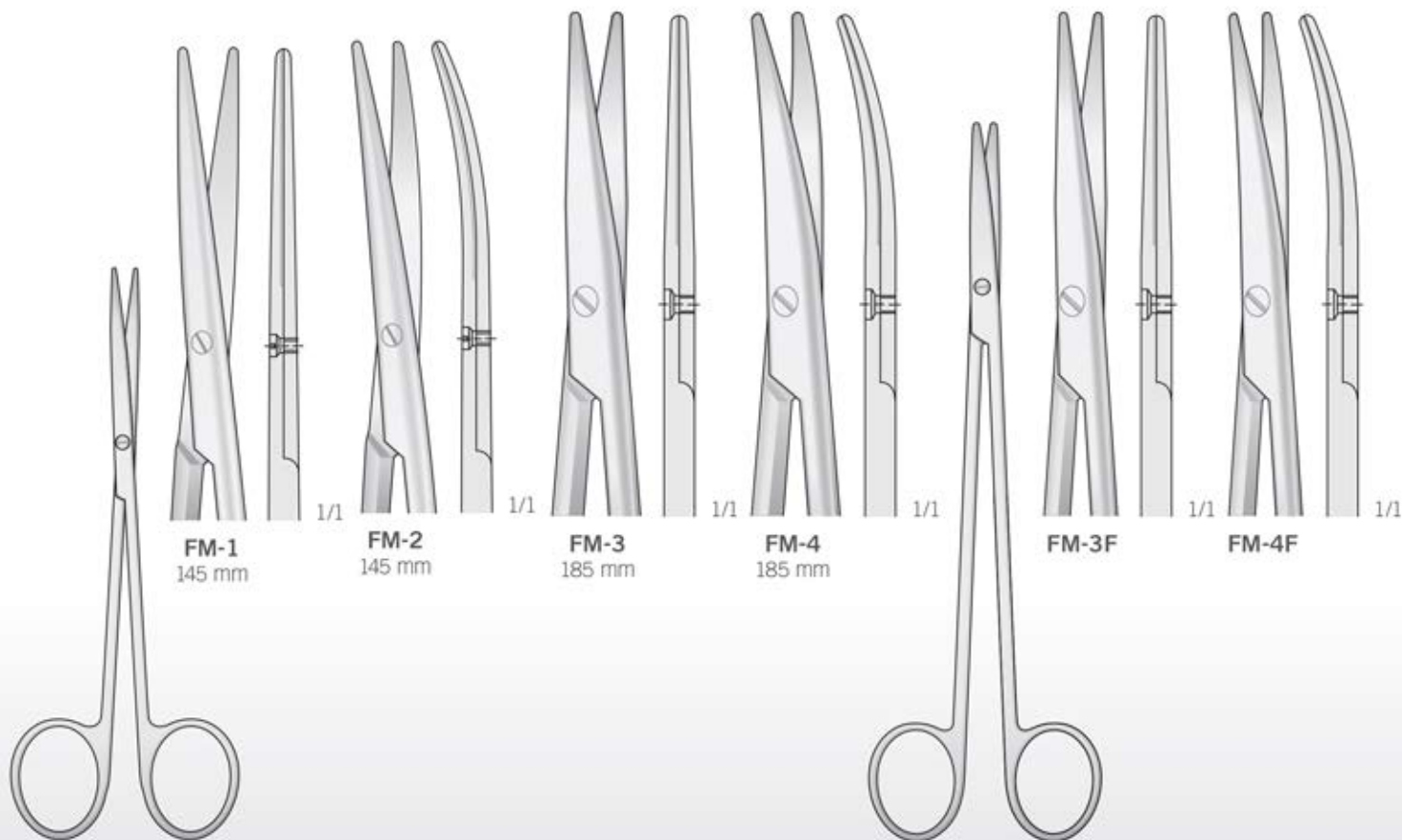

**FM-1**  
145 mm

**FM-2**  
145 mm

**FM-3**  
185 mm

**FM-4**  
185 mm

**FM-3F**

**FM-4F**

METZENBAUM  
**FM-1/FM-2**  
145 mm

METZENBAUM  
**FM-3F/FM-4F**  
185 mm



Scheren für Verbände  
 Scissors for bandages  
 Forbici per bende  
 Tijeras para vendajes  
 Ciseaux pour bandages

Schere zu entfernen Nähte  
 Scissors to remove sutures  
 Forbici per rimuovere suture  
 Tijeras para quitar las suturas  
 Des ciseaux pour enlever les sutures

Pinzette zum Entfernen von Drähten  
 Tweezers for removing wires  
 Pinza per rimozione punti metallici  
 Pinzas para quitar cables  
 Pince à épiler pour enlever les fils

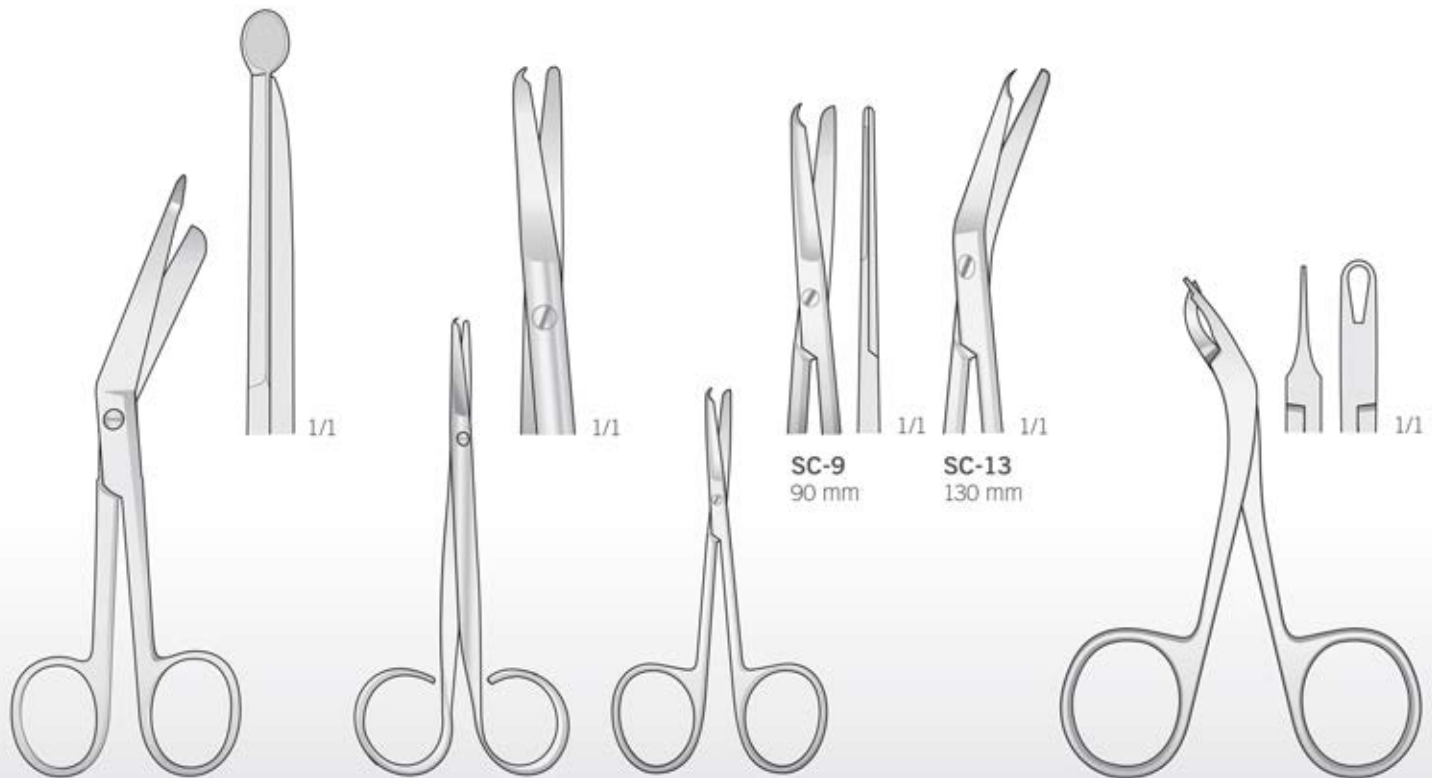

LISTER  
**FG-31** 145 mm  
**FG-32** 180 mm

SPENCER  
**SC-1**  
 110 mm

SPENCER  
**SC-9/SC-13**

**BF-64**  
 115 mm



**General Surgery**  
 Allgemeine Chirurgie  
 Chirurgie générale  
 Cirugía General  
 Chirurgia Generale

**TC**

Mit Hartmetalleinsätzen  
 Tungsten-carbide scissors  
 Forbici con lame al carburo di tungsteno  
 Tijeras con placas de carburo de tungsteno  
 Siseaux vec plaquettes en carbure de tungstène

Mit einer Schneide gezahnt  
 With one blade serrated  
 Con una lama dentellata  
 Con una hoja dentada  
 Avec une lame dentèle

Spitz  
 Sharp  
 Acuta  
 Aguda  
 Pointu

TC

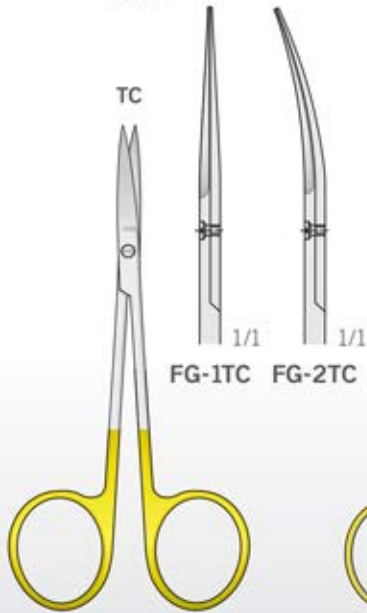

IRIS  
 FG-1TC/FG2-TC  
 115 mm

TC



METZENBAUM  
 FM-66/FM-69  
 145 mm

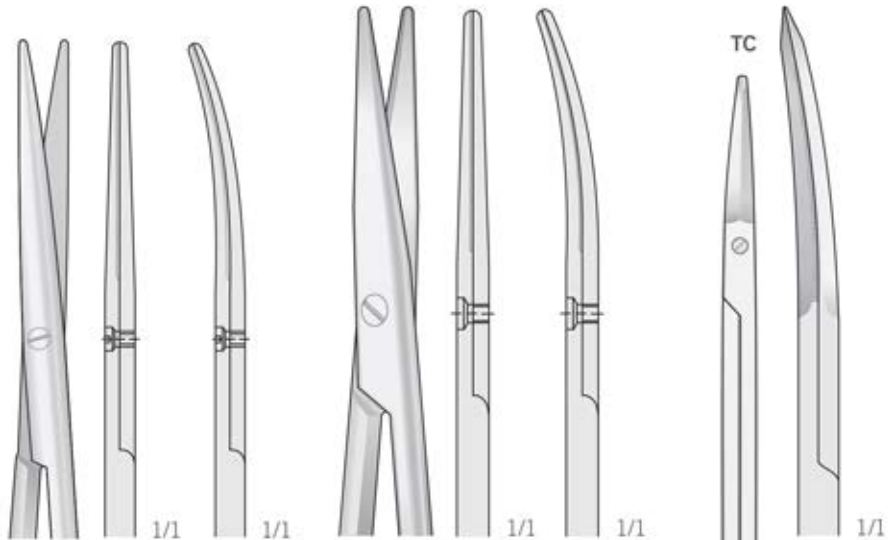

FM-66 145 mm  
 FM-67 145 mm

FM-68 185 mm  
 FM-69 185 mm

TC

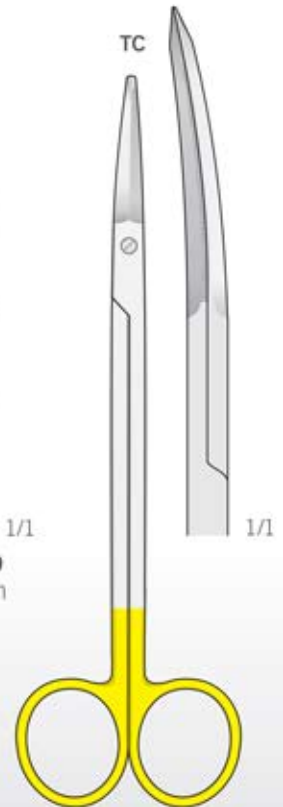

FACE-LIFT  
 FM-343  
 180 mm



### TC

Mit Hartmetalleinsätzen - Mit einer Schneide gezahnt  
Tungsten-carbide scissors - With one blade serrated  
Forbici con lame al carburo di tungsteno - Con una lama dentellata  
Tijeras con placas de carburo de tungsteno - Con una hoja dentada  
Siseaux vec plaquettes en carbure de tungstène - Avec une lame dentée

### Super Cut - TC

Mit Hartmetalleinsätzen - Mit einer Schneide gezahnt  
Tungsten-carbide scissors - With one blade serrated  
Forbici con lame al carburo di tungsteno - Con una lama zigrinata  
Tijeras con placas de carburo de tungsteno - Con una hoja dentada  
Siseaux vec plaquettes en carbure de tungstène - Avec une lame dentée

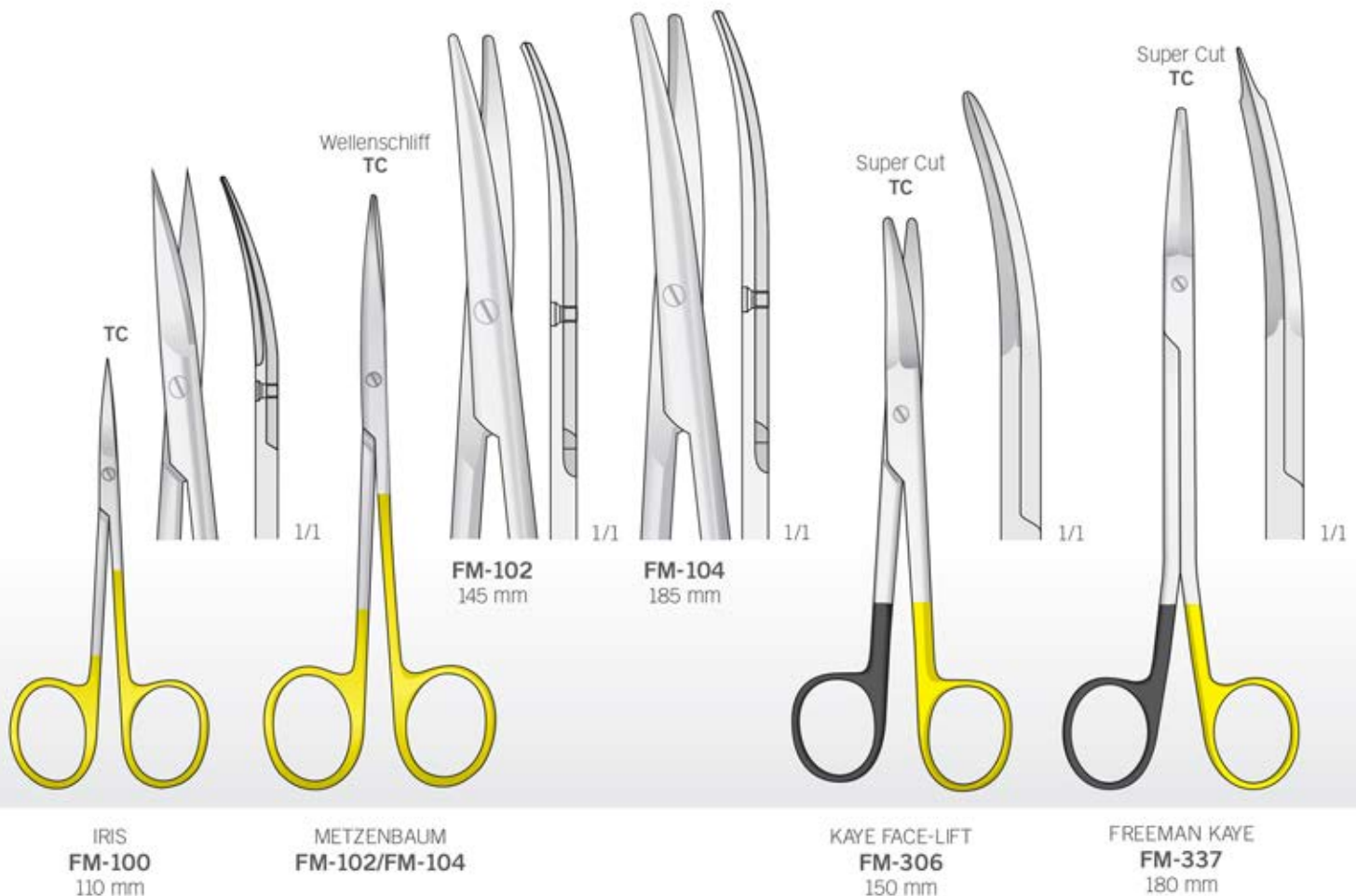



**General Surgery**  
Allgemeine Chirurgie  
Chirurgie générale  
Cirugia General  
Chirurgia Generale

## Super Cut

Mit Hartmetalleinsätzen - Mit einer Schneide gezahnt  
Tungsten-carbide scissors - With one blade serrated  
Forbici con lame al carburo di tungsteno - Con una lama zigrinata  
Tijeras con placas de carburo de tungsteno - Con una hoja dentada  
Siseaux vec plaquettes en carbure de tungstène - Avec une lame dentée





## ADSON

Chirurgische Pinzetten - Tissue Forceps  
Pinzette chirurgiche - Pinzas quirúrgicas  
Pincès chirurgicaux

Mit Hartmetalleinsätzen  
Tungsten-carbide scissors  
Con punta al carburo  
di tungsteno  
Con punta de carburo  
de tungsteno  
Avec plaquettes  
en carbure de tungstène

Mit Fadenplatte  
With tying platform  
Con piano prendifilo  
Con piattaforma  
Avec plaques pour monofil

Micro

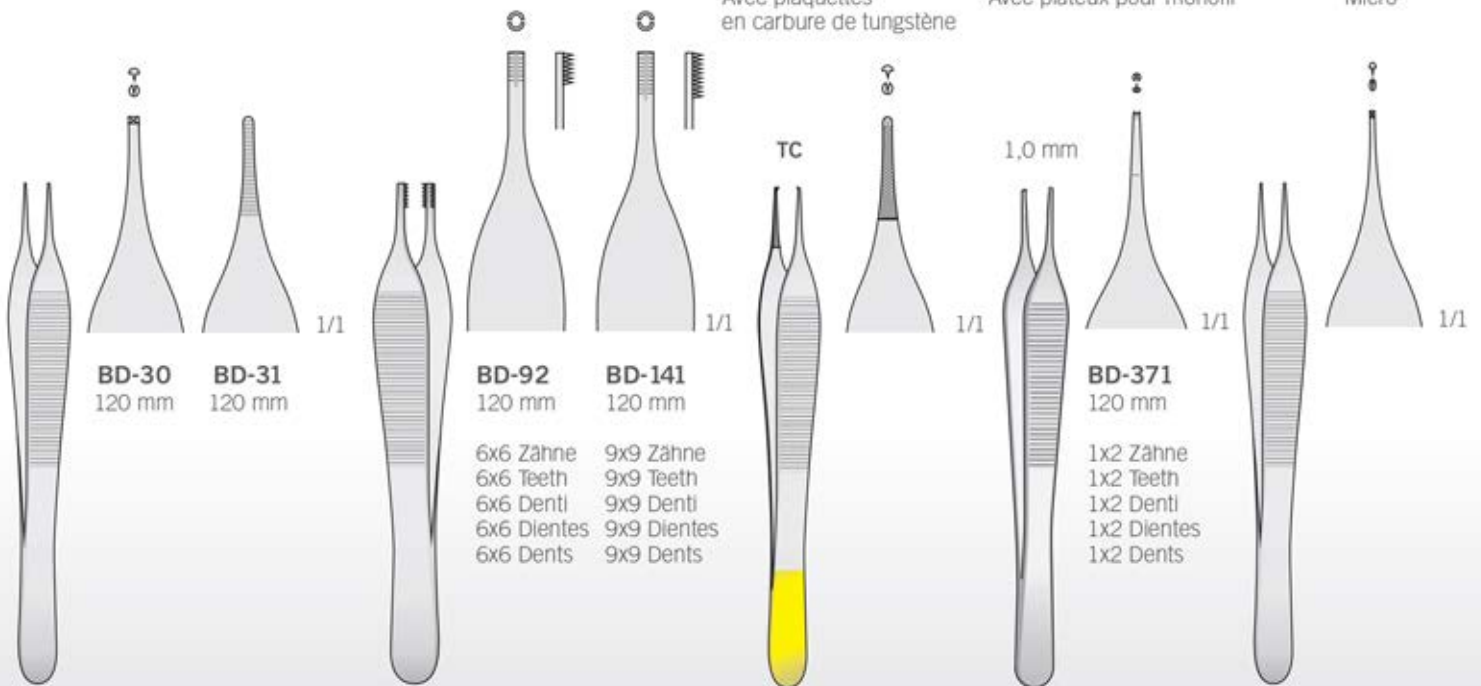

**BD-30**  
120 mm

**BD-31**  
120 mm

**BD-92**  
120 mm

**BD-141**  
120 mm

6x6 Zähne  
6x6 Teeth  
6x6 Denti  
6x6 Dientes  
6x6 Dents

9x9 Zähne  
9x9 Teeth  
9x9 Denti  
9x9 Dientes  
9x9 Dents

TC

1,0 mm

**BD-371**  
120 mm

1x2 Zähne  
1x2 Teeth  
1x2 Denti  
1x2 Dientes  
1x2 Dents

ADSON  
**BD-30/BD-31**

ADSON-BROWN  
**BD-92/BD-141**  
120 mm

ADSON  
**BD-250**  
120 mm

ADSON  
**BD-371**  
120 mm

ADSON  
**BD-73**  
120 mm





**General Surgery**  
 Allgemeine Chirurgie  
 Chirurgie générale  
 Cirugía General  
 Chirurgia Generale

Atraumatische pinzetten  
 Non-traumatic vascular tissue forceps  
 Pinzette atraumatische  
 Pinzas atraumáticas  
 Pinces atraumatiques

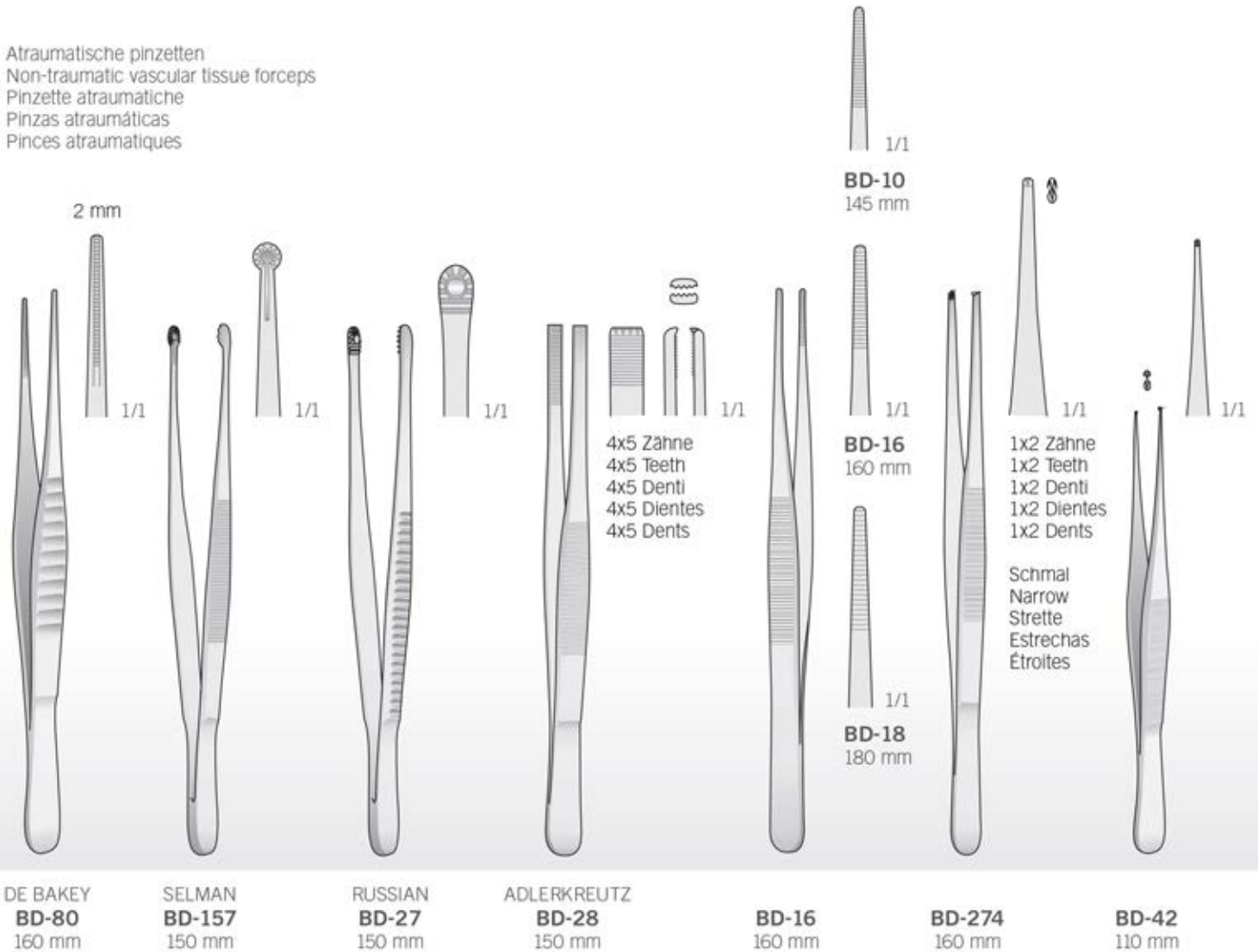

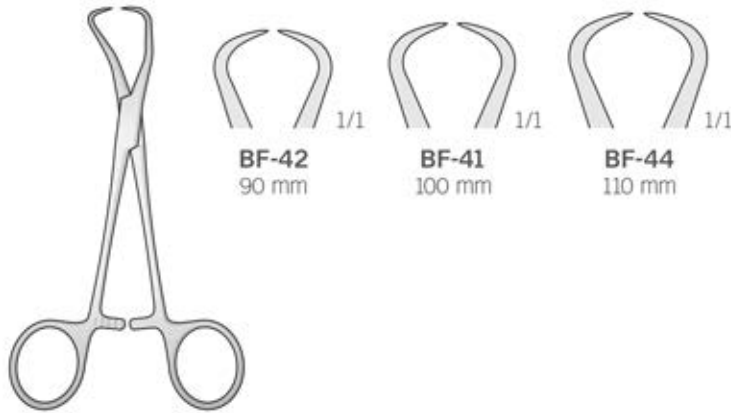

BACKHAUS  
 BF-41/BF-44

BF-42  
 90 mm

BF-41  
 100 mm

BF-44  
 110 mm

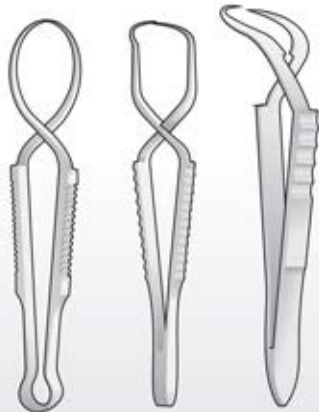

SCHAEDEL  
 BF-38  
 85 mm

FAURE  
 BF-40  
 85 mm

JONES  
 BF-48  
 90 mm

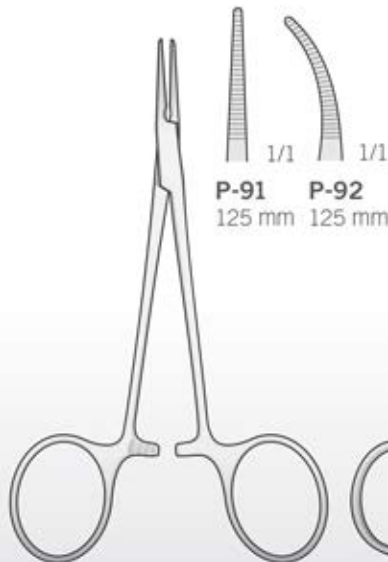

P-91  
 125 mm

P-92  
 125 mm

HALSTED  
 P-91/P-92  
 125 mm

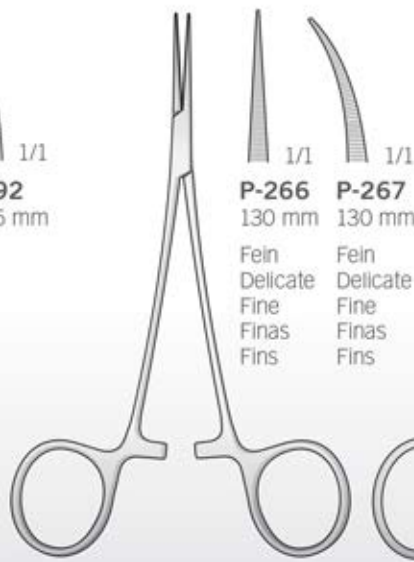

P-266  
 130 mm

P-267  
 130 mm

Fein  
 Delicate  
 Fine  
 Finas  
 Fins

Fein  
 Delicate  
 Fine  
 Finas  
 Fins

JACOBSON-MICRO  
 P-266/P-267  
 130 mm

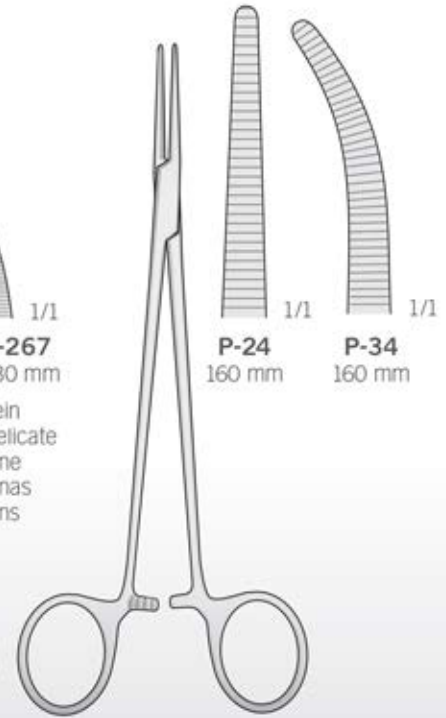

P-24  
 160 mm

P-34  
 160 mm

PEAN  
 P-24/P-34  
 160 mm



**General Surgery**  
 Allgemeine Chirurgie  
 Chirurgie générale  
 Cirugía General  
 Chirurgia Generale

Elastisch  
 Elastic  
 Elastiche  
 Elásticas  
 Elastic



Atraumatische  
 Atraumatic  
 Atraumatiche  
 Atraumáticas  
 Atraumáticas

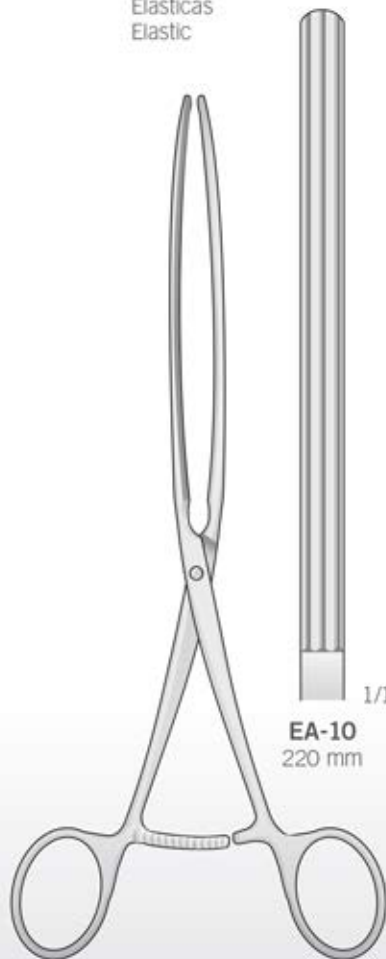

KOCHER  
 EA-10

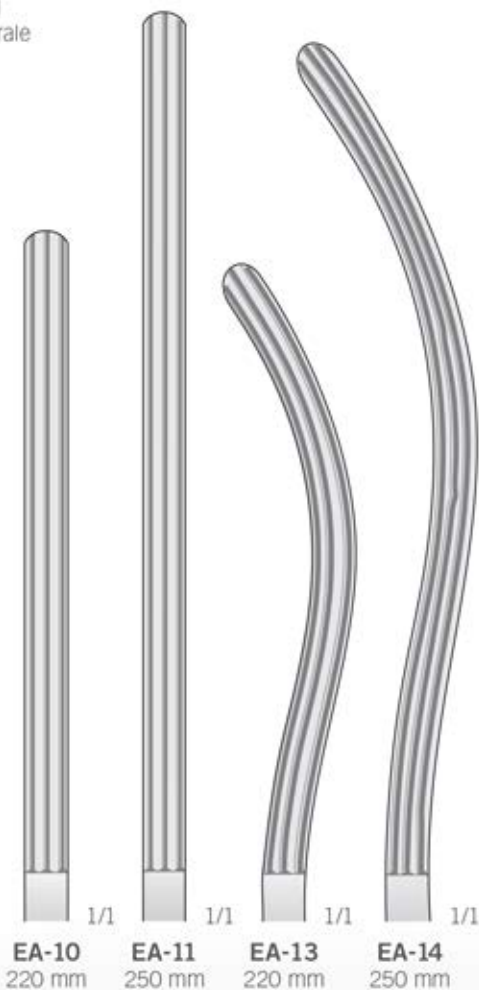

Darklemmen  
 Intestinal Clamps  
 Pinze intestinali  
 Pinzas intestinales  
 Pincas intestinales

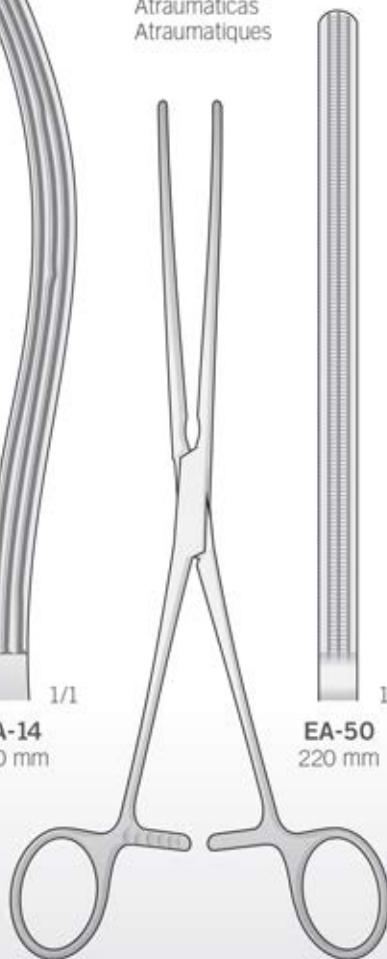

KOCHER  
 EA-53

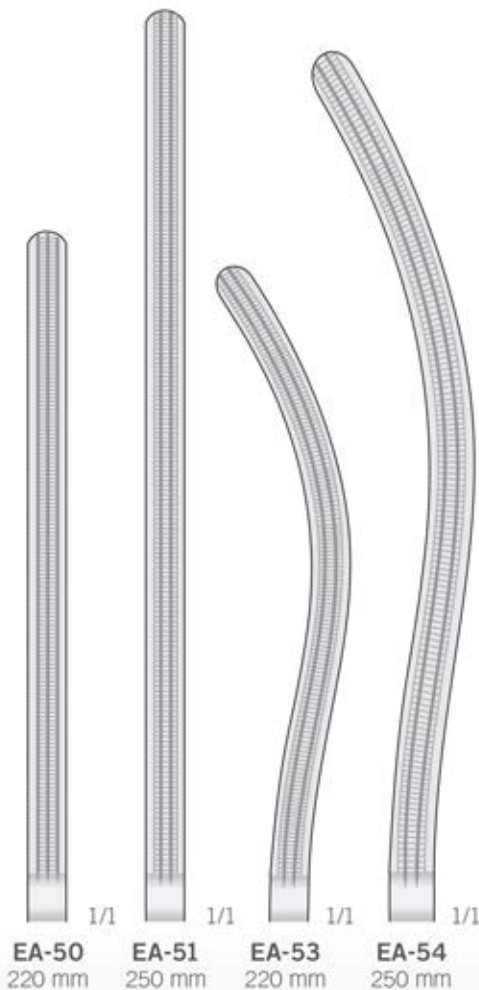

Darklemmen  
 Intestinal Clamps  
 Pinze intestinali  
 Pinzas intestinales  
 Pincas intestinales



Atraumatische  
Atraumatic  
Atraumatiche  
Atraumáticas  
Atraumatiques

Atraumatische  
Atraumatic  
Atraumatiche  
Atraumáticas  
Atraumatiques



Atraumatische  
Atraumatic  
Atraumatiche  
Atraumáticas  
Atraumatiques

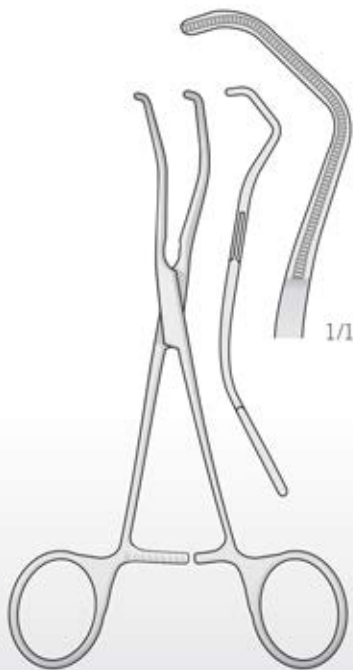

COOLEY  
**FB-16**  
160 mm

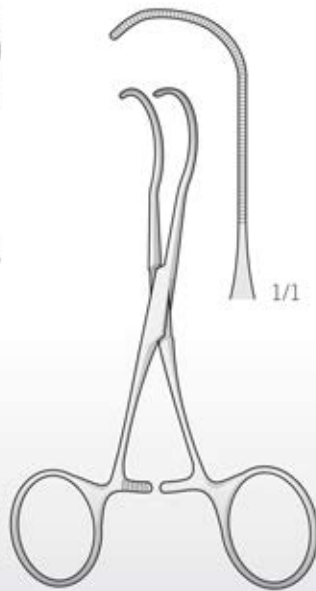

CASTANEDA  
**FB-256**  
120 mm

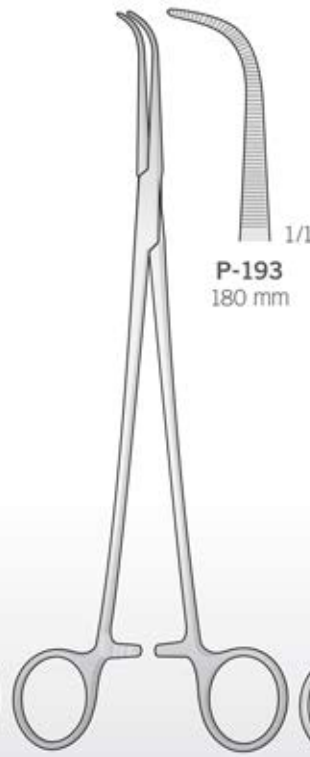

GEMINI  
**P-193**

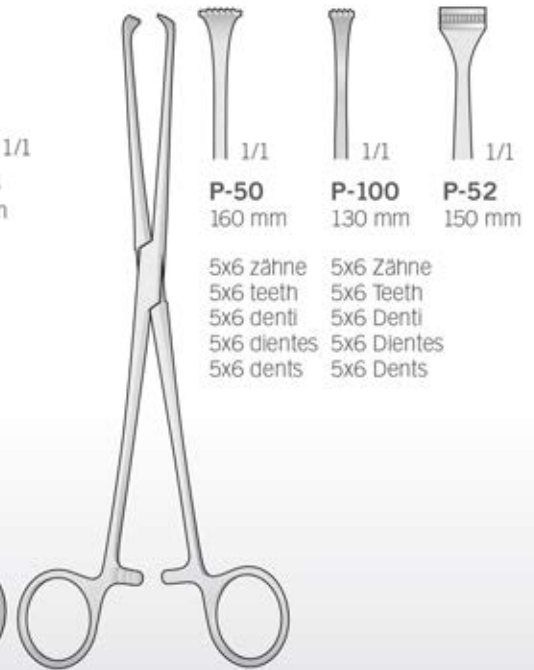

ALLIS  
**P-50/P-100**



**General Surgery**  
 Allgemeine Chirurgie  
 Chirurgie générale  
 Chirurgia General  
 Chirurgia Generale

Absaugkanülen- Vacuums - Aspiratori  
 Aspiradoras - Aspirateurs

- GF-75**  
5x2 mm  
190 mm
- GF-76**  
6x2,5 mm  
200 mm
- GF-77**  
7x3 mm  
200 mm

Fein-modell - Delicate Model  
 Modello fine - Modelo delgada  
 Mince modèle



- DB-120** L.85 mm
- DB-121** L.140 mm
- DB-122** L.165 mm



HARTMANN  
**DB-120/DB-121/DB-122**  
 L. 85 mm

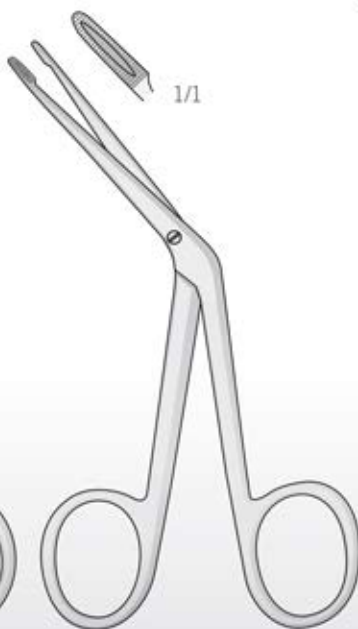

HARTMANN  
**DB-114**  
 140 mm



**GF-75/GF-77**  
 200 mm



**GF-09**  
 230 mm



POOLE  
**GF-29**  
 220 mm



POOLE  
**GF-22**  
 190 mm



Saug- und Spölinstrumente  
 Aspirating and Irrigating Instruments  
 Strumenti per aspirazione e lavaggio  
 Instrumentos de aspiración y de lavado  
 Instruments à aspiration et à irrigation

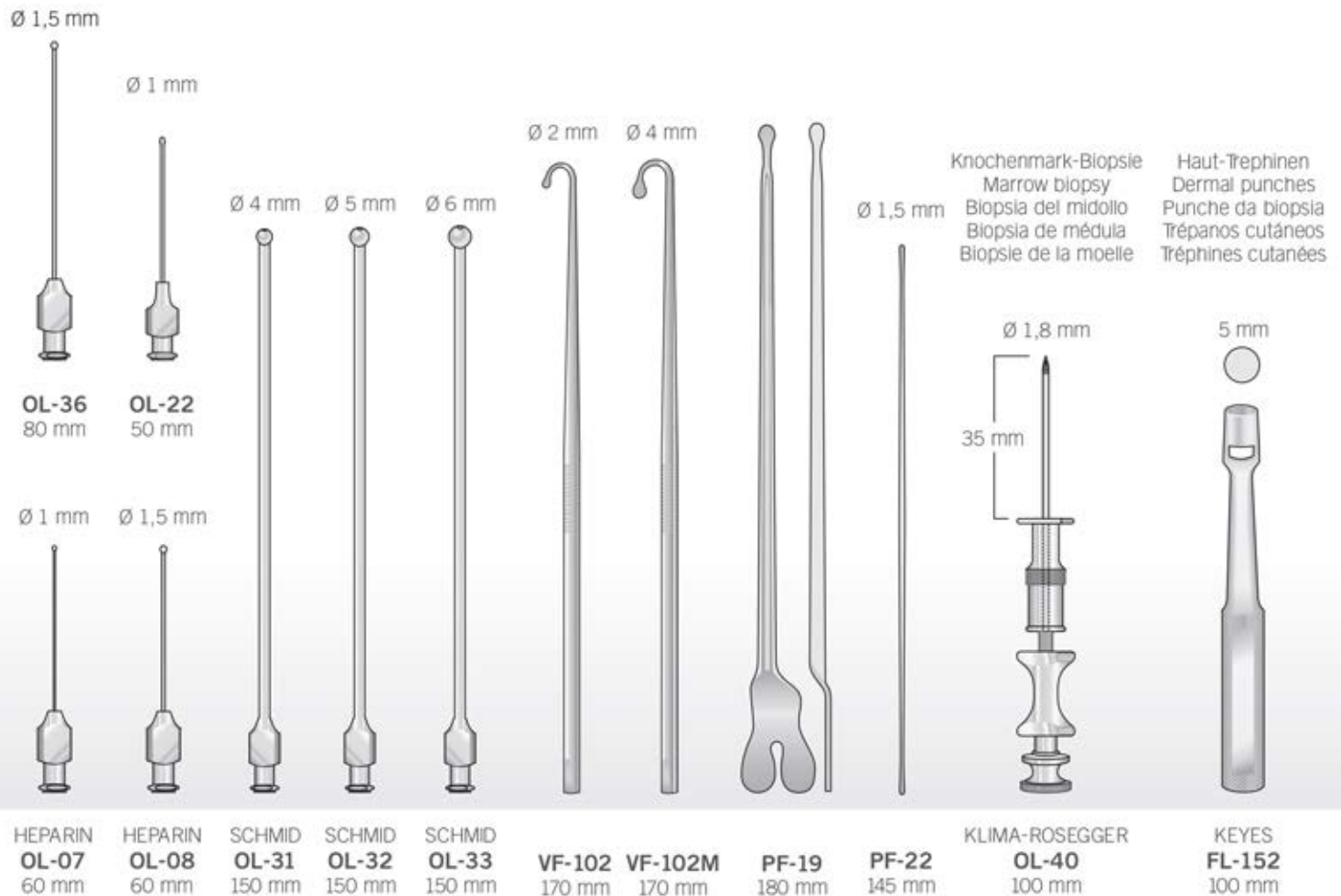



**General Surgery**  
 Allgemeine Chirurgie  
 Chirurgie générale  
 Cirurgia General  
 Chirurgia Generale

Empfohlen für Nähnadeln - Recommended for suture needles  
 Raccomandato per aghi da sutura - Recomendado para agujas de sutura  
 Recommandé pour les aiguilles à suture



Standard - Regular - Regolare  
 Regular - Régulière  
**2.0, 3.0, 4.0**



Fein - Fine - Fine  
 Fino - Fin  
**3.0, 4.0, 5.0, 6.0**



Mikro - Micro - Micro  
 Micro - Micro  
**6.0, 7.0, 8.0, 9.0**



Glatt - Smooth - Liscia  
 Lisa - Lisse  
**7.0, 8.0, 9.0, 10.0**

Nadelhalter mit Hartmetalleinlagen - Needle Holders with tungsten-carbide inserts  
 Portaghi con inserti al tungsteno - Portaagujas con placas de carburo de tungsteno  
 Porte aiguilles avec plaquettes en carbure de tungstène

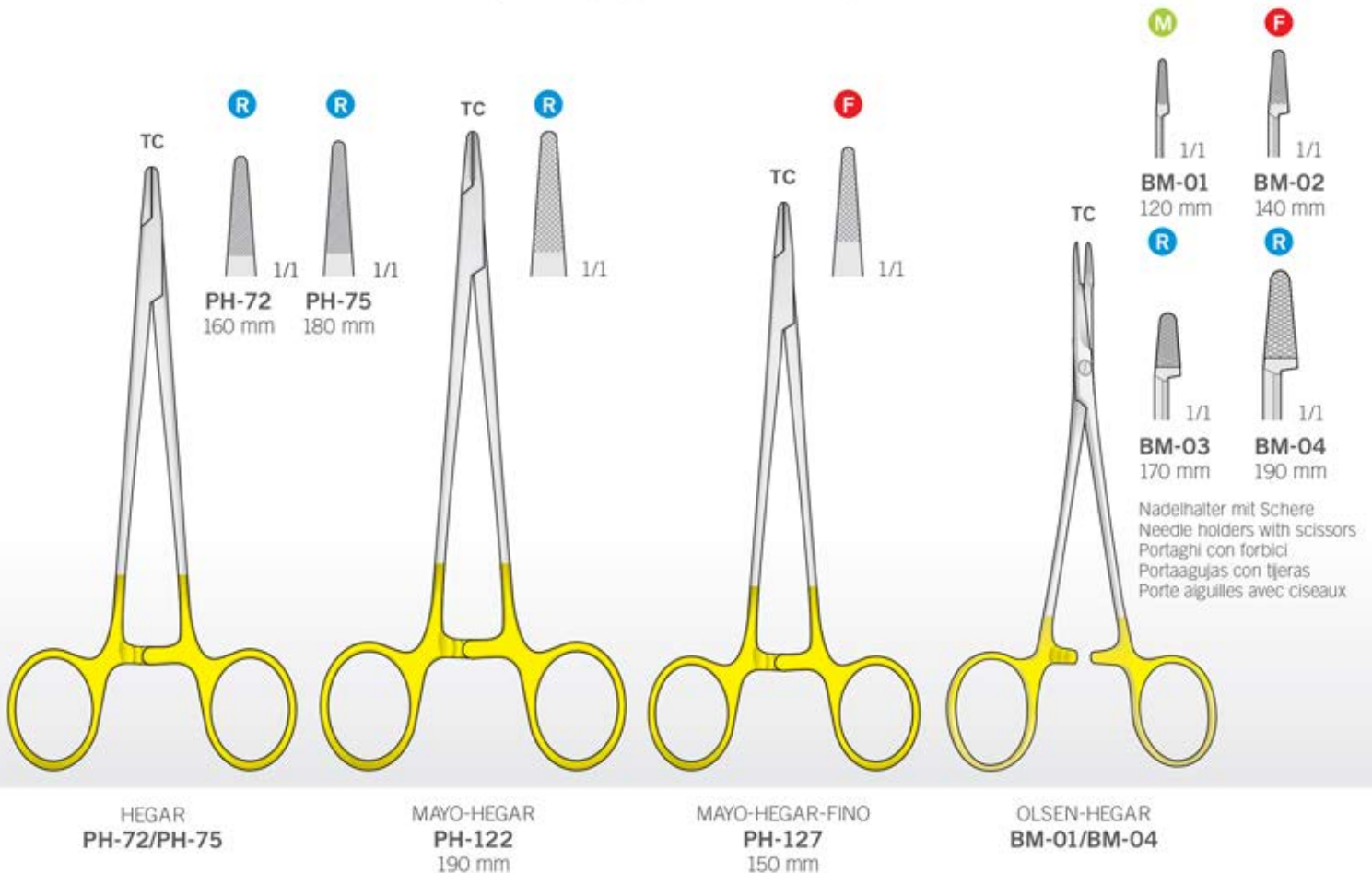

Empfohlen für Nähnadeln - Recommended for suture needles  
 Raccomandato per aghi da sutura - Recomendado para agujas de sutura  
 Recommandé pour les aiguilles à suture



Standard - Regular - Regolare  
 Regular - Regulaire  
**2.0, 3.0, 4.0**



Fein - Fine - Fine  
 Fino - Fin  
**3.0, 4.0, 5.0, 6.0**



Mikro - Micro - Micro  
 Micro - Micro  
**6.0, 7.0, 8.0, 9.0**



Glatt - Smooth - Liscia  
 Lisa - Lisse  
**7.0, 8.0, 9.0, 10.0**

**General Surgery**  
 Allgemeine Chirurgie  
 Chirurgie générale  
 Cirurgia General  
 Chirurgia Generale



Nadelhalter mit Hartmetalleinlagen - Needle Holders with tungsten-carbide inserts  
 Portaghi con inserti al tungsteno - Portaagujas con placas de carburo de tungsteno  
 Porte aiguilles avec plaquettes en carbure de tungstène

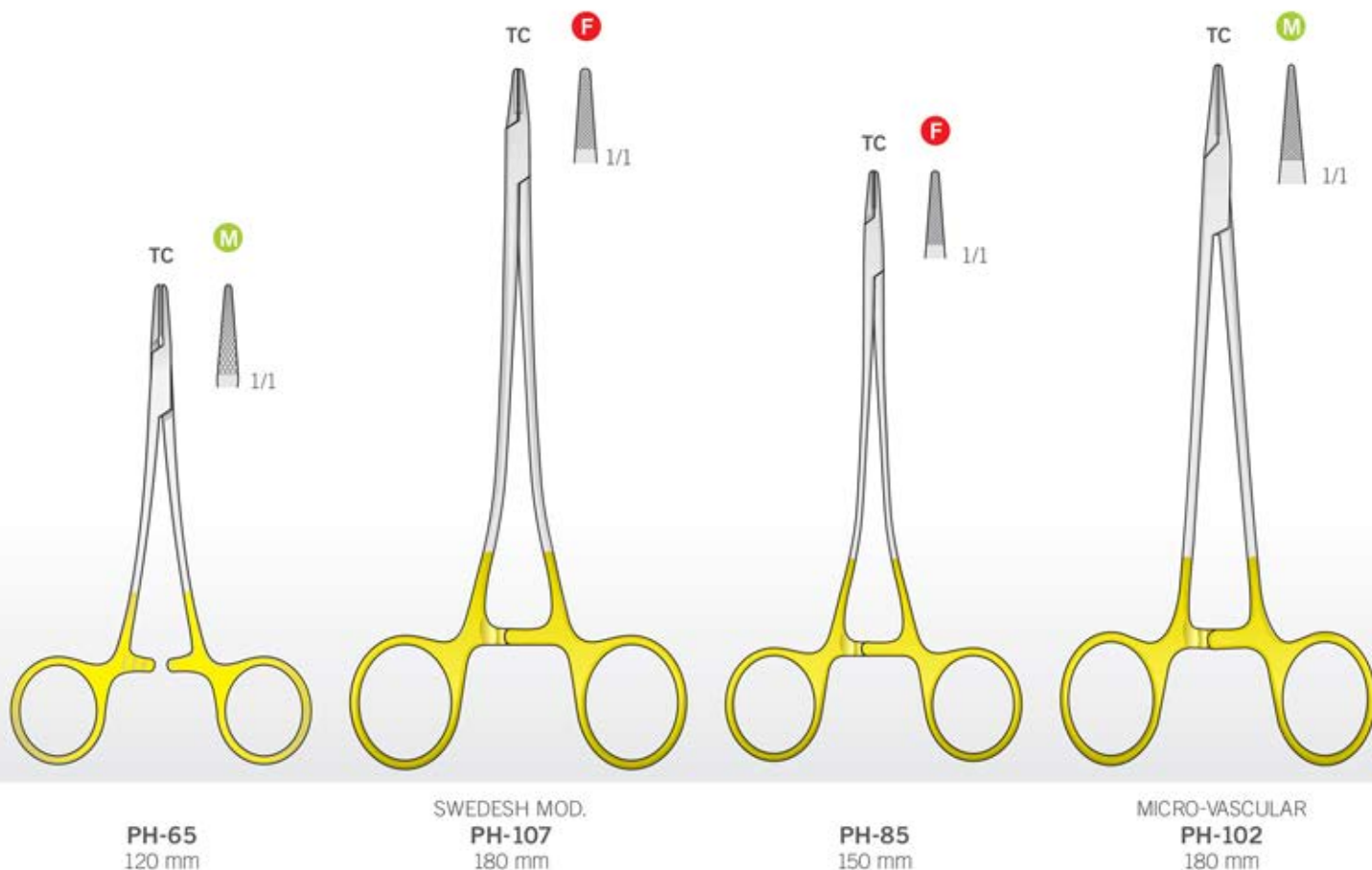





**General Surgery**  
 Allgemeine Chirurgie  
 Chirurgie générale  
 Cirurgia General  
 Chirurgia Generale

Empfohlen für Nähnadeln - Recommended for suture needles  
 Raccomandato per aghi da sutura - Recomendado para agujas de sutura  
 Recommandé pour les aiguilles à suture



Standard - Regular - Regolare  
 Regular - Regulaire  
**2.0, 3.0, 4.0**



Fein - Fine - Fine  
 Fino - Fin  
**3.0, 4.0, 5.0, 6.0**



Mikro - Micro - Micro  
 Micro - Micro  
**6.0, 7.0, 8.0, 9.0**



Glatt - Smooth - Liscia  
 Lisa - Lisse  
**7.0, 8.0, 9.0, 10.0**

Kräftiges Modell - Heavy pattern  
 Modelo robusto - Modelo sólido  
 Modèle robuste

Mit Schere - With Scissors  
 Con Forbice - Con Tijeras  
 Avec Ciseaux

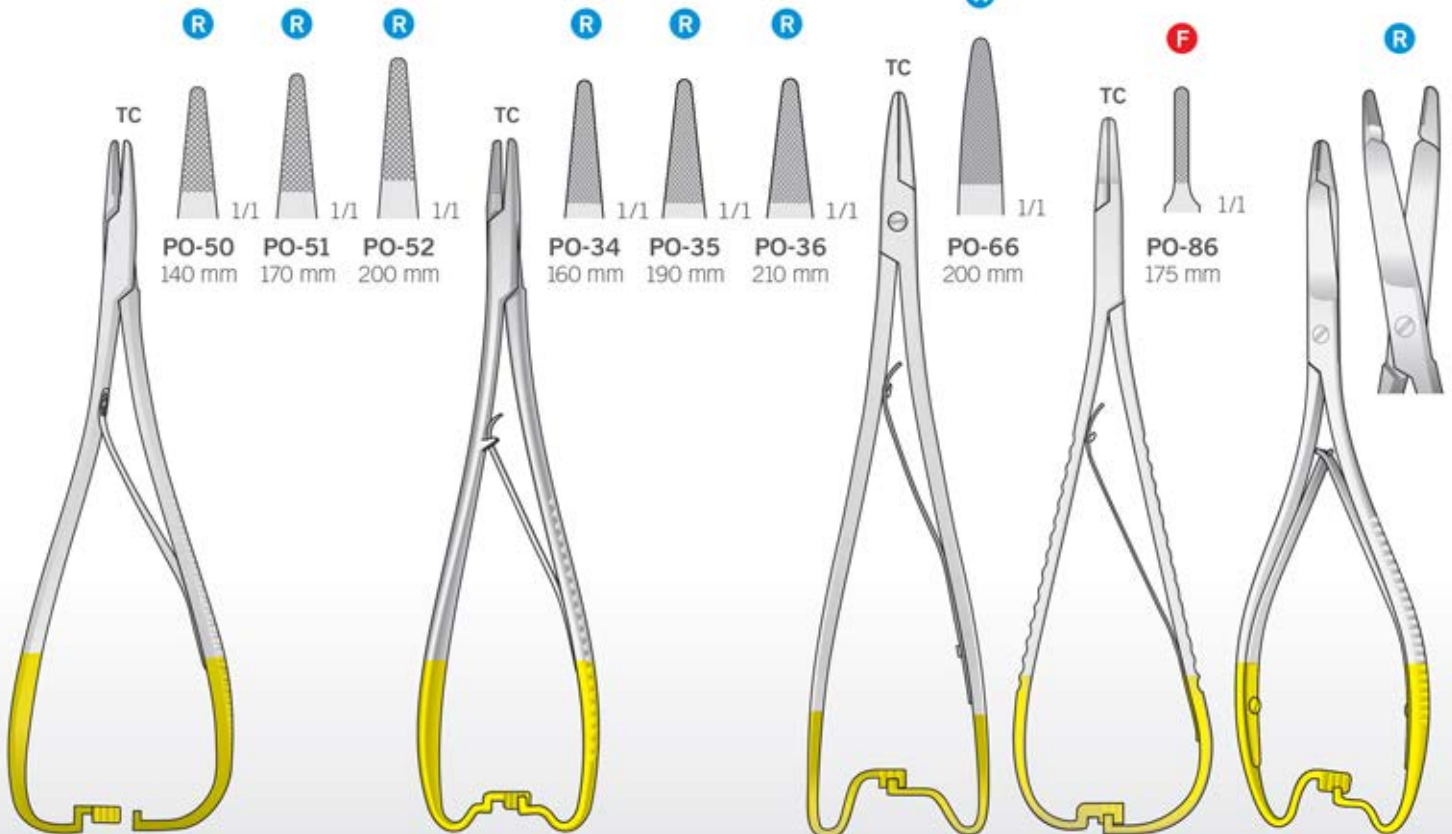

MATHIEU  
**PO-50/PO-52**

MATHIEU  
**PO-34/PO-36**

MATHIEU  
**PO-66**  
 200 mm

LICHTENBERG  
**PO-86**  
 175 mm

OLSEN-MATHIEU  
**PO-95** 140 mm  
**PO-98** 170 mm  
**PO-100** 200 mm

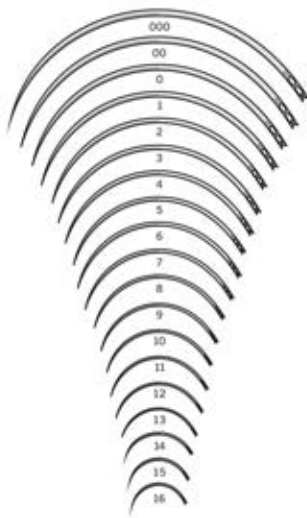

Art.	Eye	Profile
BN-502/000		▼
BN-502/00		▼
BN-502/0		▼
BN-502/1		▼
BN-502/2		▼
BN-502/3		▼
BN-502/4		▼
BN-502/5		▼
BN-502/6		▼
BN-502/7		▼
BN-502/8		▼
BN-502/9		▼
BN-502/10		▼
BN-502/11		▼
BN-502/12		▼
BN-502/13		▼
BN-502/14		▼
BN-502/15		▼
BN-502/16		▼

Farbige Ringe aus Silikon zu kodieren Chirurgie-Kits  
Colored rings in silicone to encode surgical kits  
Anelli colorati in silicone per codificare kit chirurgici  
Anillos de colores en silicona para codificar set quirúrgico  
Bagues colorées en silicone pour encoder des kits de chirurgie



**DB-941** box 120 pcs.  
**DB-942** box 175 pcs.

Farbige Bänder  
Colored ribbons  
Nastri colorati per codificare kit chirurgici  
Cintas de colores  
Rubans colorés



**DB-940**  
box 8 colours



**Dental Surgery**  
 Zahnärztliche Chirurgie  
 Chirurgie Dentaire  
 Cirugía Dental  
 Chirurgia Dentale

<p>Mini-Wurzelheber        Root Mini Elevators        Mini Leve per radici        Mini Elevadores para raíces        Mini Élévateurs à racines</p>				<p>Luxatoren für Schneidezähne        Incisors Luxators        Lussatori per incisivi        Luxadores para incisivos        Luxateurs pour incisives</p>			<p>Erweitert Wange        Widens Cheek        Allargaguancia        Amplía-mejilla        Élargit la joue</p>	
<p>Concave botton        Ø 1,0 mm</p> <p>Concave top        Ø 1,0 mm</p>			<p>Ø 1,0 mm</p>	<p>1/1</p>	<p>Mundsperrer        Mouth Gags        Apribocca        Abreboca        Ecateur buccal</p>		<p>VF-121        60 mm</p>	
<b>US DL-401</b> 155 mm	<b>US DL-402</b> 155 mm	<b>US DL-403</b> 155 mm	<b>US DL-500</b> 130 mm	<b>MIR-12</b> 155 mm	<b>VF-127</b> 185 mm	<b>VF-126</b> 160 mm	SCHMIDTKE <b>VF-120</b> 120 mm	<b>VF-122</b> 85 mm



Katzen - Cats  
Gatti - Gatos  
Chats

**VH-48** 60 mm  
**VH-49** 80 mm



Hunde - Dogs  
Canl - Perros  
Chiens

**VH-50** 110 mm  
**VH-51** 160 mm

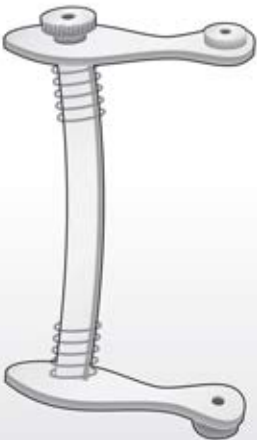

**TC**

Mit Hartmetalleinsätzen  
With Hard Metal Inserts  
Con punte in metallo duro  
Con puntas de metal duro  
Avec mors en métal dur

Zange zum Abkneifen  
von Ferkeelzähnen  
Forceps for trimming teeth  
for small animals  
Pinza per tagliare denti  
di piccoli animali  
Pinza para cortar dientes  
de pequeños animales  
Pinces à couper les dents  
des petits animaux

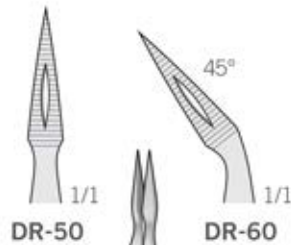

**DR-50**

**DR-60**



**LX-98**  
175 mm

4,5 mm

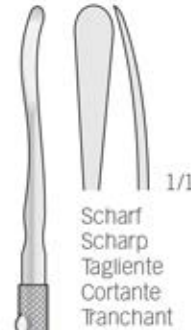

Scharf  
Scharp  
Tagliente  
Cortante  
Tranchant



**L-21**

**L-27**

**L-26**

Stumpf  
Blunt  
Smusso  
Romo  
Mousse



**L-28**

**L-29**

**VH-48/VH-51**

STIEGLITZ  
**DR-50/DR-60**  
140 mm

**FREER**  
180 mm

**SD-M**

2,2 mm

3,0 mm

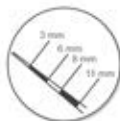

Eine seite gezahnt  
 One side serrated  
 Un lato dentellato  
 Un lado dentado  
 Dentelure sur un côté



DL-78  
155 mm



DL-79  
155 mm



1/1  
DA-02  
130 mm



Pack. 12 pcs.

RH-4 22 mm



1/1  
DA-01  
130 mm



Massiv  
Solid  
Pleno  
Sólido  
Massif

Rostfrei  
Stainless  
Inox  
Inoxidable  
Inoxydable

FAHRENKRUG  
DL-05  
190 mm

FAHRENKRUG  
DL-06  
190 mm

CP-11  
SM-11  
160 mm

CP-12S  
SM-13  
160 mm

DL-78/DL-79  
155 mm

DA-01/DA-02  
130 mm

MA-2  
125 mm

Fig. 100L Fig. 100R



Wurzelheber  
 Root Elevators  
 Leve per radici  
 Elevadores para raíces  
 Elévateurs à racines

Luxatoren  
 Luxators  
 Lussatori  
 Luxadores  
 Luxateurs

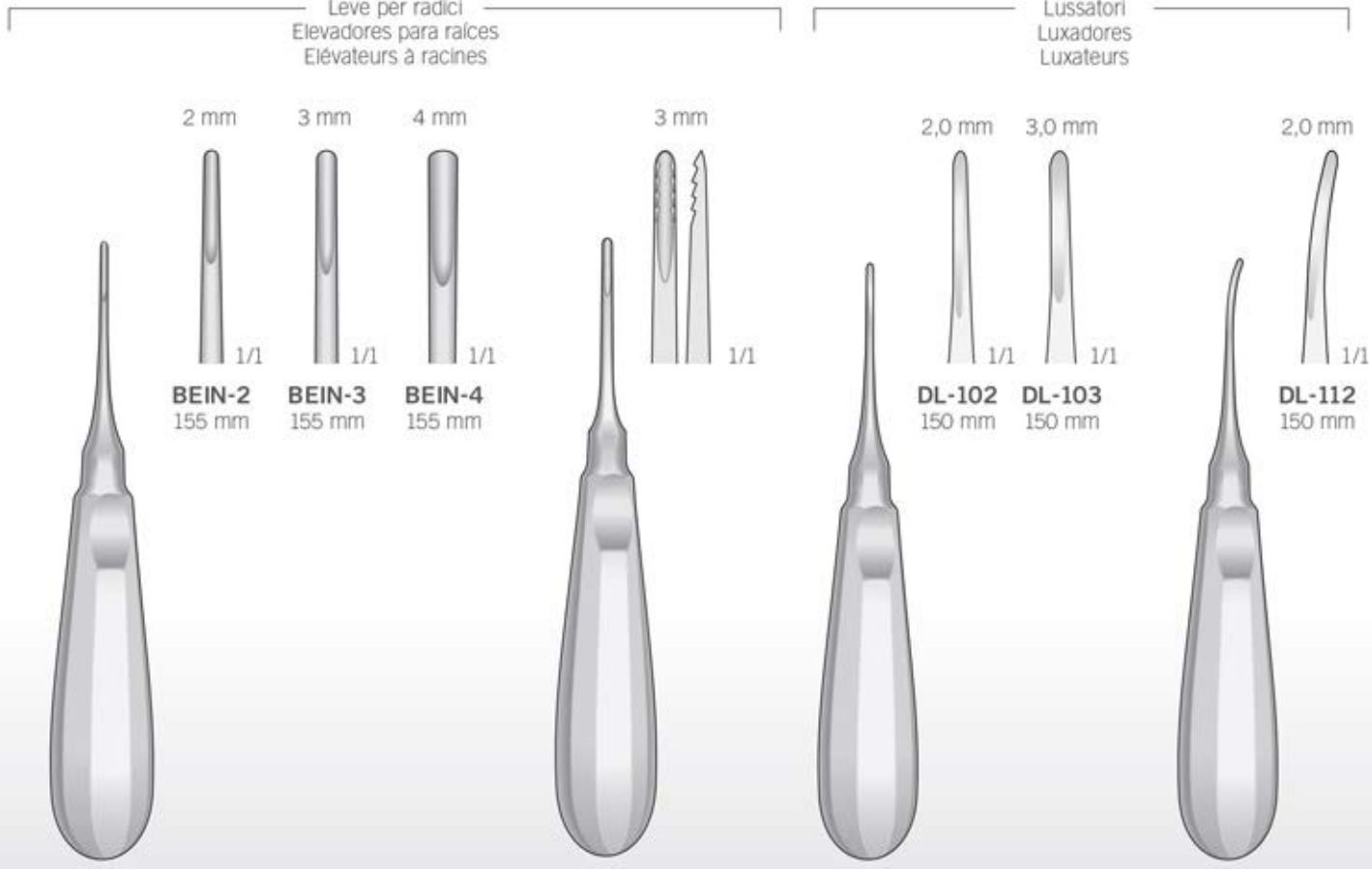

**BEIN-2/BEIN-4**  
155 mm

**BEIN-2Z**  
155 mm

**DL-102/DL-103**  
150 mm

**DL-112**  
150 mm



1/1

**56**

Zum Trennen Unterer Molarenwurzeln  
 For separating lower molar roots  
 Per radici dei molari inferiori, presa in profondità  
 Para separar raíces de molares inferiores profundos  
 Pour séparer les racines des molaires inférieures



1/1

**PEB-5**

Untere Schneidezähne  
 Lower incisors  
 Incisivi inferiori  
 Incisivos inferiores  
 Incisives inférieures



1/1

**PEB-3**

Obere Molaren  
 Upper molars  
 Molari superiori  
 Molares superiores  
 Molaires supérieures



1/1

**PEB-2**

Obere Prämolaren  
 Upper Premolars  
 Premolari superiori  
 Premolares superiores  
 Prémolaires supérieures



1/1

**PEB-1**

Obere Schneidezähne  
 Upper Incisors  
 Incisivi superiori  
 Incisivos superiores  
 Incisives supérieures



1/1

**1**

Obere Schneide  
 und Eckzähne

Upper Incisors  
 and cuspids

Incisivi e canini  
 superiori

Incisivos y caninos  
 superiores

Incisives et canines  
 supérieures



1/1

**30**

Obere Wurzeln

Upper Roots

Radici superiori

Raíces superiores

Racines supérieures



1/1

**49**

Obere Wurzeln  
 sehr feine

Upper very  
 fine roots

Radici superiori  
 molto sottili

Raíces superiores  
 muy finas

Racines supérieures  
 très fines



1

30/56

49

PEB-1/PEB-5



Universal Küretten  
 Universal Curettes  
 Curette universall  
 Curetas universales  
 Curettes universelles

Küretten  
 Curettes  
 Curette  
 Curetas  
 Curettes

Scaler

Periotome  
 Periotomes  
 Periotomi  
 Periostõtomas  
 Périotomes

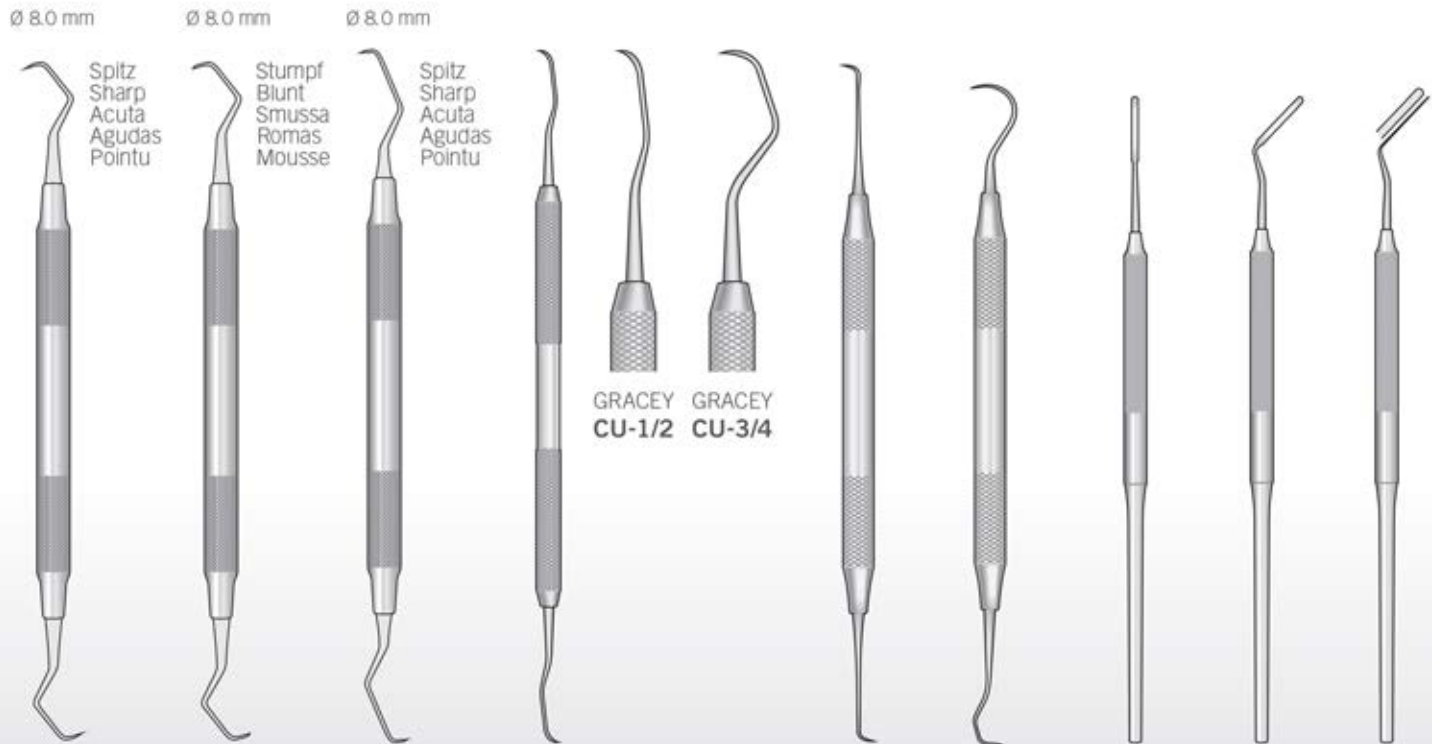

**718-M23**  
165 mm

**718-M23A**  
165 mm

**718-M23B**  
170 mm

GRACEY  
**CU-1/2/CU-3/4**

GOLDMAN-FOX TOWNER-  
**718-277** JAQUETTE  
**719-111**

**MC-11**  
160 mm

**MC-12**  
160 mm

**MC-13**  
160 mm



Periostale  
 Periosteal  
 Scollatori  
 Perióstica  
 Décolleur

Scharf  
 Sharp  
 Taglienti  
 Afilado  
 Tranchant

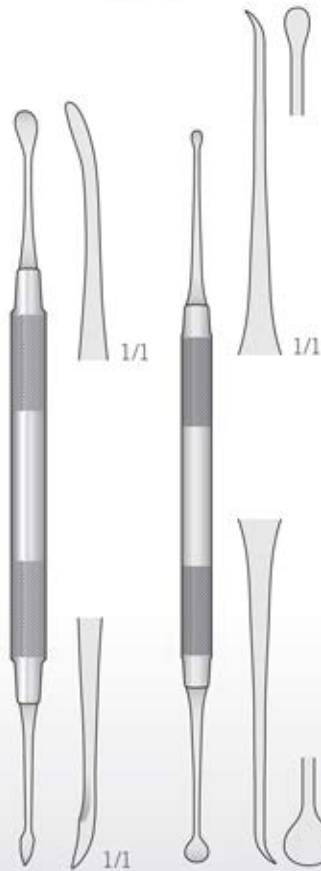

MOLT  
**MO-8**  
 185 mm

MOLT  
**MO-10**  
 180 mm

R-2

R-3

HOLLENBACK  
**715-102**  
**715-103**



715-102

715-103

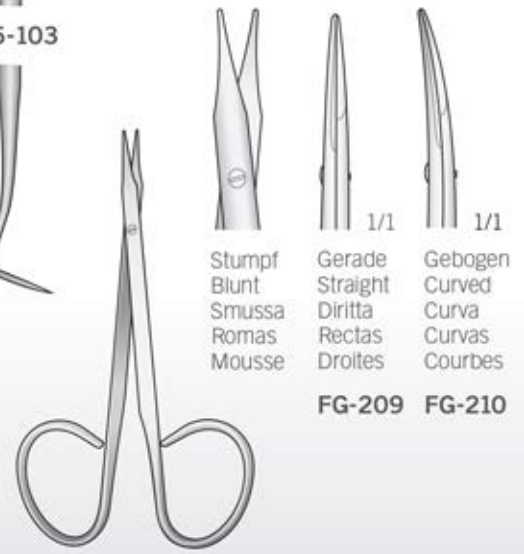

STEVENS  
**FG-209/FG-210**  
 100 mm

Stumpf  
 Blunt  
 Smussa  
 Romas  
 Mousse

Gerade  
 Straight  
 Diritta  
 Rectas  
 Droites

Gebogen  
 Curved  
 Curva  
 Curvas  
 Courbes

**FG-209** **FG-210**



**OR-17** - 90 mm  
 Meßbereich: 0 - 20 mm  
 Measuring range: 0 - 20 mm  
 Campo di misura: 0 - 20 mm  
 Alcance de medición: 0 - 20 mm  
 Etendue de mesure: 0 - 20 mm

**OR-12** - 170 mm  
 Meßbereich: 0 - 40 mm  
 Measuring range: 0 - 40 mm  
 Campo di misura: 0 - 40 mm  
 Alcance de medición: 0 - 40 mm  
 Etendue de mesure: 0 - 40 mm

CASTROVIEJO  
**OR-12/OR-17**

Augenlid  
 Eyelid  
 Blefarostati  
 Párpado  
 Paupière

Stumpf  
 Blunt  
 Smussa  
 Romo  
 Mousse



**FD-64**

Stumpf  
 Blunt  
 Smussa  
 Romo  
 Mousse



**FD-41**

Hornhaut Schere  
 Corneal scissors  
 Forbici corneali  
 Tijeras de córnea  
 Corneal ciseaux

Universal  
 Universal  
 Universale  
 Universal  
 Universel

<b>NK-80</b>	27 mm	5 mm
<b>NK-82</b>	34 mm	9 mm
<b>NK-84</b>	42 mm	12 mm
<b>NK-86</b>	42 mm	14 mm



**BARRAQUER**  
**NK-80/NK-86**  
 52 mm

**LISTER-BURCH**  
**BV-04**  
 80 mm

**WILLIAMS**  
**BV-06**  
 80 mm

**WESTCOTT**  
**FD-64/FD-65**  
 120 mm

**FD-41/FD-42**  
 120 mm

**FD-11**  
 110 mm

**CASTROVIEJO**  
**FD-66/FD-67**  
 110 mm

**CASTROVIEJO**  
**FD-68**  
 110 mm



**Ophthalmology**  
Ophthalmologie  
Ophtalmologie  
Oftalmologia  
Oftalmologia

Ohne Sperre  
Without Lock  
Senza arresto  
Sin cierre  
Sans Arrêt

Atraumatische  
Atraumatic  
Atraumatiche  
Atraumáticas  
Atraumatiques

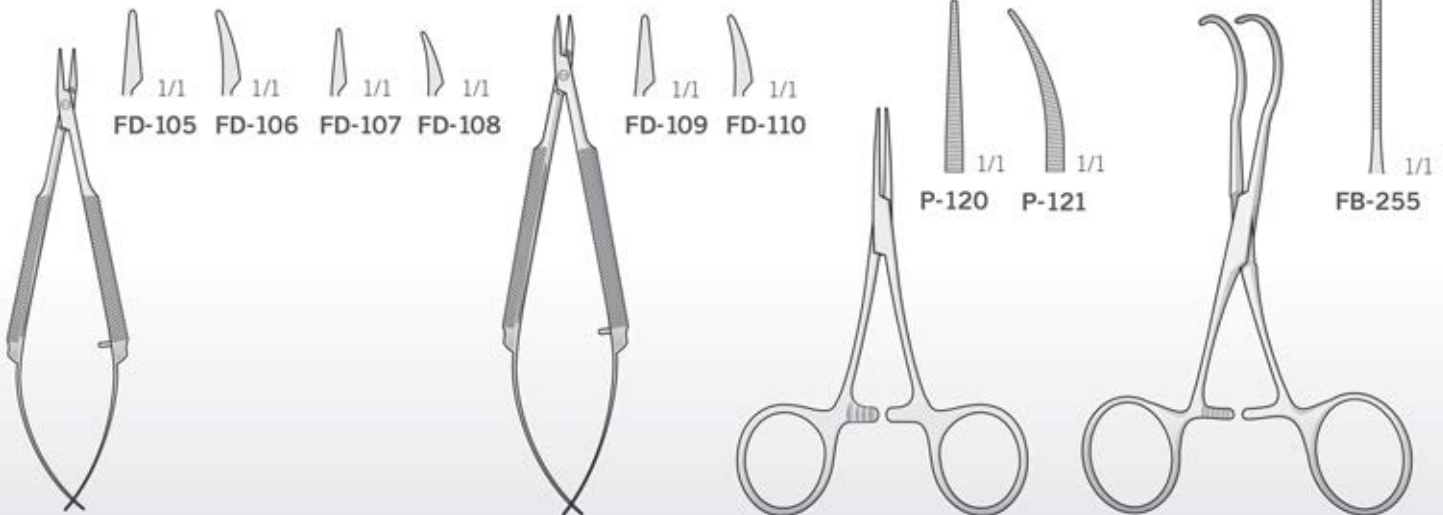

CASTROVIEJO  
**FD-105/FD-108**  
110 mm

CASTROVIEJO  
**FD-109/FD-110**  
125 mm

HARTMANN-BABY-MOSQUITO  
**P-120/P-121**  
95 mm

CASTANEDA  
**FB-255**  
120 mm

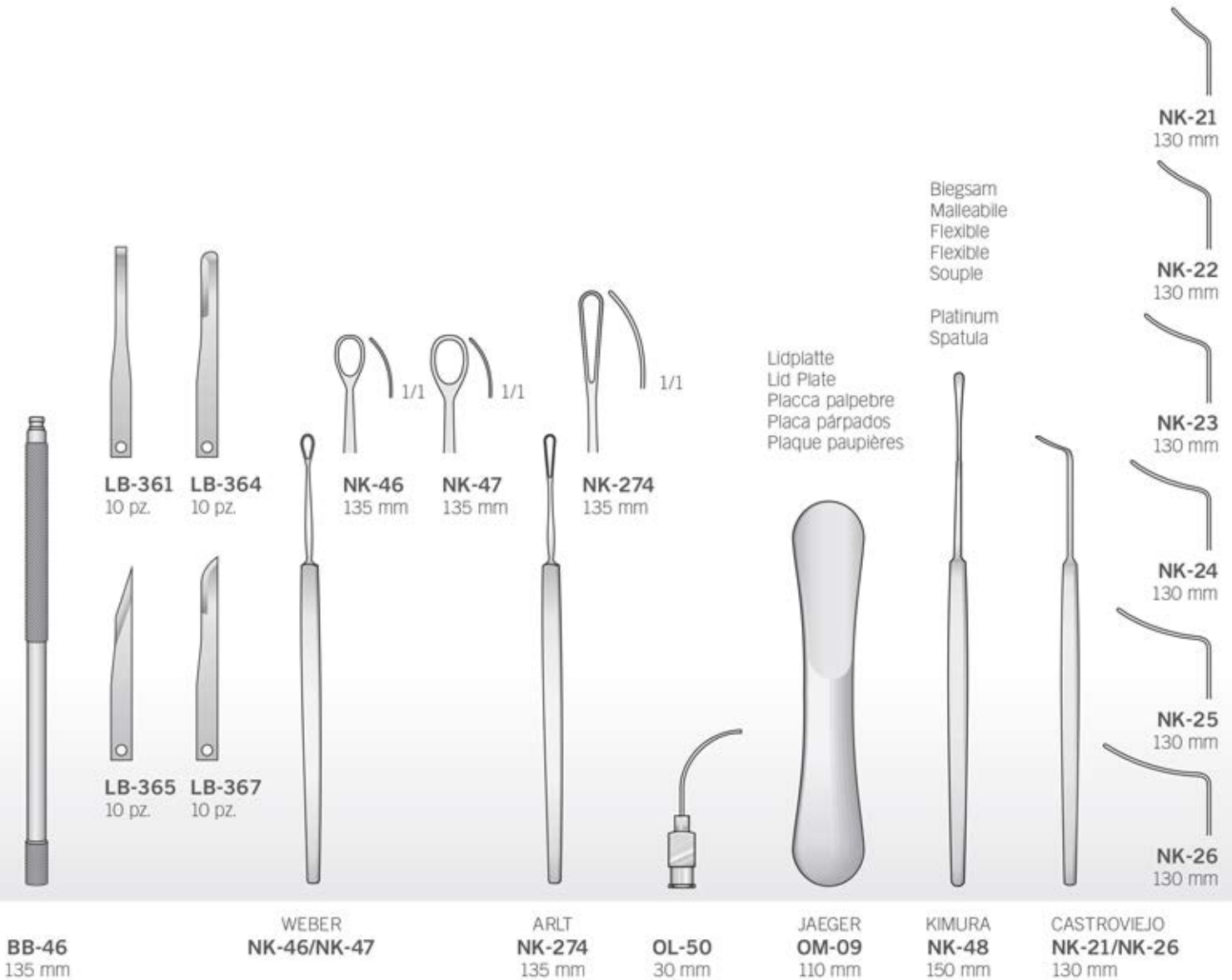



**Ophthalmology**  
 Ophthalmologie  
 Ophtalmologie  
 Oftalmologia  
 Oftalmologia

Pinzetten dritte Augenlid  
 Tweezers third eyelid  
 Pinza terza palpebra  
 Pinzas párpado tercero  
 Pincés troisième paupière

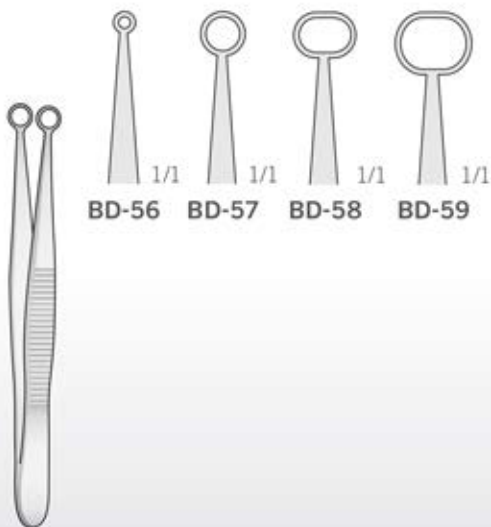

**BD-56/BD-59**  
 100 mm

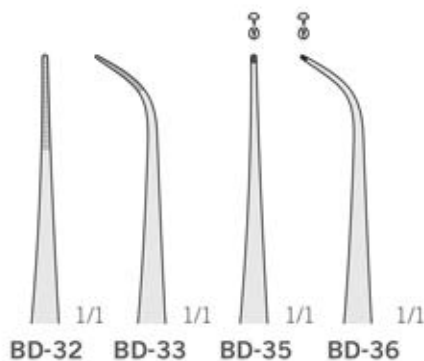

Iris Pinzetten  
 Iris Forceps  
 Pinze da iride  
 Pinza para iris  
 Pince à iris

**BD-32/BD-36**  
 100 mm

Chalazionpinzetten  
 Chalazion Forceps  
 Pinzette da calazio  
 Pinzas para chalación  
 Pincés à chalazion



DESMARRES  
**BD-130/BD-132**  
 90 mm



Fixierpinzetten  
Fixation forceps  
Pinze da Fissazione  
Pinzas de fijación  
Pinces à fixer

Mit Stop  
With Stop  
Con arresto  
Con parada  
Avec arrêt

Tying Forceps  
delicate 5 mm  
long platform  
for 7-0 to  
9-0 sutures

Tying & Utility  
Forceps standard  
7 mm long platform  
for sutures  
below 7-0

Suturing Forceps  
1x2 teeth  
of 0,3 mm set  
at 45° with delicate  
platform

Universal Suturing  
Forceps  
1x2 teeth of  
0,7 mm set at 45°  
with heavy platform

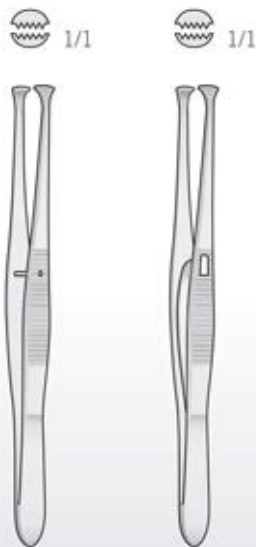

GRAEFE  
BD-135  
110 mm

GRAEFE  
BD-136  
110 mm



COLIBRI  
NK-66  
75 mm



COLIBRI  
NK-69  
80 mm

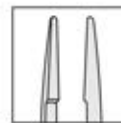

ST. MARTIN  
MF-200  
85 mm

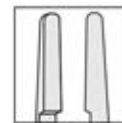

PAUFIQUE  
MF-201  
88 mm



ST. MARTIN  
MF-205  
85 mm

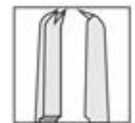

PAUFIQUE  
MF-206  
88 mm



### Traumatology - Orthopaedics

Traumatologie - Orthopädie  
Traumatologie - Orthopédie  
Traumatología - Ortopedia  
Traumatologia - Ortopedia



- Max Ø 0.7 mm (.028")
- 1.30 x 0.65 mm (.052" x .026")

Für weichen und harten Draht  
For soft and hard Wire  
Per filo leggero e duro  
Para alambre blando y duro  
Pour fil léger e dur

Universalzange  
Universal Pliers  
Pinze universali  
Alicates universales  
Pincers universelles

Rostfrei  
Stainless Steel  
Acciaio Inox  
Acero Inoxidable  
Acier Inoxydable

Parallel-Flachzange mit Seitenschneider  
Flat-nose pliers parallel with lateral wire cutter  
Pinza a branche parallele con tronchese  
Alicates de ramas paralelas con corta-alambre lateral  
Caliper branches en parallèle avec des coupe

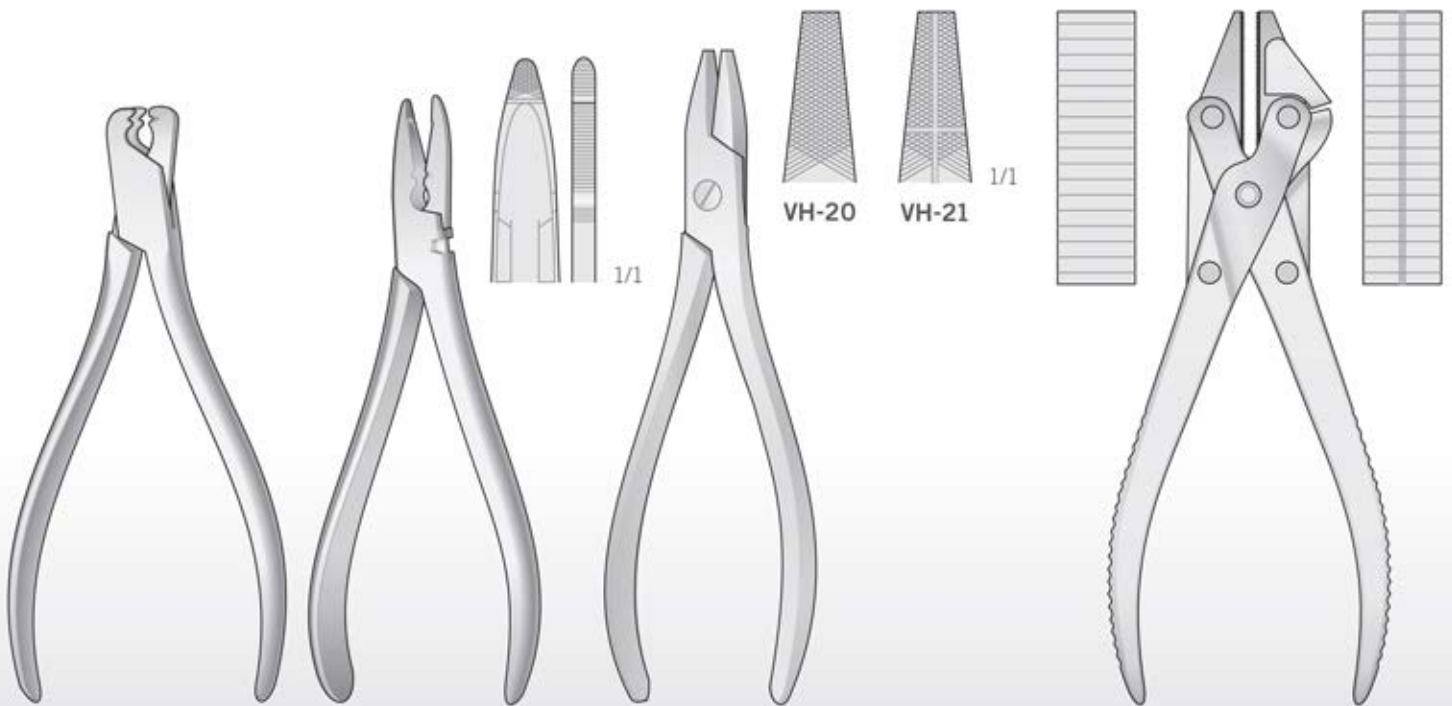

ADERER  
**DP-41**  
145 mm

WALDSACHS  
**DP-84**  
150 mm

**VH-20/VH-21**  
175 mm

**LX-80**  
185 mm

**Traumatology - Orthopaedics**

Traumatologie - Orthopädie

Traumatologie - Orthopédie

Traumatología - Ortopedia

Traumatologia - Ortopedia

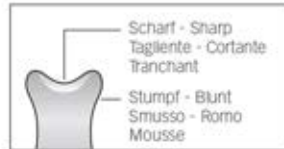

Für Lig. Femurkopf  
For ligament femoral head  
Per legamenti testa del femore  
De la cabeza femoral del ligamento  
Pour les ligaments tête femore

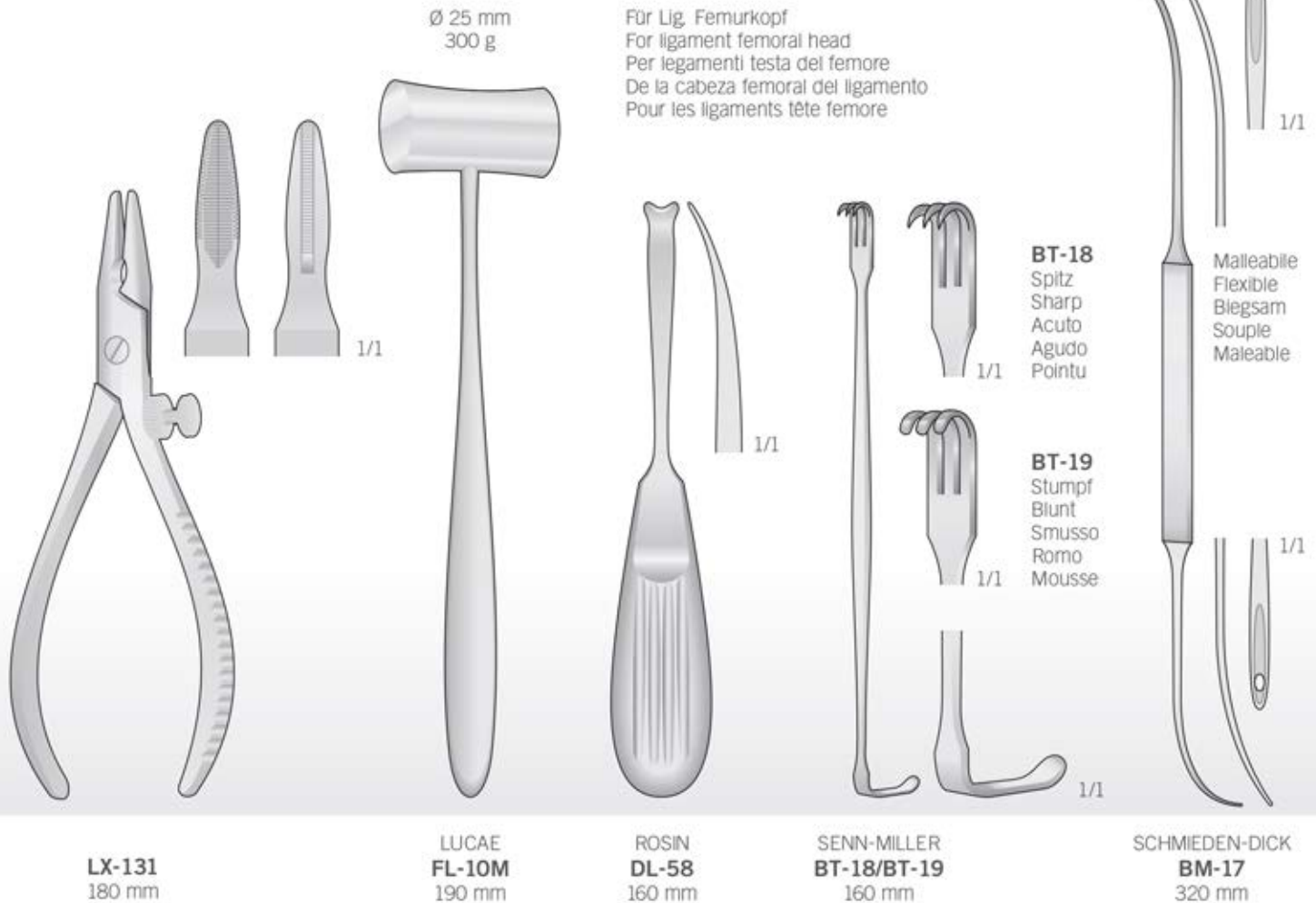





## Traumatology - Orthopaedics

Traumatologie - Orthopädie

Traumatologie - Orthopédie

Traumatologia - Ortopedia

Traumatologia - Ortopedia

### BV-108

Spitz

Scharp

Acuto

Agudo

Pointu

### BV-109

Stumpf

Blunt

Smusso

Romo

Mousse

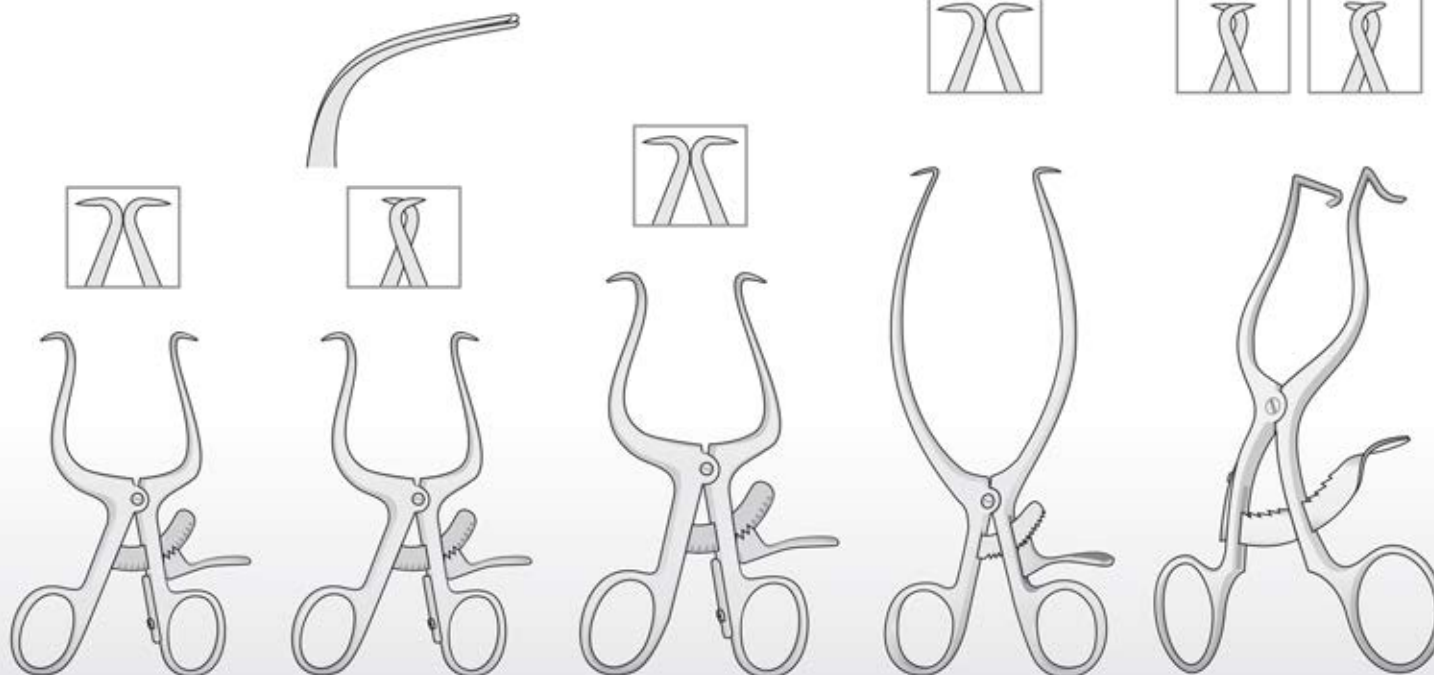

GELPI  
**BV-14**  
90 mm

GELPI  
**BV-14M**  
90 mm

GELPI  
**BV-15**  
110 mm

GELPI  
**BV-16**  
140 mm

CLOWARD-CONTOUR  
**BV-108/BV-109**  
140 mm

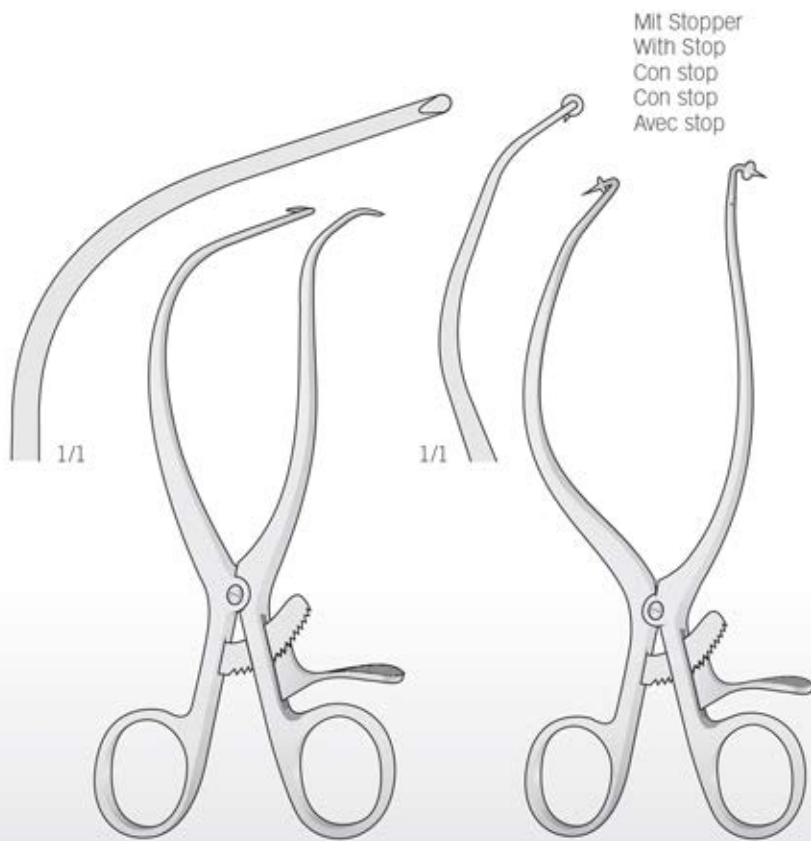

GELPI-SELETZ  
**BV-11**  
 165 mm

GELPI-LOKTITE  
**BV-13**  
 190 mm

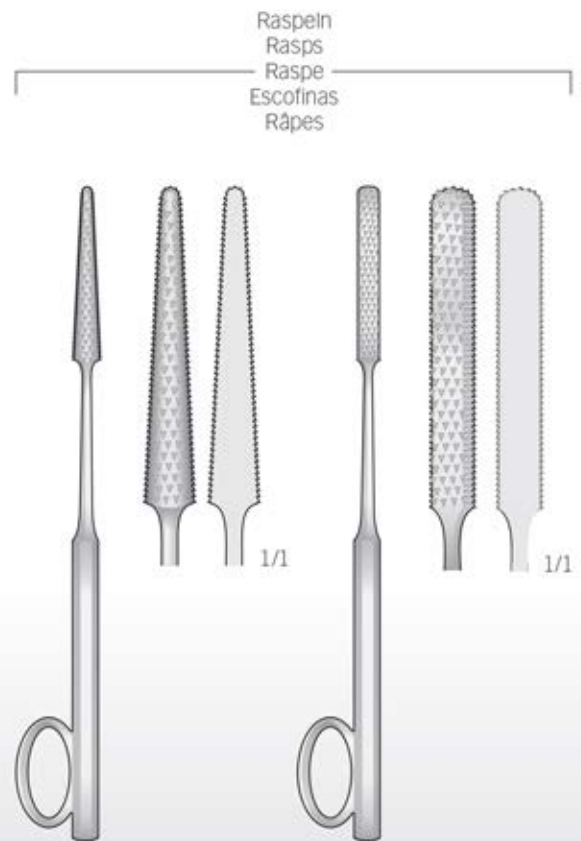

GOOD  
**FK-199**  
 160 mm

GALLAHER  
**FK-194**  
 160 mm

**Traumatology - Orthopaedics**

Traumatologie - Orthopädie  
 Traumatologie - Orthopédie  
 Traumatología - Ortopedia  
 Traumatologia - Ortopedia

Raspatorien  
 Periosteal Raspatories  
 Periostotomi  
 Legras periostótomos  
 Rugines à périostomie

Knochensägen  
 Bone saws  
 Seghetti per osso  
 Sierra para huesos  
 Scies à os

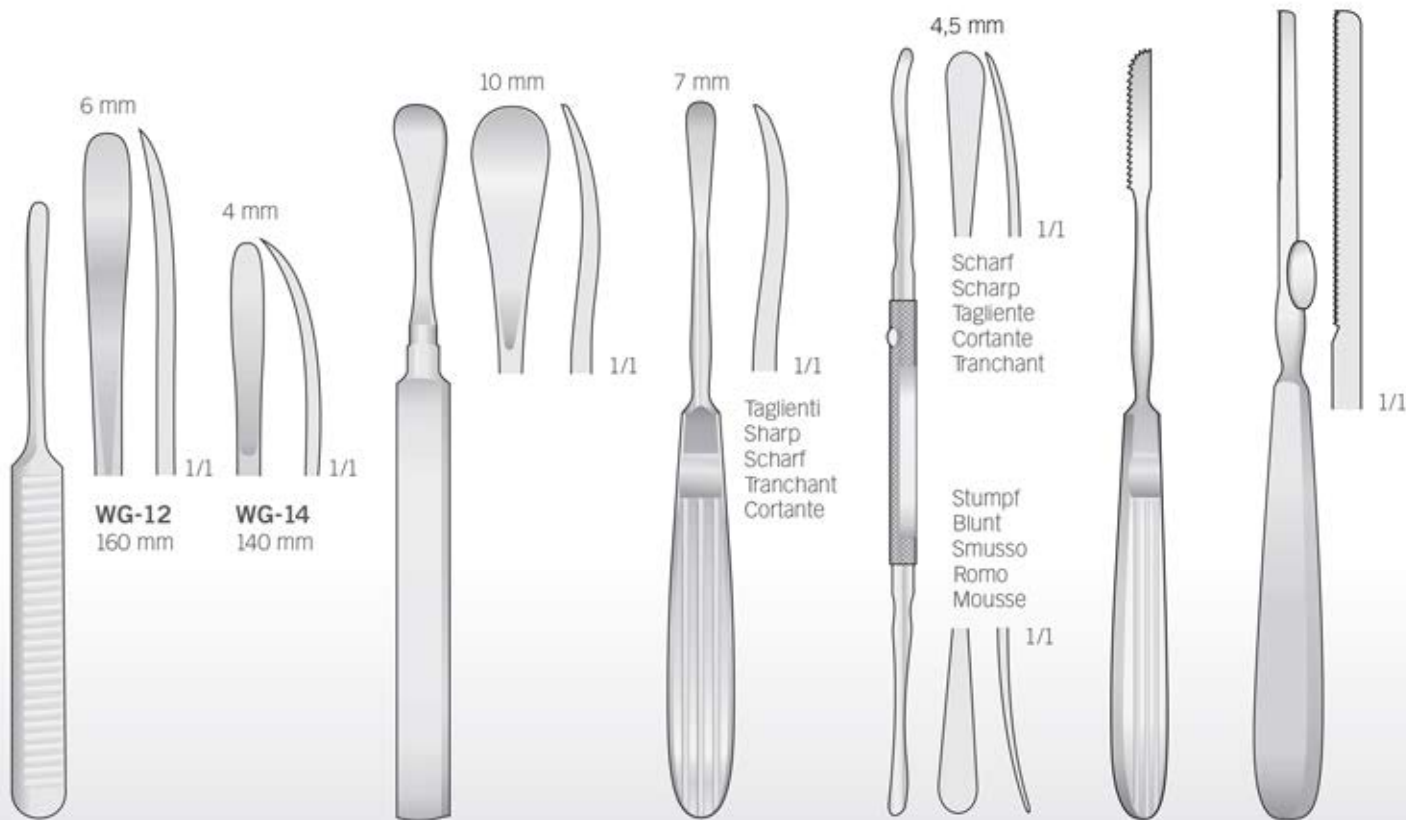

WILLIGER  
**WG-12/WG-14**

HENAHAN  
**BT-05**  
 175 mm

OBWEGESER  
**DO-63**  
 175 mm

**FREER**  
 180 mm

**DO-267**  
 190 mm

LINDEMANN  
**FK-243**  
 200 mm

## FL-90

Komplettset mit - Set complete with  
Set completo di - Set completo con  
Set complet avec

Mit Ferrozellgriff 4 Klängen  
With Ferrozell handle 4 Blades  
Manico portalamo in ferrozell 4 Lame  
Con mango de Ferrozell 4 Hojas  
Avec poignée en Ferrozell 4 Lames

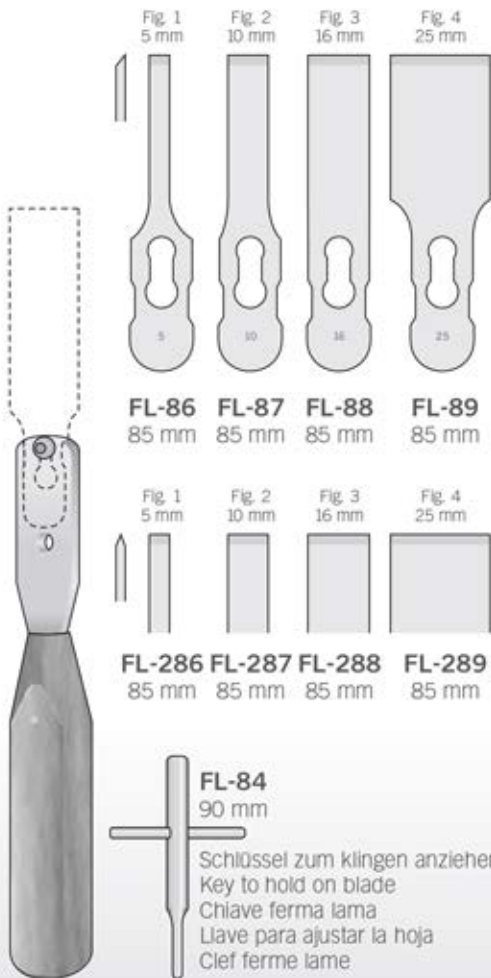

FL-85  
190 mm

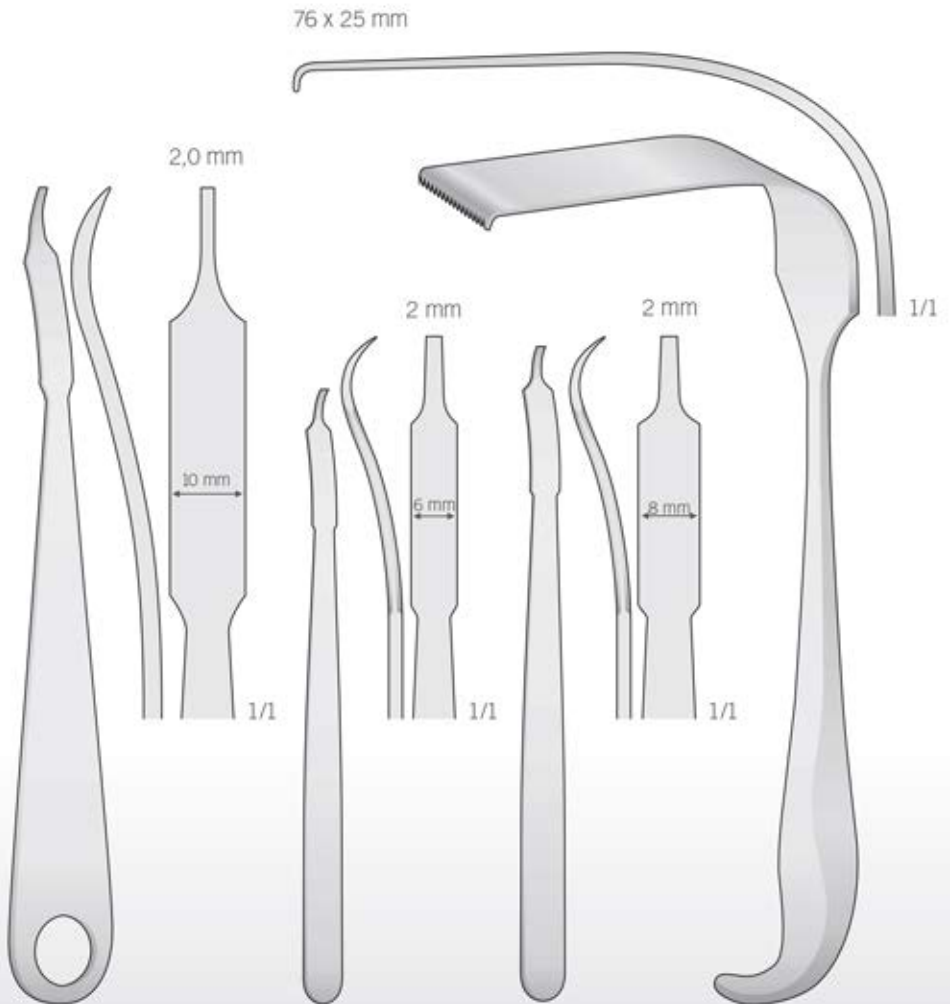

FK-51  
220 mm

MINI-HOHMANN  
FK-48  
160 mm

MINI-HOHMANN  
FK-49  
160 mm

MEYERDING  
BT-98  
230 mm

Traumatology - Orthopaedics  
Traumatologie - Orthopädie  
Traumatologie - Orthopédie  
Traumatología - Ortopedia  
Traumatologia - Ortopedia

**Traumatology - Orthopaedics**

Traumatologie - Orthopädie  
 Traumatologie - Orthopédie  
 Traumatología - Ortopedia  
 Traumatologia - Ortopedia

Von Hand zu spannen  
 Tightened by hand  
 Con chiusura a mano  
 Cerrado a mano  
 Serré à la main

Inox  
 Spannbereich  
 0 - 3 mm



**LS-222**

Inox  
 Spannbereich  
 0,8 - 6 mm



**LS-224**

Inox  
 ORIGINAL JACOBS  
 Ø 10 mm



**LS-236**  
 50 mm



**LS-227**  
 40 mm

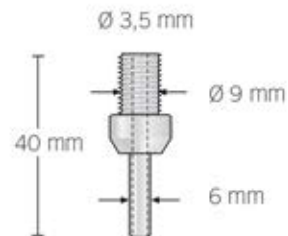

**LS-228**  
 40 mm  
 Canulato

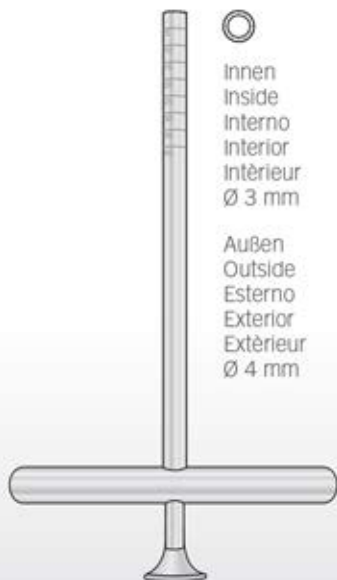

**FK-92**  
 170 mm

Innen  
 Inside  
 Interno  
 Interior  
 Intérieur  
 Ø 3 mm

Außen  
 Outside  
 Esterno  
 Exterior  
 Extérieur  
 Ø 4 mm

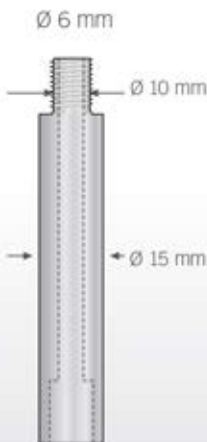

Ø 10 mm  
**LS-237**  
 90 mm



**LS-241**  
 52 mm

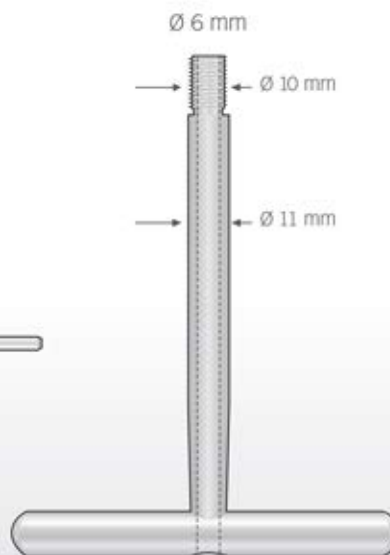

Ø 6 mm  
**LS-238**  
 130 mm



**LS-320**  
 145 mm



Steckbohrbüchsen  
 Insert-drill  
 Manicotto dentato - Centrapunte  
 Guía de perforación  
 Guide de perçage

Ø Außen	Ø Für Bohrer
Ø Outside	Ø For drills
Ø Esterno	Ø Per punte
Ø Exterior	Ø Para brocas
Ø Extérieur	Ø Pour Mèches

Cod. Art.

<b>LS-114</b>	3,5 mm	2 mm
<b>LS-115</b>	3,5 mm	2,7 mm

**LS-95**

Guide Point for bone

Komplett mit  
 Complete with  
 Completo con  
 Completo con  
 Complet avec

LS-94  
 LS-96  
 LS-97  
 LS-98



**LS-96**  
 Ø 2 mm



**LS-97**  
 Ø 2,7 mm



**LS-98**  
 Ø 3,5 mm

**LS-94**  
 145 mm

Ø Int. 1,6 mm  
 Ø Est. 2,6 mm

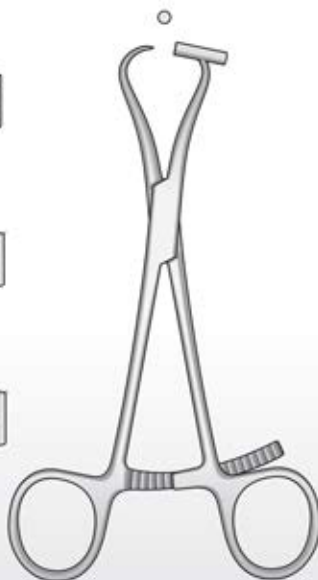

**FO-242**  
 140 mm

Ø Int.  
 2,5 mm



**LS-100**  
 120 mm

6 mm

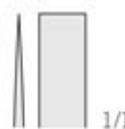

1/1  
**FL-265**

10 mm



1/1  
**FL-267**

15 mm



1/1  
**FL-269**

Ø Int.  
 1,2 mm

MINI-LAMBOTTE

**FL-265**  
 170 mm

Zange Cerclage  
 Cerclage forceps  
 Pize per cerchiaggi  
 Pinza para Cerclaje  
 Pincers pour cerclage

TC

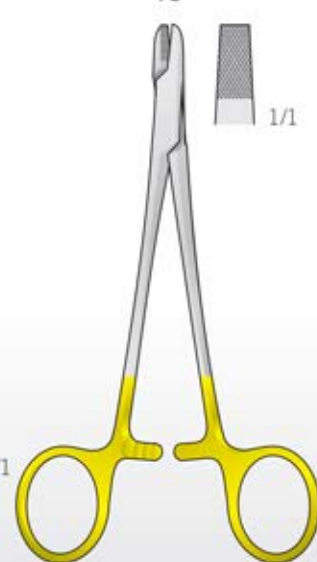

**PH-58**  
 150 mm

**LS-95**



### Traumatology - Orthopaedics

Traumatologie - Orthopädie  
Traumatologie - Orthopédie  
Traumatología - Ortopedia  
Traumatologia - Ortopedia

Löffel  
Spoons  
Cucchiai  
Cucharillas  
Cuillère

4-Hubs  
4 Hubs  
4 Snodi  
4 Centros  
4 Pôles

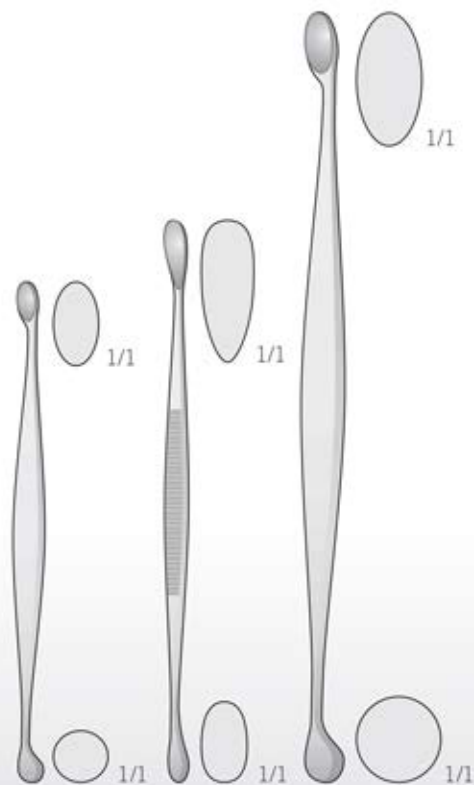

**FK-177**  
130 mm

**VOLKMANN  
FK-72**  
145 mm

**FK-178**  
200 mm



**BEYER  
FO-20**  
180 mm



**ZAUFAL-JANSEN  
FO-34**  
180 mm



**MINI-FRIEDMANN  
FO-22/FO-220**  
150 mm



**FO-23**



**FO-22**

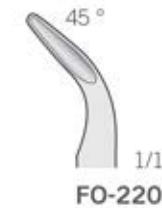

**FO-220**



**FO-24**

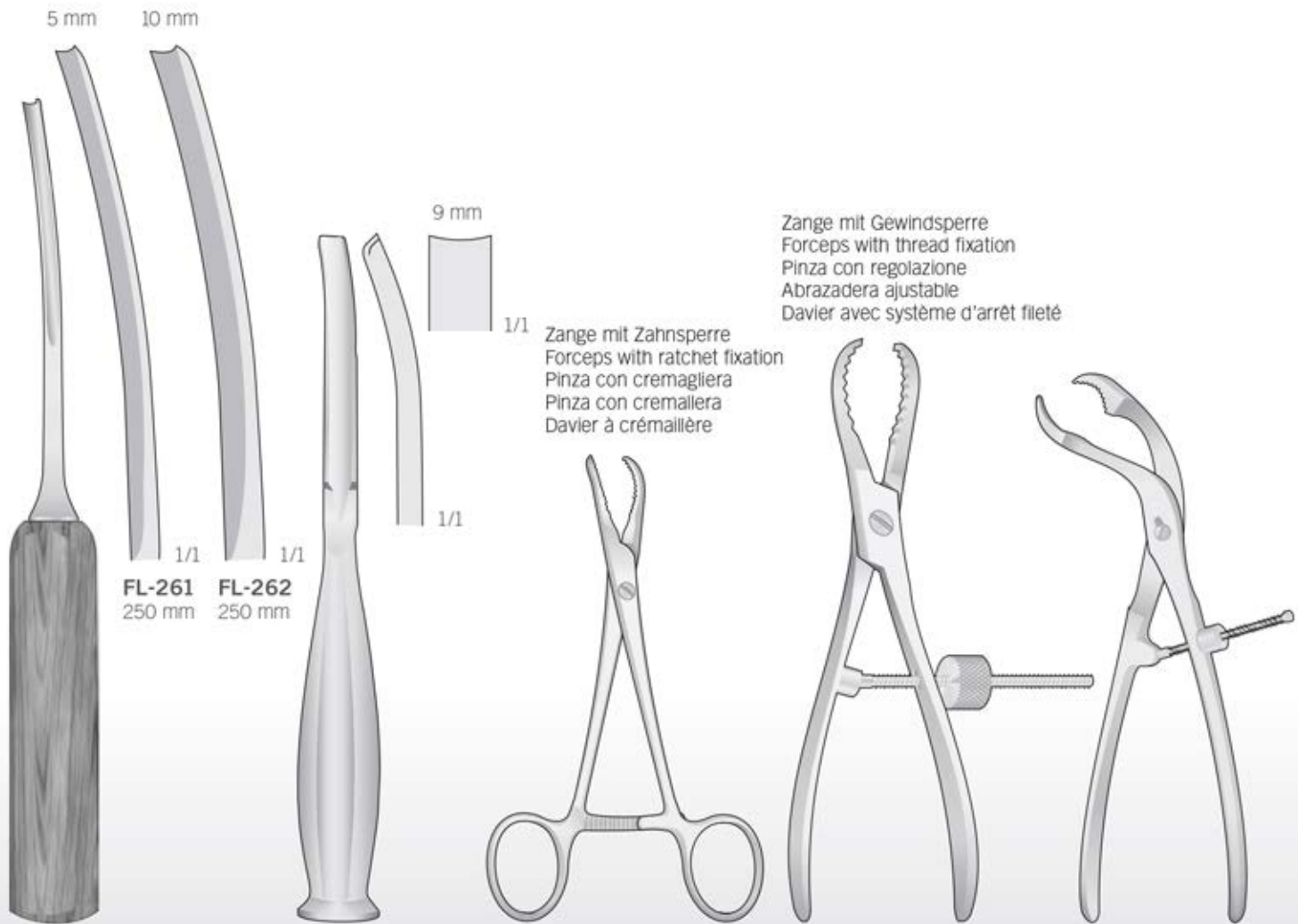

LEXER  
**FL-261**  
 250 mm

SMITH-PETERSEN  
**FL-359**  
 200 mm

**FO-47**  
 140 mm

**FO-48**  
 170 mm

**FO-71**  
 150 mm





**Traumatology - Orthopaedics**

Traumatologie - Orthopädie  
Traumatologie - Orthopédie  
Traumatología - Ortopedia  
Traumatologia - Ortopedia



**FO-62**  
230 mm



**FO-82**  
250 mm



**FO-105**  
280 mm

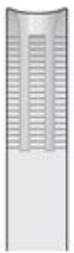

1/1

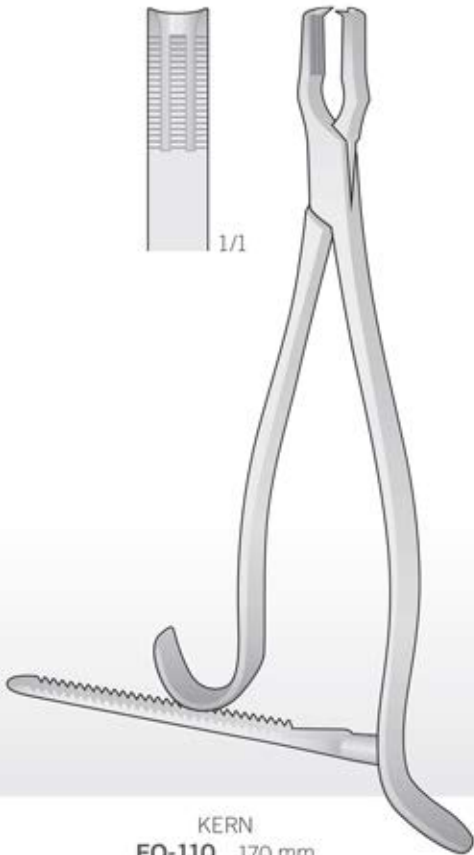

**KERN**  
**FO-110** 170 mm  
**FO-112** 220 mm



1/1



**ULRICH**  
**FO-84**  
180 mm



**ULRICH**  
**FO-62/FO-105**  
260 mm



Für weichen Draht Ø 5 mm  
 Für harten Draht Ø 4,5 mm  
 For soft wire Ø 5 mm  
 For hard wire Ø 4,5 mm  
 Per filo leggero Ø 5 mm  
 Per filo duro Ø 4,5 mm  
 Para alambre blando Ø 5 mm  
 Para alambre duro Ø 4,5 mm  
 Pour fil léger Ø 5 mm  
 Pour fil dur Ø 4,5 mm



**LX-107**  
375 mm

Für weichen draht Ø 2,5 mm  
 Für harten draht Ø 2 mm  
 For soft wire Ø 2,5 mm  
 For hard wire Ø 2 mm  
 Per filo leggero Ø 2,5 mm  
 Per filo duro Ø 2 mm  
 Para alambre blando Ø 2,5 mm  
 Para alambre duro Ø 2 mm  
 Pour fil léger Ø 2,5 mm  
 Pour fil dur Ø 2 mm

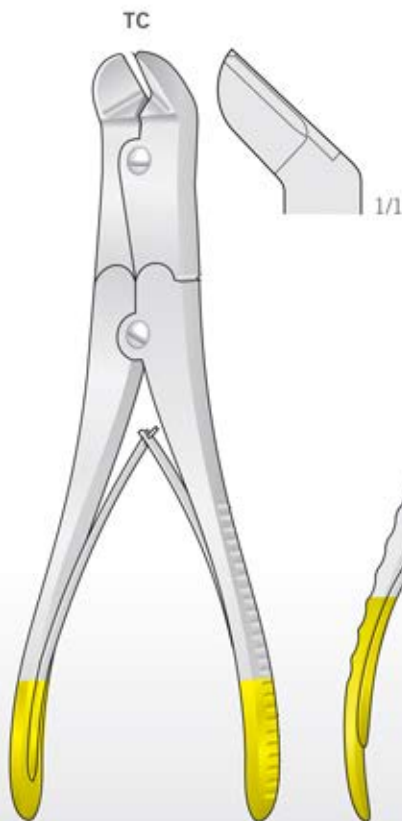

**LX-105**  
230 mm

Für weichen draht Ø 3,5 mm  
 Für harten draht Ø 2,5 mm  
 For soft wire Ø 3,5 mm  
 For hard wire Ø 2,5 mm  
 Per filo leggero Ø 3,5 mm  
 Per filo duro Ø 2,5 mm  
 Para alambre blando Ø 3,5 mm  
 Para alambre duro Ø 2,5 mm  
 Pour fil léger Ø 3,5 mm  
 Pour fil dur Ø 2,5 mm

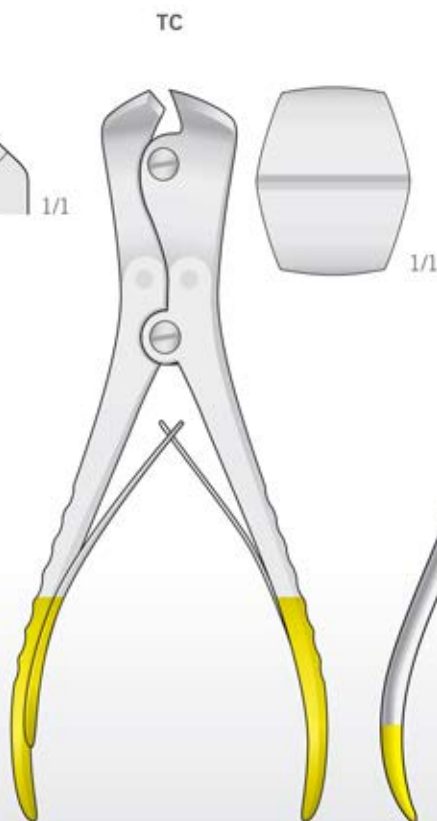

**LX-104**  
215 mm

○ Max Ø 1.0 mm (.040")

Seitenschneider  
 Side Cutters  
 Taglio laterale  
 De corte lateral  
 Coupante latérale

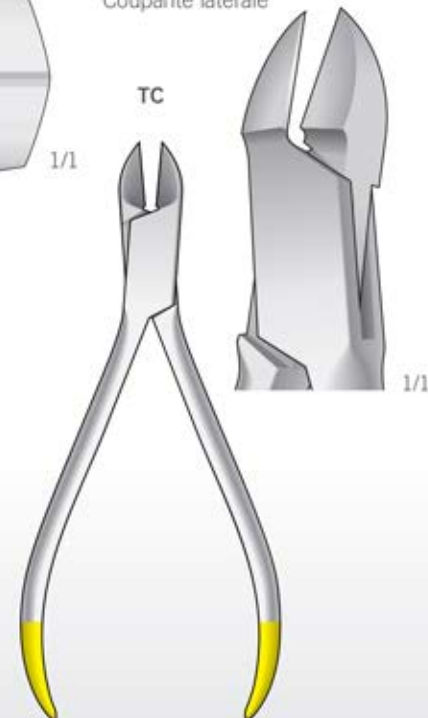

**LX-96TC**  
150 mm



**Traumatology - Orthopaedics**

Traumatologie - Orthopädie

Traumatologie - Orthopédie

Traumatología - Ortopedia

Traumatologia - Ortopedia

Lange Rack  
Long Rack  
Cremagliera lunga  
Cremallera larga  
Crémaillère longue

Lange Schraube  
Long Screw  
Vite lunga  
Tornillo largo  
Vis longue

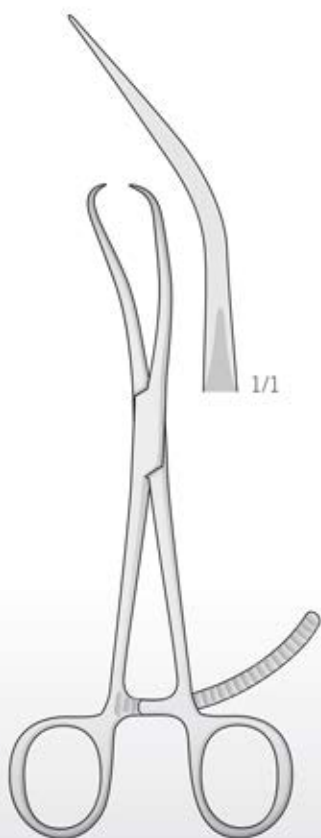

REILL  
FO-64L  
170 mm

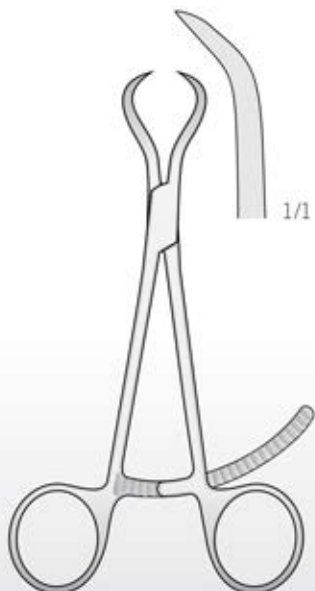

FO-66L  
135 mm

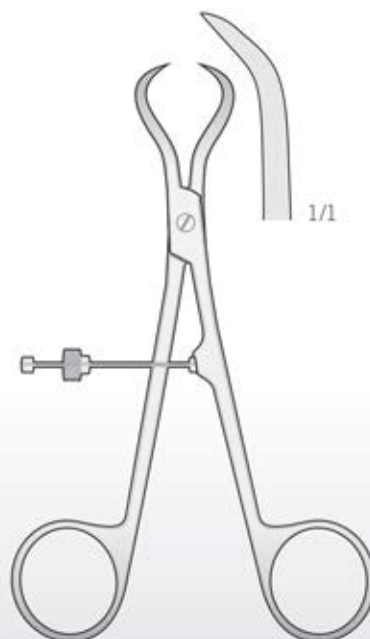

FO-79  
140 mm

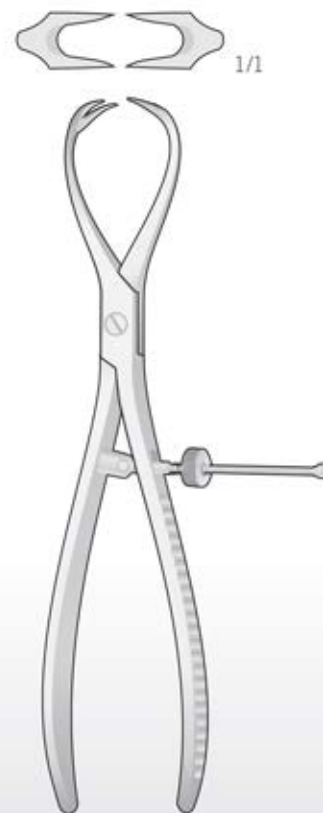

PATELLA  
FO-46L  
185 mm

Mit Schraubverschluss  
 With screw  
 Con vite di fissaggio  
 Con tornillo  
 Avec vis

**ENT - Otolaryngology**  
 HNO - Heilkunde  
 ORL - Oto-rhino-laryngologie  
 ORL - Otorrinolaringología  
 ORL - Otorinolaringoiatria

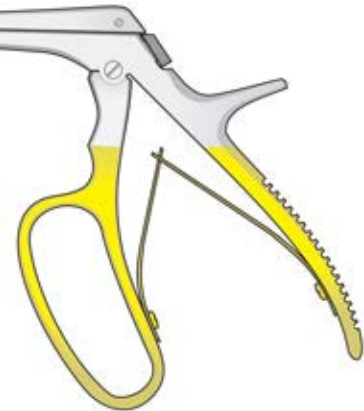
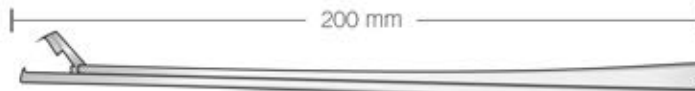
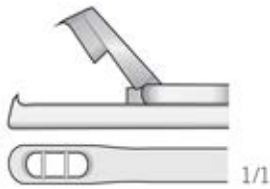

**TISCHLER-MORGAN  
 FF-59**

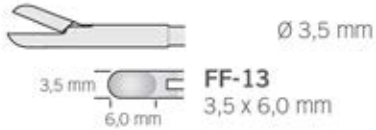

**FF-13**  
 3,5 x 6,0 mm

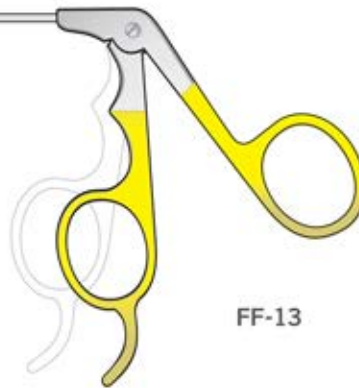

**FF-13**



**FF-13M**  
 3,0 x 5,0 mm

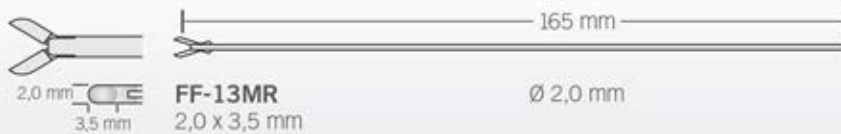

**FF-13MR**  
 2,0 x 3,5 mm

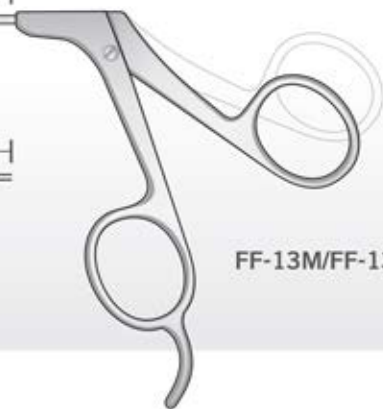

**FF-13M/FF-13MR**



**Neurosurgery**  
 Neurochirurgie  
 Neurochirurgie  
 Neurocirugía  
 Neurochirurgia

**CASPAR**  
**FF-200M**  
 Distraktor Lang komplett  
 Distractor Long complete  
 Distrattore modificato completo

**FF-201M**  
 1 Distraktor Lang  
 1 Distractor Long only

**FF-202**  
 1 Bohrbüchse  
 1 Drilling Guide

**FF-203**  
 1 Spezialbohrer  
 1 Special Drill

**FF-205**  
 2 Distraktionsschrauben  
 2 Distraction Screws

**FF-206**  
 1 Schraubendreher  
 1 Screw Driver

Spezialbohrer  
 Special Drill  
 Ø 1,7 mm

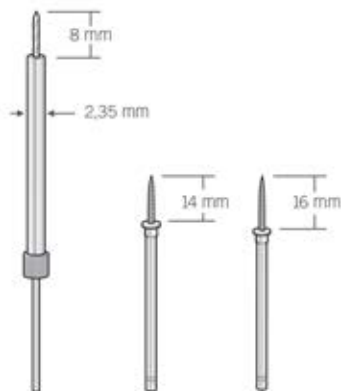

CASPAR **FF-203** 145 mm  
 CASPAR **FF-204** 70 mm  
 CASPAR **FF-205** 70 mm

Schraubendreher  
 Screw Driver

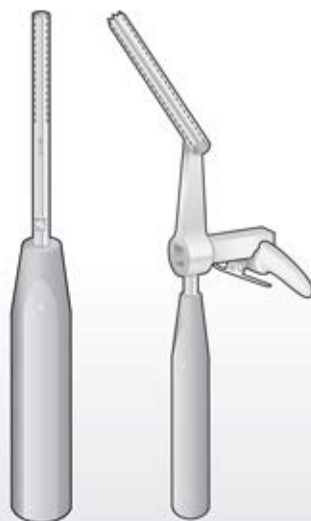

CASPAR **FF-206** 200 mm  
**FF-202**  
 Bohrbüchse  
 Drilling Guide only  
 Guida punte solo

Dissettore per  
 Neurochirurgia



OLIVECRONA  
**KO-47**  
 180mm

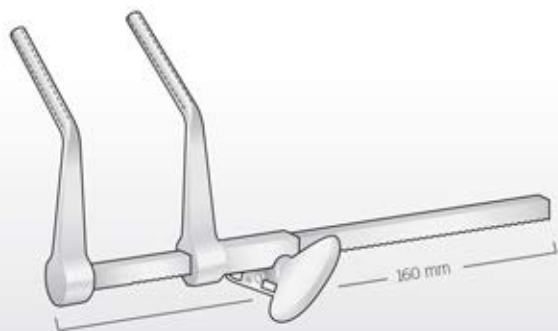

CASPAR **FF-201M**  
 Distraktor Lang  
 Distractor Long only  
 Distrattore modificato solo

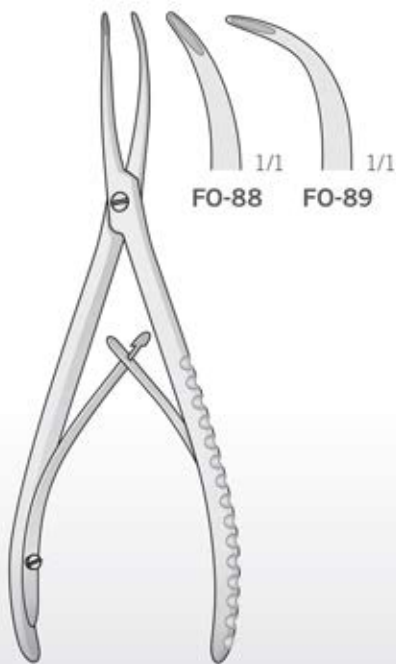

STELLBRINK  
**FO-88/FO-89**  
 170 mm

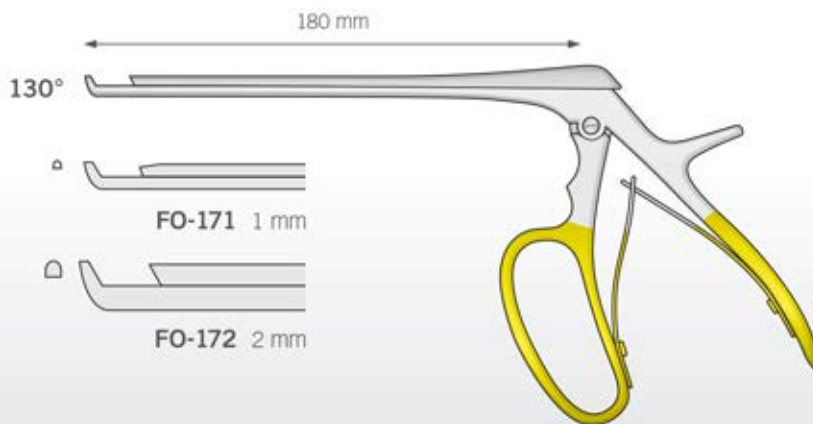
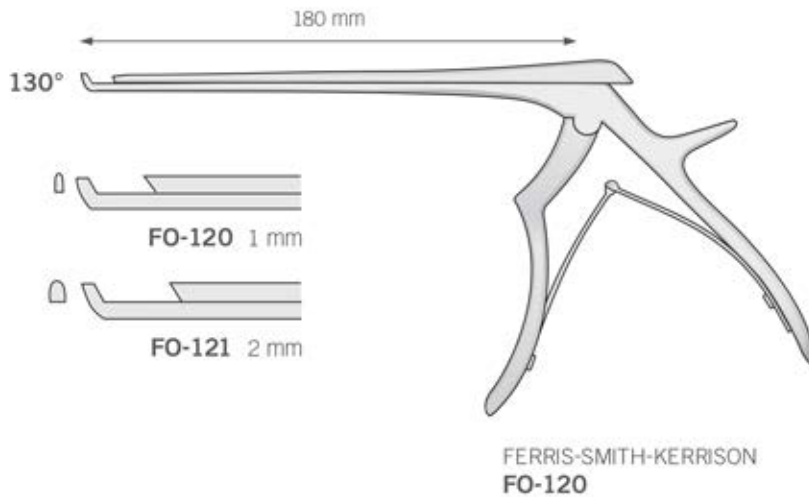

Femur-Wundspreizer  
 Femur Retractor  
 Divaricatore femorale



Femur-Wundspreizer  
 Femur Retractor  
 Divaricatore femorale



DE BAKEY  
**BV-315**  
 100 mm

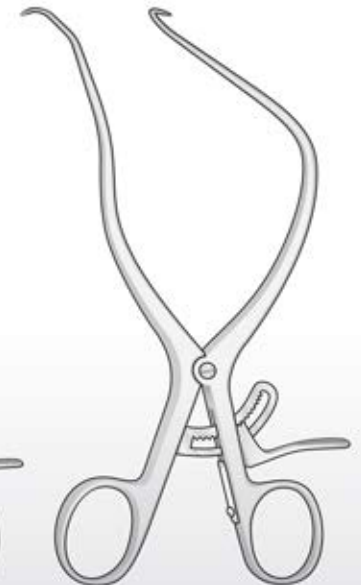

DE BAKEY  
**BV-316**  
 170 mm

Palpatorischen  
 Palpatory  
 Palpatori  
 Palpación  
 Palpatoire

Schlingen  
 Anses  
 Anse  
 Ansas  
 Boucles



**AS-16**  
 225 mm

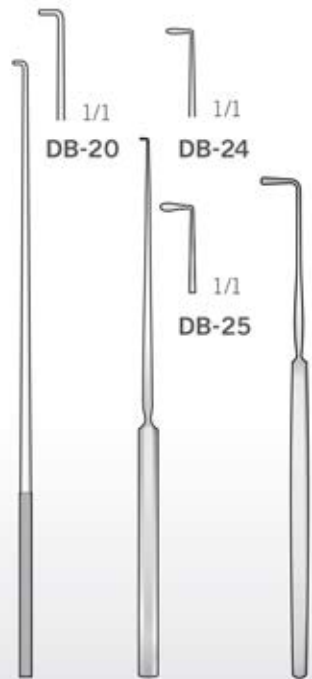

DAY  
**DB-20** 160 mm

LUCAE  
**DB-24/DB-25** 140 mm

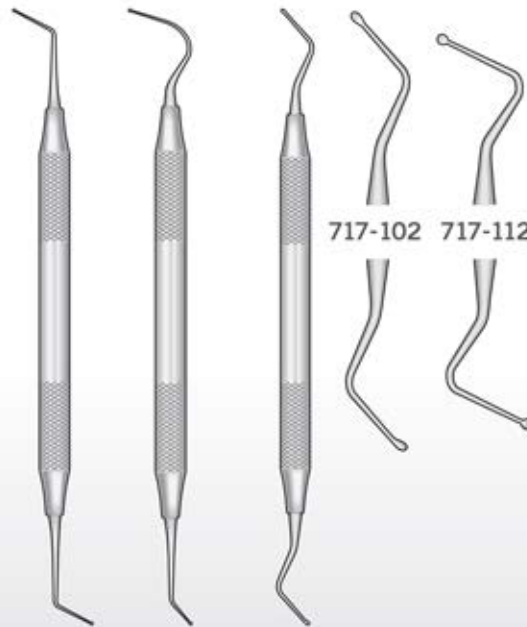

GRAEFE  
**NK-245** 130 mm

**713-101** **713-102** **717-100**

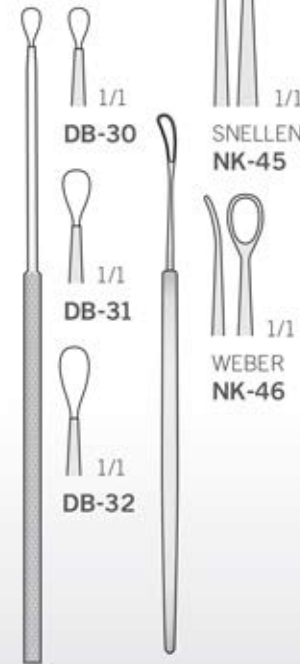

BILLEAU  
**DB-30** 160 mm

SNELLEN  
**NK-45/NK-46** 135 mm

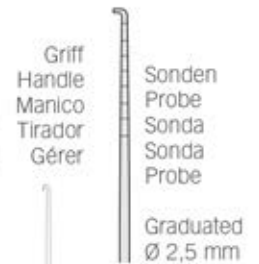

**AS-19**  
 220 mm

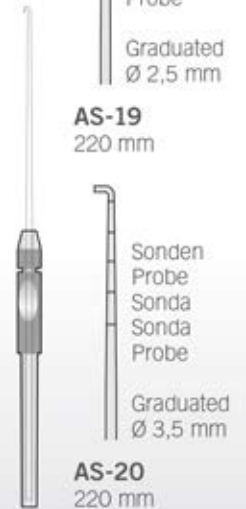

**AS-20**  
 220 mm

**AS-10**  
 125 mm



## Sharpen & Lubricate



**DB-96**  
**ARKANSAS N°8**  
 100 x 50 x 13 mm

What? A natural stone extracted from the mountains of Arkansas. Its shape is flat and rectangular.

Why? To sharpen all cutting parts of surgical instruments.

When? Whenever necessary to sharpen cutting parts (scissors, osteotomes, curettes, etc.).



**DB-299**  
**ARKANSAS**  
**Conica N° 299**  
 Ø 8 x 90 mm

What? A natural stone extracted from the mountains of Arkansas. Its shape is cone-shaped and cylindrical.

Why? To manually sharpen internal parts of curettes, scalers, gouges, rongeurs, etc.

When? Whenever necessary to sharpen the internal parts of surgical instruments in areas that otherwise cannot be reached.



**DB-4**  
**ARKANSAS N°4**  
 100 x 25 x 12 mm

What? A natural stone extracted from the mountains of Arkansas. Its shape is flat and rectangular.

Why? To sharpen all cutting parts of surgical instruments.

When? Whenever necessary in routine sharpening and finishing of the edge and toe of an instrument.



**DB-3**  
**INDIA N°6**  
**DB-6A**  
**ARKANSAS N°6A**  
 100 x 45 mm

What? India stones: quarried from the finest Ozark novaculite (silicon quartz) deposits. Arkansas stone: extracted from Arkansas mountains.

Why? To manually sharpen internal parts of curettes and scalers.

When? India: for sharpening of excessively dull instruments or those requiring recontouring. Arkansas: for routine sharpening and finishing.



**DB-OL**  
**SCHARPENOIL**  
 30 cc

What? A non-coloured oil, which is an indispensable complement for manual sharpening of surgical instruments.

Why? To activate the abrasive properties of all stones (Arkansas, India), and to reduce the possibility of overheating the instruments during sharpening.

When? Must ALWAYS be used during all sharpening operations.

## Testing & Lubrication

What? A hard plastic test stick that can be used to test the blade of an instrument.

Why? To determine the sharpness of an instrument.

When? Always. If the blade of the instrument runs smoothly over the plastic stick, then it is blunt. A sharp instrument will grab into the stick and removes small fragments of the plastic.



**DB-15**  
**TEFLON STICK**  
**for testing**  
 Ø 8 x 100 mm



**DB-OLR**  
**RODHOIL**  
**Lubricant**  
 50 cc

What? A high density lubricating oil of slightly red tint.

Why? To ensure perfect function and fluid movement of all surgical instruments.

When? It should be applied on all hinges or all other parts which are subject to movement or friction. Its use facilitates elimination of any residue present within the instrument hinges.

## Sterilisation

### STERILIZATION CONTAINERS

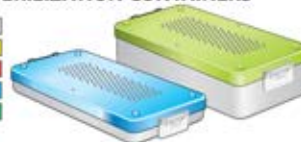

**CT-555N<sup>®</sup> / CT-556N<sup>®</sup>**  
**CT-560N<sup>®</sup> / CT-564N<sup>®</sup>**  
**CT-565N<sup>®</sup> / CT-569N<sup>®</sup>**  
 300 x 140 x (40<sup>°</sup> / 70<sup>°</sup> / 100<sup>°</sup>) mm

### STAINLESS STEEL CASSETTES

with silicone racks

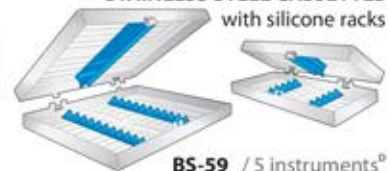

**BS-59** / 5 instruments<sup>®</sup>  
**BS-60** / 10 instruments<sup>®</sup>  
**BS-61** / 20 instruments<sup>®</sup>  
 185 x 35 x (75<sup>°</sup> / 135<sup>°</sup> / 185<sup>°</sup>) mm

## Rinse & Clean

What? A bacteriostatic and anticorrosive detergent.

Why? Anticorrosive, bacteriostatic and lubricating action on all surgical instruments. It guarantees perfect maintenance by eliminating eventual stains, halos and browning due to sterilization, disinfection and washing with tap water.

When? Use periodically, diluted or concentrated (see special instructions on packaging).



**CLEANLACT**  
**DB-10M**  
 250 cc  
**DB-50M**  
 500 cc  
**DB-1L**  
 1000 cc



**DB-11**  
 155 mm



**DB-12**  
 175 mm

What? **DB-11** and **DB-12** are special brushes for surgical instruments.

Why? To remove eventual residue, organic or not, from all surgical instruments, in particular in angled, hinged and knurled parts, without damaging instrument surface. They are autoclavable.

When? Every time, for regular cleaning of all instrumentation and in the event that an instrument is exposed for an extended period to air before being immersed in the cleaning solution.

### SPECIAL RUBBER FOR METAL

Fine **DB-07**  
 Coarse **DB-08**  
 50 x 40 x 20 mm

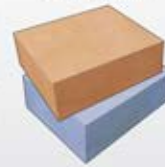

What? An abrasive eraser specially designed for surgical instruments.

Why? To remove stains, halos or persistent burnishing from all surgical instruments without damaging the instrument surface.

When? Necessary when routine cleaning does not remove all stains.



1	24	BD-157	10	CU-1/2	25	EA-10	12	FK-72	40	FM-318	8	LB-365	29	NK-47	29	PH-107	17
30	24	BD-250	9	CU-3/4	25	EA-11	12	FK-92	38	FM-319	8	LB-367	29	NK-48	29	PH-122	16
49	24	BD-274	10	DA-01	22	EA-13	12	FK-177	40	FM-328	8	LK-4	3	NK-66	31	PH-127	16
56	24	BD-371	9	DA-02	22	EA-14	12	FK-178	40	FM-337	7	LS-94	39	NK-69	31	PO-34	18
713-101	48	BEIN-2	23	DB-07	49	EA-50	12	FK-194	35	FM-343	6	LS-95	39	NK-80	27	PO-35	18
713-102	48	BEIN-2Z	23	DB-08	49	EA-51	12	FK-199	35	FO-20	40	LS-96	39	NK-82	27	PO-36	18
715-102	26	BEIN-3	23	DB-1L	49	EA-53	12	FK-243	36	FO-22	40	LS-97	39	NK-84	27	PO-50	18
715-103	26	BEIN-4	23	DB-3	49	EA-54	12	FL-10M	33	FO-23	40	LS-98	39	NK-86	27	PO-51	18
717-100	48	BF-38	11	DB-4	49	FB-16	13	FL-84	37	FO-24	40	LS-100	39	NK-245	48	PO-52	18
717-102	48	BF-40	11	DB-6A	49	FB-255	28	FL-85	37	FO-34	40	LS-114	39	NK-274	29	PO-66	18
717-112	48	BF-41	11	DB-10M	49	FB-256	13	FL-86	37	FO-46L	44	LS-115	39	OL-07	15	PO-86	18
718-277	25	BF-42	11	DB-11	49	FD-11	27	FL-87	37	FO-47	41	LS-222	38	OL-08	15	PO-95	18
718-M23	25	BF-44	11	DB-12	49	FD-41	27	FL-88	37	FO-48	41	LS-224	38	OL-22	15	PO-98	18
718-M23A	25	BF-48	11	DB-15	49	FD-42	27	FL-89	37	FO-62	42	LS-227	38	OL-31	15	PO-100	18
718-M23B	25	BF-64	5	DB-20	48	FD-64	27	FL-152	15	FO-64L	44	LS-228	38	OL-32	15	R-2	26
719-111	25	BM-01	16	DB-24	48	FD-65	27	FL-261	41	FO-66L	44	LS-236	38	OL-33	15	R-3	26
AS-10	48	BM-02	16	DB-25	48	FD-66	27	FL-262	41	FO-71	41	LS-237	38	OL-36	15	RH-4	22
AS-16	48	BM-03	16	DB-30	48	FD-67	27	FL-265	39	FO-79	44	LS-238	38	OL-40	15	SC-1	5
AS-19	48	BM-04	16	DB-31	48	FD-68	27	FL-267	39	FO-82	42	LS-241	38	OL-50	29	SC-9	5
AS-20	48	BM-17	33	DB-32	48	FD-105	28	FL-269	39	FO-84	42	LS-320	38	OM-09	29	SC-13	5
BB-46	29	BN-502	19	DB-50M	49	FD-106	28	FL-286	37	FO-88	46	LX-80	32	OR-12	27	SD-M	21
BD-10	10	BS-59	49	DB-96	49	FD-107	28	FL-287	37	FO-89	46	LX-96TC	43	OR-17	27	SM-11	22
BD-16	10	BS-60	49	DB-114	14	FD-108	28	FL-288	37	FO-105	42	LX-98	21	P-24	11	SM-13	22
BD-18	10	BS-61	49	DB-120	14	FD-109	28	FL-289	37	FO-110	42	LX-104	43	P-34	11	US DL-401	20
BD-27	10	BT-05	36	DB-121	14	FD-110	28	FL-359	41	FO-112	42	LX-105	43	P-50	13	US DL-402	20
BD-28	10	BT-18	33	DB-122	14	FF-13	45	FM-1	4	FO-120	47	LX-107	43	P-52	13	US DL-403	20
BD-30	9	BT-19	33	DB-299	49	FF-13M	45	FM-2	4	FO-121	47	LX-131	33	P-91	11	US DL-500	20
BD-31	9	BT-98	37	DB-940	19	FF-13MR	45	FM-3	4	FO-171	47	MA-2	22	P-92	11	VF-102	15
BD-32	30	BV-04	27	DB-941	19	FF-59	45	FM-3F	4	FO-172	47	MC-11	25	P-100	13	VF-102M	15
BD-33	30	BV-06	27	DB-942	19	FF-200M	46	FM-4	4	FO-220	40	MC-12	25	P-120	28	VF-120	20
BD-35	30	BV-11	35	DB-0L	49	FF-201M	46	FM-4F	4	FO-242	39	MC-13	25	P-121	28	VF-121	20
BD-36	30	BV-13	35	DB-OLR	49	FF-202	46	FM-12	3	FREER	21, 36	MF-200	31	P-193	13	VF-122	20
BD-42	10	BV-14	34	DL-05	22	FF-203	46	FM-66	6	GF-09	14	MF-201	31	P-266	11	VF-126	20
BD-56	30	BV-14M	34	DL-06	22	FF-204	46	FM-67	6	GF-22	14	MF-205	31	P-267	11	VF-127	20
BD-57	30	BV-15	34	DL-58	33	FF-205	46	FM-68	6	GF-29	14	MF-206	31	PEB-1	24	VH-20	32
BD-58	30	BV-16	34	DL-78	22	FF-206	46	FM-69	6	GF-75	14	MIR-12	20	PEB-2	24	VH-21	32
BD-59	30	BV-108	34	DL-79	22	FG-1TC	6	FM-100	7	GF-76	14	MO-8	26	PEB-3	24	VH-48	21
BD-73	9	BV-109	34	DL-102	23	FG-2TC	6	FM-102	7	GF-77	14	MO-10	26	PEB-5	24	VH-49	21
BD-80	10	BV-315	47	DL-103	23	FG-10	3	FM-104	7	KO-47	46	NK-21	29	PF-19	15	VH-50	21
BD-92	9	BV-316	47	DL-112	23	FG-31	5	FM-180	3	L-21	21	NK-22	29	PF-22	15	VH-51	21
BD-130	30	CT-555N	49	DO-63	36	FG-32	5	FM-296	8	L-26	21	NK-23	29	PH-58	39	WG-12	36
BD-131	30	CT-556N	49	DO-267	36	FG-209	26	FM-297	8	L-27	21	NK-24	29	PH-65	17	WG-14	36
BD-132	30	CT-560N	49	DP-41	32	FG-210	26	FM-300	8	L-28	21	NK-25	29	PH-72	16		
BD-135	31	CT-564N	49	DP-84	32	FK-48	37	FM-301	8	L-29	21	NK-26	29	PH-75	16		
BD-136	31	CT-565N	49	DR-50	21	FK-49	37	FM-306	7	LB-361	29	NK-45	48	PH-85	17		
BD-141	9	CT-569N	49	DR-60	21	FK-51	37	FM-308	8	LB-364	29	NK-46	29, 48	PH-102	17		

EN / Graphic images in our Catalogue are for references only and not binding. We reserve the right to modify esthetically and technically without prior notice. To reprint this catalogue - or any part of it - without our final approval, is prohibited.

DE / Die Abbildungen in unseren Katalogen sind nicht bindend für unseren Betrieb. Wir behalten uns das Recht auf Abänderungen in Aussehen und Abmessungen vor, ohne vorherige Ankündigung. Der Nachdruck des Kataloges - auch auszugsweise - ist ohne unser ausdrückliches Einverständnis untersagt. Geschmacksmuster angemeldet.

FR / Les images graphiques dans les catalogues sont à titre de références. Nous réservons le droit de modifier de façon technique et/ou esthétique sans préavis. La production totale ou partielle de ce catalogue - sans notre accord - est interdite.

ES / Las imágenes en nuestro catálogo son sólo referenciales. Nos reservamos el derecho modificarlas técnica o estéticamente sin previo aviso. Prohibida la reproducción total o parcial del catálogo sin el consentimiento explícito de la empresa.

IT / L'immagine raffigurata nei nostri cataloghi non è vincolante per l'azienda, che si riserva il diritto di apportare modifiche estetiche o tecniche senza alcun preavviso. È vietata la riproduzione totale o parziale del presente catalogo senza il nostro consenso.

