

German quality - nothing less



BROMED
INSTRUMENTS



Chirurgia Plastica
Cirugía Plástica
Chirurgie Plastique

Plastische Chirurgie
Plastic Surgery

Table of Contents

Inhaltsverzeichnis
Tavola dei contenuti
Tabla de contenido
Table des matières

BMT	Firmenprofil Company Profile Profilo Compagnia Perfil de la empresa Profil de l'entreprise	III
BMT	Technische Informationen - Sterilisierung Technical Information - Sterilization Informazioni tecniche - Sterilizzazione Información técnica - Esterilización Information technique - Stérilisation	V
1	Diagnostik, Meßinstrumente, Skalpelle Diagnostic, Measuring Instruments, Knives Diagnostica, Strumenti per misura, Bisturi Diagnostico, Instrumentos de medición, Bisturios Diagnostic, Instruments à mesurer, Bistouris	1
2	Scheren Scissors Forbici Tijeras Ciseaux	13
3	Pinzetten Tissue Forceps Pinzette Pinzas Pincers	77
4	Arterienklemmen, Drahtumführungsnadel Hemostatic Forceps, Wire Guides Pinze emostatiche, Passafili Pinzas hemostáticas, Agujas para ligaduras Pincers hémostatiques, Cerclage instruments	107
5	Nadelhalter Needle Holders Port'aghi Portaagujas Porte aiguilles	131
6	Mundsperrer, Wundhaken, Nasen Spekula Mouth gags, Retractors, Nasal Specula Aprébocas, Divaricatori, Speculum nasali Aprébocas, Separadores, Espéculos nasales Ecarteur buccal, Ecarteurs, Spéculum nasaux	163
7	Raspatorien, Elevatorien Raspatories, Elevators Periostotomi, Elevatori Legras, Elevadores Rugines, Elevateurs	203
8	Knochenmeißel, Hämmer Bone Chisels, Hammers ScalPELLI, Martelli Cinceles, Martillos Scalpel, Maillets	221
9	Nasenraspeln, Löffel Nasal Rasps, Curettes Raspe nasali, Cucchiali Raspadores nasales, Cucharillas Râpes nasales, Curettes	251
10	Hohlmeißelzange Rongeurs Pinze ossivore Pinzas Gubias Pincers Gouges	267
11	Absaugkanülen, Nagelzangen Suction tubes, Nail Nippers Cannule, Tronchesi per unghie Cánulas, Pinzas para uñas Canule, Pincers pour ongles	285
12	Wartung und Sterilisierung Maintenance and Sterilization Manutenzione e Sterilizzazione Mantenimiento y Esterilización Entretien et Stérilisation	307
13	Alphabetischen Index Alphabetical index Indice alfabetico Indice alfabético Index alphabétique	317
14	Alphanumerischen Index Alphanumerical index Indice alfanumerico Indice alfanumérico Index alphanumérique	339
15	Addendum - Plastische Chirurgie Addendum - Plastic Surgery Addendum - Chirurgia Plastica Addendum - Cirugía Plástica Addendum - Chirurgie Plastique	A-1
16	Addendum - Nummernverzeichnis Addendum - Alphanumerical index Addendum - Indice alfanumerico Addendum - Indice alfanumérico Addendum - Index alphanumérique	A-62
17	Service und Reparatur Service and Repair Servizio e Riparazione Servicio y Reparación Service et Réparation	A-63
18	Vergleichstabellen Conversion Tables Tabelle di comparazione Tablas de comparación Tableaux de comparaison	A-63

Rinsing Procedures

Rinse

Immediately after surgery, rinse instruments under warm (not hot) running water. Rinsing should remove all blood, body fluids and tissue. Dried soils may damage the instrument surface and make cleaning very difficult. Do not use hot water as this will coagulate proteinous substances.

After rinsing, you can start any of the three cleaning techniques*.

(If not done immediately after rinsing, instruments should be submerged in a solution of water and neutral PH(7) detergent - "only" PH(7) because if not rinsed off properly, low PH detergents will cause breakdown of stainless protective surface and black staining. High PH detergent will cause surface deposit of brown stain, which will also interfere with smooth operation of the instrument. We strongly recommend using a detergent containing a rust inhibitor.*

Cleaning Procedures

Ultrasonic Cleaning

Using ultrasound combined with a special cleaning solution, **it is the most effective cleaning method available.**

Recommended for regular instruments such as hand instruments and forceps. Ultrasonic cleaning *is not recommended for instruments which are very delicate, are not 100% steel or which have sharp cutting edges* (scissors, needle holders, bone forceps and not 100% steel such as rubber, mouth mirrors, titanium, tungsten carbide inserts - TC or diamond dusted tips, etc.). The ultrasonic vibrations can chip, break or corrode any welded parts. For the delicate instruments, use manual cleaning.

Steps to follow:

- 1) Sort instruments carefully so as to include only instruments compatible with ultrasonic cleaning.
- 2) Place instruments in open position.
- 3) Make certain sharp edges are not touching other instruments.
- 4) Do not combine different metals (chrome plated, stainless, copper, titanium, etc.)
- 5) Change solution frequently to avoid accumulation of micro organisms.
- 6) After rinsing and before sterilization, inspect and dry the instruments thoroughly.

Advantages

• Safer than hand scrubbing, cleans instruments very effectively, reduces the risk of contaminants spreading through splatter, allows for more efficient use of staff time.

Disadvantages

- Remember to sort the instruments carefully and to change the cleaning solution.
- If the cement is not removed while it is still soft, ultrasonic cleaning will not remove hardened permanent cement.

Manual Cleaning

We recommend ultrasonic cleaning as the best and most effective way to clean surgical instruments, but sharp or delicate or not 100% steel instruments should be cleaned manually.

Steps to follow:

- 1) Use stiff plastic cleaning brushes (DB-11, DB-12, nylon, tooth brush, etc.) Do not use steel wool or wire brushes except specially recommended stainless steel wire brushes for instruments such as bone files, or on stained areas in knurled handles. In this case always treat instruments with the special "cleaning milk" Cleanlact so as to restore and protect the anti-rust coating.
- 2) Brush delicate instruments carefully and, if possible, handle them separately from general instruments.
- 3) Make sure all instrument surfaces are visibly clean and free from stains and tissue.
- 4) After scrubbing, rinse instruments thoroughly under running water. While rinsing, open and close scissors, hemostats, needle holders and other hinged instruments to ensure the hinge areas are fully rinsed, inside and out.

Advantages

• Effective if performed properly.

Disadvantages

- Increases risk of operator injury, increases the risk of contaminants spreading through splatter, labor-intensive.
- Requires proper care and periodical replacement of scrub brushes.

Automated Washer

This can also be a very effective cleaning method. Not all instruments are compatible with automated washers and restrictions vary according to the washer model.

Steps to follow:

It is necessary to see manufacturer's instructions for detailed requirements.

Advantages

- Same as Ultrasound Cleaning

Disadvantages

- Same as Ultrasound Cleaning.

Lubricating Procedures

Lubrication

Immediately after surgery, rinse instruments under warm (not hot) running water. Rinsing should remove all blood, body fluids and tissue. Dried soils may damage the instrument surface and make cleaning very difficult. Do not use hot water as this will coagulate proteinous substances.

Always lubricate instruments before sterilization, immediately after the last rinse cycle. Lubricate all instruments which have any metal to metal action such as hemostats, scissors, retractors and needle holders using the Rodhoil (DB-OLR) high density lubricant.

Proper lubrication will make your instruments more resistant to corrosion, rusting and staining. In addition to corrosion and stain prevention, lubrication cuts down friction at the joints, keeping the action of the instrument smooth, delicate and light and extending the life of your instruments.

We also recommend the Cleanlact (DB-1L) solution which is very effective in maintaining the anti-rust finish of your instruments and which also acts as a lubricant (see our further section stain treatment).

Sharpening Procedures

Why sharpen instruments?

Surgical Instruments should be kept identical to their original design. Dental and surgical procedures are most effective when using sharp instruments as they reduce hand and wrist fatigue, improve calculus removal, save time, improve tactile sensitivity, and minimize patient discomfort.

Instruments can be sharpened by using different types of stones:

Arkansas (a natural stone extracted from the mountains of Arkansas) and **India** (a synthetic stone quarried from the finest Ozark novaculite deposits -silicon quartz).

• **Arkansas flat stone (DB-96)**

Used to sharpen all cutting parts of surgical instruments (edge and toe of an instrument)

• **Arkansas conical stone (DB-299)**

Used to manually sharpen internal parts of curettes, scalers, gouges, rongeurs, etc. (toe and face of an instrument).

• **Arkansas rectangular stone (DB-4)**

Used to sharpen all cutting parts of surgical instruments (toe and face of an instrument).

• **Arkansas wedge stone (DB-6A)**

Used to manually sharpen internal parts of curettes and scalers. (toe and face of an instrument). Routine sharpening and finishing.

• **India wedge stone (DB-3)**

Used for sharpening of excessively dull instruments or those requiring re-contouring (toes and faces of an instrument).

How to sharpen instruments?

Generally, the instruments should be sharpened following this procedure:

- 1) Place one drop of Sharpenoil (DB-OL) on the arkansas/india stone. Lubrication improves the movement of the instrument blade over the stone; also, it prevents the metal particles from clogging the stone.
- 2) Hold the instrument in one hand, while applying the stone to the lateral surface angled with the face of the blade.
- 3) Position the stone to contact the heel of the blade and work toward the tip, keeping the stone in contact with the blade throughout the sharpening procedure.
- 4) Move the stone up and down with short strokes, placing more pressure on the down stroke. (Do not move the instrument, keep the instrument still).
- 5) Finish sharpening the instrument with a down stroke; this will prevent a rough edge from forming.
- 6) Evaluate the sharpness with the teflon testing stick (DB-15). If the blade is still dull, re-evaluate the angle of the stone and repeat the sharpening procedure (steps 2-6)

Scalers and Curettes

• **Sickle Scaler Toe End**

The sickle scaler has a pointed tip and, therefore, the stone is held straight as it nears the tip.

• **Curette Toe End**

The curette has a rounded toe, so the position of the stone is adapted around the rounded cross-section. With both types of instrument, always finish on a down stroke to remove any flash of metal.

When to sharpen instruments?

Instruments should be sharpened lightly after each use; there are two ways to evaluate whether the cutting edge is dull and requires sharpening:

• **Visual**

The cutting edge should be inspected regularly in a good light (and if possible, under magnification). If the cutting edge is blunt it will be rounded and reflect the light. A dull, non-reflective line indicates sharpness.

• **Teflon Testing Stick (DB-15)**

If the blade of the instrument runs smoothly over the testing stick, then it is blunt. A sharp instrument will grab into the stick and removes small fragments of the plastic.

Care of Sharpening Stones

After use, wipe the stone with a clean cloth to remove metal particles. Then, clean the stone by scrubbing or using ultrasound to remove lubricant before sterilization. After sterilization, lubricate before each use. Be sure to use entire stone to prevent "grooving".

Sterilization Procedures

Inspection

Before preparing for sterilization, all instruments should be inspected. Generally un-magnified visual inspection under good light conditions is sufficient. All parts of the instruments should be checked for visible soil and/or corrosion.

Remember: some types of damages (corrosion, rust and spots) are transmitted to the instruments intact. Always check cutting edges for sharpness and damage.

Packaging

Where appropriate the cleaned, disinfected, and checked medical devices should be assembled into the dedicated trays provided. BMT cassettes/containers should be simple or double wrapped according to AAMI/CSR technique. (AAMI: Association for Advancement of Medical Instrumentation / CSR: central sterilization room) The packaging for terminally sterilized medical devices should fulfill the following requirements:

- EN ISO 11607
- Suitable for steam sterilization (temperature resistance up to at least 141 °C, sufficient steam permeability)
- Sufficient protection of the instruments as well as of the sterilization packagings to mechanical damage.

Sterilization

It is a procedure which removes all pathogenic and non pathogenic micro-organisms; it should be performed with utmost care.

These are the most common and effective sterilization techniques:

- 1 | Autoclave - Steam Sterilization
- 2 | Chemiclave
- 3 | Dry Sterilization

Sterilization Techniques

Autoclave - Steam Sterilization

Steam autoclave (moist heat) sterilization using a pre-vacuum (forced air removal) cycle is recommended. Instruments are treated with high pressure water steam.

Sterilizing agent: distilled water.

Recommended standard times and temperature*:
4 - 20 min. / 130 - 134°C (266 - 268°F)

Advantages

- Highly effective
- Nontoxic
- Inexpensive
- Rapid heating & rapid penetration of instruments

Disadvantages

- Items must be heat and moisture resistant.
- Needs good maintenance. The autoclave is not working correctly if steam comes out of the lid or around the door.

Chemiclave

Instruments are treated with high pressure, with the help of chemical steams. Instruments must be dried before sterilization.

Sterilizing agent: special chemical solutions.

Recommended standard times and temperature*:
4 - 20 min. / 130 - 134°C (266 - 268°F)

Advantages:

- Minimal dulling, rusting and corroding of instruments.
- Unsaturated chemical vapor method is a low-humidity process.
- The heat-up time is shorter than for most steam sterilizers.
- Easy to operate, fill and purge / Minimal order.

Disadvantages:

- Needs adequate ventilation / It is flammable
- Vapo-Steril solution has formaldehyde in it, known to be a potential carcinogen.
- Needs to be mixed with water when disposed.

Automated Washer

Instruments sterilization takes place by means of hot air. Instruments must be dried before sterilization.

At present, this sterilization technique is not recommended, as it doesn't guarantee reliable sterilization and gradually causes damages.

Recommended standard times and temperature*:
60 - 90 min. / 150 - 170°C (300 - 320°F)

Advantages

- Reaches surfaces of instruments that cannot be disassembled. This is accomplished by conduction.
- Low cost.

Disadvantages

- Long exposure time is necessary.
- High temperatures gradually cause damages such as surface blackening, loss of polish and dullness.
- Specialized packaging is needed.

For more information, view our catalogue online:
"Instrument Cleaning, Sterilization & Maintenance"
www.BMTsurgical.com/catalogues.html

Instrument Protection

Instrument Care

Surgical instruments can be reused, unless indicated otherwise. The life time of instruments depends on the frequency of use, the care of the user and proper reprocessing methods. The most effective method of dealing with instrument problems is to prevent them from occurring. The use of "treated water", careful preliminary cleaning, the use of neutralized PH solution, adherence to manufacture's instructions, and visual inspection, will help to keep instruments performing accurately free of troublesome stains. It is important to act quickly should a problem arise.

New Instruments

- New instruments must be processed before use.
- They must undergo the entire cleaning process.
- They are usually oiled in production and this must be removed prior to running them through a sterilizer (Do not take from packaging and go to the sterilizer).

Factors affecting instrument care

1 | Water

Regular tap water is not appropriate for instrument sterilization. High chloride and lime concentration and various other minerals can lead to staining or damage of the stainless steel. When water dries, chlorides will concentrate and cause pitting on the instrument. Fully Desalted Water avoids this problem.

2 | Corrosion

Certain compounds are highly corrosive to stainless steel and will cause serious damage despite the passivated protective surface. If instruments are inadvertently exposed to any of the following substances, they should be rinsed immediately with copious amounts of water.

Instruments should never be exposed to:

- Aqua regia
- Ferric chloride
- Hydrochloric acid
- Iodine
- Sulfuric acid

Removing Stains

Stains can be removed, whereas rust will leave permanent damage. To determine if a brown or orange discoloration is a stain or rust, use the eraser test:

- 1) Rub a pencil eraser over the discoloration.
- 2) If the discoloration is removed with the eraser and the metal underneath is smooth and clean, this is a stain.
- 3) If a pit mark appears under the discoloration, this is corrosion or rust.

Stain and Rust Protection

It is common for instruments to become stained or spotted despite the best efforts. In nearly all cases these problems are the result of minerals deposited upon the surfaces of the instruments, as well as insufficient cleaning. Proper technique during cleaning and sterilizing procedures will prevent most staining occurrences.

Diagnosing spots and stains

• Brown/Orange Stains

Cause: A result of high-pH detergents. Chlorhexidine usage or improper soaking of instruments. This color stain can also be caused by soaking in tap water.

• Dark Brown Stains

Cause: Low-pH instrument solutions. The brownish-colored film may also be caused by a malfunctioning sterilizer. Similar localized stain spots can also be a result of baked-on blood.

• Bluish Black Stains

Cause: Reverse plating, when instruments of different metal (e.g. chrome and stainless steel) are ultrasonically processed together. This can occur when high quality instruments are mixed with lower end ones. Additionally, exposure to saline, blood, or potassium chloride will cause this bluish black color. Similar to tarnish on silverware.

• Black Stains

Cause: Contact with ammonia or a solution containing ammonia.

• Light or Dark Spots

Cause: Water droplets drying on the instruments. With slow evaporation, the minerals sodium, calcium and magnesium left behind can cause this spotting.

• Rust Deposits

Cause: Dried blood that has become baked on the serrated or hinged areas of surgical instruments. This organic material, once baked on, may appear dark in color. Also can be caused by soaking in tap water.

Warnings

• BMT's product warranty against manufacturer defects automatically expires in the cases of improper care, maintenance and/or use.

• New instruments must undergo the entire cleaning process before use. Do not take from packaging and go to the sterilizer.

• Avoid putting oxidized or rusty instruments in sterilizing or disinfectant solutions, as other instruments could be attacked.

• BMT usually does not define the maximum number of uses appropriate for re-usable surgical instruments. The useful life of these devices depends on many factors including the method and duration of each use, and the handling between uses. Careful inspection and functional test of the device before use is the best method of determining the end of serviceable life for the medical device.

• Used, damaged and oxidized tools should not be used because they are no longer able to perform their function. Please note that some types of damages (corrosion, rust and spots) are transmitted to the instruments intact.

• Sterilization does not replace the cleaning and maintaining of the instruments. -Ultrasonic Cleaning does not sterilize.

• The tools provided by BMT are subject to Directive 93/42/EEC and therefore be discarded by the regional force.

Instrument Maintenance and Sterilization

Remove gross soil / Place in aldehyde-free disinfectant bath / Rinse in running water / Disassemble where possible
Soak in cleaning solution / Brush, operate moving parts / Rinse in running water / Inspect, place on absorbent paper



Sharpen and Lubricate



ARKANSAS Flat Stone N° 8
DB-96 | 100 x 50 x 13 mm

What? A natural stone extracted from the mountains of Arkansas. Its shape is flat and rectangular.

Why? To sharpen all cutting parts of surgical instruments.

When? Whenever necessary to sharpen cutting parts (scissors, osteotomes, curettes, etc.).



ARKANSAS Conical Stone N° 299
DB-299 | Ø 8 x 90 mm

What? A natural stone extracted from the mountains of Arkansas. Its shape is cone-shaped and cylindrical.

Why? To manually sharpen internal parts of curettes, scalars, gouges, rongeurs, etc.

When? Whenever necessary to sharpen the internal parts of surgical instruments in areas that otherwise cannot be reached.



ARKANSAS Wedge N° 6A | DB-6A
INDIA Wedge N° 6 | DB-3

What? *India:* quarried from the finest Ozark novaculite (silicon quartz) deposits. *Arkansas:* extracted from Arkansas mountains.

Why? To manually sharpen internal parts of curettes and scalars.

When? *India:* for sharpening of excessively dull instruments or those requiring recontouring. *Arkansas:* for routine sharpening and finishing.



ARKANSAS Rectangular N° 4
DB-4 | 100 x 12 x 25 mm

What? A natural stone extracted from the mountains of Arkansas. Its shape is flat and rectangular.

Why? To sharpen all cutting parts of surgical instruments.

When? Whenever necessary to sharpen cutting parts (scissors, osteotomes, curettes, etc.).



Lubricating and sharpening oil
SCHARPENOIL | DB-0L | 30 cc

What? A non-coloured oil, which is an indispensable complement for lubricating and manual sharpening of surgical instruments.

Why? To ensure perfect function and fluid movement of all surgical instruments. To activate the abrasive properties of all stones and to reduce the possibility of overheating the instruments during sharpening.

When? It should be applied on all hinges or all other parts which are subject to movement or friction. Its use facilitates elimination of any residue present within the instrument hinges. Must ALWAYS be used during all sharpening operations.

Testing

Teflon Testing Stick
DB-15 | Ø 8 x 100 mm

What? A hard plastic stick used to test the blade of an instrument.

Why? To determine the sharpness of an instrument.

When? Always. If the blade of the instrument runs smoothly over the plastic stick, then it is blunt. A sharp instrument will grab into the stick and removes small fragments of the plastic.



Sterilization

Steel Cassettes with silicone racks
Stainless Steel

- BS-59 - (5 instruments)^D
- BS-60 - (10 instruments)^E
- BS-61 - (20 instruments)^F

Dimensions (mm)
185 x 35 x (75^D / 135^E / 185^F)



Containers

Stainless Steel - Aluminium

- CT-555N^A / CT-556N^A
- CT-560N^B / CT-564N^B
- CT-565N^C / CT-569N^C

Dimensions (mm)
300 x 140 x (40^A / 70^B / 100^C)



Rinse and Clean

Detergent | CLEANLACT
DB-10M | DB-50M | DB-1L
250 cc | 500 cc | 1000 cc

What? A bacteriostatic and anticorrosive detergent.

Why? Anticorrosive, bacteriostatic and lubricating action on all surgical instruments. It guarantees perfect maintenance by eliminating eventual stains, halos and browning due to sterilization, disinfection and washing with tap water.

When? Use periodically, diluted or concentrated (see special instructions on packaging).



BRUSH
DB-11
DB-12

What? Special brushes for surgical instruments.

Why? To remove eventual residue, organic or not, from all surgical instruments, in particular in angled, hinged and knurled parts, without damaging instrument surface. Autoclavable.

When? Every time, for regular cleaning of all instrumentation and in the event that an instrument is exposed for an extended period to air before being immersed in the cleaning solution.



Special Rubber for metal
DB-07 | Fine
DB-08 | Coarse

What? An abrasive eraser specially designed for surgical instruments.

Why? To remove stains, halos or persistent burnishing from all surgical instruments without damaging the instrument surface.

When? Necessary when routine cleaning does not remove all stains.





1

Diagnostik, Meßinstrumente, Skalpell
Diagnostic, Measuring Instruments, Knives
Diagnostica, Strumenti per misura, Bisturi
Diagnostico, Instrumentos de medición, Bisturi
Diagnostic, Instruments à mesurer, Bistouris



**DUPLAY
AB-41R**
Nasenspekulum
Nasal specula
Speculum nasale
Especulo nasales
Spèculum nasal

Speculum in Nylon
Schwarz - Black - Nero
Negro - Noir



- # 1 - Ø 3,0 mm
- # 2 - Ø 4,5 mm
- # 3 - Ø 5,5 mm

AB-32R
Satz zu 3
Set of 3
Set 3 pezzi
Juego de 3
Jeu de 3
Fig. 1-3

Spekulum für Erwachsene
Specula for adults
Speculum per adulti
Especula para adultos
Spèculum pour adultes

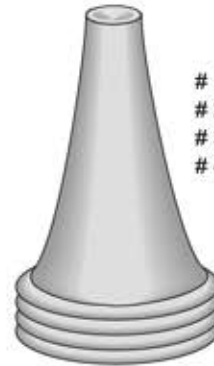

- # 1 - AB-04 - Ø 4,5 mm
- # 2 - AB-05 - Ø 5,5 mm
- # 3 - AB-06 - Ø 6,5 mm
- # 4 - AB-07 - Ø 7,5 mm

**HARTMANN
AB-09**
Satz zu 4
Set of 4
Set 4 pezzi
Juego de 4
Jeu de 4
Fig. 1-4

Laryngoskope - Laryngoscopes
Laringoscopi - Laringoscopios - Laryngoscopes

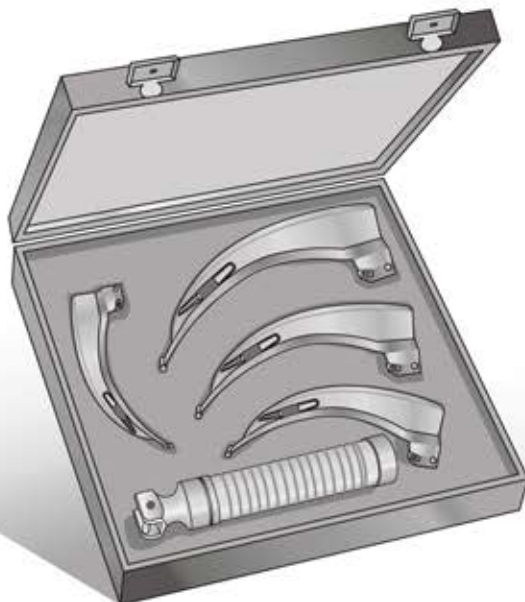

**Mc INTOSH
AA-S104 - Set 4 lame**



**Mc INTOSH
AA-S503 - Set 3 lame**

Kaltlicht
Fiber Optic
A luce fredda
De Luz fria
A lumière froide

Meßbereich: 0 - 15 mm
 Measuring range: 0 - 15 mm
 Campo di misura: 0 - 15 mm
 Alcance de medición: 0 - 15 mm
 Etendue de mesure: 0 - 15 mm

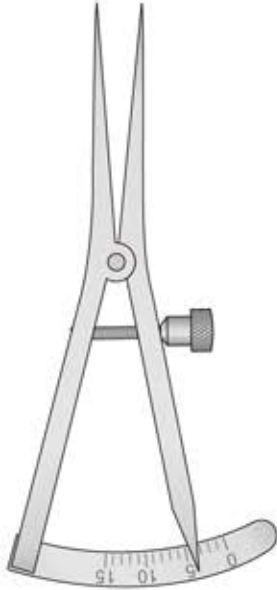

CASTROVIEJO
 OR-15
 90 mm

Meßbereich: 0 - 20 mm
 Measuring range: 0 - 20 mm
 Campo di misura: 0 - 20 mm
 Alcance de medición: 0 - 20 mm
 Etendue de mesure: 0 - 20 mm

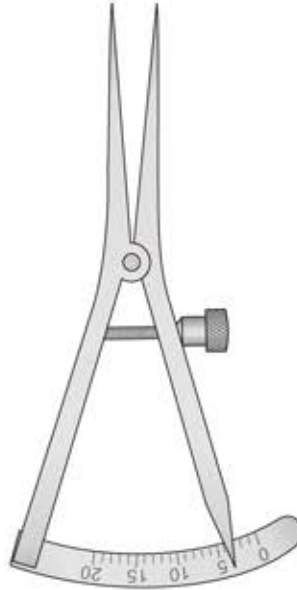

CASTROVIEJO
 OR-17
 90 mm

Meßbereich: 0 - 20 mm
 Measuring range: 0 - 20 mm
 Campo di misura: 0 - 20 mm
 Alcance de medición: 0 - 20 mm
 Etendue de mesure: 0 - 20 mm

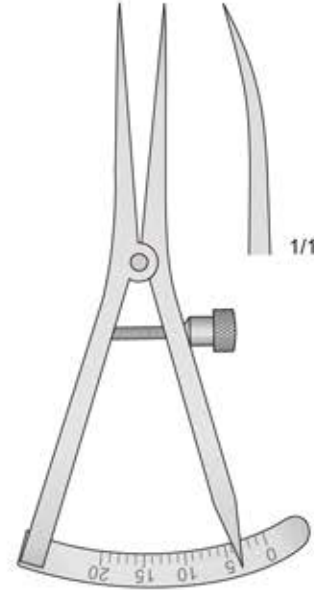

CASTROVIEJO
 OR-19
 90 mm

Meßbereich: 0 - 40 mm
 Measuring range: 0 - 40 mm
 Campo di misura: 0 - 40 mm
 Alcance de medición: 0 - 40 mm
 Etendue de mesure: 0 - 40 mm

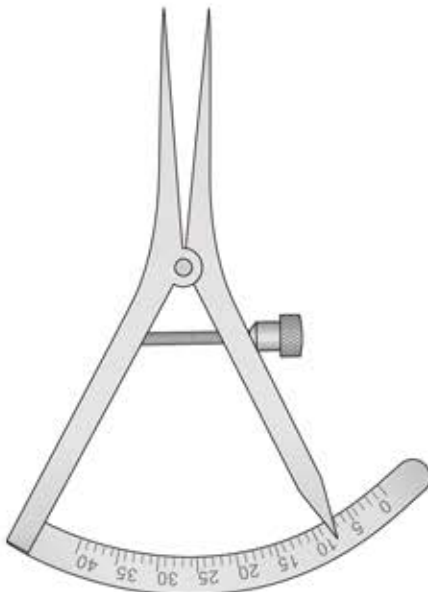

CASTROVIEJO
 OR-11
 90 mm

Meßbereich: 0 - 40 mm
 Measuring range: 0 - 40 mm
 Campo di misura: 0 - 40 mm
 Alcance de medición: 0 - 40 mm
 Etendue de mesure: 0 - 40 mm

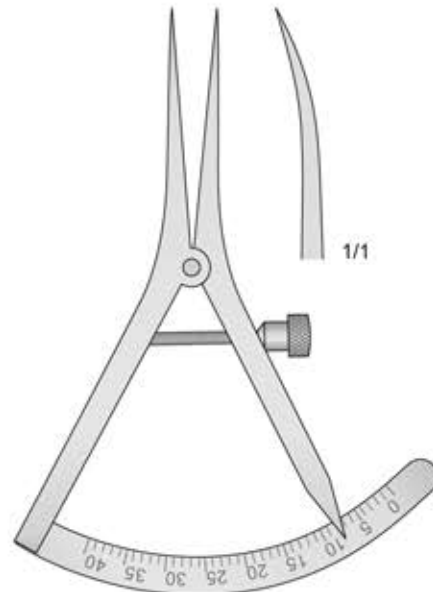

CASTROVIEJO
 OR-13
 90 mm

Messinstrumente

Measuring instruments

Strumenti per misura

Instrumentos para medir

Instruments à mesurer

Meßbereich: 0 - 80 mm
 Measuring range: 0 - 80 mm
 Campo di misura: 0 - 80 mm
 Alcance de medición: 0 - 80 mm
 Etendue de mesure: 0 - 80 mm

Meßbereich: 0 - 80 mm
 Measuring range: 0 - 80 mm
 Campo di misura: 0 - 80 mm
 Alcance de medición: 0 - 80 mm
 Etendue de mesure: 0 - 80 mm



OR-40
125 mm



OR-45
95 mm



LS-04
80 mm

0,5 mm



LS-07
50 mm

0,5 mm



LS-08
120 mm

0,5 mm



LS-09
150 mm

0,5 mm



LS-06
300 mm



MA-B3
Fig. 3



MA-B3M
Fig. 3M



MA-B7
Fig. 7



MA-B7K
Fig. 7k



MA-B1
Fig. 5

Skalpellgriffe
Skalpellklingen, steril

Scalpel handles
Scalpel blades, sterile

Manici per bisturi
Lame da bisturi sterili

Mangos de bisturi
Hojas de bisturi
estériles

Manches de bistouris
Lames de bistouris
stériles

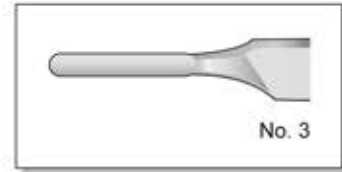

1,5 mm



MA-B8

2,5 mm



MA-B9



LB-10
Fig. 10



LB-11
Fig. 11



LB-12
Fig. 12



LB-13
Fig. 13



LB-15
Fig. 15



MA-B2
Fig. 5a



MA-B8/MA-B9
155 mm

Packung mit 100 Stück
Package with 100 units
Scatola da 100 pezzi
Paquete con 100 unidades
Boîte avec 100 lames

Skalpelligriffe
Skalpelligingen, steril

Scalpel handles
Scalpel blades, sterile

Manici per bisturi
Lame da bisturi sterili

Mangos de bisturi
Hojas de bisturi
estériles

Manches de bistouris
Lames de bistouris
stériles

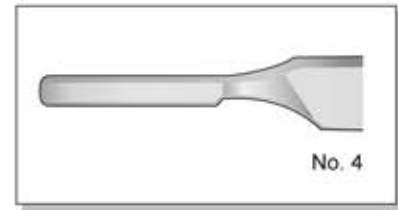

MA-B4
Fig. 4



MA-B10
Fig. 8



LB-20
Fig. 20



LB-21
Fig. 21



LB-22
Fig. 22



LB-23
Fig. 23



LB-25
Fig. 25

Packung mit 100 Stück
Package with 100 units
Scatola da 100 pezzi
Paquete con 100 unidades
Boîte avec 100 lames

Mikro-Skalpellklingen,
Skalpellgriffe

Micro Scalpel Blades,
Scalpel handles

Micro lame per bisturi,
Manici per bisturi

Micro hojas de bisturi,
Mangos de bisturi

Micro lame de bistouris,
Manches pour bistouris



LB-361



LB-362



LB-364



LB-365



LB-367



LB-368

Packung mit 10 Stück
Package with 10 units
Confezione 10 pezzi
Paquete con 10 unidades
Boîte avec 10 lames



LB-363



LB-366



LB-369

Packung mit 1 Stück
Package with 1 unit
Confezione 1 pezzo
Paquete con 1 unidade
Boîte avec 1 lame

Für Mikro-Skalpellklingen - For Micro Scalpel Blades
Per Micro Lame - Para Micro Hojas
Pour Micro-Lame de bistouris



NK-1
100 mm



NK-2
150 mm



BB-36
125 mm



BB-46
135 mm



BB-48 - 155 mm
BB-50 - 180 mm
BB-52 - 200 mm



1/1

CASPAR
BB-50



1/1

BB-52

Rasierklingen
Klingenbrecher

Razor Blades
Blade removing forceps

Lamette da rasoio
Pinze per rimozione lame

Hojas de afeitar
Pinza para quitar hojas

Lames de rasoir
Pinces pour enlever
les lames



LB-40
Packung 10 Klingen
Package 10 blades
Scatola da 10 lame
Cajita de 10 hojas
Boite de 10 lames

Klingen-Entferner - Blade Remover
Per rimozione lame - Saca-Hojas
Enlève-Lames

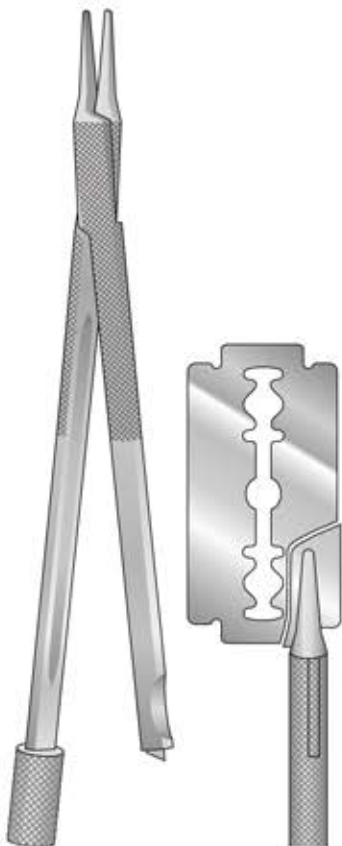

NK-12
120 mm

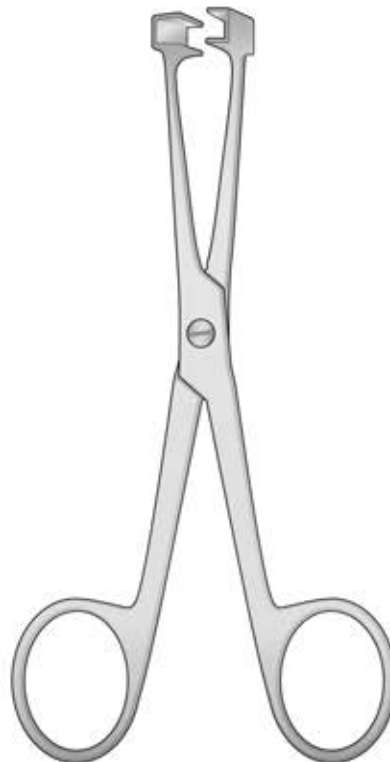

GS-18
135 mm

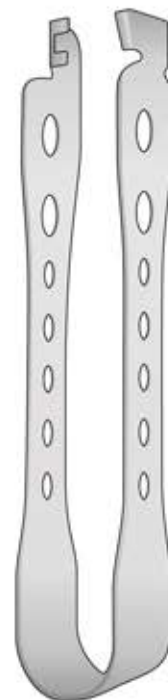

GS-16
115 mm

Rhinoplastikmesser

Rhinoplasty Knives

Bisturi per rinoplastica

Cuchillos para rinoplastica

Couteaux pour Rhino-plastie

Spitz
Sharp
Acuto - Agudas
Pointu



JOSEPH
NK-430/NK-431

Gerade
Straight
Diritto - Recto
Droit



1/1
NK-430
150 mm

Gebogen
Curved
Curvo - Curvo
Courbe



1/1
NK-431
150 mm

Stumpf
Blunt
Smussa - Romas
Mousse



JOSEPH
NK-432/NK-433

Gerade
Straight
Diritto - Recto
Droit



1/1
NK-432
150 mm

Gebogen
Curved
Curvo - Curvo
Courbe



1/1
NK-433
150 mm



JOSEPH
NK-100
150 mm



1/1



CONVERSE
NK-101
160 mm



1/1



FOMON
NK-102
160 mm



FOMON
FR-176
160 mm



1/1

1/1



COTTLE
FR-12
150 mm



COTTLE
FR-48
150 mm

Rhinoplastikmesser

Rhinoplasty Knives

Bisturi per rinoplastica

Cuchillos para rinoplastica

Couteaux pour Rhino-plastie



FREER
FR-11
175 mm

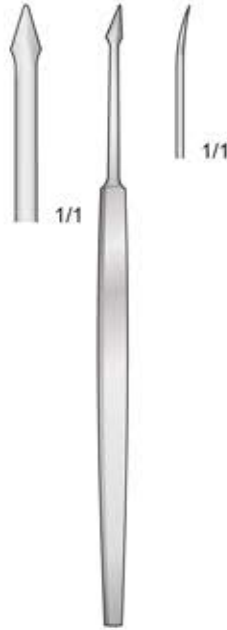

MASING
FR-168
130 mm

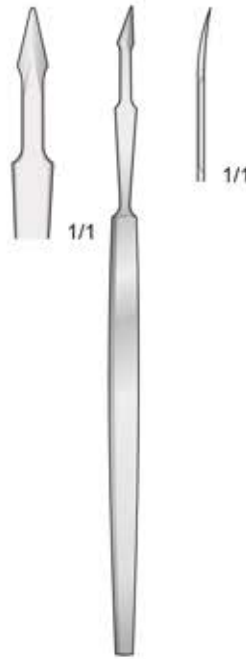

MASING
FR-169
130 mm



BALLENGER
FR-175
140 mm



FREER
FR-18
165 mm



BRÜNINGS
FR-177
165 mm



MALTZ
FR-19
160 mm

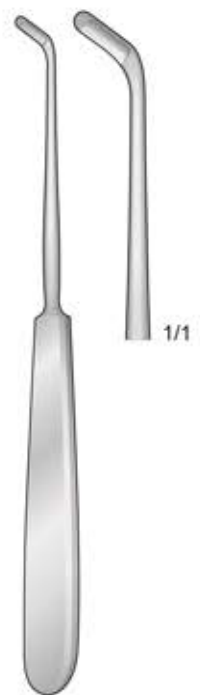

JOSEPH
FR-49
160 mm

2

Scheren
Scissors
Forbici
Tijeras
Ciseaux

Mikro Scheren

Micro scissors

Micro forbici

Micro tijeras

Micro ciseaux

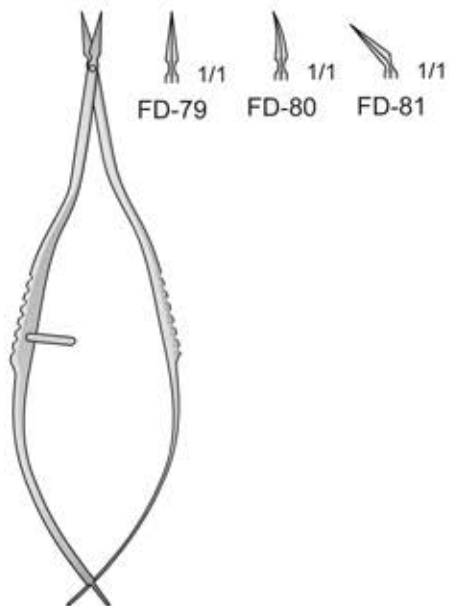

VANNAS
FD-79/FD-81
85 mm

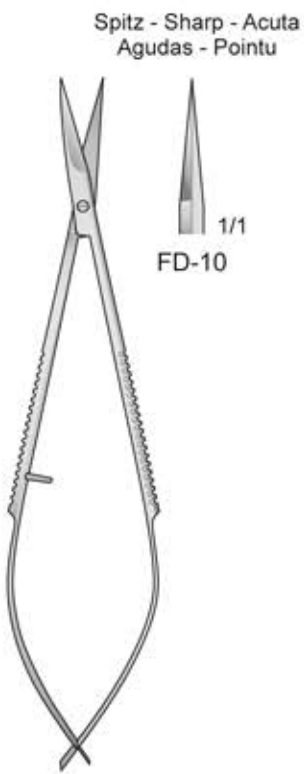

NOYES
FD-10
120 mm

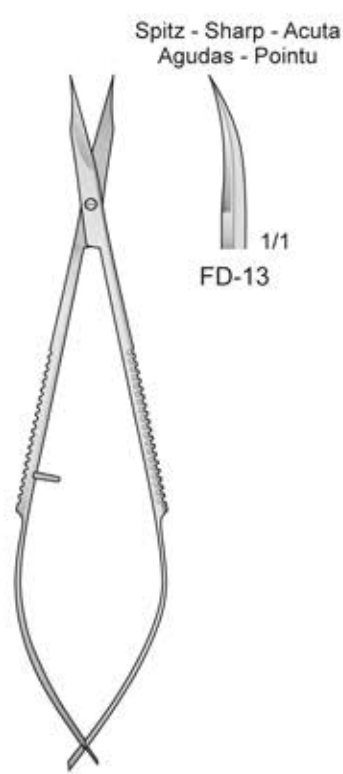

WESTCOTT
FD-13
120 mm

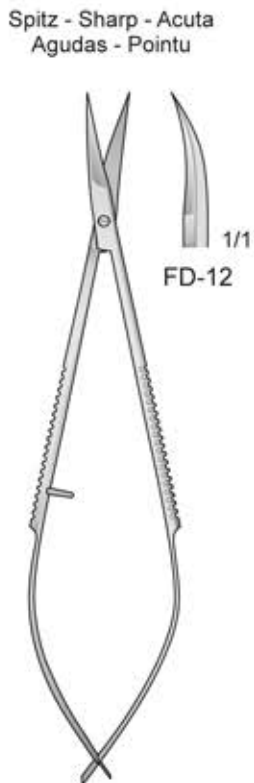

NOYES
FD-12
120 mm

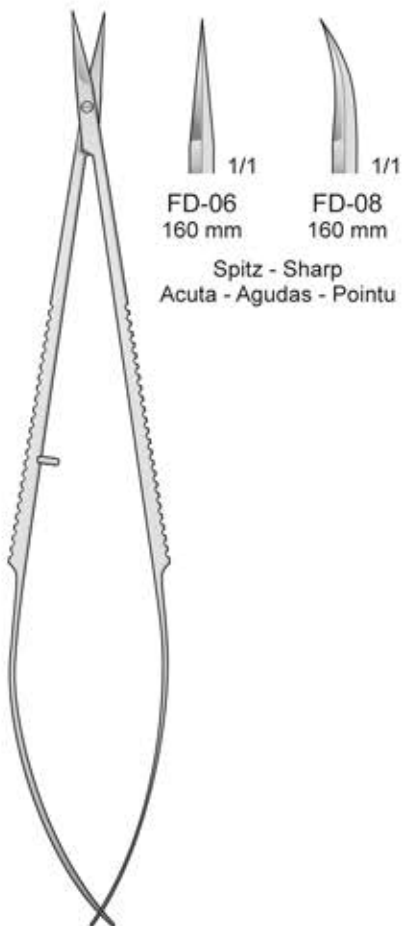

FD-06/FD-08
160 mm

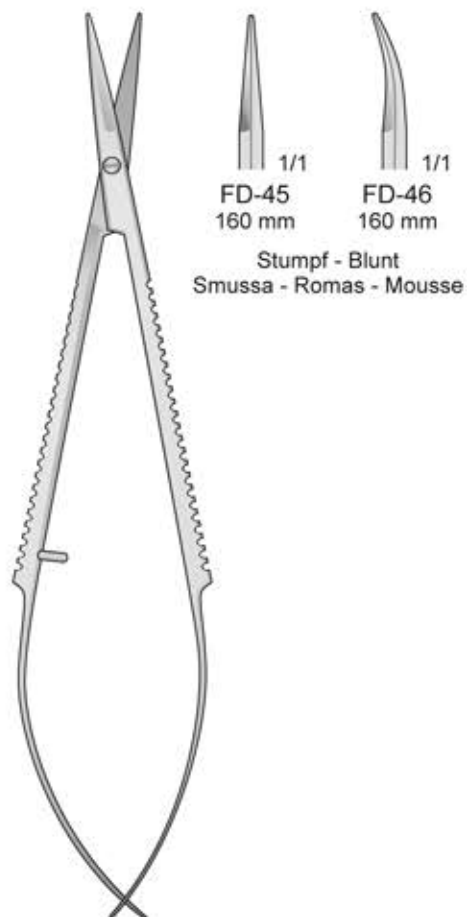

FD-45/FD-46
160 mm

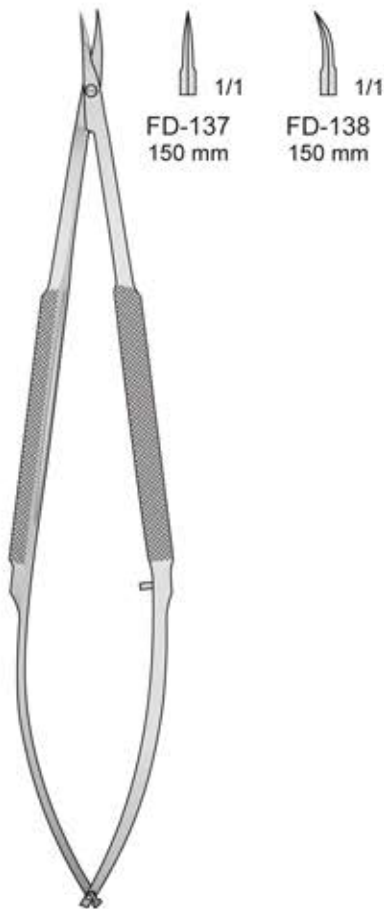

FD-137
150 mm

FD-138
150 mm

FD-137/FD-138
150 mm

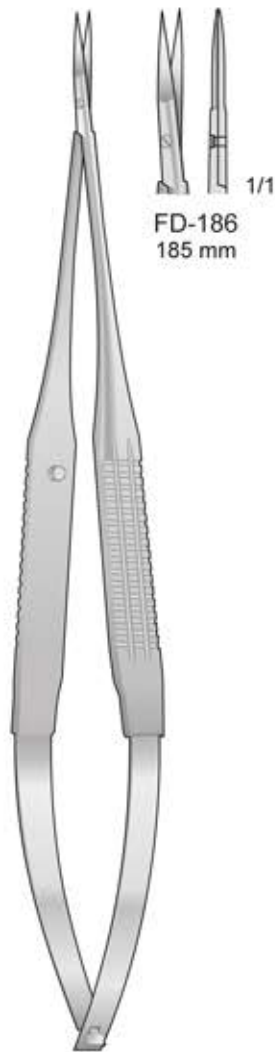

FD-186
185 mm

YASARGIL
FD-186
185 mm

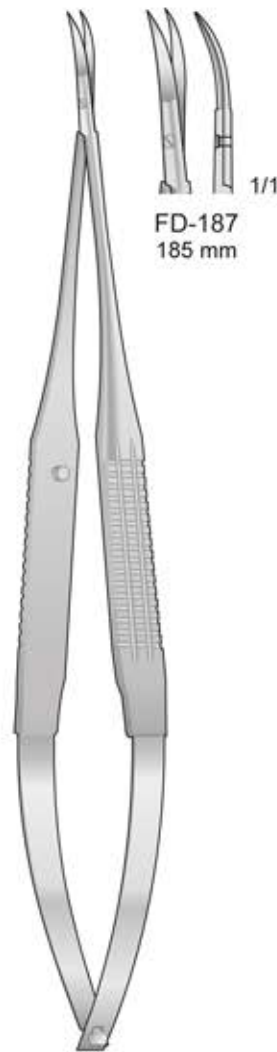

FD-187
185 mm

JACOBSON
FD-187
185 mm

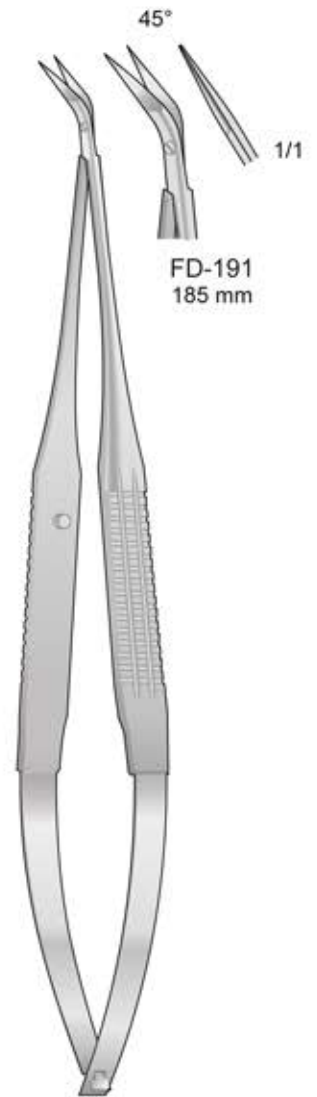

FD-191
185 mm

POTTS-YASARGIL
FD-191
185 mm

Mikro Scheren

Micro scissors

Micro forbici

Micro tijeras

Micro ciseaux



BROCK
FD-221
150 mm



BROCK
FD-223
150 mm



FD-306/FD-311
190 mm



FD-306

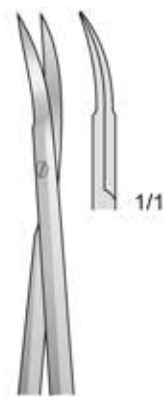

FD-307



FD-310

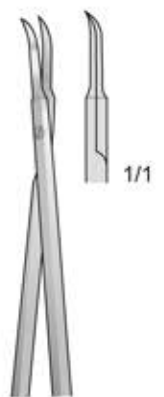

FD-311

Forbici ad anelli grandi

Iris scissors

Blepharoplasty
Blefaroplastica

Spitz - Sharp
Acuta - Aguda
Pointu

Spitz - Sharp
Acuta - Aguda
Pointu

Stumpf - Blunt
Smussa - Romas
Mousse

Spitz - Sharp
Acuta - Aguda
Pointu

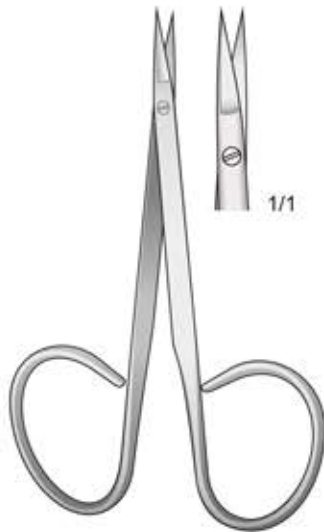

FG-200
95 mm

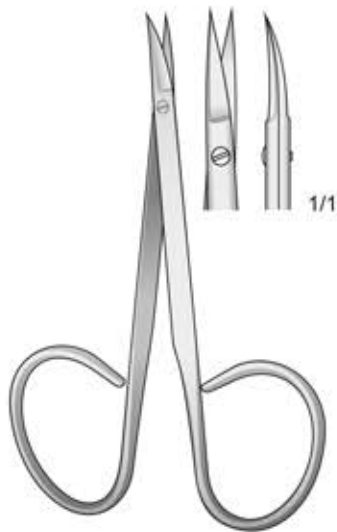

FG-201
95 mm

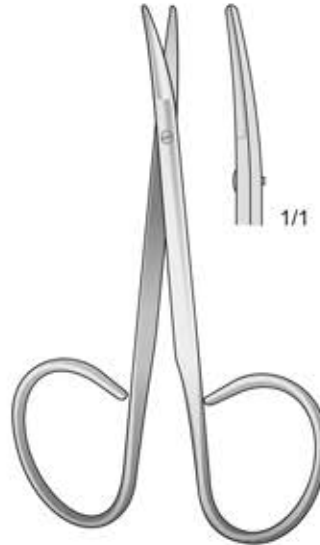

FG-202
95 mm

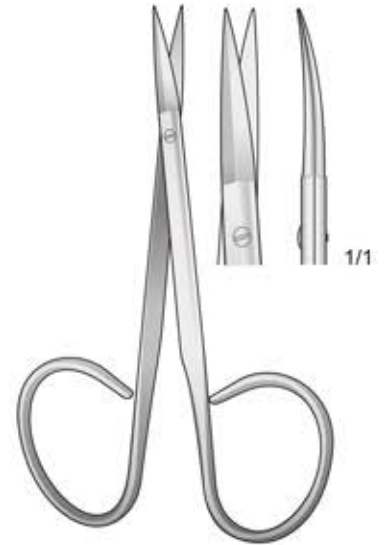

FG-203
105 mm

Iris scissors

Stumpf - Blunt
Smussa - Romas
Mousse

Stumpf - Blunt
Smussa - Romas
Mousse

Spitz - Sharp
Acuta - Aguda
Pointu

Spitz - Sharp
Acuta - Aguda
Pointu

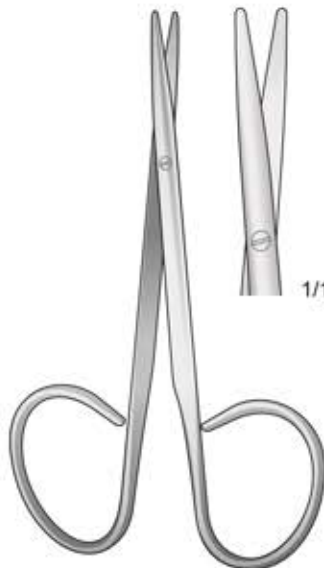

FG-204
100 mm

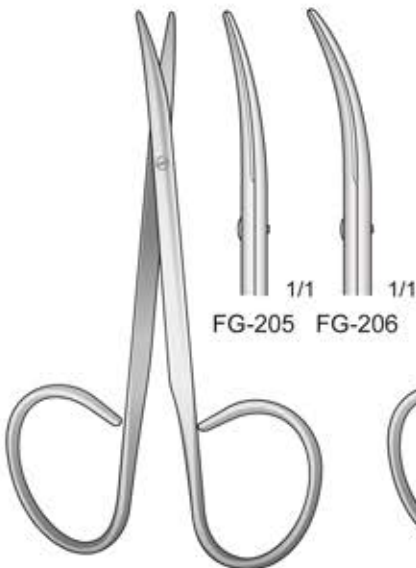

FG-205/FG-206
100 mm

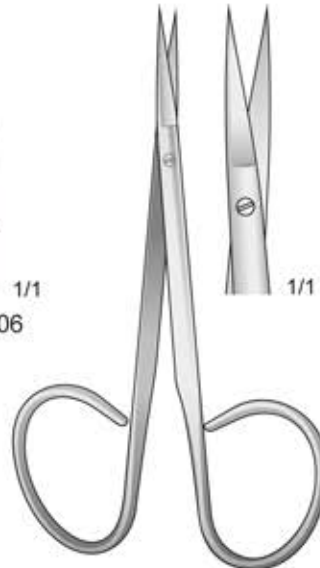

FG-207
105 mm

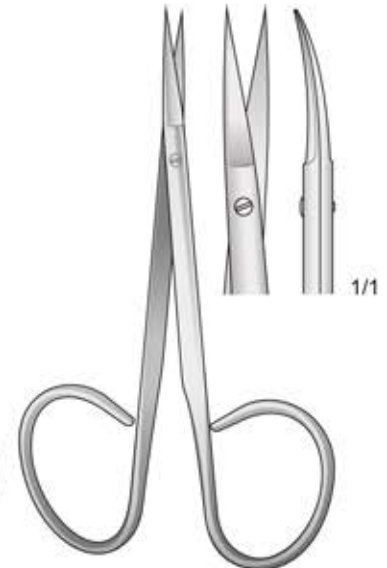

FG-208
105 mm

Forbici ad anelli grandi

Stumpf - Blunt
Smussa - Romas
Mousse

Stumpf - Blunt
Smussa - Romas
Mousse

Spitz - Sharp
Acuta - Aguda
Pointu

Spitz - Sharp
Acuta - Aguda
Pointu

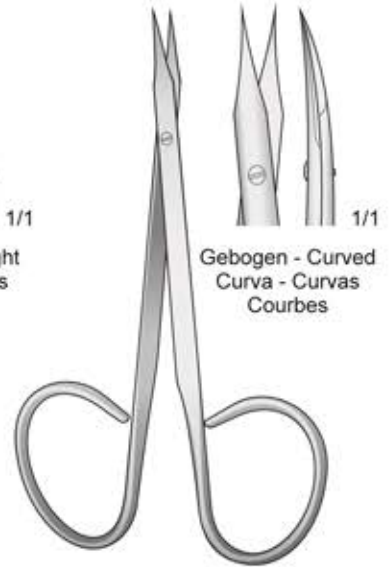
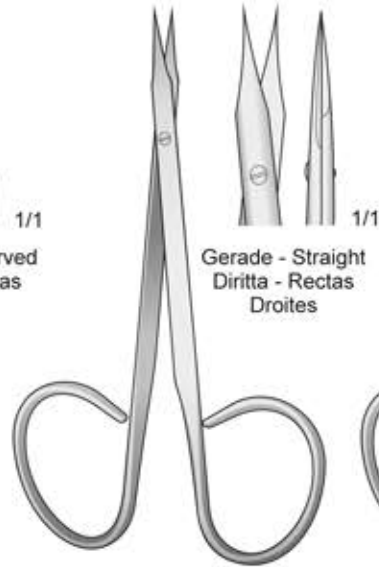
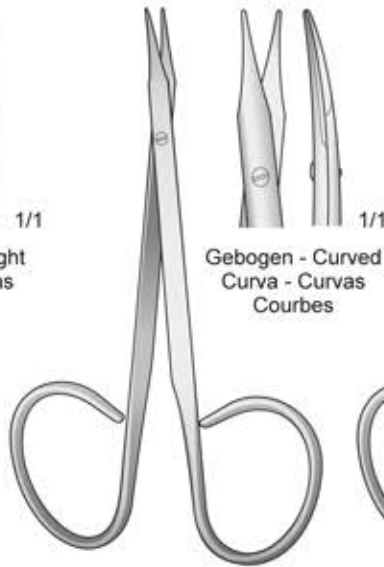
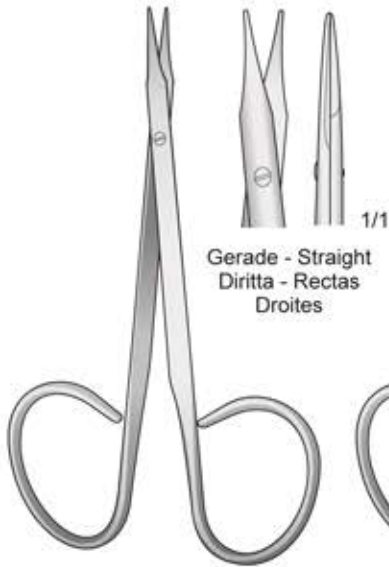

Gerade - Straight
Diritta - Rectas
Droites

Gebogen - Curved
Curva - Curvas
Courbes

Gerade - Straight
Diritta - Rectas
Droites

Gebogen - Curved
Curva - Curvas
Courbes

STEVENS
FG-209
100 mm

STEVENS
FG-210
100 mm

WALTON
FG-211
100 mm

WALTON
FG-212
100 mm

Spitz - Sharp
Acuta - Aguda
Pointu

Gezahnt - Serrated
Dentellata - Dentadas
Dentelés

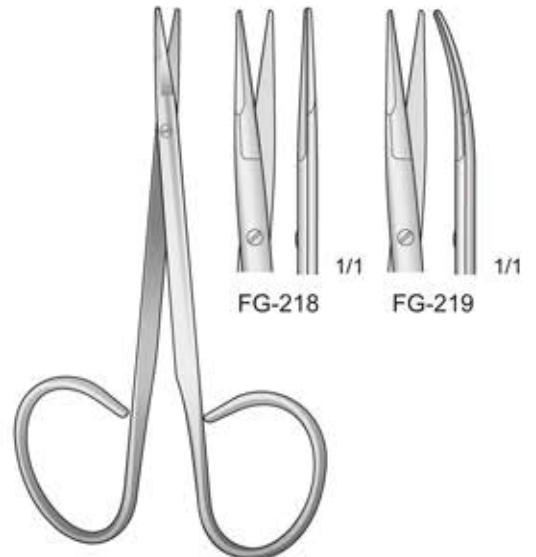
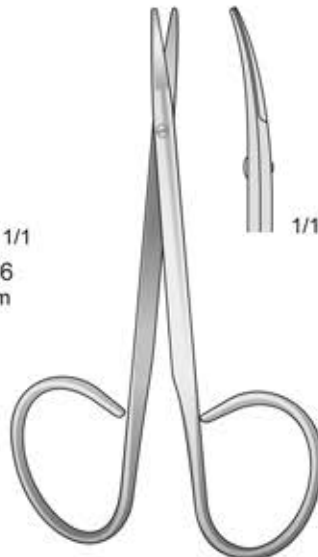
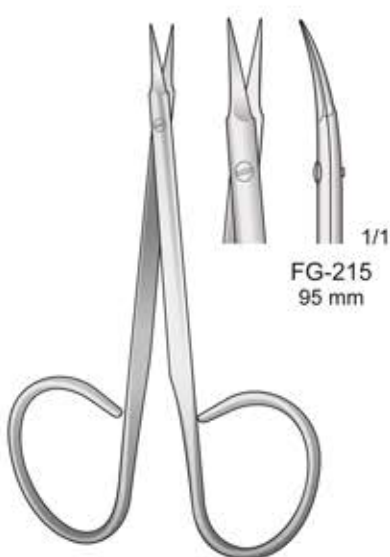

FG-215
95 mm

FG-216
115 mm

FG-218

FG-219

STITCH
FG-215/FG-216

RAGNELL
FG-217
100 mm

KAYE
FG-218/FG-219
105 mm

Spitz - Pointed - Acute
Agudas - Pointus

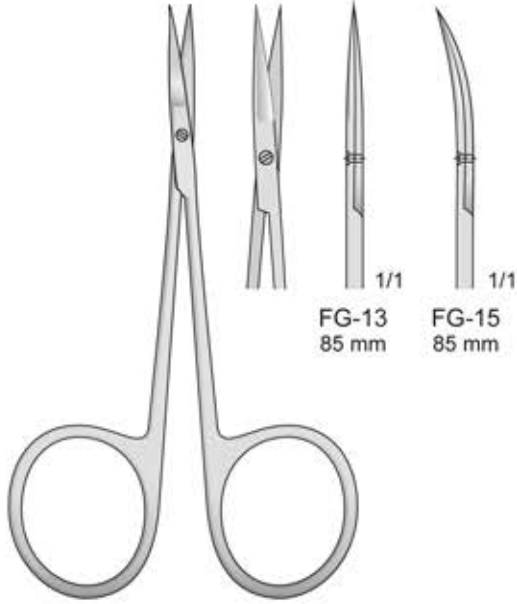

MICRO-IRIS
FG-13/FG-15
85 mm

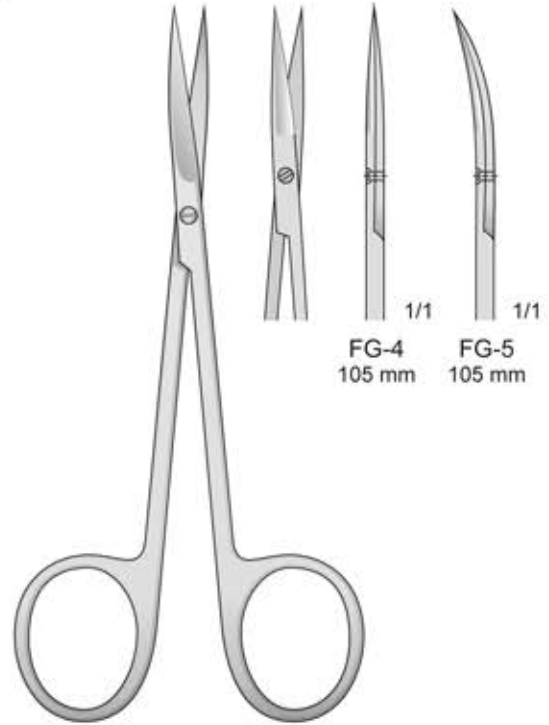

FG-4/FG-5
105 mm

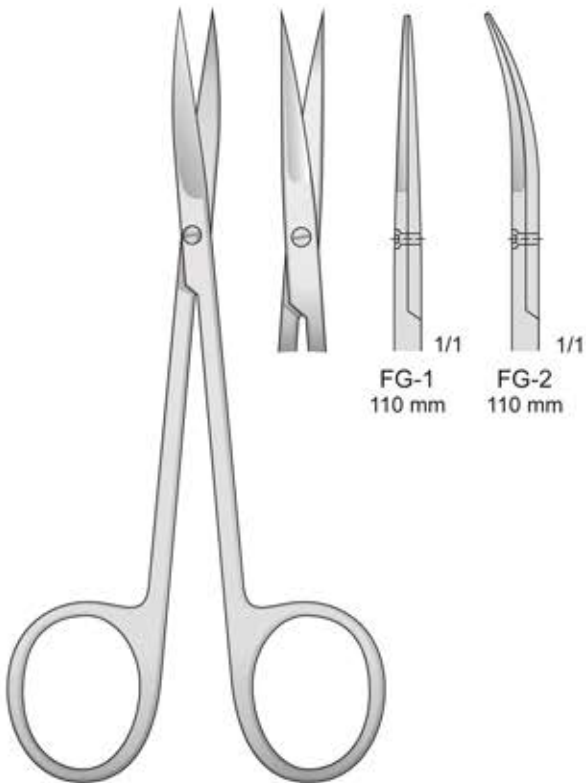

IRIS
FG-1/FG-2
110 mm

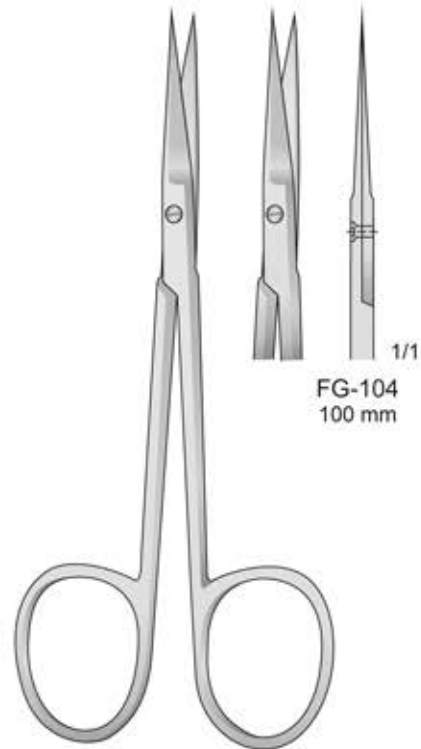

FG-104
100 mm

Feine Scheren

Delicate scissors

Forbici delicate

Tijeras finas

Ciseaux délicate

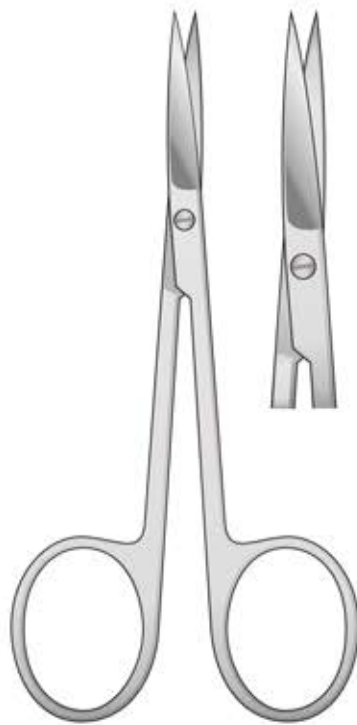

FG-23/FG-24
110 mm

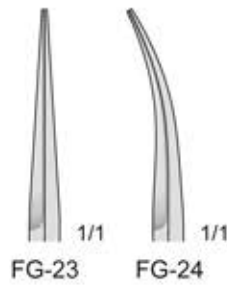

Stumpf - Blunt
Smussa - Romo - Émoussé

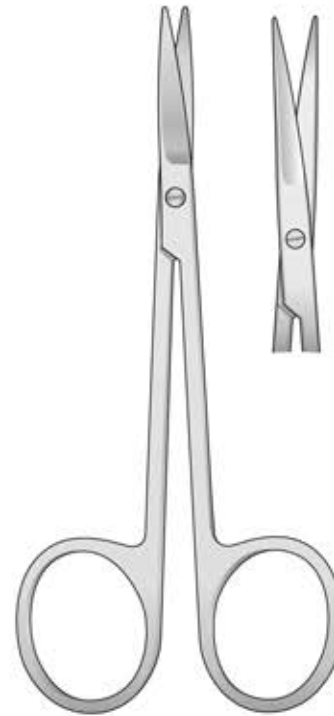

FG-101/FG-102
110 mm

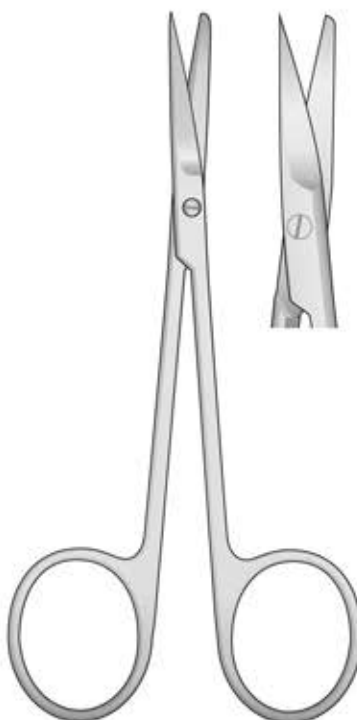
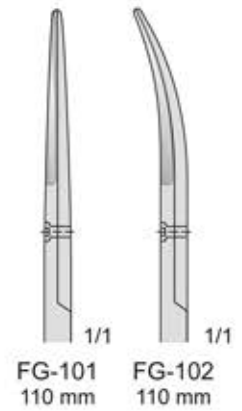

FG-103/FG-105
110 mm

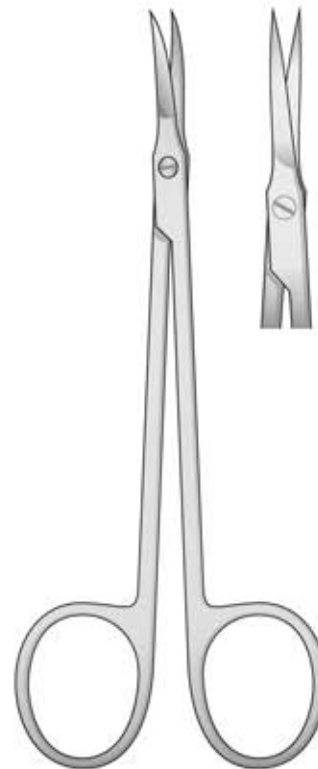
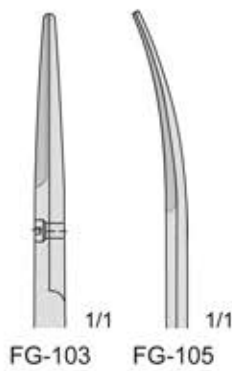

GFR-S/GFC-S
120 mm

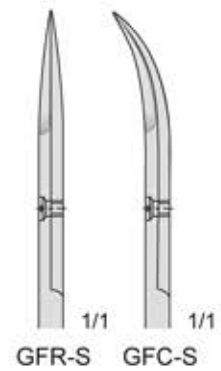

Stumpf
Blunt
Smussa
Romas
Mousse

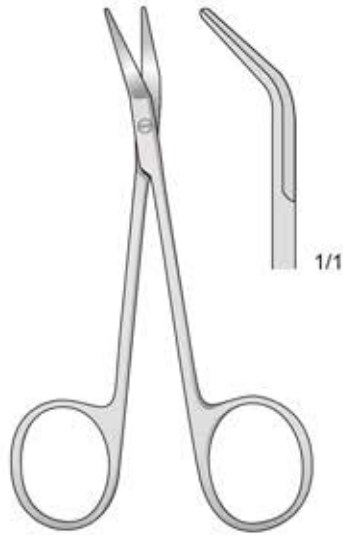

GRAEFE
FG-30
100 mm

Spitz
Sharp
Acuta
Aguda
Pointu

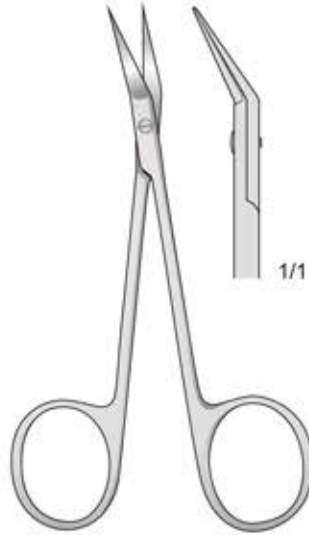

WILMER
FG-122
105 mm

Spitz
Sharp
Acuta
Aguda
Pointu

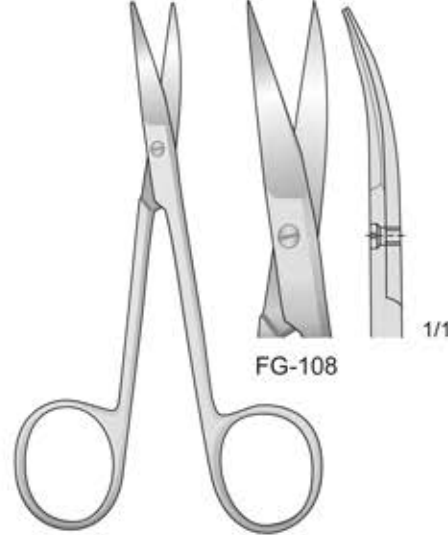

COTTLE-MASING
FG-108/FG-109
105 mm

Stumpf
Blunt
Smussa
Romas
Mousse

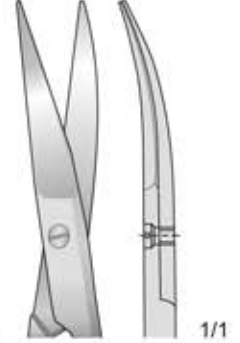

FG-109

Spitz
Sharp
Acuta
Aguda
Pointu

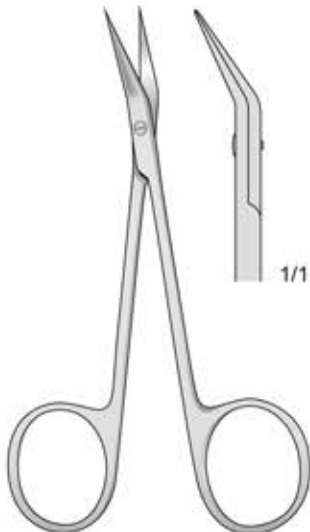

BIRO
FG-94
100 mm



FG-3
115 mm

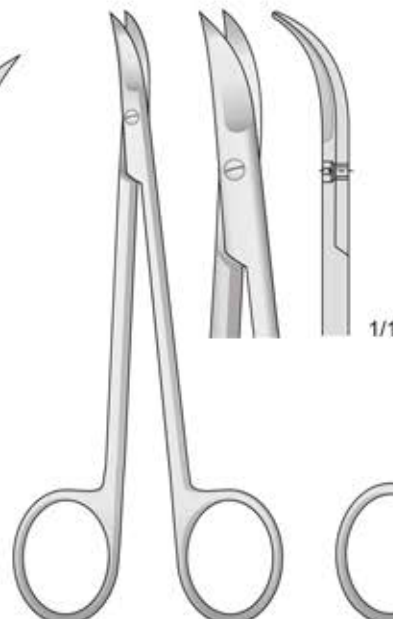

CHADWICK
FG-39
115 mm

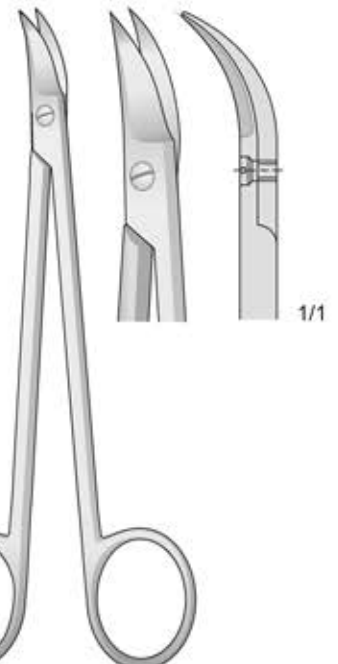

QUINBY
FG-38
130 mm

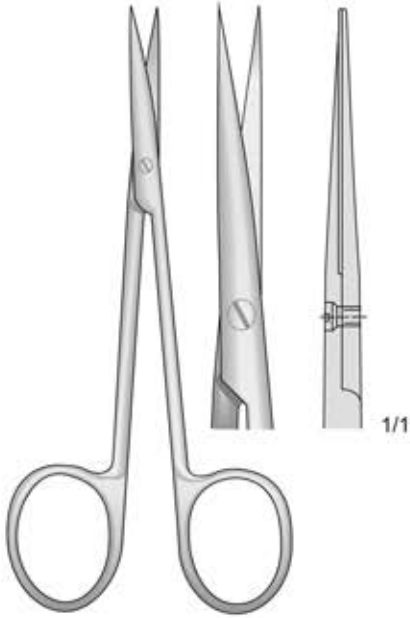

KILNER
FG-58
115 mm

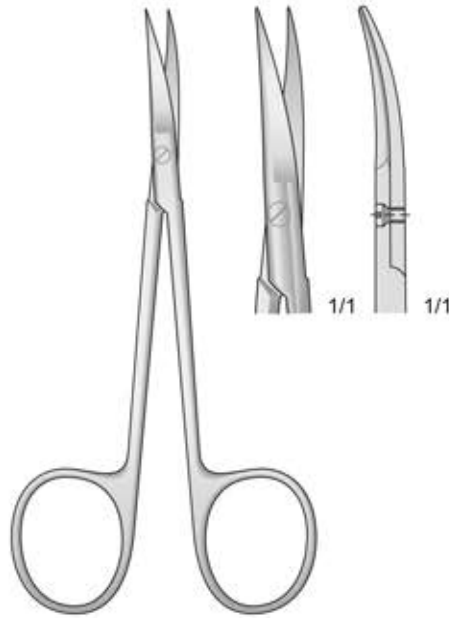

COTTLE
FG-59
115 mm

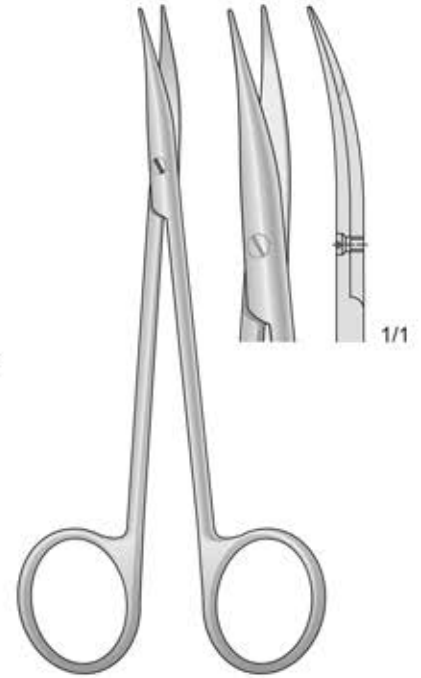

JAMESON-WERBER
FG-123
130 mm

Stumpf - Blunt
Smussa - Romo - Émoussé

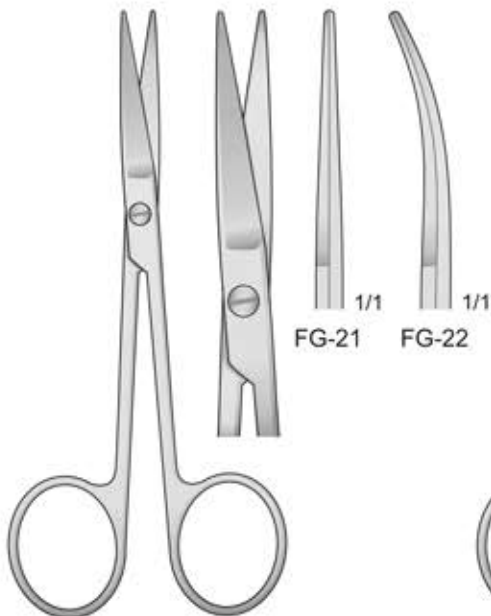

FG-21/FG-22
115 mm

Spitz - Sharp
Acuta - Agudo - Aiguo

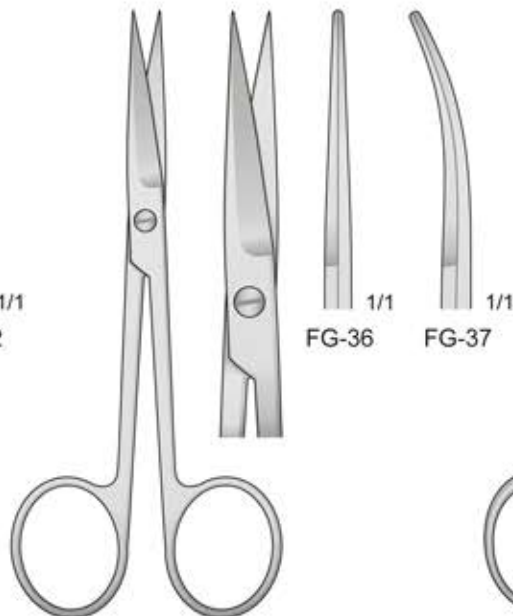

FG-36/FG-37
115 mm

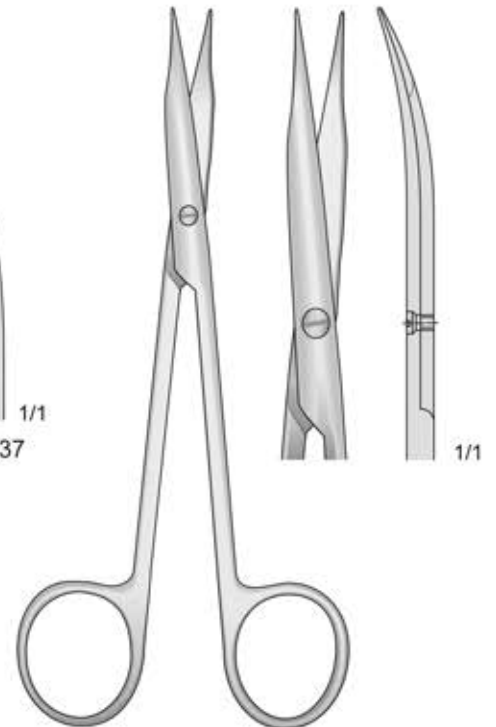

JAMESON
FG-124
145 mm

Gezahnt - Sawedge - Dentellata - Dentadas - Dentelé

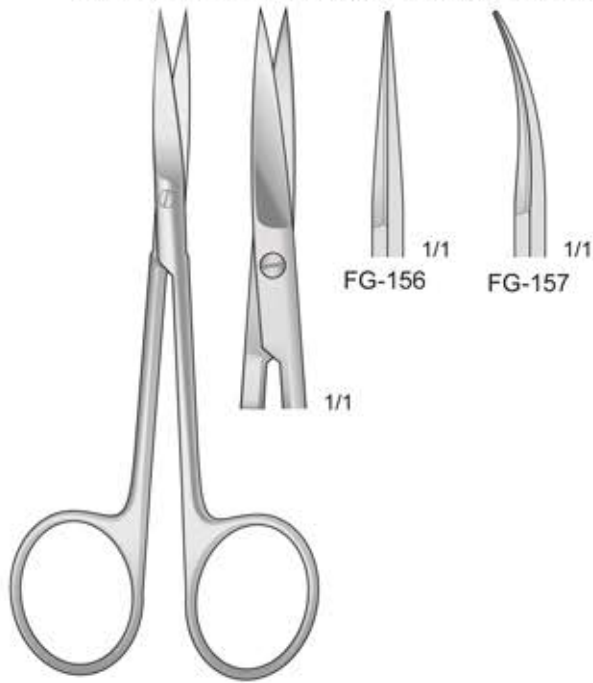

FG-156/FG-157
110 mm

Gezahnt - Sawedge - Dentellata - Dentadas - Dentelé

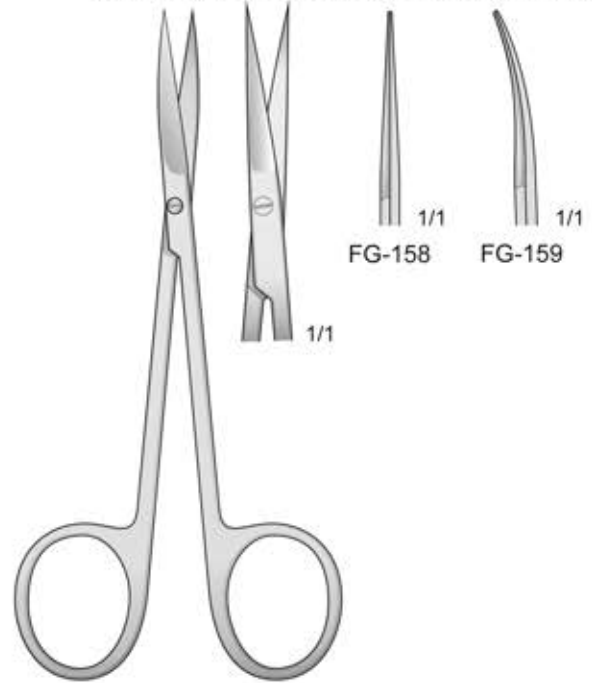

FG-158/FG-159
110 mm

Plastikscheren
Plastic Scissors
Forbici per Plastica

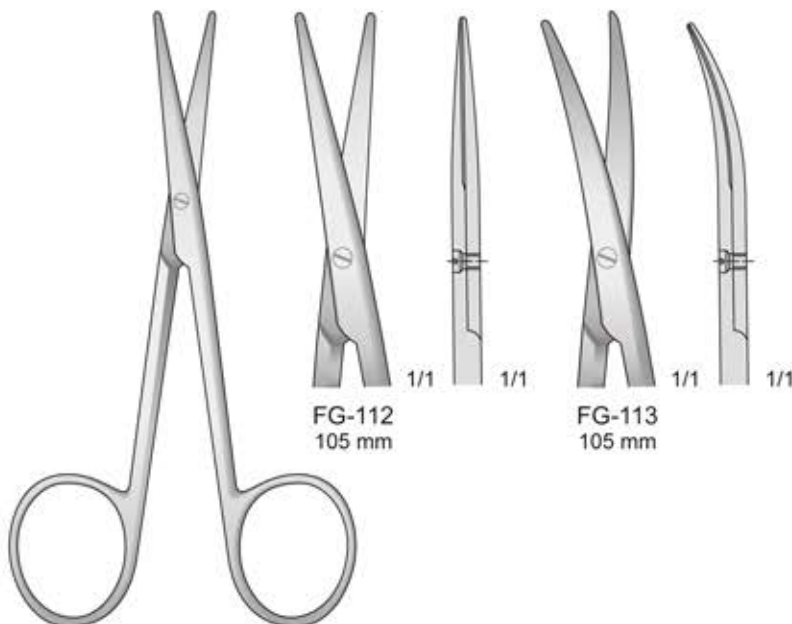

COTTLE-KNAPP
FG-112/FG-113
105 mm
(LEXER-BABY)

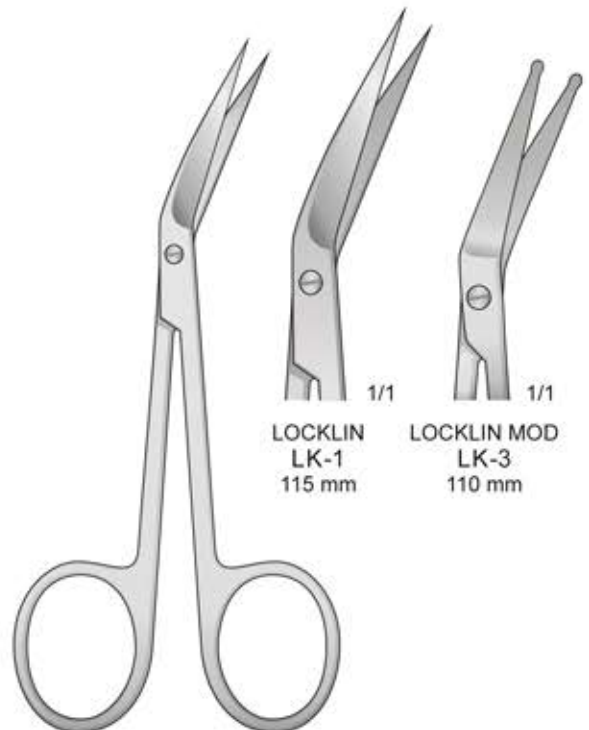

LK-1/LK-3

Feine Scheren

Delicate scissors

Forbici delicate

Tijeras finas

Ciseaux délicate

Gezahnt - Sawedge - Dentellata - Dentadas - Dentelé

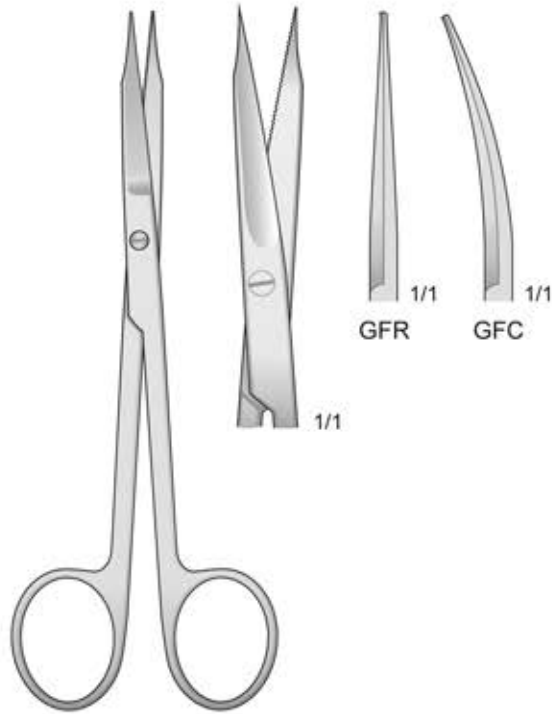

GOLDMAN-FOX
GFR/GFC
120 mm

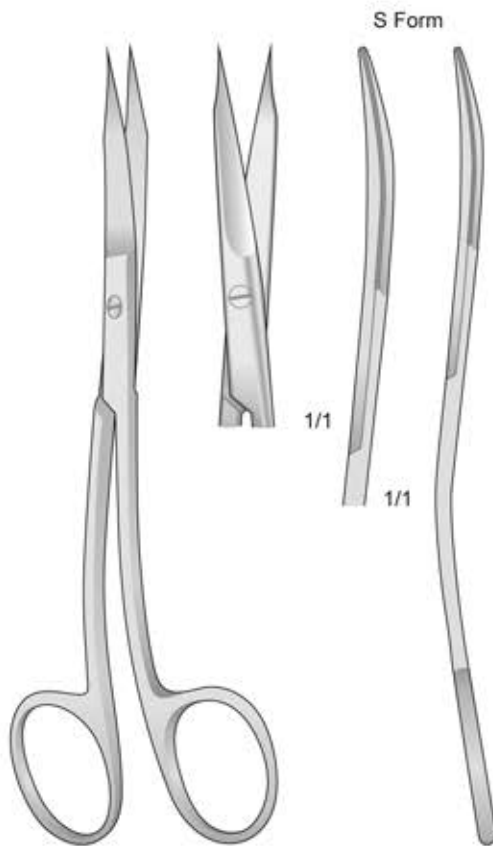

GOLDMAN-FOX
GFS
130 mm

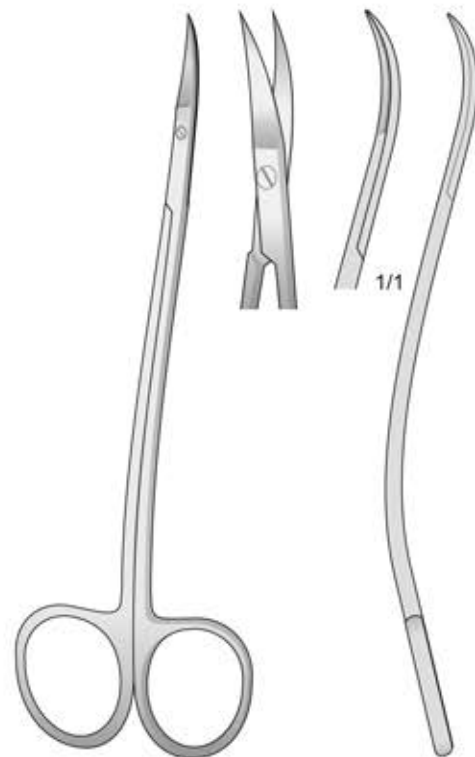

LA GRANGE
LG-1
115 mm

Stumpf - Blunt - Smusse - Romas - Mousses

Spitz - Pointed - Acute - Agudas - Pointus

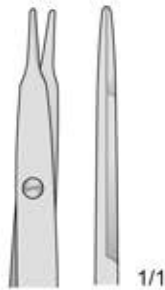
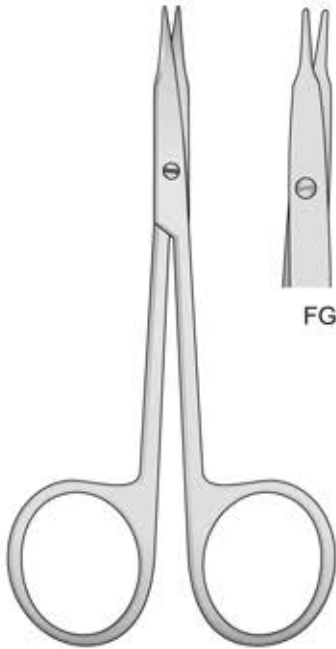

FG-50



FG-51



FG-52



FG-53

STEVENS
FG-50/FG-53
110 mm

Stumpf - Blunt - Smussa
Romas - Mousse

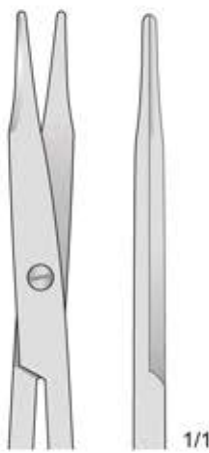
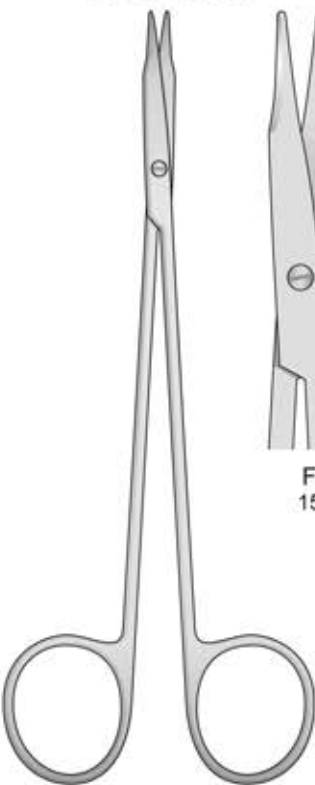

FG-54
150 mm



FG-55
150 mm

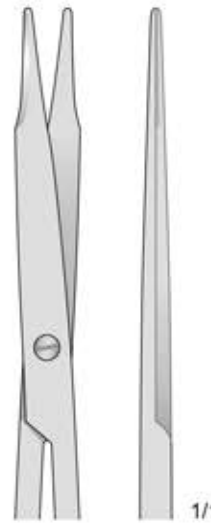

FG-56
180 mm



FG-57
180 mm

REYNOLDS
FG-54/FG-57

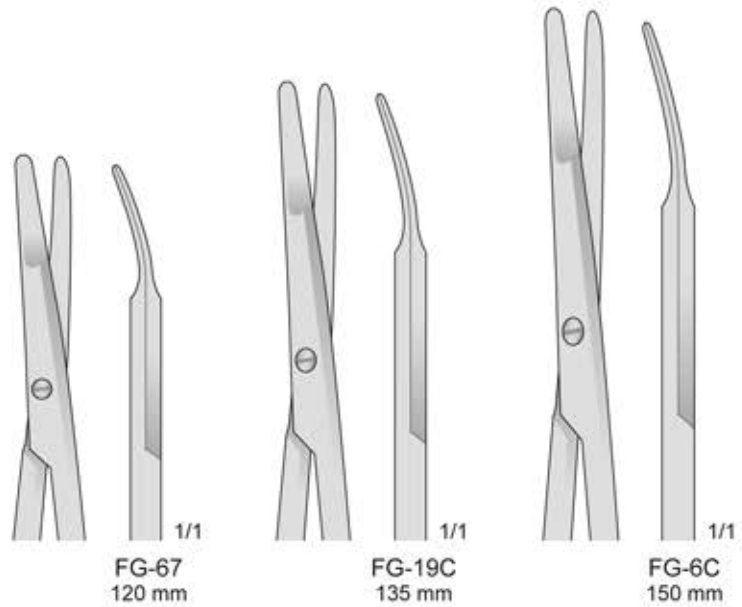
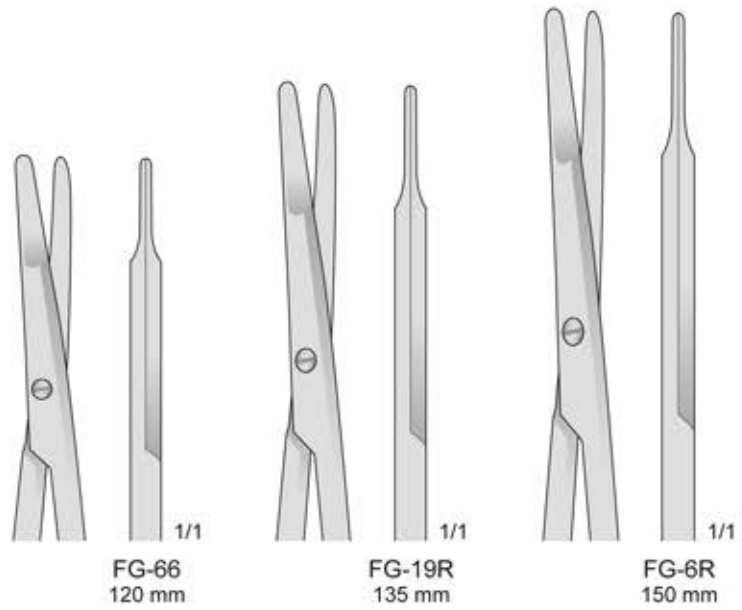
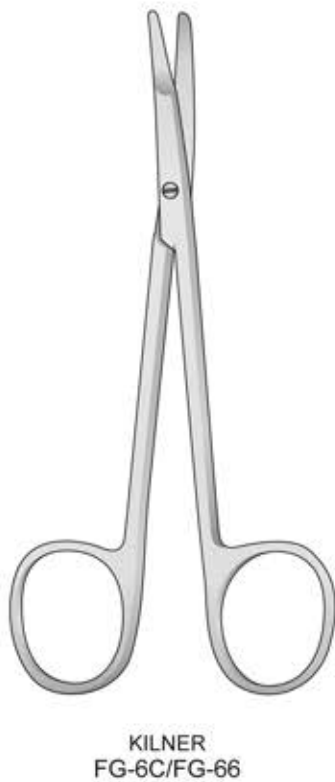
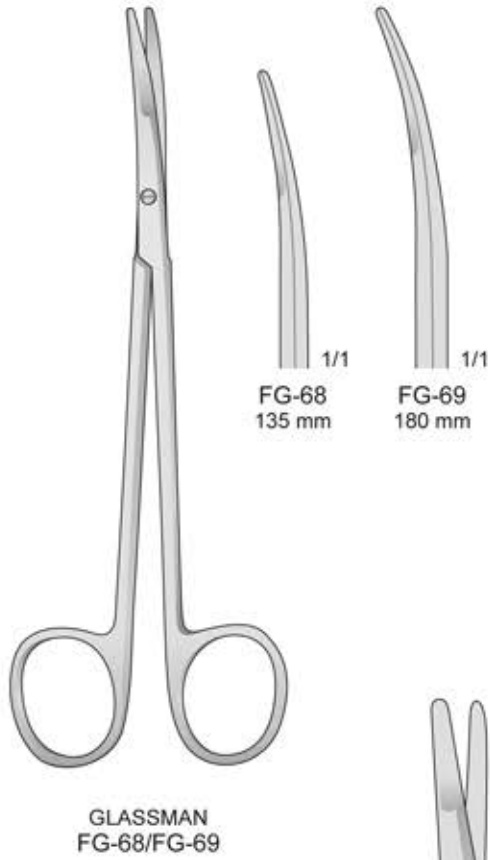

Gezahnt - Saw edge - Dentellate
Dentadas - Dentelés

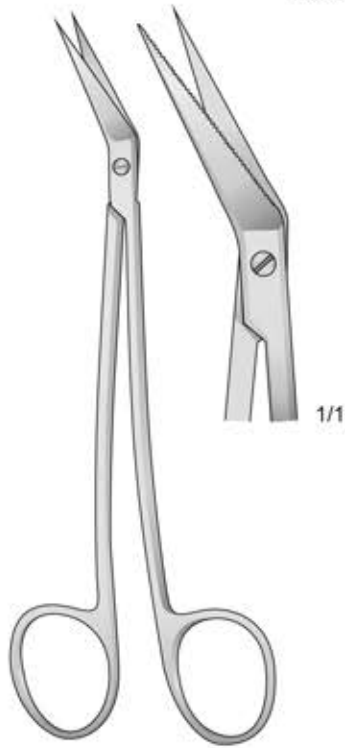

LOCKLIN
LK-2
160 mm

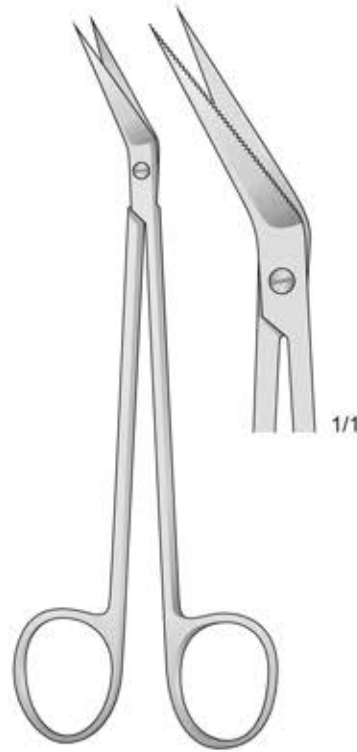

LOCKLIN
LK-4
160 mm

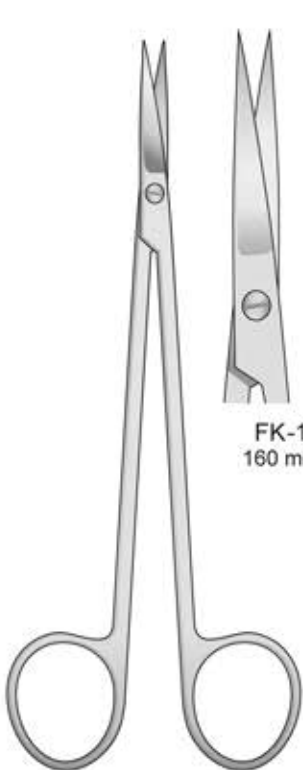

KELLY
FK-1/FK-87

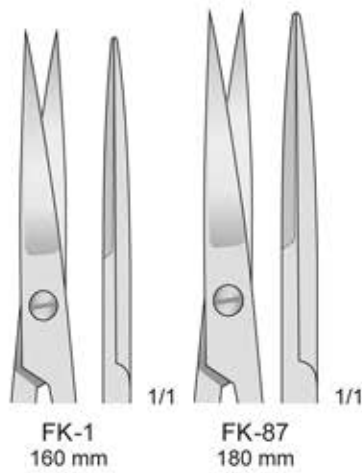

FK-87
180 mm

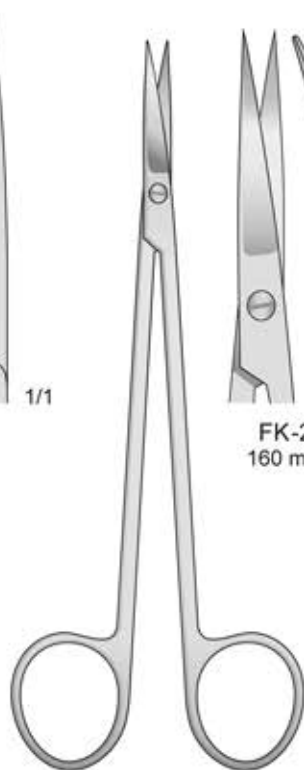

KELLY
FK-2/FK-88

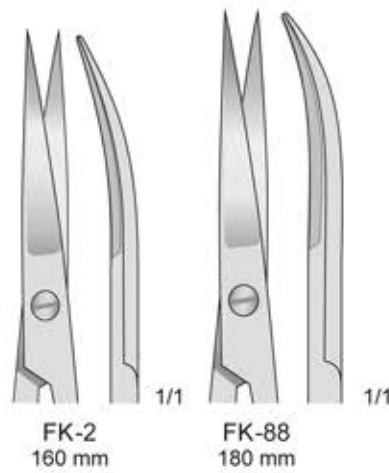

FK-88
180 mm

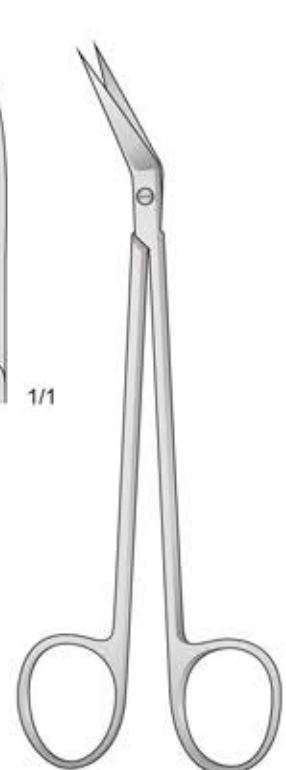

KELLY
FK-10
160 mm

Standard

Stumpf - Blunt
Smusse - Romas
Mousses



1/1



1/1

FM-35
130 mm



1/1

FM-9
145 mm



1/1

FM-37
165 mm



1/1

FM-39
185 mm

FM-9/FM-39

Stumpf - Blunt
Smusse - Romas
Mousses



1/1



1/1

FM-36
130 mm



1/1

FM-10
145 mm



1/1

FM-38
165 mm



1/1

FM-40
185 mm

FM-10/FM-40

Standard



1/1



1/1

FM-49
115 mm



1/1

FM-27
130 mm



1/1

FM-29
145 mm



1/1

FM-31
165 mm



1/1

FM-33
185 mm



1/1

FM-62
200 mm

FM-27/FM-62



1/1



1/1

FM-63
115 mm



1/1

FM-28
130 mm



1/1

FM-30
145 mm



1/1

FM-32
165 mm



1/1

FM-34
185 mm

FM-28/FM-63

Standard

Spitz - Sharp
Acuta - Agudo - Pointu



1/1



1/1

FM-41
130 mm



1/1

FM-7
145 mm



1/1

FM-43
165 mm

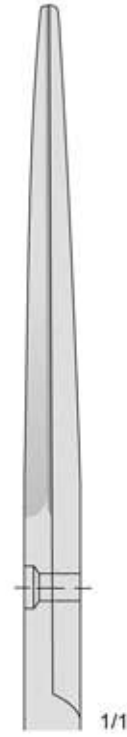

1/1

FM-45
185 mm



1/1

FM-72
200 mm

FM-7/FM-72

Spitz - Sharp
Acuta - Agudo - Pointu



1/1



1/1

FM-42
130 mm



1/1

FM-8
145 mm



1/1

FM-44
165 mm

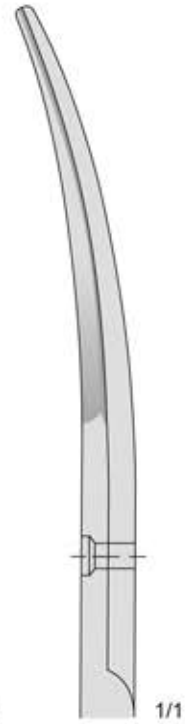

1/1

FM-46
185 mm

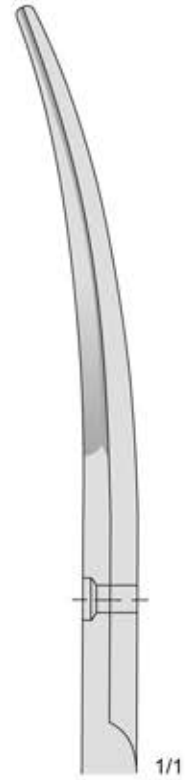

1/1

FM-73
200 mm

FM-8/FM-73

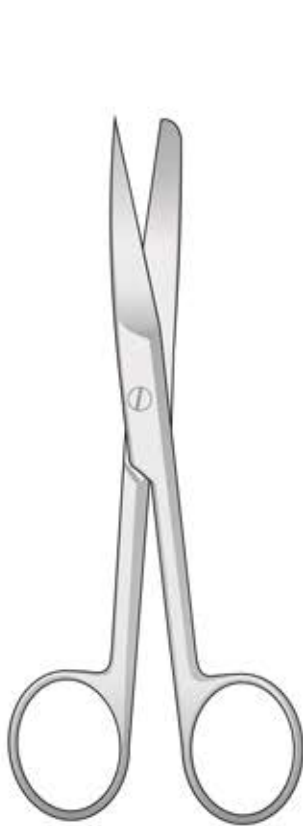

DEAVER
FG-47/FG-49
145 mm

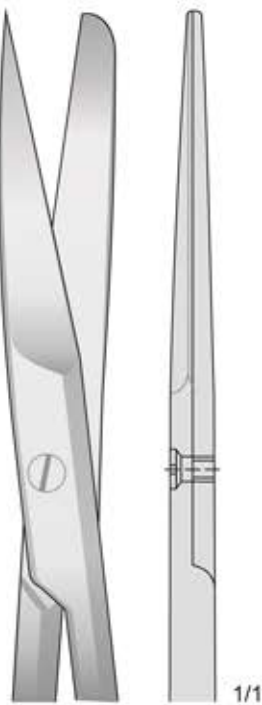

FG-47
145 mm



FG-48
145 mm

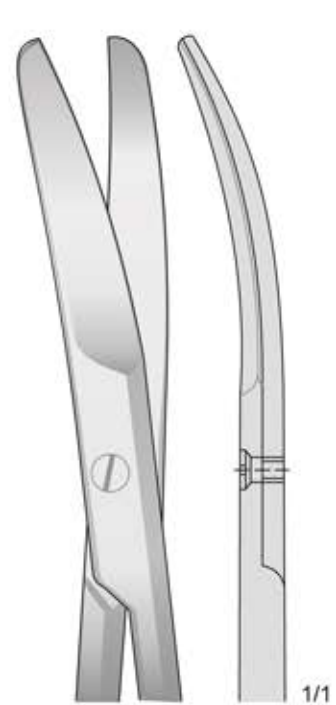

FG-49
145 mm

Inzisionscheren - Incision scissors
Forbici da incisione - Tijeras para incisión
Ciseaux à incision

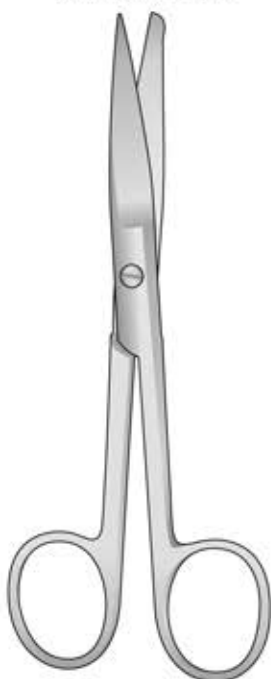

FG-16/FG-117



FG-16
130 mm



FG-17
145 mm

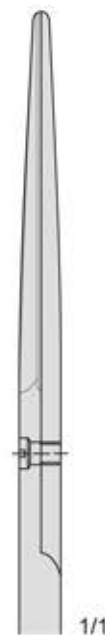

FG-117
165 mm

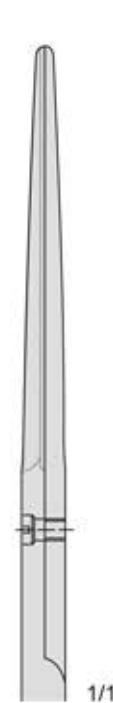

FG-18
185 mm

Chirurgische Scheren

Operating Scissors

Forbici chirurgiche

Tijeras para cirugía

Ciseaux chirurgicaux

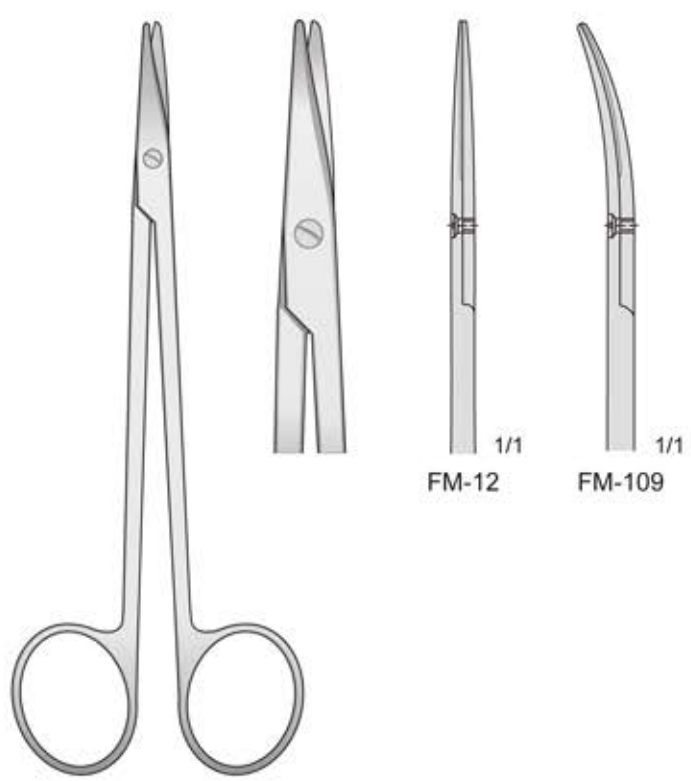

METZENBAUM
FM-12/FM-109
150 mm

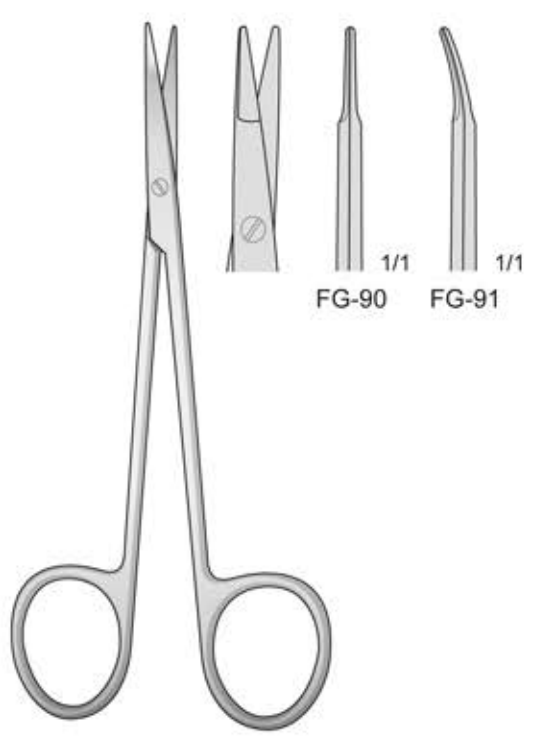

SHEA
FG-90/FG-91
120 mm

Spitz - Sharp
Acuta - Agudo - Pointu

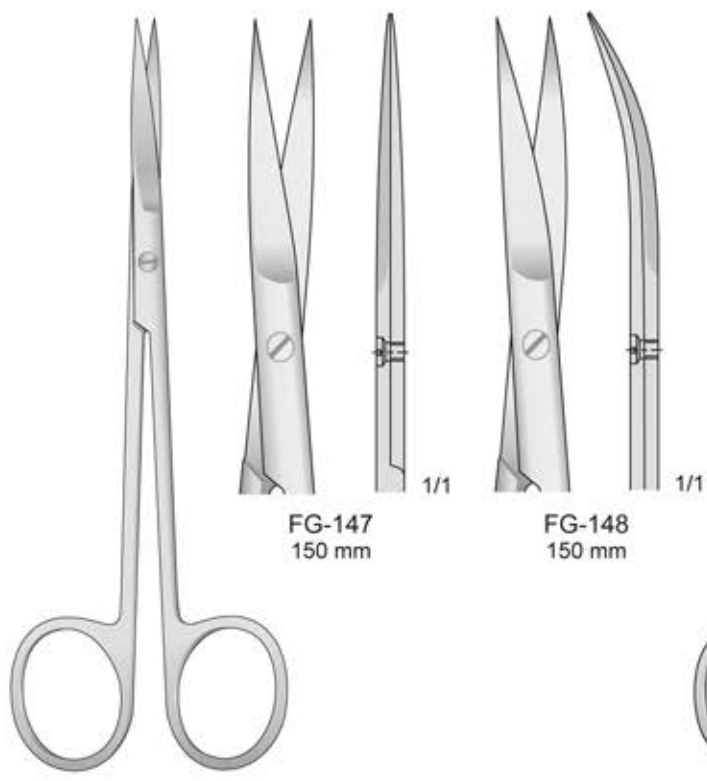

JOSEPH
FG-147/FG-148
150 mm



METZENBAUM
FM-126/FM-127
145 mm

Feine Scheren

Delicate scissors

Forbici delicate

Tijeras finas

Ciseaux délicate

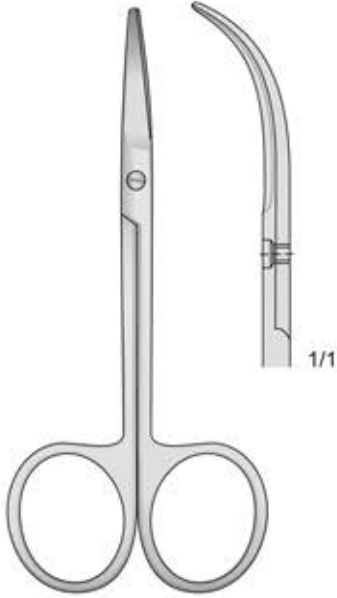

FOMON
FG-43
110 mm

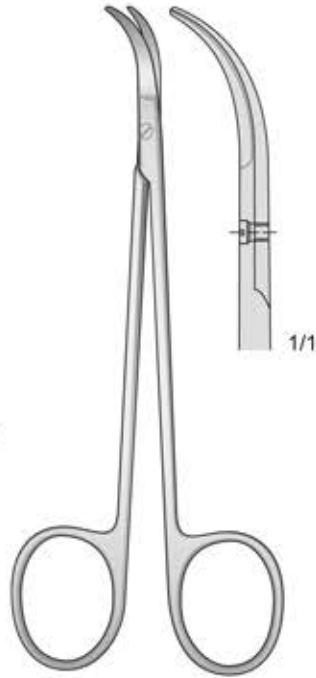

FOMON
FG-93
135 mm

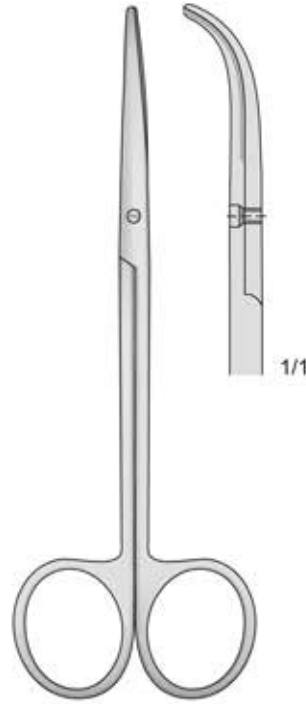

FOMON
FG-44
140 mm

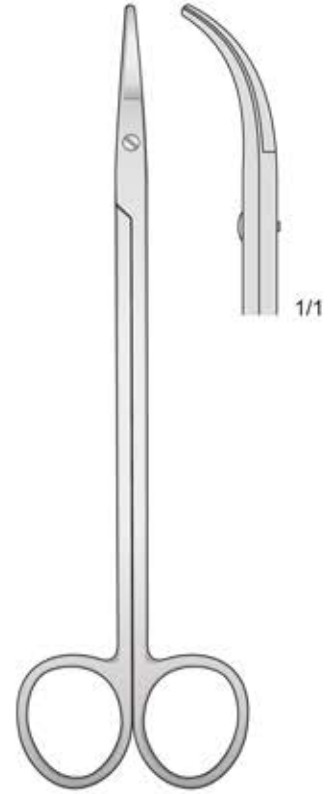

WALTON
FG-146
165 mm

Mit Fadenbohrung - With eye for suture
Con occhiello per sutura - Tijeras para ligaduras
Avec oeil pour les sutures

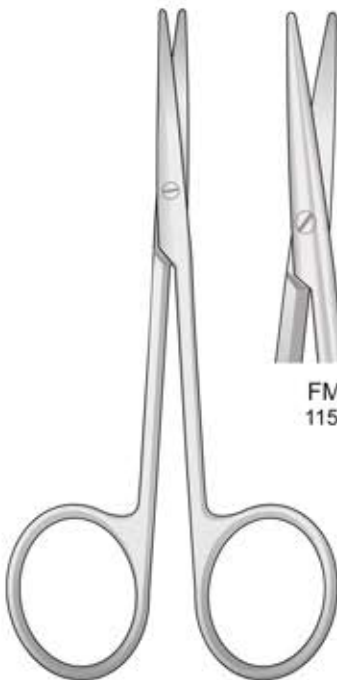

BABY - METZENBAUM
FM-47/FM-48
115 mm

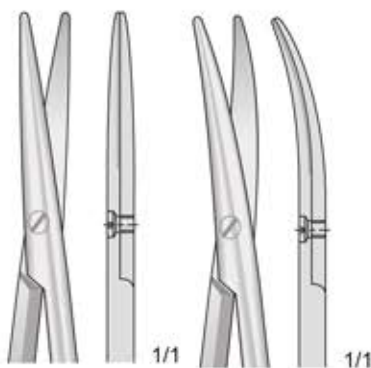

FM-47
115 mm

FM-48
115 mm

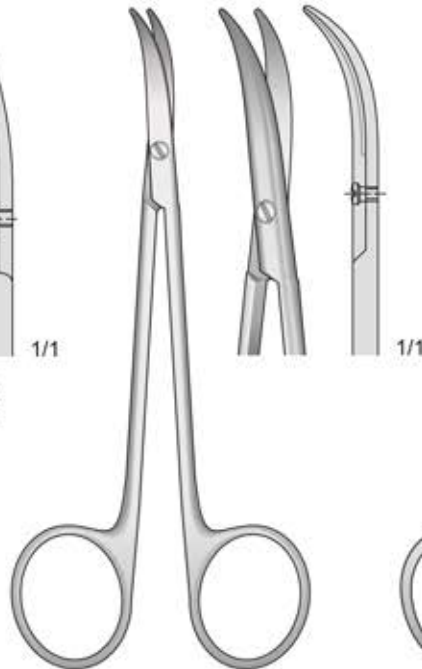

CINELLI
FG-95
115 mm

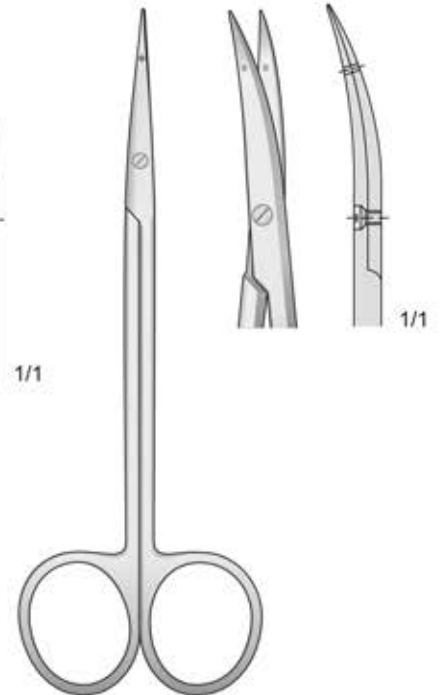

LITTLER
FG-100
120 mm

Präparierscheren - Dissecting Scissors
Forbici per dissezione - Tijeras para preparaciones - Ciseaux à dissection

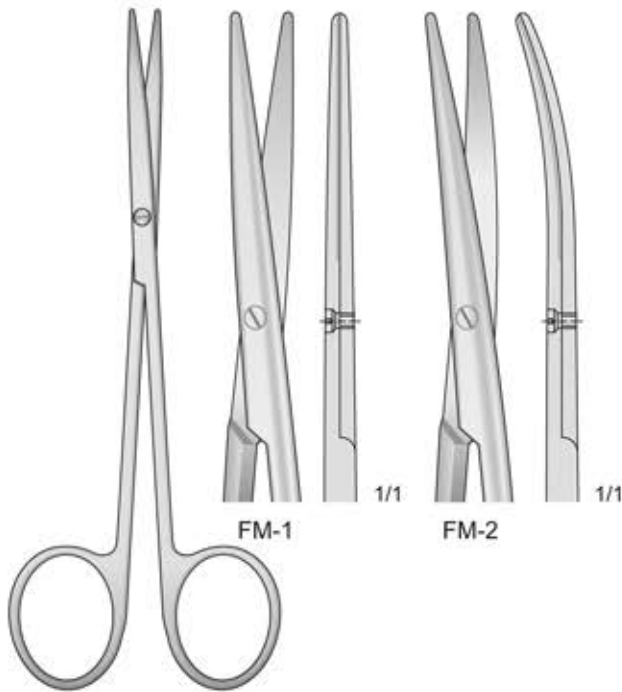

METZENBAUM
FM-1/FM-2
145 mm

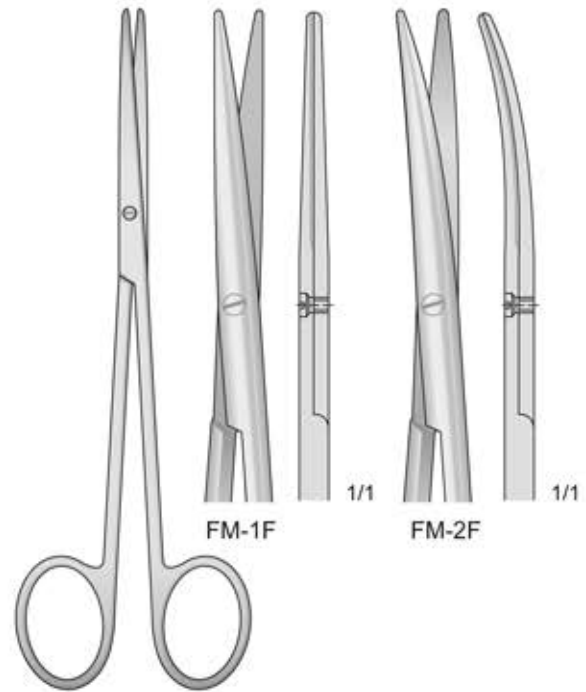

METZENBAUM-FINO
FM-1F/FM-2F
145 mm

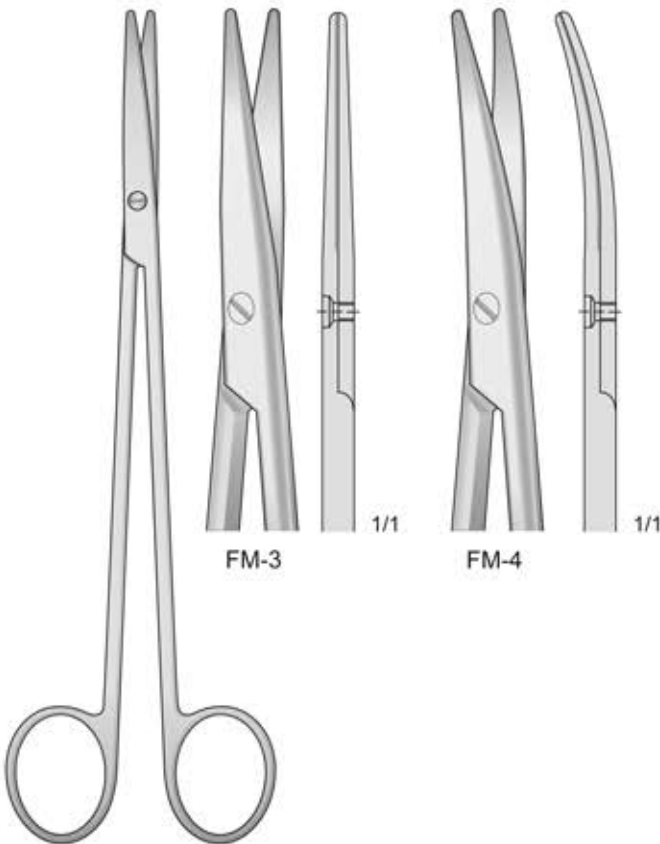

METZENBAUM
FM-3/FM-4
185 mm

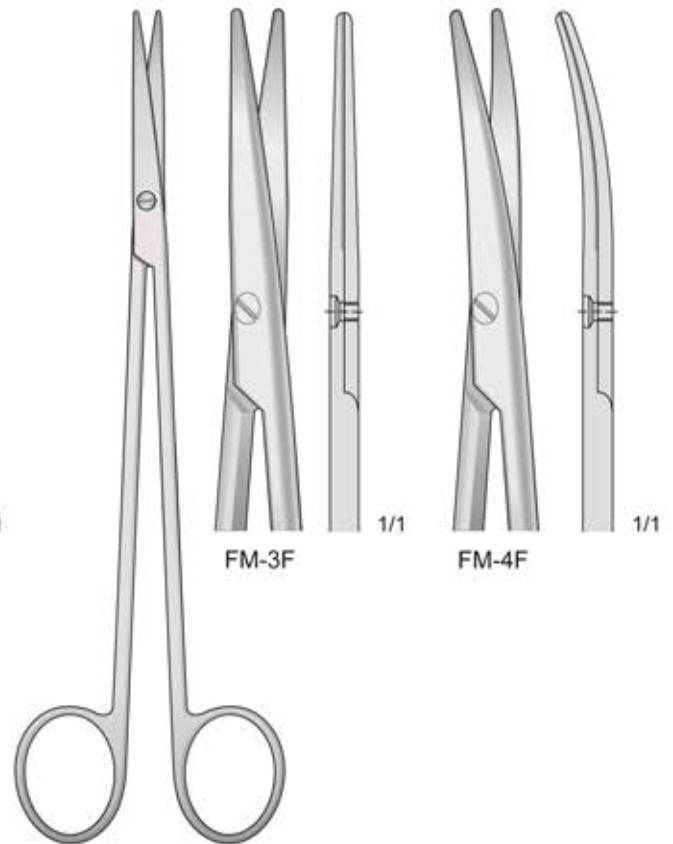

METZENBAUM-FINO
FM-3F/FM-4F
185 mm

Präparierscheren - Dissecting Scissors
Forbici per dissezione - Tijeras para preparaciones - Ciseaux à dissection

Spitz - Sharp
Acuta - Agudo - Pointu

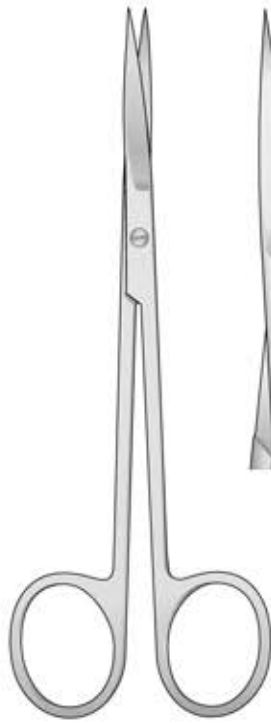

METZENBAUM
FG-14/FG-28
145 mm

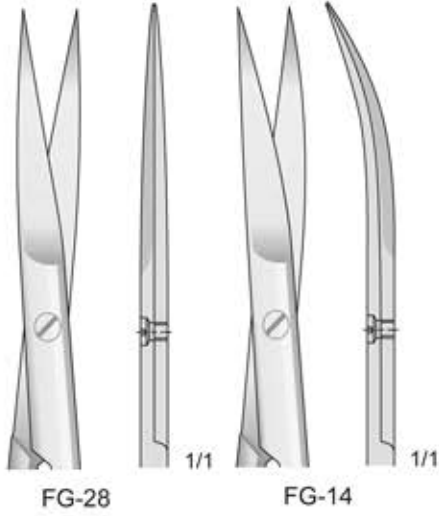

METZENBAUM
FM-74/FM-75
160 mm

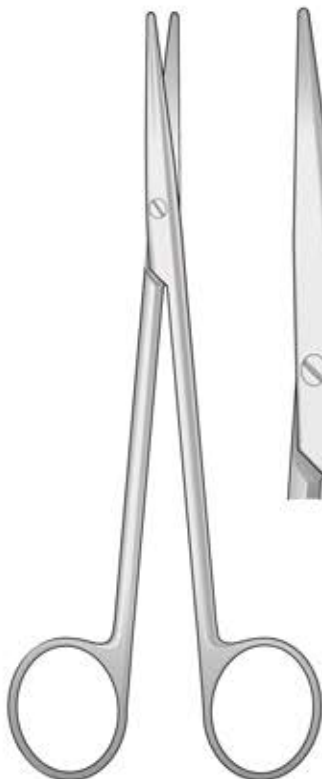
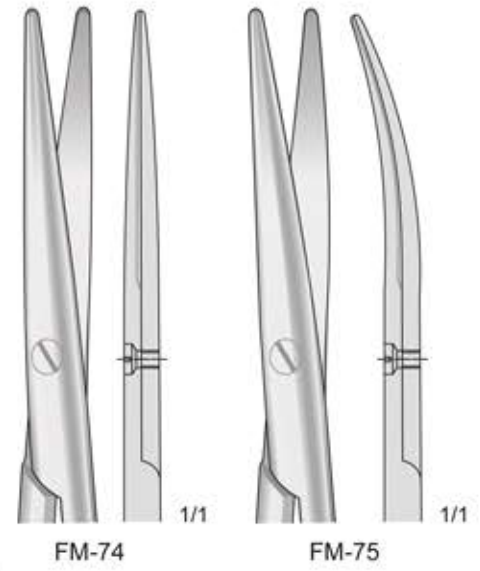

METZENBAUM
FM-70/FM-71
200 mm

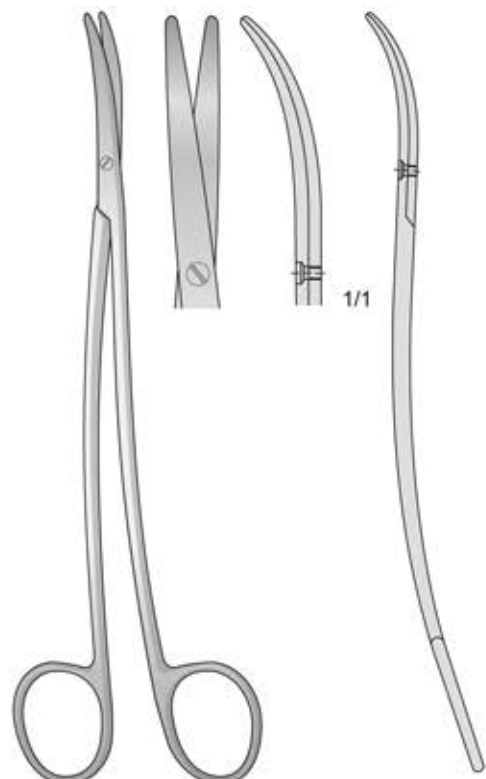
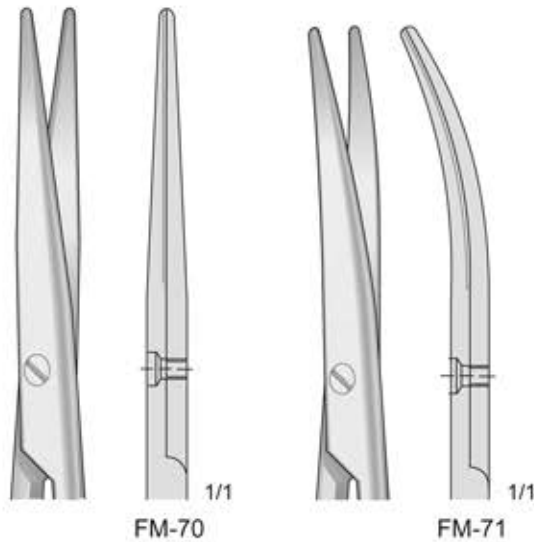

METZENBAUM-FINO
FM-120 - 180 mm
FM-121 - 200 mm
FM-122 - 230 mm



Chirurgische Scheren

Operating Scissors

Forbici chirurgiche

Tijeras para cirugía

Ciseaux chirurgicaux

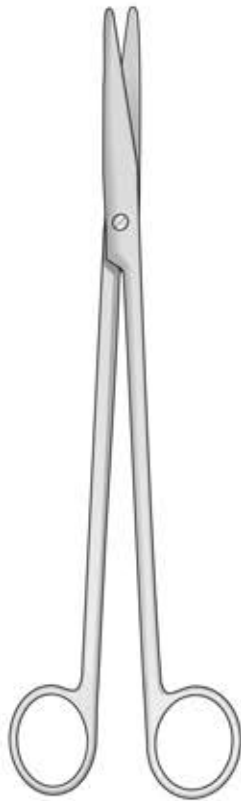

NELSON-METZENBAUM
FM-11/FM-114



FM-11
230 mm



FM-112
250 mm



FM-113
280 mm



FM-114
305 mm

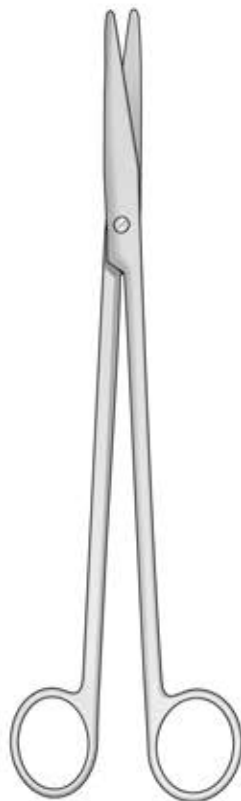

NELSON-METZENBAUM
FM-13/FM-117



FM-13
230 mm



FM-115
250 mm



FM-116
280 mm



FM-117
305 mm

Fein - Delicate - Fine - Finas - Fins



TOENNIS-ADSON
FG-60/FG-61
180 mm

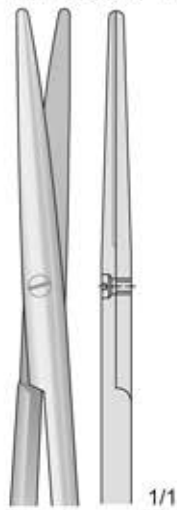

FG-60
180 mm

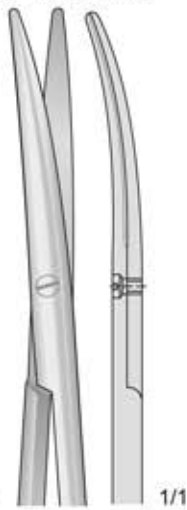

FG-61
180 mm

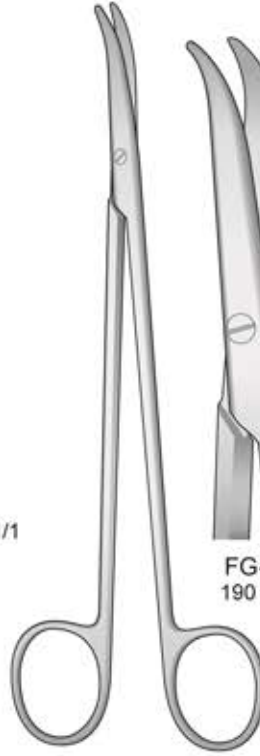

THOREK
FG-45/FG-65

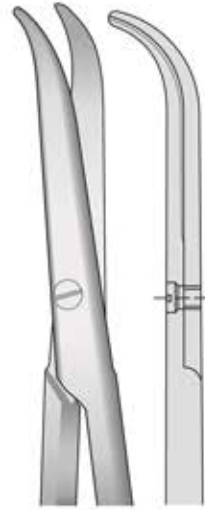

FG-45
190 mm

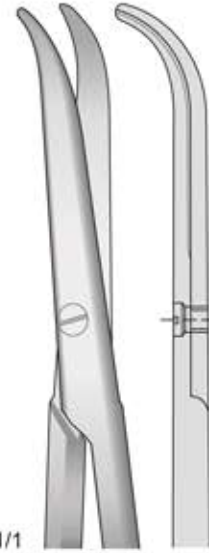

FG-46
230 mm

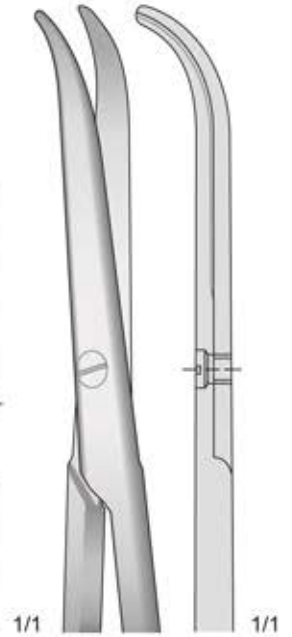

FG-65
250 mm

Fein - Delicate - Fine - Finas - Fins

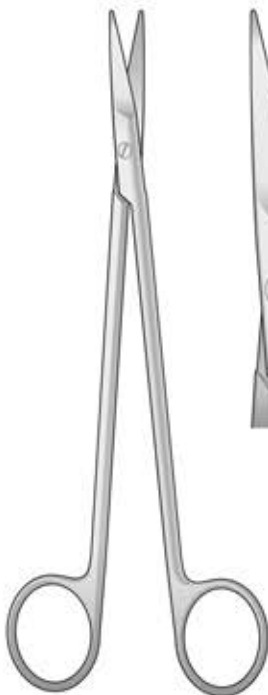

TOENNIS
FG-73/FG-75
180 mm

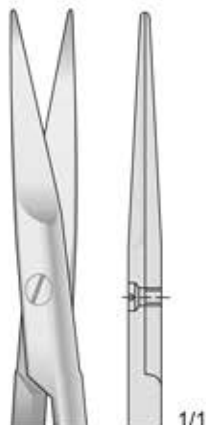

FG-73
180 mm

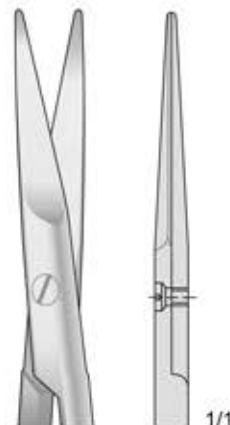

FG-74
180 mm

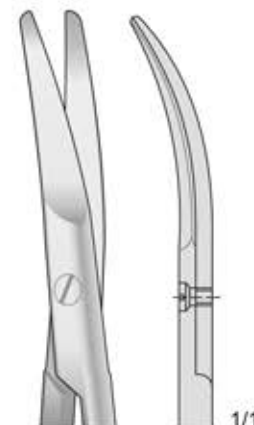

FG-75
180 mm

Präparierscheren - Dissecting scissors - Forbici per dissezione - Tijeras para preparaciones - Ciseaux à dissection

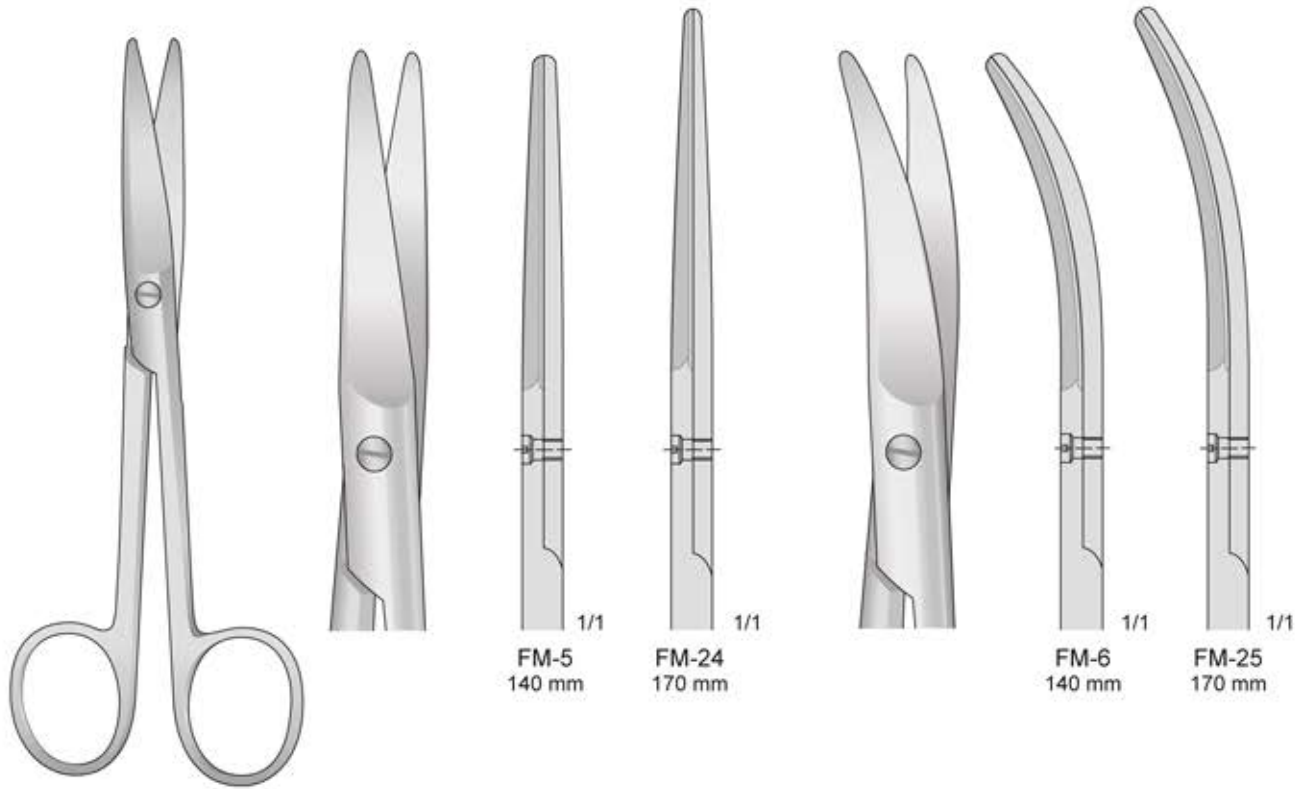

MAYO
FM-5/FM-25

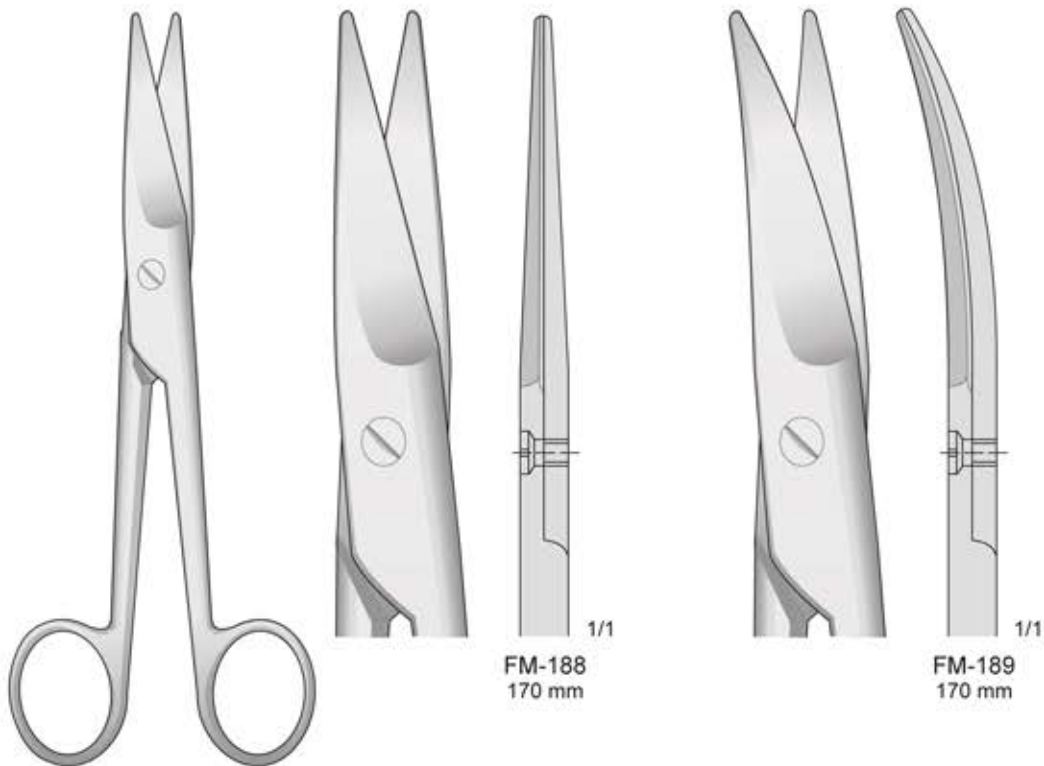

MAYO-NOBLE
FM-188/FM-189

Präparierscheren - Dissecting scissors - Forbici per dissezione - Tijeras para preparaciones - Ciseaux à dissection

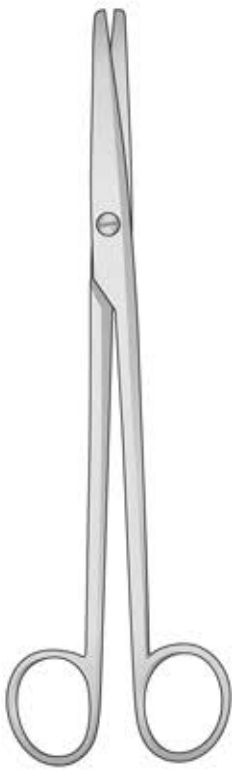

MAYO
FM-80/FM-82

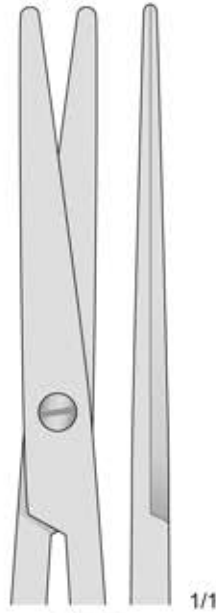

FM-80
160 mm

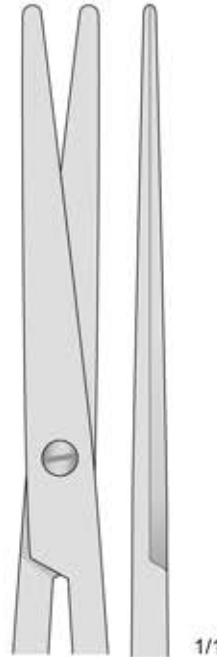

FM-81
190 mm

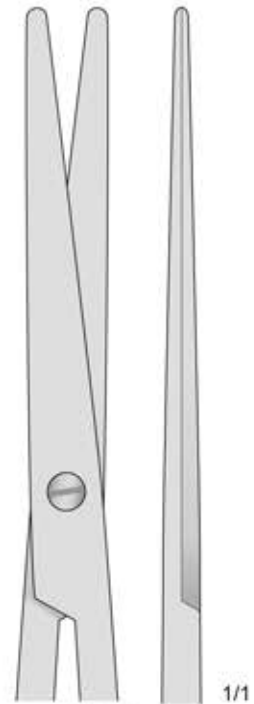

FM-82
210 mm

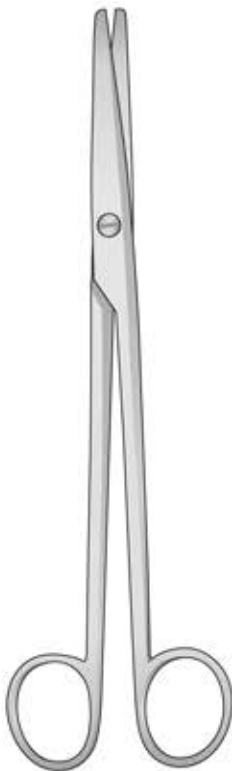

MAYO
FM-83/FM-85

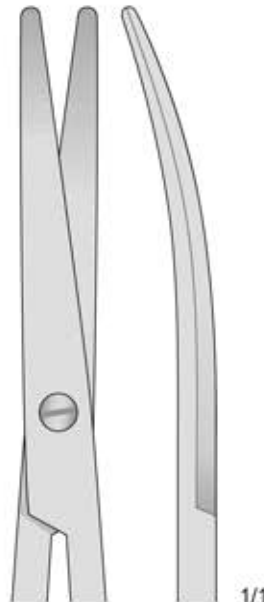

FM-83
160 mm

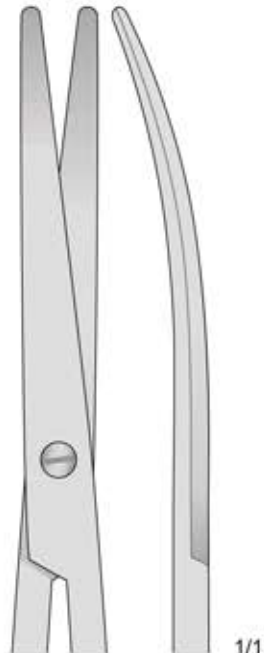

FM-84
190 mm

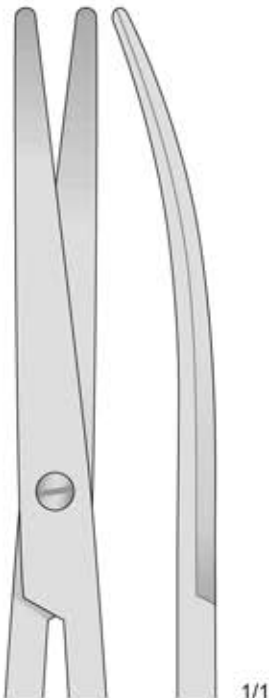

FM-85
210 mm

Fein - Delicate - Fine - Finas - Fins



LEXER
FM-180/FM-181
165 mm



FM-180

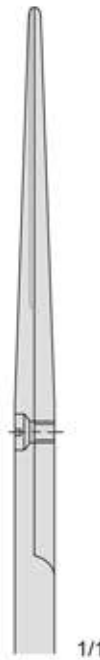

1/1



FM-181

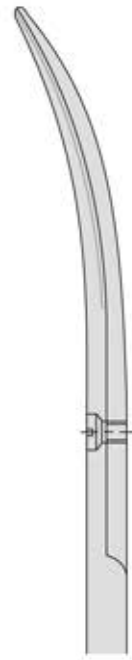

1/1

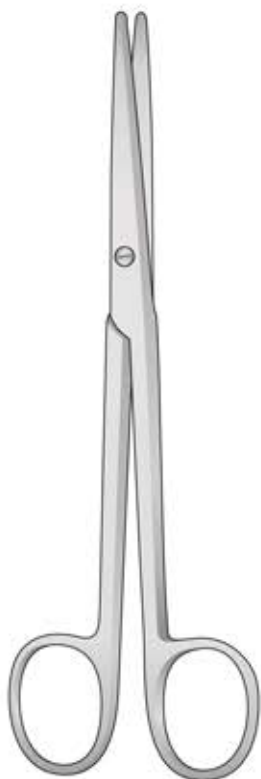

LEXER
FM-86/FM-89



FM-86
160 mm

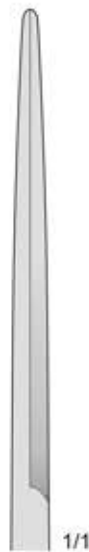

1/1



FM-87
210 mm

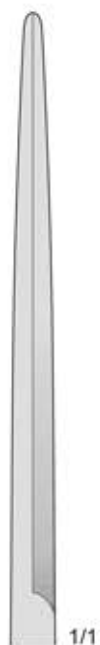

1/1



FM-88
160 mm



1/1



FM-89
210 mm



1/1

Präparierscheren - Dissecting Scissors - Forbici per dissezione - Tijeras para preparaciones - Ciseaux à dissection



FM-110
150 mm



1/1



FM-111
150 mm

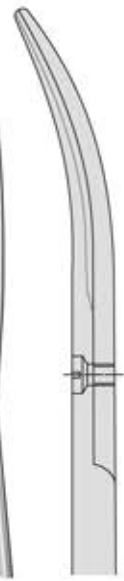

1/1

STILLE
FM-110/FM-111
150 mm

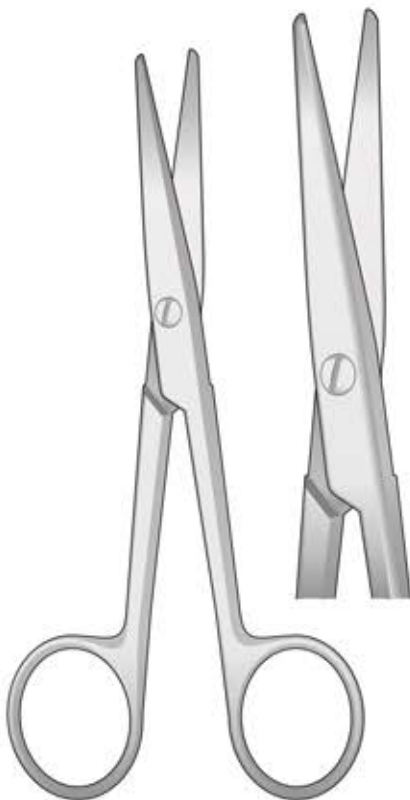

1/1

FM-76
140 mm



1/1

FM-77
170 mm



FM-78
140 mm

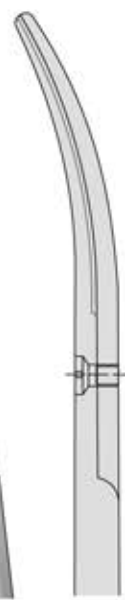

1/1



1/1

FM-79
170 mm

MAYO-STILLE
FM-76/FM-79

Präparierscheren - Bilateral Dissecting Scissors
 Forbici per dissezione a taglio bilaterale - Tijeras para preparaciones - Ciseaux à dissection

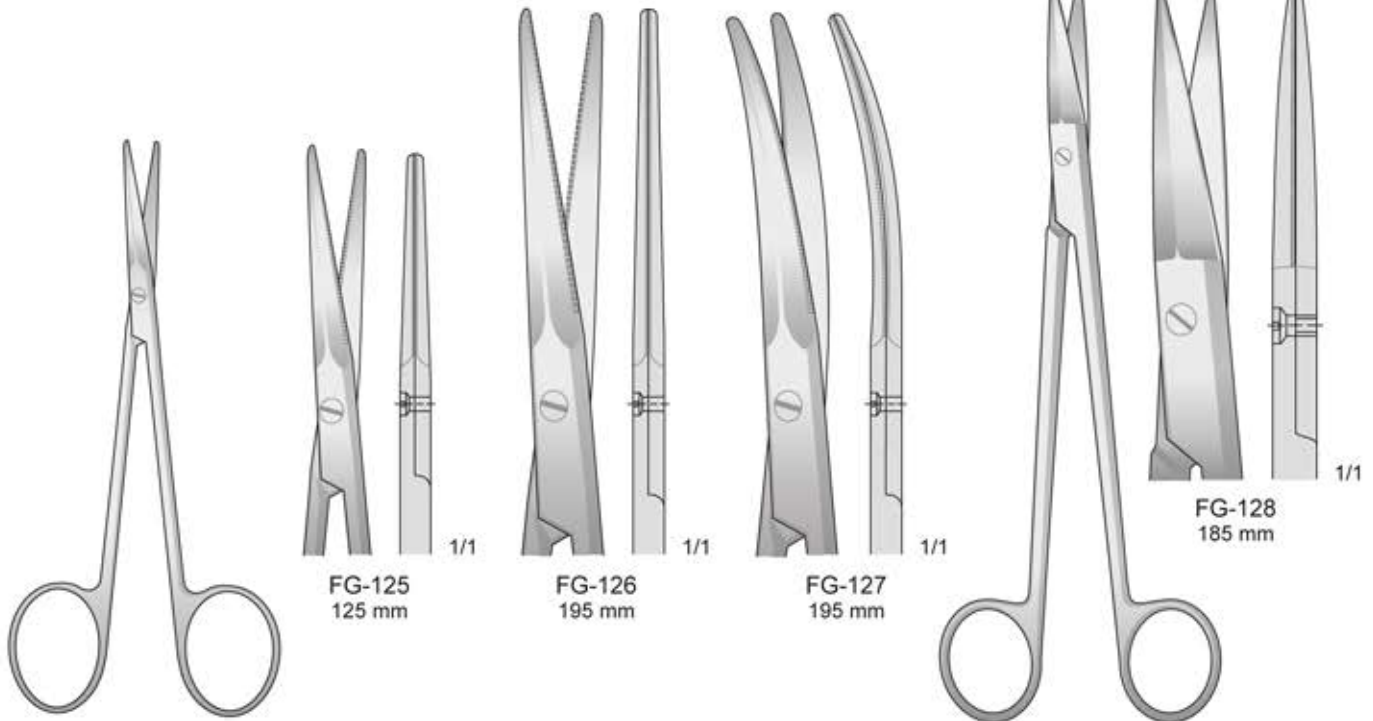

GORNEY
FG-125/FG-127

FG-128
185 mm

Präparierscheren - Bilateral Dissecting Scissors
 Forbici per dissezione a taglio bilaterale - Tijeras para preparaciones - Ciseaux à dissection

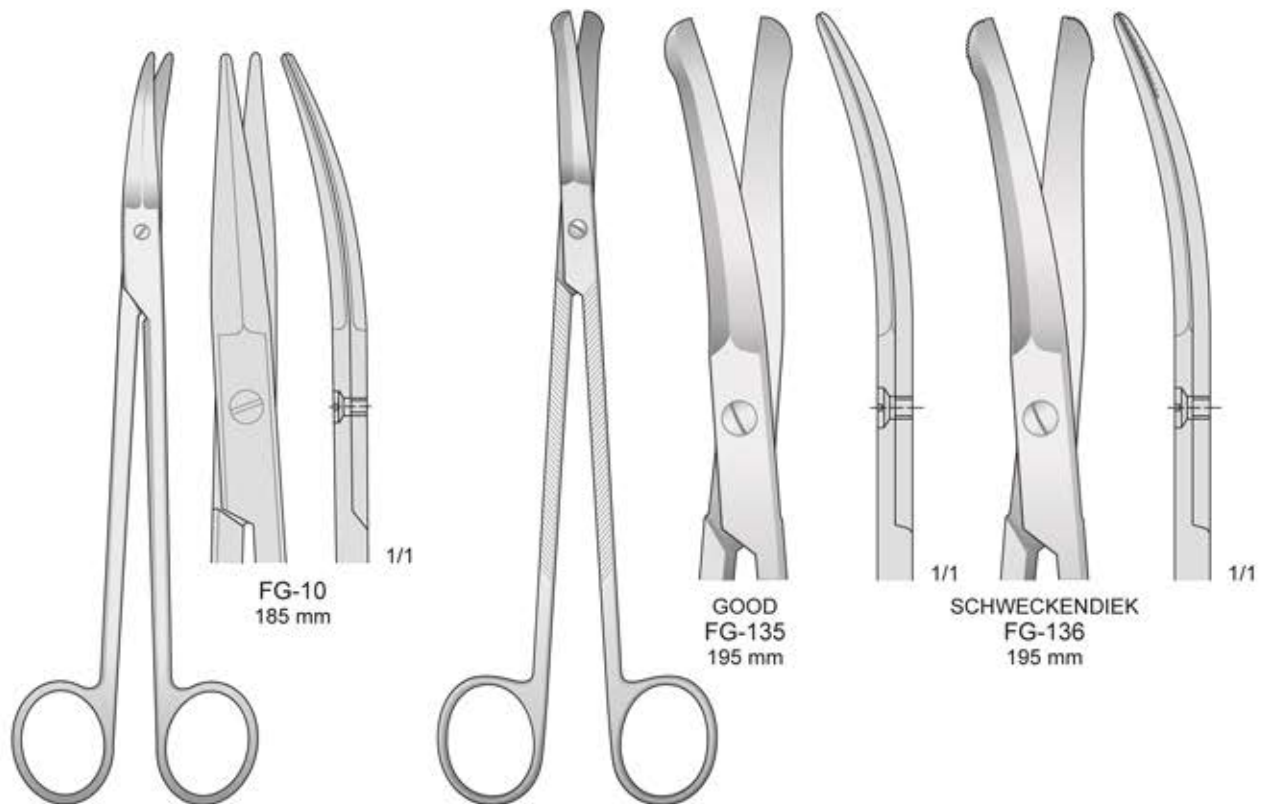

FG-10
185 mm

FG-135/FG-136
195 mm

Mit einer Schneide gezahnt - With one blade serrated
 Con una lama dentellata - Con una hoja dentada
 Avec une lame dentée

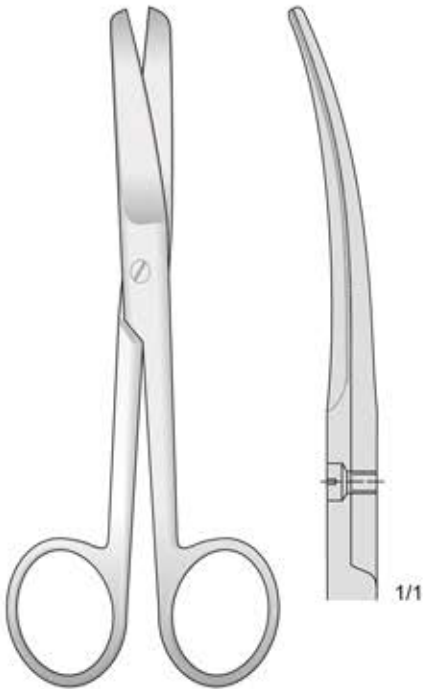

FG-116
165 mm

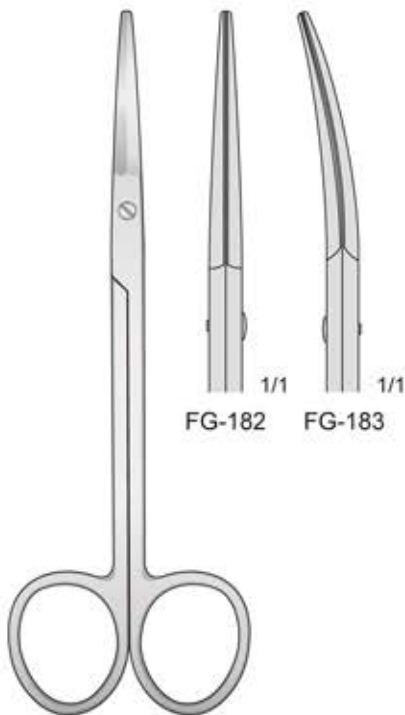

KAHN
FG-182/FG-183
145 mm

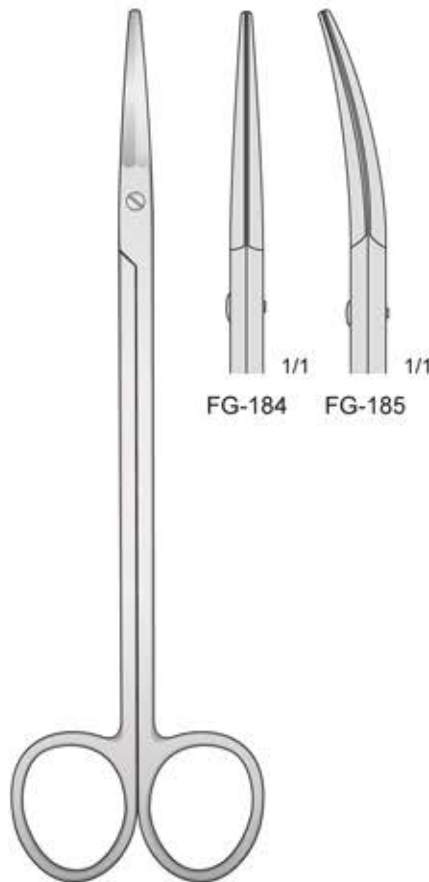

KAHN
FG-184/FG-185
180 mm

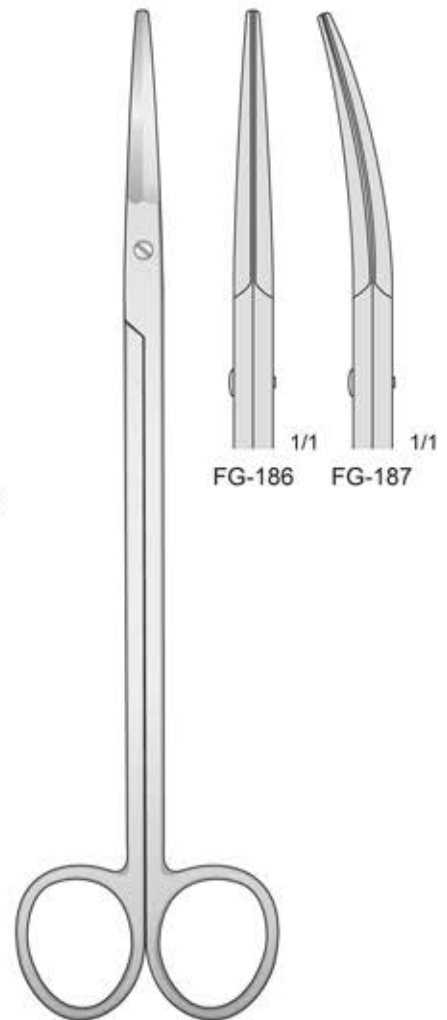

KAHN
FG-186/FG-187
205 mm

Gezahnt - Serrated - Dentellata - Dentadas - Dentelé

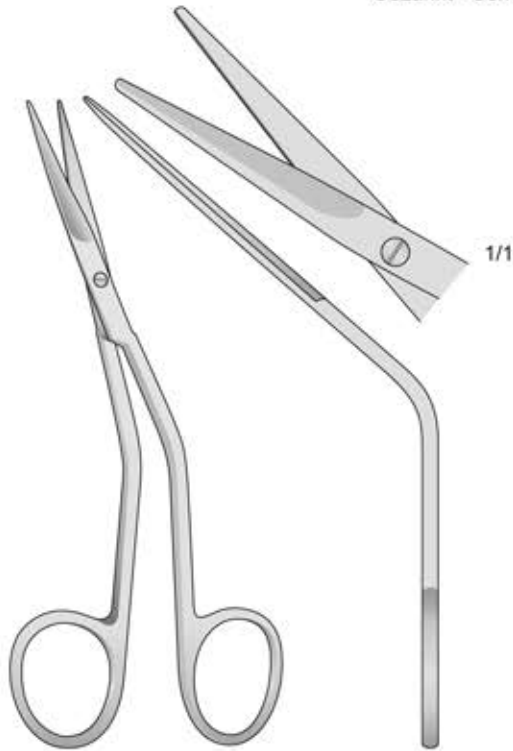

FOMON
FG-41
135 mm

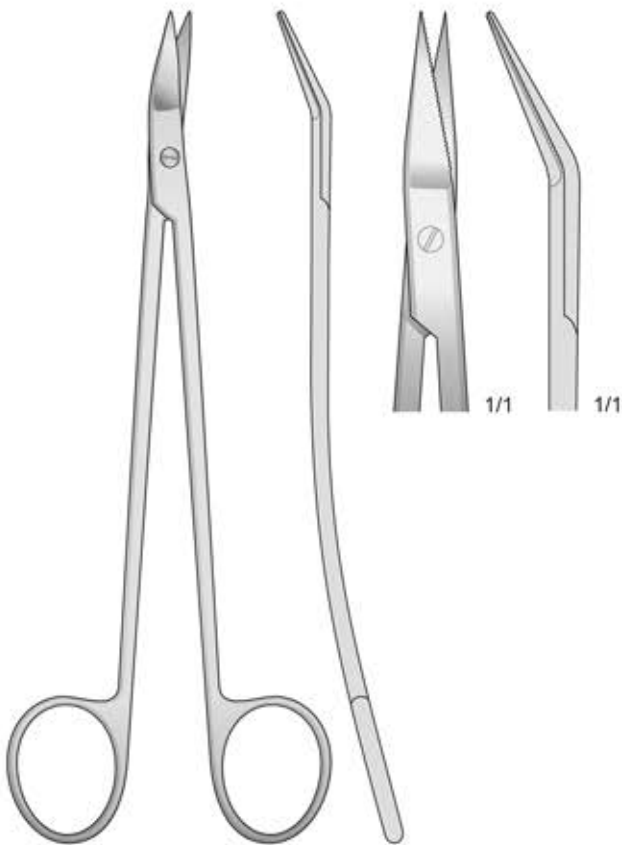

DEAN
DEAN
180 mm

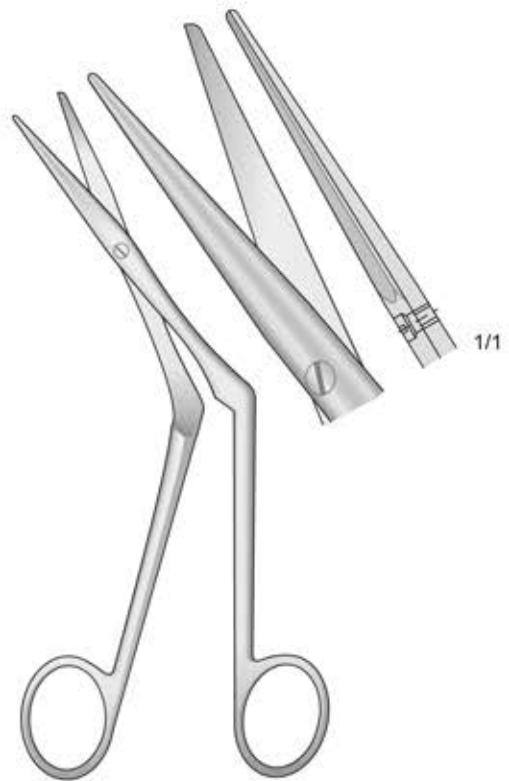

HEYMANN-KNIGHT
FG-99
175 mm

Nasenscheren - Nasal Scissors - Forbici nasali - Tijeras nasales - Ciseaux nasaux



FOMON
FG-7
150 mm



HEYMANN
FG-8
180 mm

Gezahnt
Serrated
Dentellata
Dentadas
Dentelé

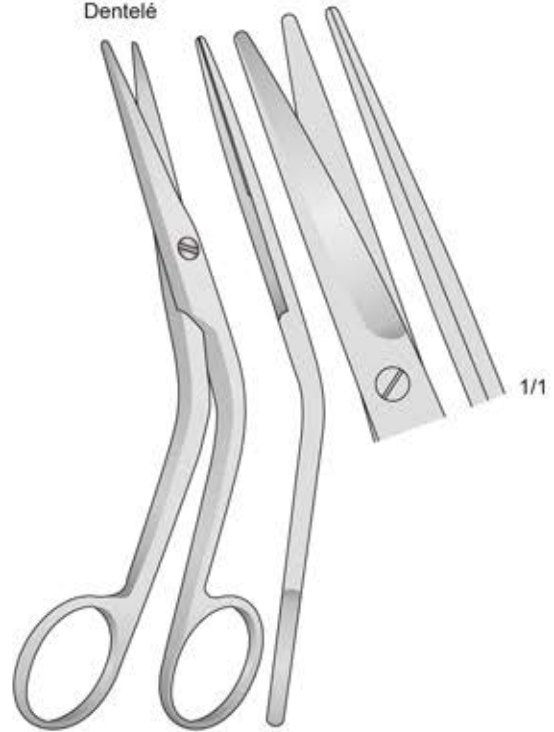

COTTLE
FG-9
160 mm

Knochensplitterscheren

Bone cutting scissors

Forbici ossivore

Tijeras para huesos

Ciseaux à os

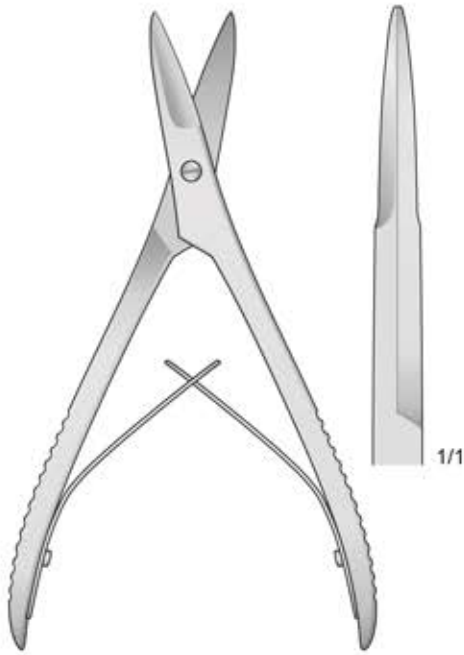

FO-63
160 mm

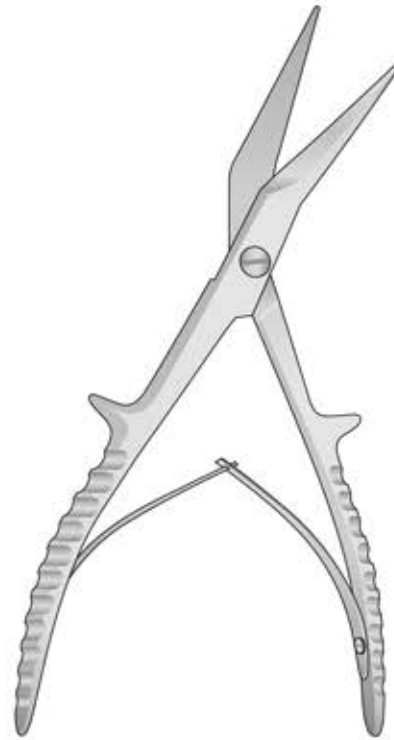

FG-110
195 mm

Gezahnt
Serrated
Dentellata
Dentadas
Dentelé

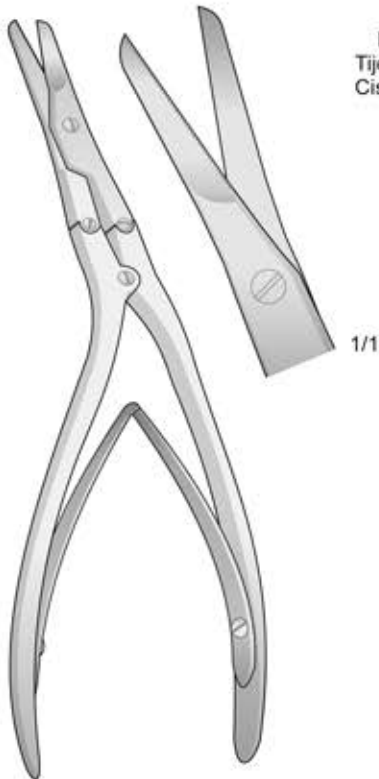

CAPLAN
FO-144
200 mm

Nasenseptumscheren
Septum Scissors
Forbici per setto nasale
Tijeras para el tabique nasal
Ciseaux pour cloison nasale

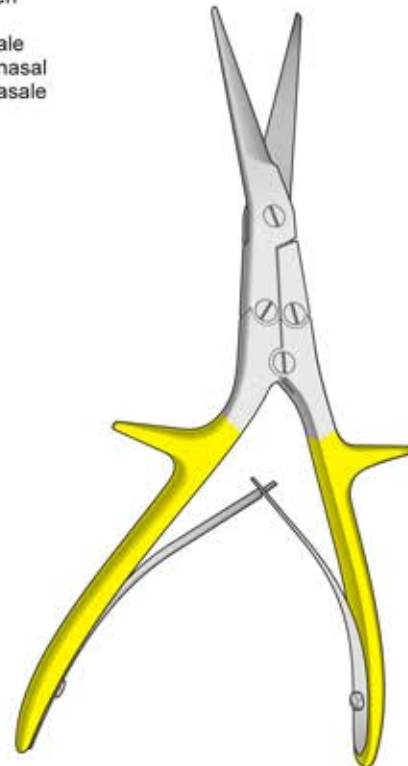

GORNEY
FO-190
205 mm

Mit einer Schneide gezahnt
With one blade serrated
Con una lama dentellata
Con una hoja dentada
Avec une lame dentée

Super Cut

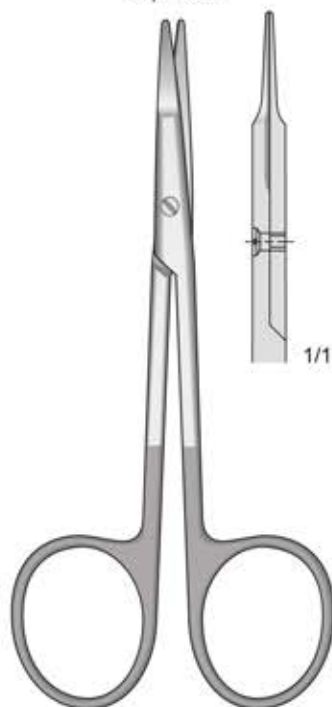

GREENBERG-PAR
FM-294
115 mm

Super Cut

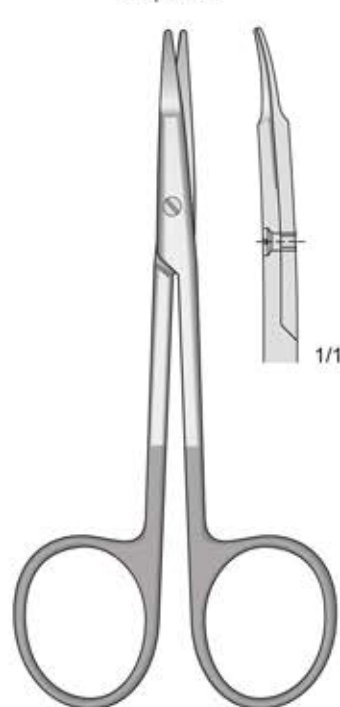

GREENBERG-PAR
FM-295
115 mm

Super Cut

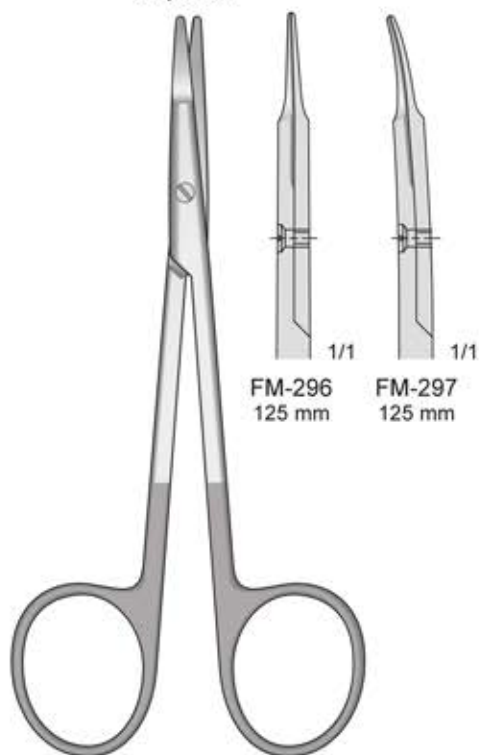

KILNER
FM-296/FM-297
125 mm

Super Cut

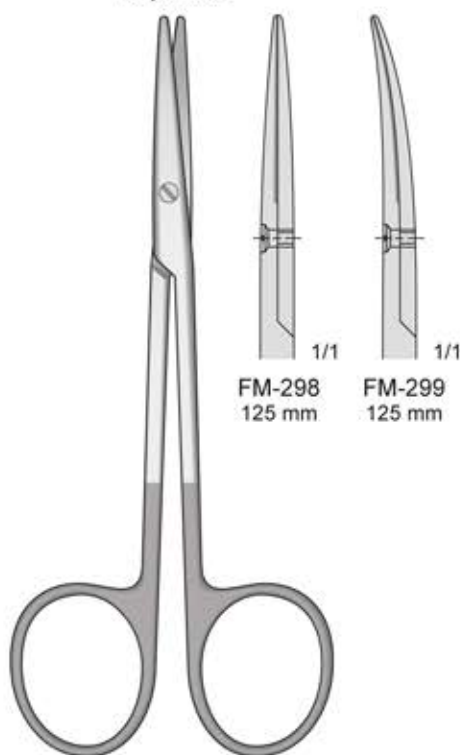

METZENBAUM
FM-298/FM-299
125 mm

Super Cut

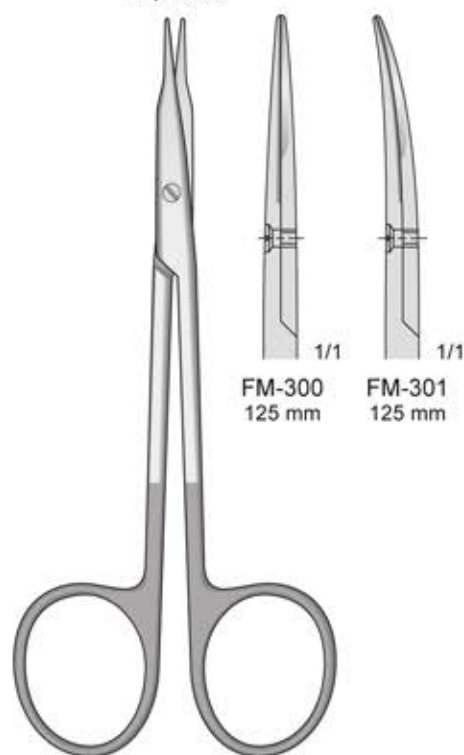

STEVENS
FM-300/FM-301
125 mm

"Super-cut" scheren micro-schliff für tissue atrauma - "Super-cut" scissors for gripping tissue and cutting interproximally
 Forbici "Super-cut" estremamente taglienti per tessuti con riduzione del trauma - Tijeras "super cortes" para cortar tissue-atrauma
 Ciseaux "super cut" coupe les tissus en reduisant les risques de traumatisme

Gezahnte Scheren
 Scissors Serrateds
 Forbici Dentellate
 Tijeras Dentada
 Ciseaux Dentelé

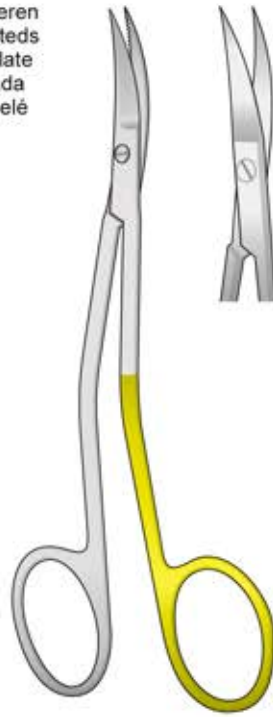

LA GRANGE
 LG-1SC/LG-2SC
 115 mm

Spitz
 Sharp
 Acute
 Agudas
 Pointu



LA GRANGE
 LG-1SC

Stumpf
 Blunt
 Smusse
 Romas
 Mousse



LA GRANGE
 LG-2SC

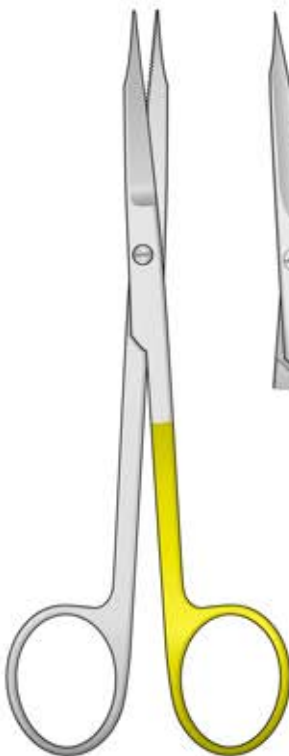

GOLDMAN-FOX
 GFC-SC/GFR-SC
 135 mm



GFR-SC



GFC-SC

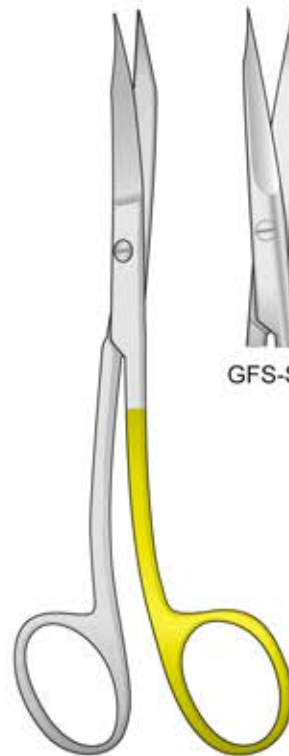

GOLDMAN-FOX
 GFS-SC
 130 mm



GFS-SC

S Form



"Super-cut" scheren micro-schliff für tissue atrauma - "Super-cut" scissors for gripping tissue and cutting interproximally
 Forbici "Super-cut" estremamente taglienti per tessuti con riduzione del trauma - Tijeras "super cortes" para cortar tissue-atrauma
 Ciseaux "super cut" coupe les tissus en réduisant les risques de traumatisme

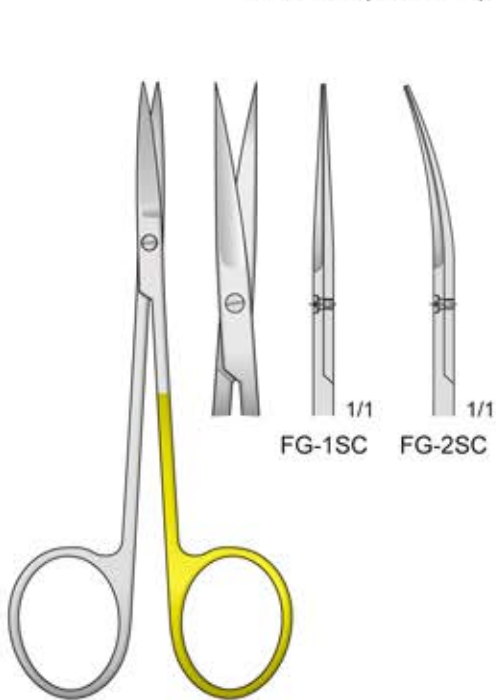

IRIS
FG-1SC/FG-2SC
110 mm

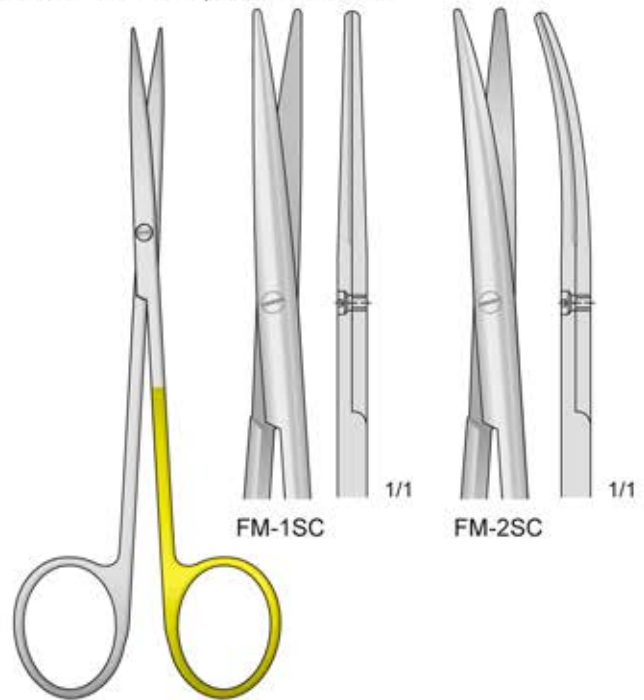

METZENBAUM
FM-1SC/FM-2SC
145 mm

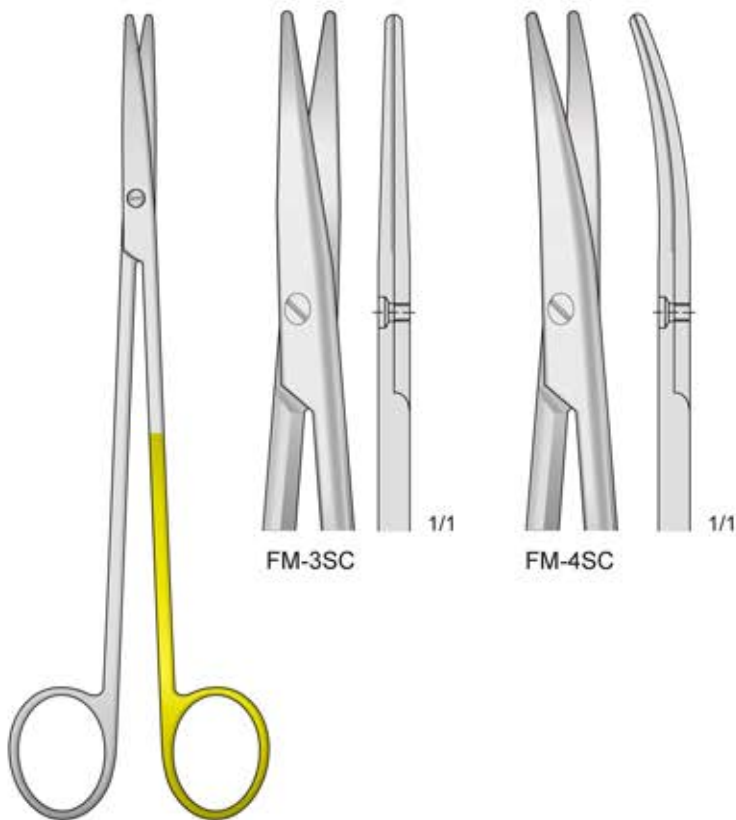

METZENBAUM
FM-3SC/FM-4SC
185 mm

"Super-cut" scheren micro-schliff für tissue atrauma - "Super-cut" scissors for gripping tissue and cutting interproximally
 Forbici "Super-cut" estremamente taglienti per tessuti con riduzione del trauma - Tijeras "super cortes" para cortar tissue-atrauma
 Ciseaux "super cut" coupe les tissus en reduisant les risques de traumatisme

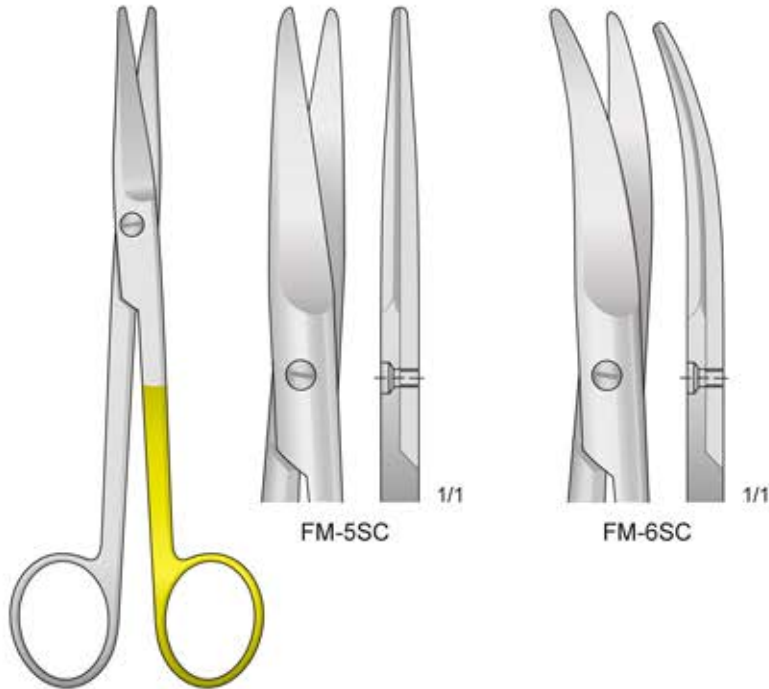

MAYO
 FM-5SC/FM-6SC
 140 mm

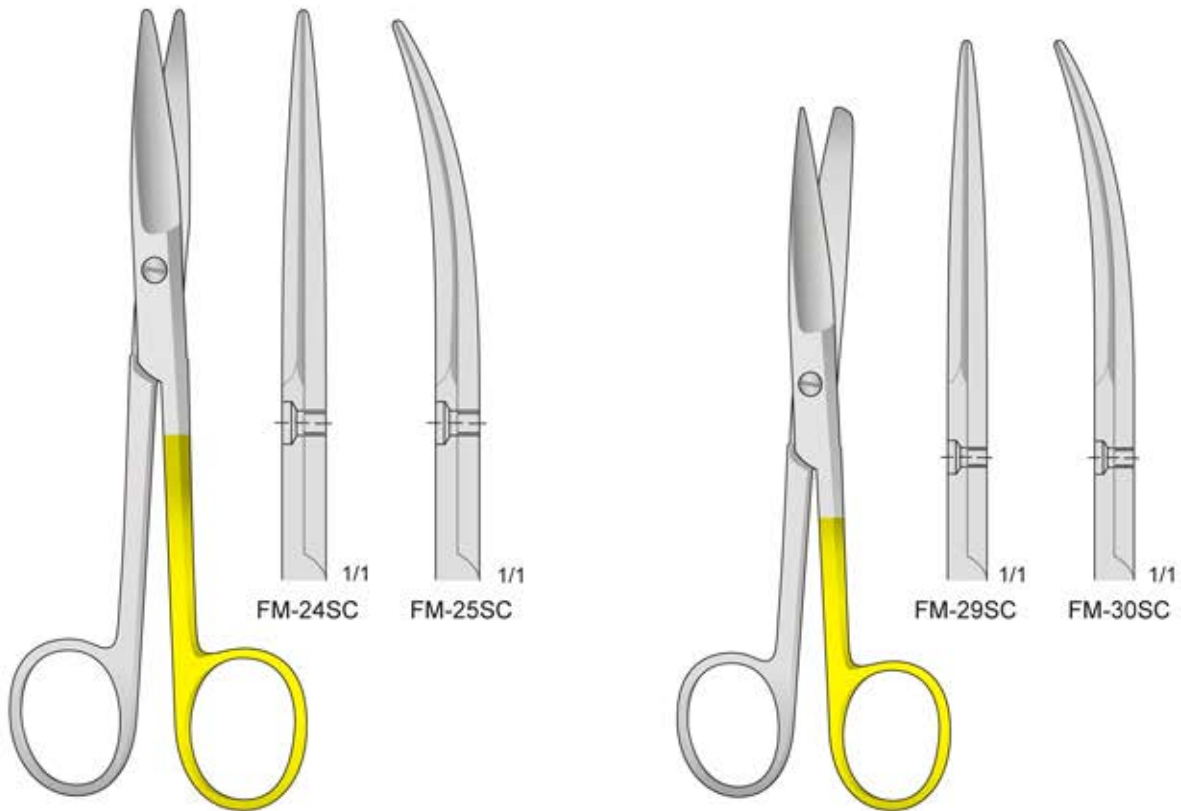

MAYO
 FM-24SC/FM25SC
 170 mm

FM-29SC/FM30SC
 145 mm

L = links
left
mancini
izquierda
gauche

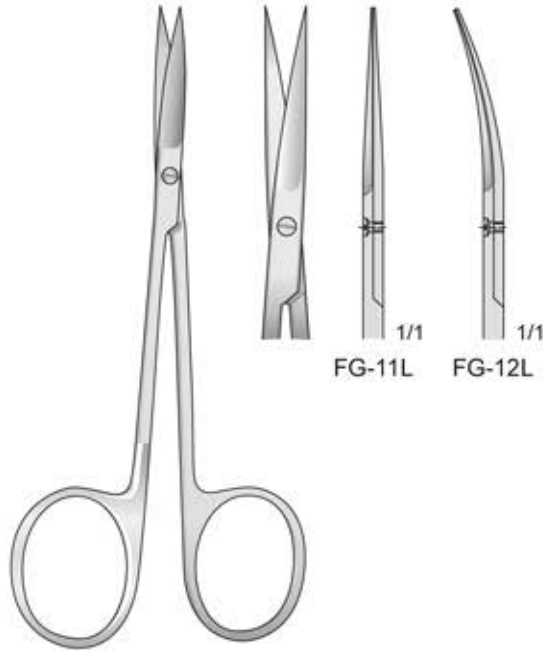

IRIS
FG-11L/FG-12L
110 mm

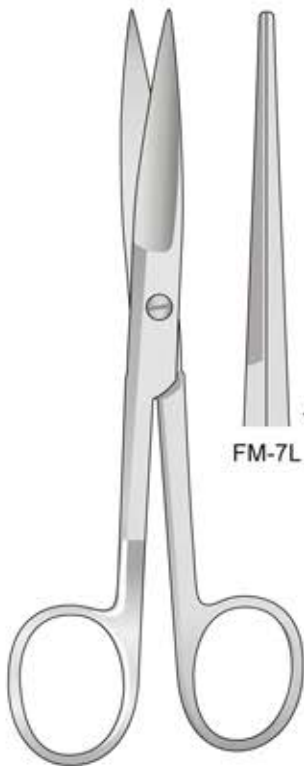

FM-7L/FM-8L
145 mm

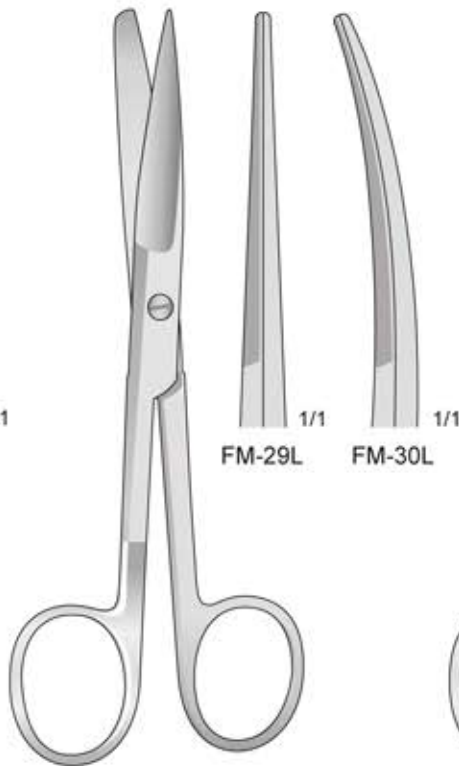

FM-29L/FM-30L
145 mm

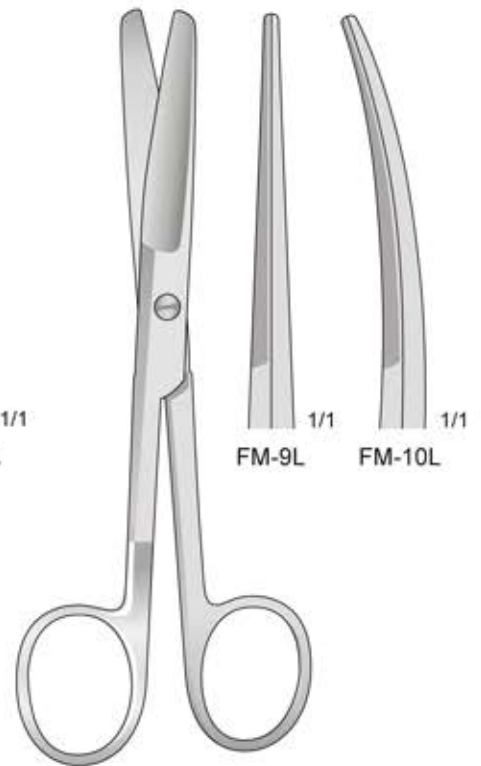

FM-9L/FM-10L
145 mm

Mit Hartmetalleinsätzen - Tungsten-carbide scissors
 Con punta al carburo di tungsteno - Tijeras de tungsteno - Avec plaquettes en carbure de tungstène

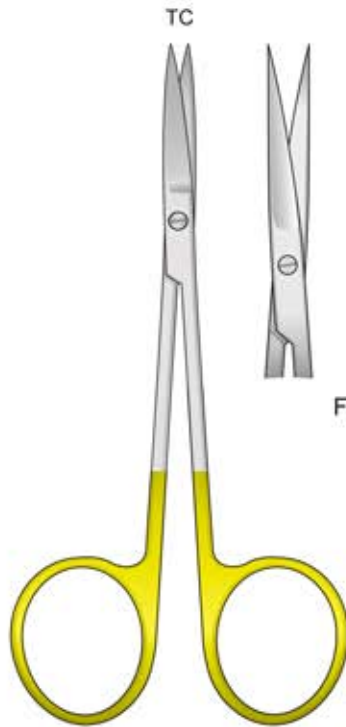

IRIS
 FG1-TC/FG2-TC
 115 mm

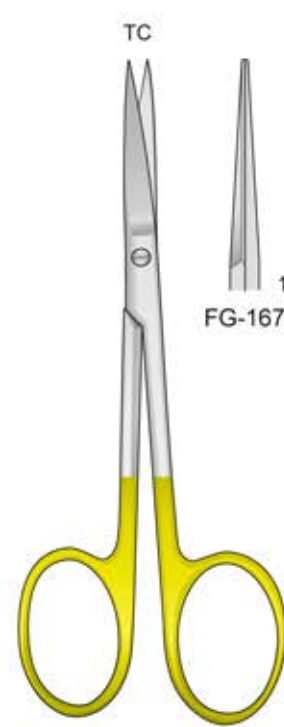
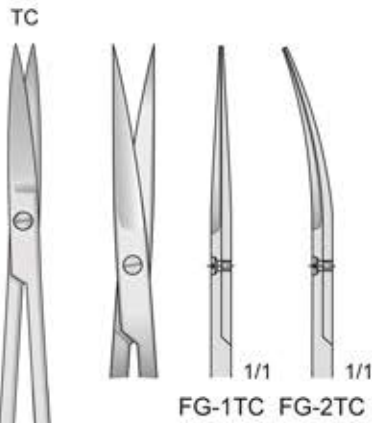

FG-167/FG-168
 110 mm

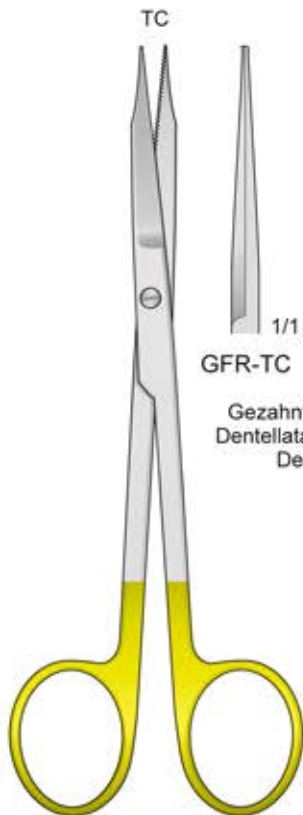
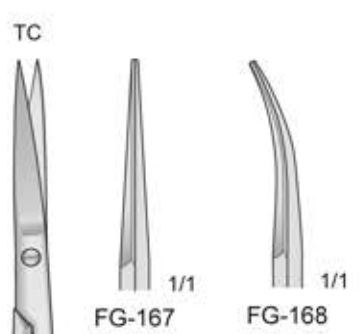

GOLDMAN-FOX
 GFC-TC/GFR-TC
 135 mm

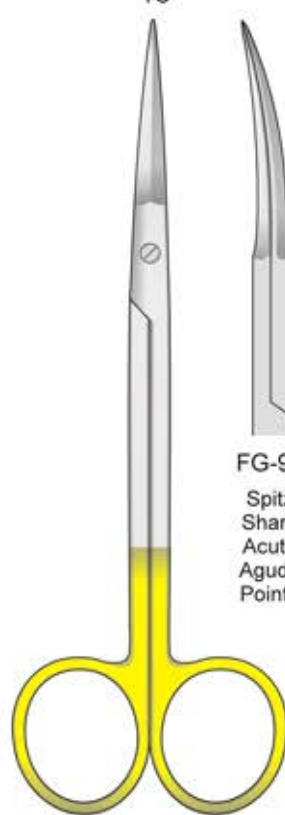
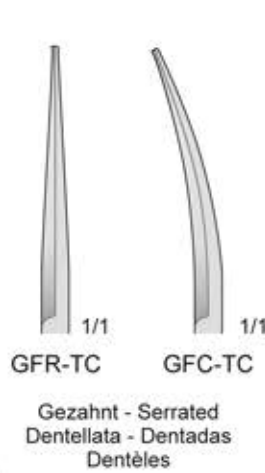

PECK-JOSEPH
 FG-92/FG-98
 140 mm

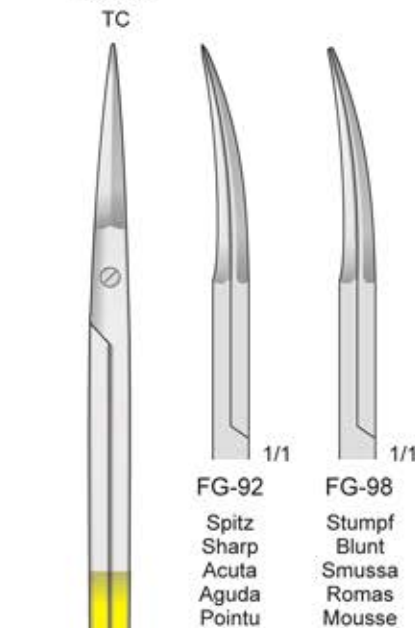

METZENBAUM-FINO
 FM-96
 140 mm

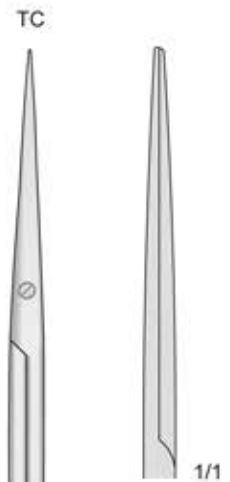

Mit Hartmetalleinsätzen - Tungsten-carbide scissors
Con punta al carburo di tungsteno - Tijeras de tungsteno - Avec plaquettes en carbure de tungstène

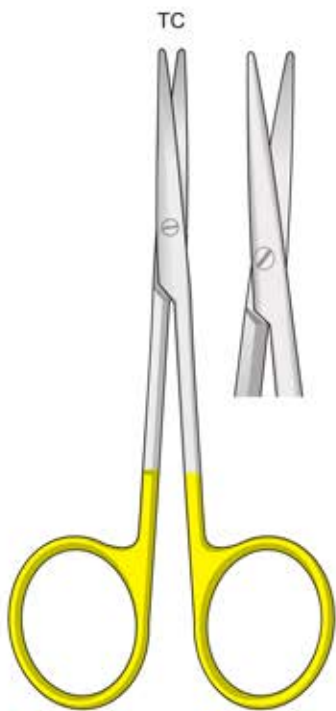

FM-118
115 mm

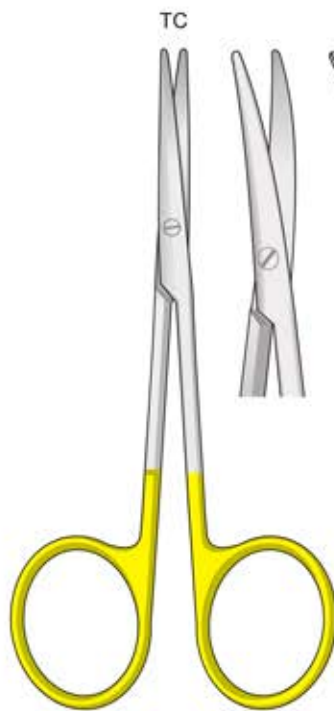

FM-119
115 mm

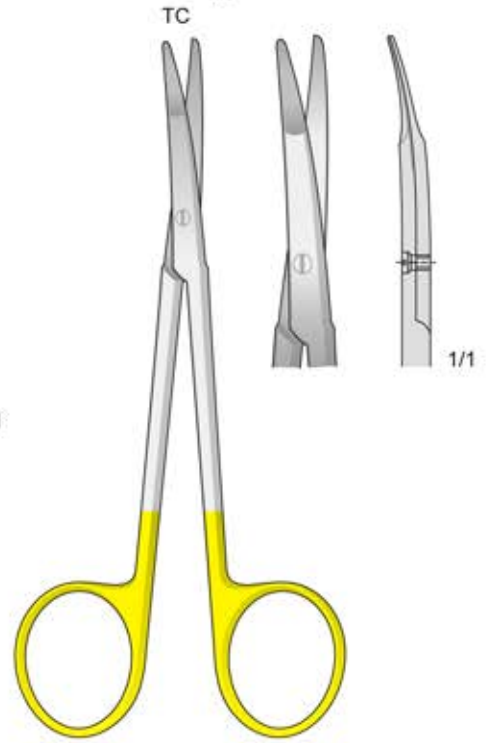

KILNER (RAGNELL)
FM-350
125 mm

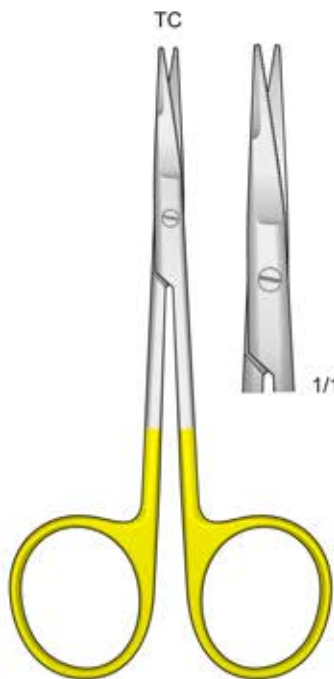

PAR-TYPE
FM-316
115 mm

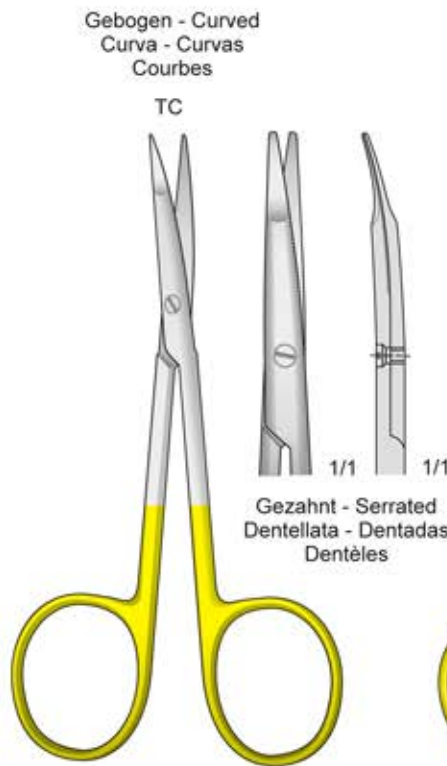

GREENBERG-PAR
FM-317
115 mm

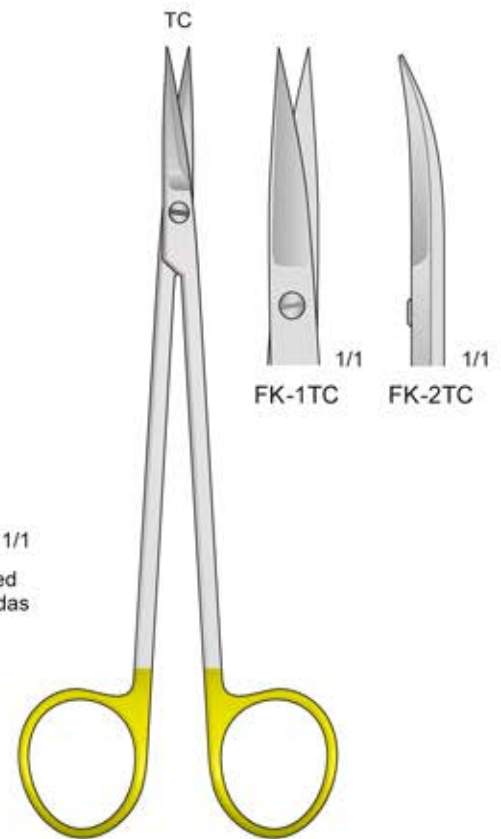

KELLY
FK-1TC/FK-2TC
160 mm

Mit Hartmetalleinsätzen - Tungsten-carbide scissors
 Con punta al carburo di tungsteno - Tijeras de tungsteno - Avec plaquettes en carbure de tungstène

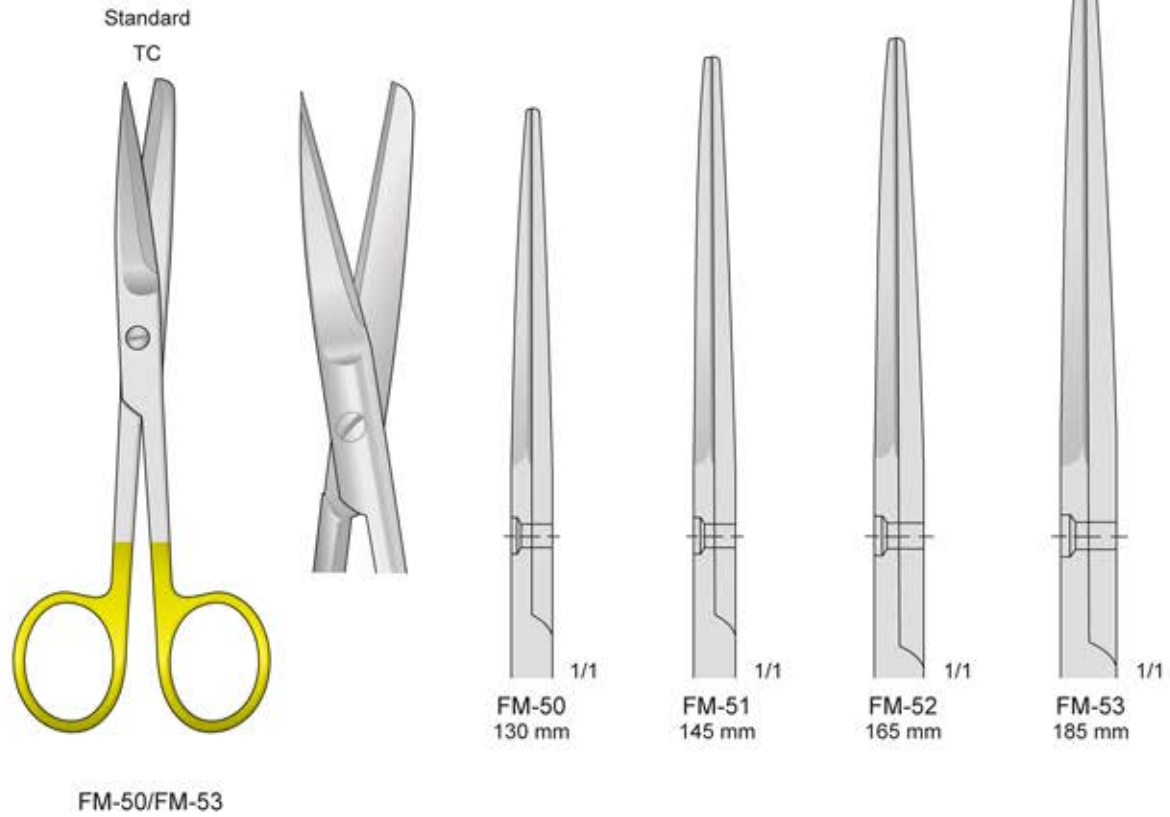

Mit Hartmetalleinsätzen - Tungsten-carbide scissors
 Con punta al carburo di tungsteno - Tijeras de tungsteno - Avec plaquettes en carbure de tungstène

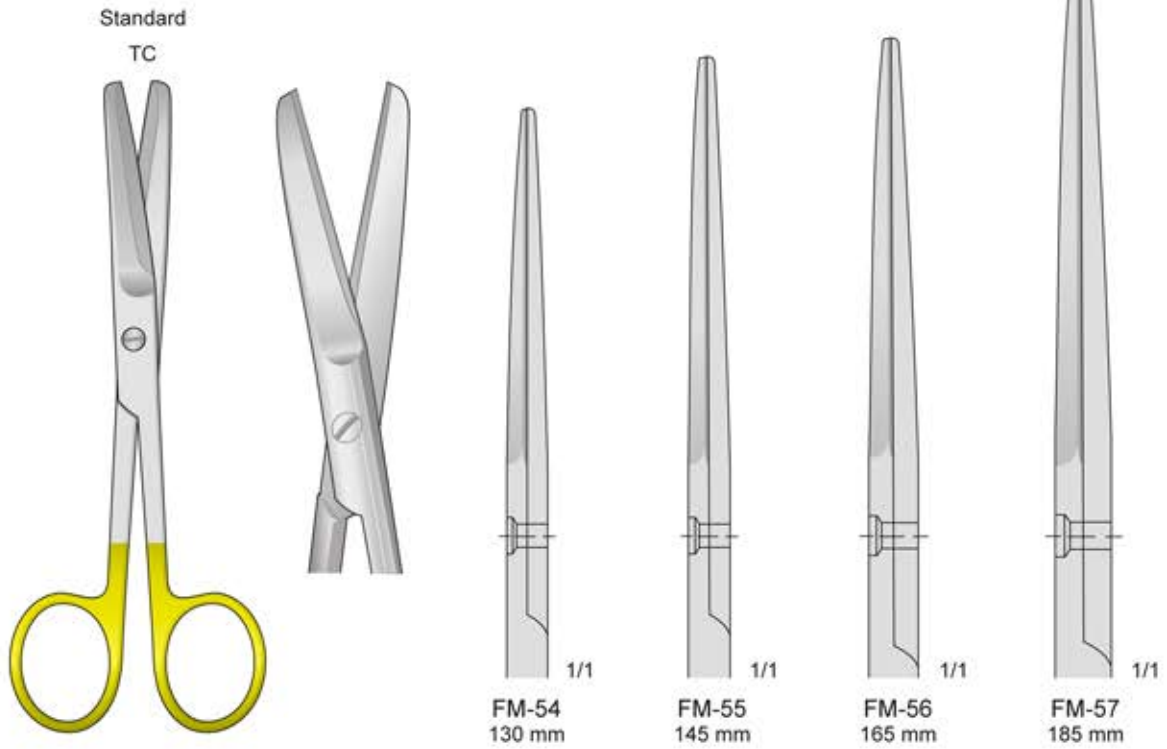

FM-54/FM-57

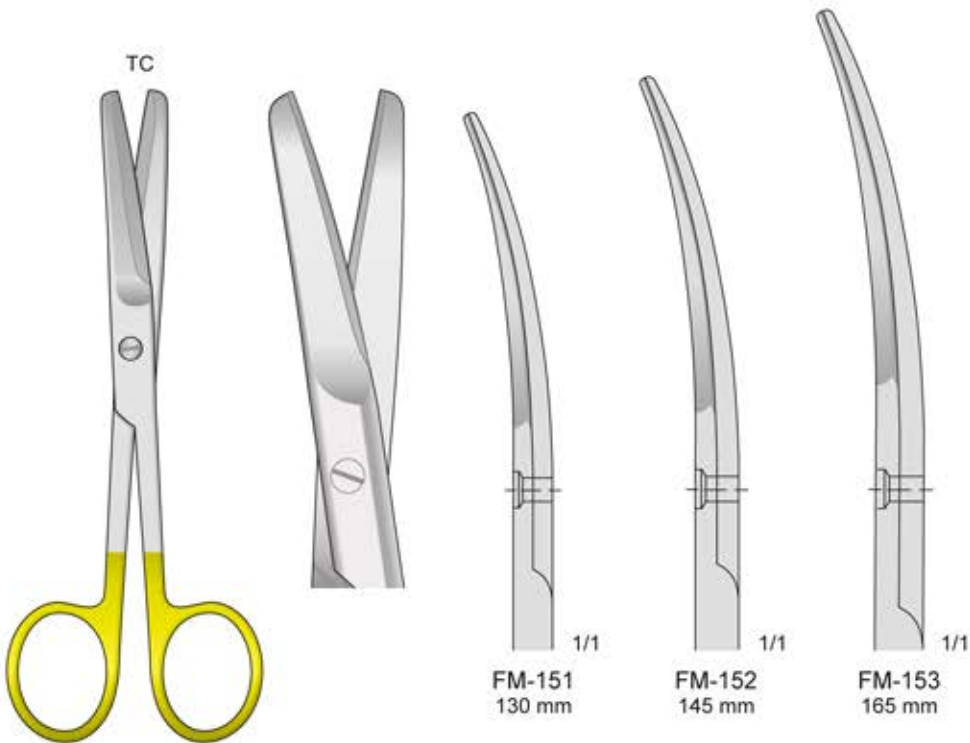

FM-151/FM-153

Mit Hartmetalleinsätzen - Tungsten-carbide scissors
 Con punta al carburo di tungsteno - Tijeras de tungsteno - Avec plaquettes en carbure de tungstène

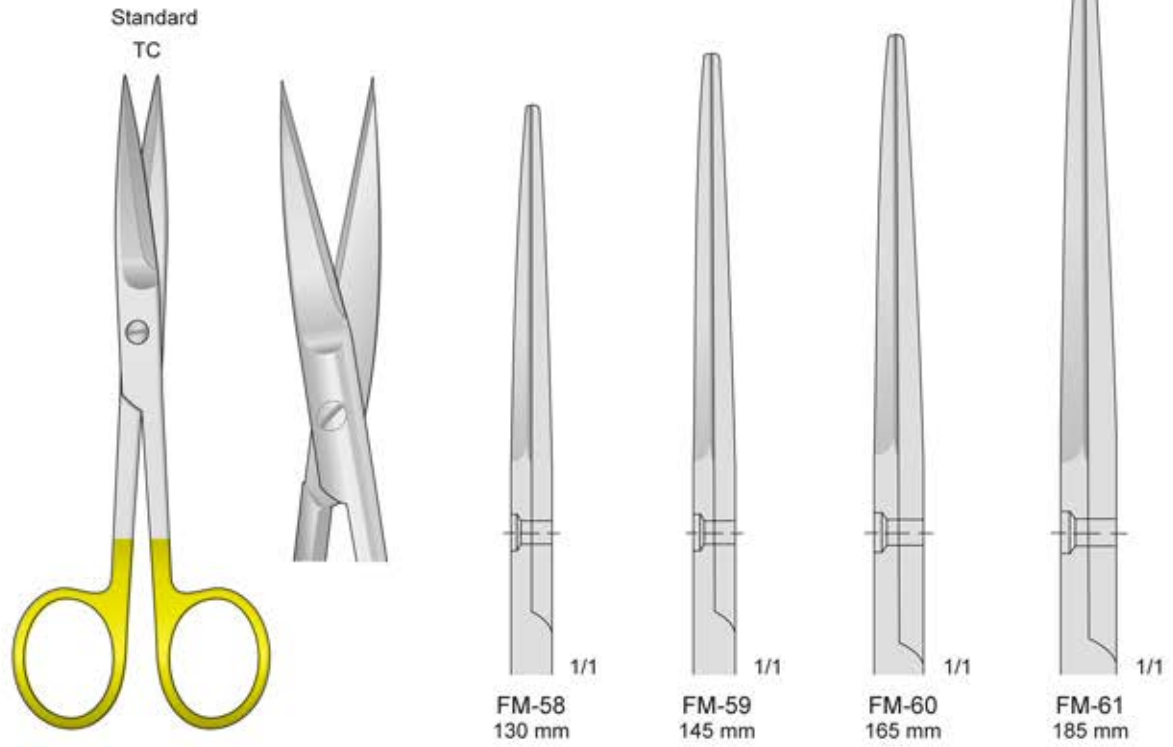

FM-58/FM-61



FM-145/FM-147

Mit Hartmetalleinsätzen - Tungsten-carbide scissors
Con punta al carburo di tungsteno - Tijeras de tungsteno - Avec plaquettes en carbure de tungstène

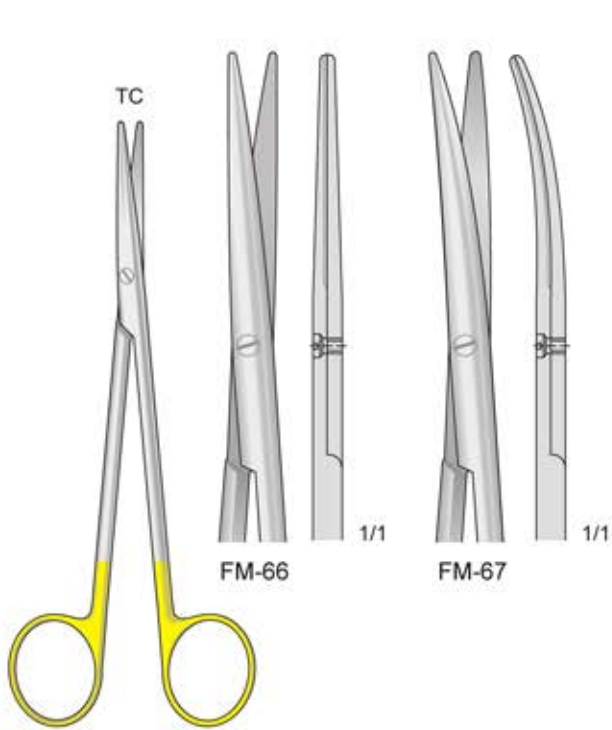

METZENBAUM
FM-66/FM-67
145 mm

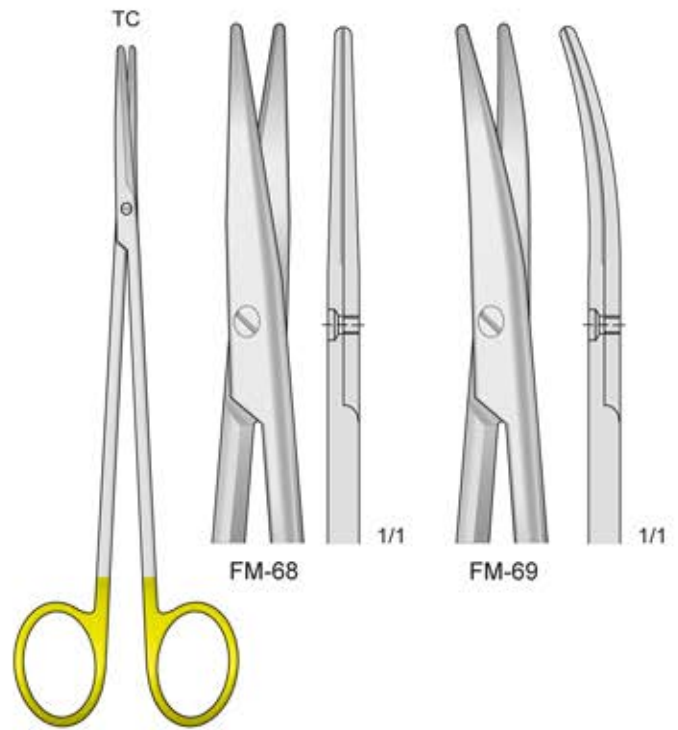

METZENBAUM
FM-68/FM-69
185 mm

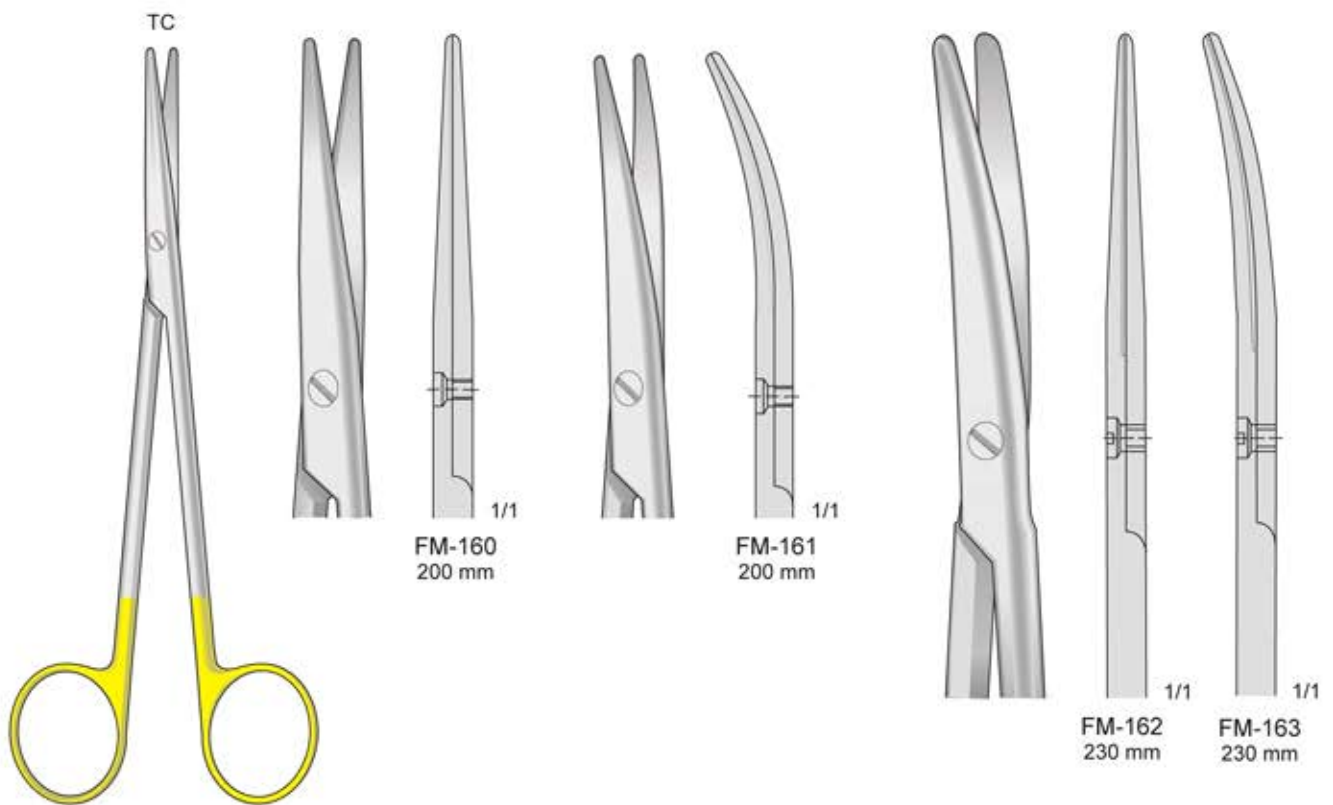

METZENBAUM
FM-160/FM-163

Mit Hartmetalleinsätzen - Tungsten-carbide scissors
Con punta al carburo di tungsteno - Tijeras de tungsteno - Avec plaquettes en carbure de tungstène

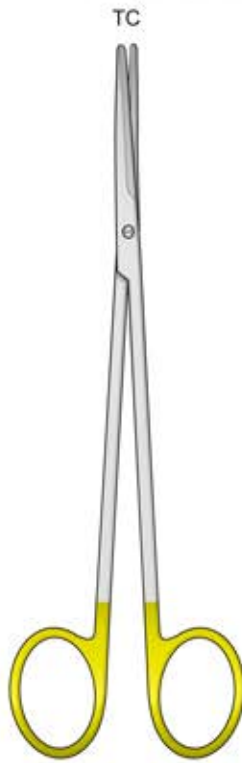

METZENBAUM-FINO
FM-201/FM-205



FM-201
140 mm

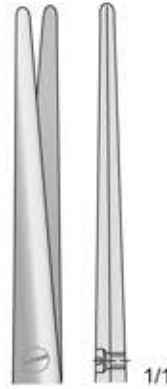

FM-203
180 mm

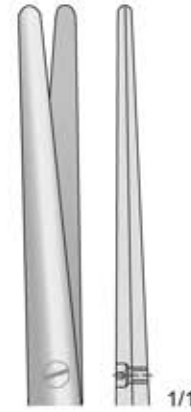

FM-205
200 mm

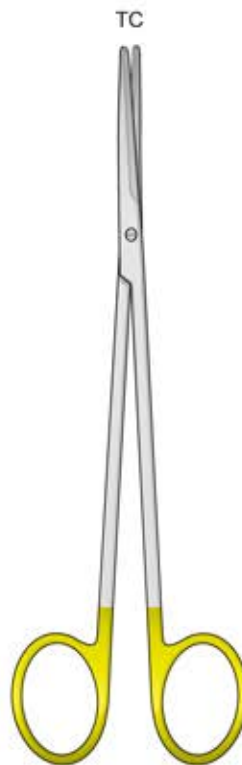

METZENBAUM-FINO
FM-207/FM-211



FM-207
230 mm

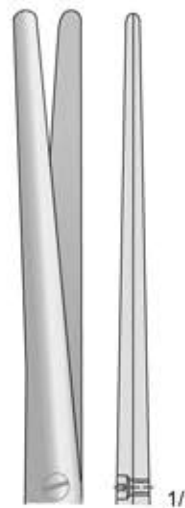

FM-209
250 mm

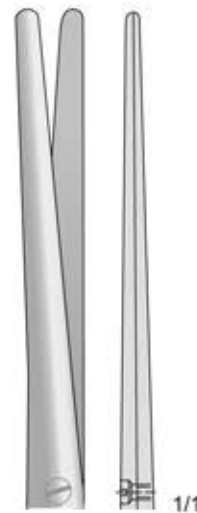

FM-211
280 mm

Mit Hartmetalleinsätzen - Tungsten-carbide scissors
Con punta al carburo di tungsteno - Tijeras de tungsteno - Avec plaquettes en carbure de tungstène

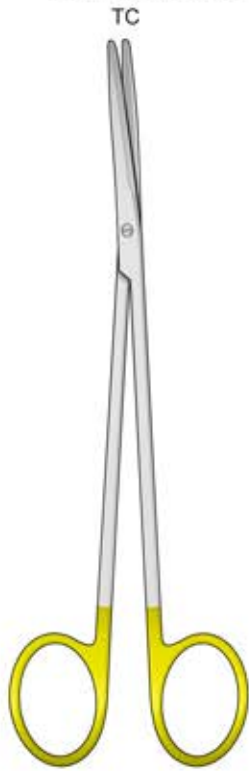

METZENBAUM-FINO
FM-202/FM-206

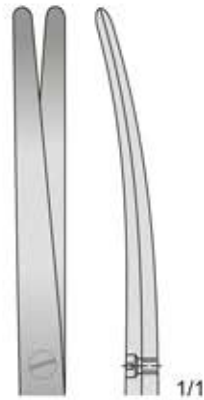

FM-202
140 mm

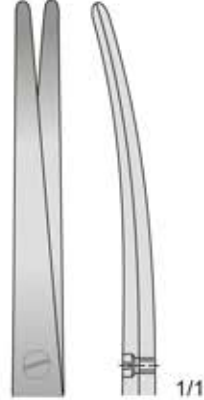

FM-204
180 mm

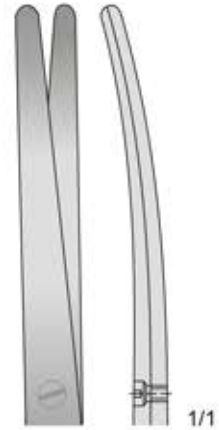

FM-206
200 mm

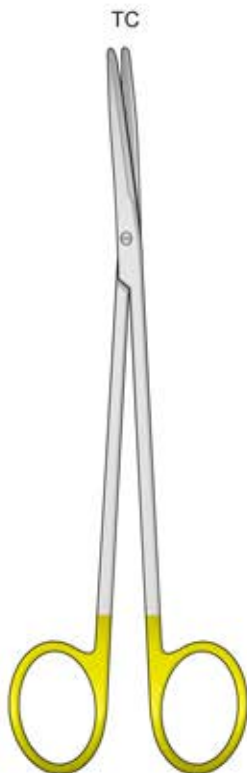

METZENBAUM-FINO
FM-208/FM-212

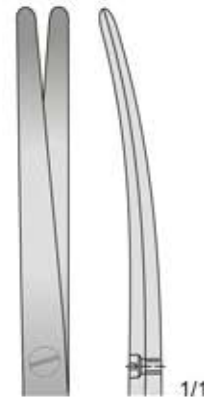

FM-208
230 mm

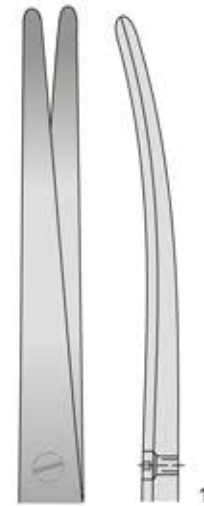

FM-210
250 mm

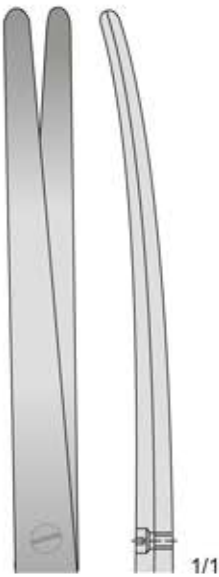

FM-212
280 mm

Mit Hartmetalleinsätzen - Tungsten-carbide scissors
 Con punta al carburo di tungsteno - Tijeras de tungsteno - Avec plaquettes en carbure de tungstène



METZENBAUM-FINO
FM-96/FM-99

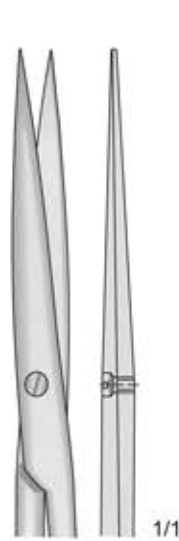

FM-96
140 mm

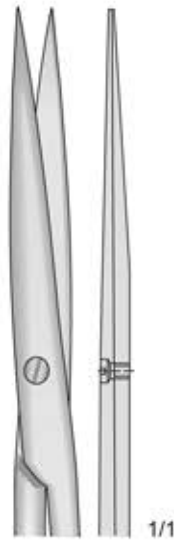

FM-97
180 mm

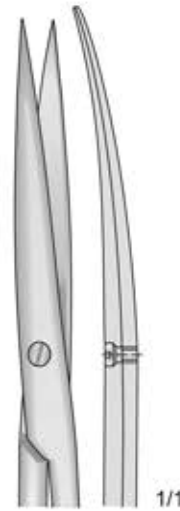

FM-98
140 mm

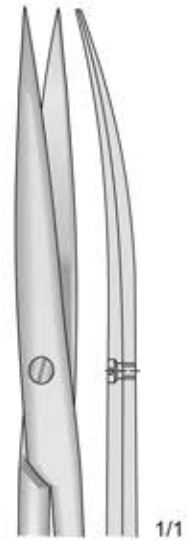

FM-99
180 mm

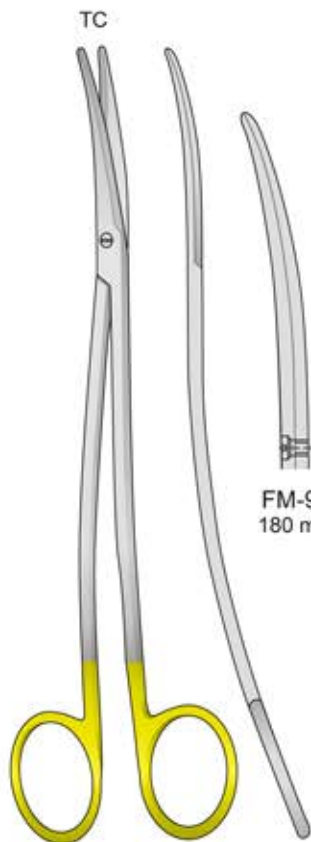

METZENBAUM-FINO
FM-90/FM-94



FM-90
180 mm

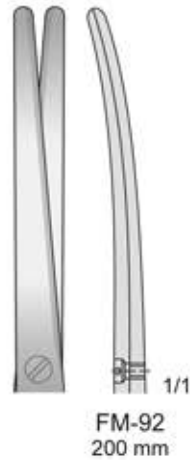

FM-92
200 mm

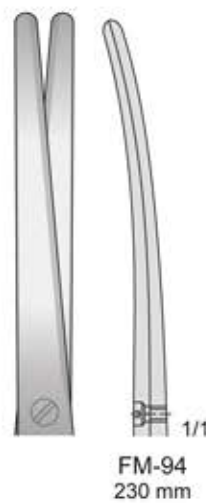

FM-94
230 mm

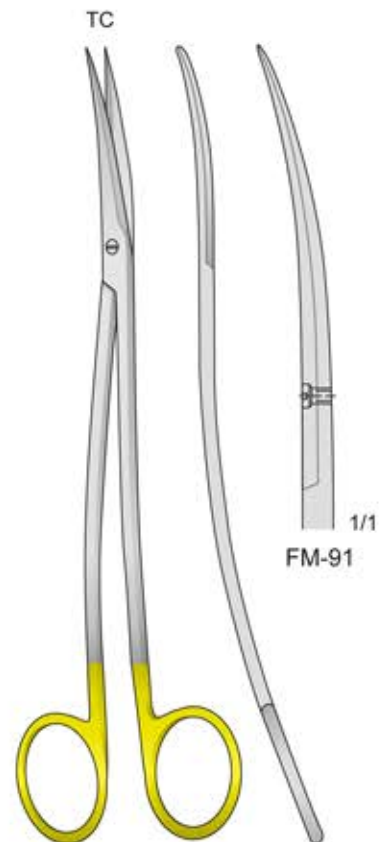

METZENBAUM-FINO
FM-91
180 mm

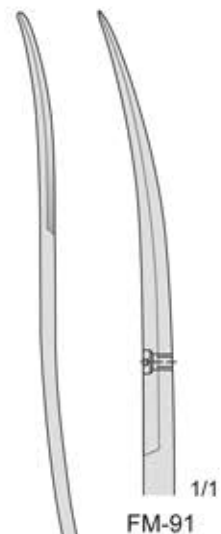

FM-91

Mit Hartmetalleinsätzen - Tungsten-carbide scissors
Con punta al carburo di tungsteno - Tijeras de tungsteno - Avec plaquettes en carbure de tungstène

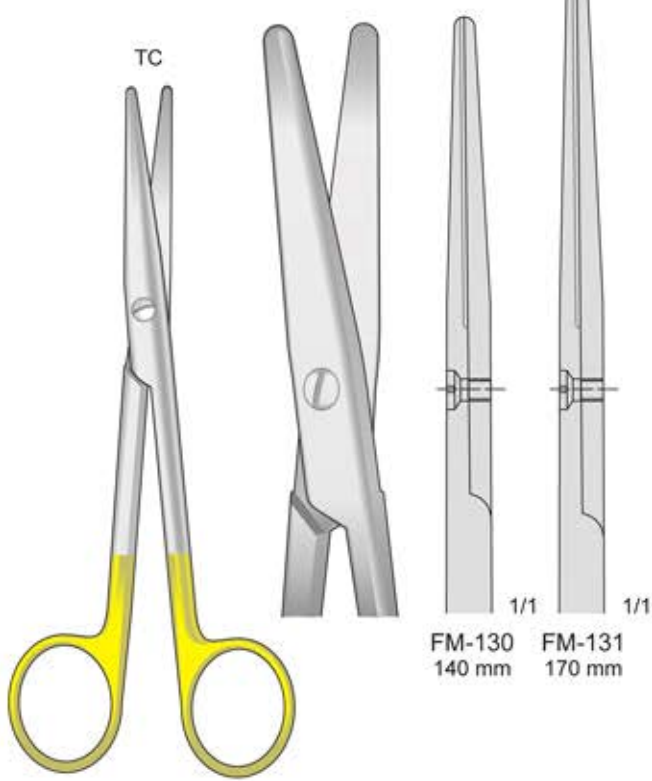

MAYO-STILLE
FM-130/FM-131

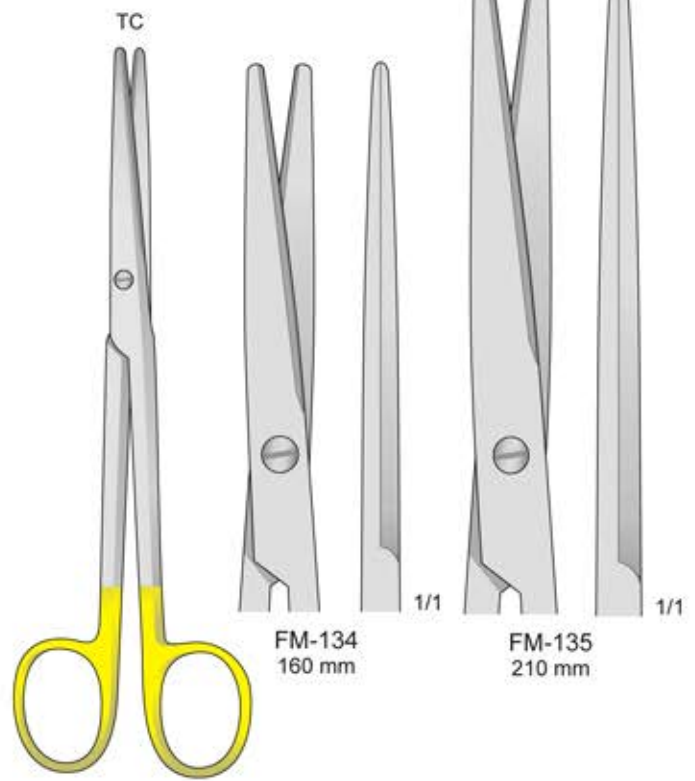

LEXER
FM-134/FM-135

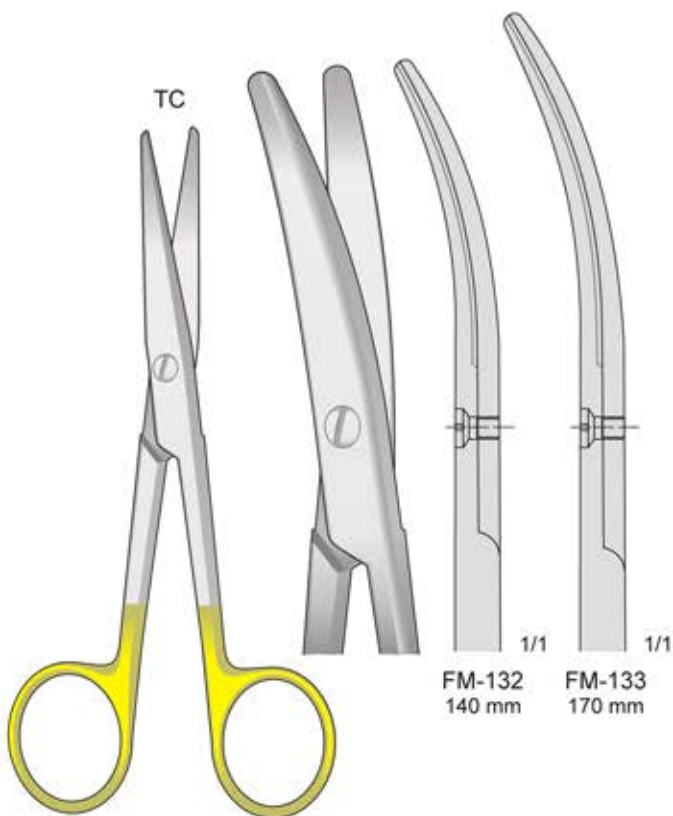

MAYO-STILLE
FM-132/FM-133

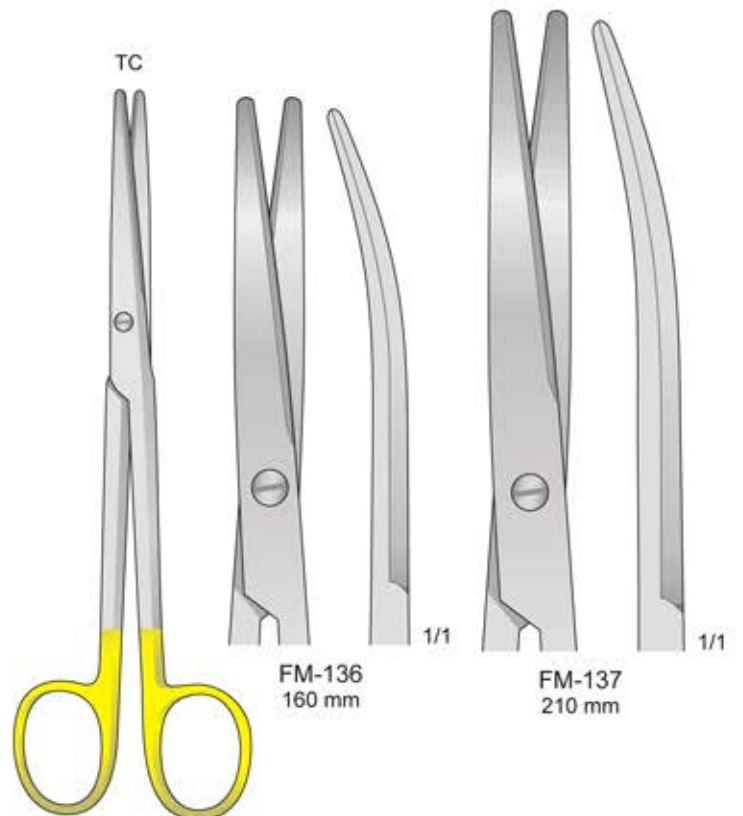

LEXER
FM-136/FM-137

Mit Hartmetalleinsätzen - Tungsten-carbide scissors
Con punta al carburo di tungsteno - Tijeras de tungsteno - Avec plaquettes en carbure de tungstène

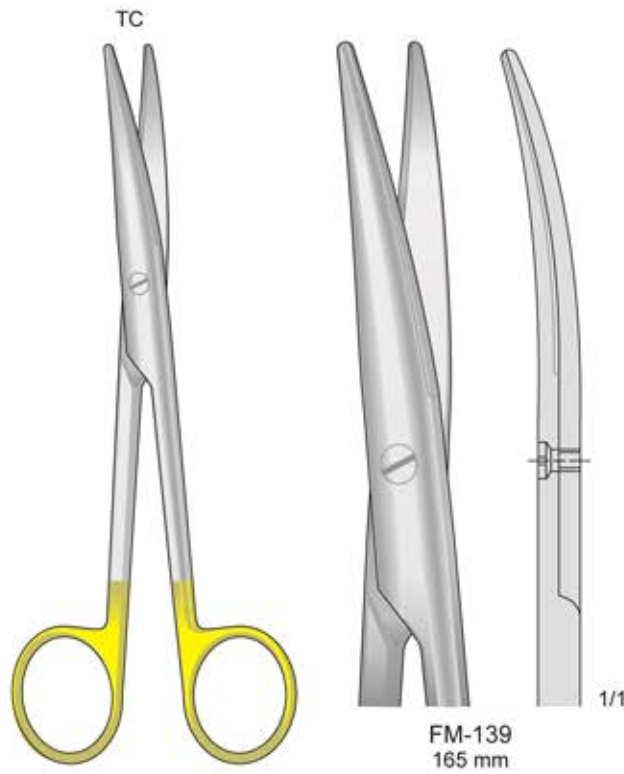

MAYO-LEXER
FM-139
165 mm

FM-139
165 mm

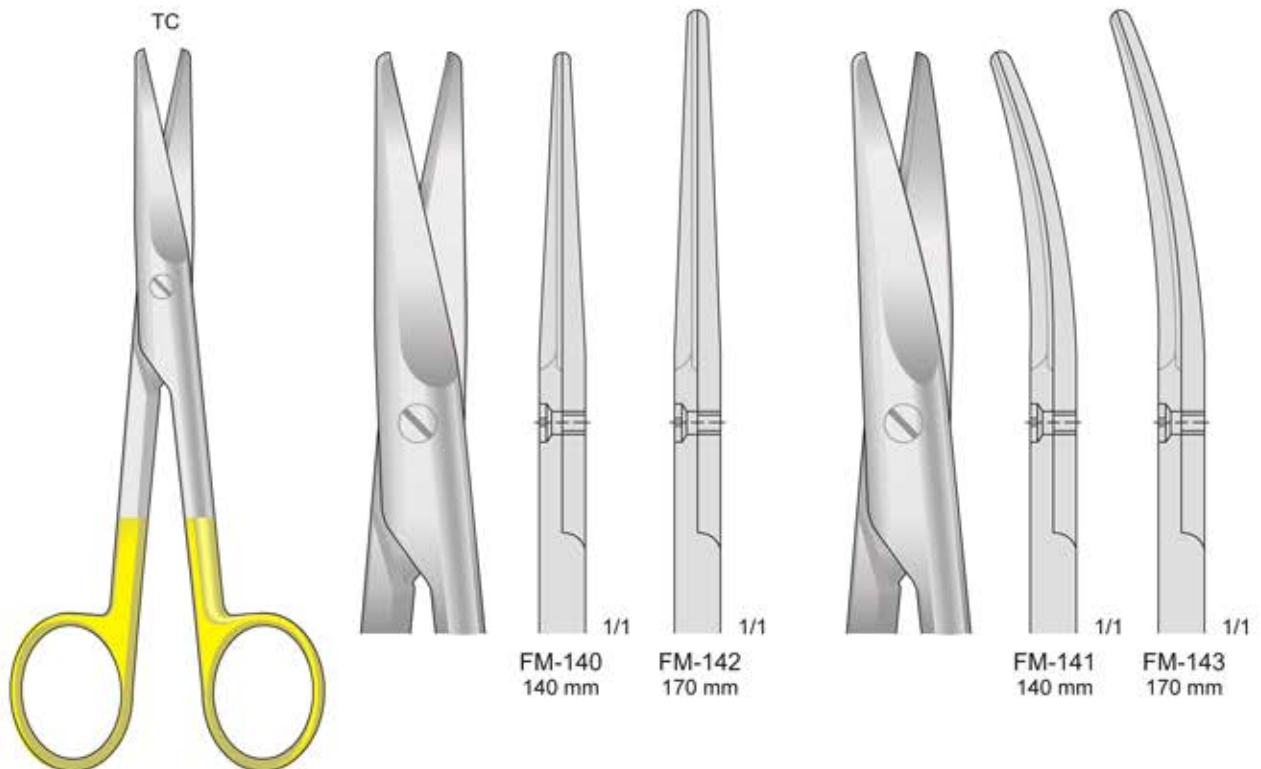

MAYO
FM-140/FM-143

FM-140
140 mm

FM-142
170 mm

FM-141
140 mm

FM-143
170 mm

Mit Hartmetalleinsätzen - Tungsten-carbide scissors
 Con punta al carburo di tungsteno - Tijeras de tungsteno - Avec plaquettes en carbure de tungstène

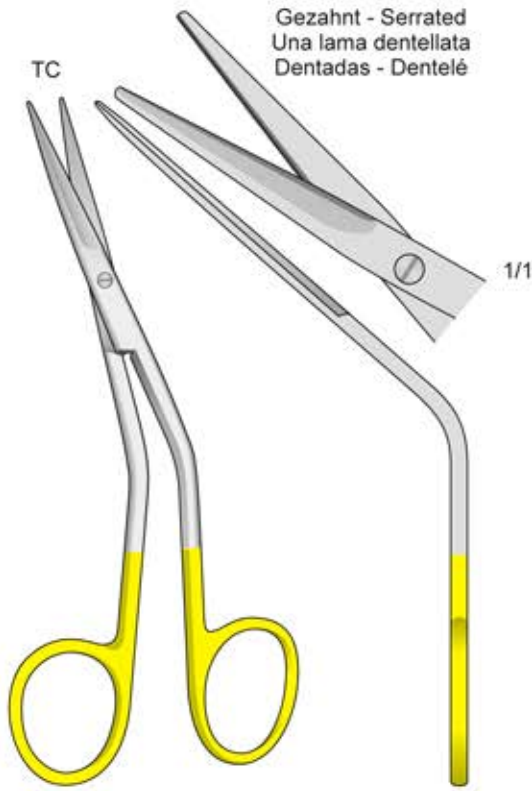

FOMON
FG-165
135 mm

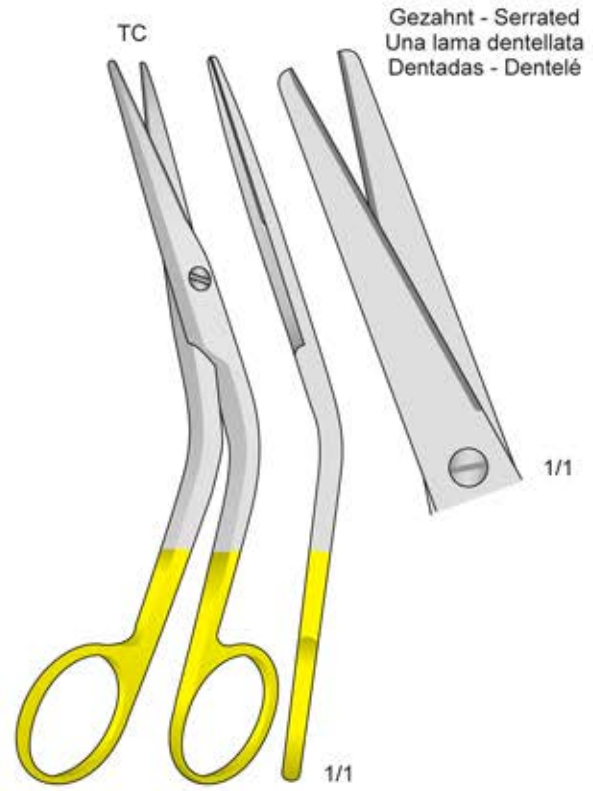

COTTLE
FG-166
160 mm

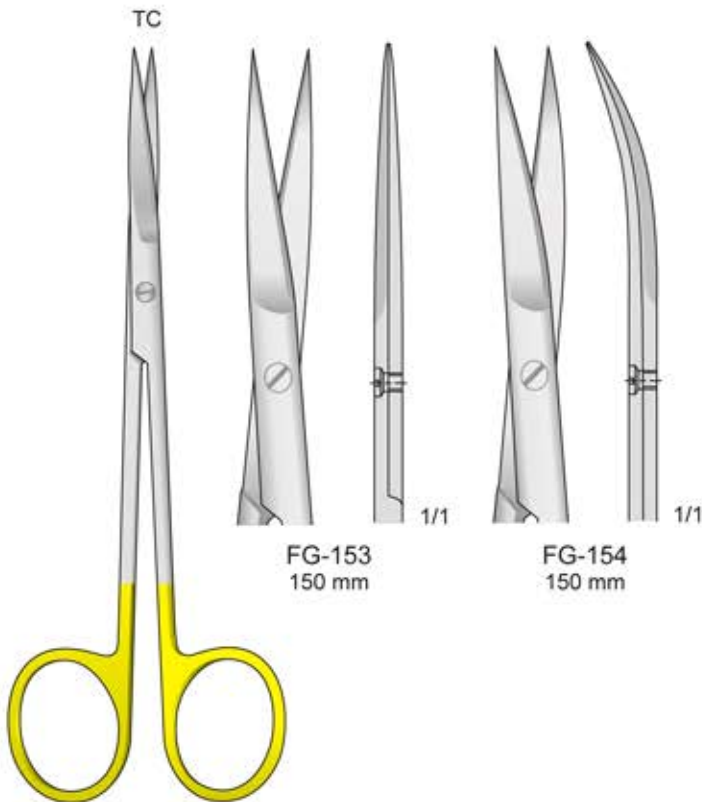

JOSEPH
FG-153/FG-154
150 mm

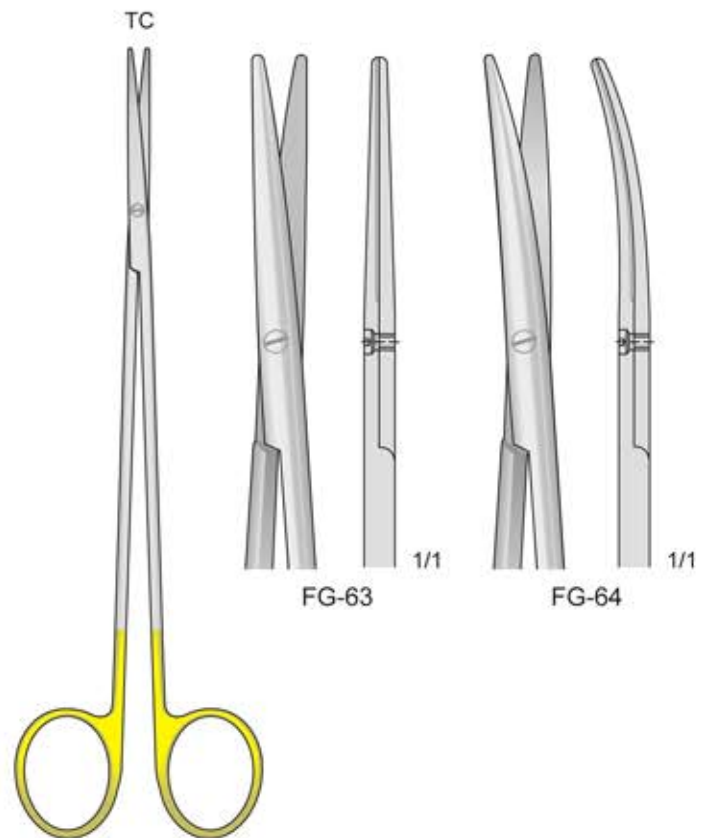

TOENNIS-ADSON
FG-63/FG-64
180 mm

Mit Hartmetalleinsätzen - Tungsten-carbide scissors
 Con punta al carburo di tungsteno - Tijeras de tungsteno - Avec plaquettes en carbure de tungstène

Scheren mit Wellenschliff auf einer Schnittfläche
 Scissors cut one serrated cutting edge
 Forbici con taglio ondulato su una lama
 Tijeras con ondas afilados
 Ciseaux avec affutage spécial ont une lame dentée

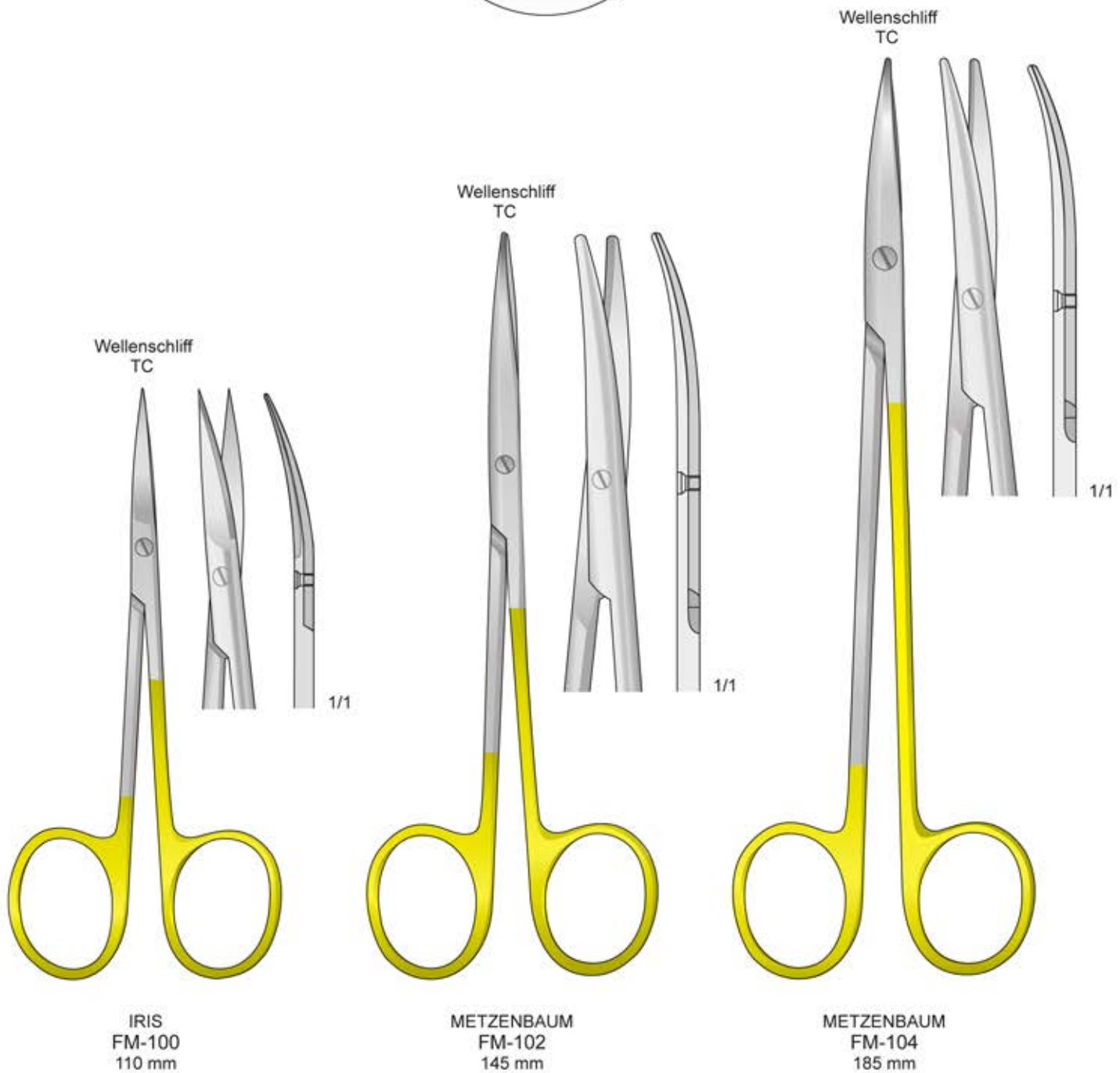
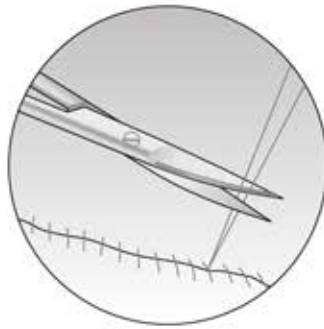

Mit Hartmetalleinsätzen - Tungsten-carbide scissors
 Con punta al carburo di tungsteno - Tijeras de tungsteno - Avec plaquettes en carbure de tungstène

Mit einer Schneide gezahnt
 With one blade serrated
 Con una lama zigrinata
 Con una hoja dentada
 Avec lame dentée

TC

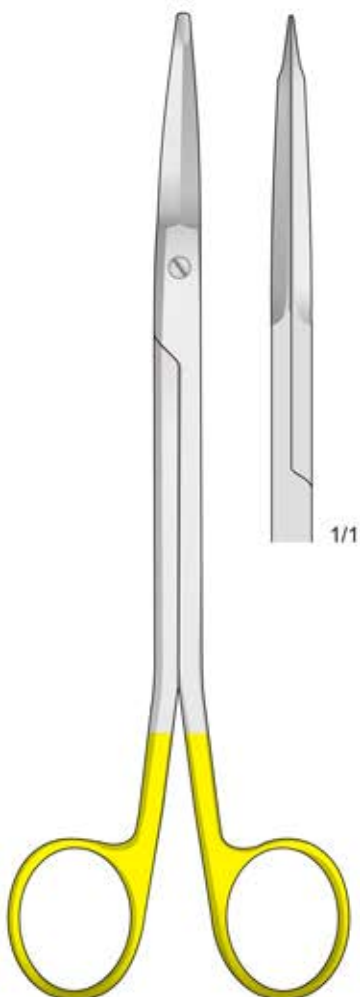

FREEMAN-GORNEY
 FM-311
 180 mm

Mit einer Schneide gezahnt
 With one blade serrated
 Con una lama zigrinata
 Con una hoja dentada
 Avec lame dentée

TC

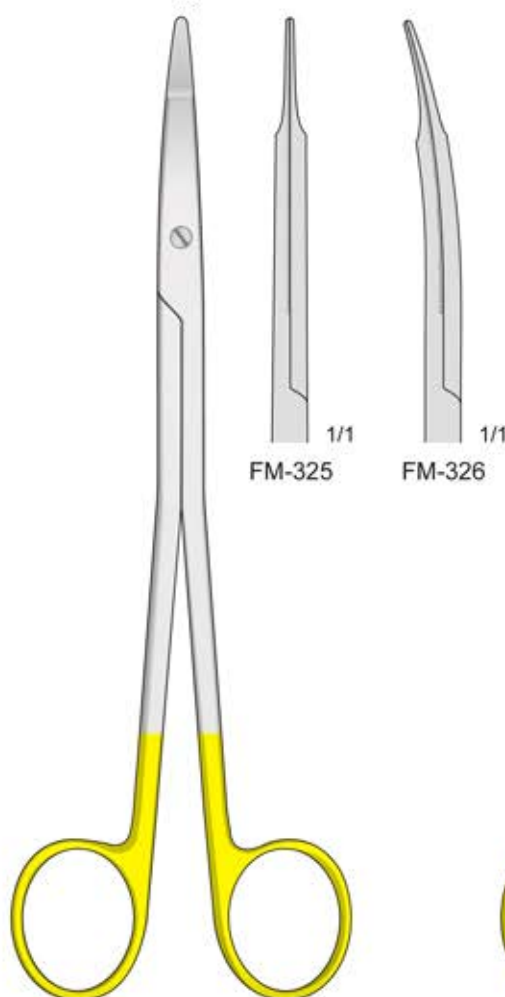

FREEMAN
 FM-325/FM-326
 180 mm

Mit einer Schneide gezahnt
 With one blade serrated
 Con una lama zigrinata
 Con una hoja dentada
 Avec lame dentée

TC

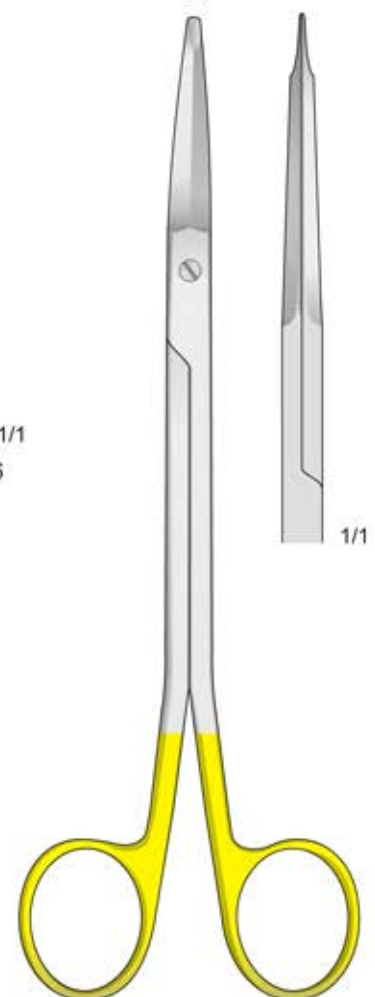

FREEMAN-KAYE
 FM-334
 180 mm

Mit Hartmetalleinsätzen - Tungsten-carbide scissors
 Con punta al carburo di tungsteno - Tijeras de tungsteno - Avec plaquettes en carbure de tungstène

Mit einer Schneide gezahnt
 With one blade serrated
 Con una lama zigrinata
 Con una hoja dentada
 Avec lame dentée

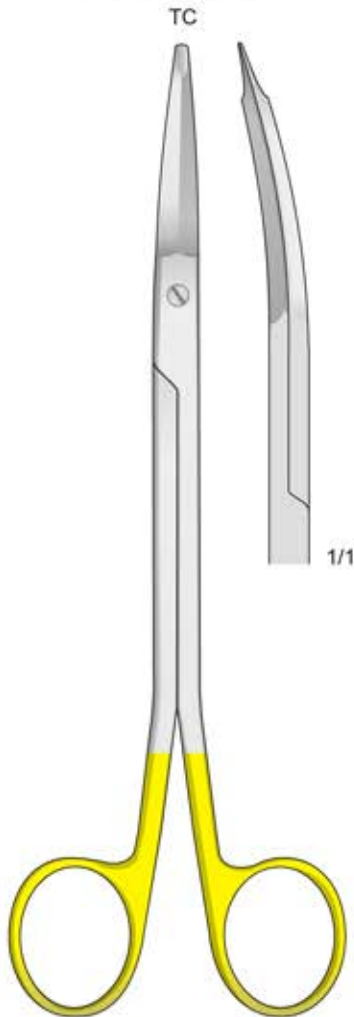

FREEMAN-KAYE
 FM-335
 180 mm

Mit einer Schneide gezahnt
 With one blade serrated
 Con una lama zigrinata
 Con una hoja dentada
 Avec lame dentée

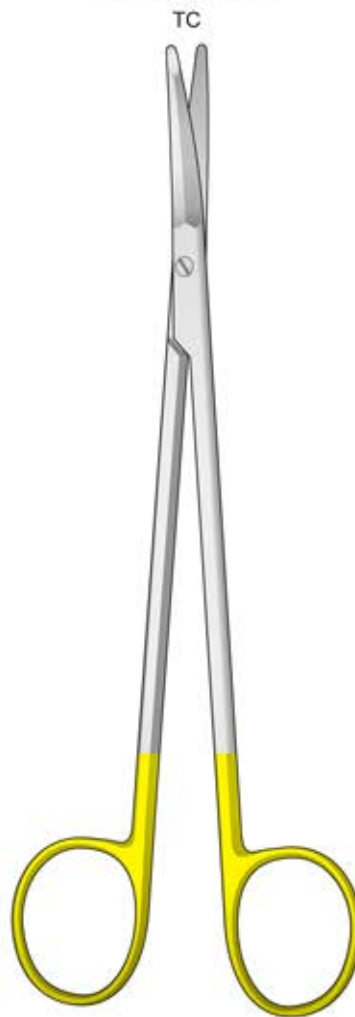

FACE LIFT
 FM-338
 180 mm

Mit einer Schneide gezahnt
 With one blade serrated
 Con una lama zigrinata
 Con una hoja dentada
 Avec lame dentée

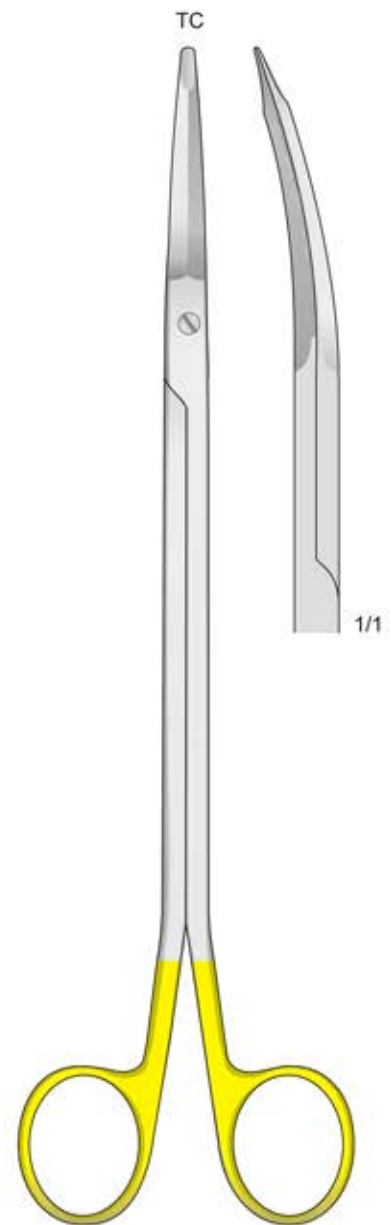

GORNEY
 FM-312
 230 mm

Mit Hartmetalleinsätzen - Tungsten-carbide scissors
 Con punta al carburo di tungsteno - Tijeras de tungsteno - Avec plaquettes en carbure de tungstène

S-Förmig Gebogen
 S-Shaped
 Forma S
 Informa a S
 Forme S

Mit einer Schneide gezahnt
 With one blade serrated
 Con una lama zigrinata
 Con una hoja dentada
 Avec lame dentèle

Mit einer Schneide gezahnt
 With one blade serrated
 Con una lama zigrinata
 Con una hoja dentada
 Avec lame dentèle

Mit einer Schneide gezahnt
 With one blade serrated
 Con una lama zigrinata
 Con una hoja dentada
 Avec lame dentèle



GORNEY
 FM-320/FM-321
 180 mm

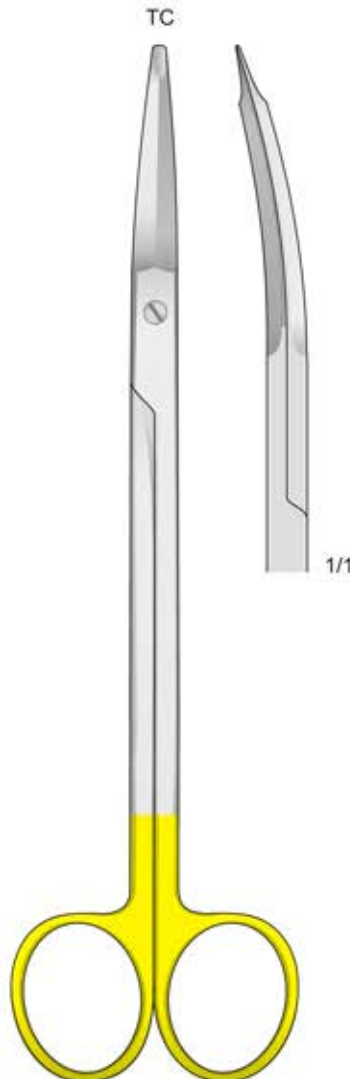

GORNEY
 FM-323
 190 mm

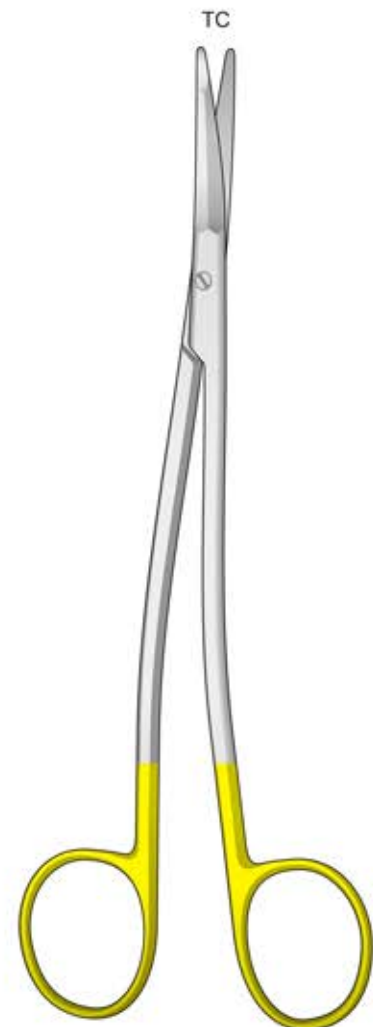

STELLA
 FM-341
 180 mm

Mit Hartmetalleinsätzen - Tungsten-carbide scissors
 Con punta al carburo di tungsteno - Tijeras de tungsteno - Avec plaquettes en carbure de tungstène

Mit einer Schneide gezahnt
 With one blade serrated
 Con una lama zigrinata
 Con una hoja dentada
 Avec lame dentèle

TC

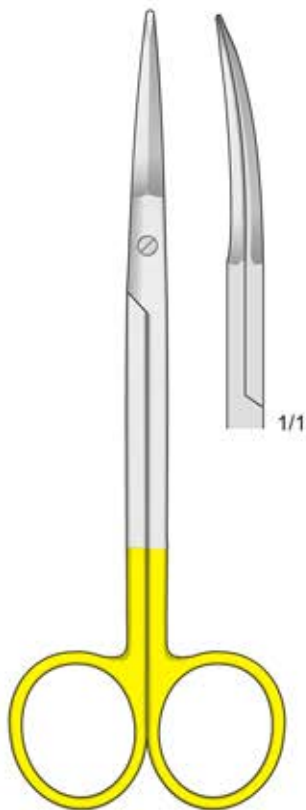

GREGORY
 FM-339
 140 mm

Mit einer Schneide gezahnt
 With one blade serrated
 Con una lama zigrinata
 Con una hoja dentada
 Avec lame dentèle

TC

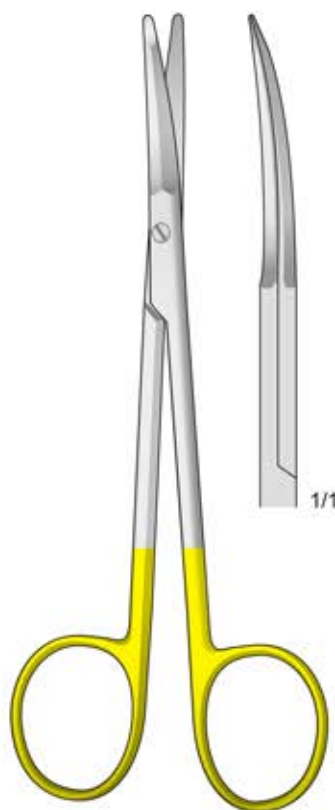

FACE LIFT
 FM-340
 150 mm

Mit einer Schneide gezahnt
 With one blade serrated
 Con una lama zigrinata
 Con una hoja dentada
 Avec lame dentèle

TC

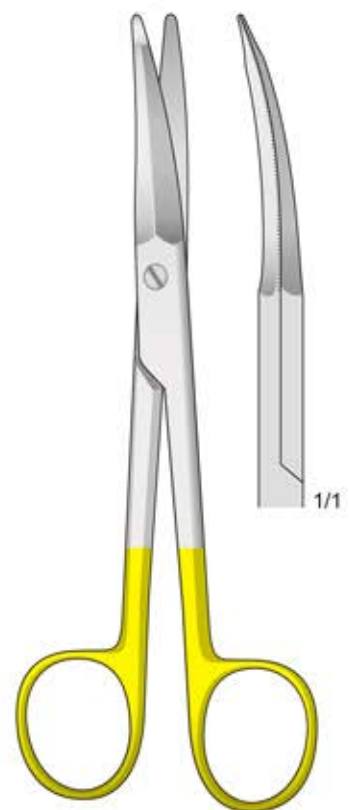

FACE LIFT
 FM-342
 140 mm

Mit Hartmetalleinsätzen - Tungsten-carbide scissors
 Con punta al carburo di tungsteno - Tijeras de tungsteno - Avec plaquettes en carbure de tungstène

Mit einer Schneide gezahnt
 With one blade serrated
 Con una lama zigrinata
 Con una hoja dentada
 Avec lame dentèle

Mit einer Schneide gezahnt
 With one blade serrated
 Con una lama zigrinata
 Con una hoja dentada
 Avec lame dentèle

TC

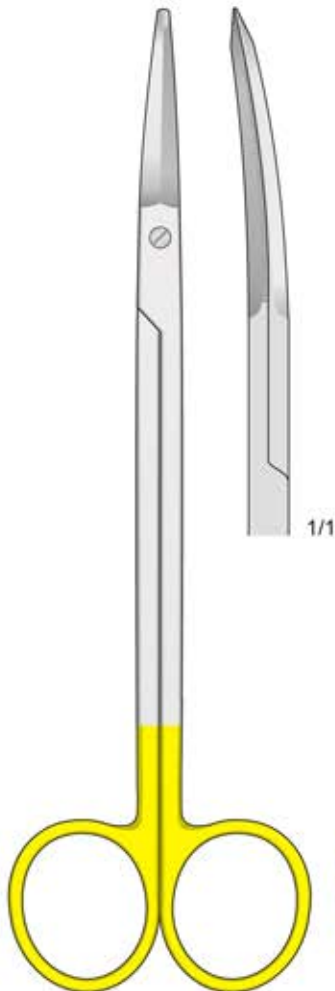

FACE-LIFT
FM-343
180 mm

TC

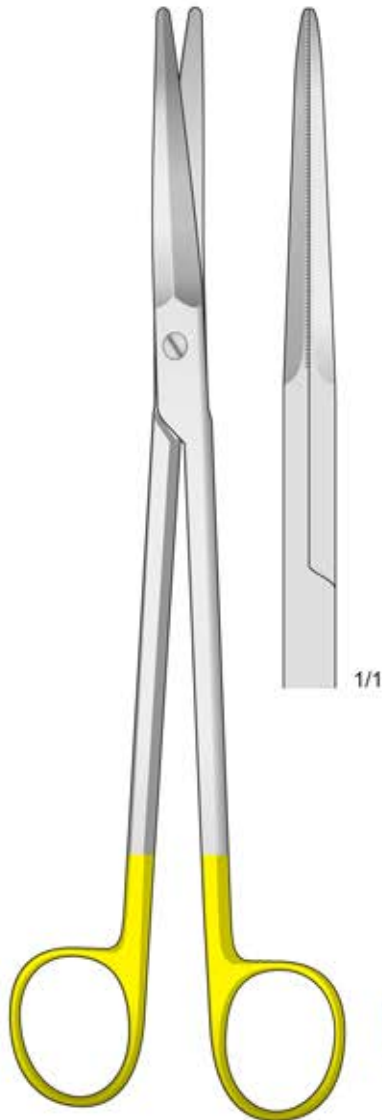

GORNEY
FM-344
200 mm

Mit einer Schneide gezahnt
 With one blade serrated
 Con una lama zigrinata
 Con una hoja dentada
 Avec lame dentèle

TC

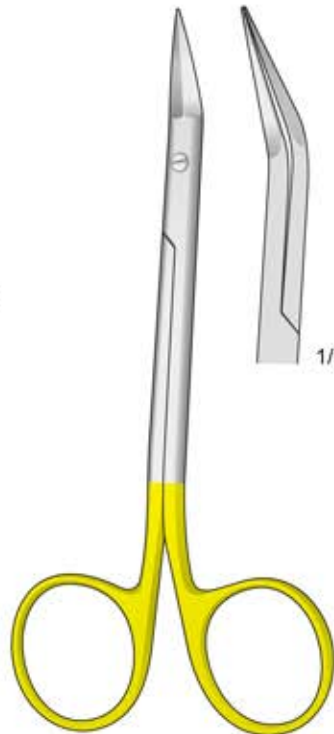

GIUNTA-NASAL
FM-351
130 mm

Super Cut

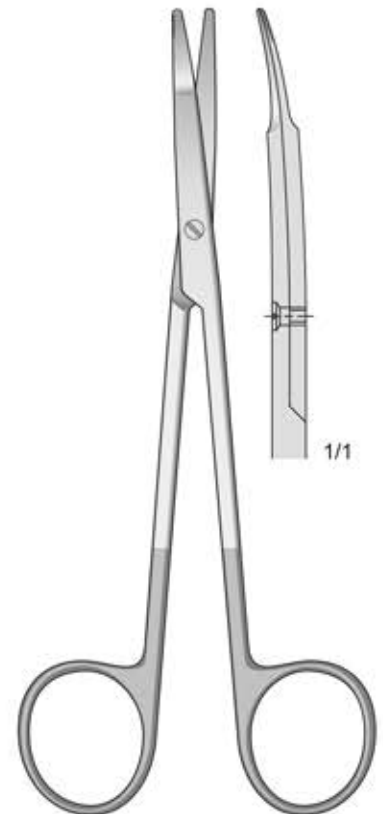

KILNER
FM-305
150 mm

Mit Hartmetalleinsätzen - Tungsten-carbide scissors
 Con punta al carburo di tungsteno - Tijeras de tungsteno - Avec plaquettes en carbure de tungstène

Mit einer Schneide gezahnt
 With one blade serrated
 Con una lama zigrinata
 Con una hoja dentada
 Avec lame dentèle

Super Cut
 TC

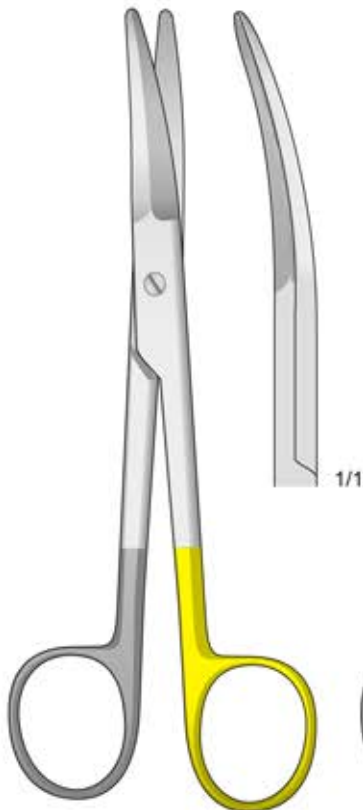

KAYE FACE-LIFT
 FM-306
 150 mm

Mit einer Schneide gezahnt
 With one blade serrated
 Con una lama zigrinata
 Con una hoja dentada
 Avec lame dentèle

Super Cut
 TC

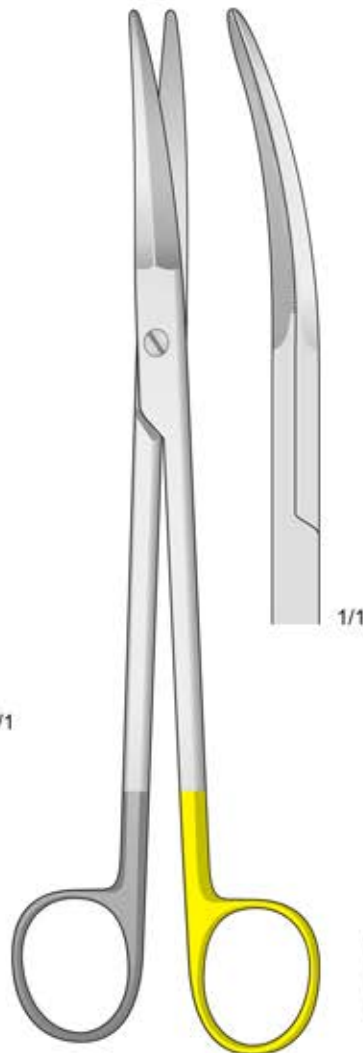

KAYE FACE-LIFT
 FM-307
 190 mm

Mit einer Schneide gezahnt
 With one blade serrated
 Con una lama zigrinata
 Con una hoja dentada
 Avec lame dentèle

Super Cut
 TC

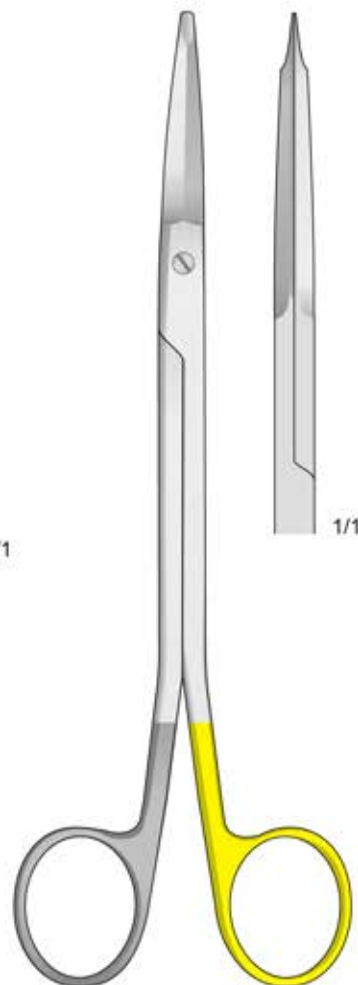

FREEMAN GORNEY
 FM-310
 180 mm

Mit einer Schneide gezahnt
 With one blade serrated
 Con una lama zigrinata
 Con una hoja dentada
 Avec lame dentèle

Super Cut
 TC

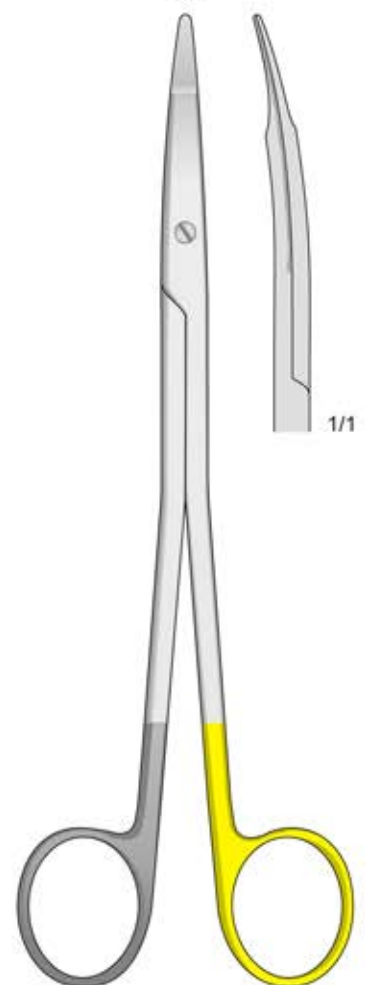

FREEMAN
 FM-330
 180 mm

Mit Hartmetalleinsätzen
Tungsten-carbide scissors
Con punta al carburo di tungsteno
Tijeras de tungsteno
Avec plaquettes en carbure de tungstène

Mit einer Schneide gezahnt
With one blade serrated
Con una lama zigrinata
Con una hoja dentada
Avec lame dentée

Super Cut
TC

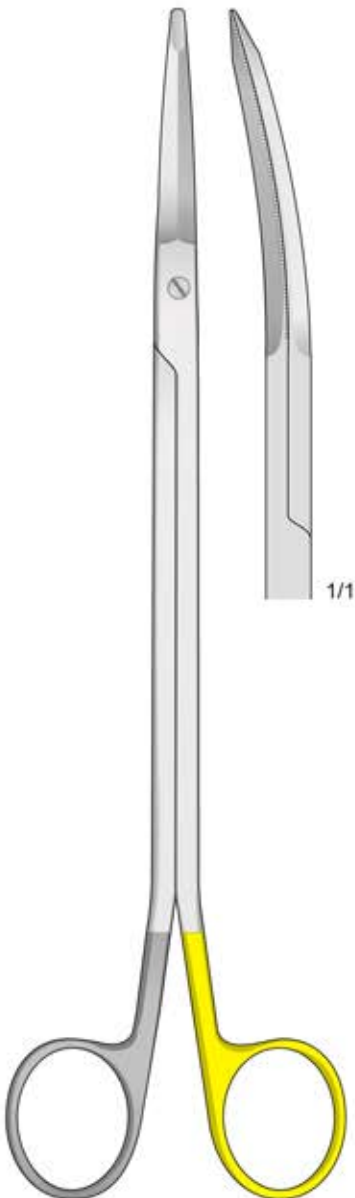

GORNEY
FM-331
230 mm

Mit einer Schneide gezahnt
With one blade serrated
Con una lama zigrinata
Con una hoja dentada
Avec lame dentée

Super Cut

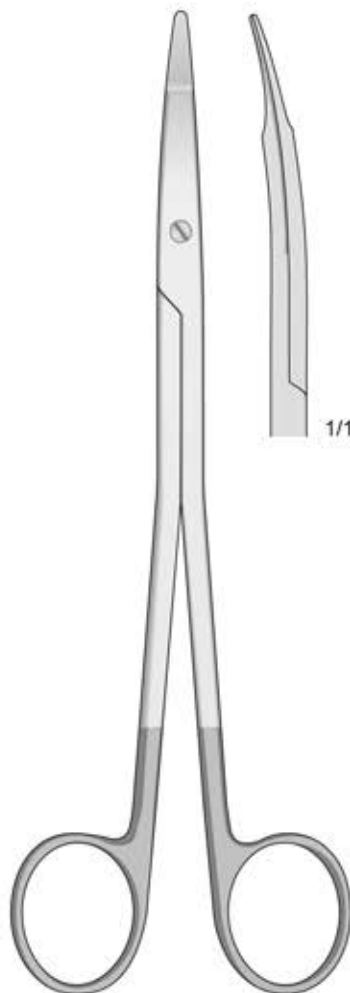

FREEMAN
FM-328
180 mm

Mit Hartmetalleinsätzen
Tungsten-carbide scissors
Con punta al carburo di tungsteno
Tijeras de tungsteno
Avec plaquettes en carbure de tungstène

Mit einer Schneide gezahnt
With one blade serrated
Con una lama zigrinata
Con una hoja dentada
Avec lame dentée

Super Cut
TC

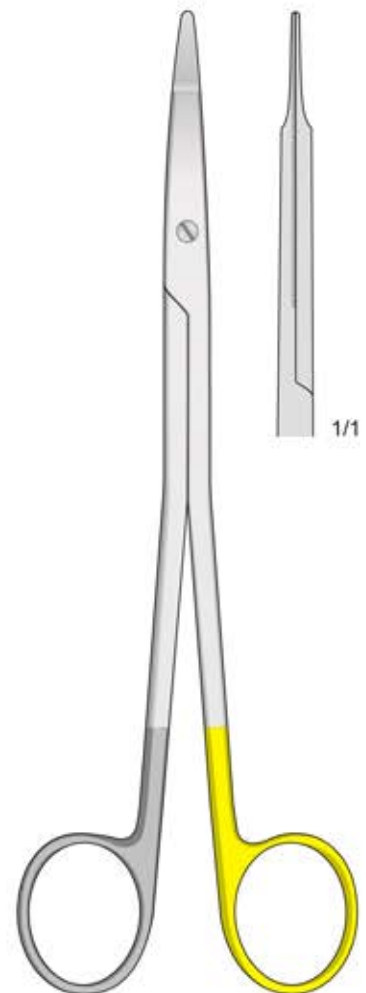

FREEMAN
FM-329
180 mm

Mit Hartmetalleinsätzen - Tungsten-carbide scissors
 Con punta al carburo di tungsteno - Tijeras de tungsteno - Avec plaquettes en carbure de tungstène

Mit einer Schneide gezahnt
 With one blade serrated
 Con una lama zigrinata
 Con una hoja dentada
 Avec lame dentèle

Super Cut
 TC

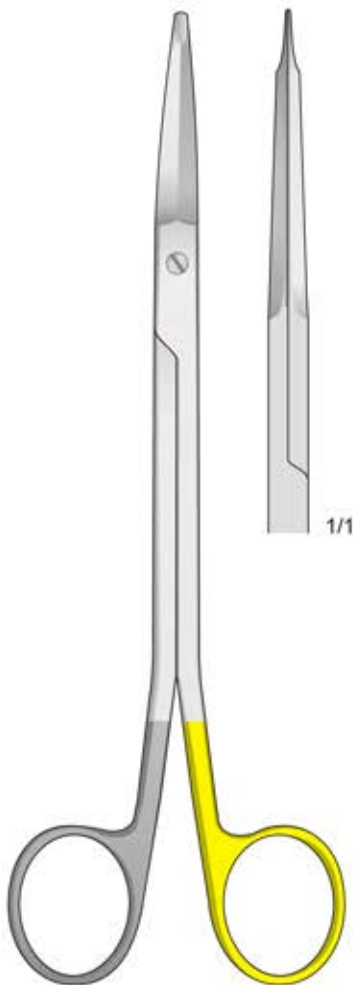

FREEMAN KAYE
 FM-336
 180 mm

Mit einer Schneide gezahnt
 With one blade serrated
 Con una lama zigrinata
 Con una hoja dentada
 Avec lame dentèle

Super Cut
 TC

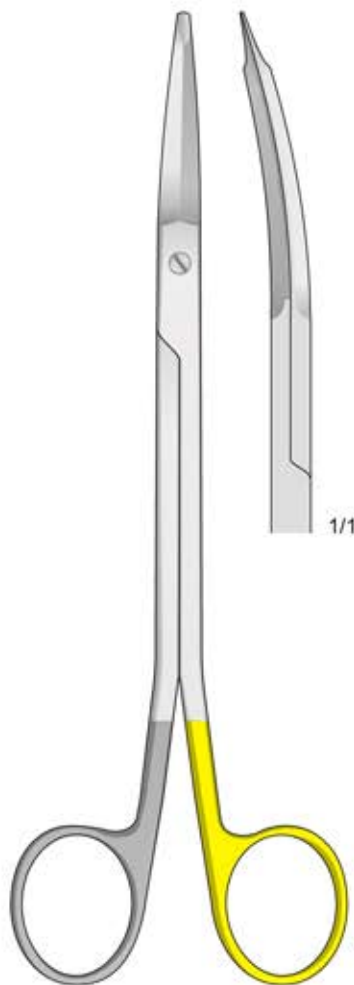

FREEMAN KAYE
 FM-337
 180 mm

Mit einer Schneide gezahnt
 With one blade serrated
 Con una lama zigrinata
 Con una hoja dentada
 Avec lame dentèle

Super Cut
 TC

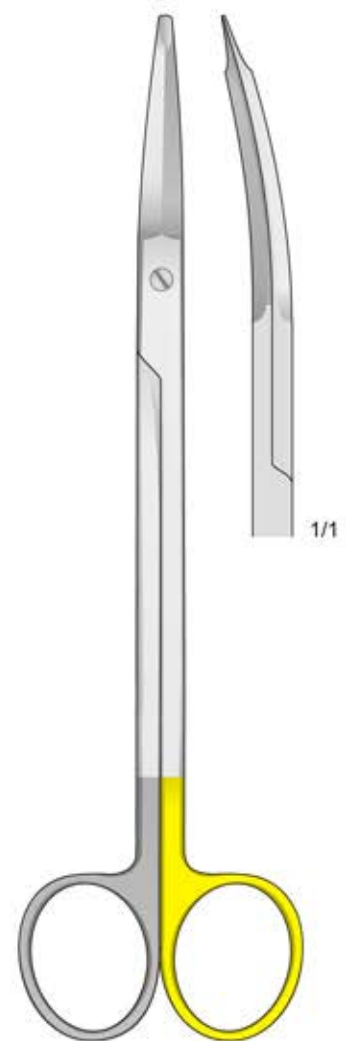

GORNEY
 FM-324
 190 mm



O'BRIEN
FG-151
95 mm

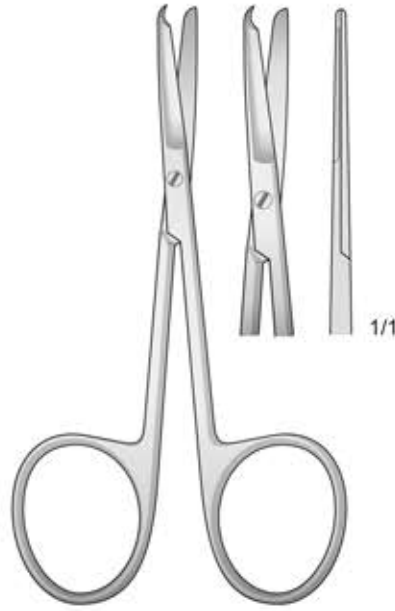

SPENCER
SC-9
90 mm

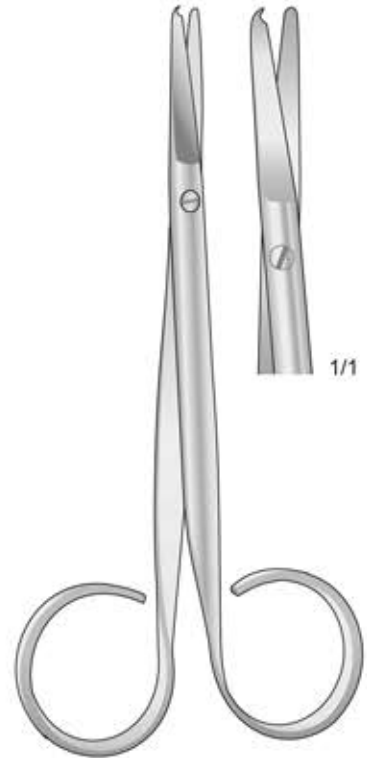

SPENCER
SC-1
110 mm

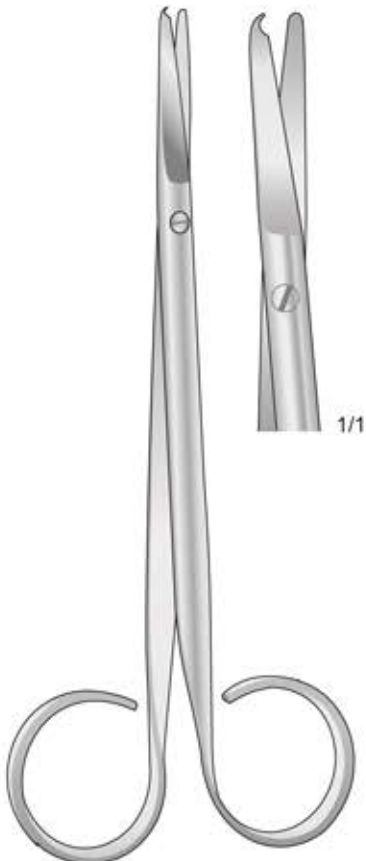

SPENCER
SC-2
145 mm

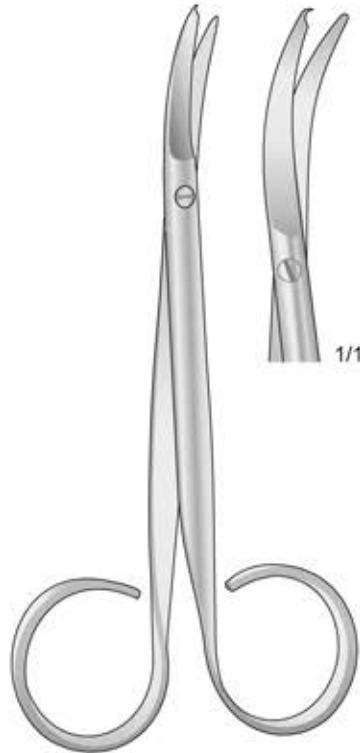

SPENCER
SC-5
110 mm

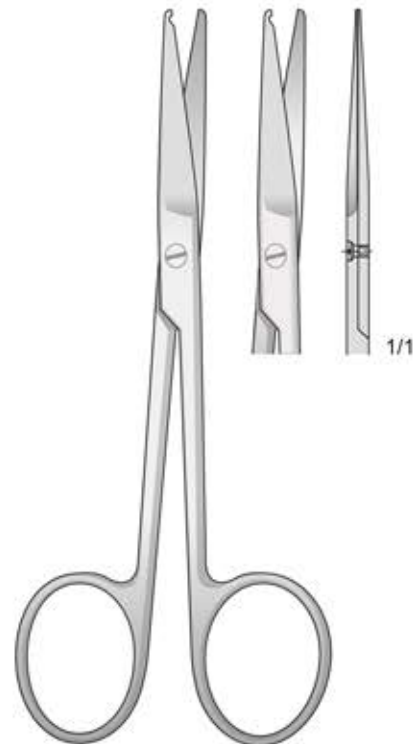

SC-12
115 mm

Nagelscheren

Nail Scissors

Forbici per unghie

Tijeras para hojas

Ciseaux pour les ongles

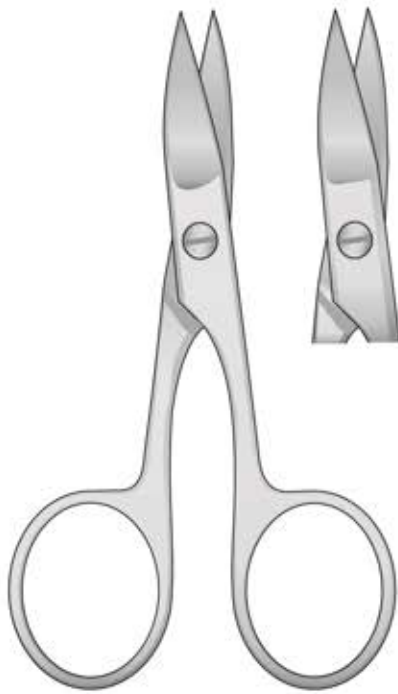

GS-23/GS-26



GS-23
90 mm

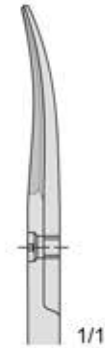

GS-24
90 mm



GS-25
100 mm



GS-26
110 mm

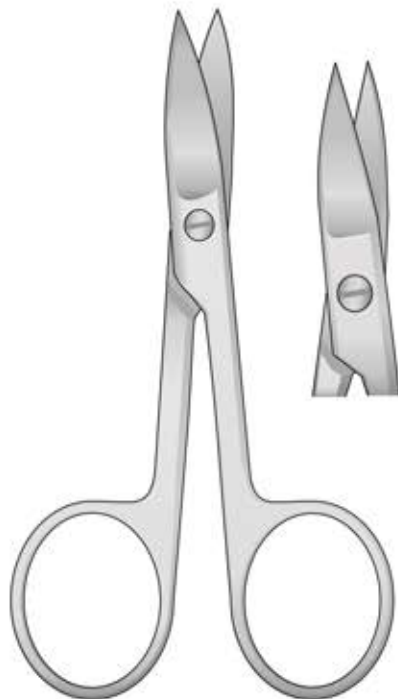

GS-27/GS-29

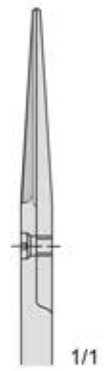

GS-27
95 mm



GS-28
95 mm



GS-29
105 mm



3

Pinzette
Tissue Forceps
Pinzette
Pinzas
Pincas

Mikro Pinzetten

Delicate forceps

Micro pinzette

Pinzas finos

Micro pincas

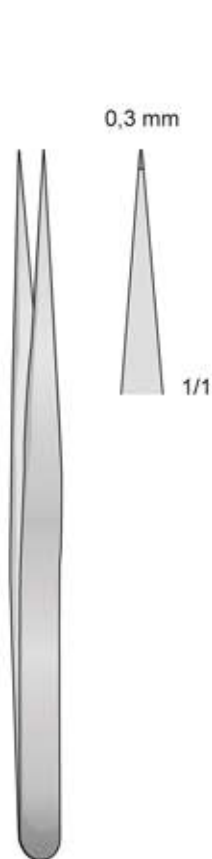

BD-235
120 mm

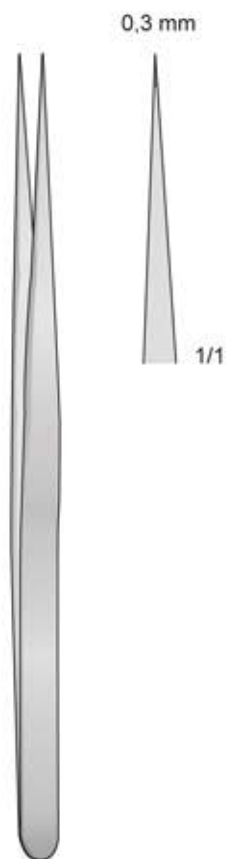

VISE
BD-236
135 mm

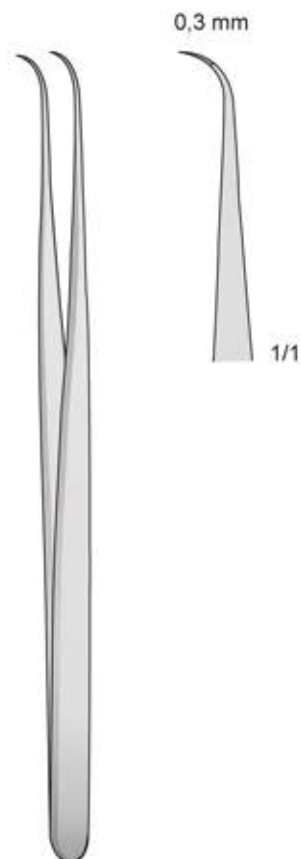

VISE
BD-237
135 mm

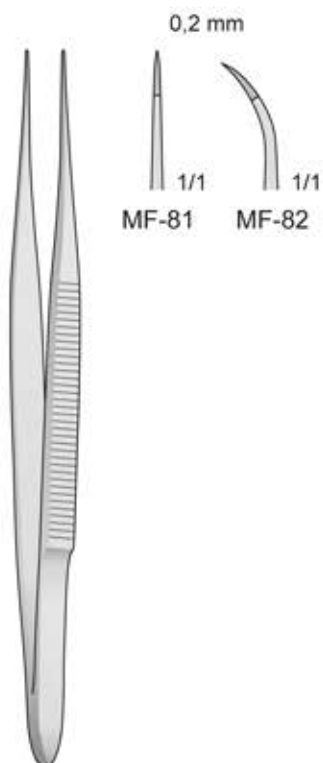

MF-81/MF-82
125 mm

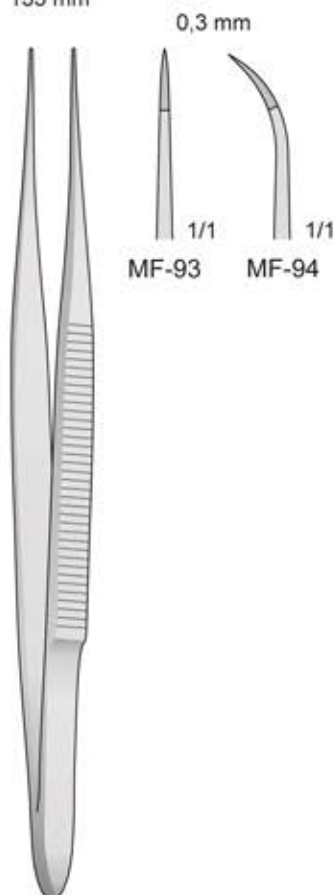

MF-93/MF-94
150 mm

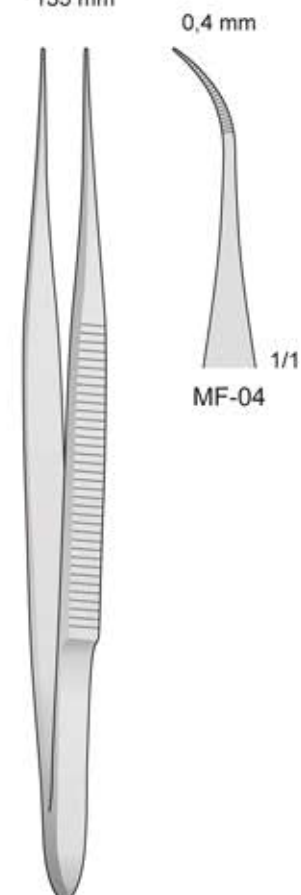

MF-04
150 mm

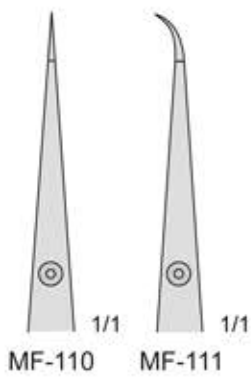

MF-110/MF-111
120 mm

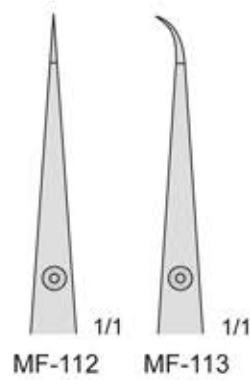

MF-112/MF-113
150 mm

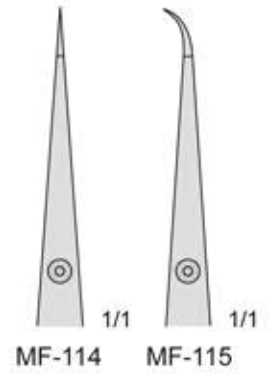

MF-114/MF-115
180 mm

Mikro Pinzetten

Delicate forceps

Micro pinzette

Pinzas finos

Micro pincers

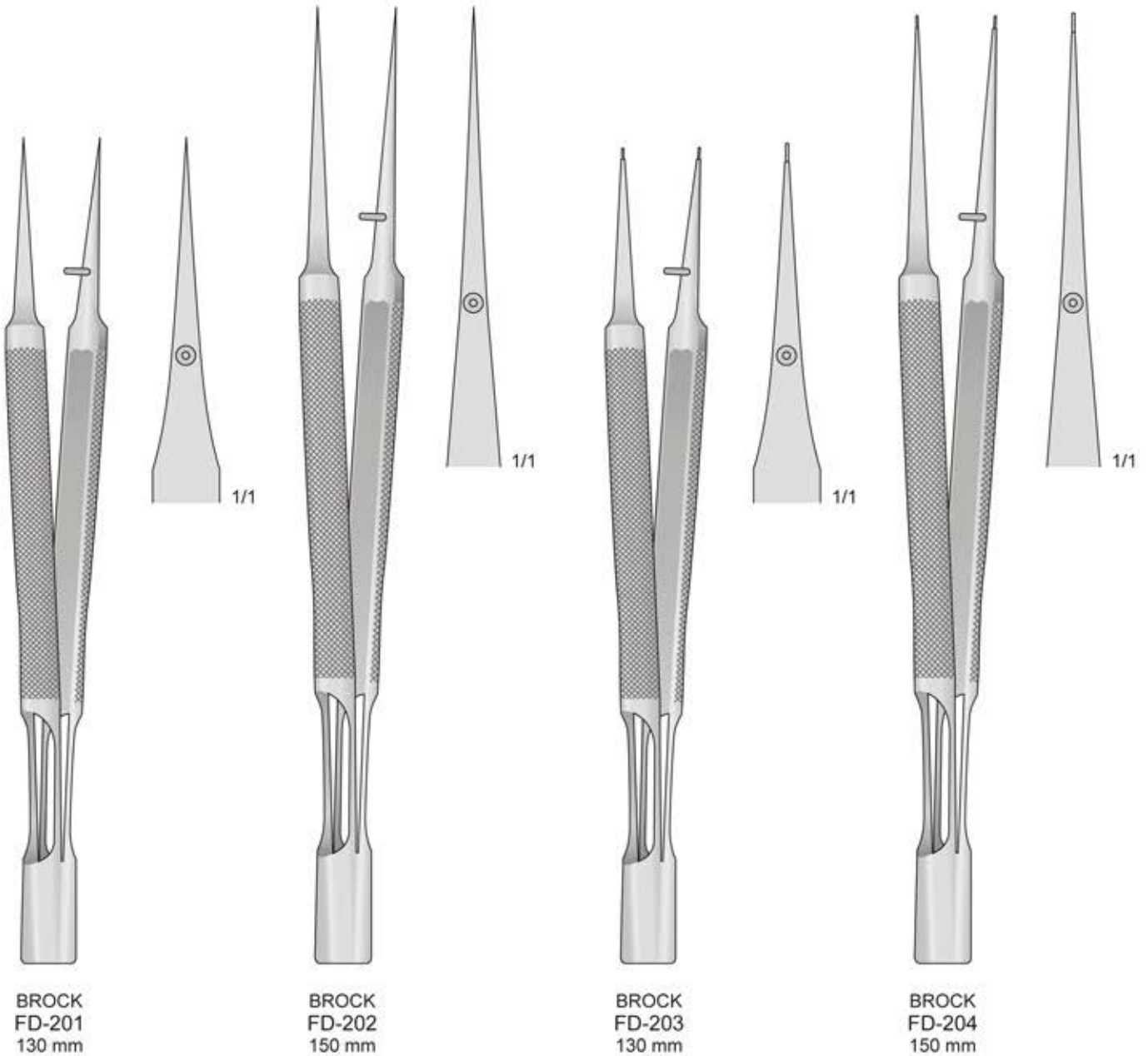
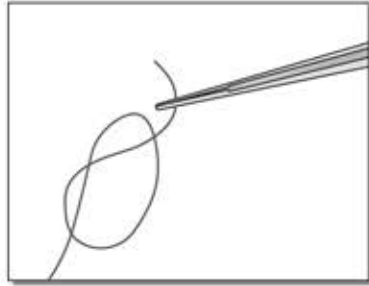

Titan - Titanium - Titanio - Titane

Mikro-Ringpinzette Ø 8 mm

Glatt - Smooth
Liscia - Lisa
Lisses

Gerieft - Serrated
Zigrinata - Estriadas
Stries

1 x 0,5 mm

1 x 0,5 mm



MF-142T
150 mm

MF-342T
150 mm

1 x 0,5 mm

1 x 0,5 mm



MF-143T
180 mm

MF-343T
180 mm



MF-124/MF-149

Ø 1 mm
MF-124 - 150 mm
MF-125 - 180 mm
MF-126 - 210 mm
MF-148 - 230 mm

Ø 2 mm
MF-127 - 150 mm
MF-128 - 180 mm
MF-129 - 210 mm
MF-149 - 230 mm

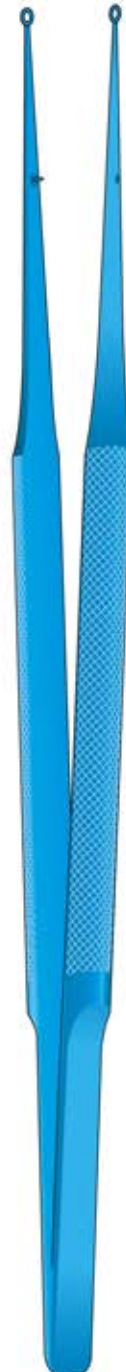

MF-142T/MF-342T

Titan - Titanium - Titanio - Titane

Mikro-Atrauma-Pinzette Ø 8 mm

Atrauma-Standard
1,8 mm



1/1

MF-354T
150 mm

Atrauma-Standard
1,8 mm



1/1

MF-355T
150 mm

Atrauma-Standard
1,8 mm



1/1

MF-356T
180 mm

Atrauma-Standard
1,8 mm



1/1

MF-357T
180 mm

Atrauma-Standard
1,8 mm



1/1

MF-358T
210 mm

Atrauma-Standard
1,8 mm



1/1

MF-359T
210 mm



MF-354T/MF-359T

Mikro-Knüpfpinzette Ø 8 mm

6 x 0,4 mm



1/1

MF-362T
150 mm

6 x 0,4 mm



1/1

MF-363T
150 mm

6 x 0,8 mm



1/1

MF-364T
180 mm

6 x 0,8 mm



1/1

MF-365T
180 mm



MF-362T/MF-365T

Mikro Pinzetten

Delicate forceps

Micro pinzette

Pinzas finos

Micro pincers

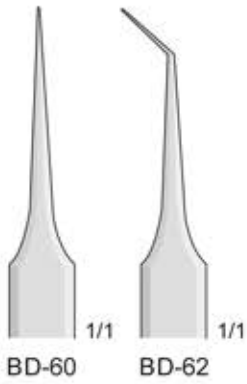

BD-60

BD-62

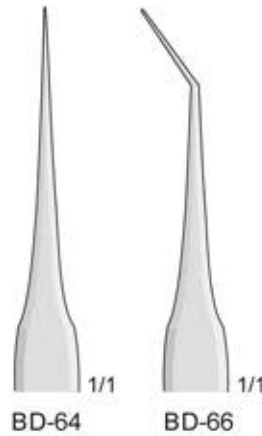

BD-64

BD-66

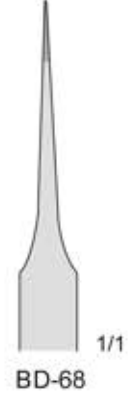

BD-68

BD-60/BD-62
110 mm

BD-64/BD-66
110 mm

BD-68
90 mm

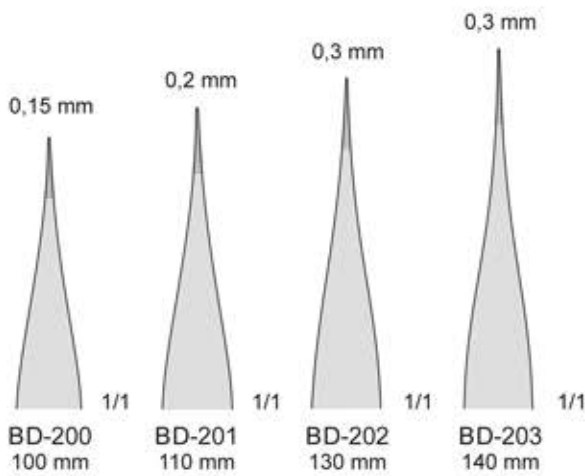

BD-200
100 mm

BD-201
110 mm

BD-202
130 mm

BD-203
140 mm



BD-200/BD-203

BD-205
115 mm

BD-206
115 mm

Feine Pinzetten

Delicate forceps

Pinzette delicate

Pinzas delicadas

Pincas d elicates

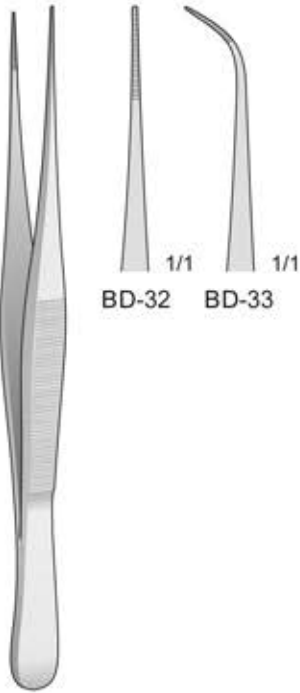

BD-32 BD-33

BD-32/BD-33
100 mm

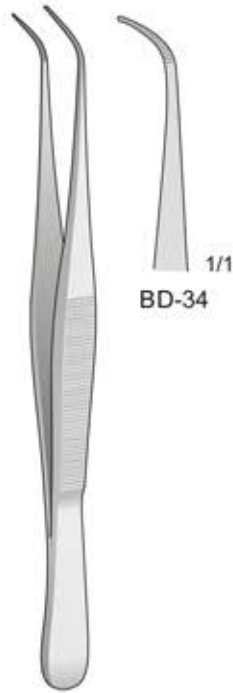

BD-34

BD-34
100 mm

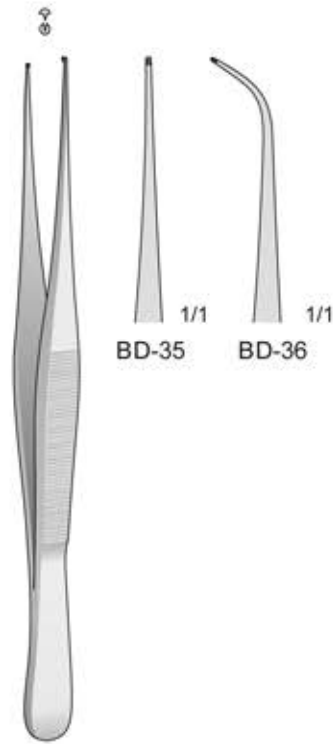

BD-35 BD-36

BD-35/BD-36
100 mm

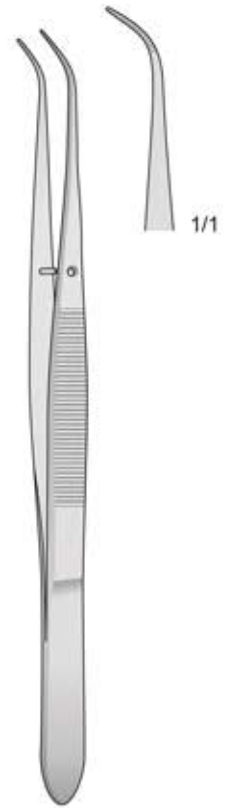

PERRY
BD-05
125 mm



BD-40

BD-40
110 mm

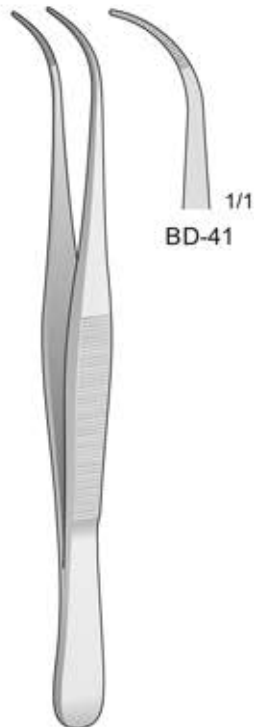

BD-41

BD-41
110 mm

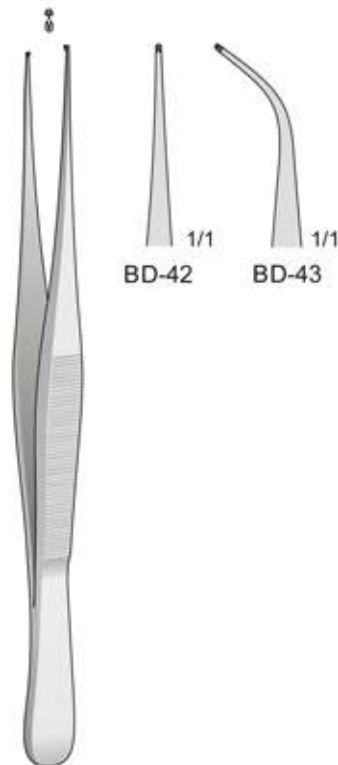

BD-42 BD-43

BD-42/BD-43
110 mm



PERRY
BD-06
125 mm

Chirurgische Pinzetten

Tissue forceps

Pinzette chirurgiche

Pinzas quirúrgicas

Pinces chirurgicales



BD-56/BD-59
100 mm



BD-238
95 mm

1x2 denti
0,2 mm
1/1
BD-238
95 mm

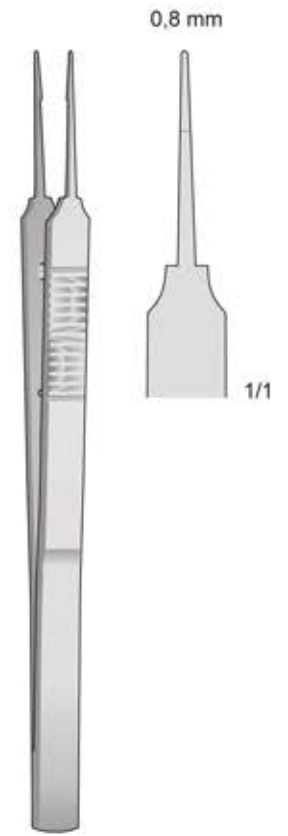

AUSTIN
BD-239
140 mm



GRAEFE
BD-04/BD-96
100 mm

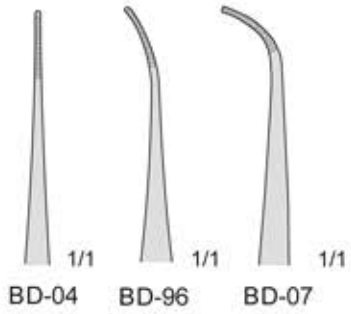

GRAEFE
BD-194/BD-196
100 mm

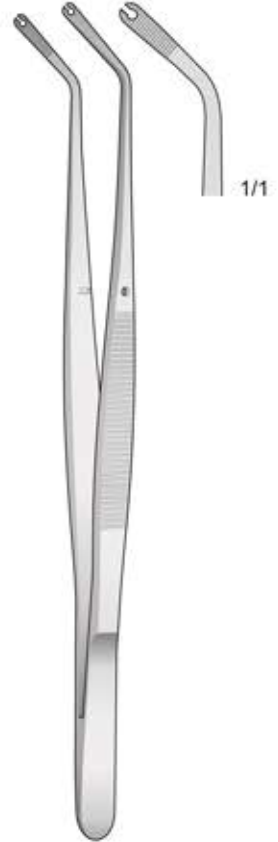
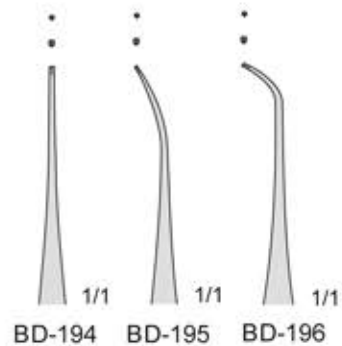

CORN
DA-07
150 mm

Chirurgische Pinzetten

Tissue forceps

Pinzette chirurgiche

Pinzas quirúrgicas

Pinces chirurgicales



BD-145
130 mm



SEMKEN
BD-44
130 mm

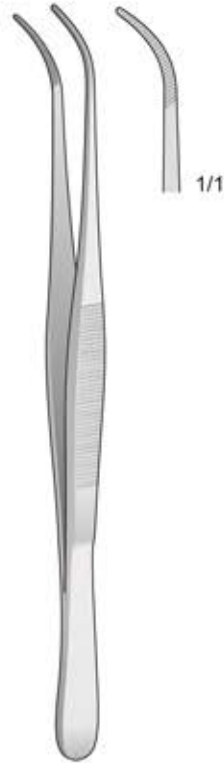

SEMKEN
BD-45
130 mm

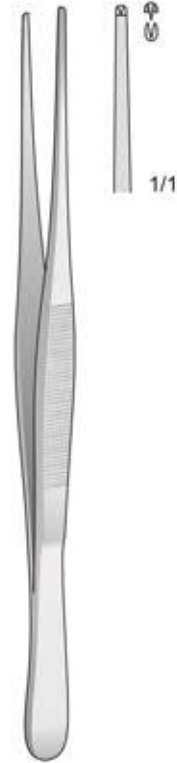

SEMKEN
BD-46
130 mm



SEMKEN
BD-47
130 mm

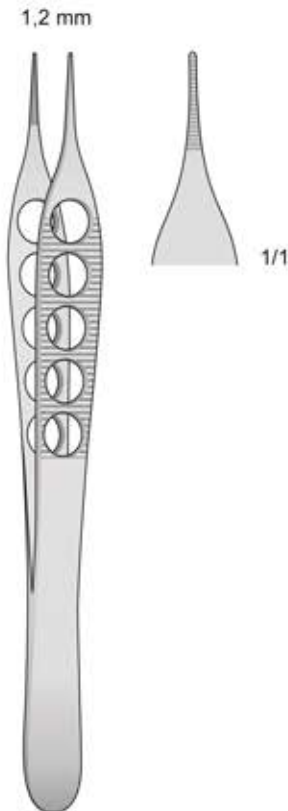

ADSON
BD-207
120 mm

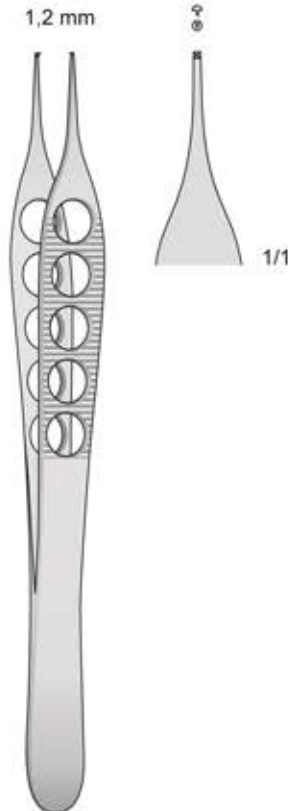

ADSON
BD-208
120 mm

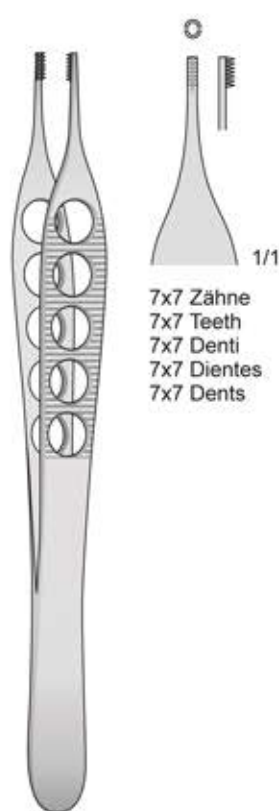

ADSON-BROWN
BD-209
120 mm

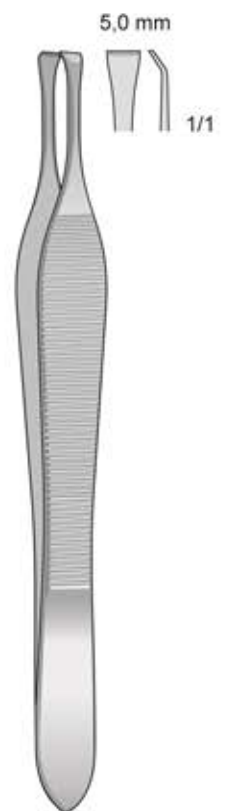

BEASLEY-BABCOCK
BD-51
120 mm

Chirurgische Pinzetten

Tissue forceps

Pinzette chirurgiche

Pinzas quirúrgicas

Pinces chirurgicales

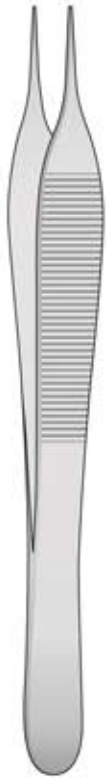

ADSON
BD-30/BD-73

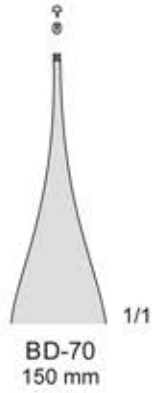
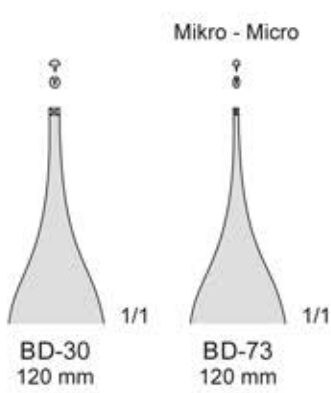

ADSON
BD-31/BD-72

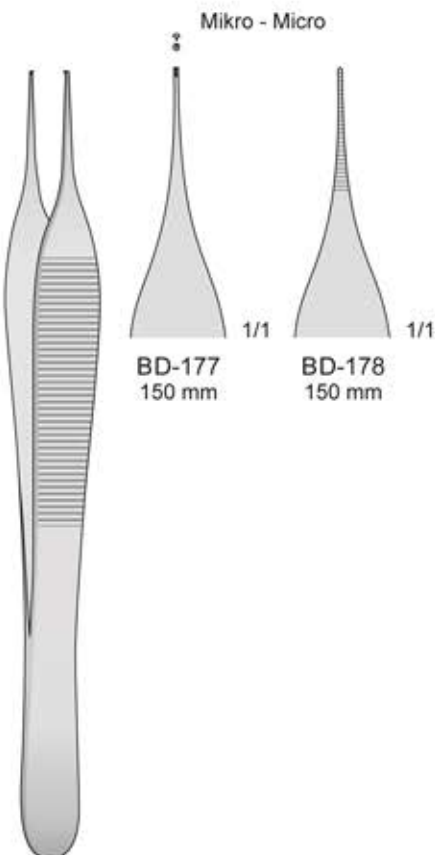
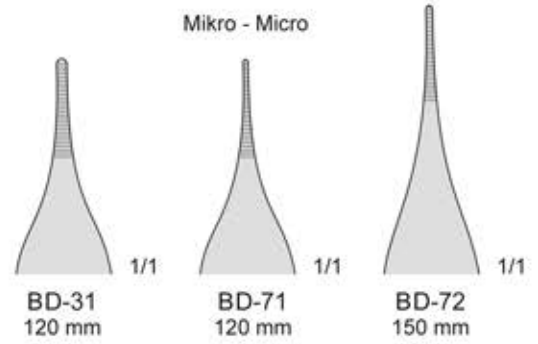

ADSON
BD-177/BD-178
150 mm

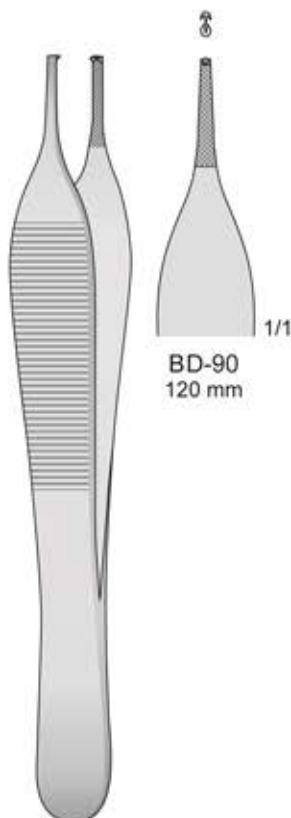

ADSON
BD-90
120 mm



ADSON-BROWN
BD-92/BD-141
120 mm

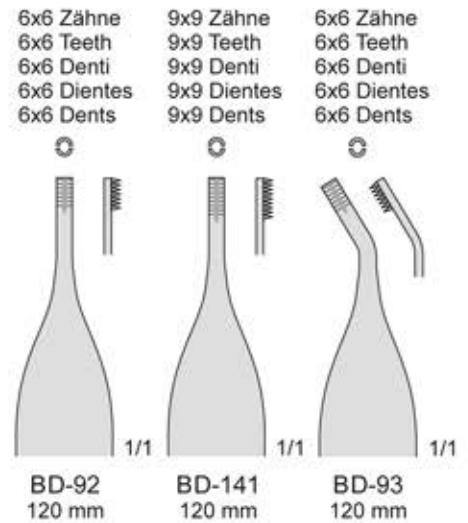

Anatomische Pinzetten

Dressing forceps

Pinzette anatomiche

Pinzas anatómicas

Pinces anatomiques

Standard

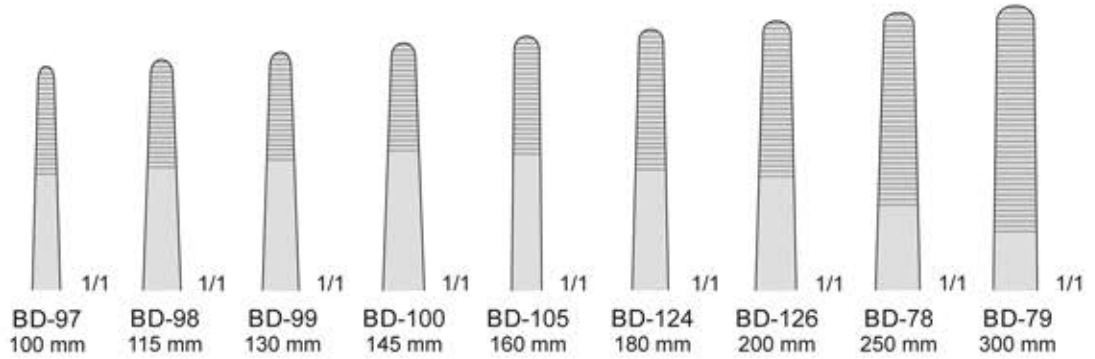

BD-78/BD-126

Mod. Fine

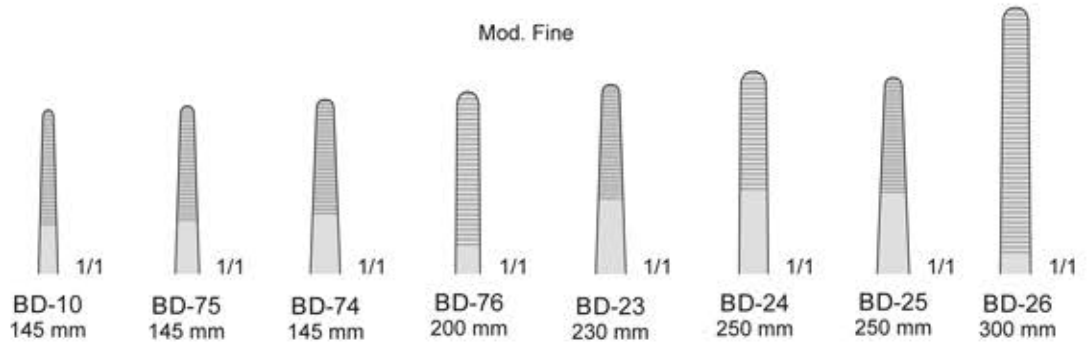

BD-10/BD-76

Anatomische Pinzetten

Dressing forceps

Pinzette anatomiche

Pinzas anatómicas

Pinces anatomiques



STILLE
BD-61/BD-67

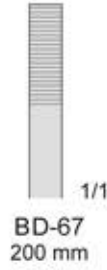
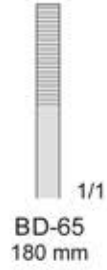
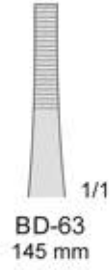
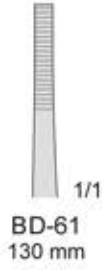

BD-16/BD-148
160 mm

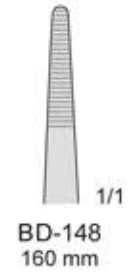
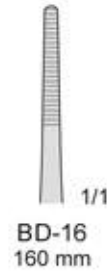

BD-240/BD-249

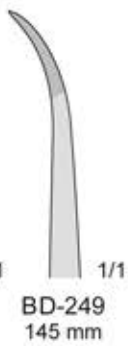
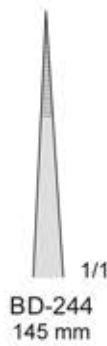
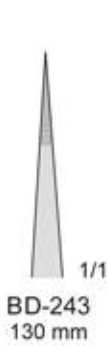

Chirurgische Pinzetten

Tissue forceps

Pinzette chirurgiche

Pinzas quirúrgicas

Pinces chirurgicales



1x2 Zähne
1x2 Teeth
1x2 Denti
1x2 Dientes
1x2 Dents

Standard

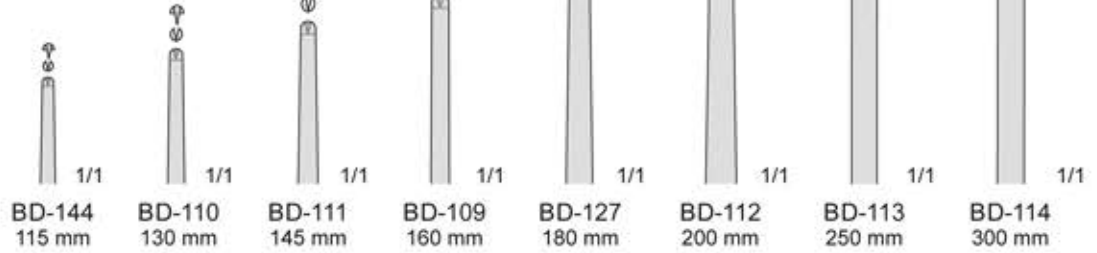

BD-109/BD-144



1x2 Zähne
1x2 Teeth
1x2 Denti
1x2 Dientes
1x2 Dents

Schmal - Narrow - Strette - Estrechas - Étroites

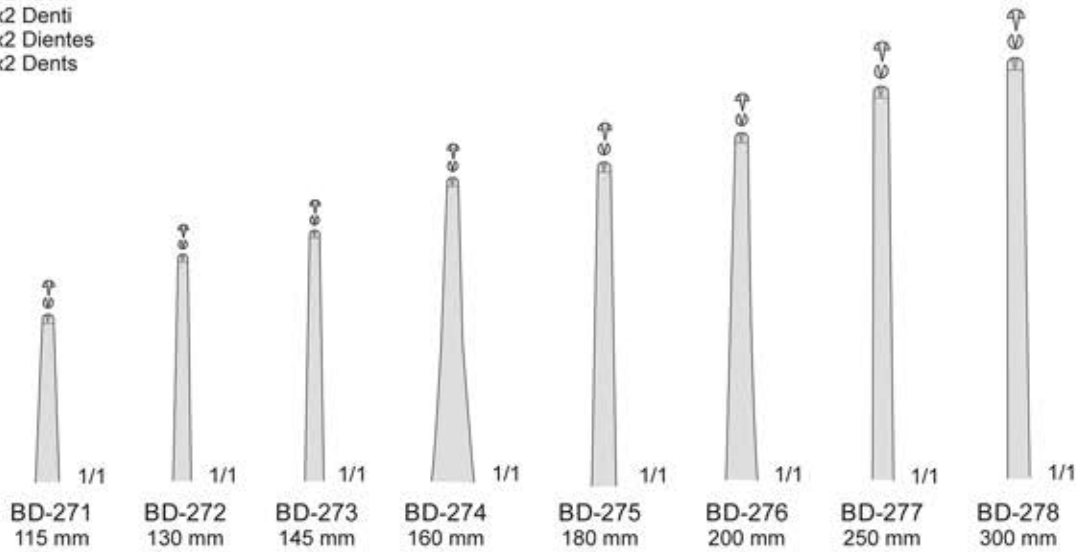

BD-271/BD-278

☐
☐ Schmal - Narrow - Strette - Estrechas - Étroites

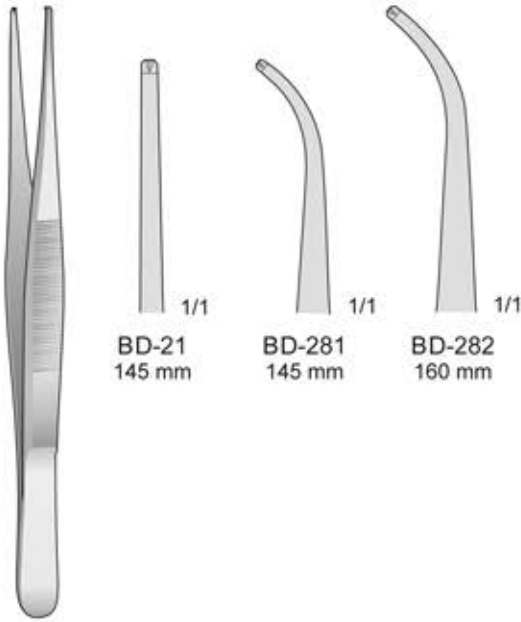

BD-21
145 mm

BD-281
145 mm

BD-282
160 mm

☐
☐ Fein - Delicate - Fine - Finas - Fines

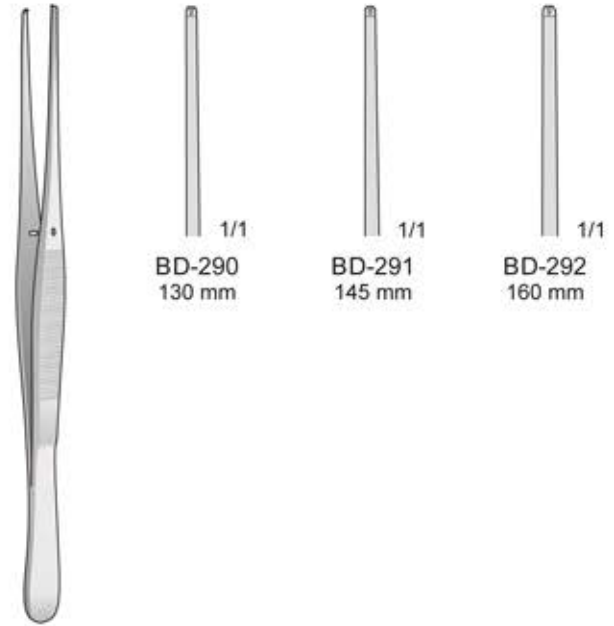

BD-290
130 mm

BD-291
145 mm

BD-292
160 mm

BD-21/BD-282

- 1 x 2 Zähne
- 1 x 2 Teeth
- 1 x 2 Denti
- 1 x 2 Dientes
- 1 x 2 Dents

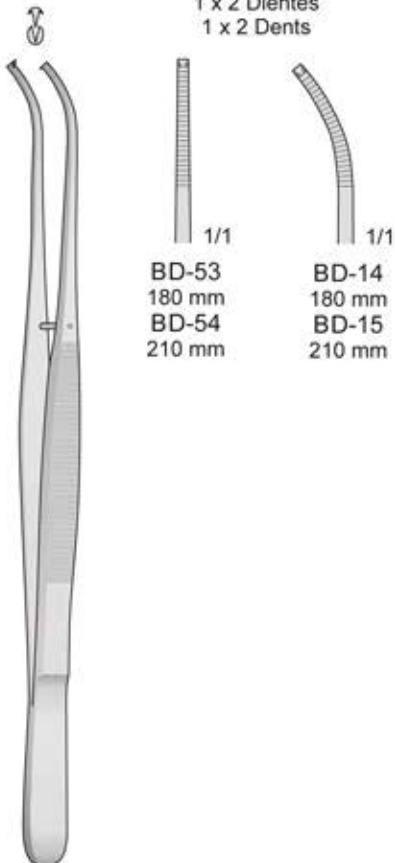

BD-53
180 mm
BD-54
210 mm

BD-14
180 mm
BD-15
210 mm

POTTS-SMITH
BD-14/BD-54

BD-290/BD-292

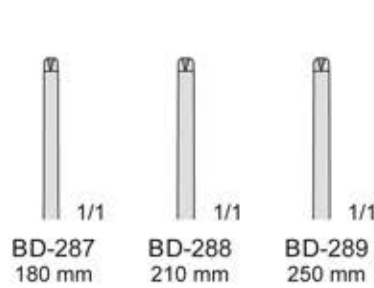

BD-287
180 mm

BD-288
210 mm

BD-289
250 mm

POTTS-SMITH
BD-287/BD-289

- 1 x 2 Zähne
- 1 x 2 Teeth
- 1 x 2 Denti
- 1 x 2 Dientes
- 1 x 2 Dents

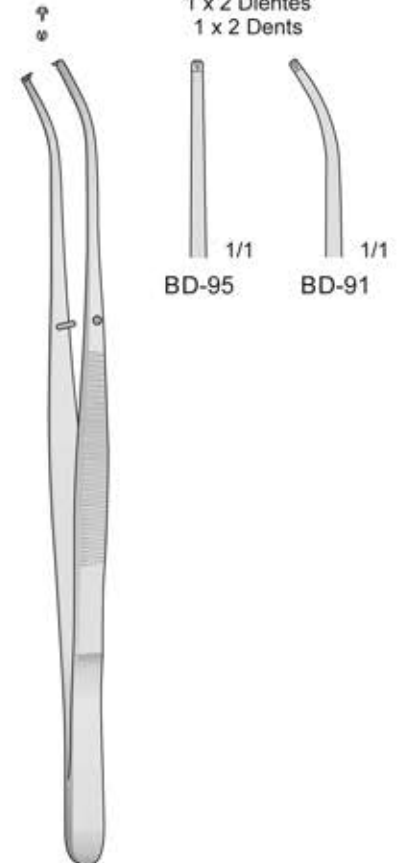

BD-95

BD-91
150 mm

SEMKEN
BD-91/BD-95
150 mm

Chirurgische Pinzetten

Tissue forceps

Pinzette chirurgiche

Pinzas quirúrgicas

Pinces quirúrgicas

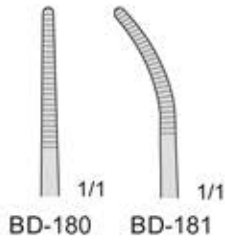

CUSHING
BD-180/BD-181
175 mm

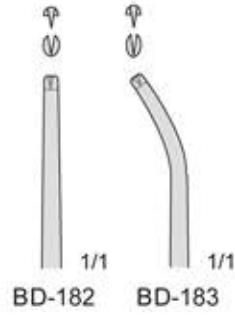

CUSHING
BD-182/BD-183
175 mm

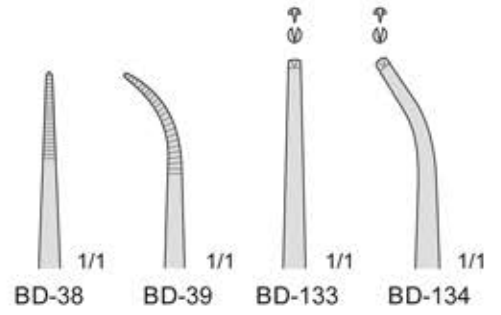

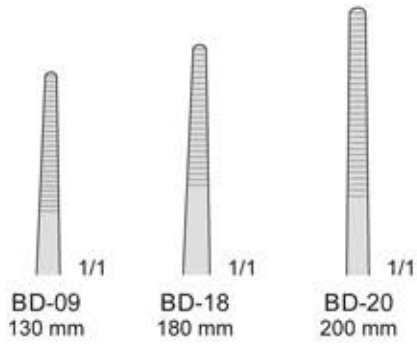

BD-38/BD-134
200 mm

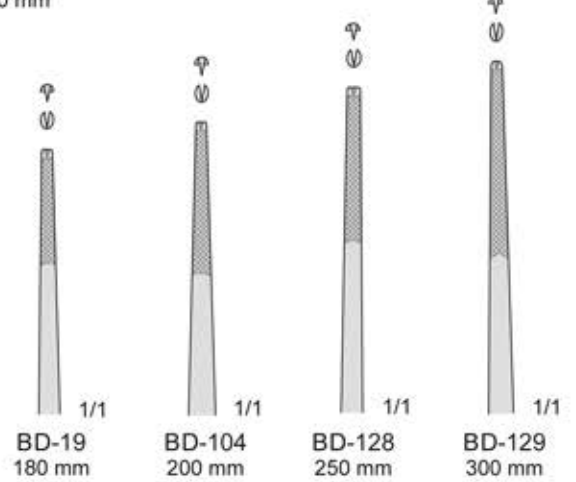

BD-09/BD-20



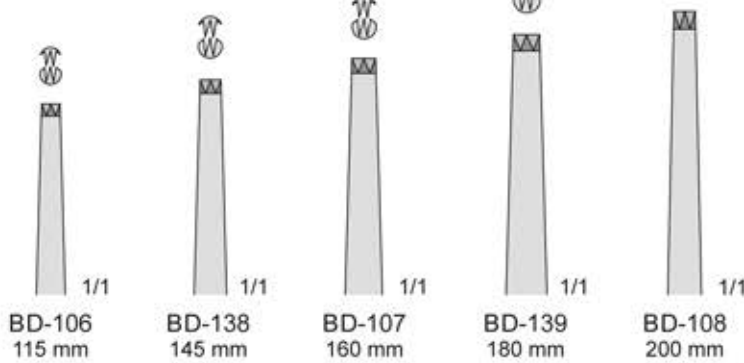

BD-19/BD-129

 2 x 3 Zähne - 2 x 3 Teeth - 2 x 3 Denti
 2 x 3 Dientes - 2 x 3 Dents



BD-106/BD-139

 3 x 4 Zähne - 3 x 4 Teeth - 3 x 4 Denti
 3 x 4 Dientes - 3 x 4 Dents

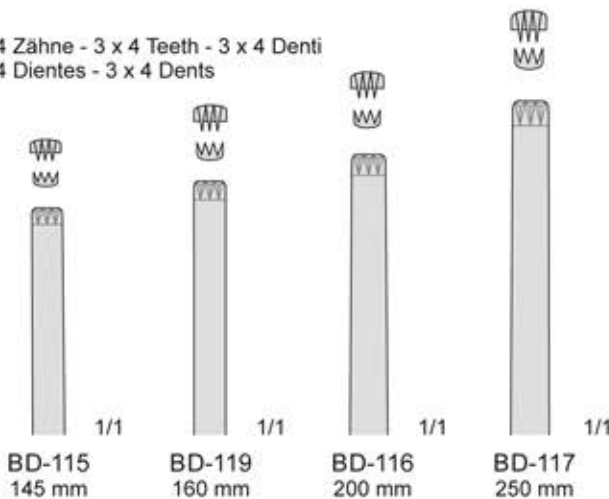

BD-115/BD-119

4 x 5 Zähne
 4 x 5 Teeth
 4 x 5 Denti
 4 x 5 Dientes

 4 x 5 Zähne - 4 x 5 Teeth - 4 x 5 Denti
 4 x 5 Dientes - 4 x 5 Dents

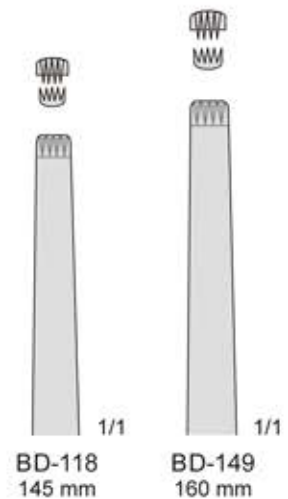

BD-118/BD-149



GERALD
MF-101
180 mm



GERALD
MF-102
180 mm



GERALD
MF-103
180 mm



GERALD
MF-104
180 mm



GERALD-BROWN
MF-105
180 mm

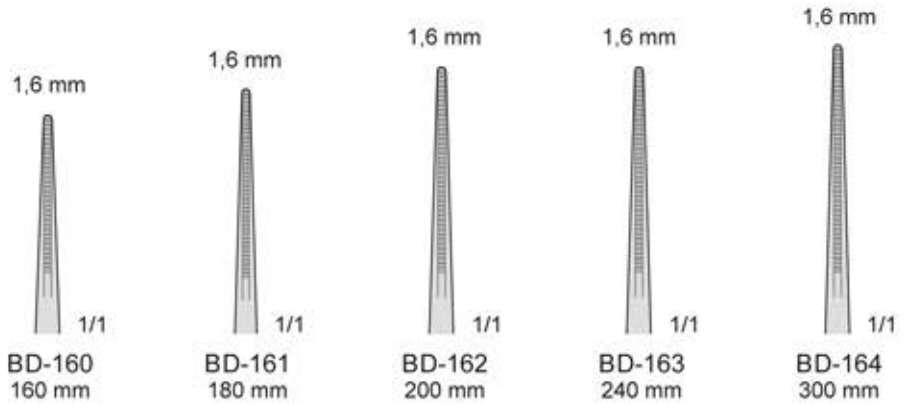

Atraumatische Pinzetten
Atraumatic Forceps
Pinzette atraumatiche
Pinzas atraumáticas
Pinces atraumatiques



DE BAKEY
BD-80/BD-164

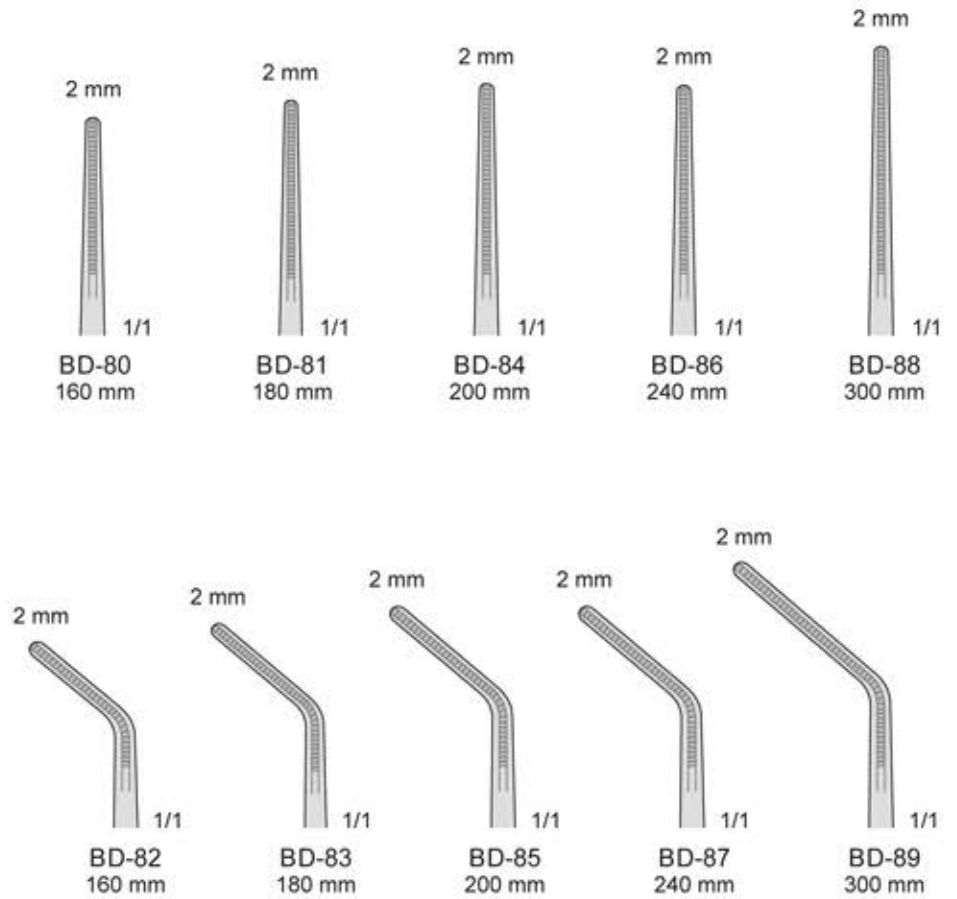



Atraumatische Pinzetten
Atraumatic Forceps
Pinzette atraumatiche
Pinzas atraumáticas
Pinces atraumatiques



DE BAKEY
BD-165/BD-173

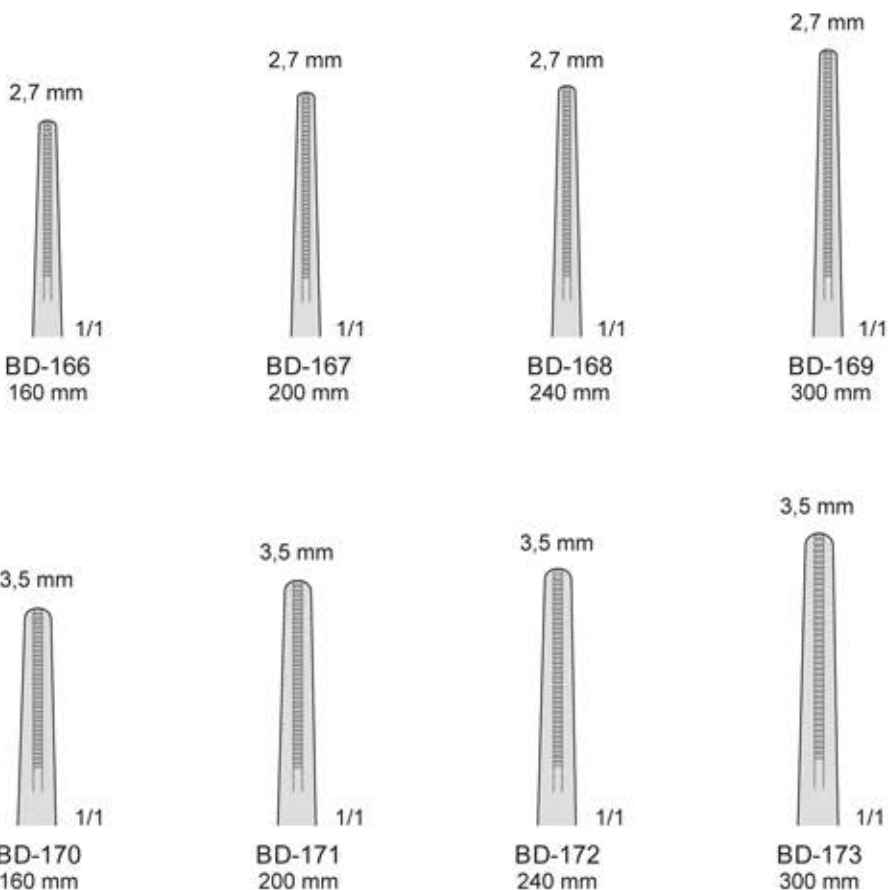

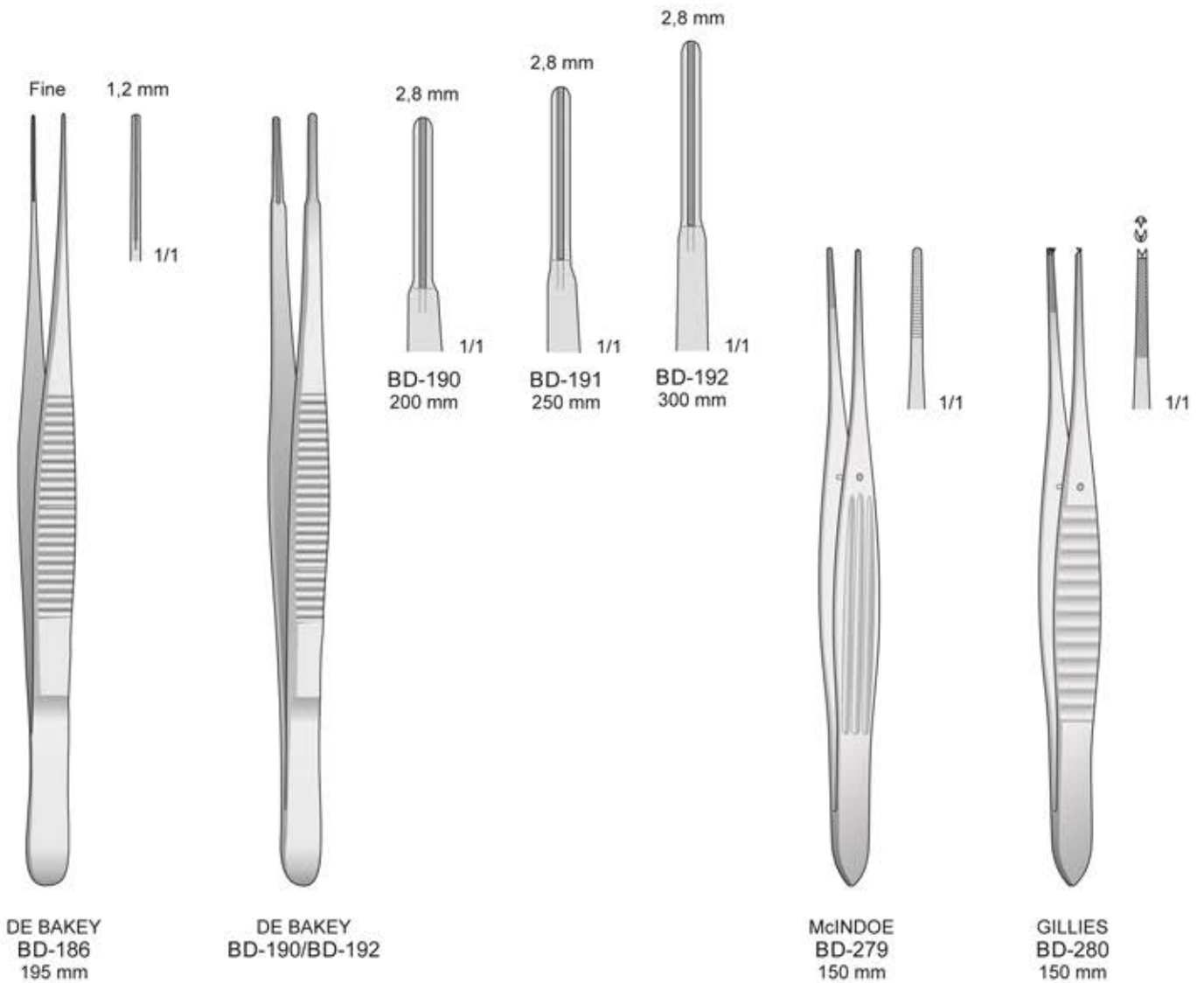

Mikro Pinzetten

Delicate forceps

Micro pinzette

Pinzas finos

Micro pinces

Fixier und Fasspinzetten - Fixation and Grasping forceps
Pinze da Fissazione - Pinzas de fijación y de aprehensión
Pinces pour saisir les tissus

Columella-Klemmen - Columella forceps
Pinzetta-Columella con stop - Pinzas para Columella
Pinces pour Columelle



1/1

GRAEFE
BD-135
110 mm



1/1

GRAEFE
BD-136
110 mm



5 mm



1/1

BD-333



1/1

BD-334

GREEN
BD-333/BD-334
100 mm

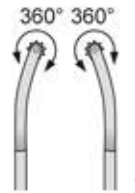

1/1

COTTLE
BD-140
100 mm

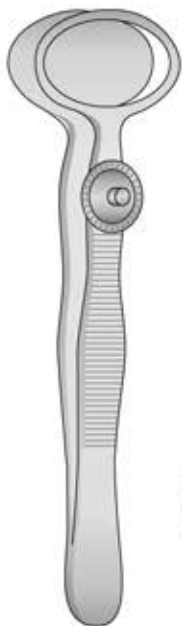
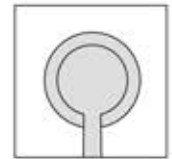
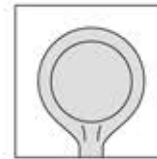
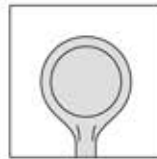

1/1

BD-130
20 mm



1/1

BD-131
26 mm



1/1

BD-132
31 mm

DESMARRES
BD-130/BD-132
90 mm



LAMBERT
BD-260
90 mm



HUNT
BD-261
95 mm



AYERS
BD-263
90 mm

Chirurgische Pinzetten

Tissue forceps

Pinzette chirurgiche

Pinzas quirúrgicas

Pinces chirurgicales

Dressing Forceps
criss-cross serrated tips

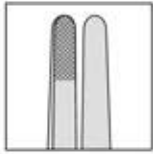

BISHOP-HARMON
MF-175
85 mm

Tissue Forceps
1x2 Teeth

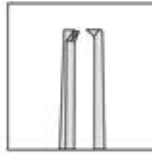

BISHOP-HARMON
MF-176 0.3 mm
MF-177 0.6 mm
85 mm

Iris Forceps
serrated jaws

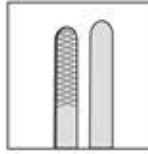

GRAEFE
MF-178 Straight
MF-179 Curved
65 mm

Iris Forceps
1x2 Teeth

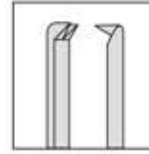

GRAEFE
MF-180 Straight
MF-181 Curved
65 mm

Micro Iris Forceps
straight, ultra fine shanks
with 1x2 teeth, 0,12 mm

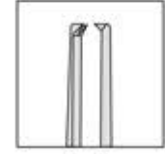

BONN
MF-182 75 mm

Ultra fine 5 mm
Straight



MF-150
100 mm

Suturing Forceps
1x2 teeth of 0,12 mm set at 90°,
extra delicate platform

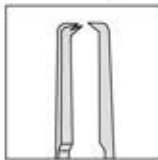

TENNANT
MF-230
100 mm



MC PHERSON
MF-235
105 mm

1x2 curved teeth

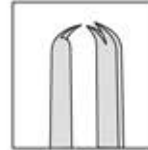

KUHNT
BD-255
110 mm

1x2 angular teeth

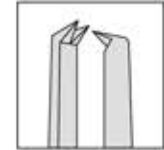

ELSCHNIG
BD-256 0,6 mm
105 mm

Mit Hartmetalleinsätzen - Tungsten-carbide forceps
 Con punta al carburo di tungsteno - Pinzas con tungsteno
 Avec plaquettes en carbure de tungstène

Pinzette mit Häkchen
 Suturing Forceps
 Pinzette per sutura



ADSON
BD-230/BD-231



1/1



1/1



ADSON
BD-250/BD-251



1/1



1/1



ADSON
BD-300
125 mm



BD-210/BD-215

Standard



1/1



1/1



1/1



1/1



1/1



1/1



SEMKEN
BD-216/BD-217



1/1



1/1

Chirurgische Pinzetten

Tissue forceps

Pinzette chirurgiche

Pinzas quirúrgicas

Pinces chirurgicales

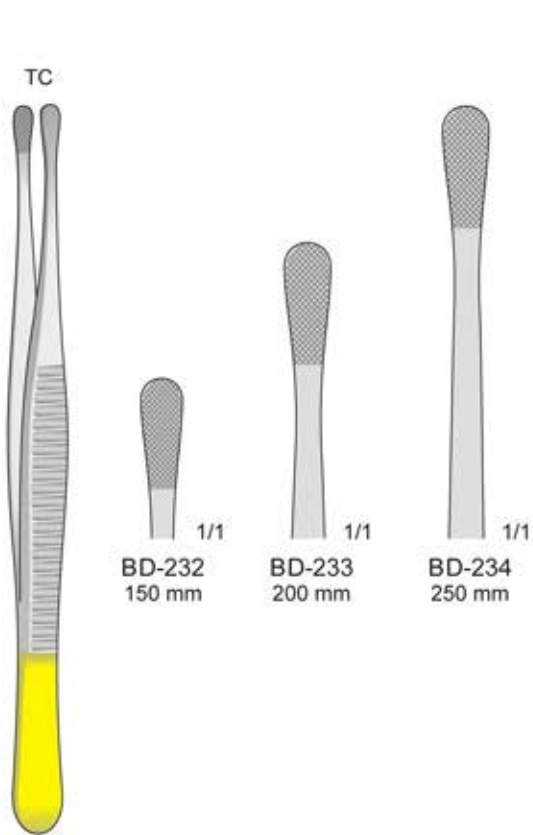

WANGENSTEEN
BD-232/BD-234

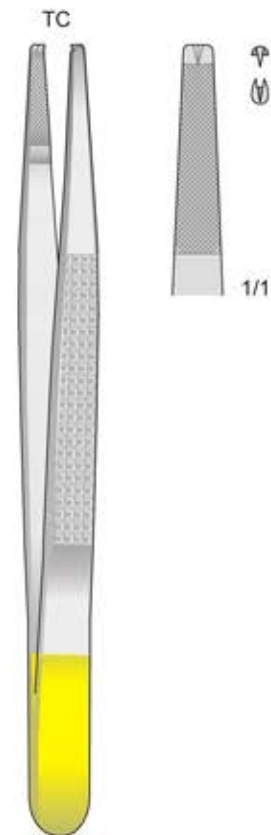

BONNEY
BD-252
180 mm

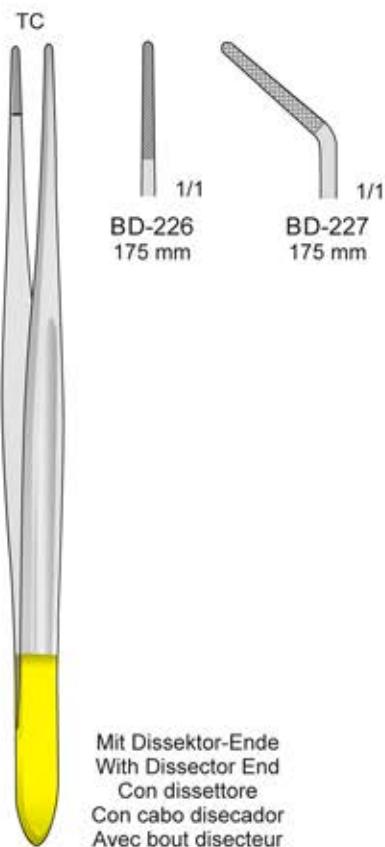

CUSHING
BD-226/BD-227
175 mm

Mit Dissektor-Ende
With Dissector End
Con dissettore
Con cabo disecador
Avec bout disecteur

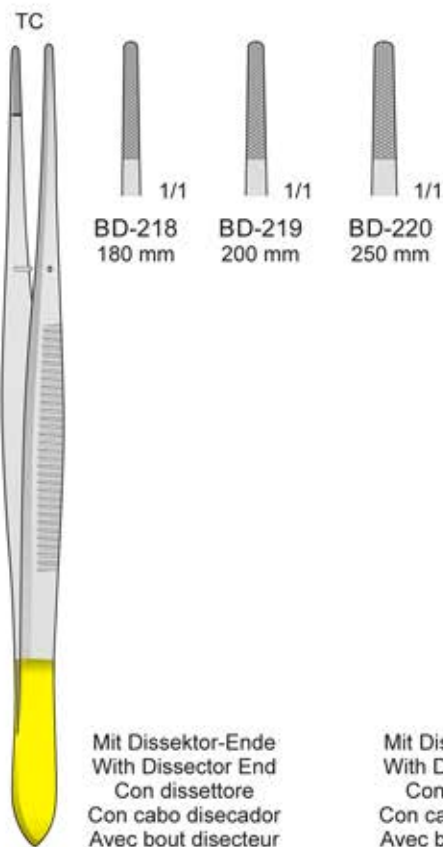

POTTS-SMITH
BD-218/BD-220

Mit Dissektor-Ende
With Dissector End
Con dissettore
Con cabo disecador
Avec bout disecteur

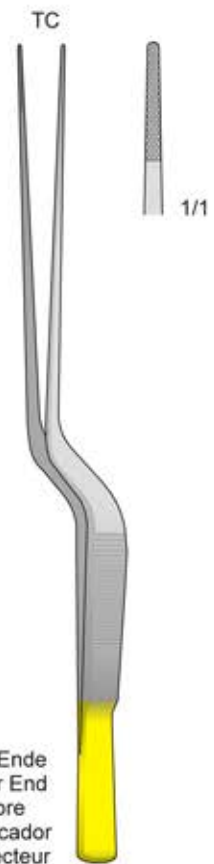





TAYLOR
BD-228
185 mm

Mit Dissektor-Ende
With Dissector End
Con dissettore
Con cabo disecador
Avec bout disecteur

Mit Hartmetalleinsätzen - Tungsten-carbide forceps
 Con punta al carburo di tungsteno - Pinzas con tungsteno
 Avec plaquettes en carbure de tungstène



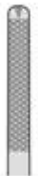







					
1/1	1/1	1/1	1/1	1/1	1/1
BD-221 145 mm	BD-222 160 mm	BD-223 180 mm	BD-224 200 mm	BD-225 250 mm	BD-229 300 mm

BD-221/BD-229

Titan - Titanium - Titanio - Titane



			
1,6 mm	1,6 mm	1,6 mm	1,6 mm
1/1	1/1	1/1	1/1
BD-160T 160 mm	BD-161T 180 mm	BD-162T 200 mm	BD-163T 240 mm
			
2 mm	2 mm	2 mm	2 mm
1/1	1/1	1/1	1/1
BD-80T 160 mm	BD-81T 180 mm	BD-84T 200 mm	BD-86T 240 mm

DE BAKEY
 BD-80T/BD-163T

Titan - Titanium - Titanio - Titane

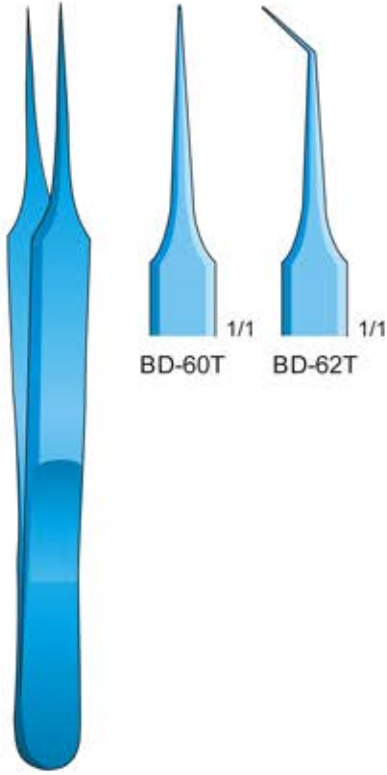

BD-60T/BD-62T
110 mm

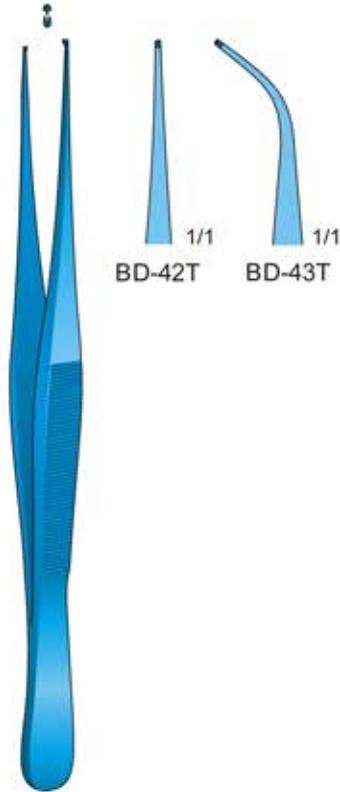

BD-42T/BD-43T
110 mm



BD-09T
130 mm

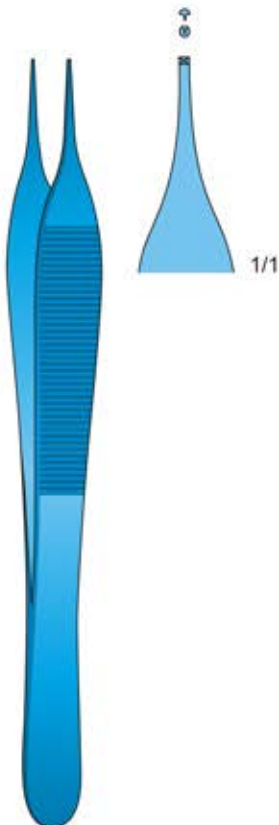

ADSON
BD-30T
120 mm



ADSON
BD-31T
120 mm



BD-75T
145 mm

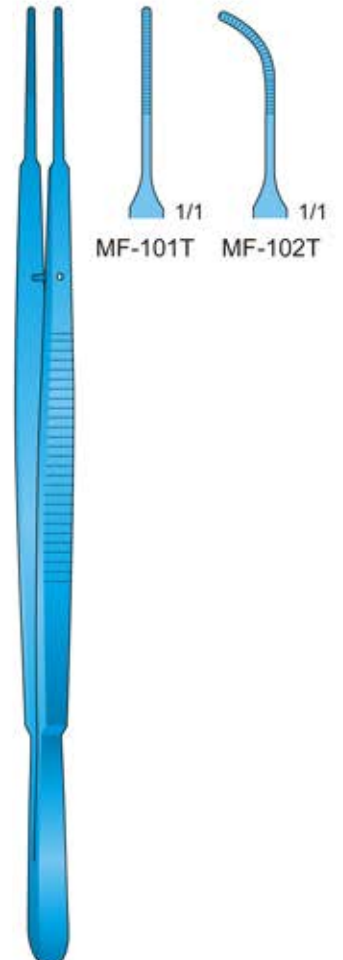

GERALD
MF-101T/MF-102T
180 mm

Ohr Pinzetten

Ear forceps

Pinzette auricolari

Pinzas auriculares

Pinces auriculaires



TROELTSCH
BD-22
110 mm



TROELTSCH
BD-146
110 mm

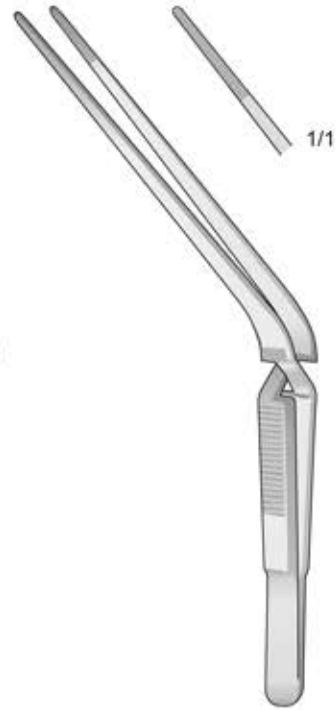

TROELTSCH
BD-179
130 mm



LUCAE
BD-147
140 mm



LUCAE
BD-101
140 mm



JANSEN
BD-102
160 mm



GRÜNWARD
BD-193
200 mm

Cilienpinzetten

Cilia forceps

Pinzette Depilatorie

Pinzas depilatorias

Pinces à épiler les cils

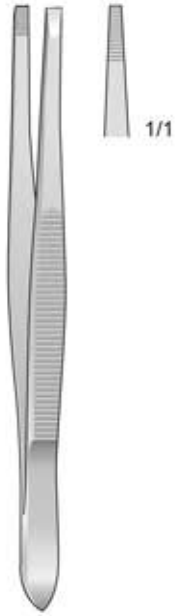

ES-45
90 mm

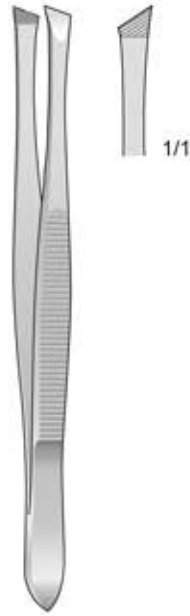

ES-46
90 mm

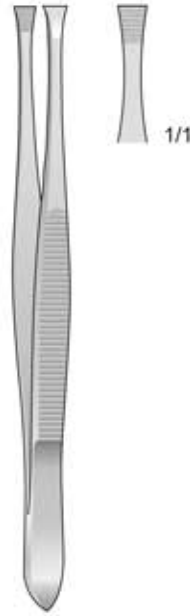

LITTAUER
ES-64
85 mm

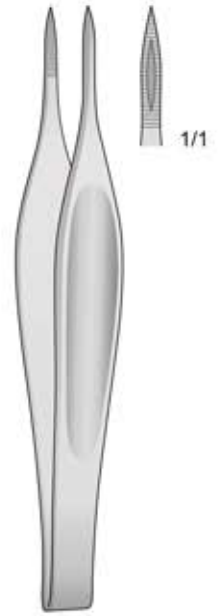

FEICHENFELD
BD-122
90 mm

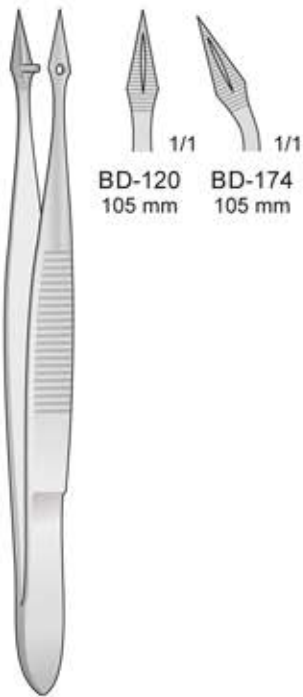
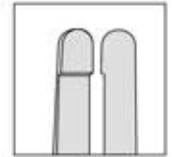
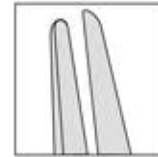
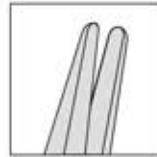

HUNTER
BD-120/BD-174



FEICHENFELD
BD-123
115 mm



BEAUPRE
FD-117
110 mm

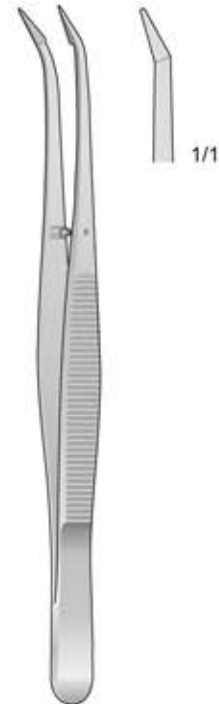

BARRAQUER
ES-65
105 mm

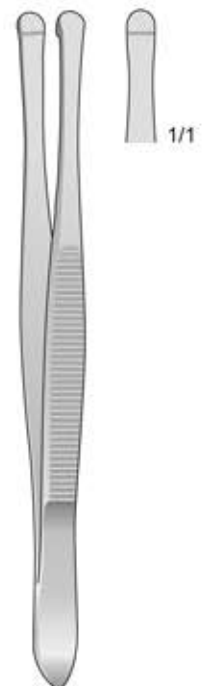

BEER
ES-48
90 mm

4

Arterienklemmen, Drahtumföhrungsnadel
Hemostatic Forceps, Wire guides
Pinze emostatiche, Passafili
Pinzas hemostáticas, Agujas para ligadura
Pinces hémostatiques, Cerclage instruments

Demarcator

Face-Lift Klemmen
Face-Lift Forceps
Pinze per Face-Lift
Pinzas para Face-Lift
Pincés pour Face-Lift

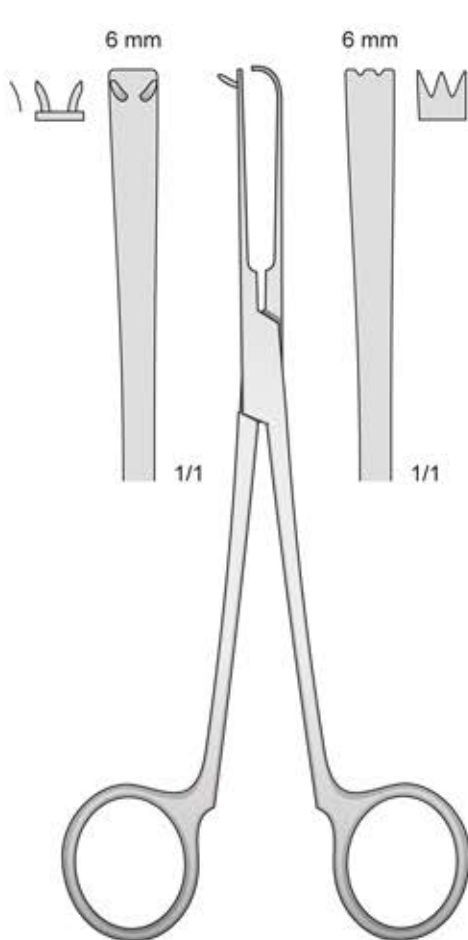

PITANGUI
ES-200
165 mm

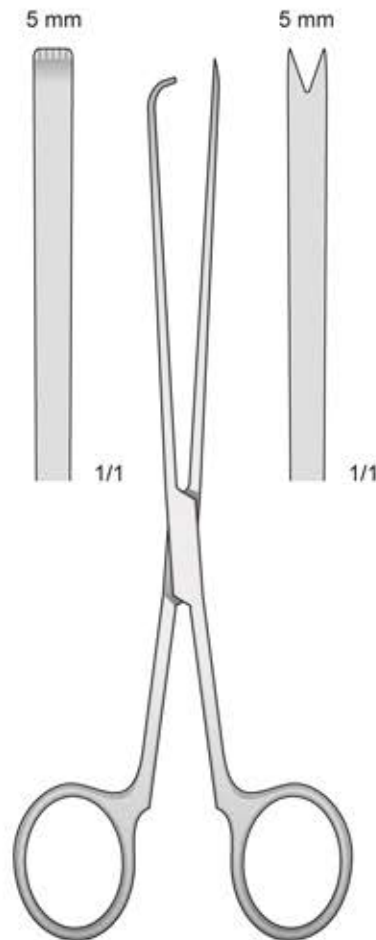

ES-201
165 mm

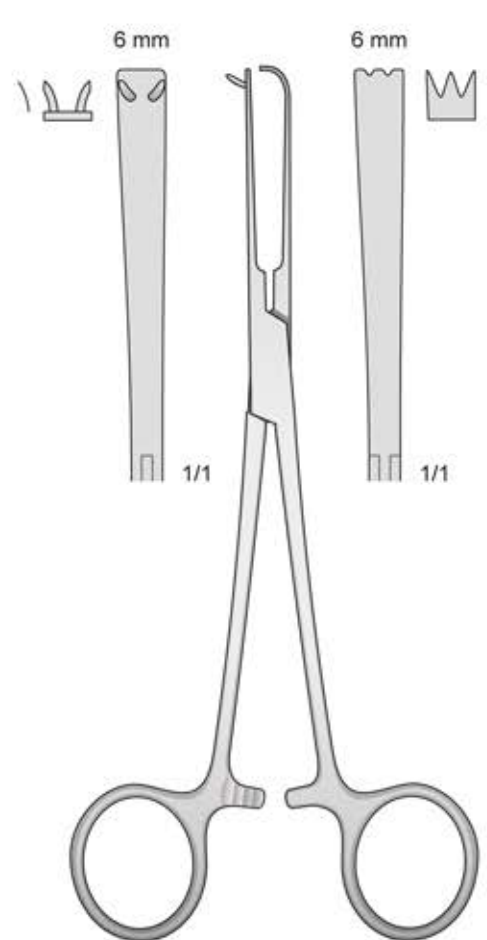

ES-202
165 mm

Gewebe und organ
Fasszangen

Gum and tissue
forceps

Pinze per afferrare
i tessuti

Pinzas para coger las
encias

Pinces pour saisir les
tissue

4 x 5 Zähne
4 x 5 Teeth
4 x 5 Denti
4 x 5 Dientes
4 x 5 Dents

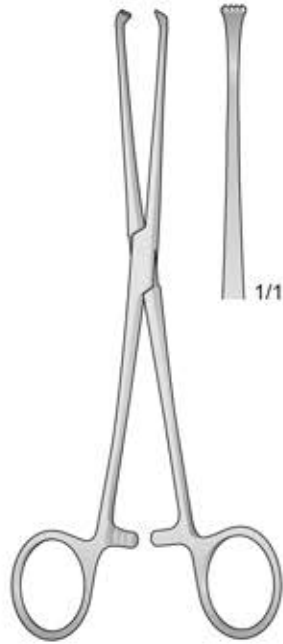

BABY-ALLIS
P-100
130 mm

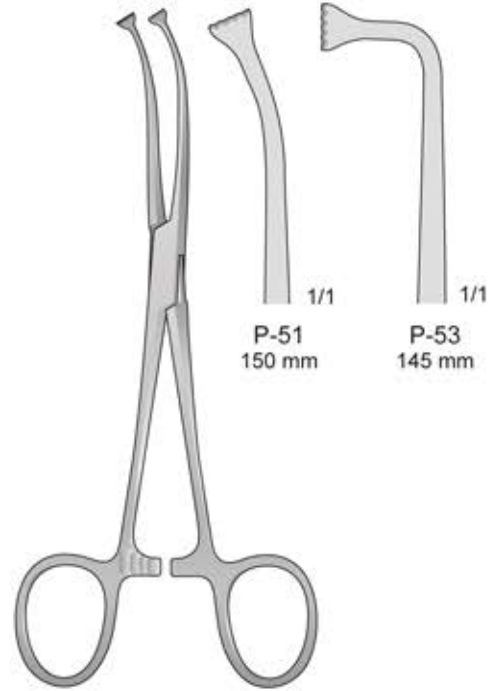

ALLIS
P-51/P-53

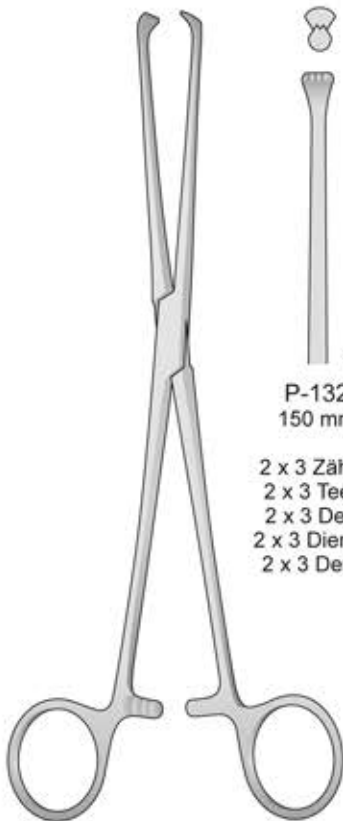

ALLIS
P-50/P-134

1/1	1/1	1/1	1/1	1/1	1/1	1/1
P-132 150 mm	P-133 150 mm	P-134 150 mm	P-50 160 mm	P-115 200 mm	P-119 220 mm	P-118 250 mm
2 x 3 Zähne 2 x 3 Teeth 2 x 3 Denti 2 x 3 Dientes 2 x 3 Dents	3 x 4 Zähne 3 x 4 Teeth 3 x 4 Denti 3 x 4 Dientes 3 x 4 Dents	4 x 5 Zähne 4 x 5 Teeth 4 x 5 Denti 4 x 5 Dientes 4 x 5 Dents	5 x 6 Zähne 5 x 6 Teeth 5 x 6 Denti 5 x 6 Dientes 5 x 6 Dents	5 x 6 Zähne 5 x 6 Teeth 5 x 6 Denti 5 x 6 Dientes 5 x 6 Dents	5 x 6 Zähne 5 x 6 Teeth 5 x 6 Denti 5 x 6 Dientes 5 x 6 Dents	5 x 6 Zähne 5 x 6 Teeth 5 x 6 Denti 5 x 6 Dientes 5 x 6 Dents

Fine-Arterienklemmen

Fine
Artery forceps

Pinze emostatiche
delicate

Pinzas hemostáticas
fino

Delicate
Pincès hémostatiques

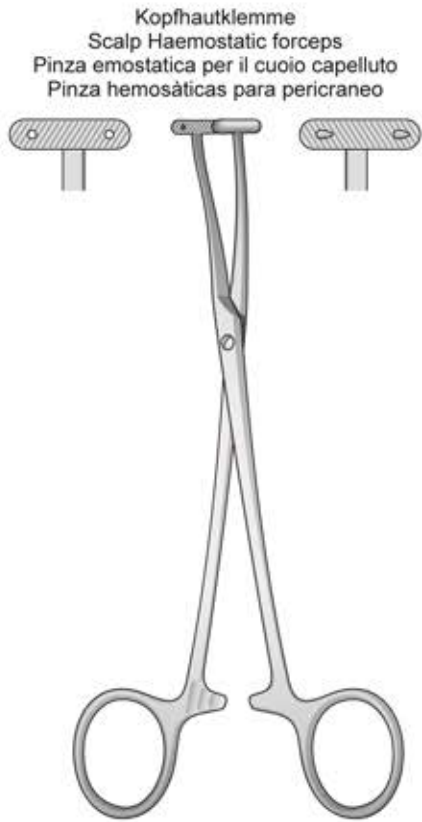

DE MARTEL
FB-120
180 mm

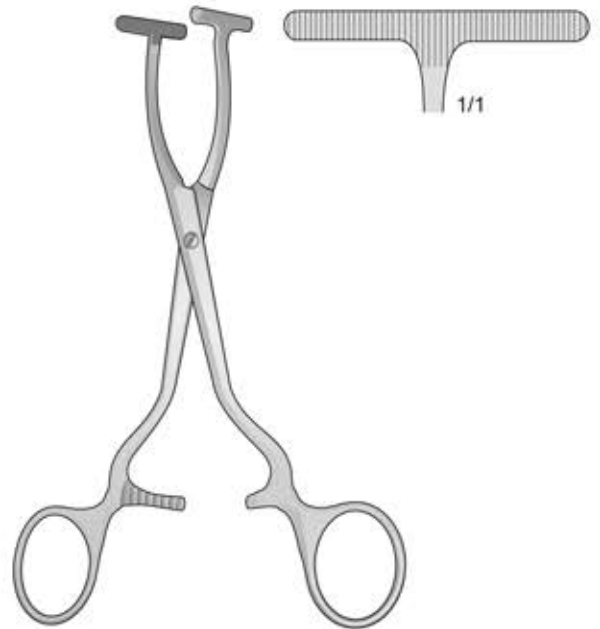

P-207
150 mm

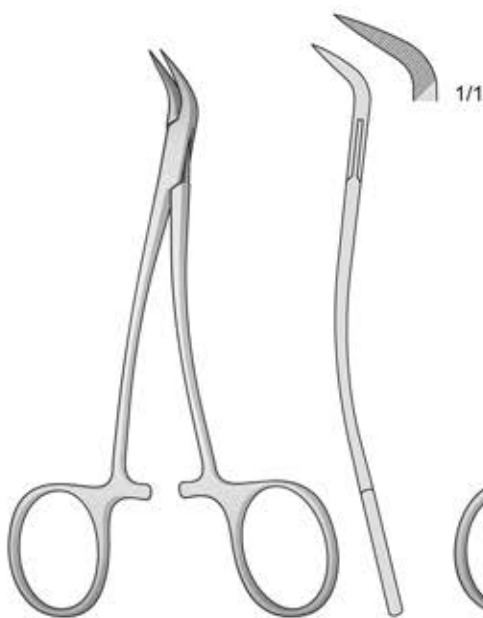

PEET
DR-40
120 mm

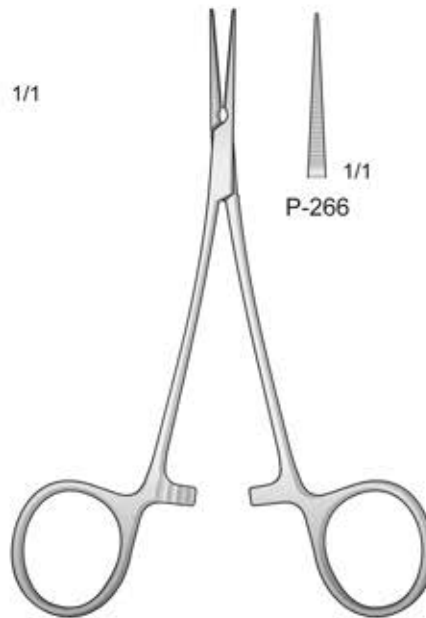

JACOBSON-MICRO
P-266
130 mm

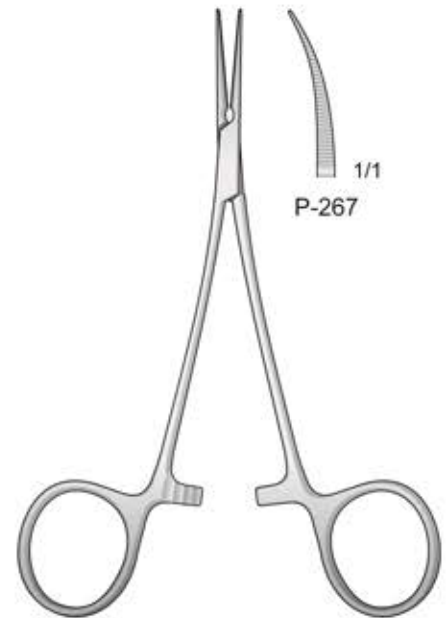

JACOBSON-MICRO
P-267
130 mm

Tuchklemmen

Towel clamps

Fissateli

Pinzas de campo

Pinces pour fixer les compresses



1/1

SCHAEDEL
BF-38
85 mm



1/1

JONES
BF-48
90 mm



1/1

FAURE
BF-40
85 mm



1/1

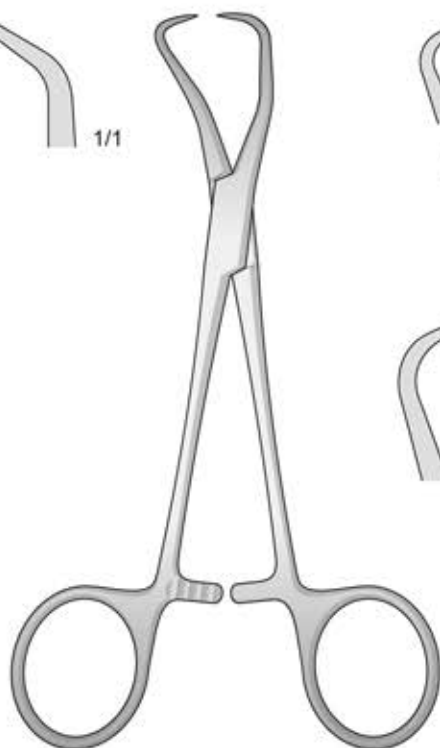

BACKHAUS
BF-41/BF-46



1/1

BF-42
90 mm



1/1

BF-41
100 mm



1/1

BF-44
110 mm



1/1

BF-46
130 mm



1/1

BF-43
135 mm



1/1

BF-45
140 mm

Tuchklemmen

Towel clamps

Fissateli

Pinzas de campo

Pinces pour fixer les compresses

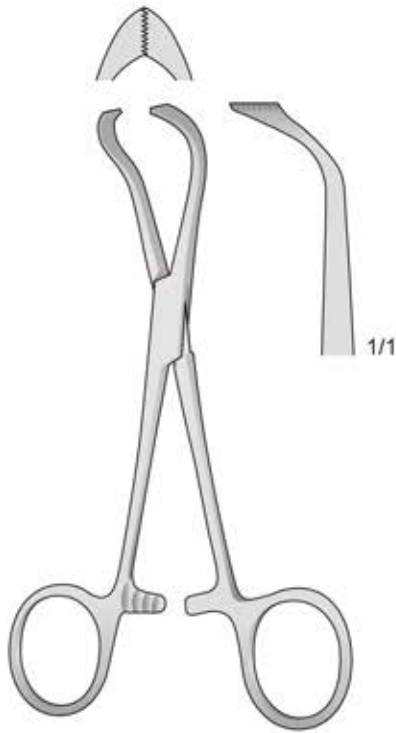

LORNA
BF-50
100 mm

Für Papiertücher
For paper cloths
Per teli di carta
Para paños
Pour Champs en papier

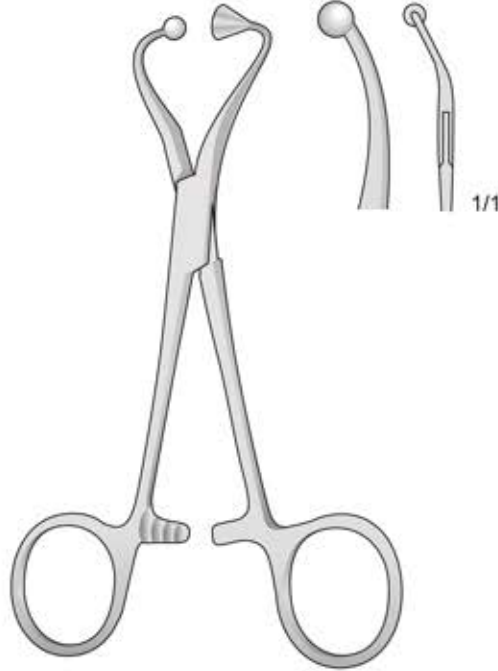

BF-74
115 mm

Für Papiertücher
For paper cloths
Per teli di carta
Para paños
Pour Champs en papier

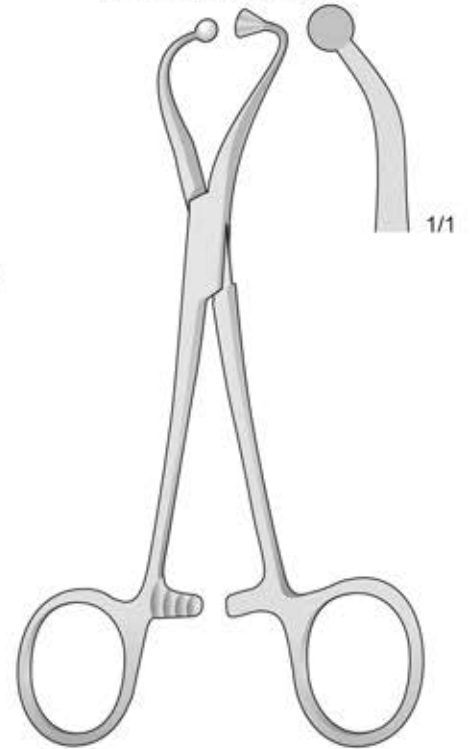

BF-75
140 mm

Für Papiertücher - For paper cloths
Per teli di carta - Para paños
Pour Champs en papier

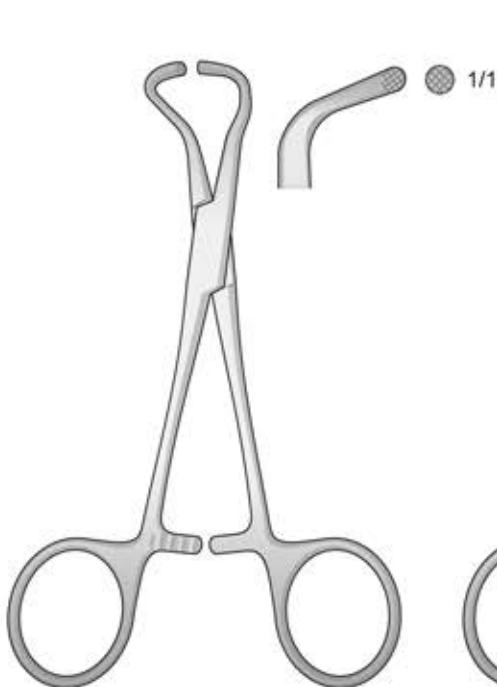

BF-76
100 mm

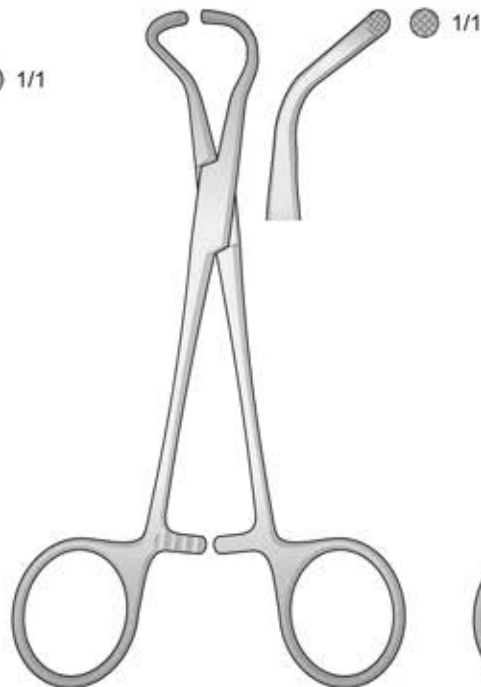

BF-77
125 mm

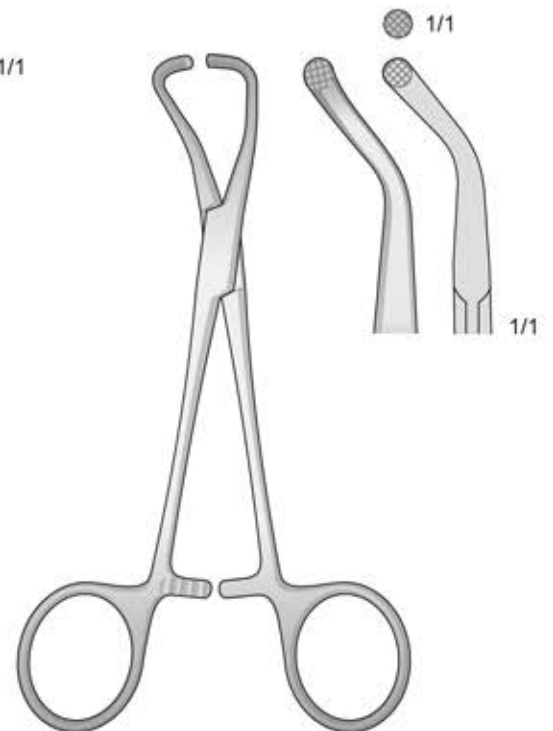

BF-52
130 mm

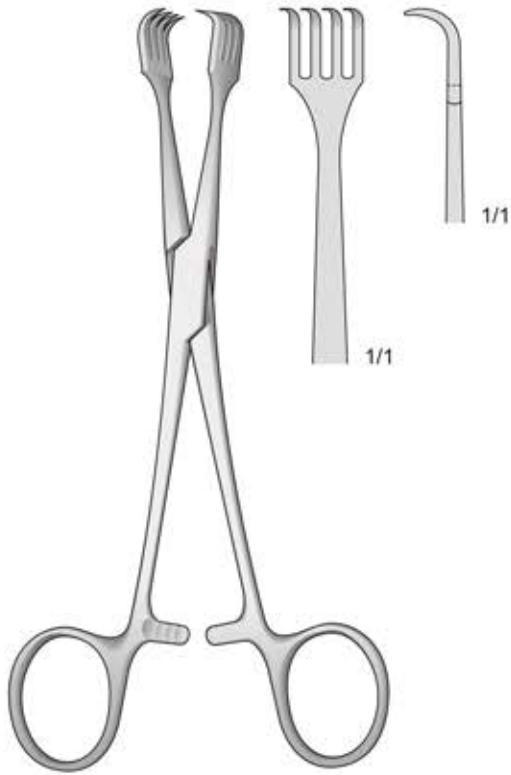

BRAUN
BF-58
155 mm

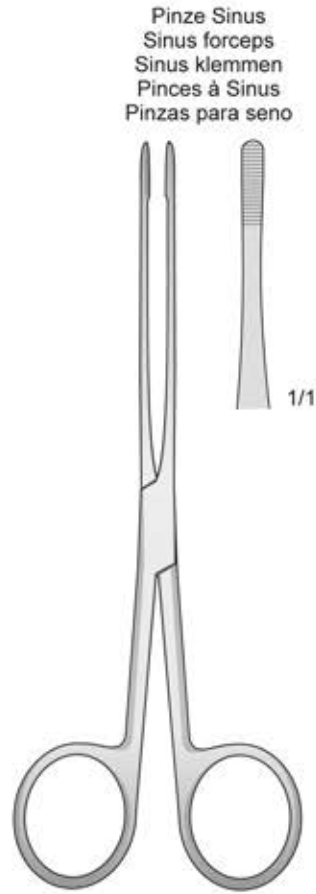

LISTER
BF-20
150 mm

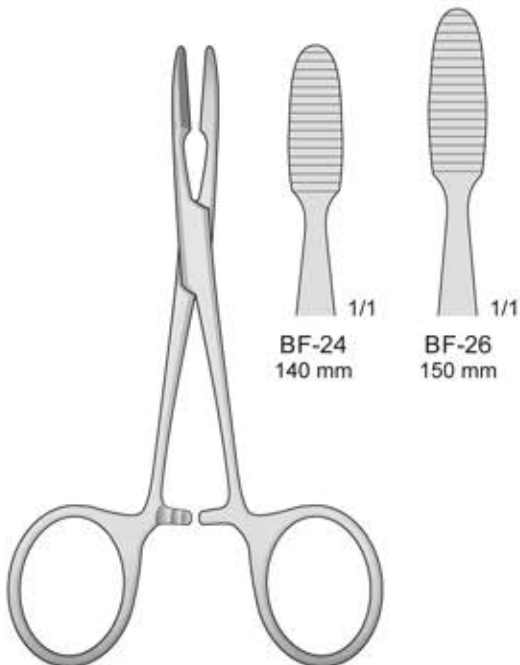

PEAN-MURPHY
BF-24/BF-26

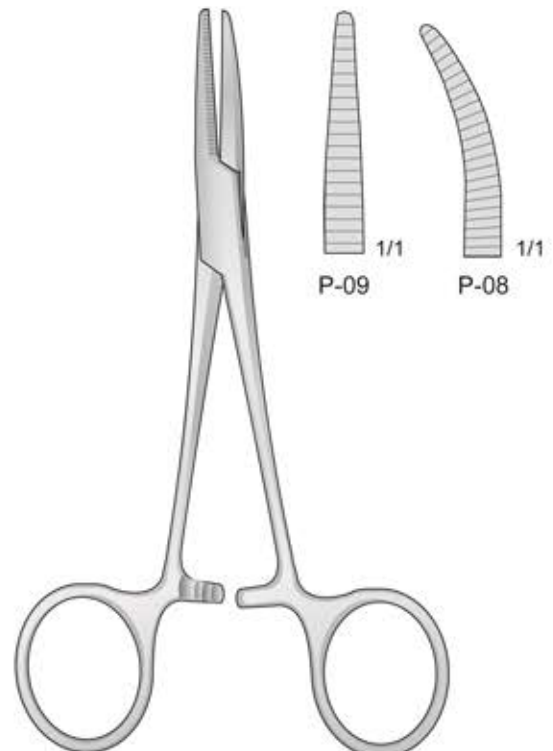

JONES
P-09/P-08
150 mm

Schwamm und
Tamponzangen

Sponge and dressing
forceps

Pinze per tamponi

Pinces à tampons

Pinces à tampons

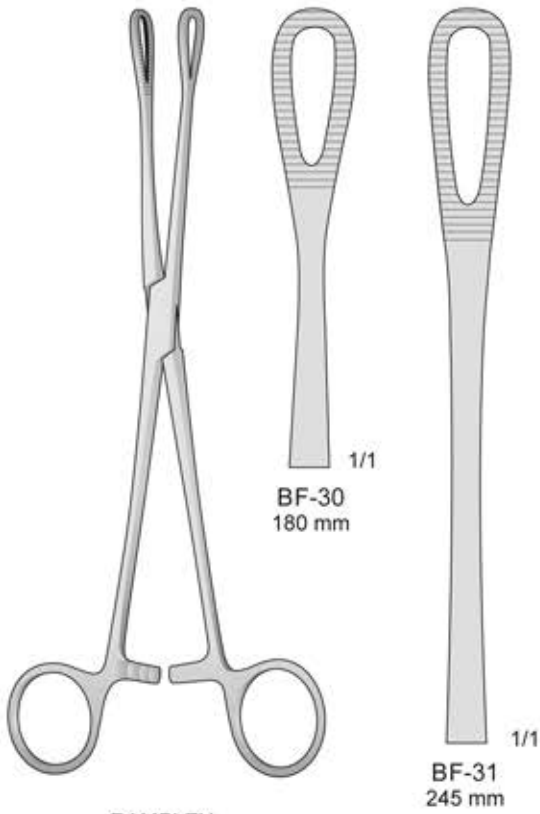

RAMPLEY
BF-30/BF-31

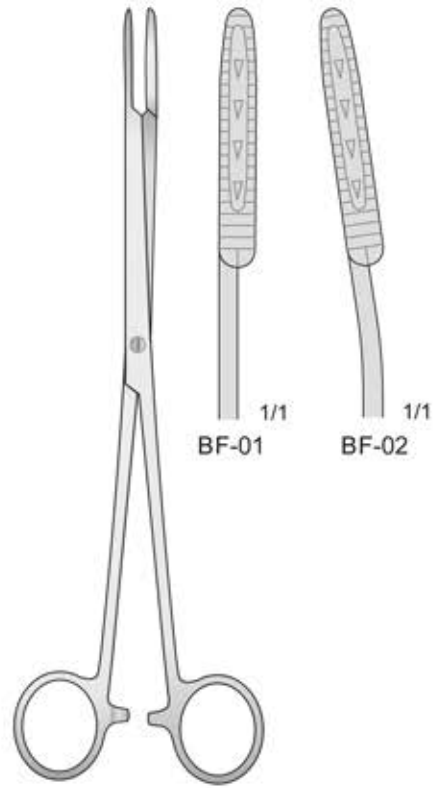

MAIER
BF-01/BF-02
245 mm

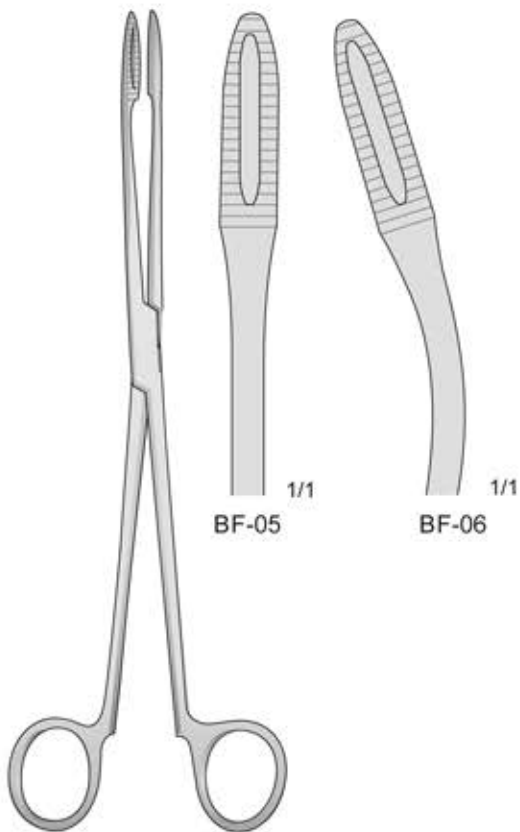

MAIER
BF-05/BF-06
265 mm

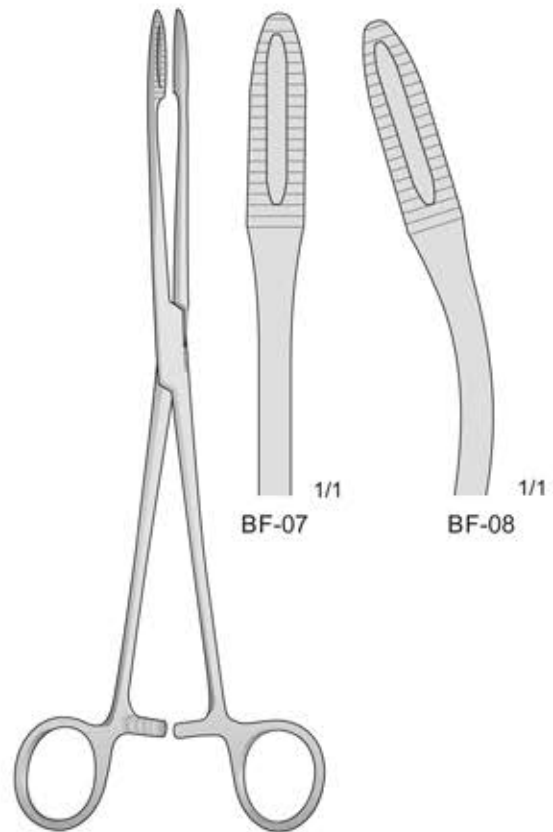

MAIER
BF-07/BF-08
265 mm

Fine-Arterienklemmen

Fine
Artery forceps

Pinze emostatiche
delicate

Pinzas hemostáticas
fino

Delicate
Pincas hémostatiques

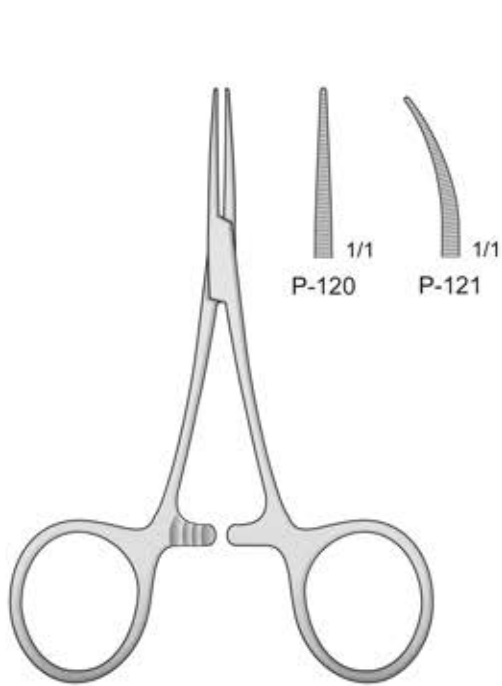

HARTMANN-BABY-MOSQUITO
P-120/P-121
95 mm

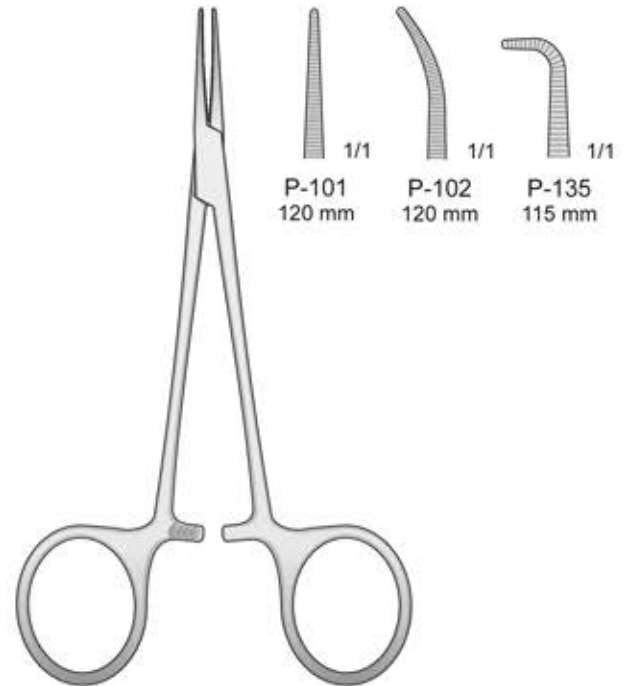

MICRO-HALSTED
P-101/P-135

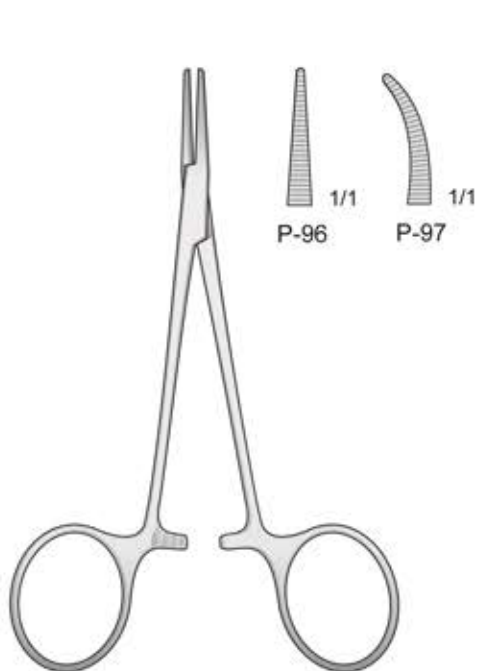

HALSTED-MOSQUITO
P-96/P-97
120 mm

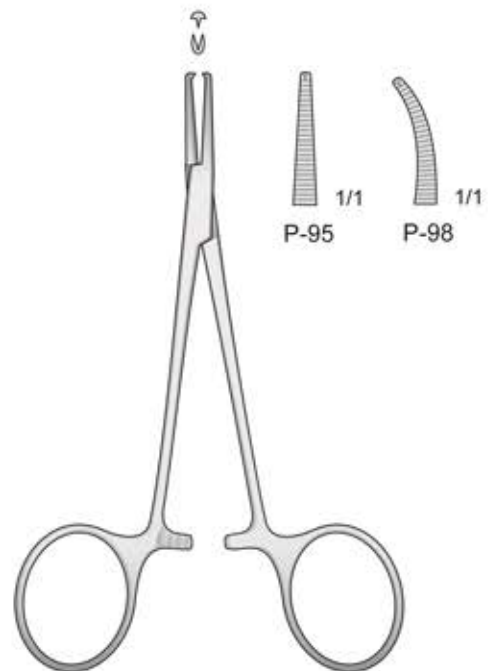

HALSTED-MOSQUITO
P-95/P-98
120 mm

Fine-Arterienklemmen

Fine
Artery forceps

Pinze emostatiche
delicate

Pinzas hemostáticas
fino

Delicate
Pincas hémostatiques

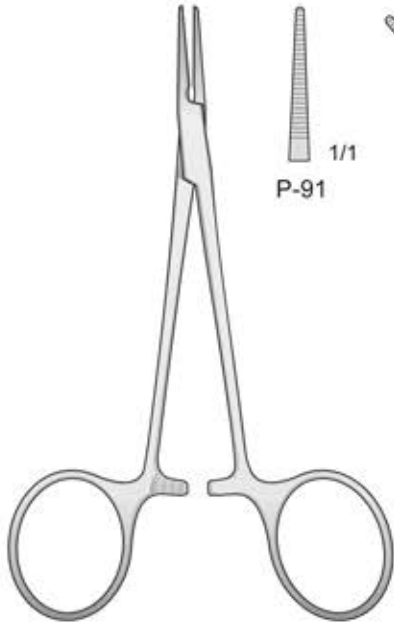

HALSTED
P-91/P-92
125 mm

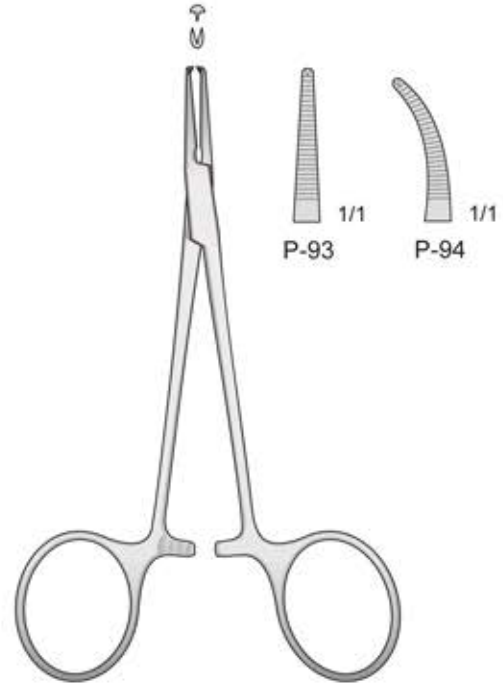

HALSTED
P-93/P-94
125 mm

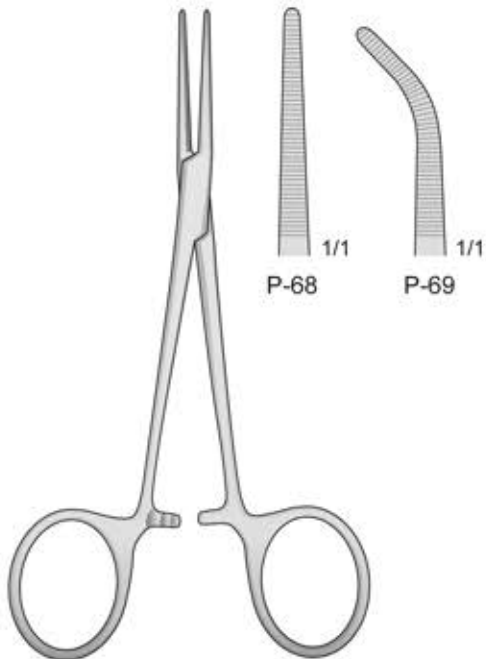

GIDEF
P-68/P-69
140 mm

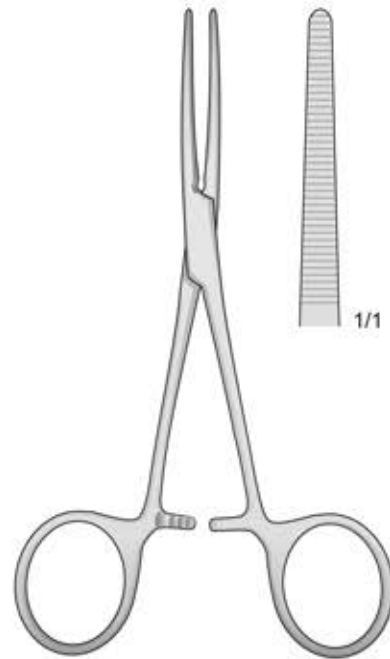

PEAN
P-17
140 mm

Arterienklemmen

Hemostatic forceps

Pinze emostatiche

Pinzas hemostáticas

Pincas hémostatiques

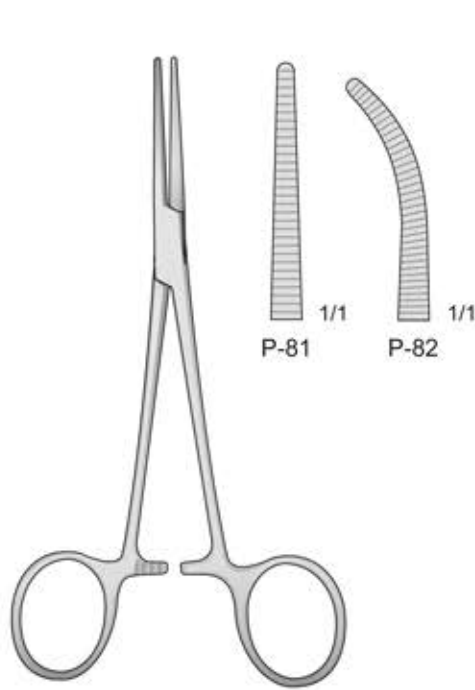

CRILE
P-81/P-82
140 mm

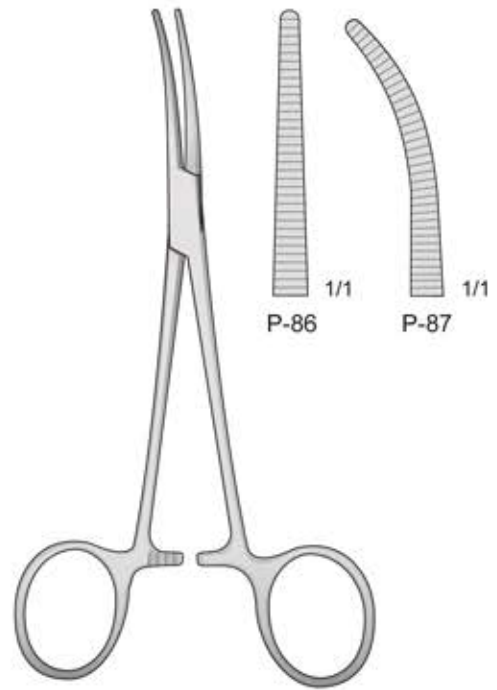

CRILE
P-86/P-87
160 mm

Seitwärts gebogen
Curved to side
Curve sul lato
Curvas laterales
Courbes latérales

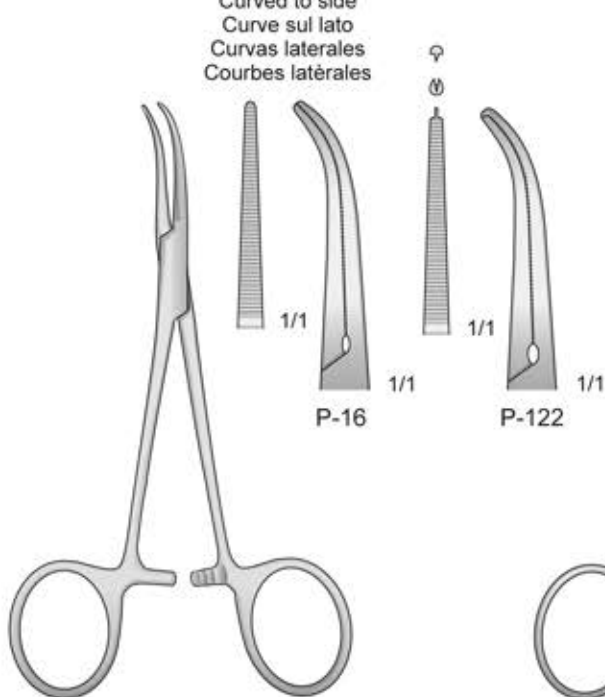

DANDY
P-16/P-122
140 mm

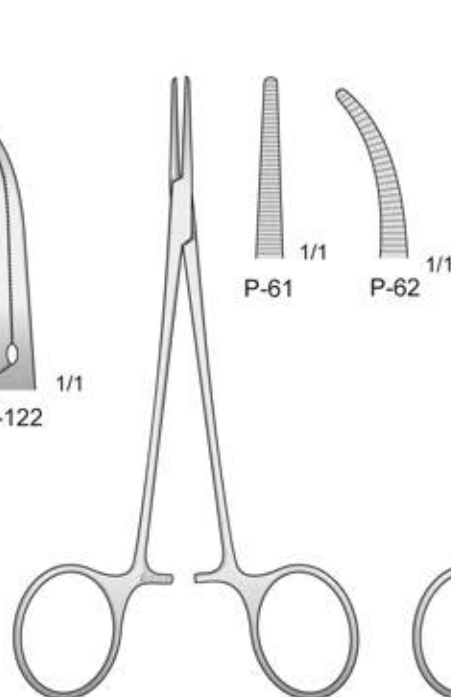

LERICHE
P-61/P-62
150 mm

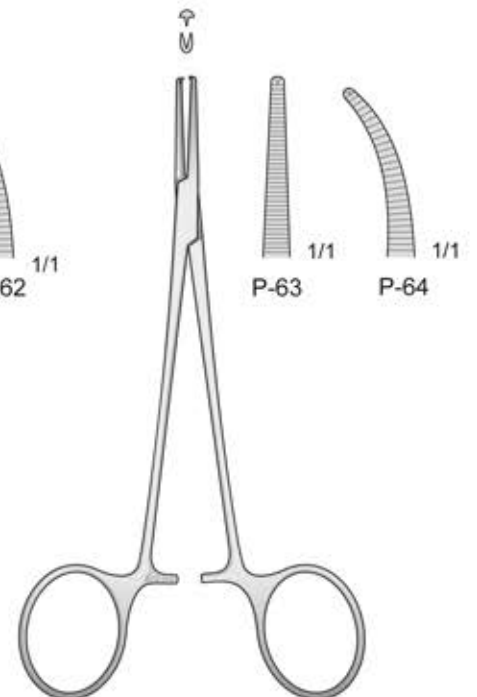

LERICHE
P-63/P-64
150 mm

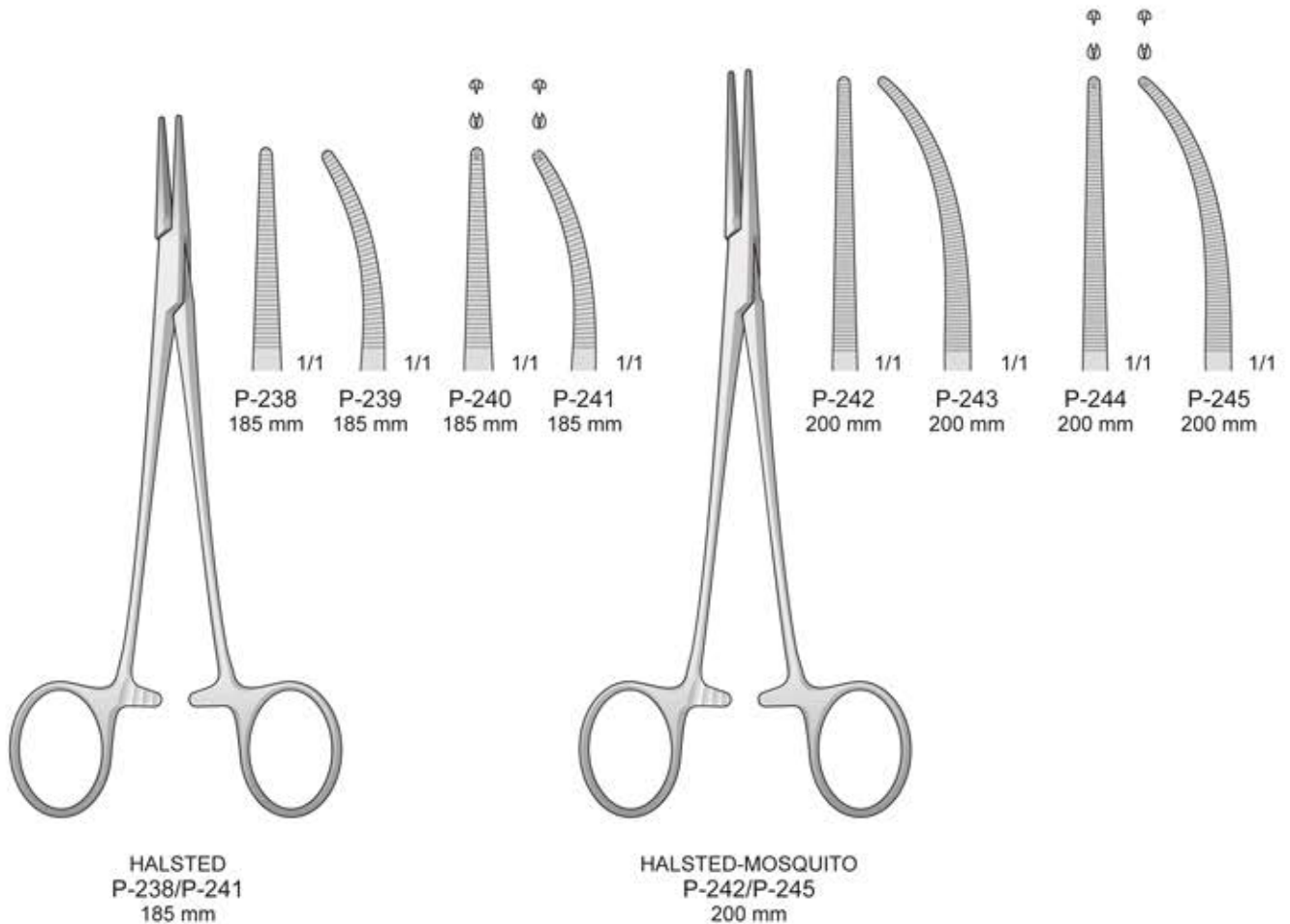
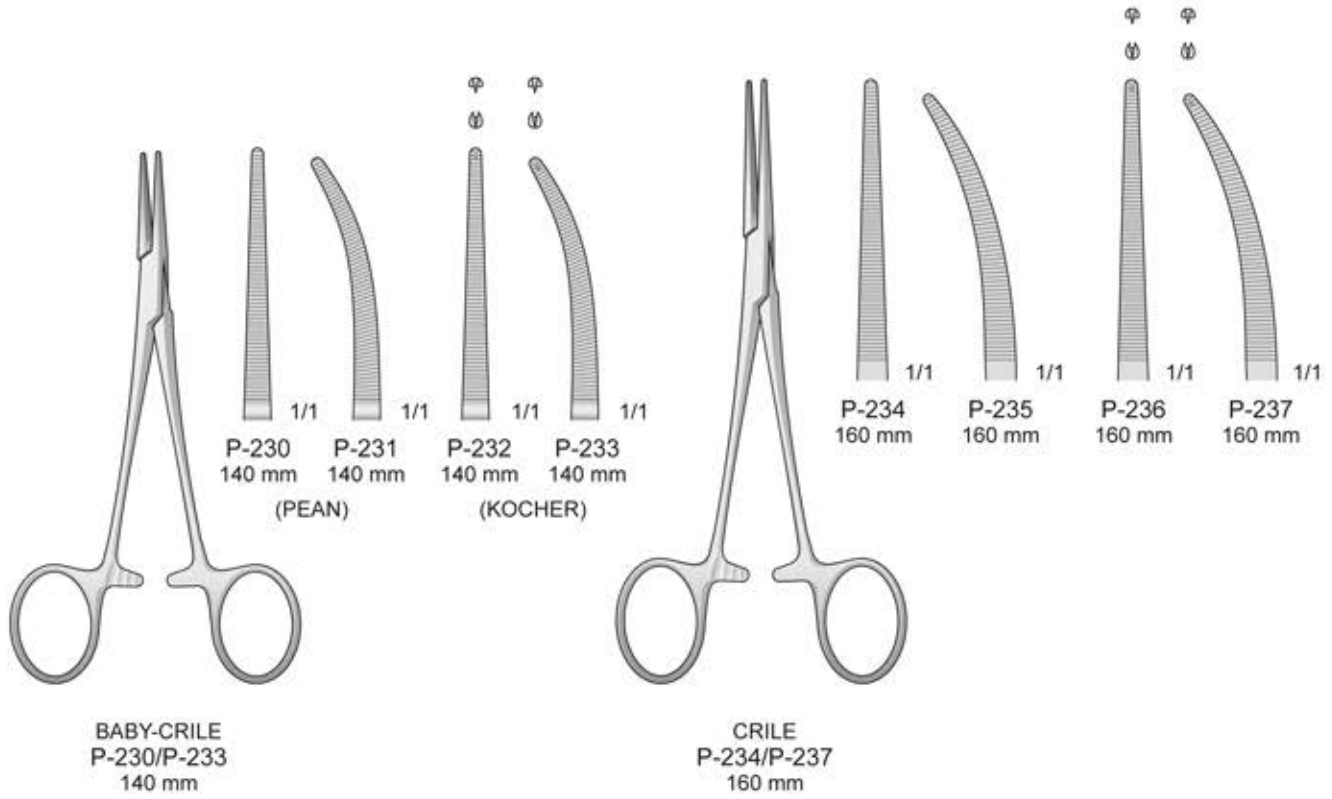

Arterienklemmen

Hemostatic forceps

Pinze emostatiche

Pinzas hemostáticas

Pinces hémostatiques

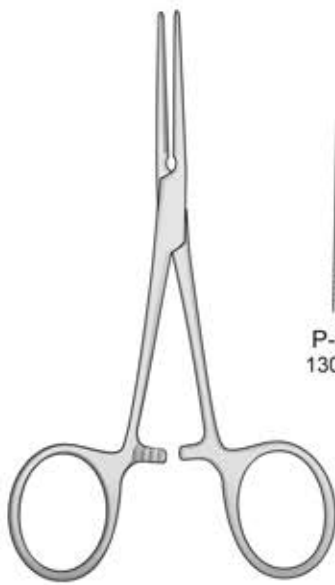

PEAN
P-250/P-255

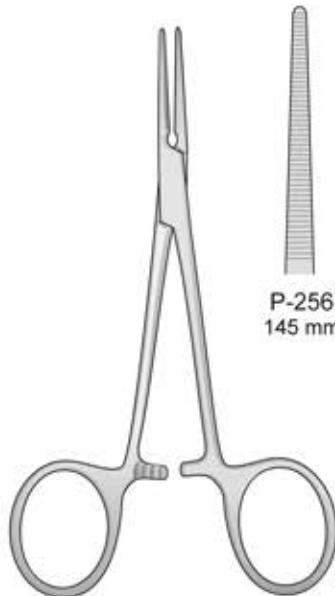
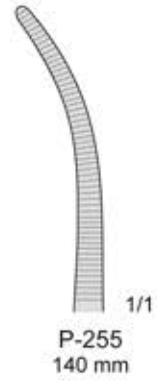
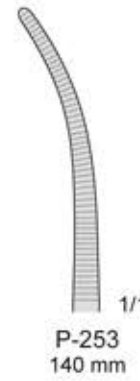
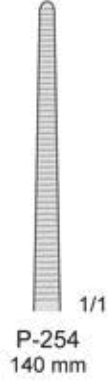
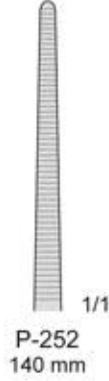
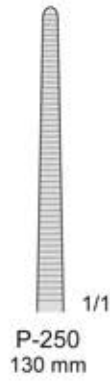

PEAN
P-256/P-259

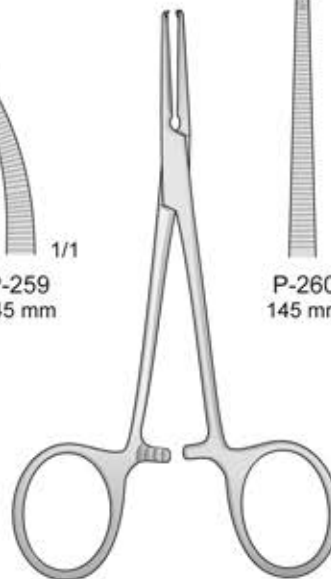
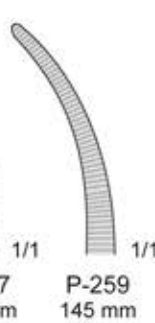
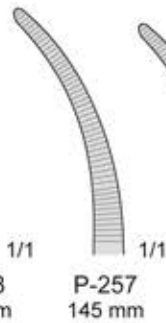
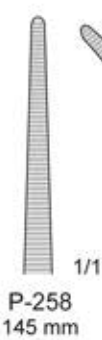
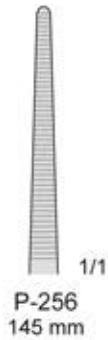

KOCHER
P-260/P-263

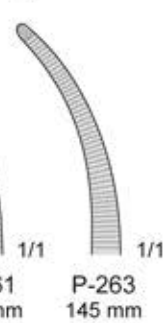
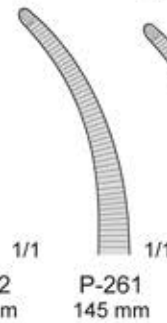
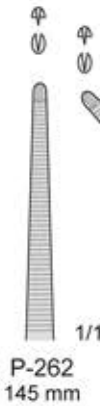
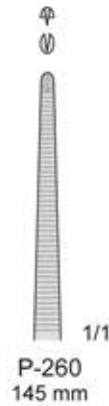

Arterienklemmen

Hemostatic forceps

Pinze emostatiche

Pinzas hemostáticas

Pinces hémostatiques

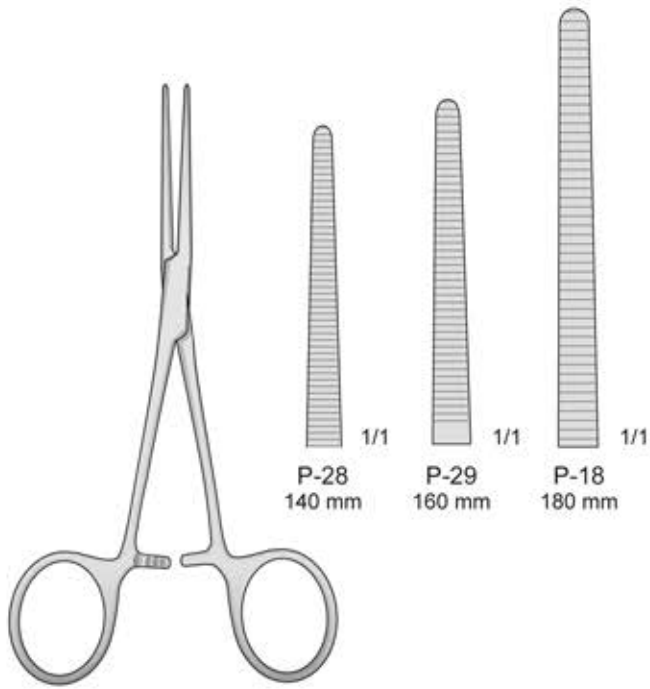

ROCHESTER-PEAN
P-18/P-29

P-28 140 mm 1/1
P-29 160 mm 1/1
P-18 180 mm 1/1

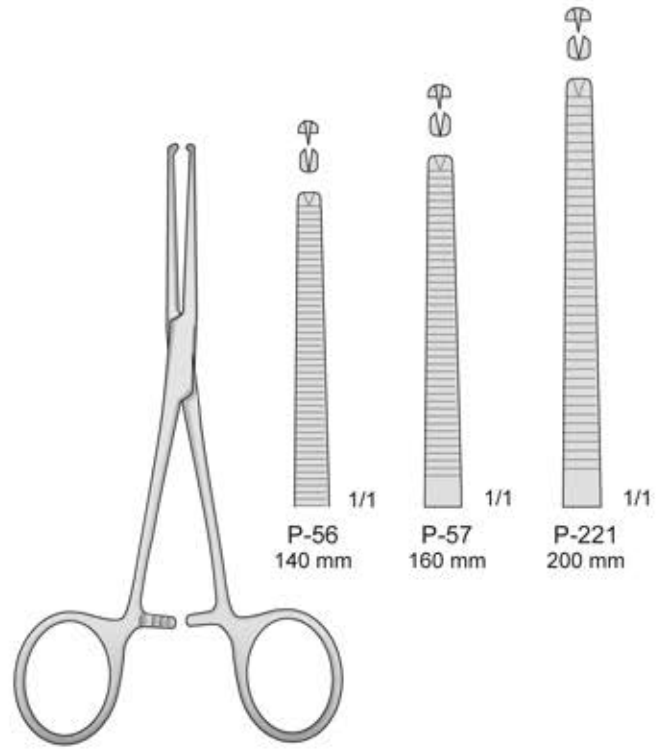

KOCHER-OCHSNER
P-56/P-221

P-56 140 mm 1/1
P-57 160 mm 1/1
P-221 200 mm 1/1

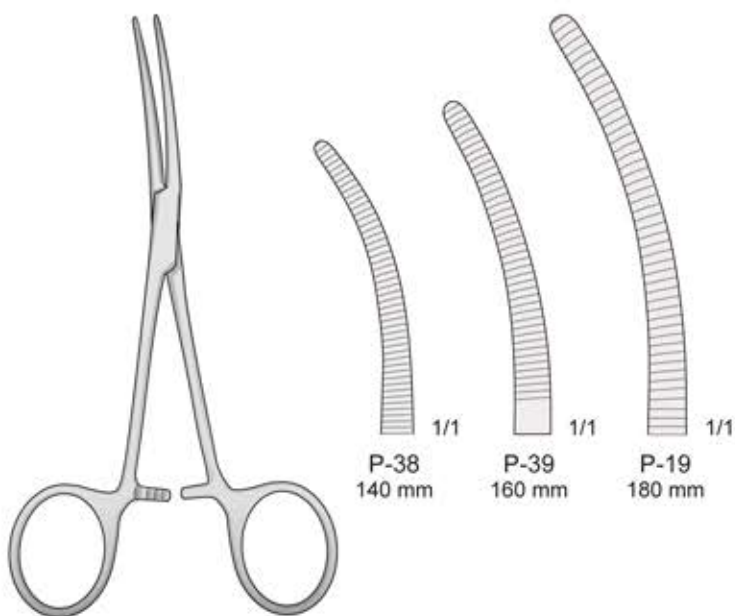

ROCHESTER-PEAN
P-19/P-39

P-38 140 mm 1/1
P-39 160 mm 1/1
P-19 180 mm 1/1

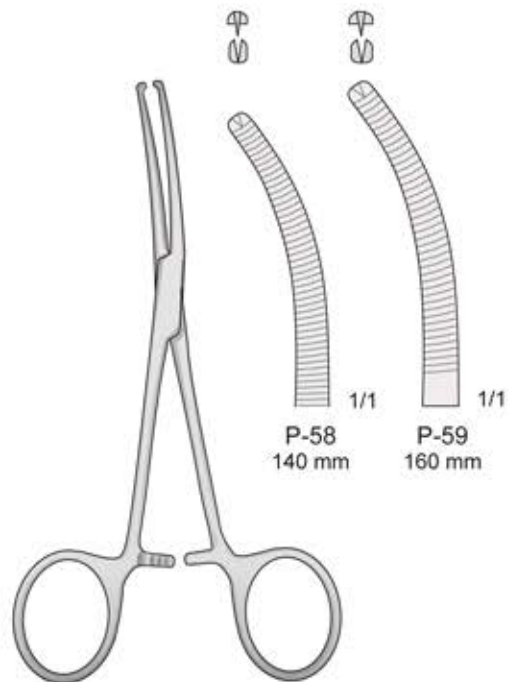

KOCHER-OCHSNER
P-58/P-59

P-58 140 mm 1/1
P-59 160 mm 1/1

Arterienklemmen

Hemostatic forceps

Pinze emostatiche

Pinzas hemostáticas

Pinces hémostatiques

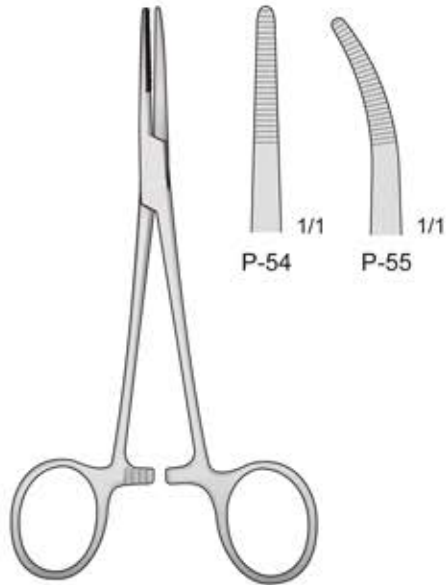

KELLY
P-54/P-55
140 mm

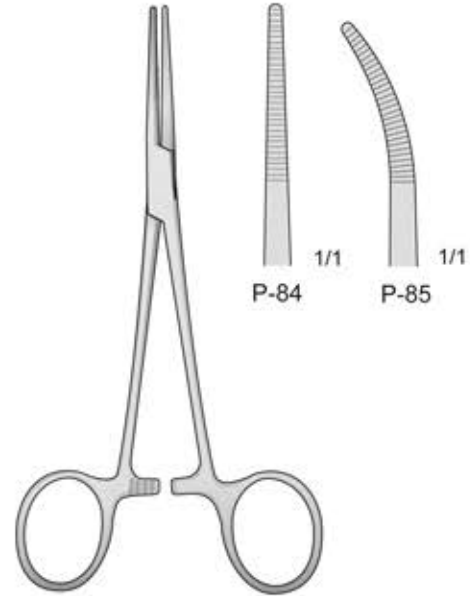

KELLY
P-84/P-85
140 mm

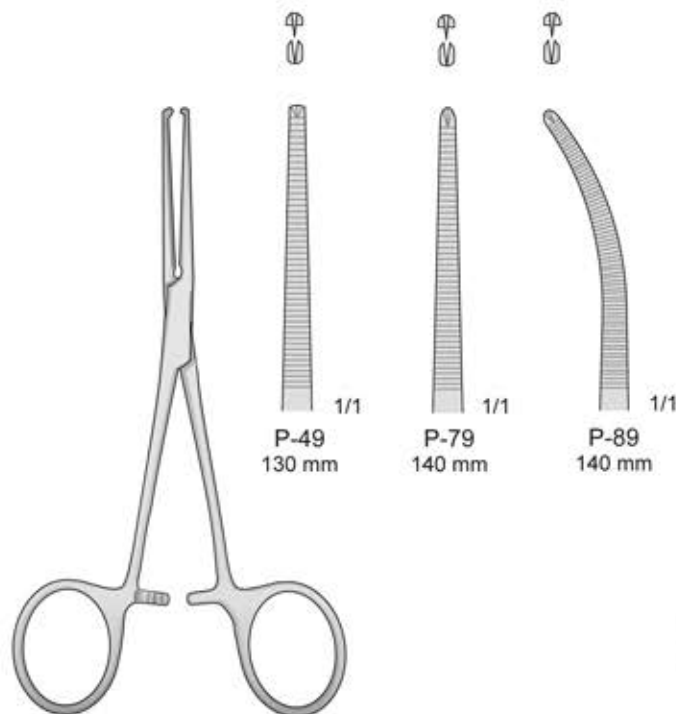

KOCHER
P-49/P-89

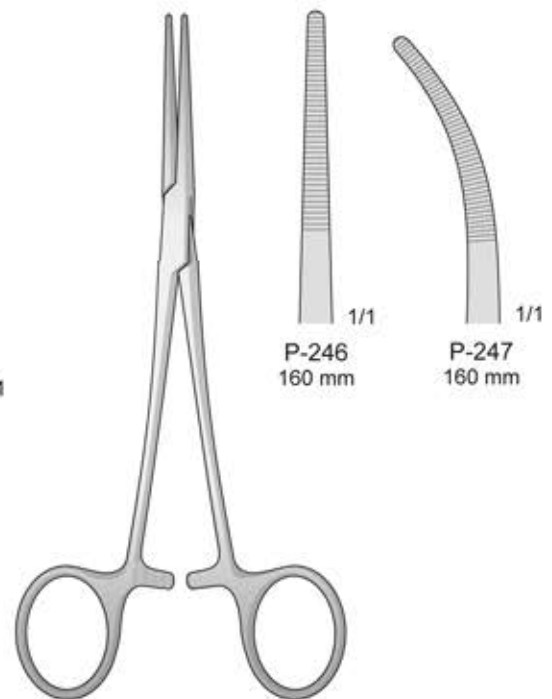

RANKIN
P-246/P-247

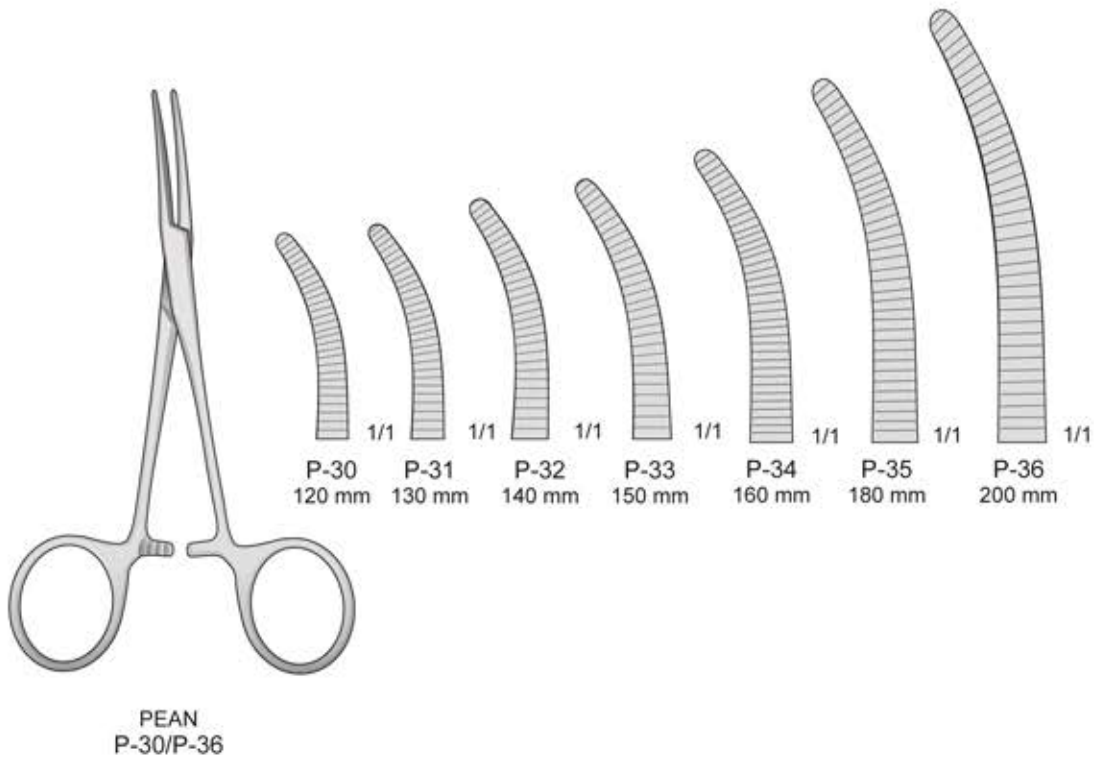
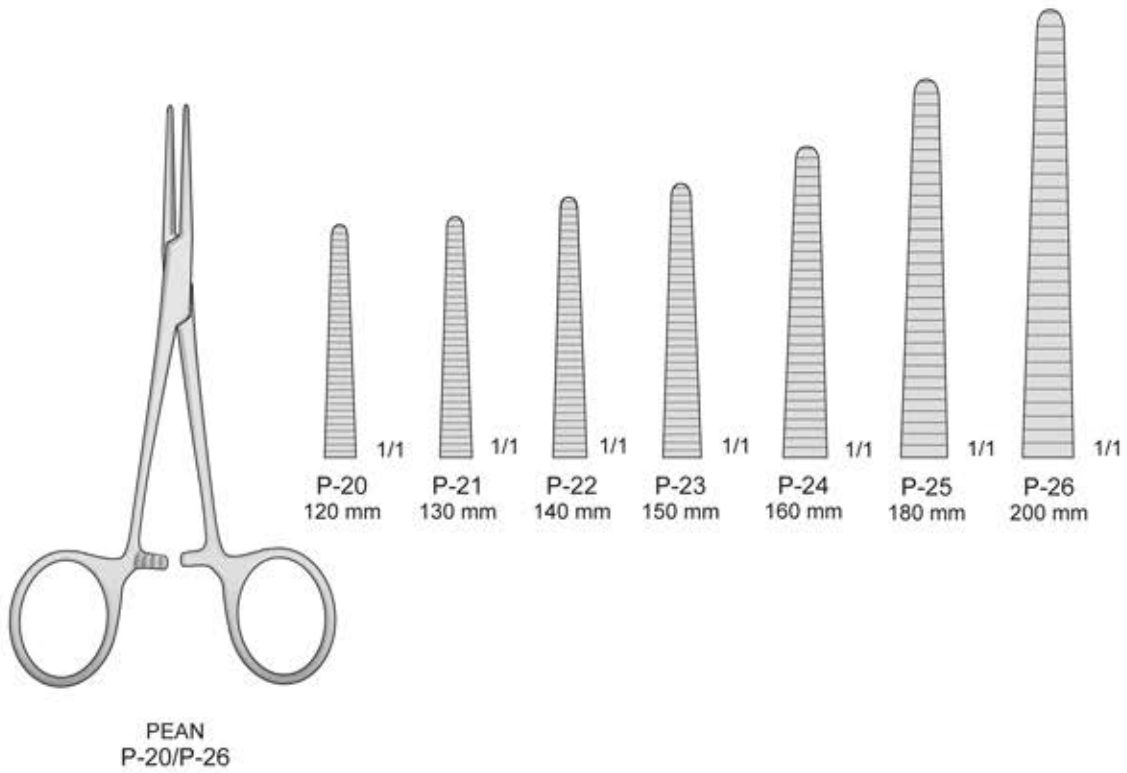

Arterienklemmen

Hemostatic forceps

Pinze emostatiche

Pinzas hemostáticas

Pinces hémostatiques

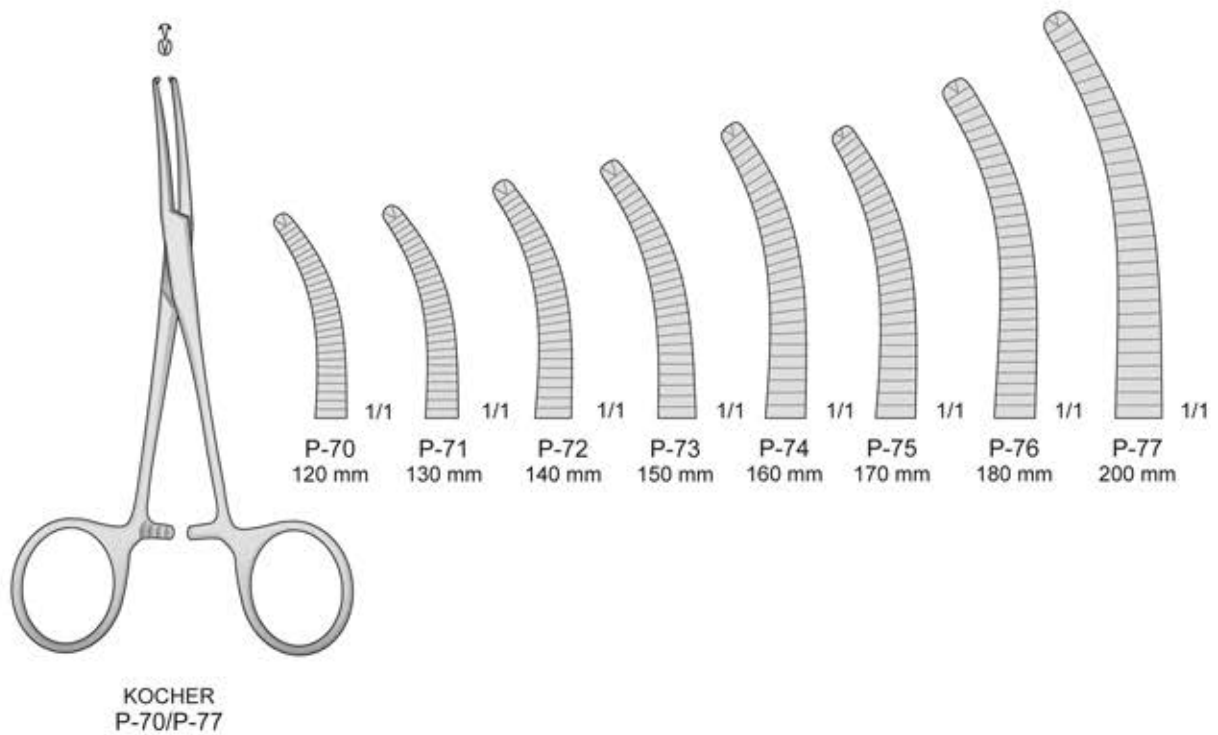
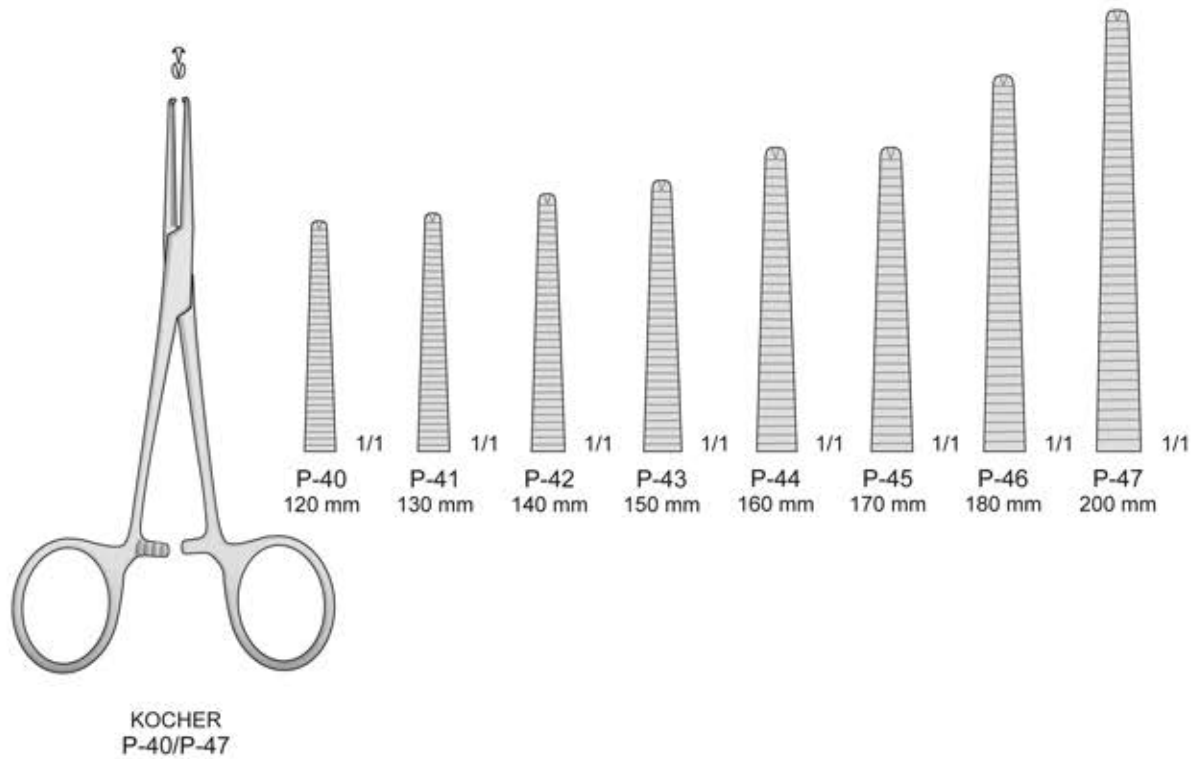

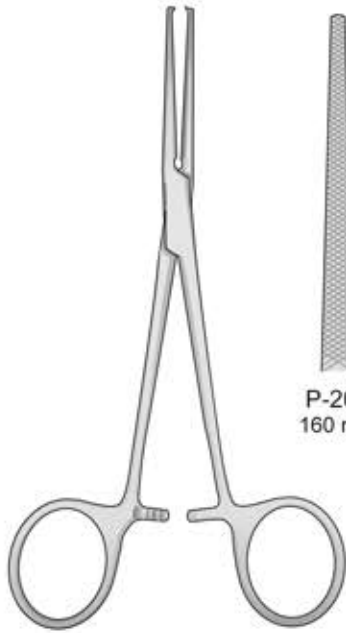

DIXON-LOVELACE
P-208/P-209

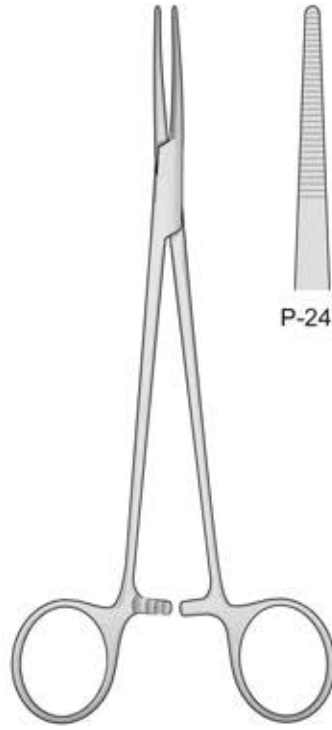
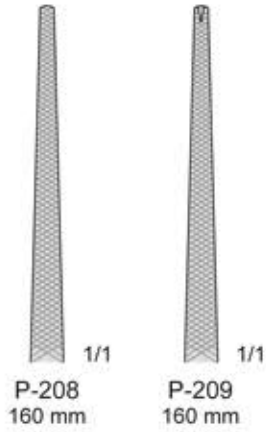

BIRKETT
P-248/P-249
180 mm

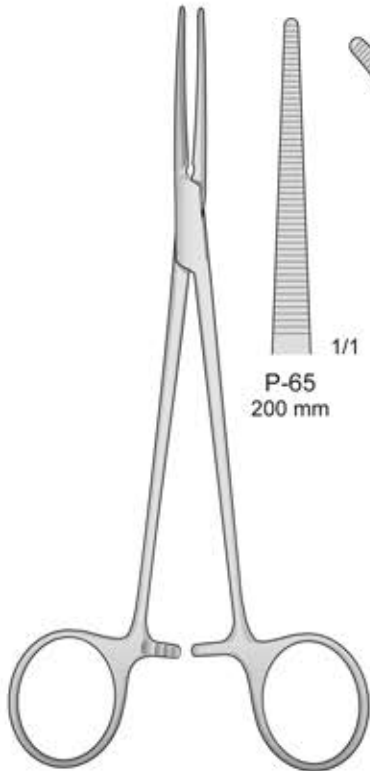
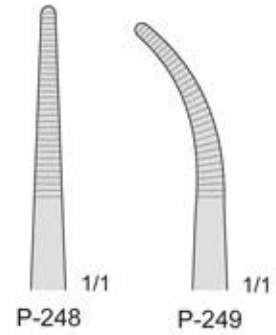

HEISS
P-65/P-200

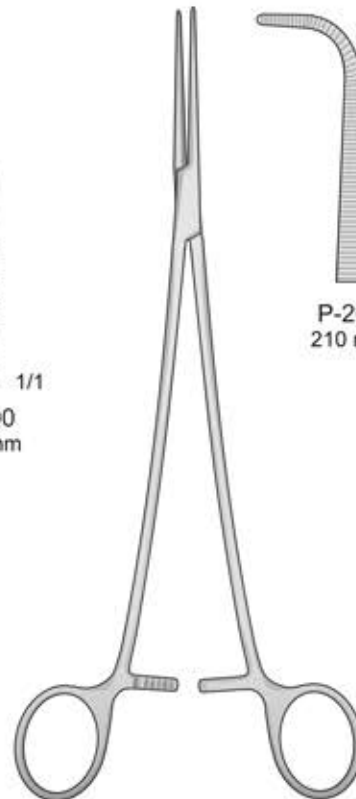
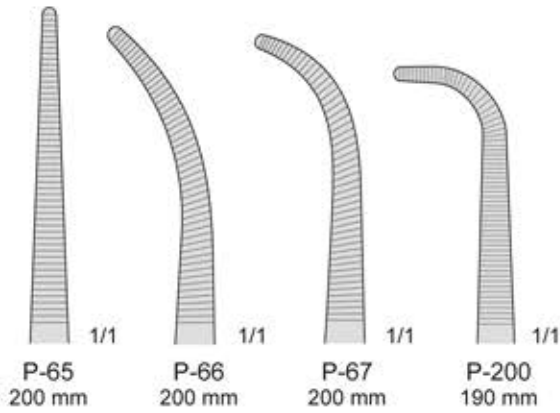

BENGOLEA
P-205/P-206

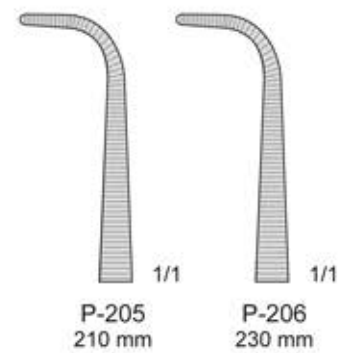

Arterienklemmen
Präparier und
Ligaturklemmen

Artery forceps
for preparation
and ligature

Pinze emostatiche
per preparazioni
e legature

Pinzas hemostáticas
Preparacion
y para ligaduras

Pinces hemostáticas
à disséquer
et à ligatures

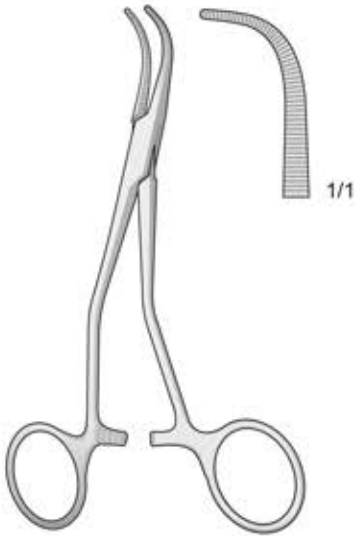

P-15
130 mm

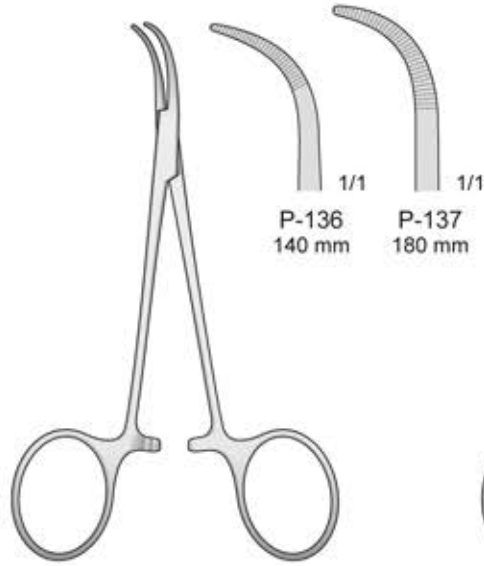

BABY-MIXTER
P-136/P-137

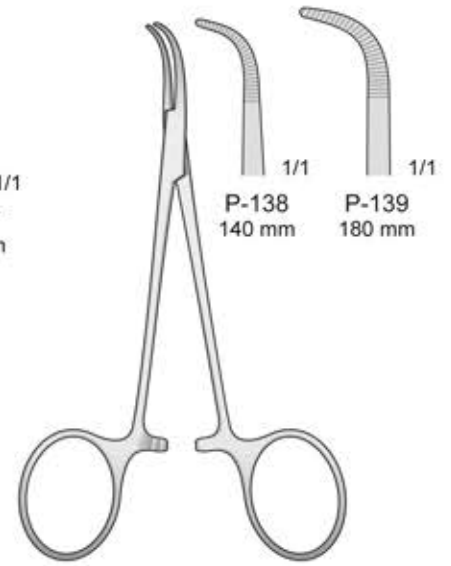

BABY-ADSON
P-138/P-139

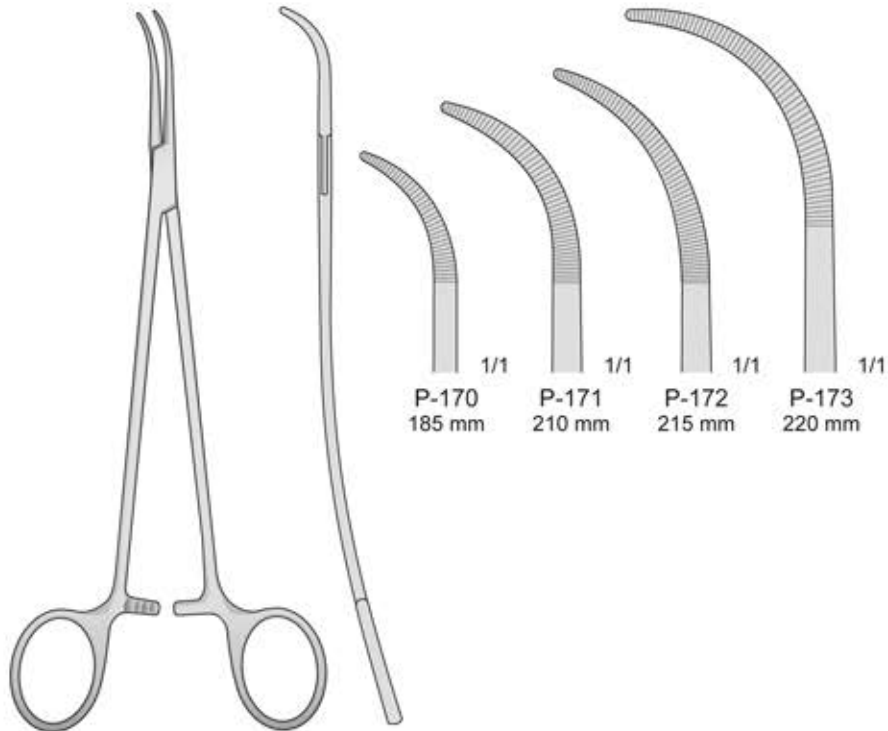

P-170/P-172

Arterienklemmen
Präparier und
Ligaturklemmen

Artery forceps
for preparation
and ligature

Pinze emostatiche
per preparazioni
e legature

Pinzas hemostáticas
Preparacion
y para ligaduras

Pinces hemostáticas
à disséquer
et à ligatures

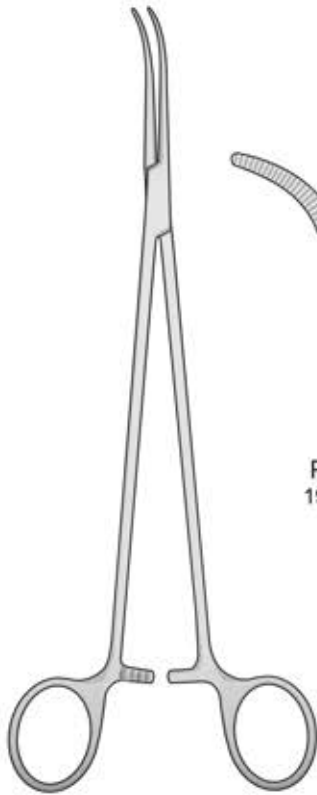

OVERHOLT-GEISSENDORFER
P-142/P-148

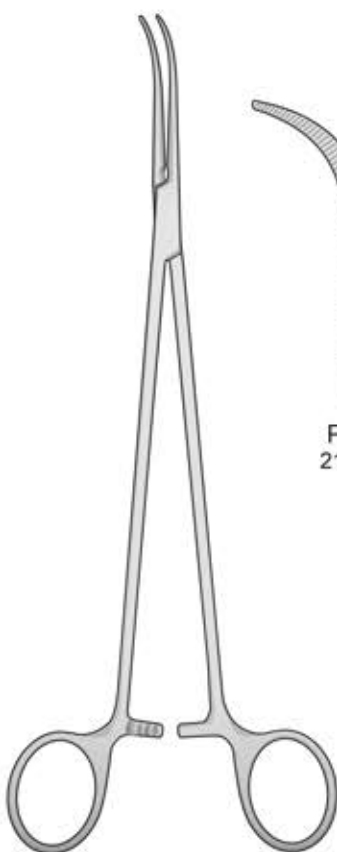
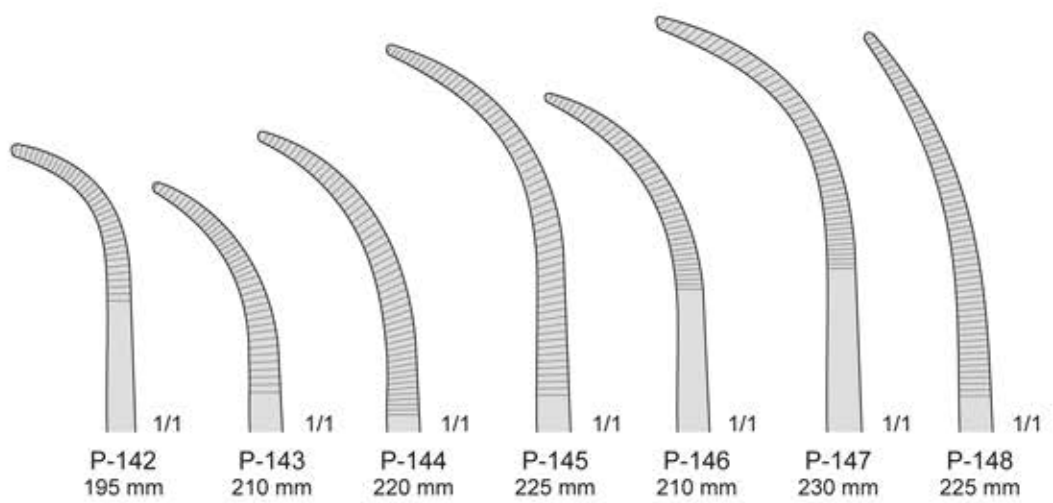

OVERHOLT
P-160/P-166

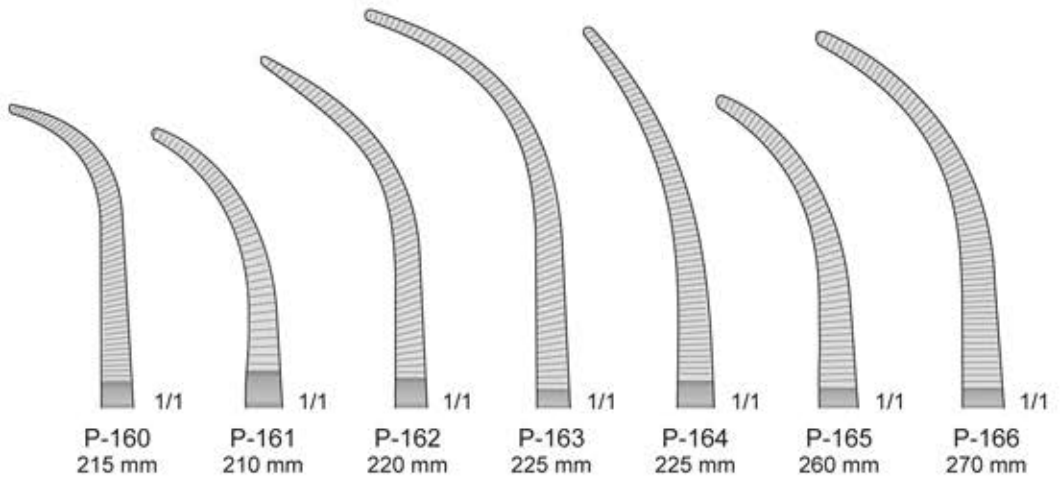

Arterienklemmen
Präparier und
Ligaturklemmen

Artery forceps
for preparation
and ligature

Pinze emostatiche
per preparazioni
e legature

Pinzas hemostáticas
Preparacion
y para ligaduras

Pinces hemostáticas
à disséquer
et à ligatures

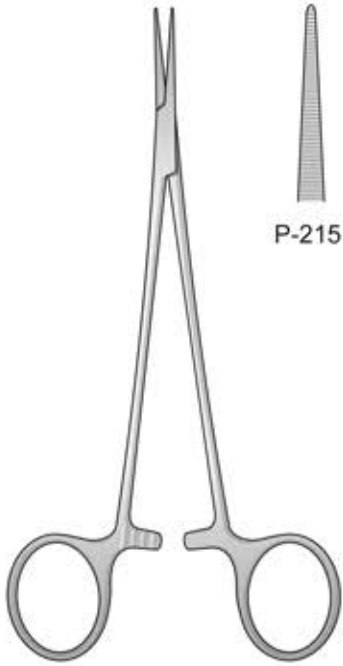

P-215/P-217
160 mm

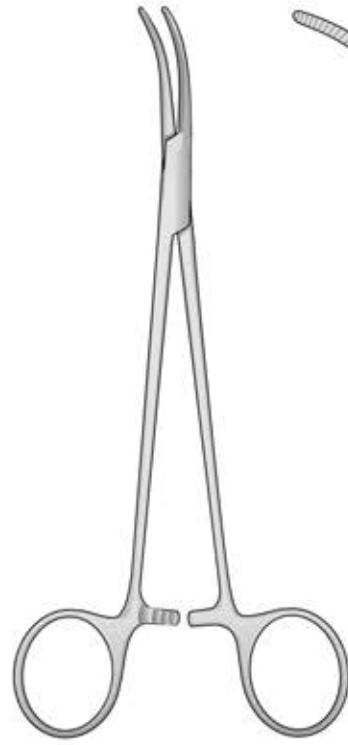
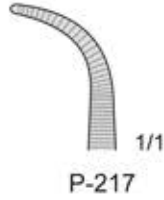
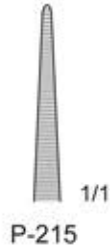

ROCHESTER-PEAN
P-210
180 mm

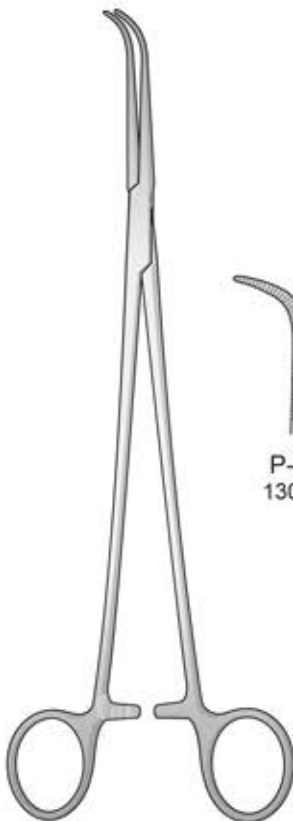
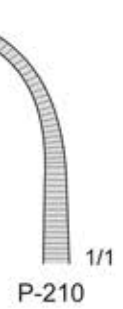

GEMINI
P-191/P-196

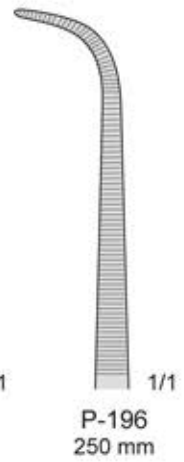
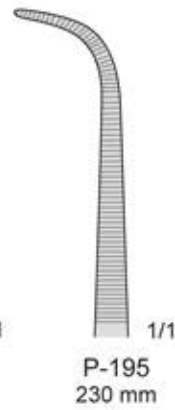
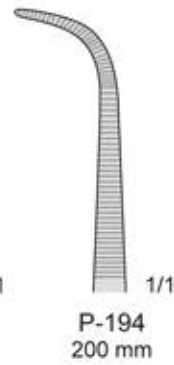
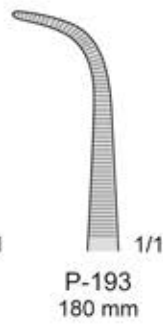
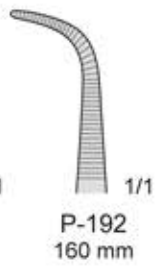
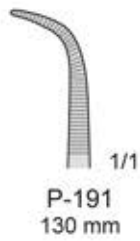

Isoliert - Insulated - Isolate - Aislante - Isolant
Monopolar - Monopolari

mit sterilisierfähiger Kunststoff-Isolierbeschichtung - with autoclavable plastic coated insulated handles
con rivestimento isolante in plastica sterilizzabile - con recubrimiento aislante de materia plástica esterilizable
à enduit plastique isolant, stérilisable



BT-490
10 x 6 mm

BT-491
14 x 7 mm

BT-492
16 x 10 mm

BT-493
18 x 12 mm

Anatomische Pinzetten, Chirurgische Pinzetten
Dressing Forceps, Tissue Forceps
Pinzette anatomiche e chirurgiche
Pinzas anatómicas, Pinzas quirúrgicas
Pincas anatómiques, Pincas quirúrgicas

DESMARRES
BT-490/BT-493
140 mm



BD-194IS
100 mm



BD-10IS
145 mm



BD-273IS
155 mm



BD-20IS
200 mm



BD-23IS
230 mm



BD-277IS
250 mm



BD-24IS
250 mm



5

Nadelhalter
Needle holders
Port'aghi
Portaagujas
Porte aiguilles

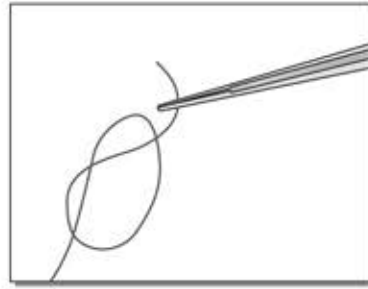

BROCK
FD-203
130 mm

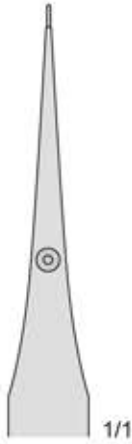

BROCK
FD-204
150 mm



BROCK
FD-211
150 mm

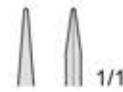

BROCK
FD-213
150 mm



Mikro Nadelhalter

Micro Needle Holders

Micro port'aghi

Micro portaagujas

Micro porte aiguilles

Glattes Maul
Smooth jaws
Con morso liscio
Mandibula lisa
A' mors lisses

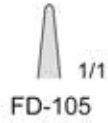
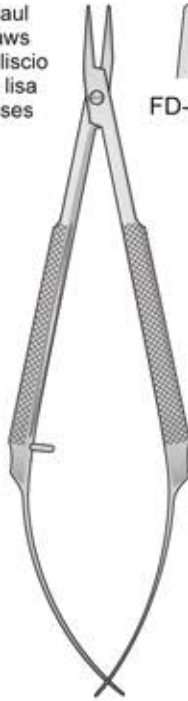

FD-105/FD-106
110 mm

FD-107/FD-108
110 mm

Glattes Maul
Smooth jaws
Con morso liscio
Mandibula lisa
A' mors lisses

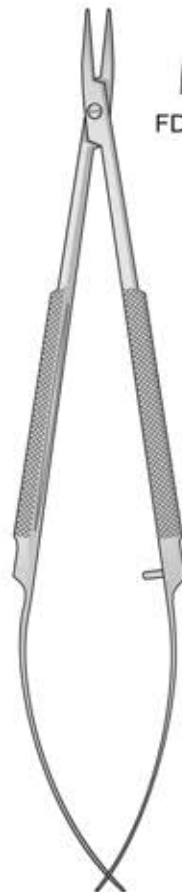

FD-113/FD-114
150 mm

FD-115/FD-116
150 mm

Feingerieftes Maul
Fine serrated jaws
Con morso zigrinato fine
Bocas estriadas finas
Mors stries fins

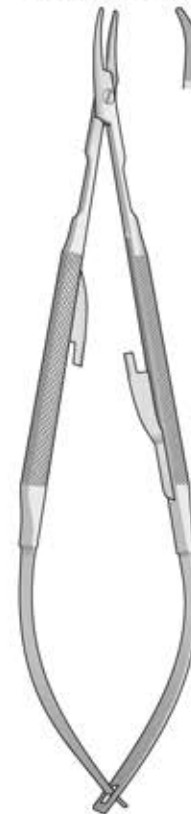

BARRAQUER
FD-24
135 mm

Glattes Maul - Smooth jaws
Con morso liscio - Mandibula lisa
A' mors lisses

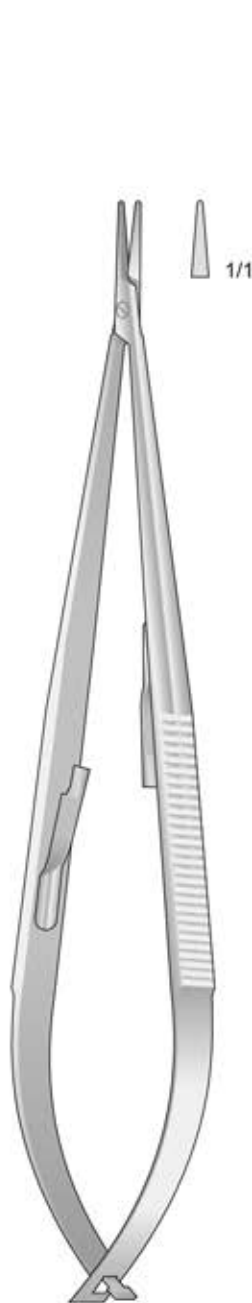

JACOBSON
FD-63
180 mm

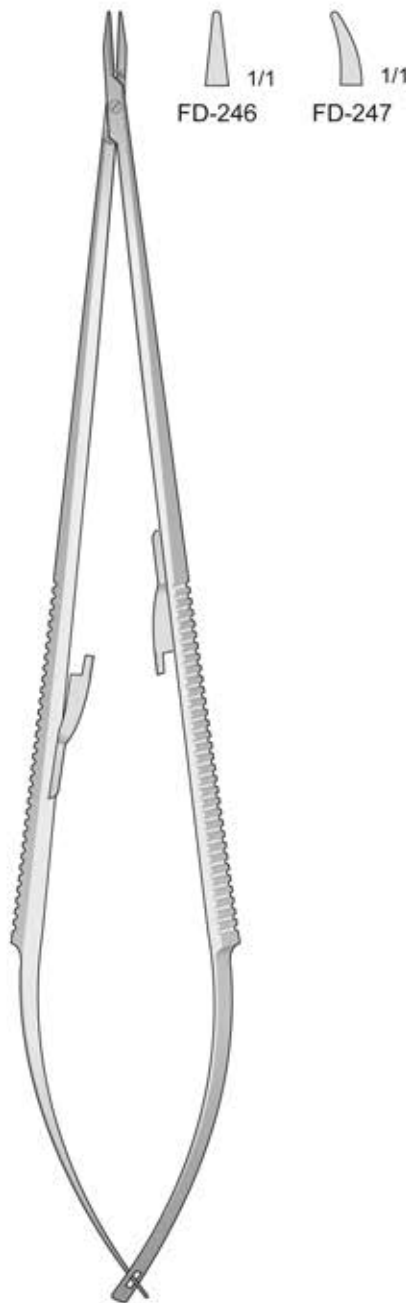

FD-246/FD-247
225 mm

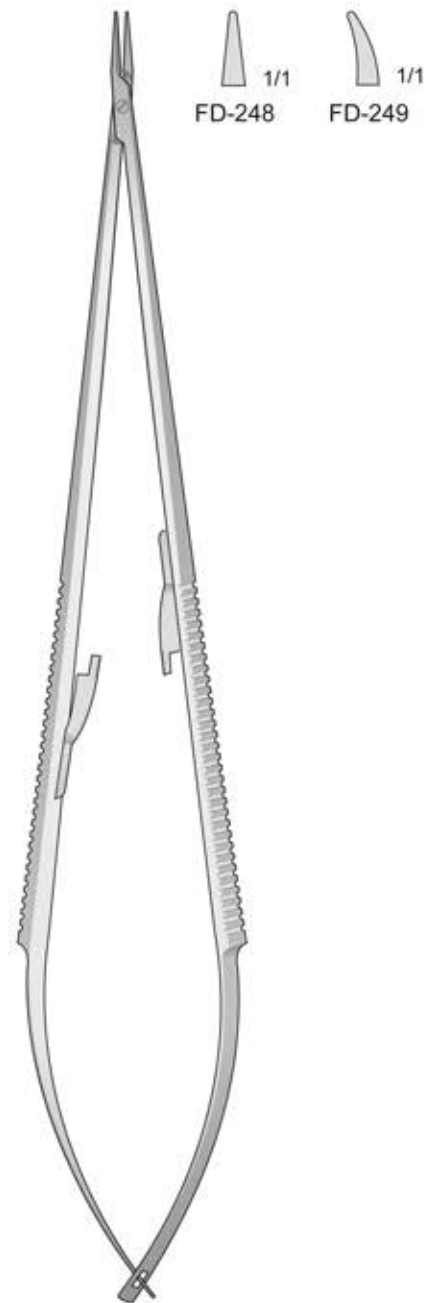

FD-248/FD-249
225 mm

Mikro Nadelhalter

Micro Needle Holders

Micro port'aghi

Micro portaagujas

Micro porte aiguilles

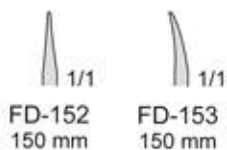

Glattes Maul
Smooth jaws
Con morso liscio
Mandibula lisa
A' mors lisses

BARRAQUER
FD-152/FD-153
150 mm

Glattes Maul
Smooth jaws
Con morso liscio
Mandibula lisa
A' mors lisses

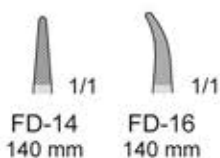

FD-14/FD-16
140 mm

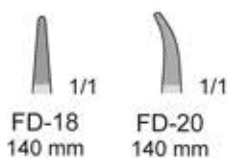
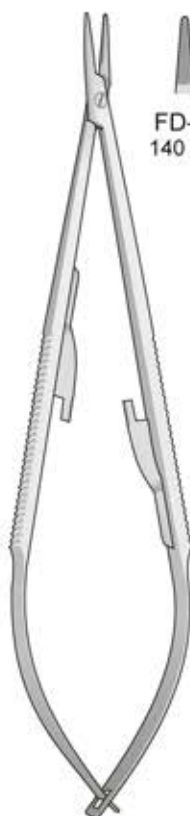

CASTROVIEJO
FD-18/FD-20
140 mm

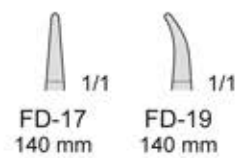
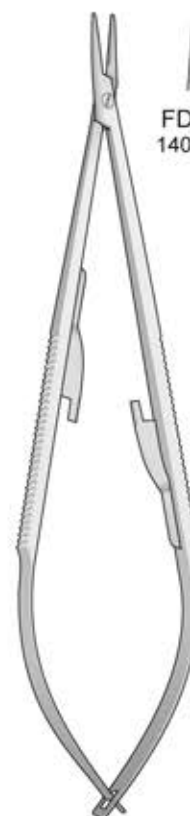

CASTROVIEJO
FD-17/FD-19
140 mm

Nadelhalter mit Hartmetalleinlagen
 Needle Holders with tungsten-carbide inserts
 Portaghi con inserti al tungsteno
 Portaagujas con plaquitas de carburo de tungsteno
 Porte aiguilles avec plaquettes en carbure de tungstène

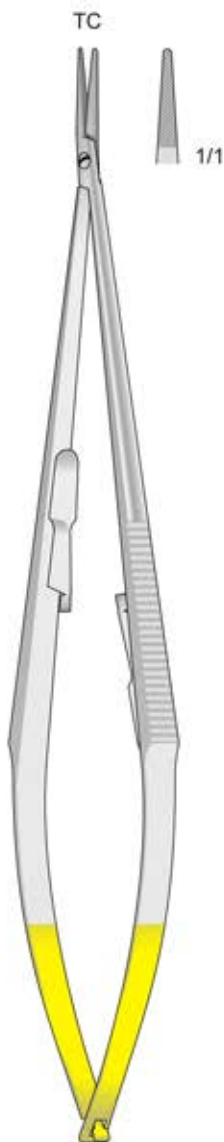

CASTROVIEJO
FD-27
215 mm

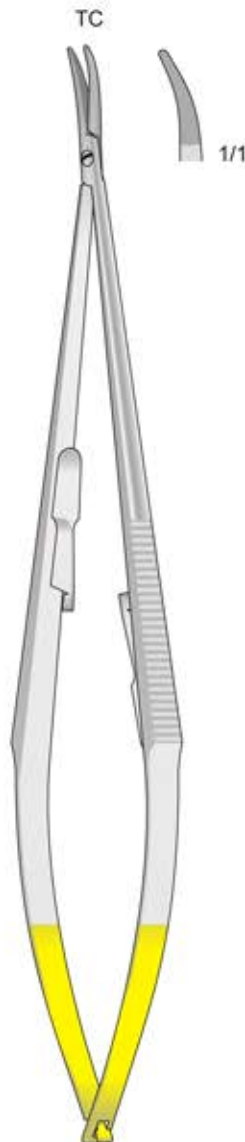

CASTROVIEJO
FD-128
215 mm

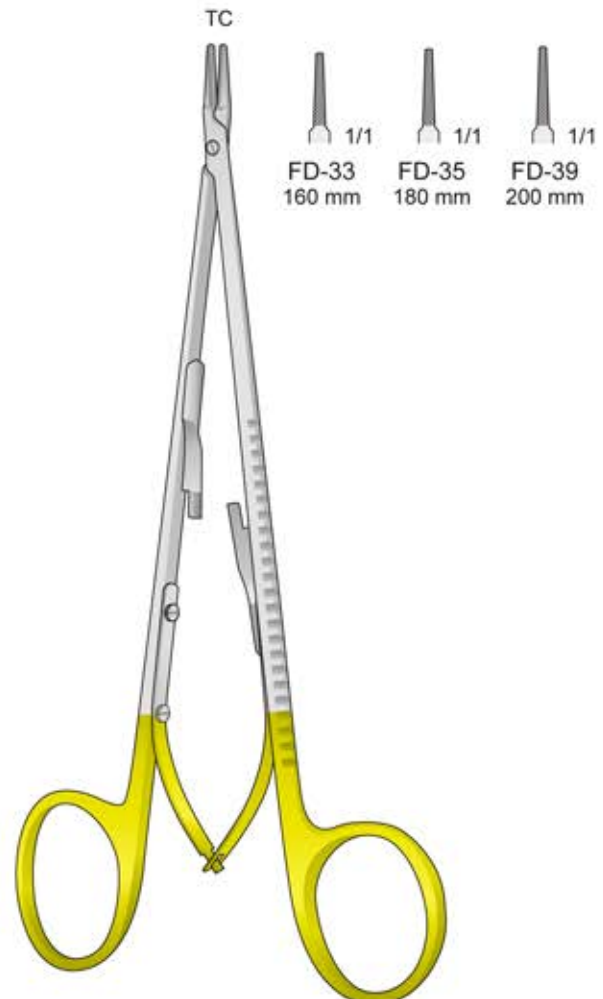

DIETRICH
FD-33/FD-39

Glattes Maul
With smooth jaws
Con morso liscio
Con mandibula lisa
Avec mors lisses

Glattes Maul
With smooth jaws
Con morso liscio
Con mandibula lisa
Avec mors lisses

Nadelhalter mit Hartmetalleinlagen
Needle Holders with tungsten-carbide inserts
Portaghi con inserti al tungsteno
Portaagujas con plaquitas de carburo de tungsteno
Porte aiguilles avec plaquettes en carbure de tungstène

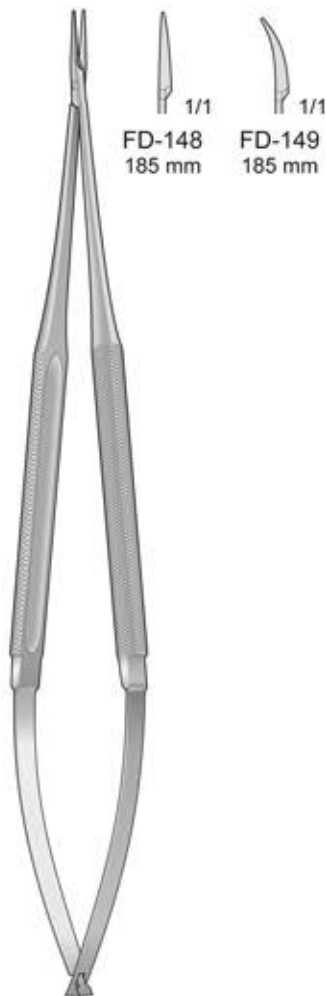

FD-148/FD-149
185 mm

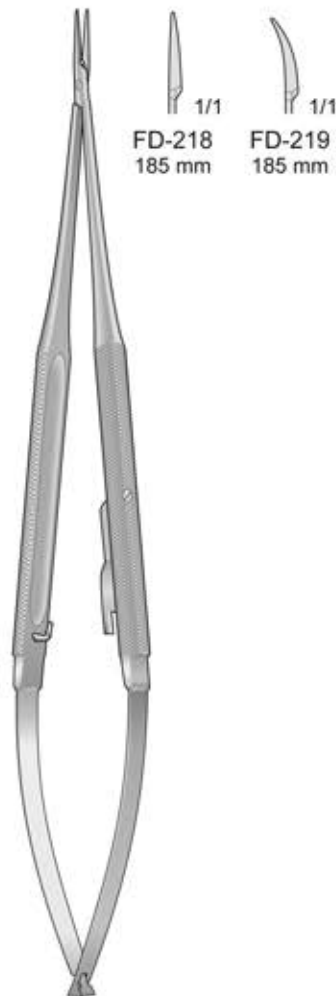

FD-218/FD-219
185 mm



JACOBSON
FD-30/FD-32
180 mm

Nadelhalter mit Hartmetalleinlagen
 Needle Holders with tungsten-carbide inserts
 Portaghi con inserti al tungsteno
 Portaagujas con plaquitas de carburo de tungsteno
 Porte aiguilles avec plaquettes en carbure de tungstène

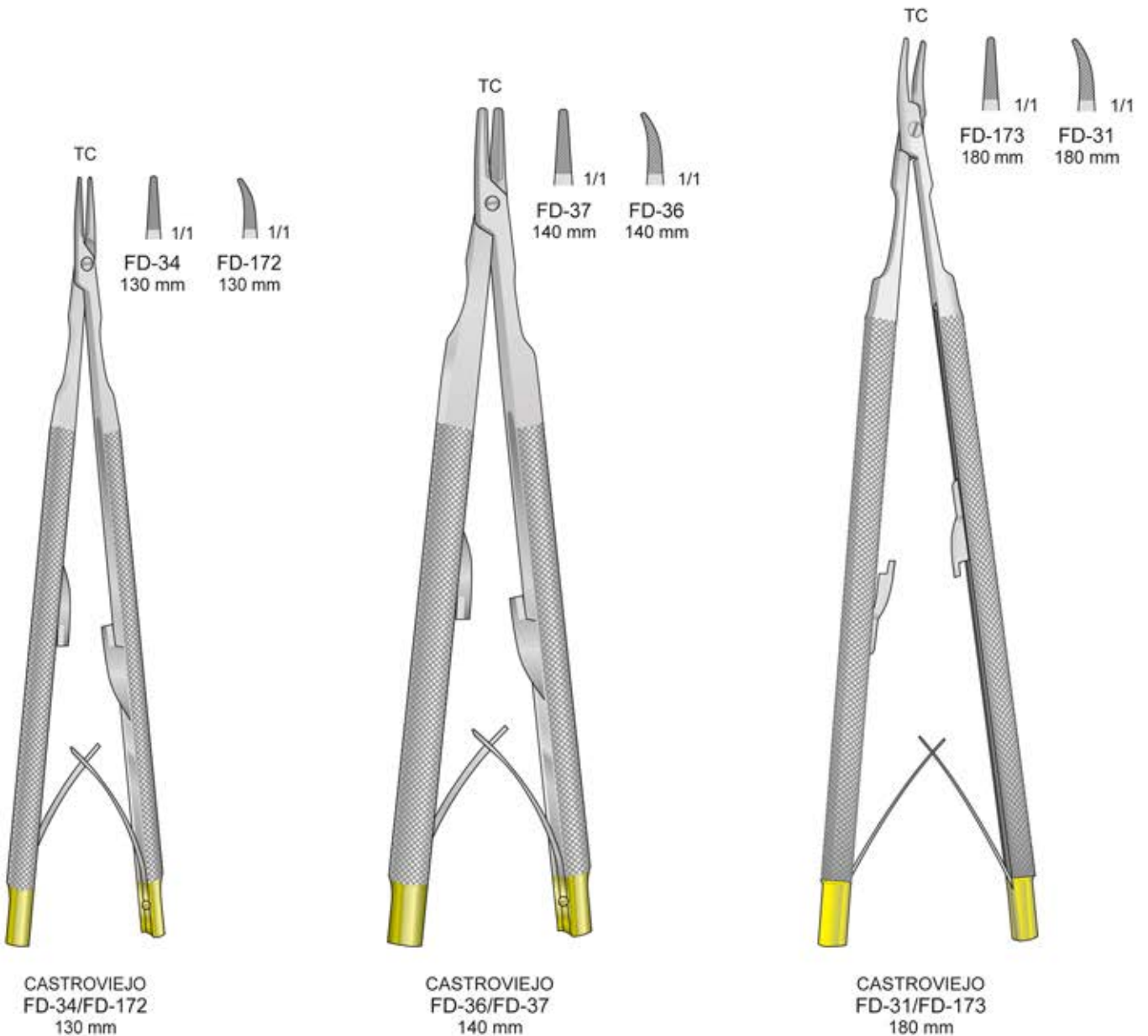

Nadelhalter

Needle Holders

Port'aghi

Portaagujas

Porte aiguilles

Glattes Maul
With smooth jaws
Con morso liscio
Con mandibula lisa
Avec mors lisses

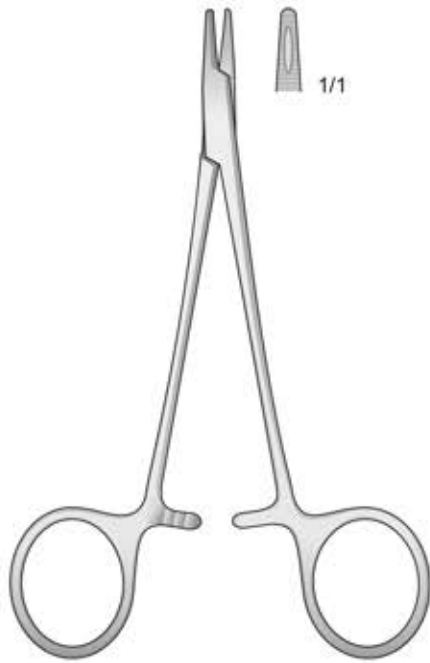

DERF
PH-39
125 mm

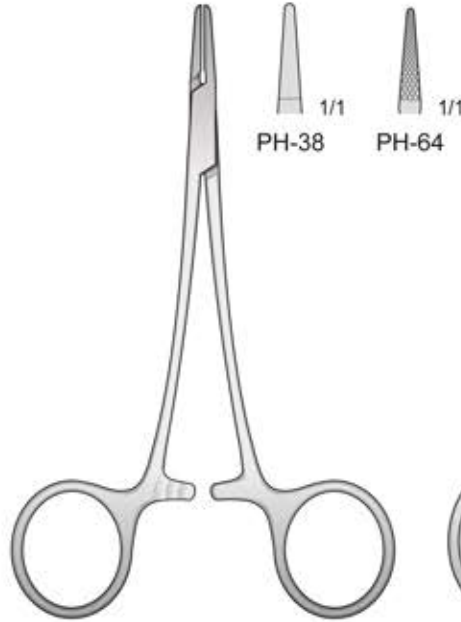

PH-38/PH-64
120 mm

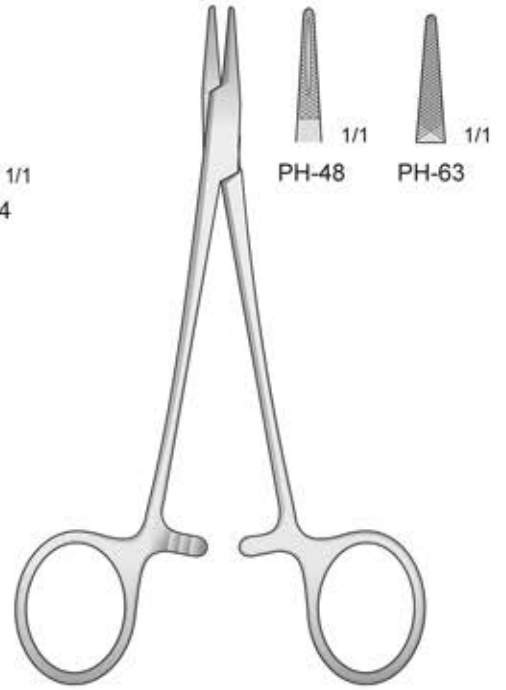

HALSEY
PH-48/PH-63
130 mm

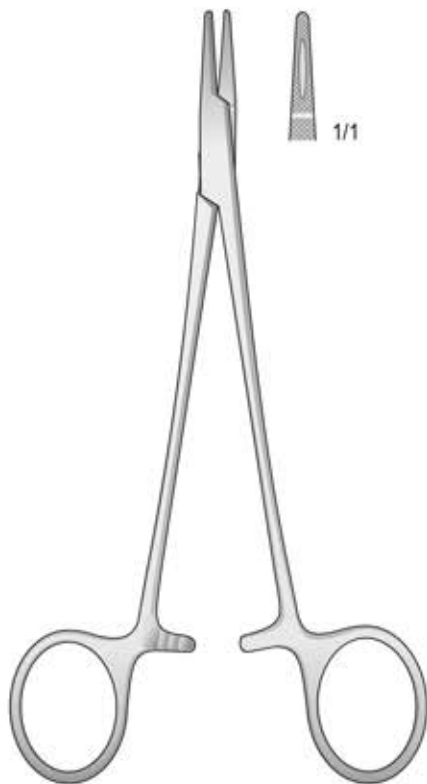

CRILE-WOOD
PH-61
150 mm

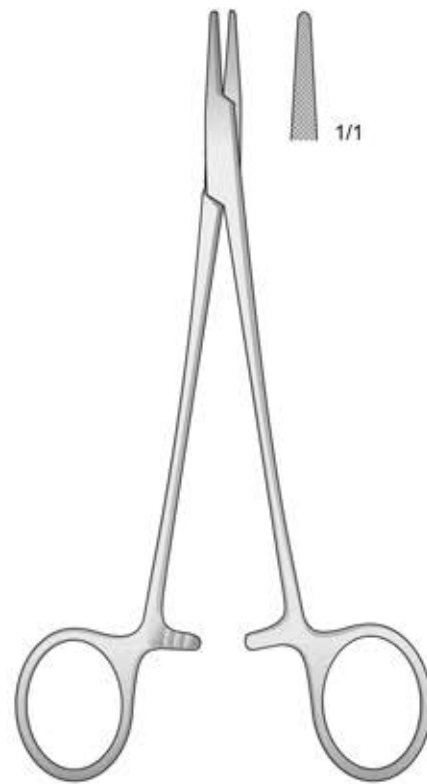

CRILE-MURRAY
PH-62
150 mm

Schlankes Modell - Delicate pattern - Modello fine
Modelo delegado - Modèle fin

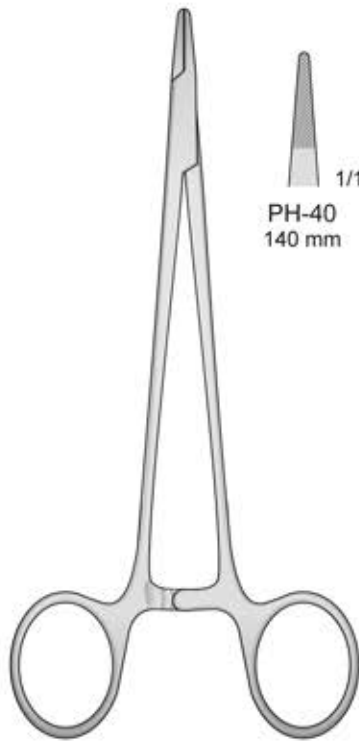

MAYO-HEGAR
PH-40/PH-45

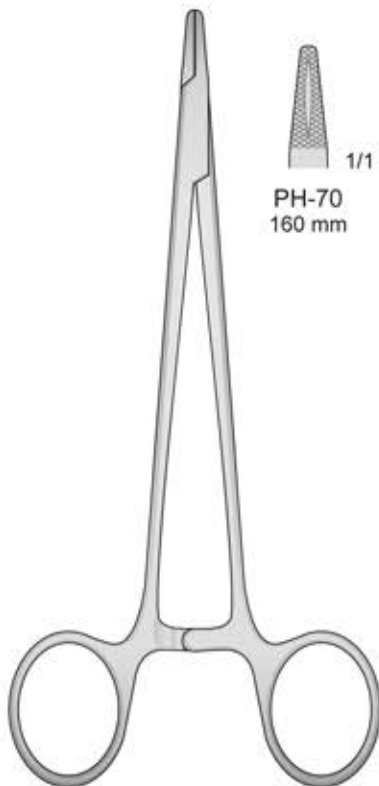
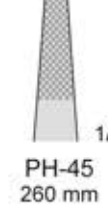
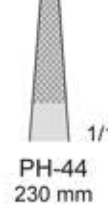
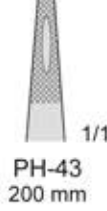
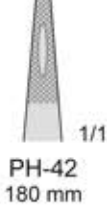
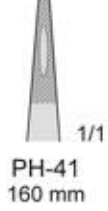
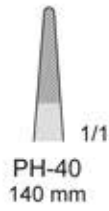

HEGAR
PH-70/PH-78

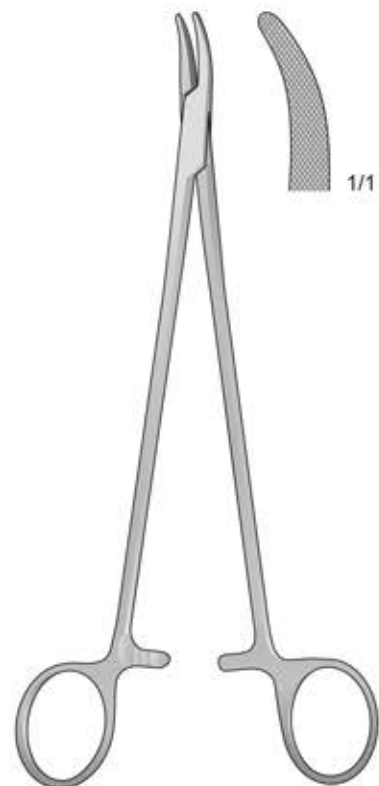
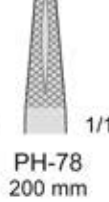
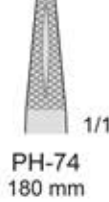
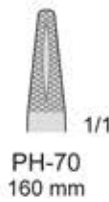

HEANEY (HEGAR)
PH-52
200 mm



Nadelhalter mit Schere - Needle holders with scissors
Port'aghi con forbici - Portaagujas con tijeras
Porte aiguilles avec ciseaux



MINI-OLSEN-HEGAR
BM-61
120 mm



OLSEN-HEGAR
BM-62
140 mm



OLSEN-HEGAR
BM-63
170 mm



OLSEN-HEGAR
BM-64
190 mm

Nadelhalter mit Schere

Needle holders with
scissors

Port'aghi con forbici

Portaagujas con tijeras

Porte aiguilles avec
ciseaux

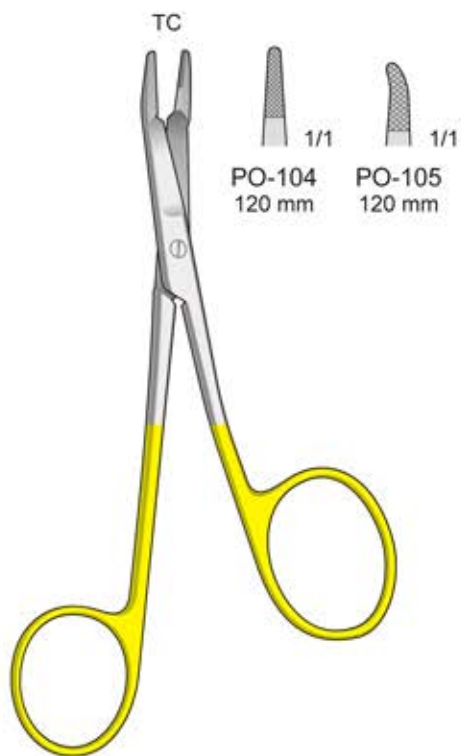

FOSTER-GILLIES
PO-104/PO-105
120 mm

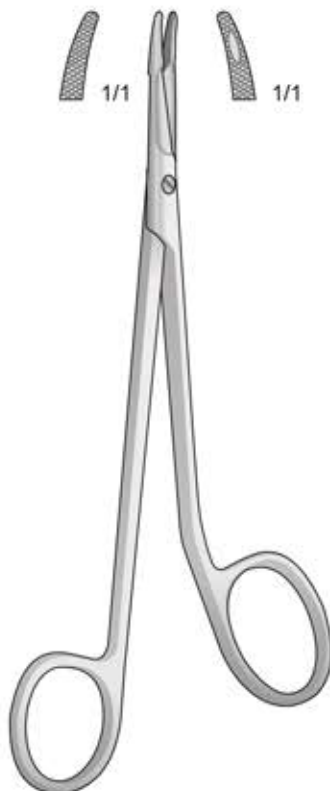

MINI-GILLIES
PO-59
145 mm

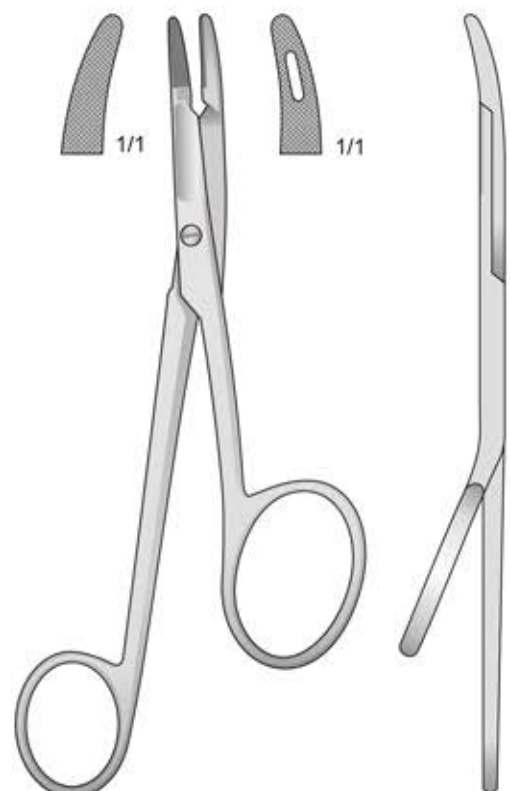

GILLIES
PO-89
160 mm

Nadelhalter mit Hartmetalleinlagen - Needle Holders with tungsten-carbide inserts
 Portaghi con inserti al tungsteno - Portaagujas con plaquitas de carburo de tungsteno
 Porte aiguilles avec plaquettes en carbure de tungstène

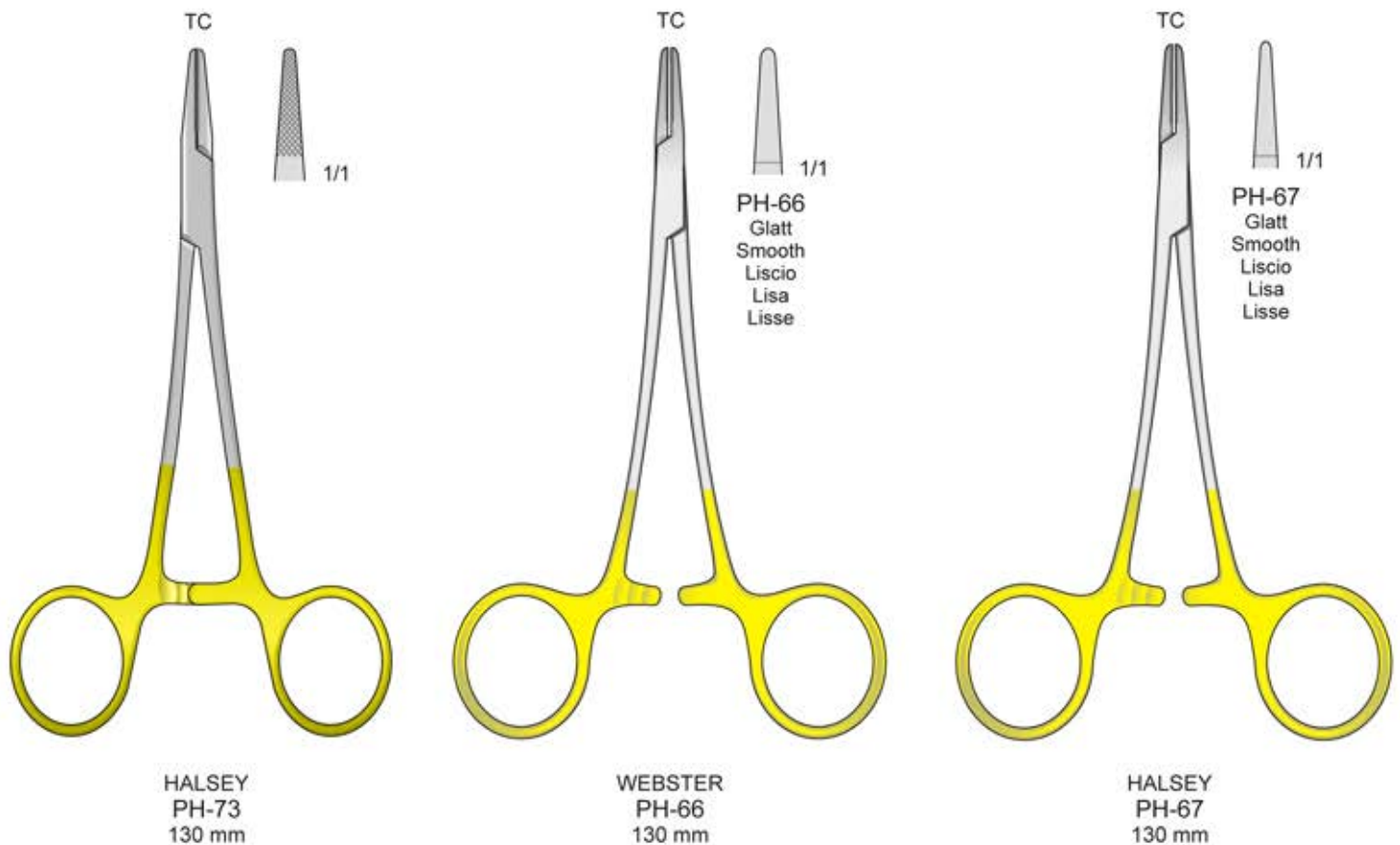
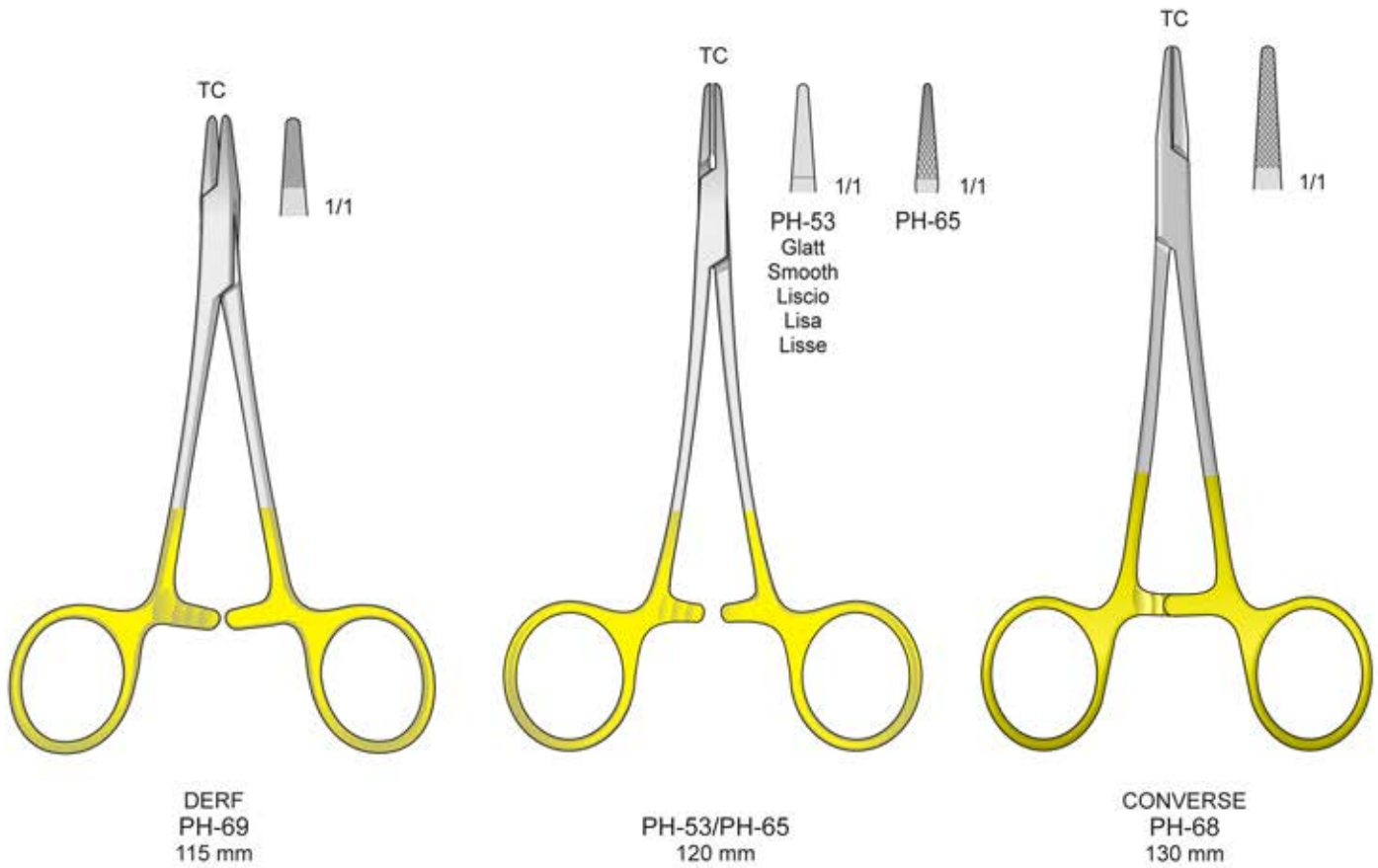

Nadelhalter

Needle Holders

Port'aghi

Portaagujas

Porte aiguilles

Nadelhalter mit Hartmetalleinlagen - Needle Holders with tungsten-carbide inserts
 Portaghi con inserti al tungsteno - Portaagujas con plaquitas de carburo de tungsteno
 Porte aiguilles avec plaquettes en carbure de tungstène

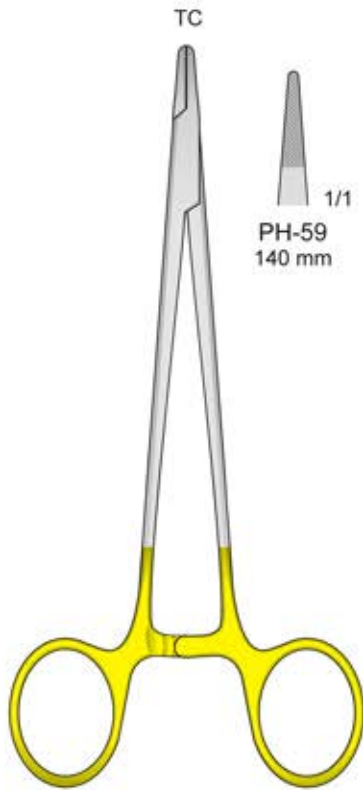

HEGAR
PH-59/PH-76

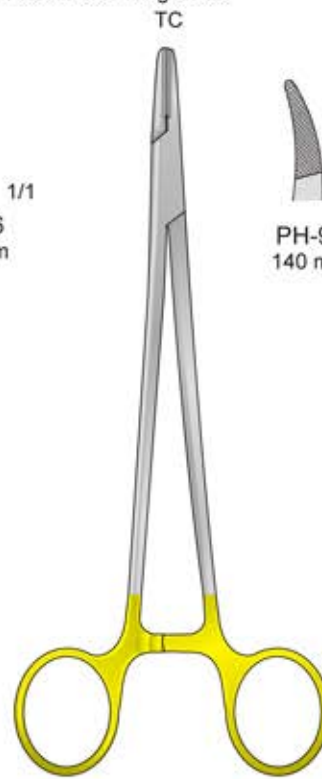
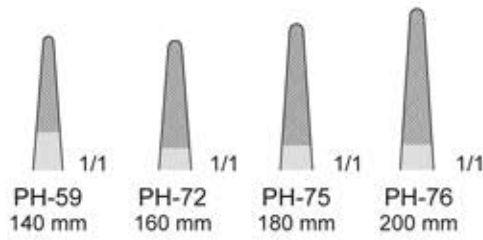

MAYO-HEGAR-HEANEY
PH-95/PH-97

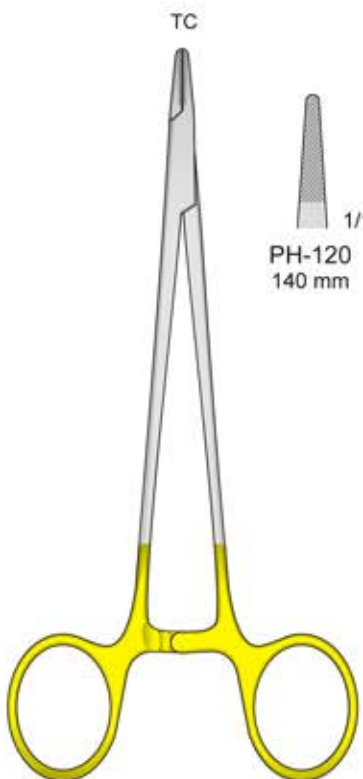
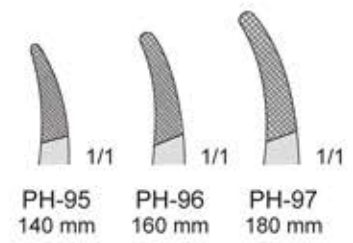

MAYO-HEGAR
PH-120/PH-125

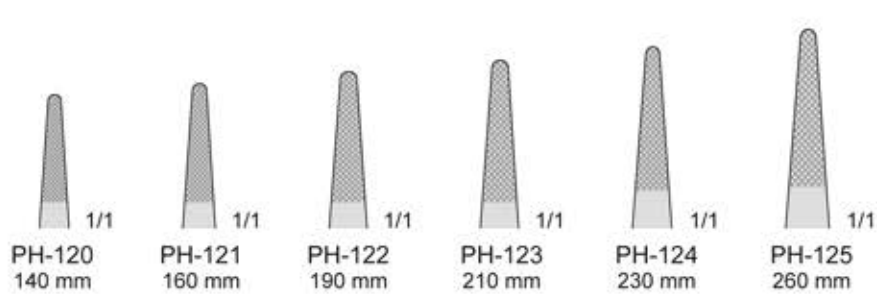

Nadelhalter

Needle Holders

Port'aghi

Portaagujas

Porte aiguilles

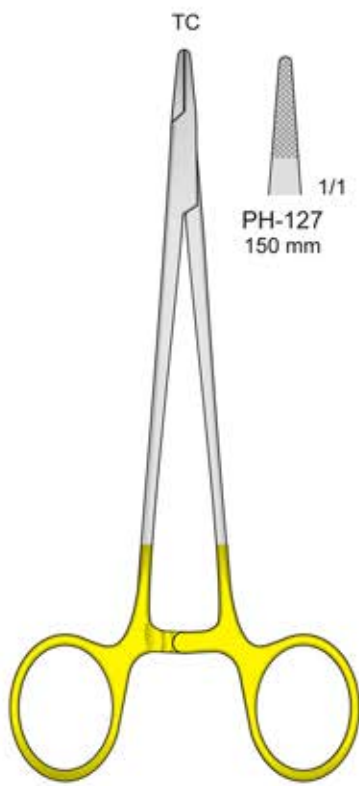

MAYO-HEGAR-FINO
PH-127/PH-129

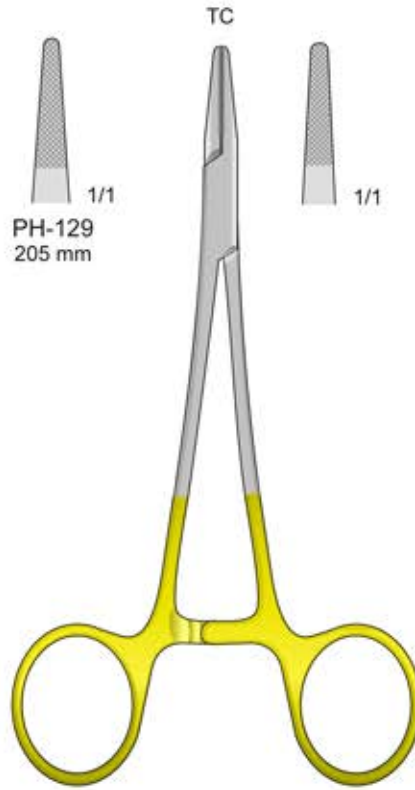
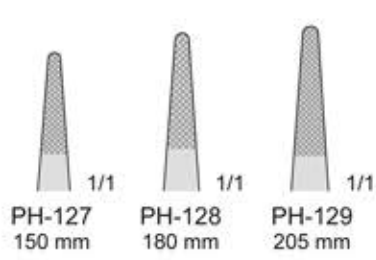

CRILE-WOOD
PH-77
180 mm



CRILE-WOOD
PH-90
150 mm

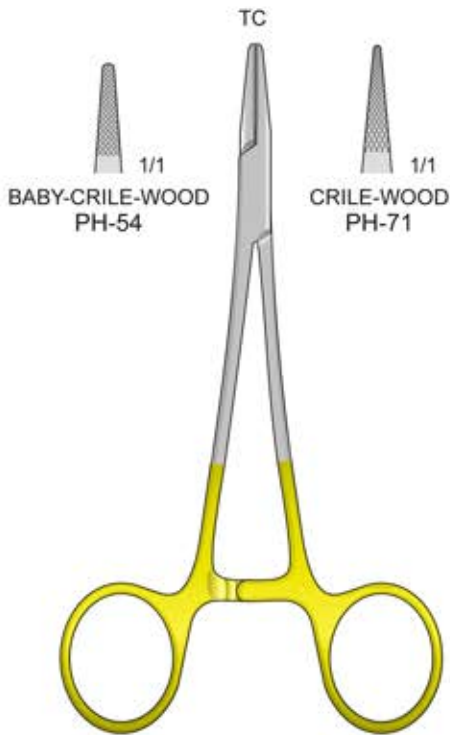

CRILE-WOOD
PH-54/PH-71
150 mm

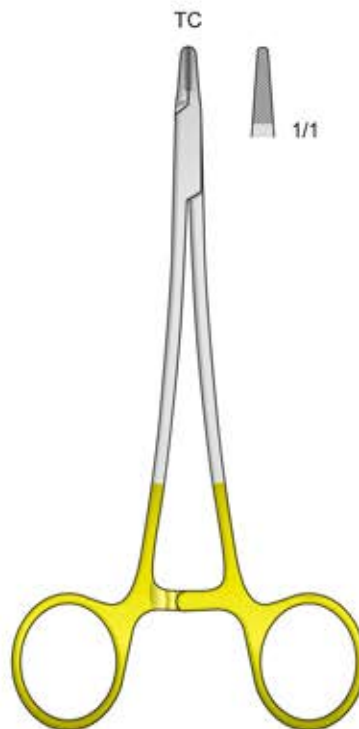
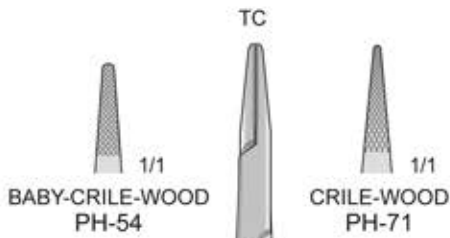

PH-79
145 mm

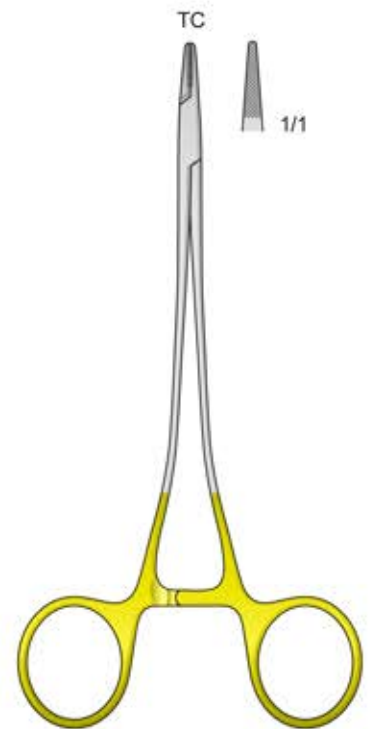

PH-85
150 mm



Nadelhalter mit Schere

Needle holders with
scissors

Port'aghi con forbici

Portaagujas con tijeras

Porte aiguilles avec
ciseaux

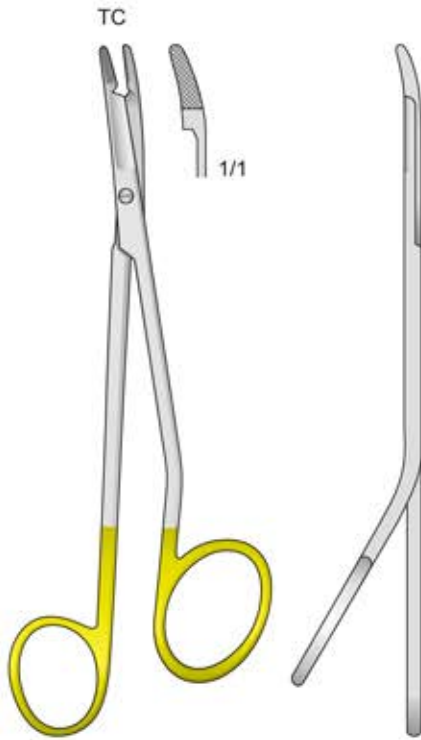

MINI-GILLIES
PO-99
145 mm

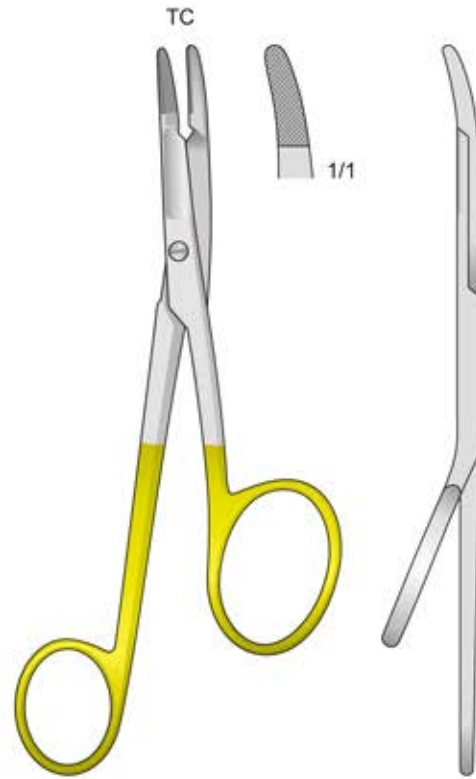

GILLIES
PO-97
160 mm

Für Linkshänder - Left Handed
Per mancini - Pour gauche - Para zurdos

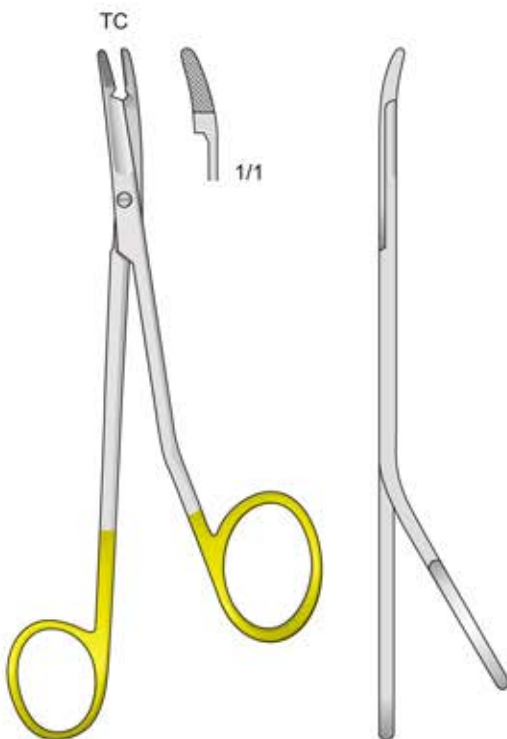

MINI-GILLIES
PO-99L
145 mm

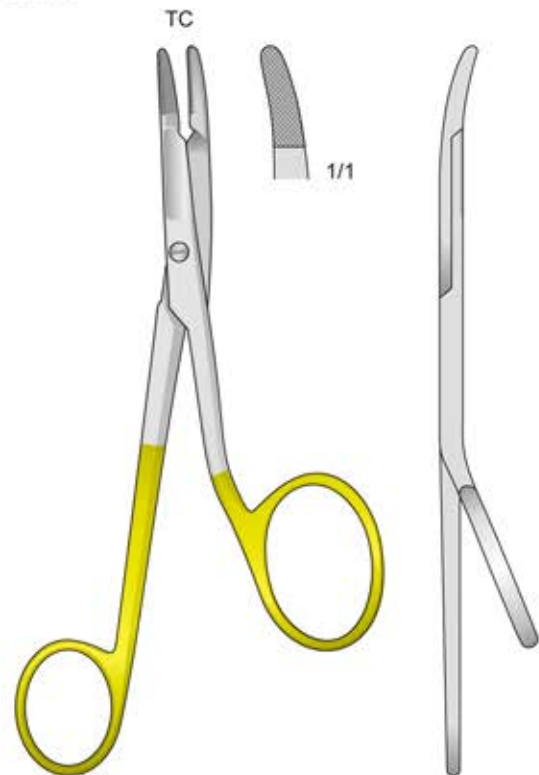

GILLIES
PO-97L
160 mm

Nadelhalter

Needle Holders

Port'aghi

Portaagujas

Porte aiguilles

Nadelhalter mit Hartmetalleinlagen - Needle Holders with tungsten-carbide inserts
 Portaghi con inserti al tungsteno - Portaagujas con plaquitas de carburo de tungsteno
 Porte aiguilles avec plaquettes en carbure de tungstène

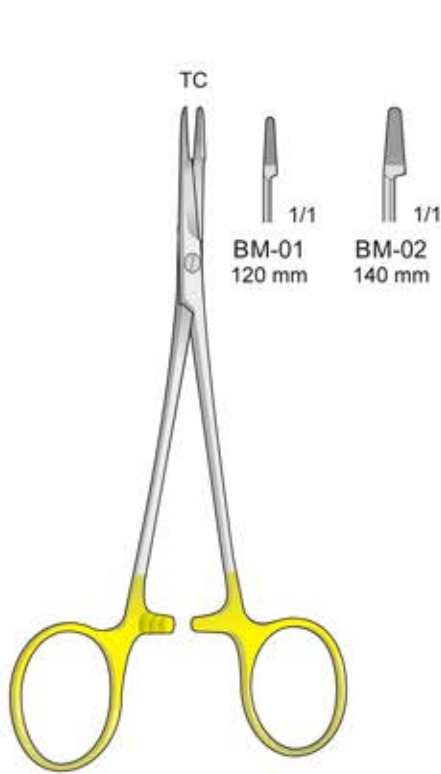

OLSEN-HEGAR
BM-01/BM-02

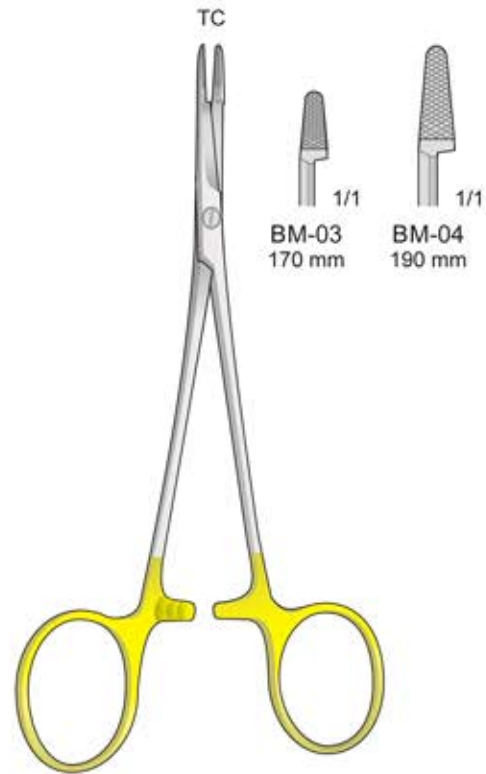

OLSEN-HEGAR
BM-03/BM-04

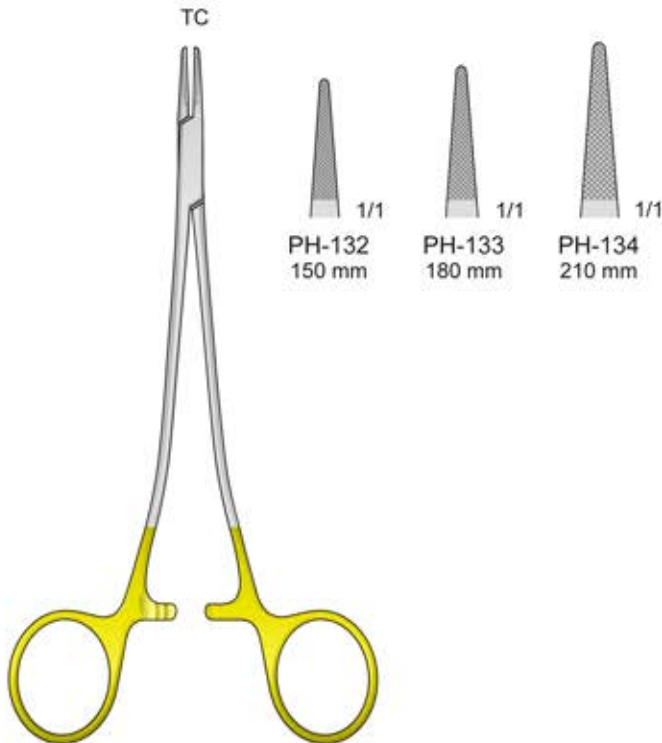

SAROT
PH-132/PH-134

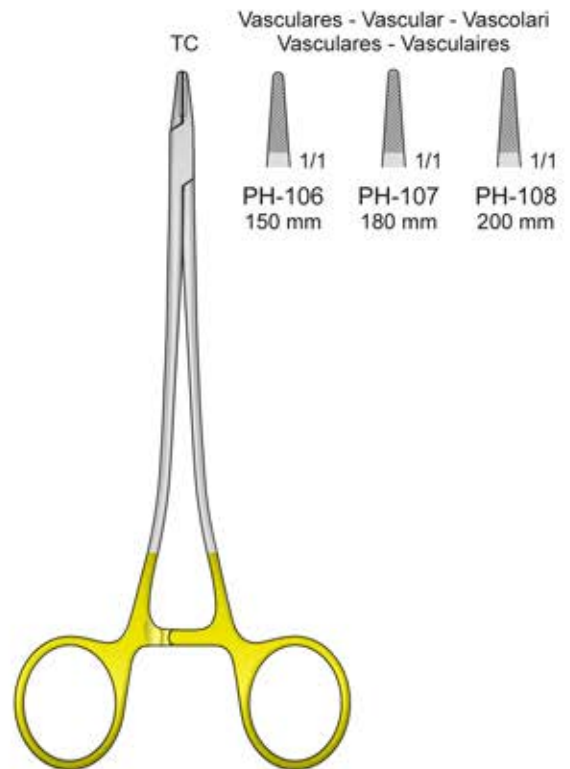

SWEDESH MOD.
PH-106/PH-108

Nadelhalter mit Hartmetalleinlagen - Needle Holders with tungsten-carbide inserts
 Portaghi con inserti al tungsteno - Portaagujas con plaquitas de carburo de tungsteno
 Porte aiguilles avec plaquettes en carbure de tungstène

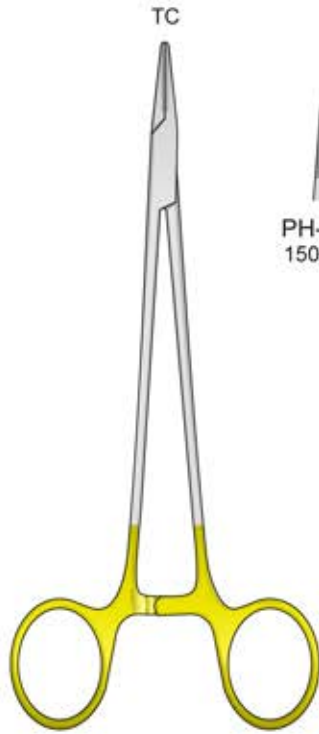

MICRO-VASCULAR
PH-101/PH-104

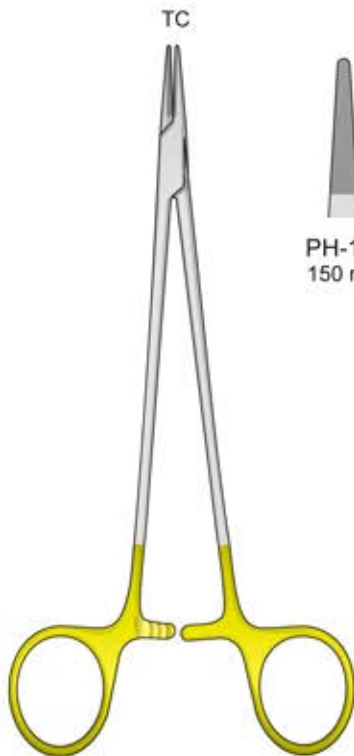
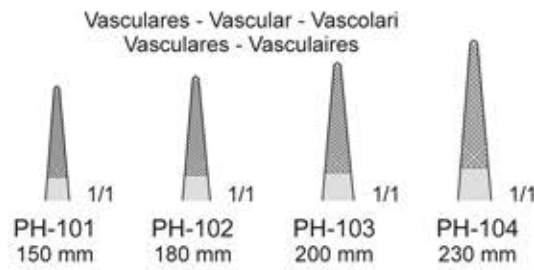

DE BAKLEY
PH-109/PH-114

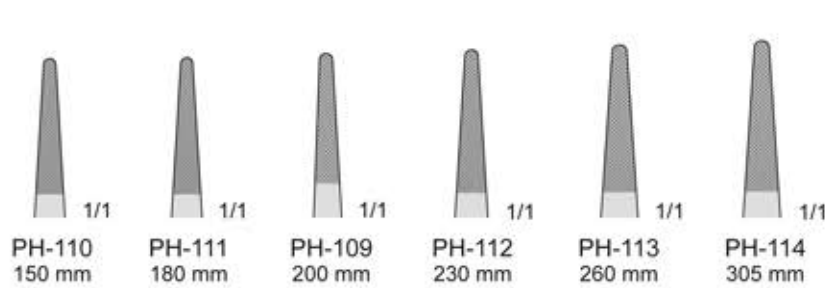

Nadelhalter mit Hartmetalleinlagen - Needle Holders with tungsten-carbide inserts
 Portaghi con inserti al tungsteno - Portaagujas con plaquitas de carburo de tungsteno
 Porte aiguilles avec plaquettes en carbure de tungstène

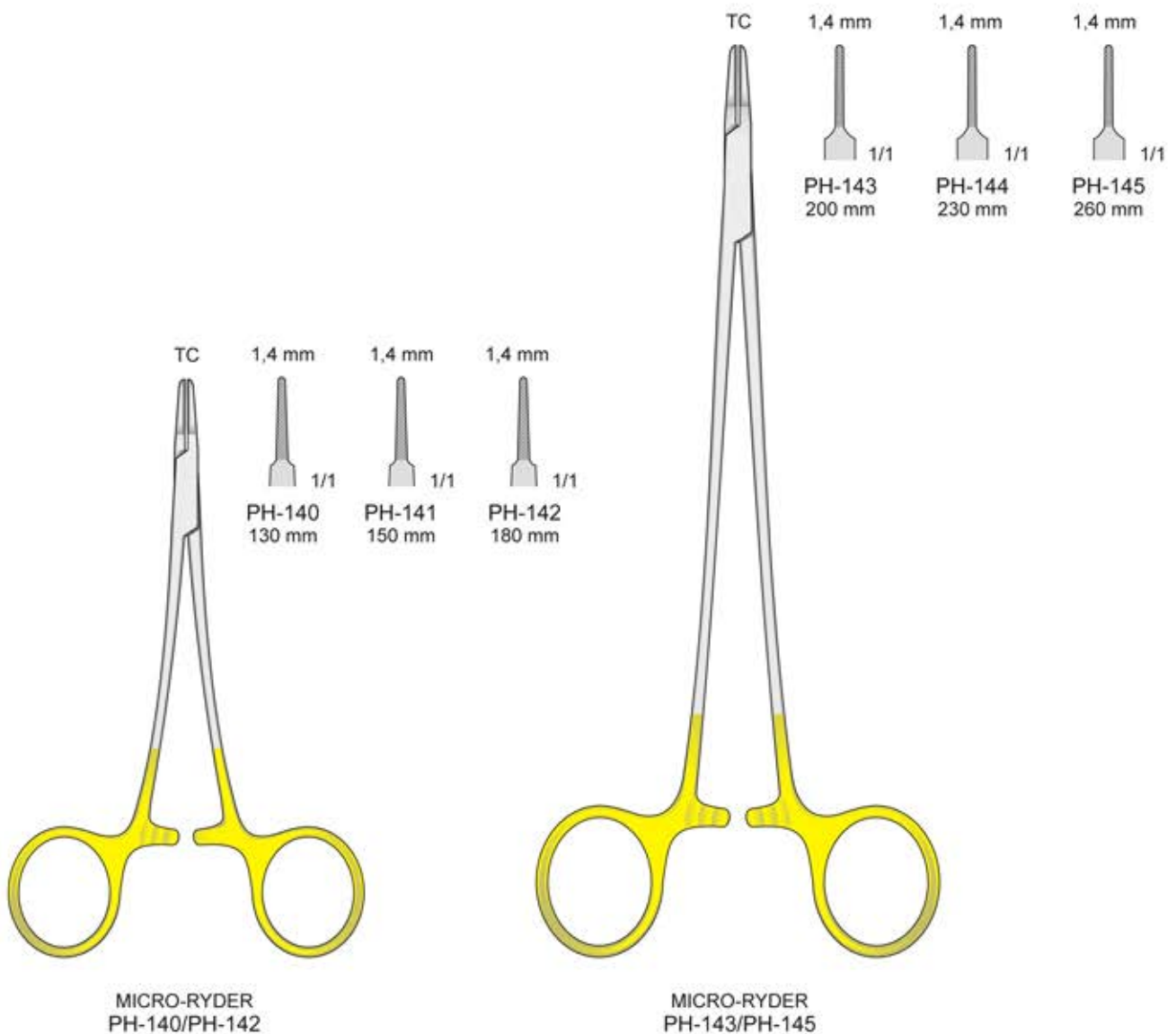

Nadelhalter mit Hartmetalleinlagen - Needle Holders with tungsten-carbide inserts
 Portaghi con inserti al tungsteno - Portaagujas con plaquitas de carburo de tungsteno
 Porte aiguilles avec plaquettes en carbure de tungstène

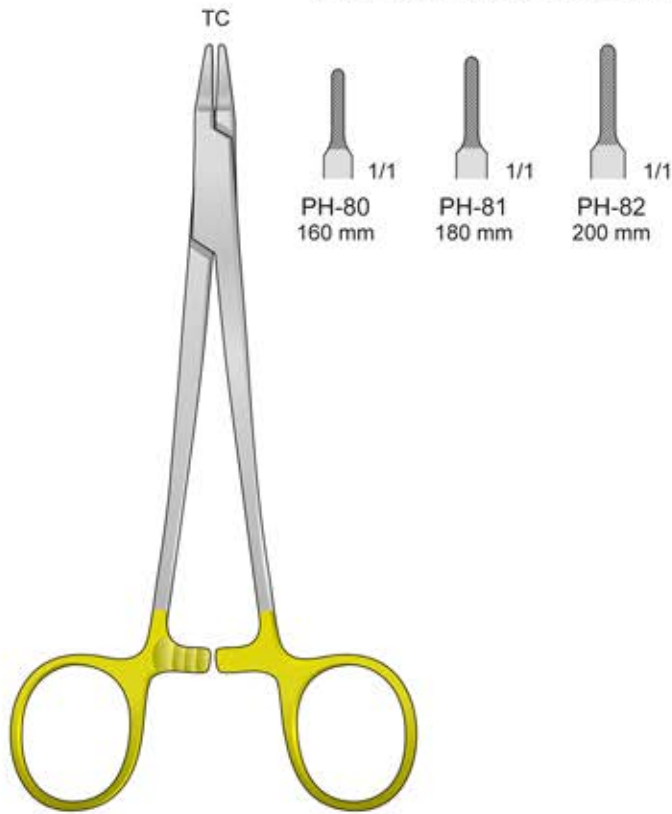

RYDER
PH-80/PH-82

Ein Ring Abgewinkelt
 One ring angled
 Un anello angolato
 Un anneau décalé

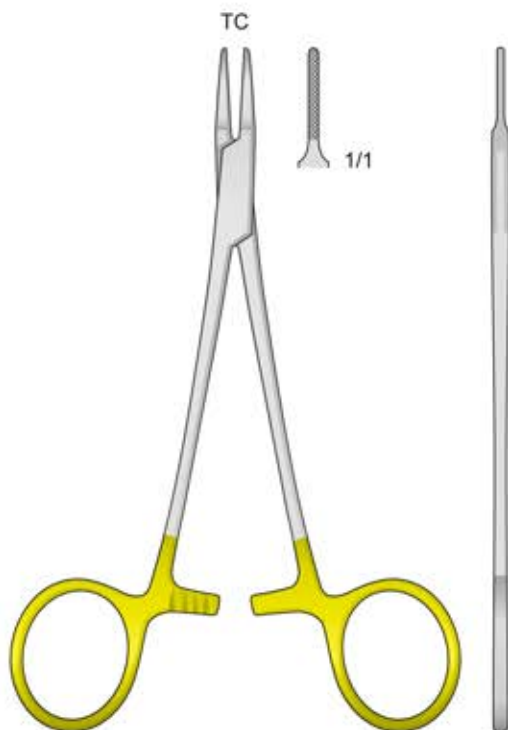

MICRO-RYDER
PH-83
140 mm

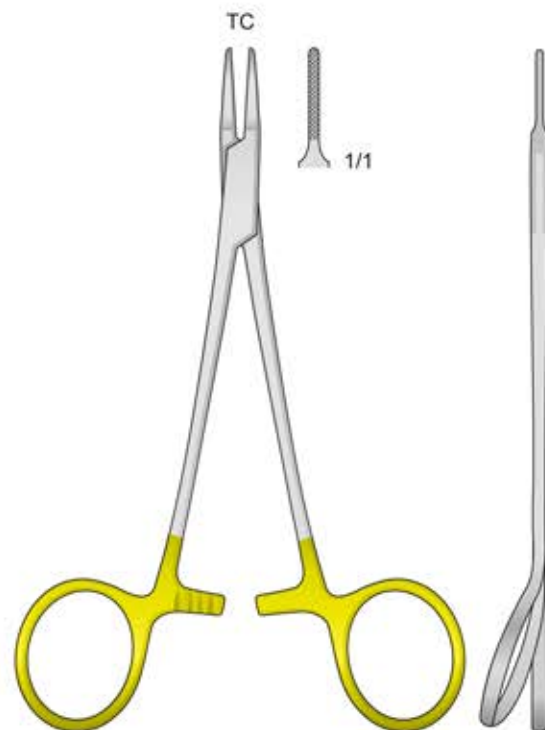

PH-84
140 mm

Nadelhalter

Needle Holders

Port'aghi

Portaagujas

Porte aiguilles

Nadelhalter mit Hartmetalleinlagen - Needle Holders with tungsten-carbide inserts
Port'aghi con inserti al tungsteno - Portaagujas con plaquitas de carburo de tungsteno
Porte aiguilles avec plaquettes en carbure de tungstène

Ein Ring abgewinkelt
One ring angled
Un anello angolato
Un anneau décalé

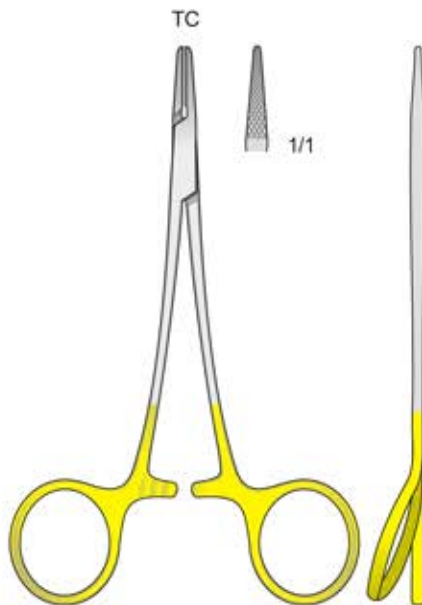

PH-99
120 mm

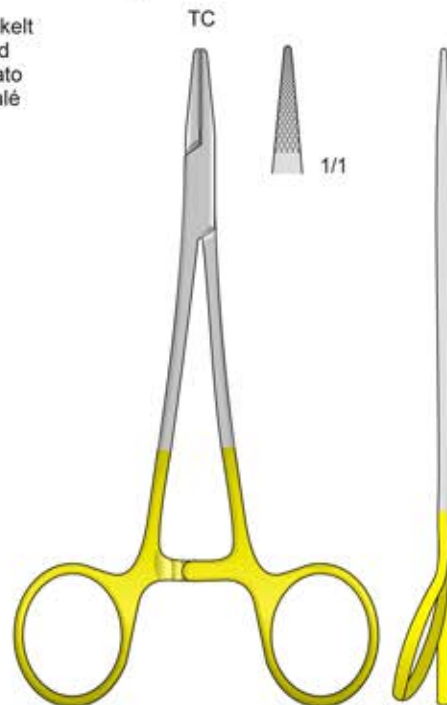

CRILE-WOOD
PH-100
150 mm



HEGAR-MAYO-SEELEY
PH-130
200 mm

Nadelhalter, Draht-Zangen - Needle holder, wire forceps
Port'aghi per fili d'acciaio - Porta agujas, pinzas para hilos
Porte-aiguilles, pinces à saisir

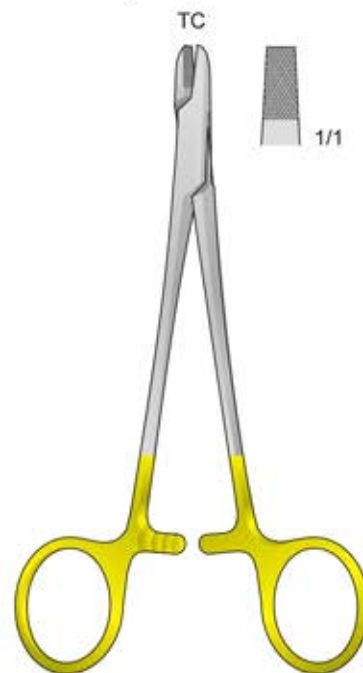

PH-58
150 mm

Nadelhalter mit Hartmetalleinlagen - Needle Holders with tungsten-carbide inserts
 Portaghi con inserti al tungsteno - Portaagujas con plaquitas de carburo de tungsteno
 Porte aiguilles avec plaquettes en carbure de tungstène

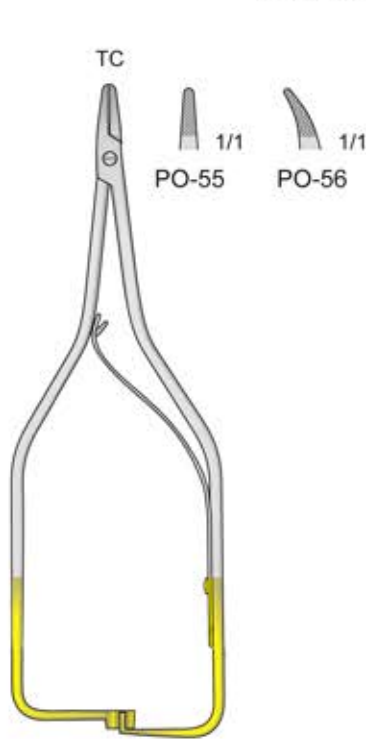

BOYNTON
PO-55/PO-56
120 mm

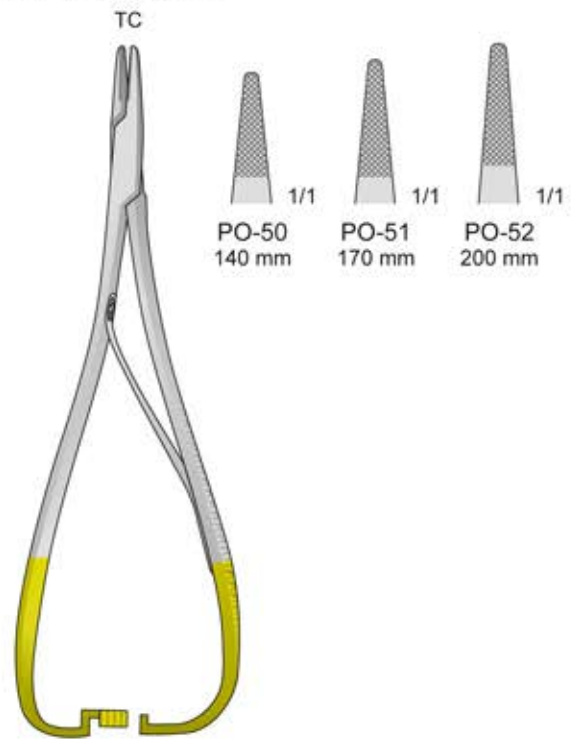

MATHIEU
PO-50/PO-52



LICHTENBERG
PO-86
175 mm

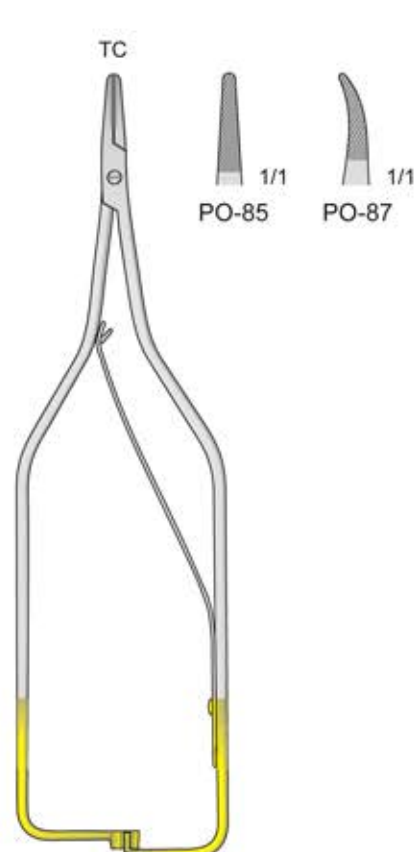

ARRUGA
PO-85/PO-87
160 mm

Gefäßclips

Vessel Clips

Clamps vascolari

Clamps vasculaires

Clamps vasculares

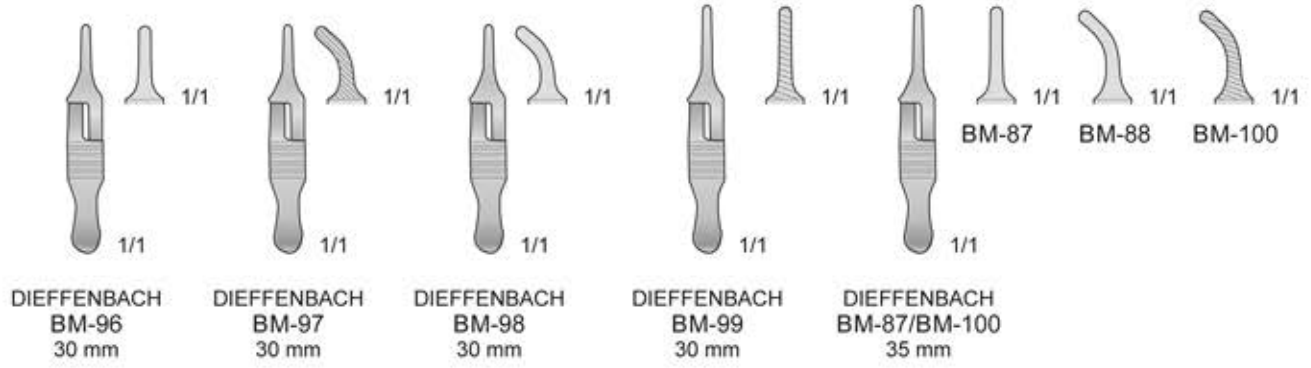

DIEFFENBACH
BM-96
30 mm

DIEFFENBACH
BM-97
30 mm

DIEFFENBACH
BM-98
30 mm

DIEFFENBACH
BM-99
30 mm

DIEFFENBACH
BM-87/BM-100
35 mm

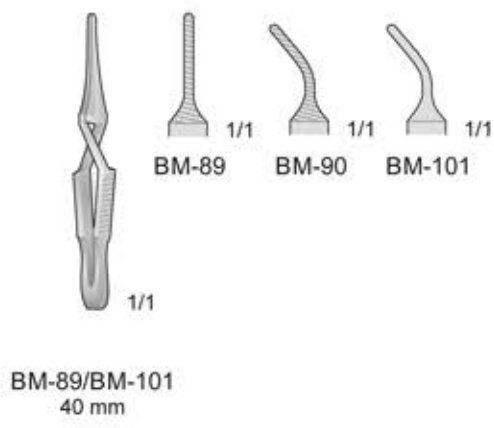

BM-89/BM-101
40 mm

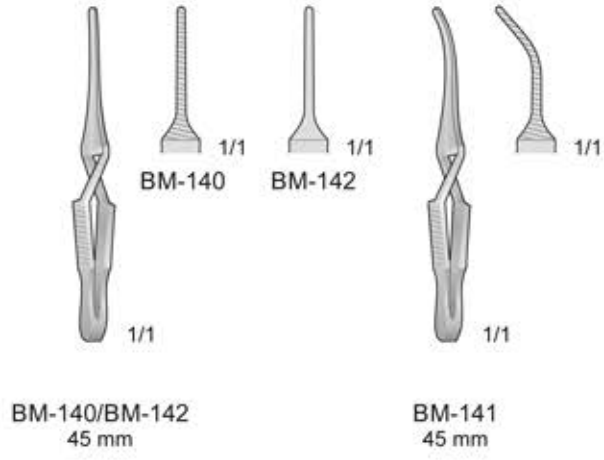

BM-140/BM-142
45 mm

BM-141
45 mm



BIEMER
FD-500/FD-502

	FD-500	4,0 mm	6,0 mm	30-40 gr.
	FD-501	5,0 mm	9,0 mm	30-40 gr.
	FD-502	5,0 mm	9,0 mm	20-25 gr.



MEDHORN
FD-503/FD-506

	FD-503	4 x 1,0 mm	10-15 gr.
	FD-504	4 x 1,4 mm	15-20 gr.
	FD-505	6 x 1,0 mm	10-15 gr.
	FD-506	6 x 1,4 mm	15-20 gr.

Gefäßklemmen Acland

Vascular Clamps Acland

Clamps Acland
Vascolari

Clamps vasculaires
Acland

Clamps vasculares
Acland

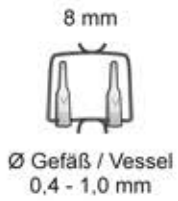

Einzelklemmen
Single Clamp



Vene - Vein
Arterie - Artery

FE-21
FE-22

Einzelklemmen
Single Clamp



FE-27
FE-28

Approximator
Approximator



FE-37
FE-38

Approximator
Approximator



FE-43
FE-44

Doppelklemmen
Double Clamp



FE-49
FE-50



Vene - Vein
Arterie - Artery

FE-23
FE-24



FE-29
FE-30



FE-39
FE-40



FE-45
FE-46

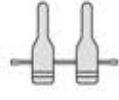

FE-51
FE-52



Vene - Vein
Arterie - Artery

FE-25
FE-26



FE-31
FE-32



FE-41
FE-42



FE-47
FE-48

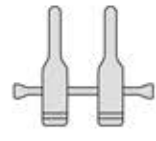

FE-53
FE-54



Vene - Vein
Arterie - Artery

FE-33
FE-34

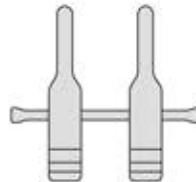

FE-55
FE-56

Klemmen-Anlegepinzette
Clamp Applying Forceps



Vene - Vein
Arterie - Artery

FE-35
FE-36

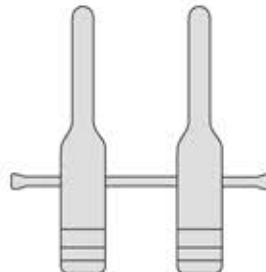

FE-57
FE-58

FE-59 mit Schloß, with lock
FE-60 ohne Schloß, without lock
140 mm

Approximatoren

Approximators

Approssimatori

Approximateurs

Approximatores

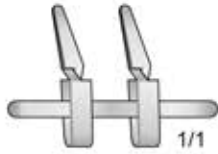

BIEMER-MÜLLER
FD-507/FD-511

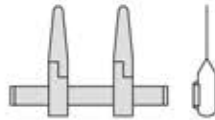

FD-507 5,0 mm 9,0 mm 25-30 gr.

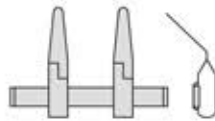

FD-508 5,0 mm 9,0 mm 25-30 gr.

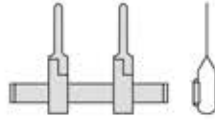

FD-509 5,0 mm 9,0 mm 25-30 gr.

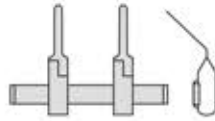

FD-510 5,0 mm 9,0 mm 25-30 gr.

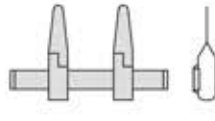

FD-511 3,5 mm 4,5 mm 25-30 gr.

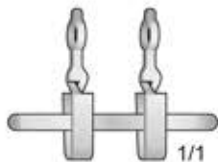

MÜLLER
FD-512/FD-515

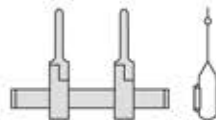

FD-512 Ø 1,0 mm 25-30 gr.

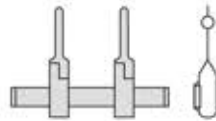

FD-513 Ø 2,0 mm 25-30 gr.

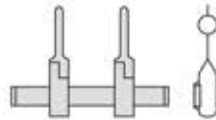

FD-514 Ø 3,0 mm 25-30 gr.

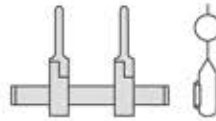

FD-515 Ø 4,0 mm 25-30 gr.

Schlüssel
Key - Chiave
Llave - Clef

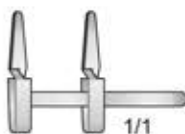

BIEMER
FD-517



FD-518



BIEMER
FD-519

FD-517
Approximator allein
Approximator only
FD-518
Approximator mit Schlüssel
Approximator with key
FD-519
Approximator mit Schlüssel
Approximator with key
FD-520
1 Paar Ersatznadeln
1 Pair of spare needles

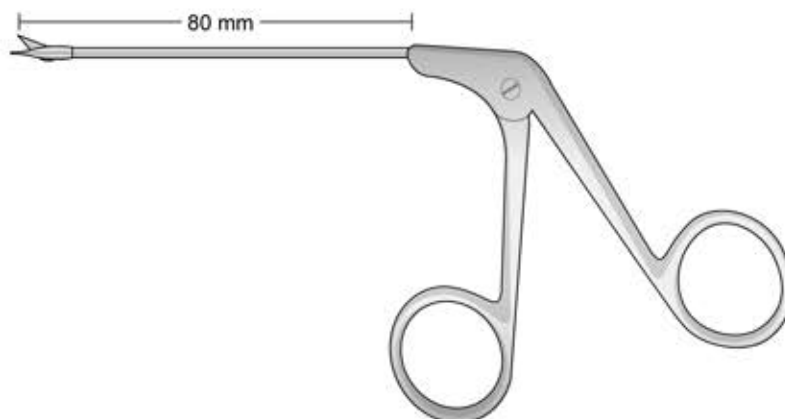
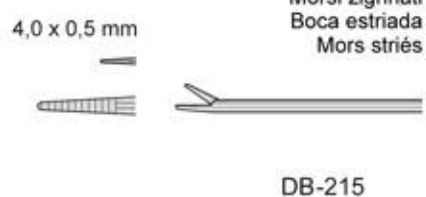
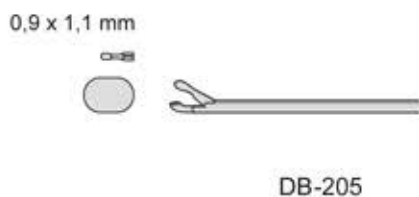
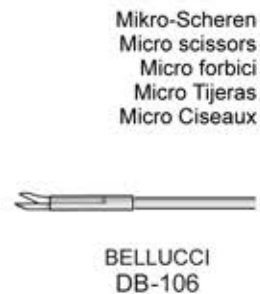
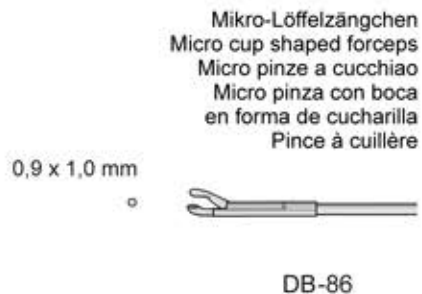

DB-86/DB-215
80 mm



OBWEGESER
DO-30
140 mm

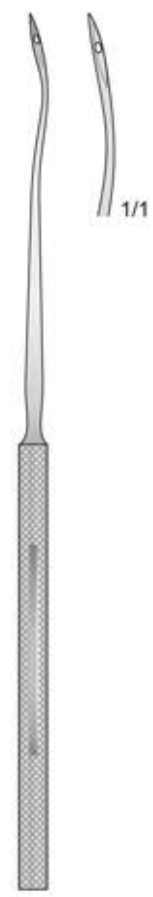

YANKAUER
BM-151
170 mm

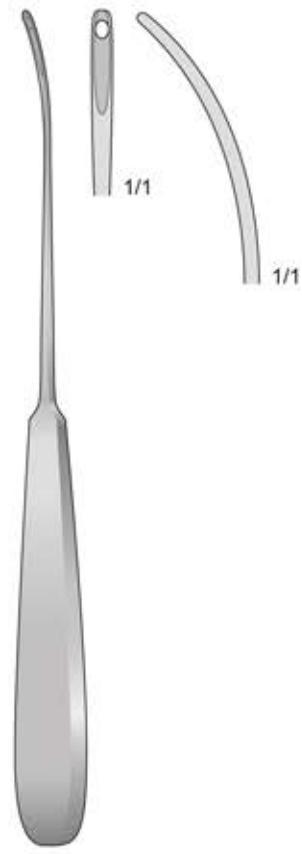

BM-28
200 mm

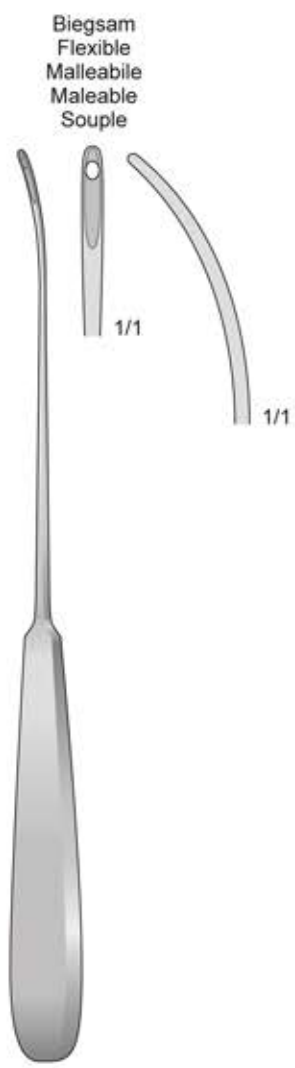

BM-74
230 mm



OBWEGESER
DO-31
230 mm

Sonden

Probes

Sonde bottonute

Estiletos

Sondes

Ø 1 mm



Ø 1,5 mm



Ø 2 mm



Ø 2 mm



Ø 1,5 mm



Ø 1,0 mm



Aus Silber
Sterling Silver
In argento
De plata en argent



PF-20 145 mm
PF-21 160 mm

PF-32 130 mm
PF-22 145 mm
PF-25 160 mm
PF-26 200 mm

PF-27 145 mm
PF-23 160 mm
PF-28 200 mm
PF-44 250 mm

PF-36 130 mm
PF-15 145 mm
PF-29 160 mm
PF-38 200 mm

PF-7
145 mm

STACKE
PF-14
110 mm

BOWMANN
PF-30 00/0 PF-34 5/6
PF-31 1/2 PF-35 7/8
PF-33 3/4 PF-37 6/7

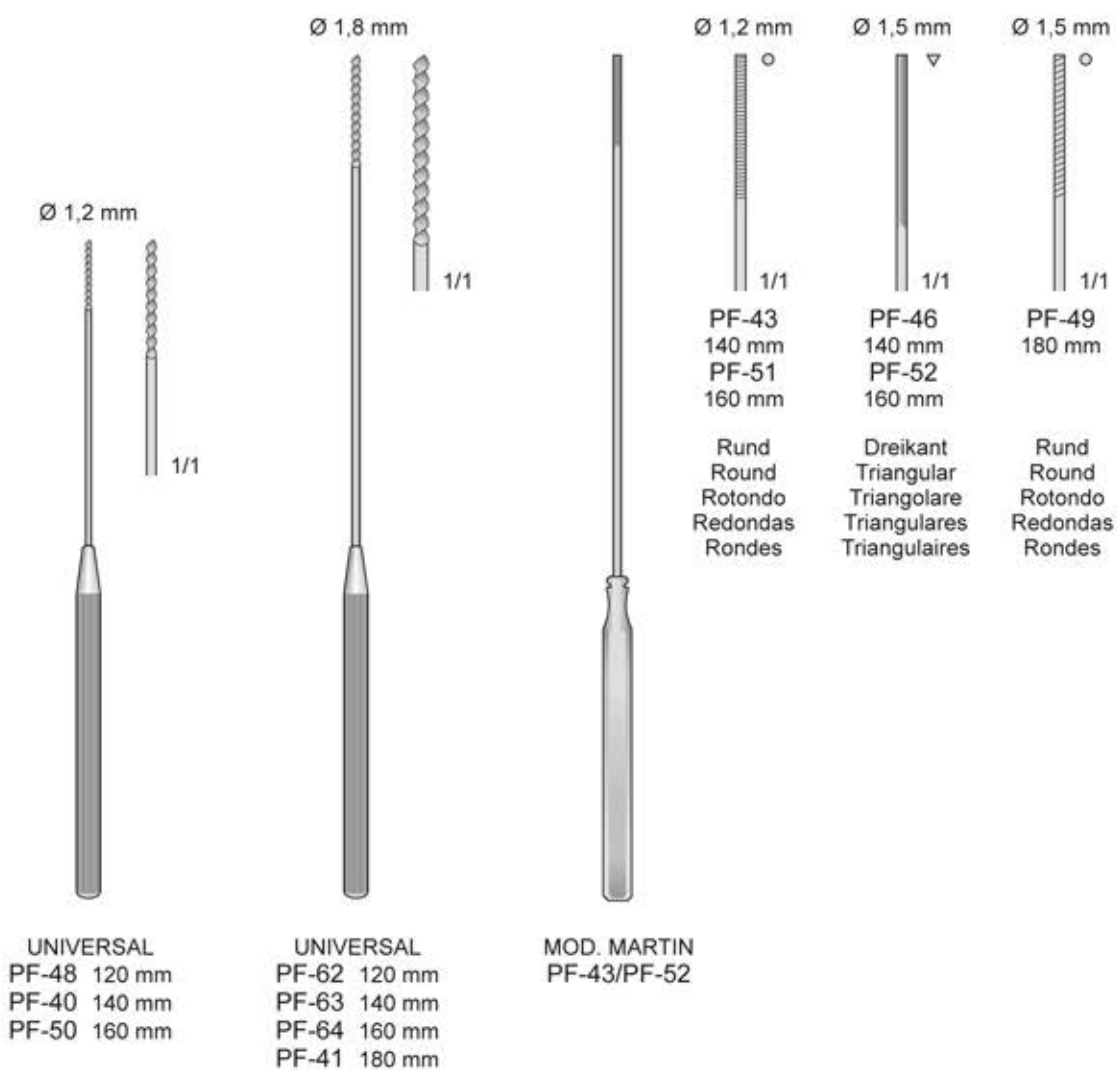

6

Mundsperrer, Wundhaken, Nasen Spekula
Mouth gags, Retractors, Nasal Specula
Apribocca, Divaricatori, Speculum nasali
Aprebocas, Separadores, Espéculos nasales
Ecarteur buccal, Ecarteurs, Spéculum nasaux

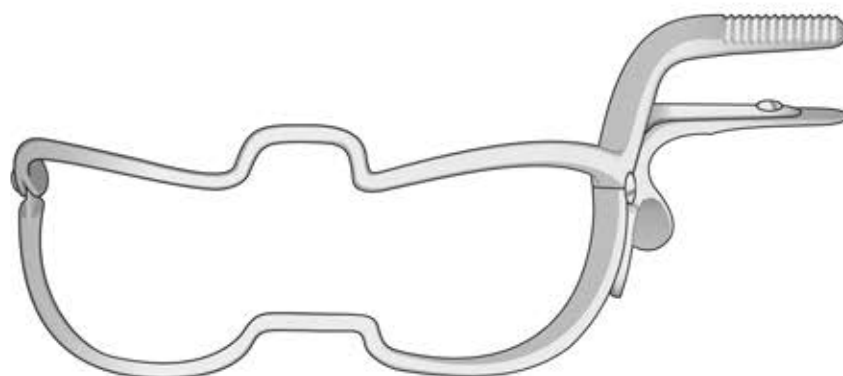

WHITEHEAD-JENNINGS

- OM-136 90 mm
- OM-137 110 mm
- OM-138 130 mm
- OM-139 150 mm

**KILNER-DOUGHTY
OM-160**
Komplett mit 3 Zungenspatel
Complete with 3 tongue depressors
Completo con 3 abbassalingua
Completo con 3 abaja lengua
Complet avec 3 abaisse-langues

Sperrer allein
Gag only
Apribocca solo
Apres-boca suelto
Manche et cadre seuls

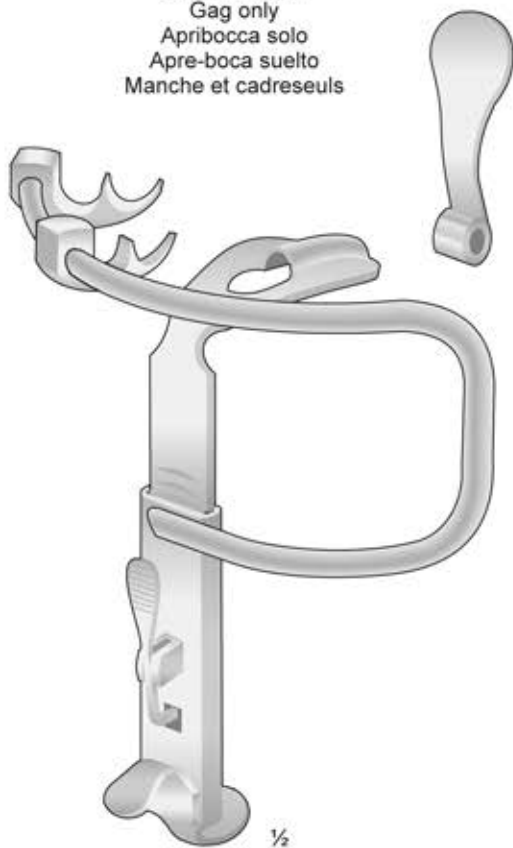

Fig. 1



OM-162
28 x 65 mm

Fig. 2



OM-163
32 x 75 mm

Fig. 3



OM-164
37 x 80 mm

**KILNER-DOUGHTY
OM-161**

Mundsperrer

Mouth gags

Apribocca

Abrebocas

Ecarteur buccal

Sperrer allein
Gag only
Apribocca solo
Apre-boca suelto
Manche et cadreseuls



DAVIS-BOYLE
OM-141

DAVIS-BOYLE
OM-140
Komplett mit 5 Zungenspatel
Complete with 5 tongue depressors
Completo con 5 abbassalingua
Completo con 5 abaja lengua
Complet avec 5 abaisse-langues

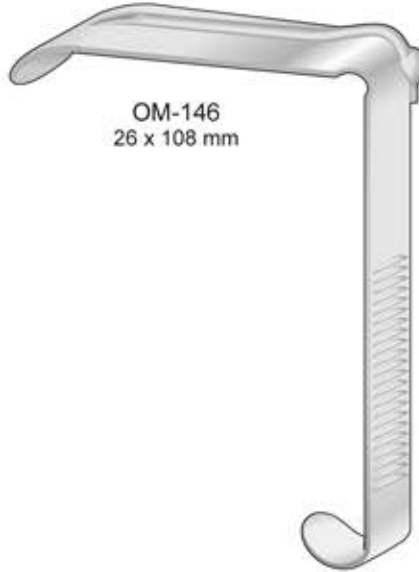

OM-146
26 x 108 mm



OM-145
25 x 93 mm



OM-144
24 x 80 mm

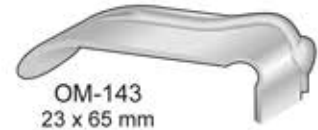

OM-143
23 x 65 mm



OM-142
21 x 30 mm

Mc-IVOR
OM-170
Komplett mit 3 Zungenspatel
Complete with 3 tongue depressors
Completo di 3 abbassalingua
Completo con 3 abaja lengua
Complet avec 3 abaisse-langues



Mc-IVOR
OM-171



OM-174
26 x 100 mm

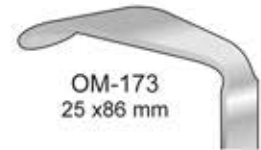

OM-173
25 x 86 mm



OM-172
23 x 70 mm

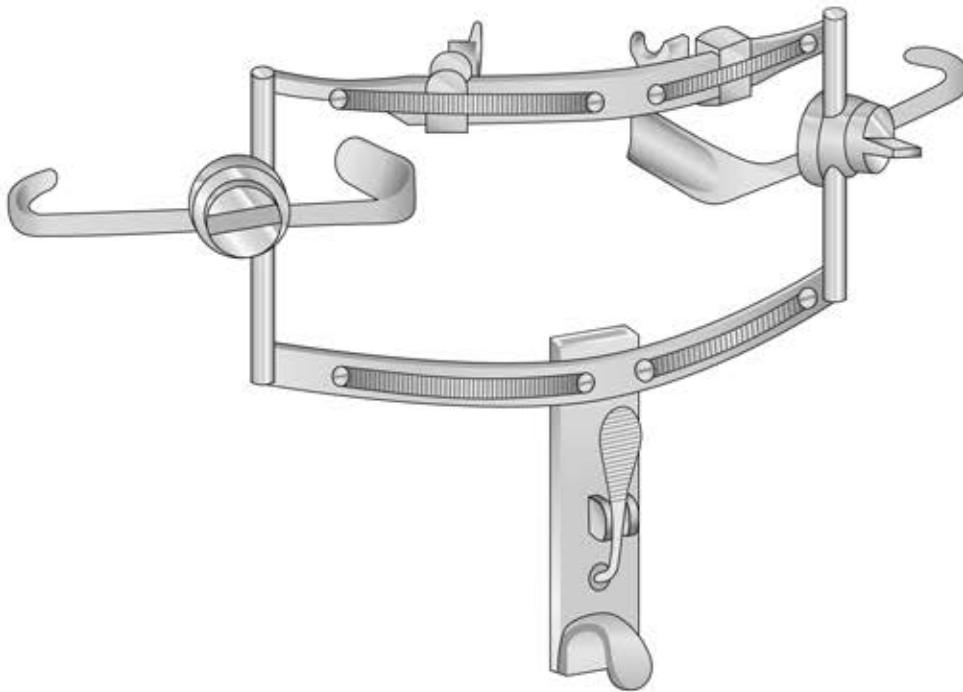

DINGMANN
OM-111

Zungenspatel
Tongue depressor
Abbassalingua
Bajalengua
Abaisse langue

Fig. 1

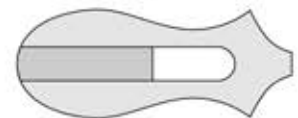

OM-112
65 x 25 mm

Fig. 2

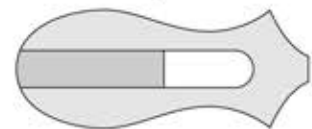

OM-113
70 x 29 mm

Fig. 3

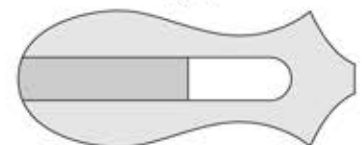

OM-114
80 x 32 mm

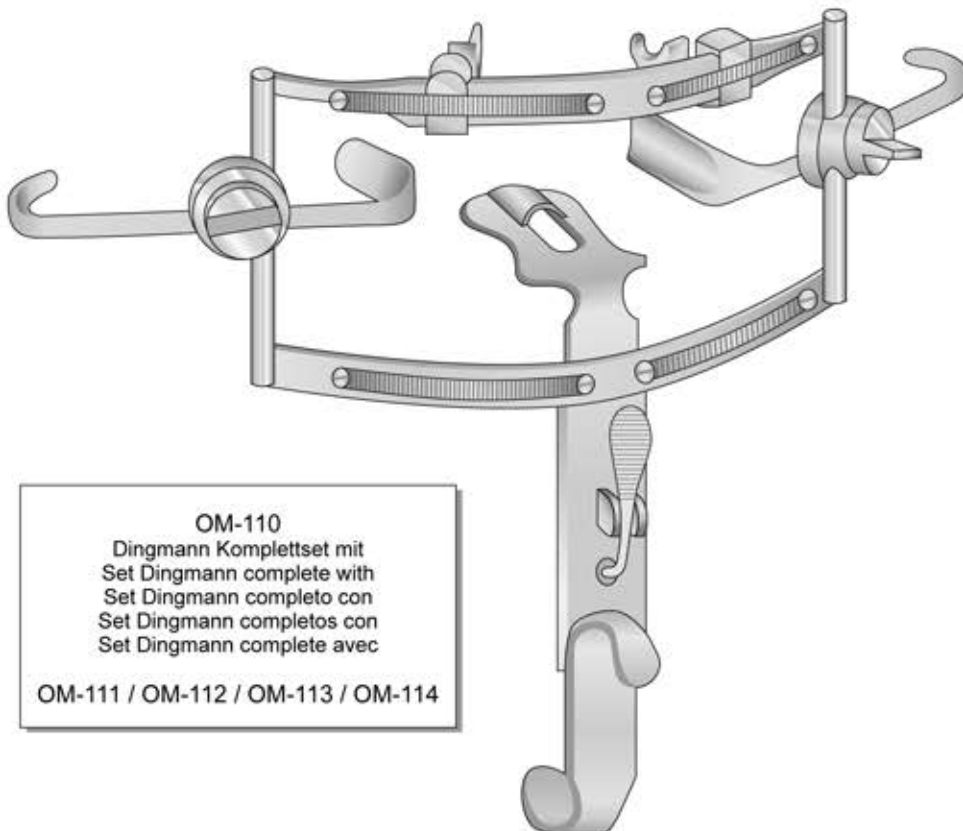

DINGMANN
OM-110
Set completo

OM-110
Dingmann Komplettsset mit
Set Dingmann complete with
Set Dingmann completo con
Set Dingmann completos con
Set Dingmann complete avec
OM-111 / OM-112 / OM-113 / OM-114

OM-85
Komplettset mit 3 Spatel
Set complete with 3 spatulas
Set completo con 3 spatole
Set completos con 3 espátulas
Set complete avec 3 spatules

OM-80 + OM-81 + OM-82

Biegsam - Malleable
Malleabile - Maleabile - Souple



OM-101 30 mm
OM-102 40 mm
OM-103 50 mm
330 mm

Biegsam - Malleable
Malleabile - Maleabile - Souple

40 mm



50 mm

HABERER
OM-104
300 mm

Biegsam - Malleable
Malleabile - Maleabile - Souple

17 mm

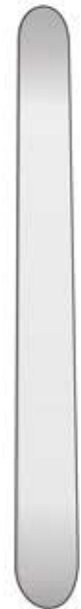

25 mm

TUFFIER
OM-99
200 mm

Rostfrei - Stainless Steel - Acciaio - Acero - Acer
Biegsam - Malleable - Malleabili - Maleables - Souples

18 mm



22 mm

OM-80
200 mm

14 mm



16 mm

OM-81
200 mm

5 mm

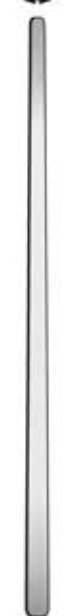

8 mm

OM-82
240 mm

18 mm



22 mm

OM-87
200 mm

14 mm

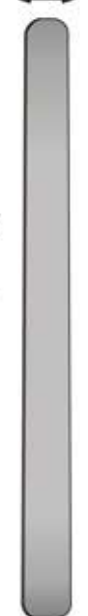

16 mm

OM-88
200 mm

Schwarz Verchromt
Black anodized
Cromato nero
Cromado en negro
Chromé noir

Zungendrucker

Tongue depressor

Abbassalingua

Bejalenguas

Abaisse-langues

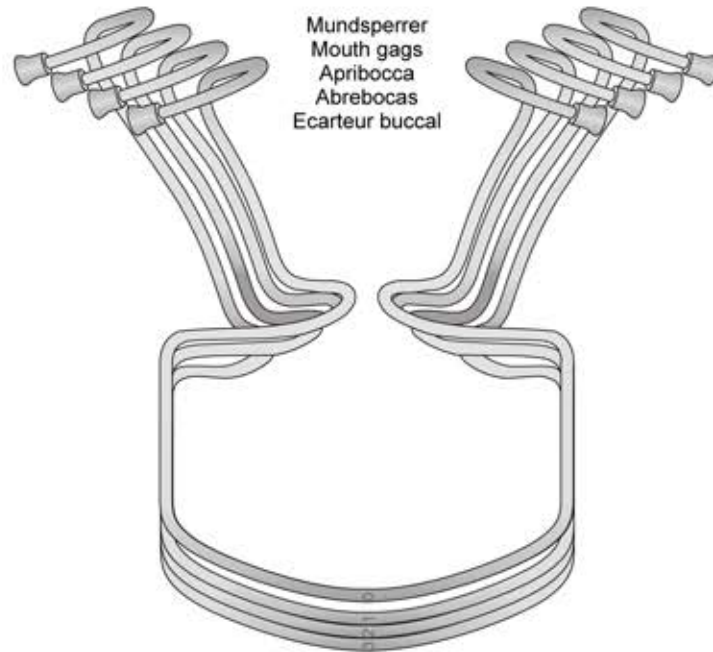

Mundsperrer
 Mouth gags
 Apribocca
 Abreboocas
 Ecarteur buccal

ORINGER

OM-74	Fig. 0	100 x 95 mm	Per bambini
OM-75	Fig. 1	115 x 105 mm	Per adulti
OM-76	Fig. 2	115 x 110 mm	Per adulti
OM-77	Fig. 3	125 x 115 mm	Per adulti

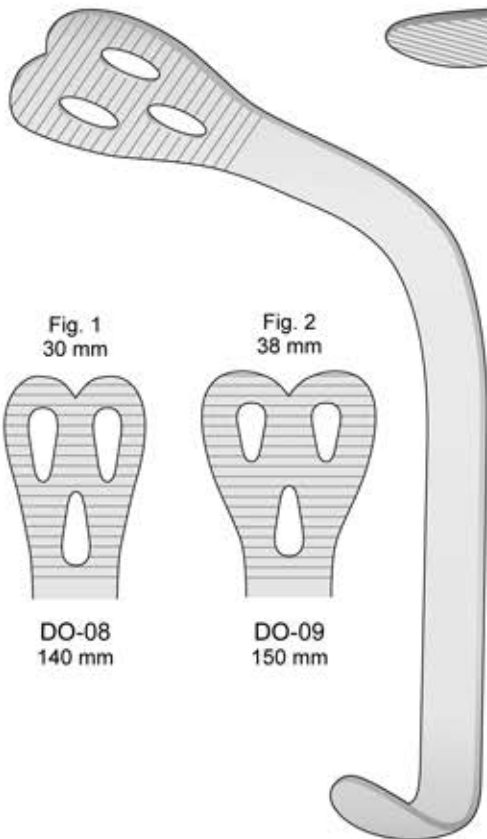

Fig. 1
30 mm

Fig. 2
38 mm

DO-08
140 mm

DO-09
150 mm

WIEDER
DO-08/DO-09

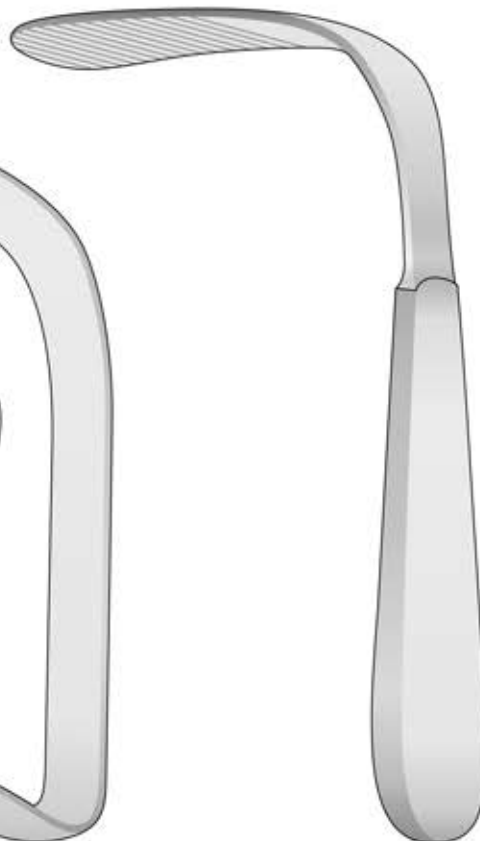

TOBOLD
OM-08
145 mm

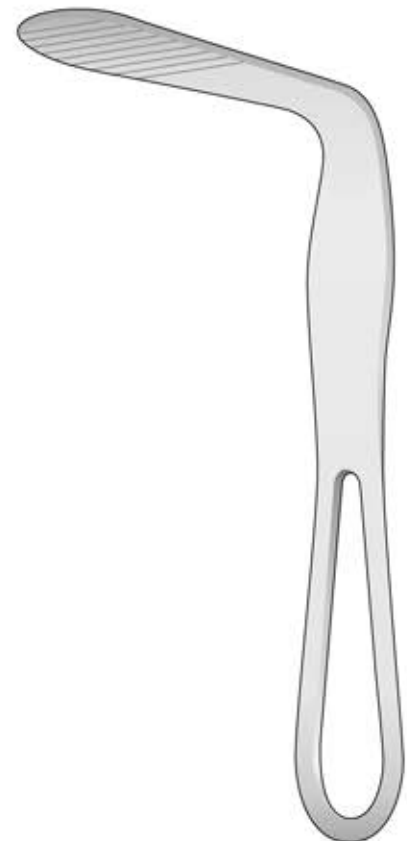

HARTMANN
OM-06
150 mm

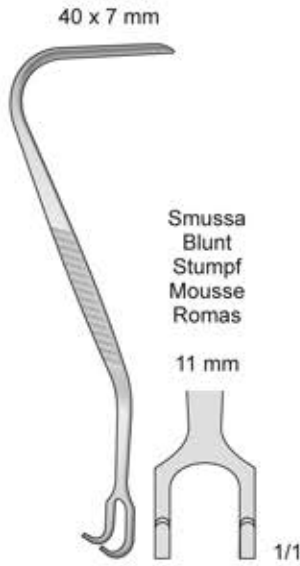

**AUFRICHT
BT-381
135 mm**

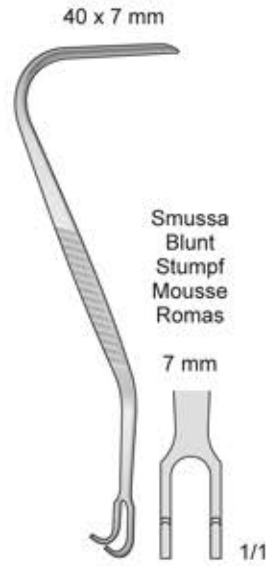

**AUFRICHT-WALTER
BT-387
135 mm**

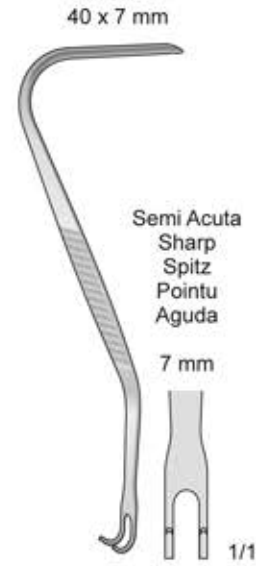

**AUFRICHT-WALTER
BT-388
135 mm**

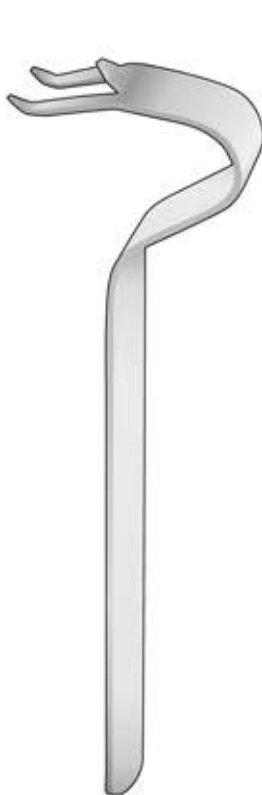

**OBWEGESER
DO-40
155 mm**

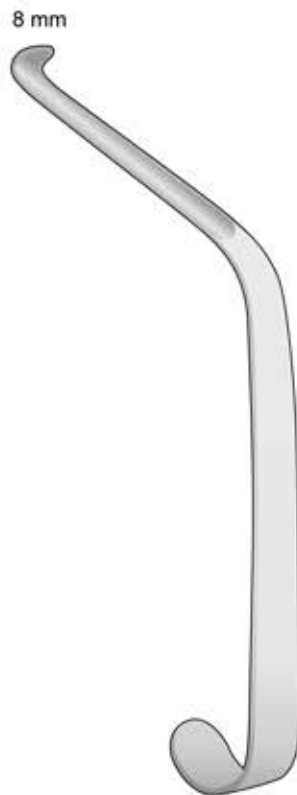

**OBWEGESER
DO-41
165 mm**



**OBWEGESER
DO-142
165 mm**

Wundhaken

Retractors

Divaricatori

Separadores

Ecarteurs

Posteriore
Posterior



DUNN-DAUTREY
DO-94 6,5 x 50 mm
140 mm

Anterior
Anteriore



DUNN-DAUTREY
DO-95 6,5 x 60 mm
140 mm

Superior
Superiore



DUNN-DAUTREY
DO-96 8 x 50 mm
140 mm

Superior
Superiore

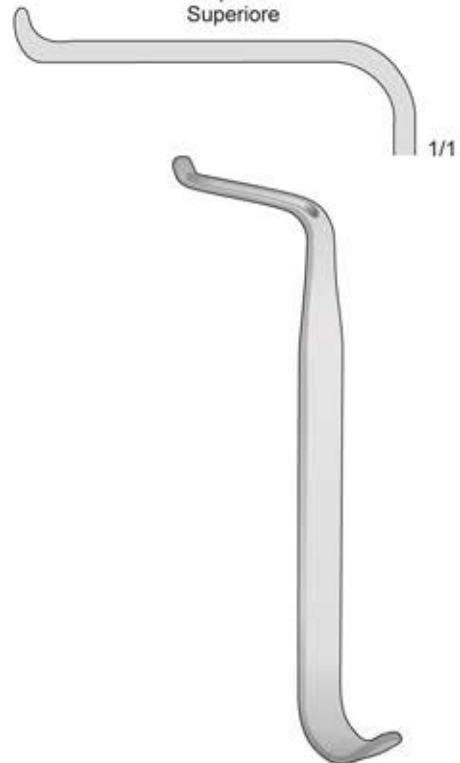

DUNN-DAUTREY
DO-97 6,5 x 50 mm
140 mm



MILLARD
BD-342/BD-343
150 mm

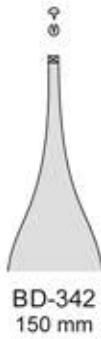

BD-342
150 mm

1/1



BD-343
150 mm

1/1

6x6 Zähne
6x6 Teeth
6x6 Denti
6x6 Dientes
6x6 Dents

Fingerring Häkchen
Finger ring Retractor
Uncino nasale a forma di anello
Ganchito en forma de anillo
Crochet nasal en forme de bague



COTTLE
DO-259

Knorpelquetsche
Cartilage crusher
Strumento per cartilagine
Machacadora
Pincas-Gouge à cartilage



COTTLE
DO-264



Nasenflügelhäkchen
Alar Retractor
Uncino per alette nasali
Ganchos para las alas de la nariz
Crochet pour les ailes du nez

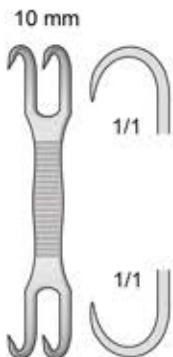

BT-226
63 mm



KILNER
BT-273
80 mm

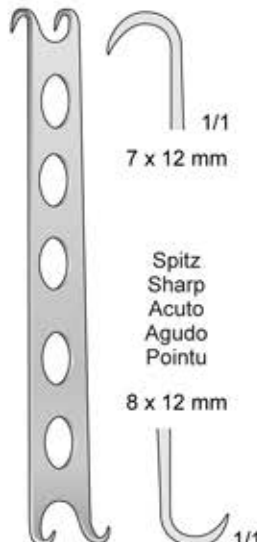

CONVERSE
BT-22
120 mm

Spitz
Sharp
Acuto
Agudo
Pointu

1/1

7 x 12 mm

Spitz
Sharp
Acuto
Agudo
Pointu

8 x 12 mm

1/1



COTTLE
BT-196
160 mm



COTTLE
BT-197/BT-199
150 mm

Fig. 1

1/1

BT-197

Fig. 2

1/1

BT-198

Fig. 3

1/1

BT-199

Mikro Wundhaken

Micro Retractors

Micro divaricatori

Micro Separadores

Micro Ecarteurs

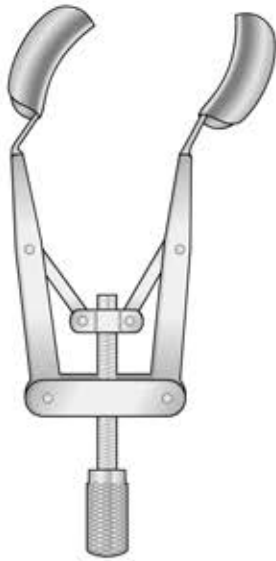

KERSHNER
NK-420

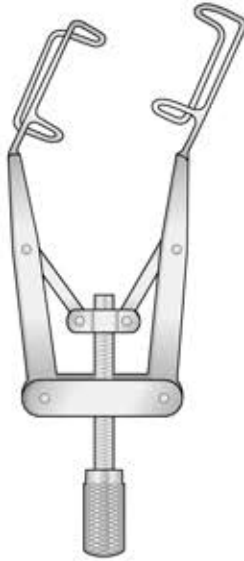

KERSHNER
NK-421

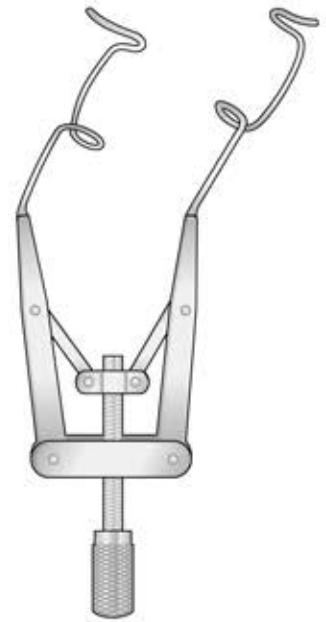

LIEBERMANN-TENNANT
NK-422

Hauthäkchen - Cutaneous hook - Uncini cutanei - Ganchos cutáneos - Erignes cutanées



GILLIES
BT-15
180 mm



GILLIES
BT-16
180 mm



BT-207
160 mm



BT-208
160 mm



GUTHRIE
BT-203
160 mm



GUTHRIE
BT-204
160 mm

Sperrelevatoren - Eye specula - Blefarostati
Blefarostatos - Blèpharostats

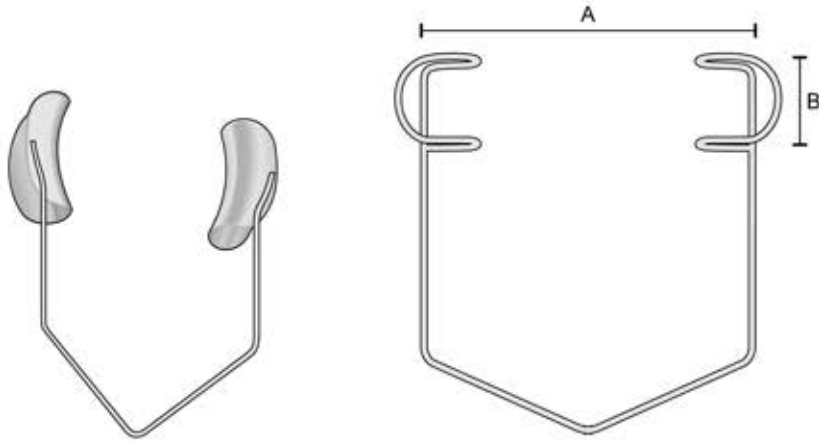

BARRAQUER
NK-83

	A	B
NK-80	27 mm	5 mm
NK-82	34 mm	9 mm
NK-84	42 mm	12 mm
NK-86	42 mm	14 mm

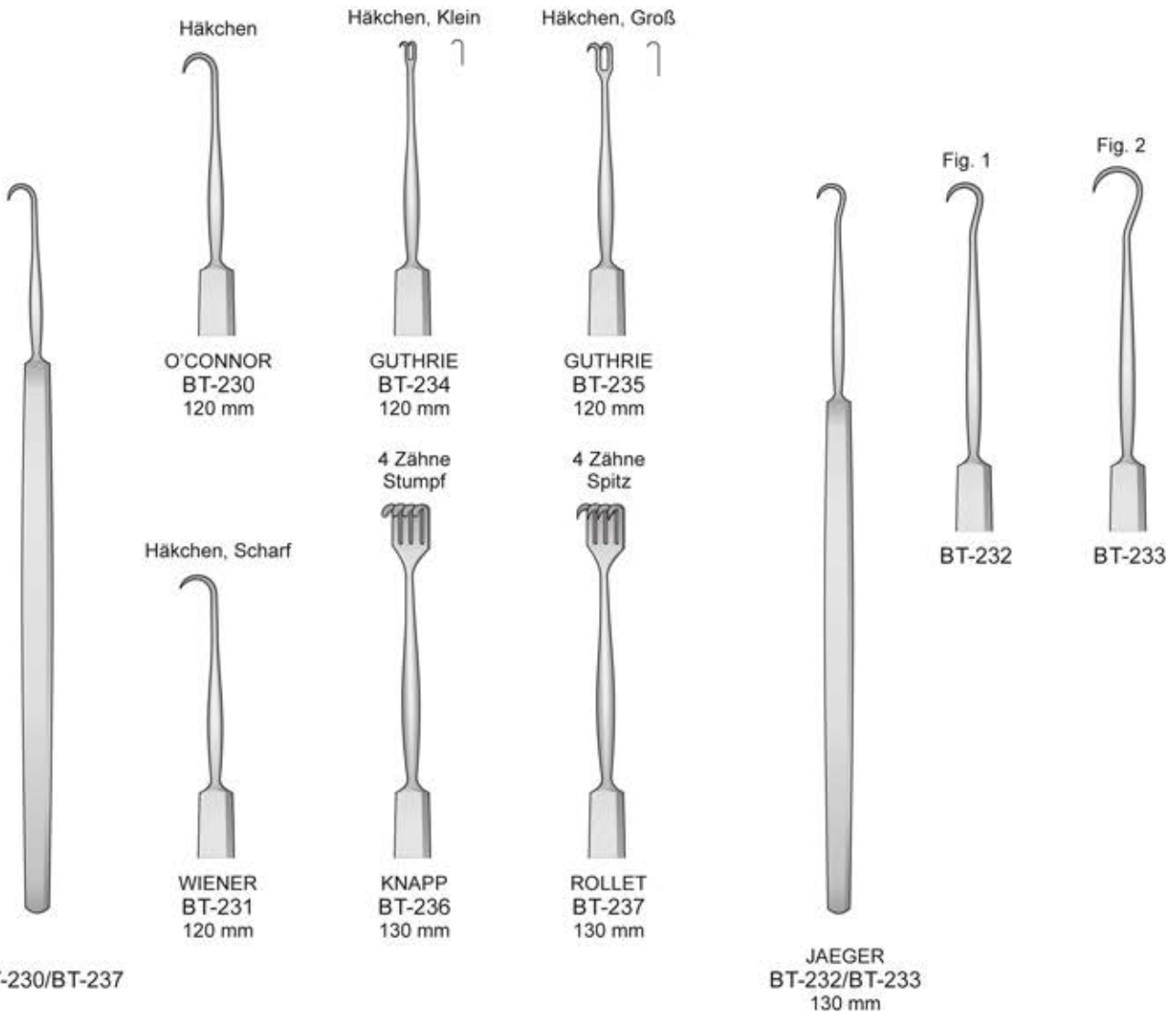

BT-230/BT-237

JAEGER
BT-232/BT-233
130 mm

Wundhaken

Retractors

Divaricatori

Separadores

Ecarteurs



KIRBY
BT-243
130 mm



FREER
BT-200
150 mm



JOSEPH
BT-210/BT-214
160 mm

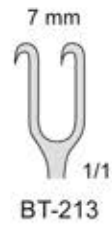

COTTLE
BT-215/BT-217
150 mm



FOMON
BT-218
160 mm

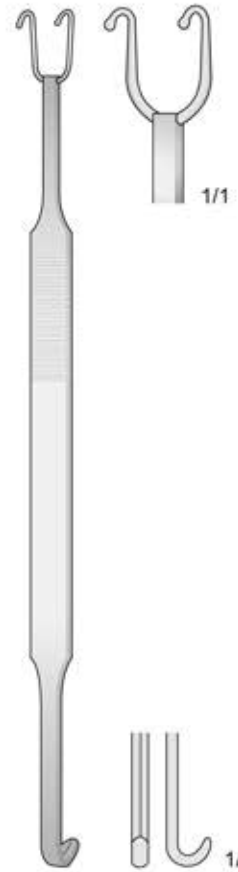

COTTLE-NEIVERT
BT-57
200 mm



Wundhaken

Retractors

Divaricatori

Separadores

Ecarteurs

2 Zähne



AXENFELD
BT-238 Scharf
BT-239 Stumpf

3 Zähne



AXENFELD
BT-240 Scharf
BT-241 Stumpf

Häkchen



PAUL
BT-242

Feine Wundhaken flexibel-spitz - Delicate retractors flexible-sharp
Divaricatori delicati flessibili-acuti - Separadores finos flexibles-agudas

Feine Wundhaken flexibel-stumpf - Delicate retractors flexible-blunt
Divaricatori delicati flessibili-smussi - Separadores finos flexibles-romas

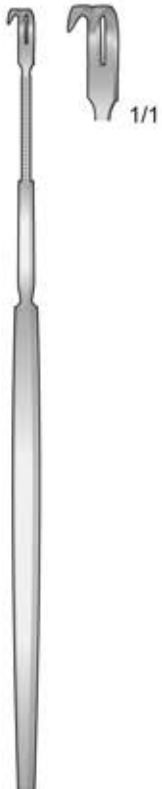

BT-50
150 mm



BT-51
150 mm

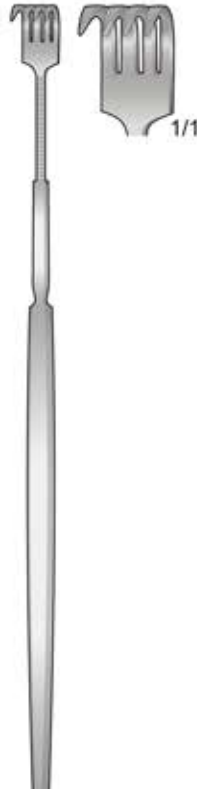

BT-52
150 mm



BT-54
150 mm

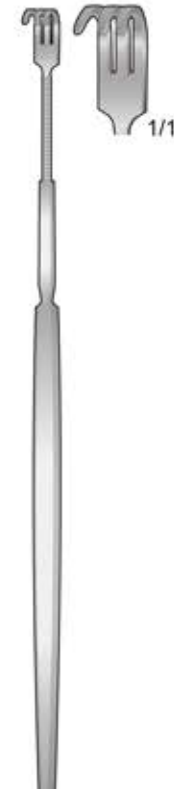

BT-55
150 mm

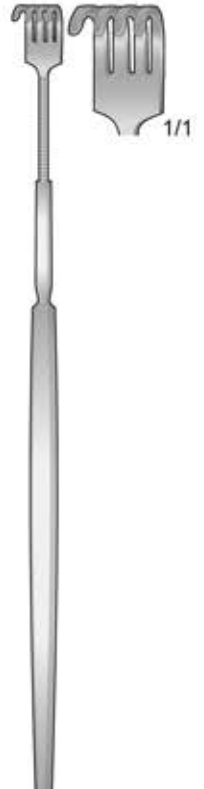

BT-56
150 mm

Wundhaken

Retractors

Divaricatori

Separadores

Ecarteurs



Instrumente zur Nasenplastik
Instrument for Rhinoplastic



COTTLE
BT-382
150 mm



NEIVERT
BT-383
160 mm

BT-40/BT-46
160 mm

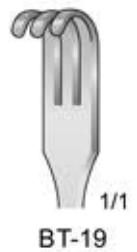
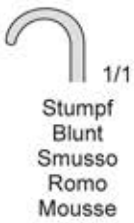
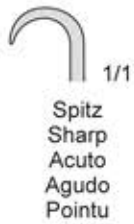

BT-38/BT-195
160 mm

SENN-MILLER
BT-18/BT-19
160 mm

1/1

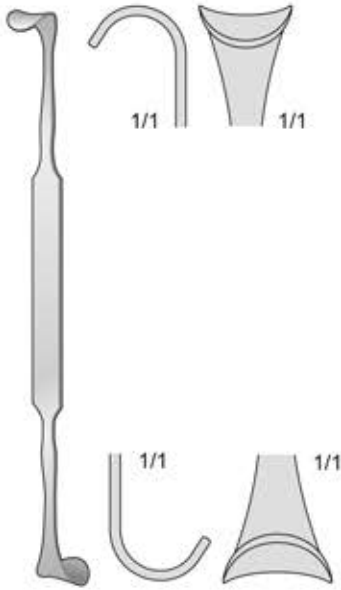

ROSE
DS-15
130 mm

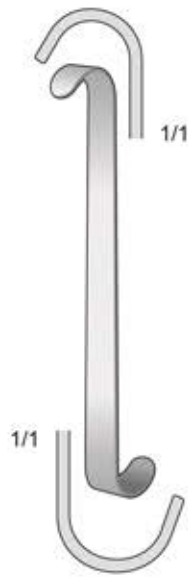

LUER
DS-16
110 mm



NEWS
DS-19
150 mm

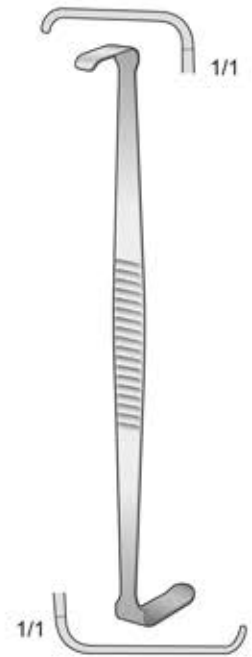

HOUSE
DS-20
150 mm



LOVE
DO-213/DO-215
150 mm

DO-213 - 18 mm
DO-214 - 20 mm
DO-215 - 22 mm



BT-296

1/1



BT-297

1/1



CUSHING
BT-298/BT-299
280 mm



BT-298

1/1



BT-299

1/1

Wundhaken

Retractors

Divaricatori

Separadores

Ecarteurs



DESMARRES
BT-70/BT-79
140 mm



ROSTKOWSKI
BT-76
135 mm

Lidhalter Gr. 2

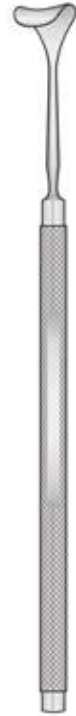

KIRBY
BT-244
140 mm



CONWAY
NK-144
140 mm



DESMARRES
NK-145
140 mm



COTTLE
BT-245
150 mm

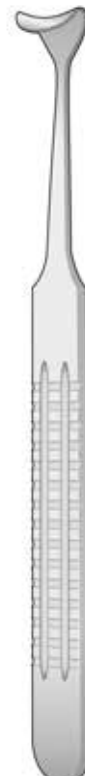

DESMARRES
BT-28
160 mm



KLAR EVATEUR
BT-09
160 mm

Wundhaken

Retractors

Divaricatori

Separadores

Ecarteurs



GIESSEN
NK-251

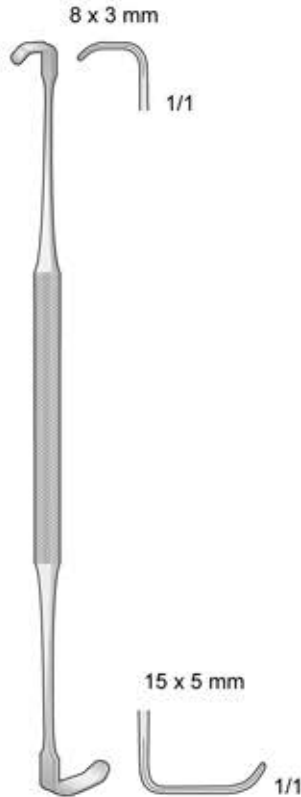

RAGNELL
BT-27
140 mm

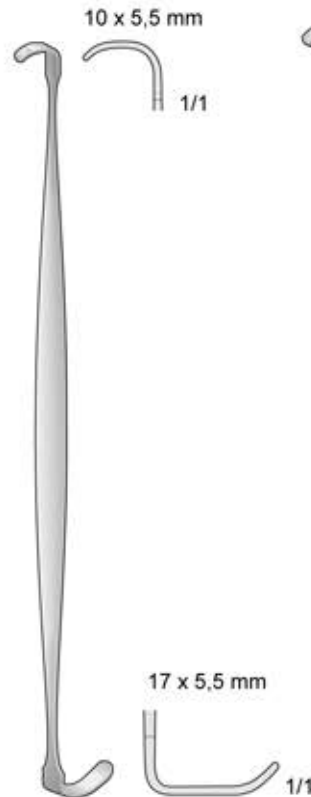

RAGNELL-DAVIS
BT-26
140 mm

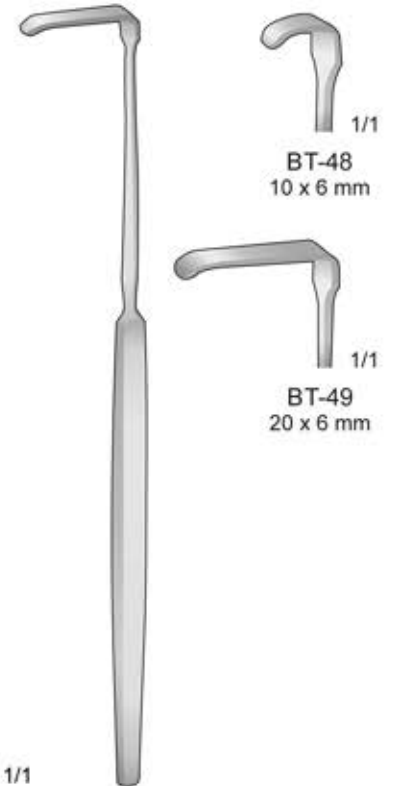

SENN-GREEN
BT-48/BT-49
160 mm

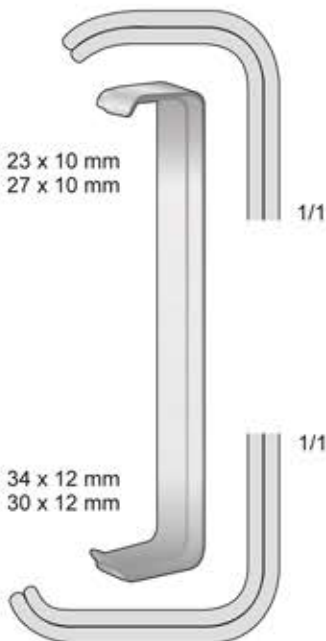

FARABEU
BT-20
120 mm

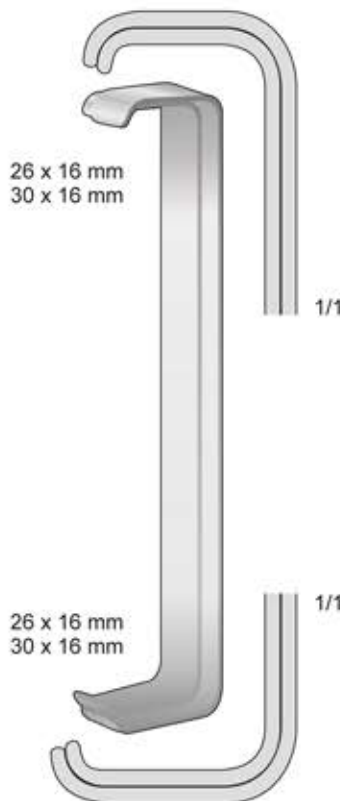

FARABEU
BT-25
150 mm

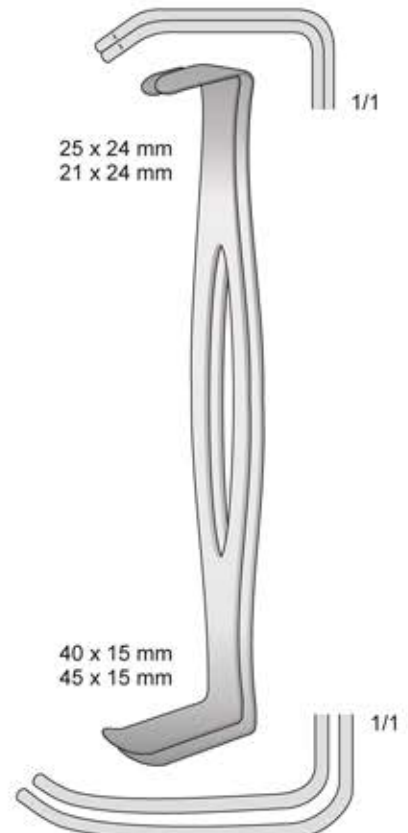

PARKER-LANGENBECK
BT-291
210 mm

Wundhaken

Retractors

Divaricatori

Separadores

Ecarteurs

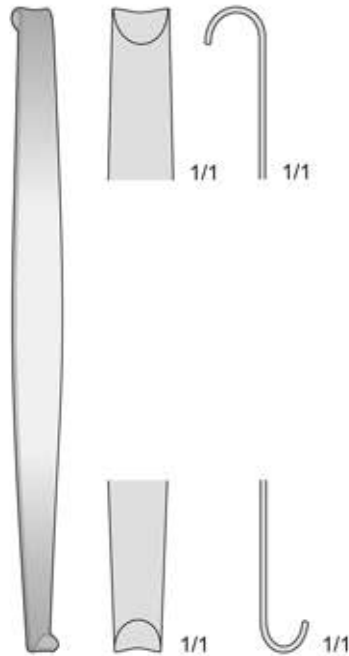

MINI-ROUX
BT-282
150 mm



CUSHING
BT-401/BT-406
200 mm



8 mm
BT-401



10 mm
BT-402



12 mm
BT-403



14 mm
BT-404



16 mm
BT-405



18 mm
BT-406

BT-283
Komplettset
Set complete
Set completo
Set completo
Set complet

29 mm
26 mm
22 mm

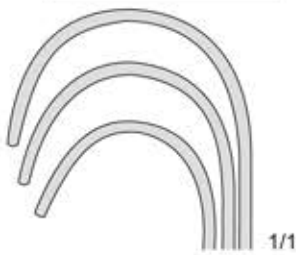

BT-284 - 20x22 mm
25x28 mm
BT-285 - 23x26 mm
29x38 mm
BT-286 - 29x29 mm
34x44 mm

28 mm
38 mm
44 mm



ROUX
BT-284/BT-286
165 mm

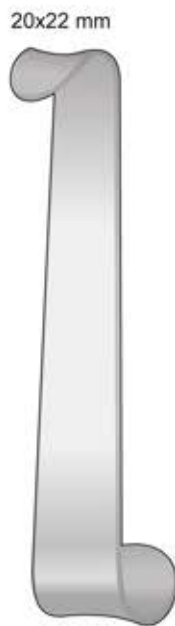

20x22 mm
25x28 mm
ROUX-MAGNUS
BT-287
150 mm



23x26 mm
29x38 mm
ROUX-MAGNUS
BT-288
160 mm

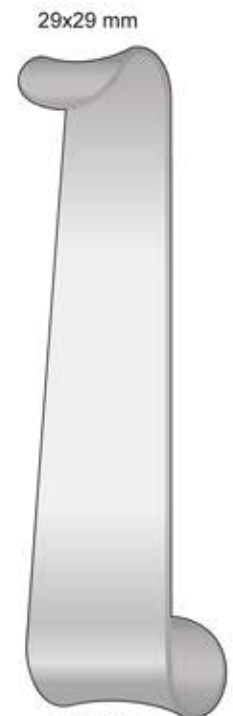

29x29 mm
34x44 mm
ROUX-MAGNUS
BT-289
170 mm

Wundhaken

Retractors

Divaricatori

Separadores

Ecarteurs

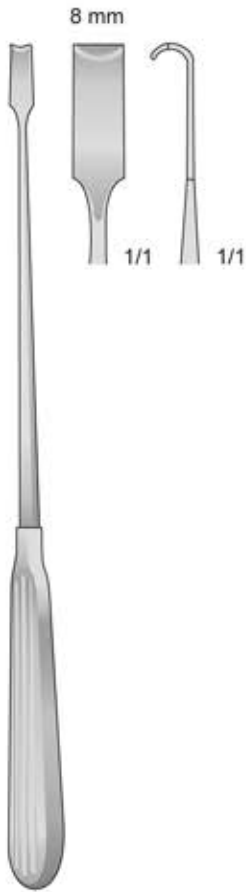

SCOVILLE
BT-312
230 mm



CUSHING
BT-114/BT-116
250 mm

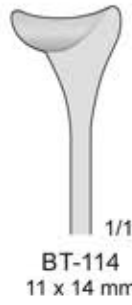

BT-114
11 x 14 mm

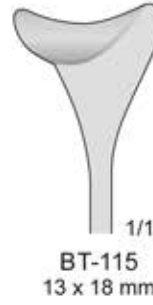

BT-115
13 x 18 mm

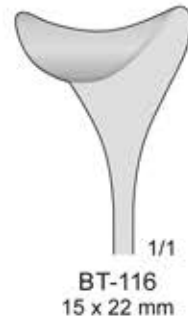

BT-116
15 x 22 mm

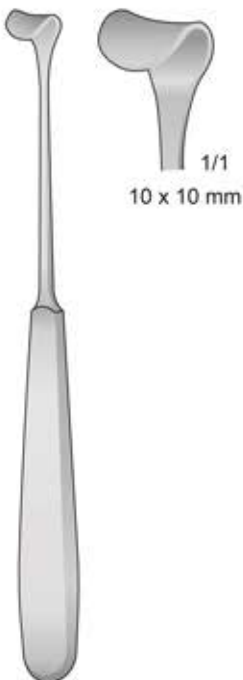

CUSHING-KOCHER
BT-113
180 mm



KOCHER
BT-117/BT-118
205 mm

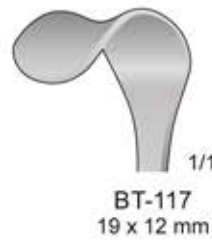

BT-117
19 x 12 mm

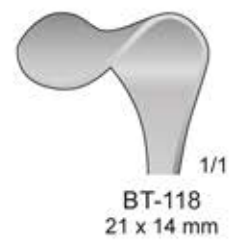

BT-118
21 x 14 mm

Wundhaken

Retractors

Divaricatori

Separadores

Ecarteurs



OBWEGESER
BT-152/BT-157
220 mm



OBWEGESER
BT-92/BT-100
220 mm

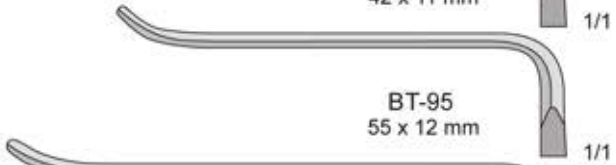
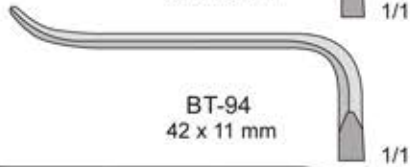
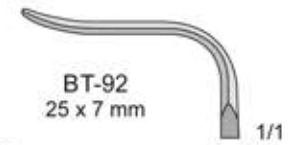
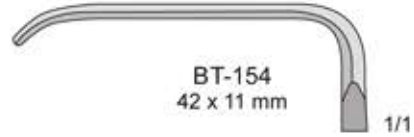

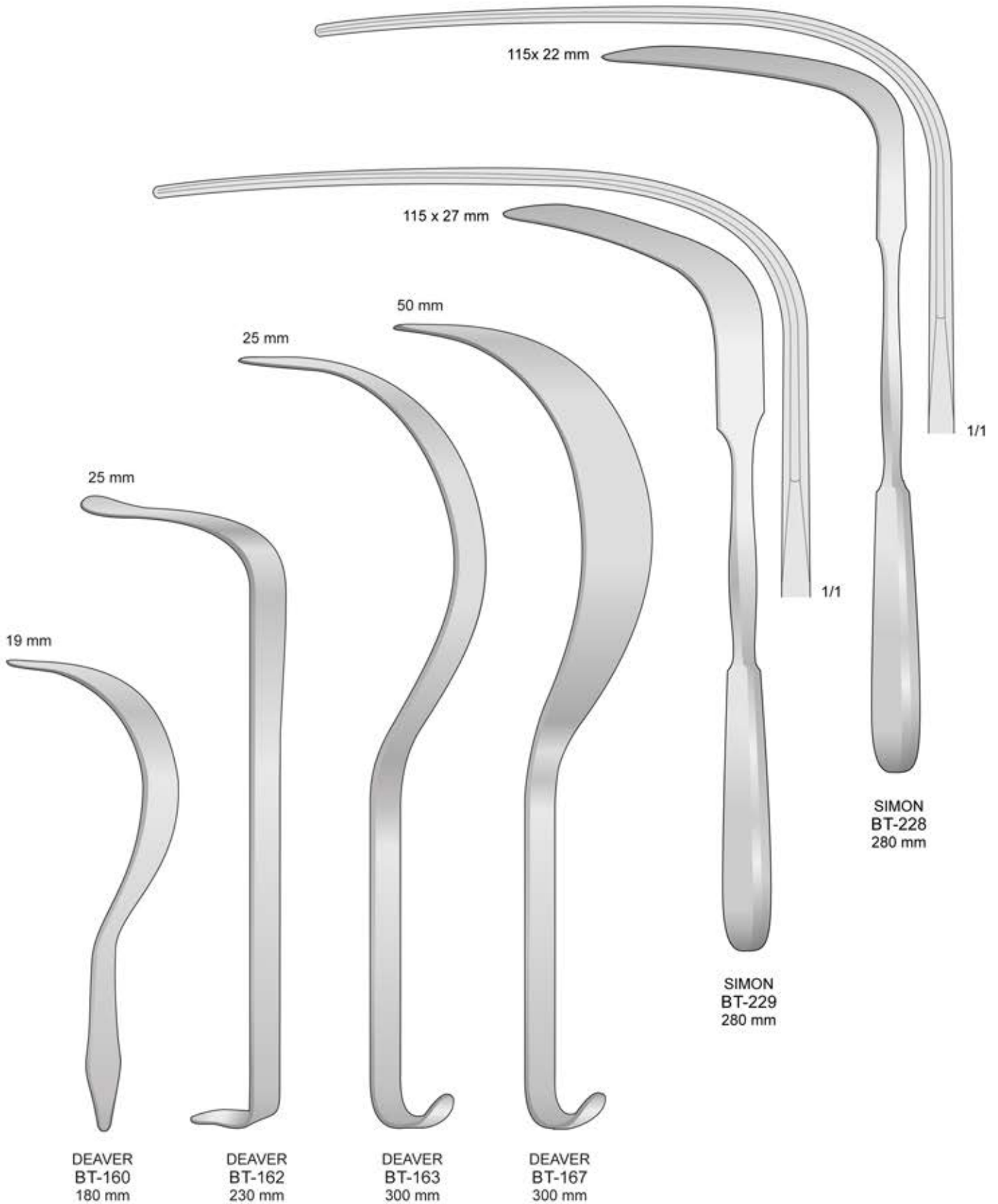

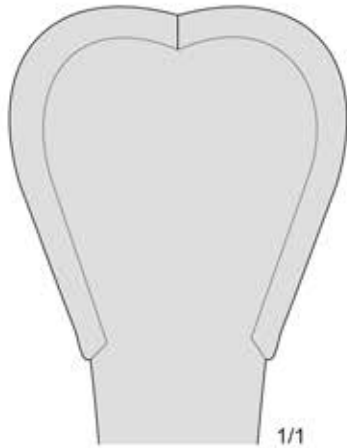

BT-341 - 127 x 40 mm



BT-342 - 127 x 62 mm

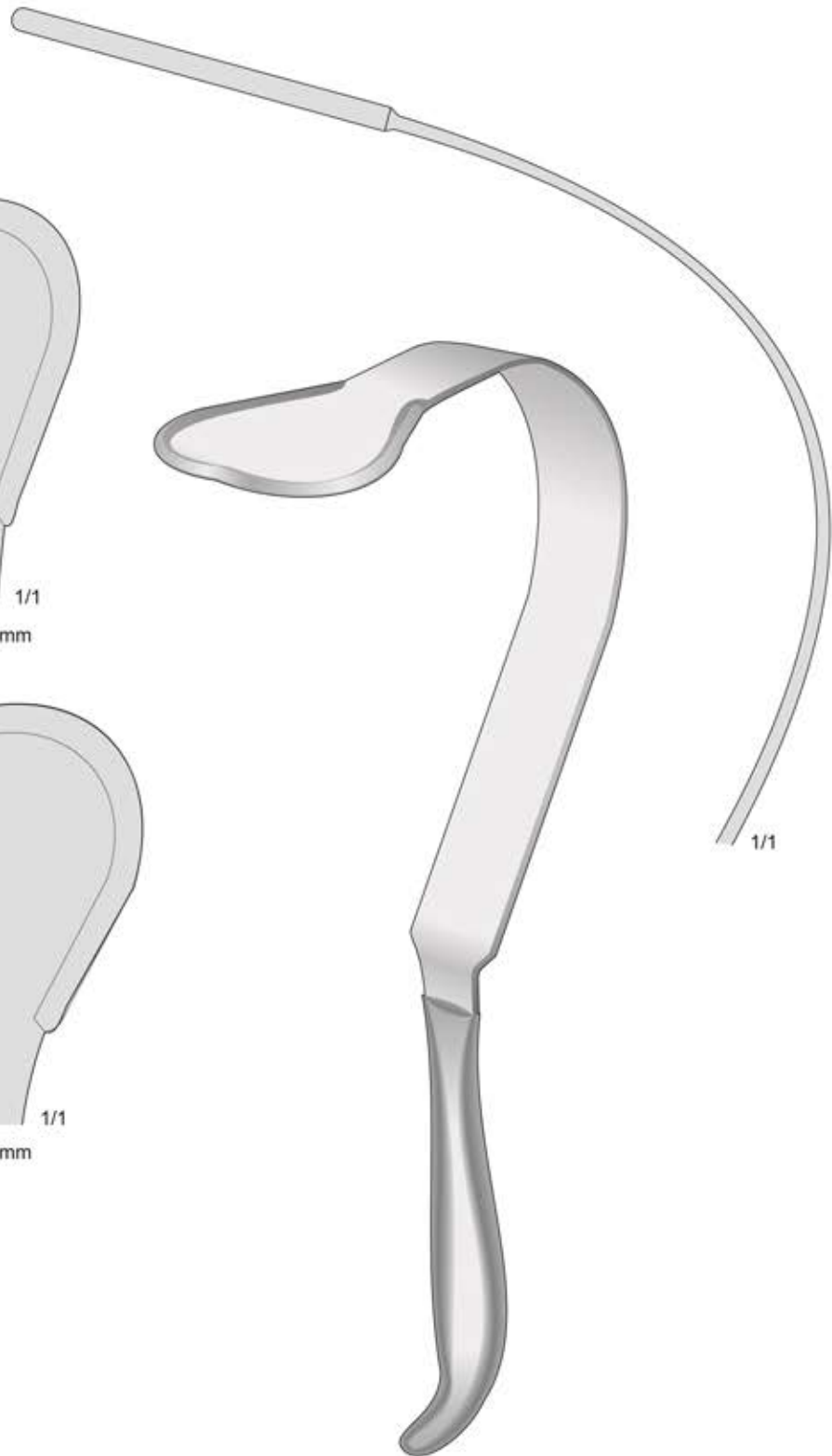

HARRINGTON
BT-341/BT-342
320 mm

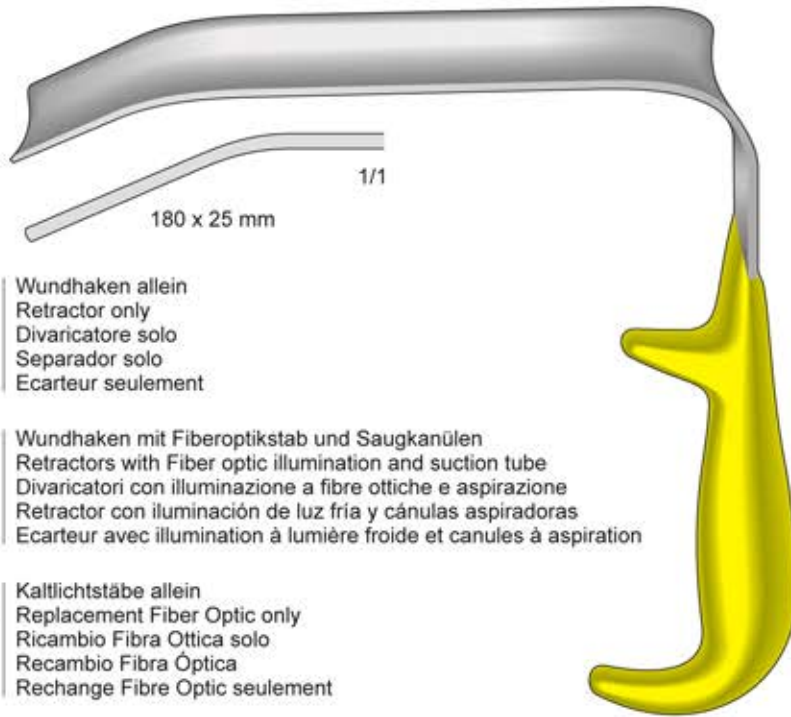

- BT-500 | Wundhaken allein
Retractor only
Divaricatore solo
Separador solo
Ecarteur seulement

- BT-501 | Wundhaken mit Fiberoptikstab und Saugkanülen
BT-502 | Retractors with Fiber optic illumination and suction tube
Divaricatori con illuminazione a fibre ottiche e aspirazione
Retractor con iluminación de luz fría y cánulas aspiradoras
Ecarteur avec illumination à lumière froide et canules à aspiration

- BT-501R | Kaltlichtstäbe allein
BT-502R | Replacement Fiber Optic only
Ricambio Fibra Ottica solo
Recambio Fibra Óptica
Rechange Fibre Optic seulement

BT-500

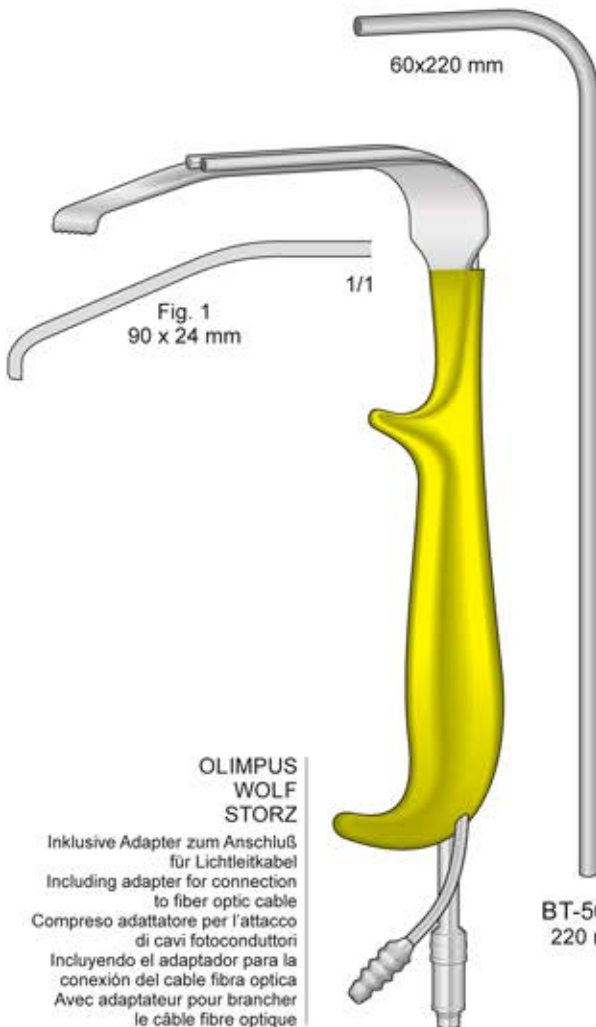

**OLIMPUS
WOLF
STORZ**
Inklusive Adapter zum Anschluss
für Lichtleitkabel
Including adapter for connection
to fiber optic cable
Compreso adattatore per l'attacco
di cavi fotoconduttori
Incluyendo el adaptador para la
conexión del cable fibra optica
Avec adaptateur pour brancher
le câble fibre optique

BT-501R
220 mm

BT-501

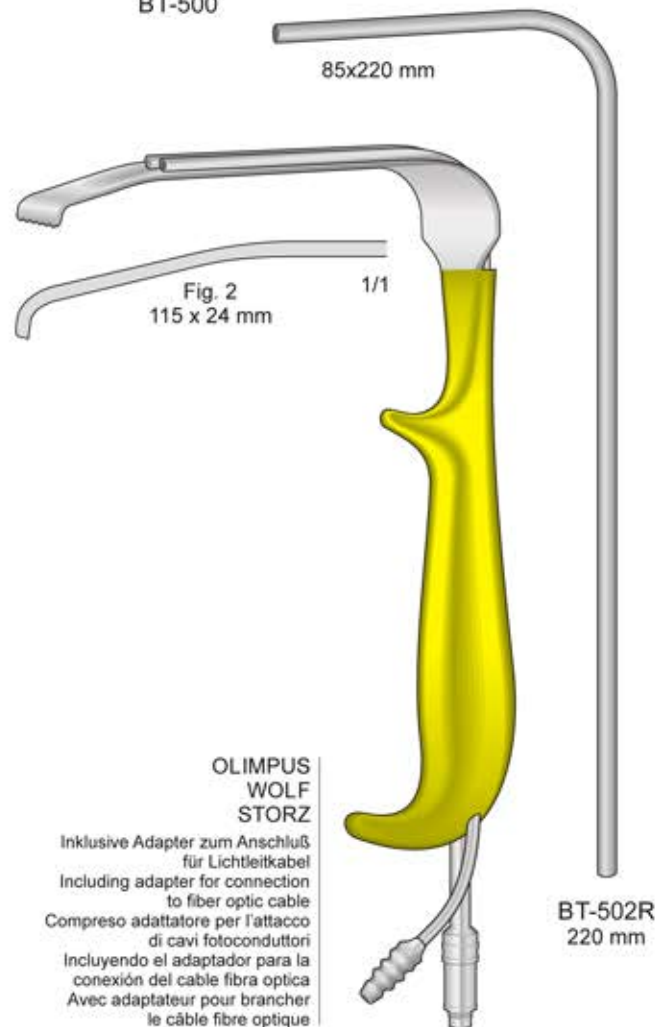

**OLIMPUS
WOLF
STORZ**
Inklusive Adapter zum Anschluss
für Lichtleitkabel
Including adapter for connection
to fiber optic cable
Compreso adattatore per l'attacco
di cavi fotoconduttori
Incluyendo el adaptador para la
conexión del cable fibra optica
Avec adaptateur pour brancher
le câble fibre optique

BT-502R
220 mm

BT-502

Wundhaken

Retractors

Divaricatori

Separadores

Ecarteurs

BT-503 | Wundhaken mit Fiberoptikstab und Saugkanülen
 BT-504 | Retractors with Fiber optic illumination and suction tube
 Divaricatori con illuminazione a fibre ottiche e aspirazione
 Retractor con iluminación de luz fría y cánulas aspiradoras
 Ecarteur avec illumination à lumière froide et canules à aspiration

BT-503R | Kaltlichtstäbe allein
 BT-504R | Replacement Fiber Optic only
 Ricambio Fibra Ottica solo
 Recambio Fibra Óptica
 Rechange Fibre Optic seulement

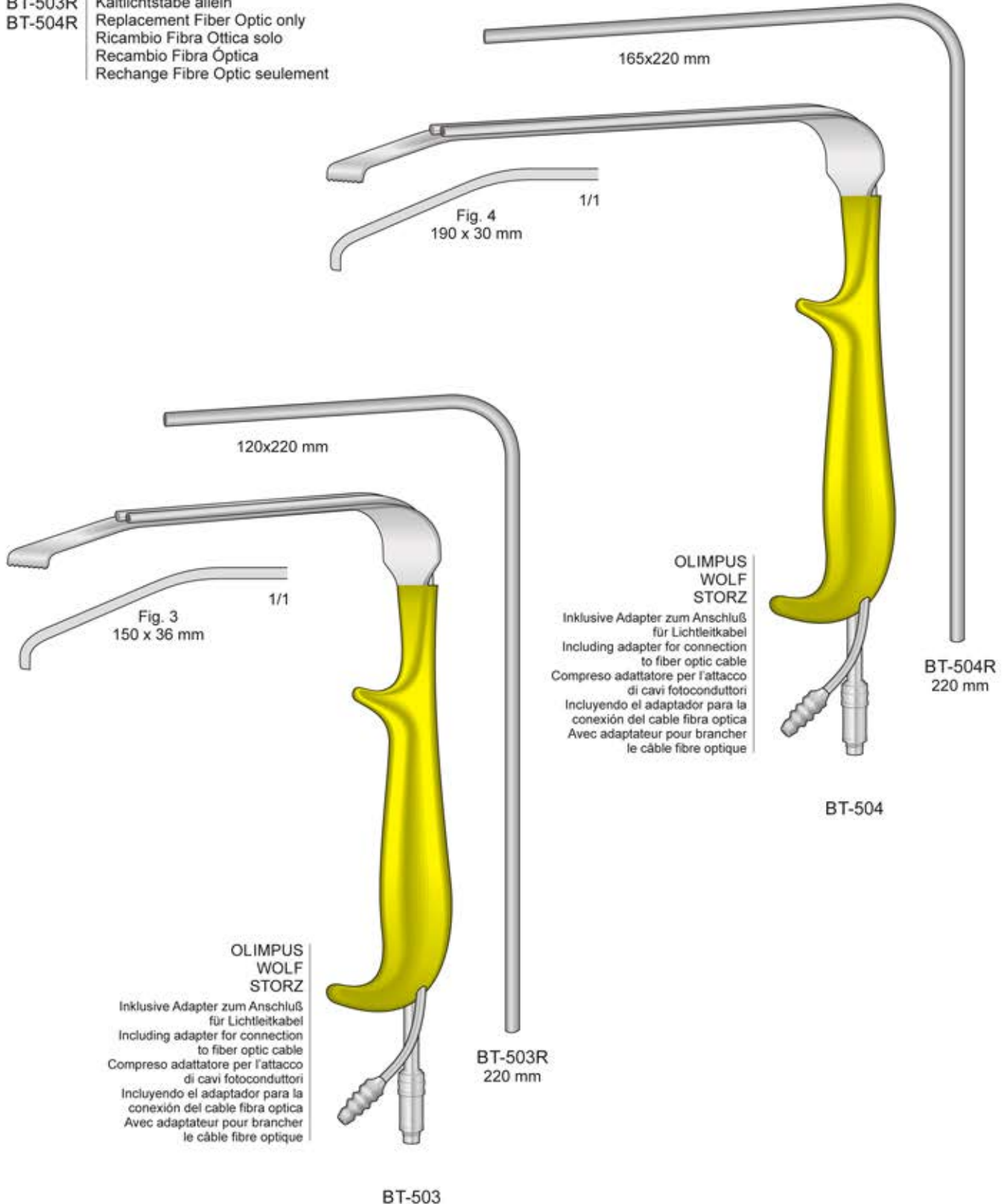

Wundhaken
Dissektoren

Retractors
Dissectors

Divaricatori
Dissettori

Separadores
Disecadores

Ecarteurs
Dissecteurs

Brust Spatel, halb-biegsam
150 mm Langes Blatt
25 mm breit
Breast Spatula, semi-malleable
150 mm blade



ES-143
315 mm

Doppelendiger
Brustretractor
Double ended
Breast Retractor



ES-145
310 mm



Fig. 1
Leicht gebogen
Slight curved
Curva leggera

ES-131
240 mm



Fig. 2
Medium gebogen
Half curved
Curva media

ES-132
240 mm



Fig. 3
Gebogen
Curved
Curvo

ES-133
265 mm



Fig. 4
Gerade
Straight
Dritto

ES-134
250 mm



Fig. 5
S-Form
S-shaped
Forma a S

ES-135
280 mm

Breast



MacCOLLUM-DINGMAN
ES-140
410 mm

Spatulated Ovale
Breast



ES-141
330 mm

Angulated
Breast



ES-142
330 mm

12 mm



FREEMAN
ES-160
205 mm

8 mm



SHEEN
ES-162
150 mm

Wundhaken

Retractors

Divaricatori

Separadores

Ecarteurs



MILLARD
ES-120



FREEMAN
ES-121
50 mm

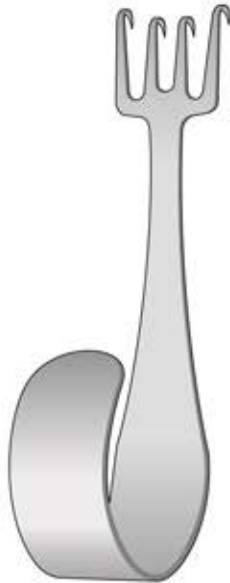

FREEMAN
ES-122
100 mm



GORNEY
ES-123
75 mm

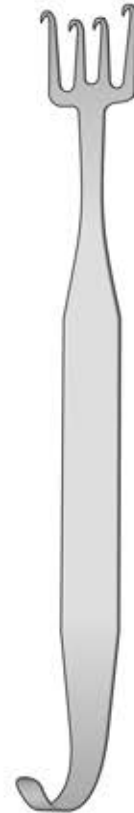

FREEMAN
ES-124
180 mm

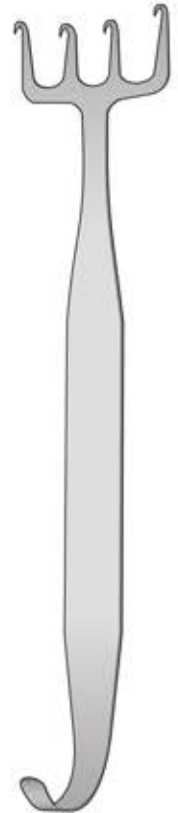

FREEMAN
ES-125
180 mm

Coronal Left Wundhaken
Coronal Lift Retractor
Divaricatore coronale

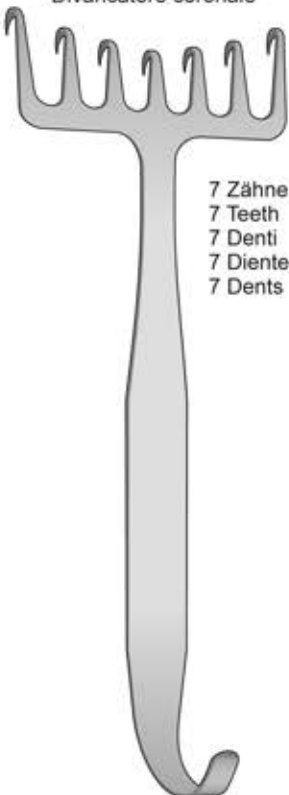

7 Zähne
7 Teeth
7 Denti
7 Dientes
7 Dents

CORONAL
ES-126
180 mm

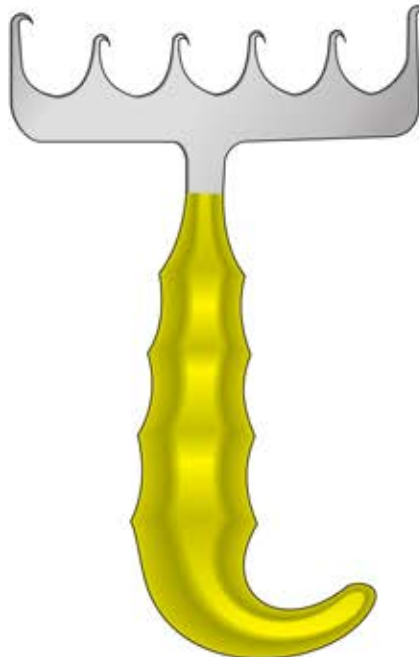

YANCOSKIE
ES-127
150 mm



FREEMAN
ES-128
180 mm

Wundhaken

Retractors

Divaricatori

Separadores

Ecarteurs



FINSEN
BV-36/BV-39
50 mm

Spitz 3x2 Zähne
Sharp 3x2 Teeth
Acuto 3x2 Denti
Agudas 3x2 Dientes
Pointü 3x2 Griffes



BV-36

Stumpf 3x2 Zähne
Blunt 3x2 Teeth
Smusso 3x2 Denti
Romas 3x2 Dientes
Mousse 3x2 Griffes



BV-37

Spitz 3x4 Zähne
Sharp 3x4 Teeth
Acuto 3x4 Denti
Agudas 3x4 Dientes
Pointü 3x4 Griffes

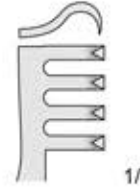

BV-38

Stumpf 3x4 Zähne
Blunt 3x4 Teeth
Smusso 3x4 Denti
Romas 3x4 Dientes
Mousse 3x4 Griffes



BV-39

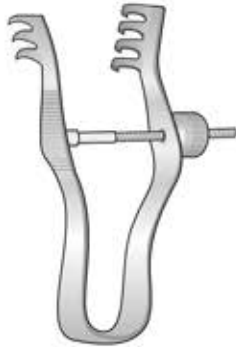

FINSEN
BV-47/BV-48
70 mm

Spitz 3x4 Zähne
Sharp 3x4 Teeth
Acuto 3x4 Denti
Agudas 3x4 Dientes
Pointü 3x4 Griffes

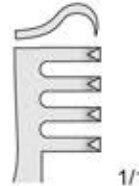

BV-47

Stumpf 3x4 Zähne
Blunt 3x4 Teeth
Smusso 3x4 Denti
Romas 3x4 Dientes
Mousse 3x4 Griffes



BV-48

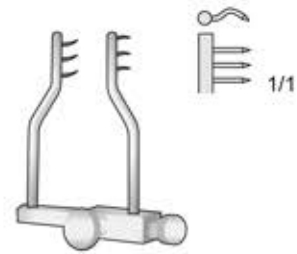

LOGAN
BV-45
40 mm

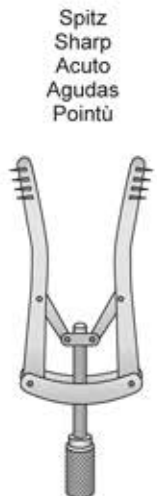

ALM
BV-12
70 mm

Spitz
Sharp
Acuto
Agudas
Pointü

Stumpf
Blunt
Smusso
Romas
Mousse



BV-49
70 mm

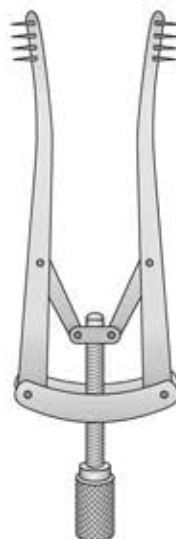

ALM
BV-10
100 mm

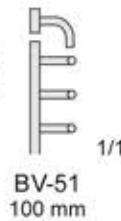

BV-51
100 mm

Spitz
Sharp
Acuto
Agudas
Pointü

Stumpf
Blunt
Smusso
Romas
Mousse



BV-08
100 mm

Wundhaken

Retractors

Divaricatori

Separadores

Ecarteurs

Spitz
Sharp
Acuto
Agudo
Pointu

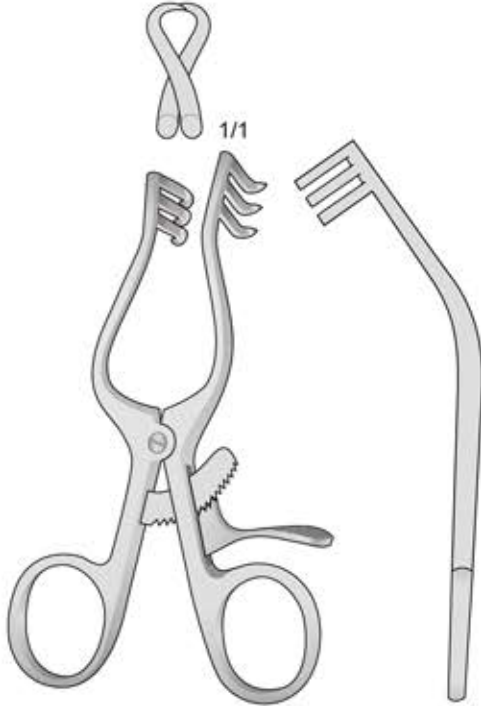

WULLSTEIN
BV-111
105 mm

Stumpf
Blunt
Smusso
Romo
Mousse

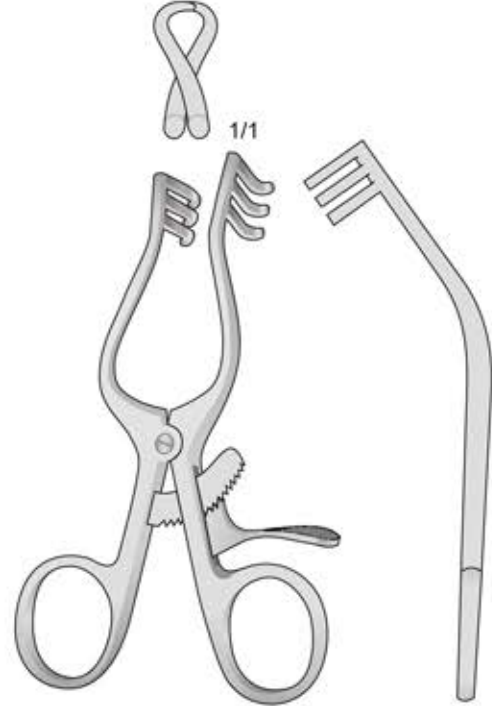

WULLSTEIN
BV-112
105 mm

Spitz
Sharp
Acuto
Agudo
Pointu

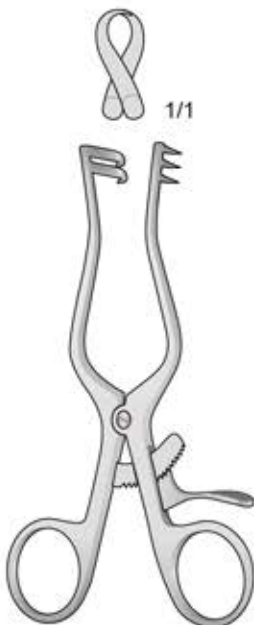

WEITLANER
BV-07
110 mm

Stumpf
Blunt
Smusso
Romo
Mousse

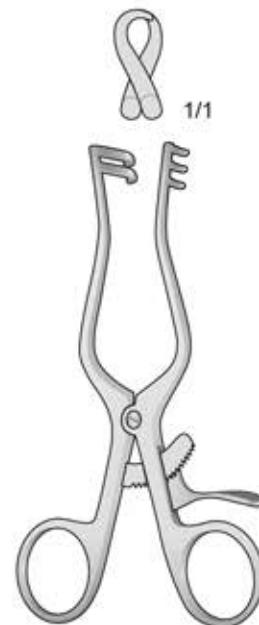

WEITLANER
BV-09
110 mm

Wundhaken

Retractors

Divaricatori

Separadores

Ecarteurs

Spitz
Sharp
Acuto
Agudo
Pointu

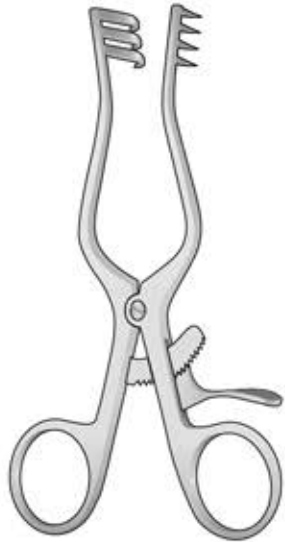

WEITLANER
BV-20
135 mm

Stumpf
Blunt
Smusso
Romo
Mousse



WEITLANER
BV-22
135 mm

Spitz - Sharp
Acuto - Agudo
Pointu

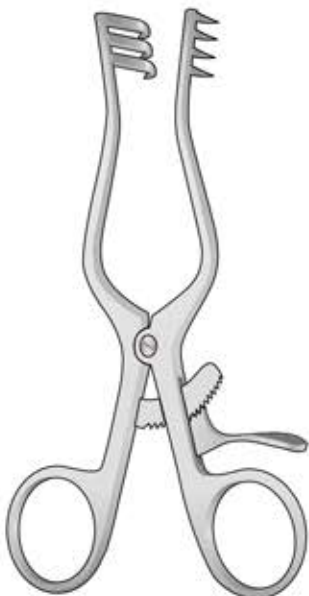

WEITLANER
BV-21
165 mm

Stumpf - Blunt
Smusso - Romo
Mousse



WEITLANER
BV-23
165 mm

Acuto
Scharp
Spitz
Pointu
Agudo



BV-68
140 mm

Smusso
Blunt
Stumpf
Mousse
Romas

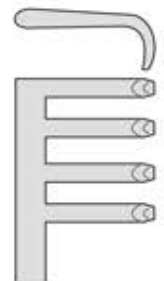

BV-70
140 mm

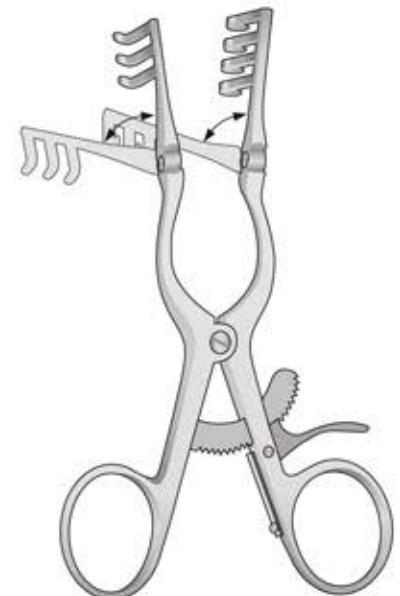

ADSON
BV-68/BV-70
140 mm

Spitz - Sharp - Acuto
Agudas - Pointu

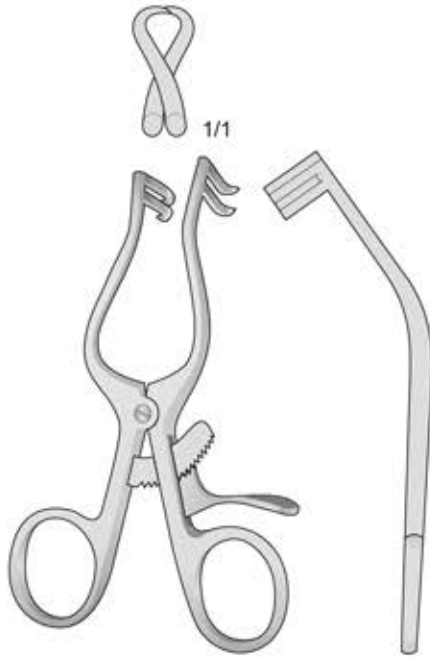

PLESTER
BV-90
110 mm

Stumpf - Blunt - Smusso
Romas - Mousse

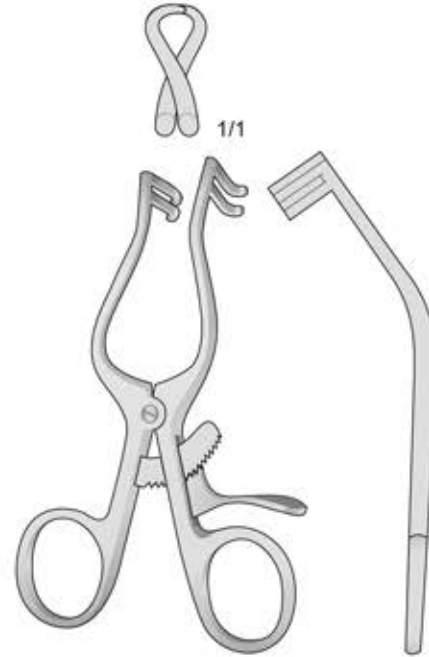

PLESTER
BV-91
110 mm

Spitz - Sharp - Acuto
Agudas - Pointu

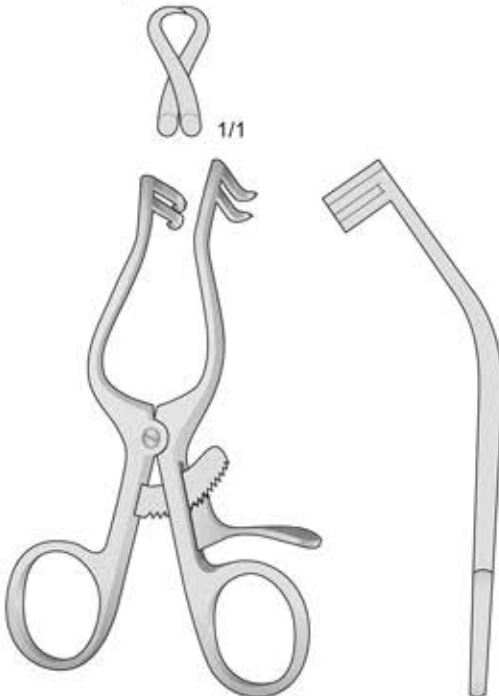

PLESTER
BV-92
135 mm

Stumpf - Blunt - Smusso
Romas - Mousse

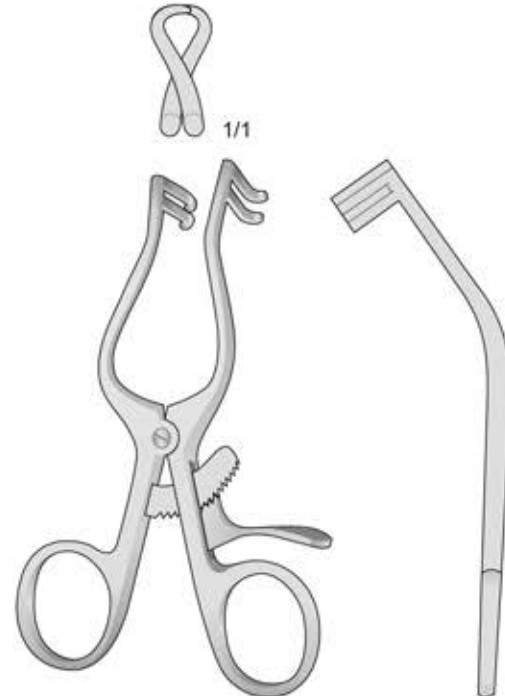

PLESTER
BV-93
135 mm

Haken Stripper

Vein Stripper

Uncini per vene

Sonda para varices

Stripper a anneau

Varizeninstrumente
 Varix Instruments
 Strumenti per varici
 Instrumentos para varices
 Instruments pour varices

Phlebodissektor - Phlebodissector
 Flebodissectore - Flebodisecador
 Dissecteur pour phlébite

ES-150
 Komplettsset mit
 Set complete with
 Set completo con
 Set completo con
 Set complete avec
 ES-151 + ES-152 + ES-153

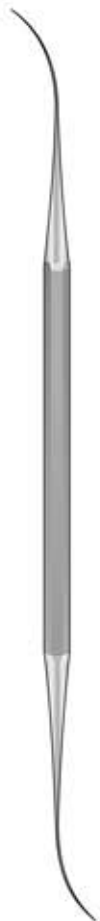

VARADY
 FB-107
 180 mm



VARADY
 FB-108
 180 mm



VARADY
 FB-109
 180 mm

Fig. 1

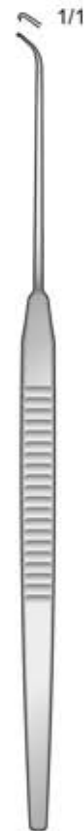

ES-151
 140 mm

Fig. 2



ES-152
 140 mm

Fig. 3



ES-153
 140 mm

FB-390
Krampfaderbesteck komplett
Varicose Vein Probe Set complete
Set completo sonda per varici
Juego para varices completo
Trousse à varices complète

Metall-Sondenspitzen
Probe tip, metal
Punta per sonda
in metallo
Punta metálica
Pointe en métal

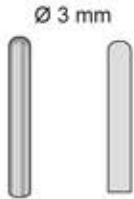

Ø 3 mm

FB-394



FB-395/FB-398

Oliven - Olives - Olive - Oliva - Olive



Ø 6 mm

FB-395



Ø 9 mm

FB-396



Ø 12 mm

FB-397



Ø 15 mm

FB-398

Griff Allein
Handle only
Manico solo
Mango solo
Manche seule



FB-400

Zugseil
Traction Cable
Cavo per trazione
Cable de tracción
Cable tracteur

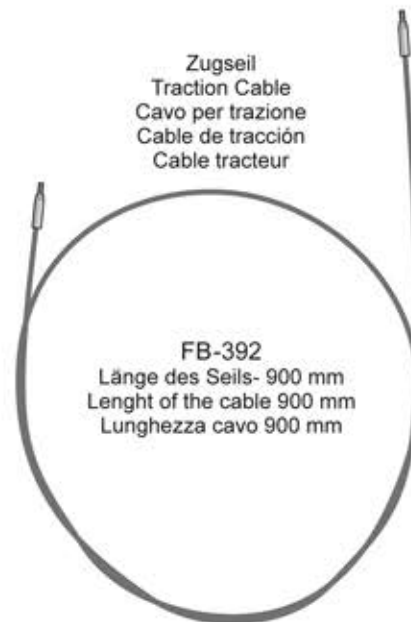

FB-392
Länge des Seils- 900 mm
Length of the cable 900 mm
Lunghezza cavo 900 mm

Wundhaken

Retractors

Divaricatori

Separadores

Ecarteurs

Nasenhaken
 Nasal Retractors
 Divaricatori nasali
 Separadores nasales
 Ecarteurs nasaux

Wundhaken mit Fiberoptikstab oval
 Retractors with Fiber optic oval
 Divaricatore a fibra ottica ovale
 Retractor con iluminación de luz fría
 Ecarteur avec illumination à lumière froide

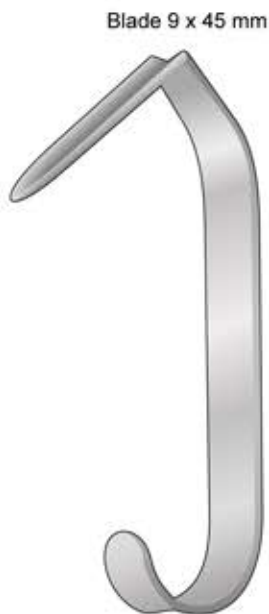

Blade 9 x 45 mm

MALINIAC
DO-200
 100 mm

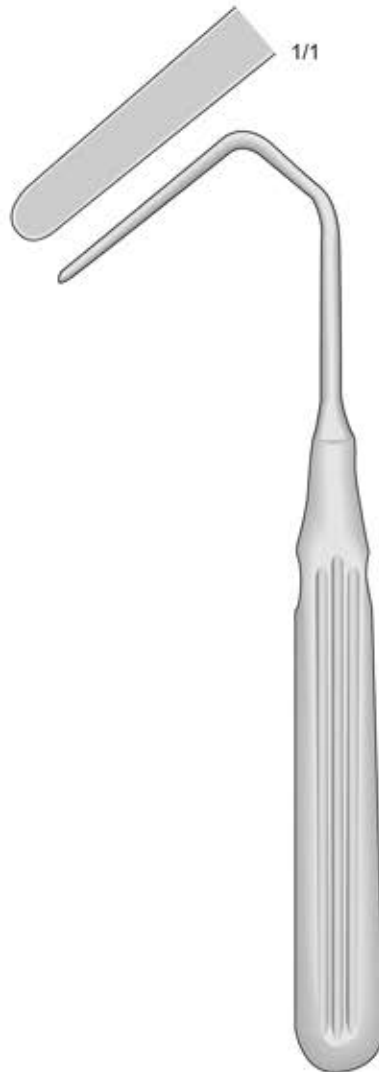

AUFRICHT
DO-48
 175 mm

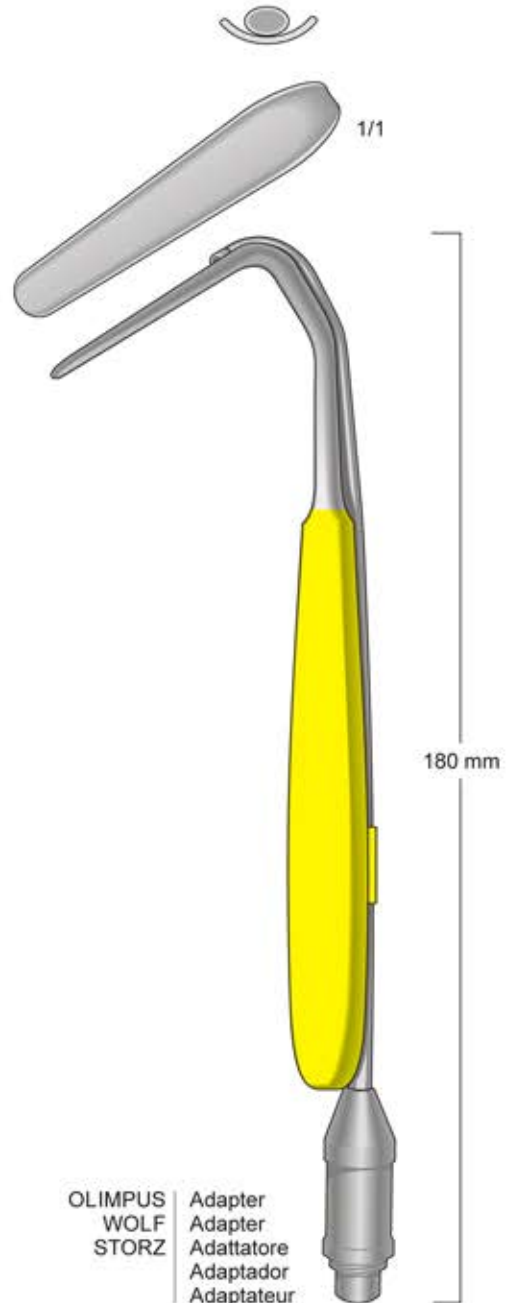

OLIMPUS Adapter
 WOLF Adapter
 STORZ Adapter
 Adattatore
 Adaptador
 Adaptateur

AUFRICHT
DO-401
 180 mm

Nasen Spekula
Nasal specula
Speculum nasali
Espéculos nasales
Spéculums nasaux

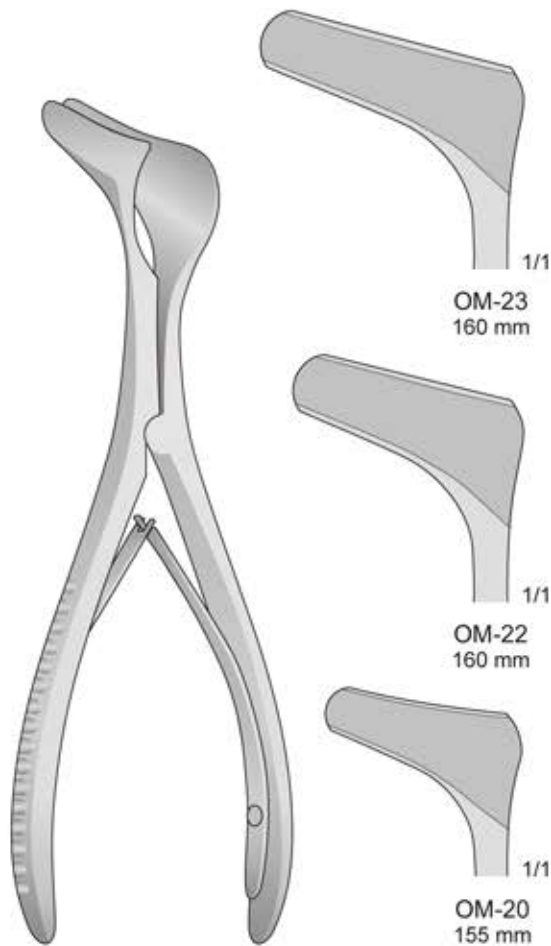

HARTMANN
OM-20/OM-23

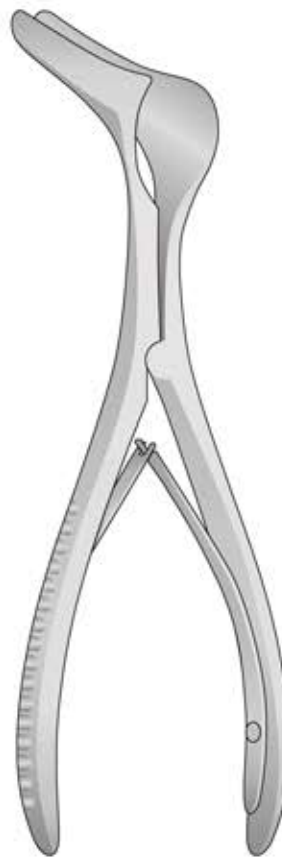

KILLIAN
OM-21/OM-31

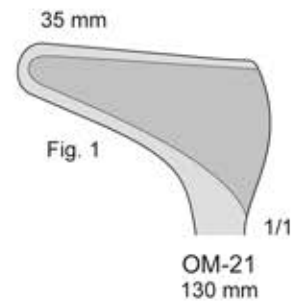
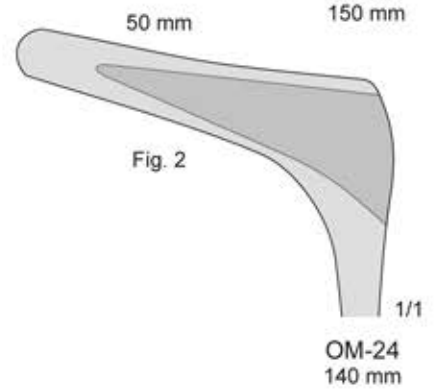
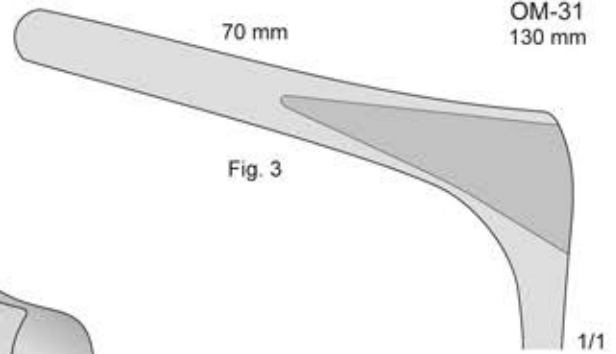
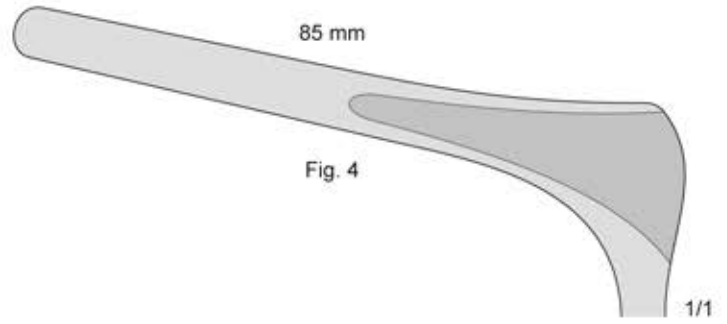

Nasen Spekula
Nasal specula
Speculum nasali
Espéculos nasales
Spéculums nasaux

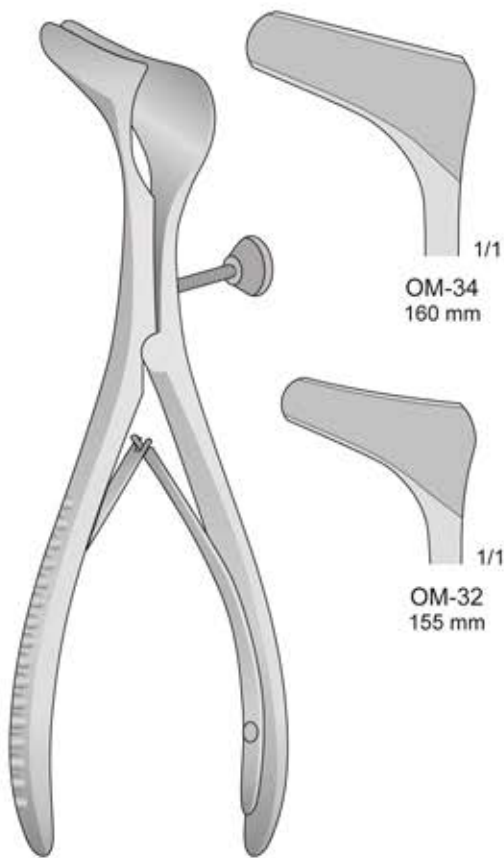

HARTMANN
OM-32/OM-34

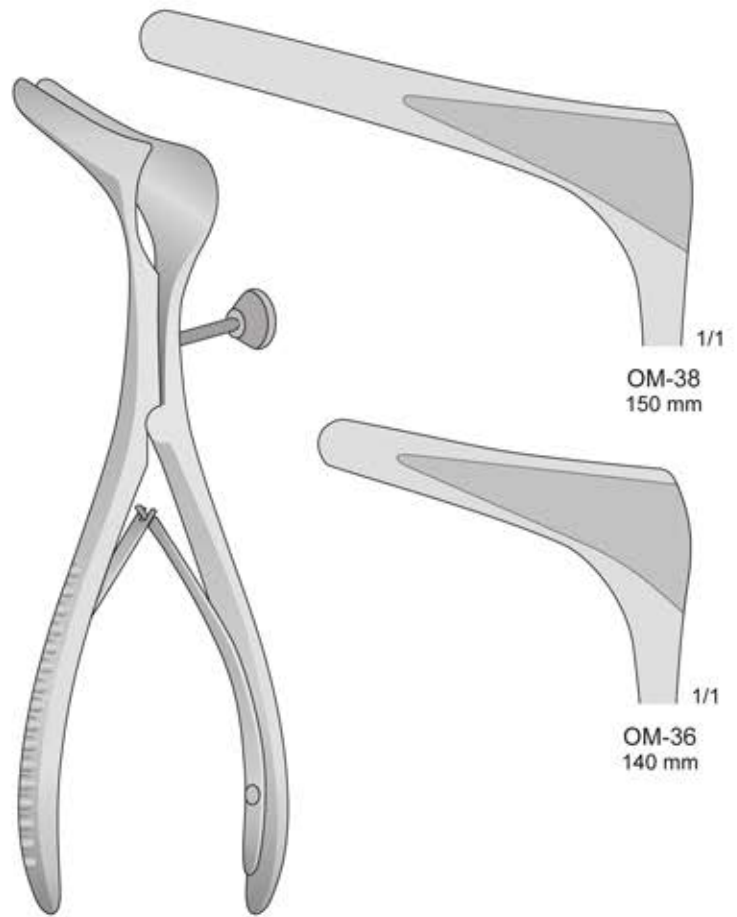

KILLIAN
OM-36/OM-38



TIECK-HALLE
OM-48/OM-49
135 mm

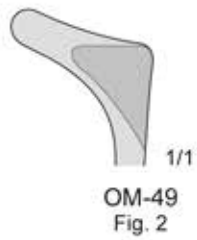
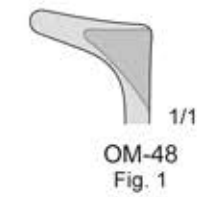

BECKMANN
OM-51/OM-54
150 mm

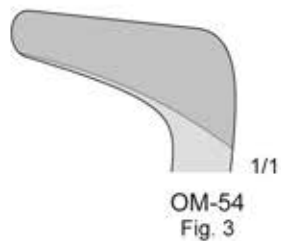
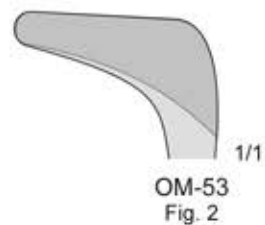
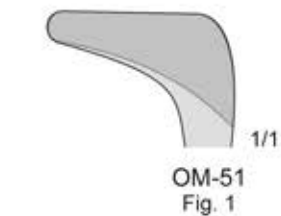

MODELL WIEN
OM-56/OM-59
140 mm

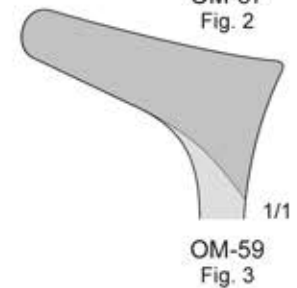
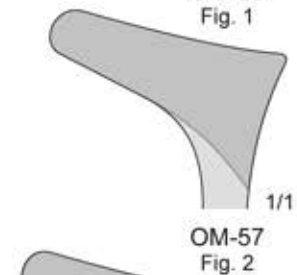
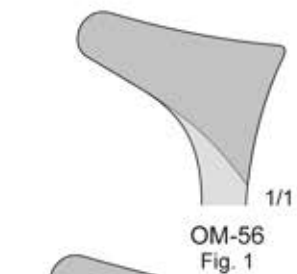



PAPAVERO-HARTMANN
OM-39
140 mm

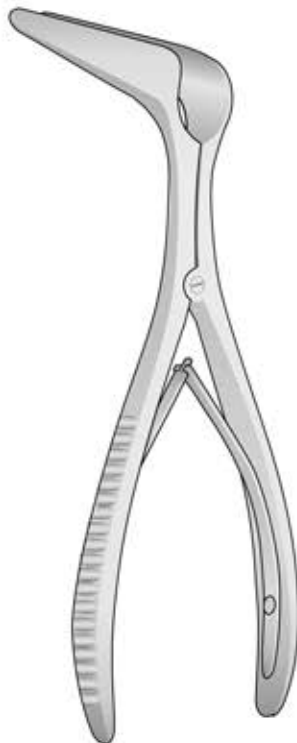

COTTLE
OM-25/OM-29
150 mm

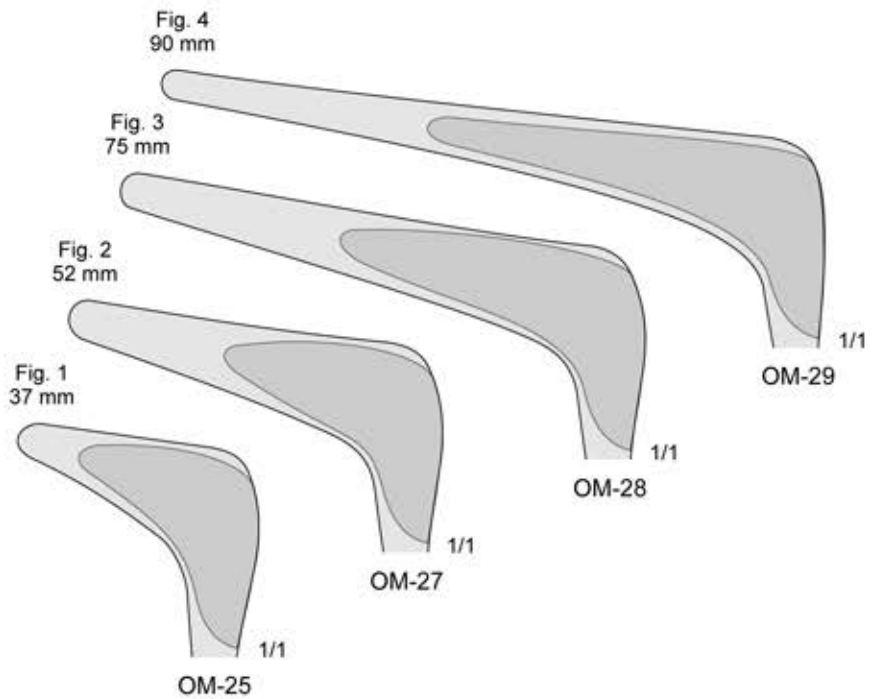



7

Raspatorien, Elevatorien
Raspatories, Elevators
Periostotomi, Elevatori
Raspadores, Elevadores
Rugines, Elevateurs

Elevatorii

Elevators

Elevatori

Elevadores

Elevateurs

Raspatorii
Periosteal Raspatories
Periostotomi
Legras periostotomos
Rugines à périostomie

4,5 mm

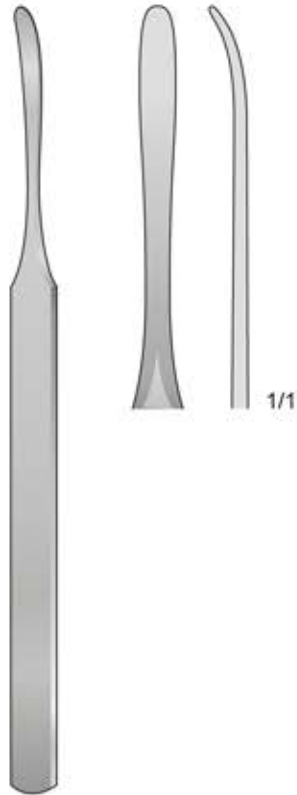

KÖNIG
KO-1
155 mm

4,5 mm

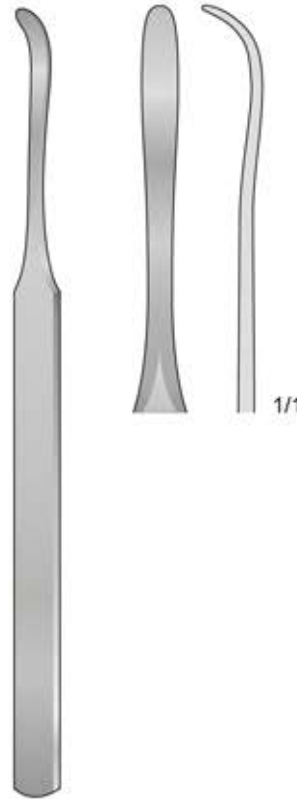

KÖNIG
KO-2
155 mm

5 mm

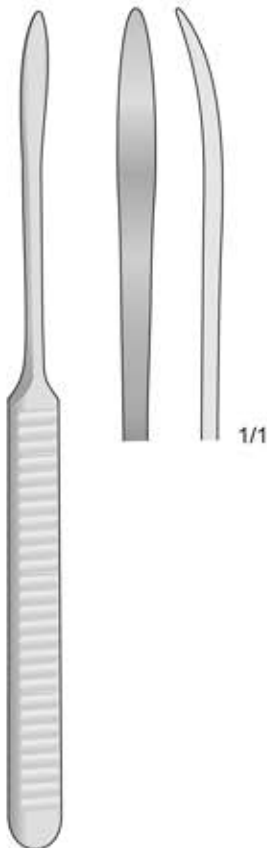

WILLIGER
WG-10
165 mm

6 mm

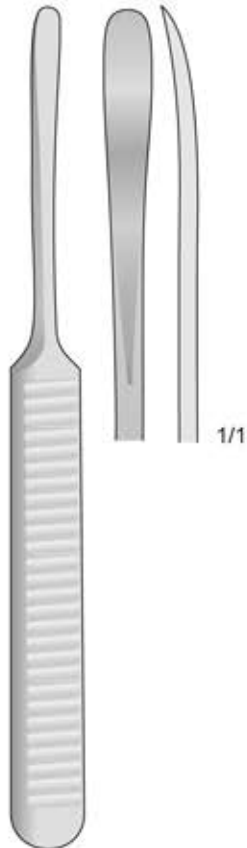

WILLIGER
WG-12
160 mm

4 mm

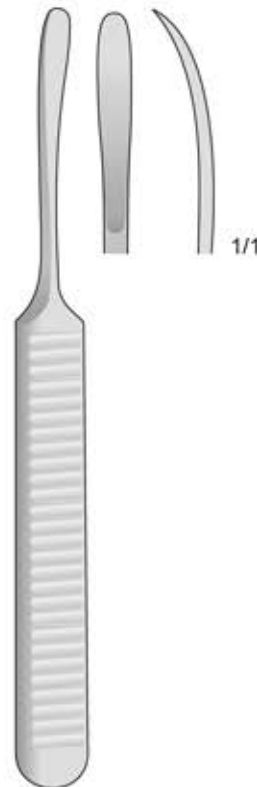

WILLIGER
WG-14
140 mm

Elevator

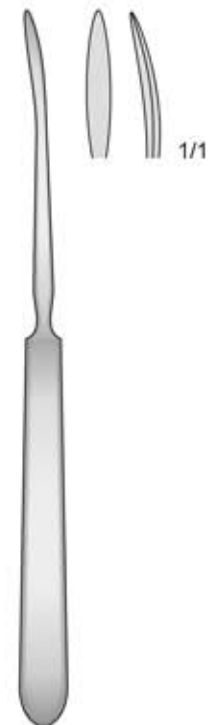

LUENEBURG
FR-10
115 mm

Dissektoren
Separatoren

Dissectors
Separators

Dissettori
Separatori

Disecadores
Descoladores

Dissecteurs
Separateurs

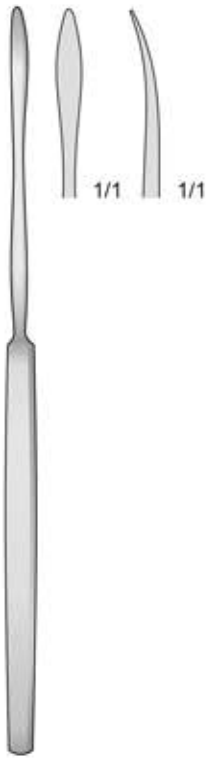

KO-18
175 mm

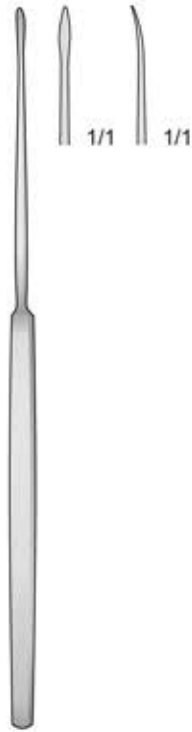

KO-19
160 mm



YANKAUER
KO-54
210 mm



MILLIGAN
KO-27
210 mm



DAVIS
KO-21
245 mm



FAGER
KO-24
200 mm



FAGER
KO-25
200 mm

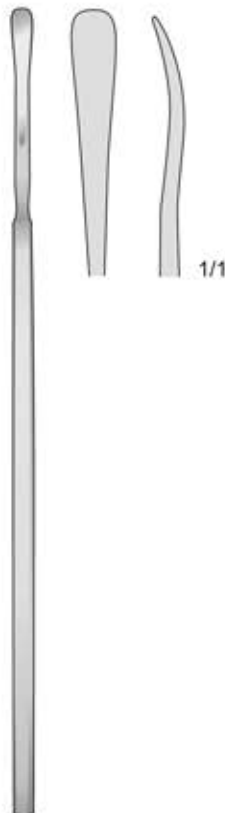

SACHS
KO-26
210 mm



SACHS
KO-28
210 mm

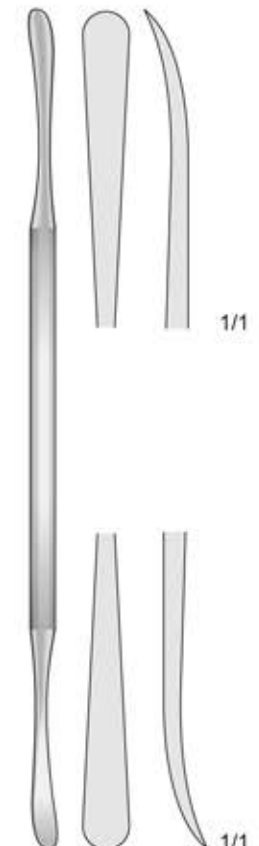

KO-29
220 mm

Dissektoren
Separatoren

Dissectors
Seperators

Dissettori
Separatori

Disecadores
Descoladores

Dissecteurs
Separateurs

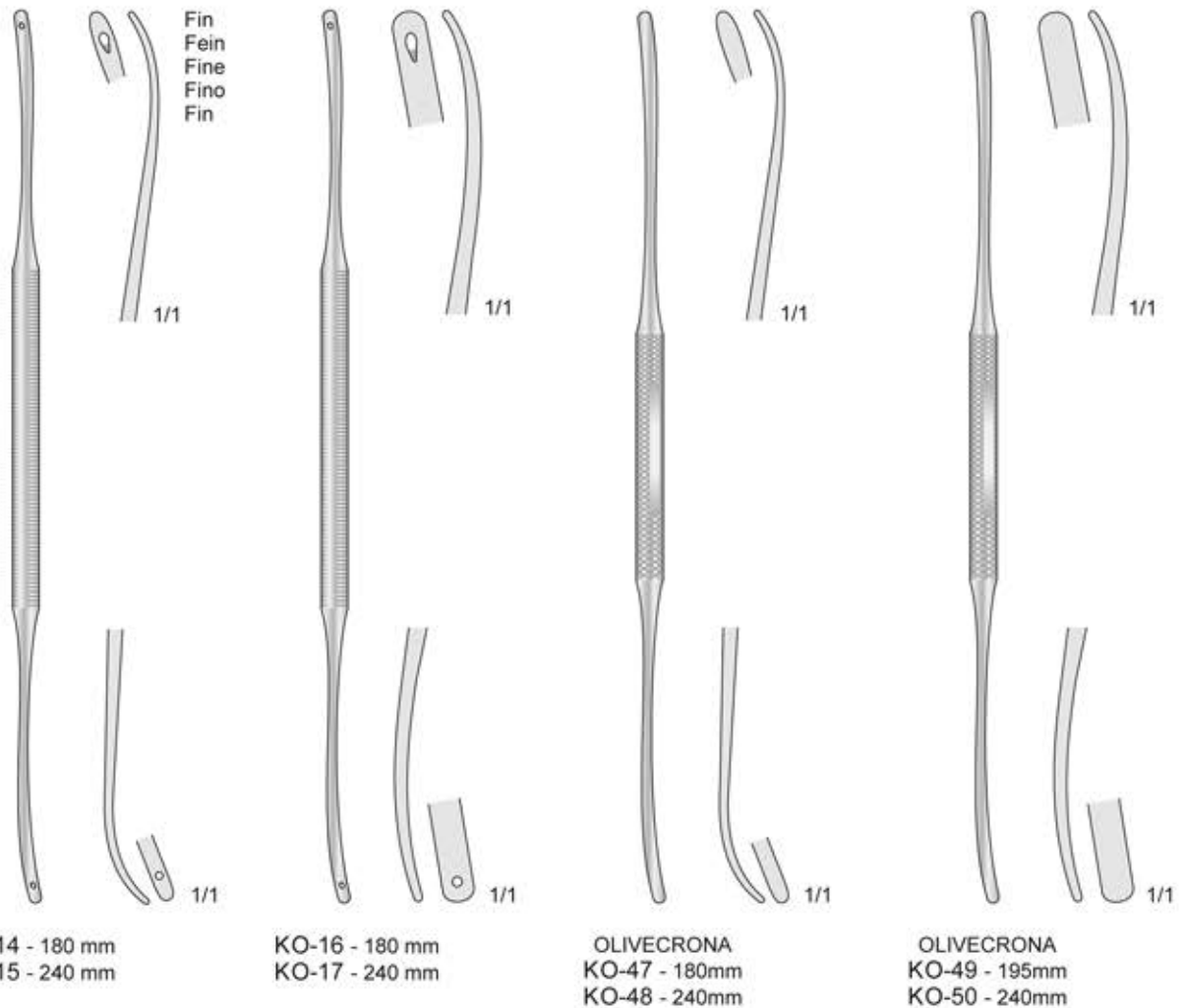

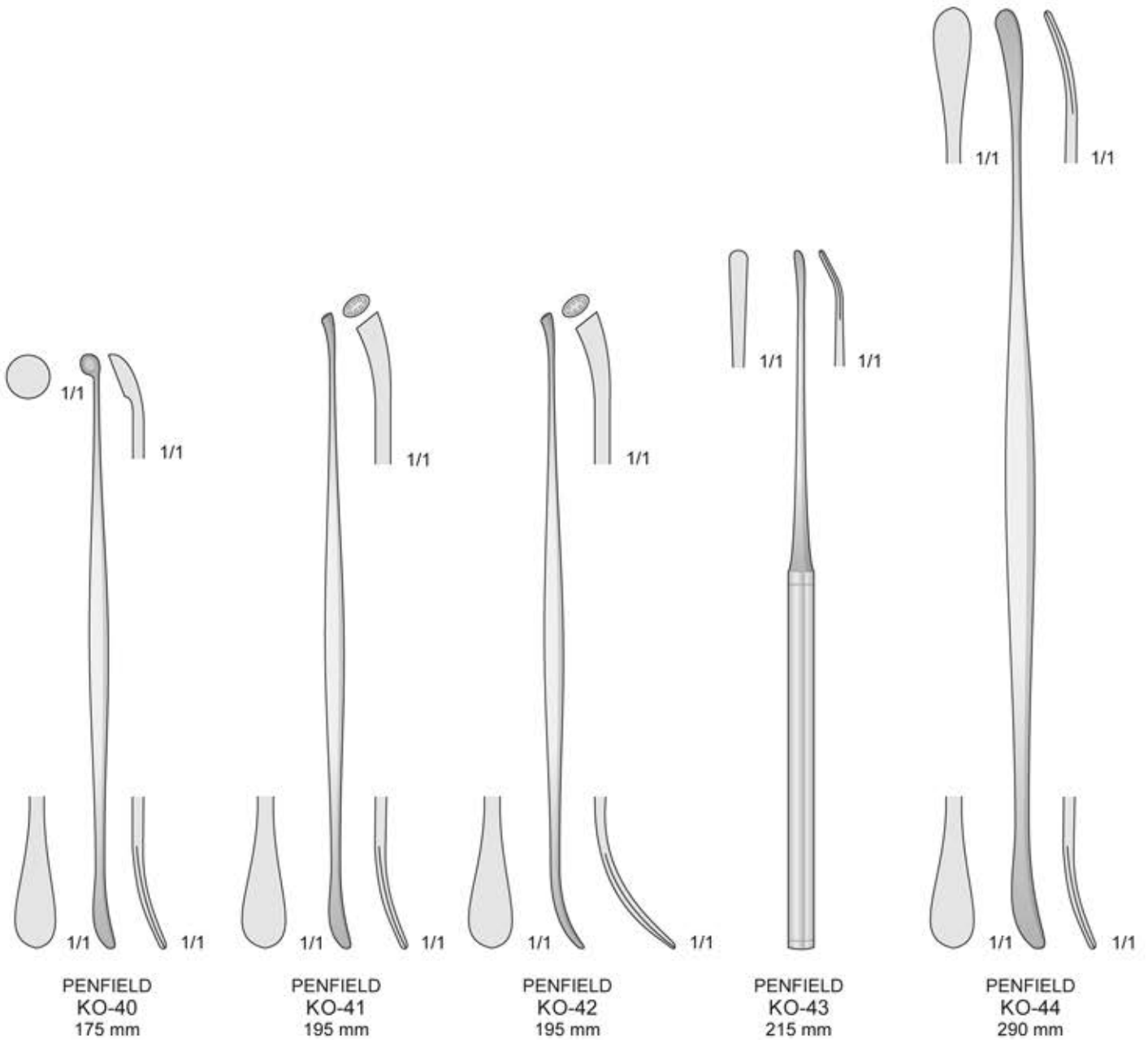

Raspatorien

Raspatories

Periostotomi

Legras

Rugines



718-24G
185 mm

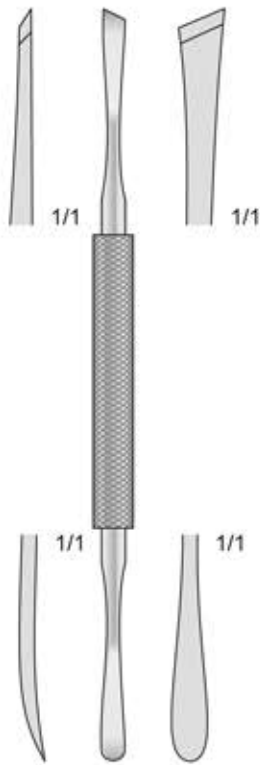

MEAD
165 mm

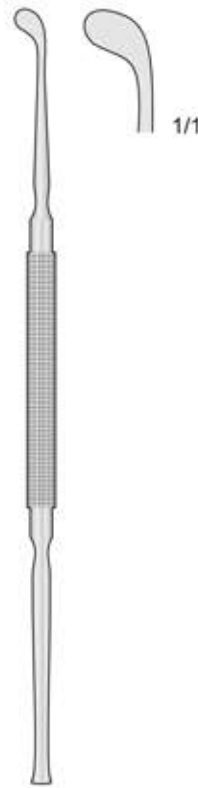

FREER
FR-15
190 mm

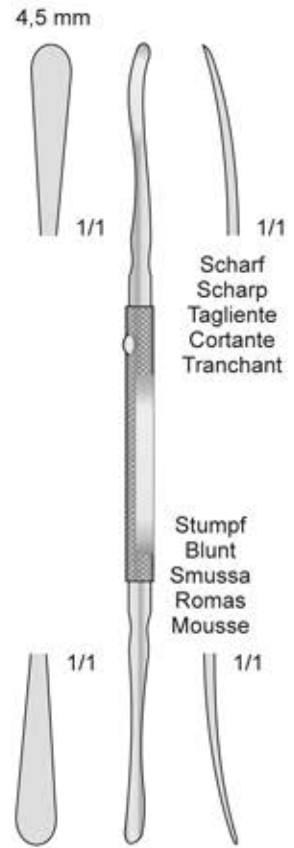

FREER
180 mm

Scharf
Scharp
Tagliente
Cortante
Tranchant

Stumpf
Blunt
Smussa
Romas
Mousse



ALDERDYCE
KO-39
210 mm

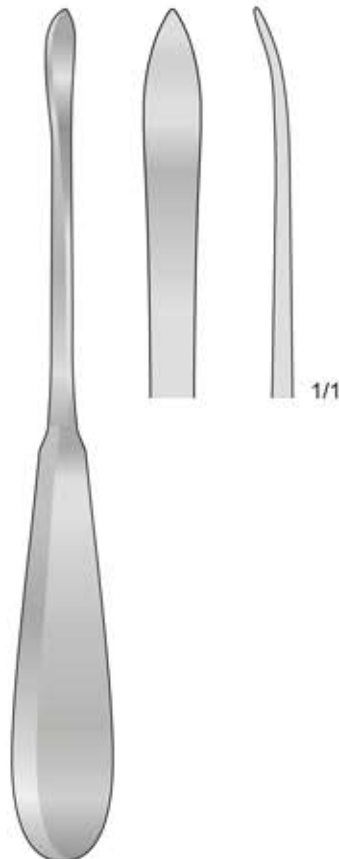

LANGENBECK
FK-12
200 mm

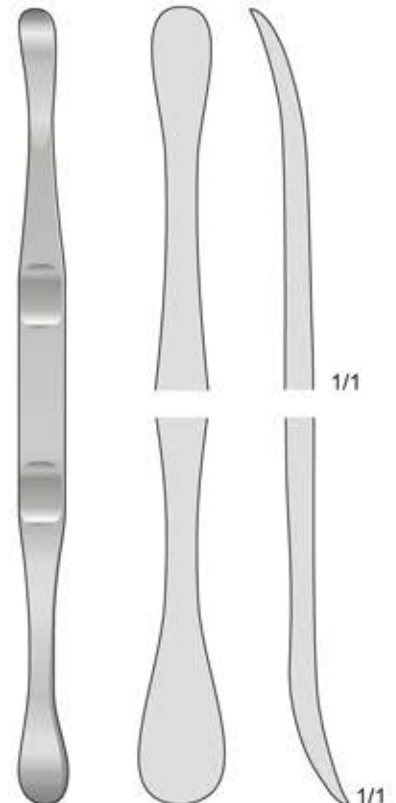

BABBUSH
KO-20
180 mm

Raspatorien

Raspatories

Periostotomi

Legras

Rugines

Septum Elevatorien
Periosteal Elevators
Elevatori per il setto nasale
Elevadores para el tabique nasal
Élévateurs pour cloison nasale

Scharf
Sharp
Tagliente
Cortante
Tranchant

Scharf
Sharp
Tagliente
Cortante
Tranchant

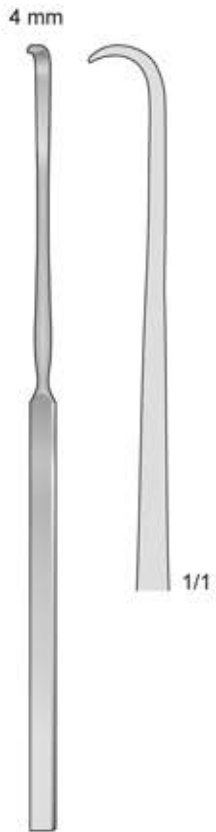

DO-244
200 mm



COTTLE
DO-60
220 mm



MASING
DO-47
210 mm

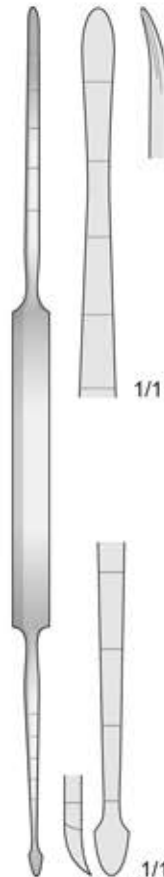

COTTLE
DO-111
210 mm

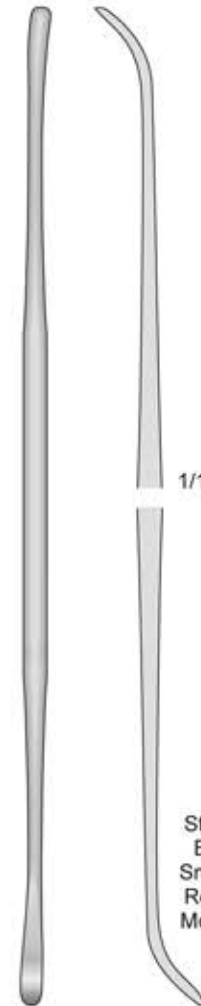

SALZBURG
DO-240
245 mm

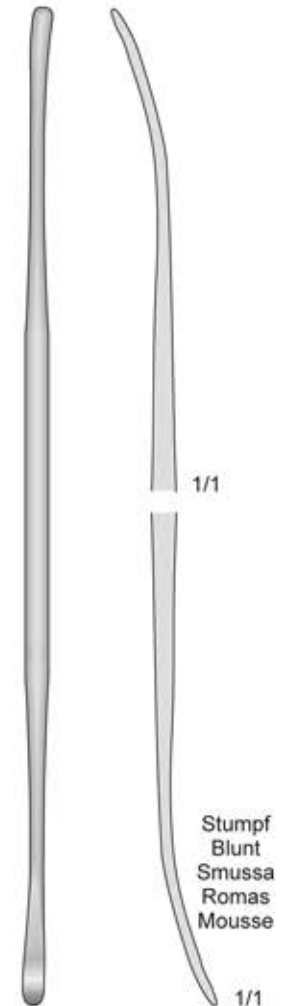

SALZBURG
DO-241
245 mm

Stumpf
Blunt
Smussa
Romas
Mousse

Stumpf
Blunt
Smussa
Romas
Mousse

Raspatorien

Raspatories

Periostotomi

Legras

Rugines

Septum Elevatorien - Periosteal Elevators - Elevatori per il setto nasale - Elevadores para el tabique nasal - Elévateurs pour cloison nasale



MCKENTY
KO-46
220 mm



BALLENGER-HAYEK
KO-61 190 mm
KO-62 220 mm

Scharf/Stumpf
Sharp/Blunt
Tagliente/Smusso
Cortante/Romo
Tranchant/Mousse



KILLIAN
KO-63
180 mm



HOWARTH
KO-30
210 mm

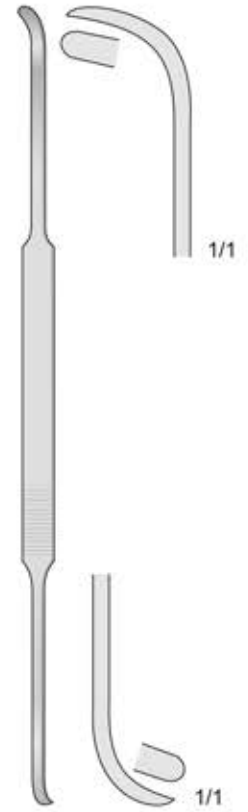

COTTLE
KO-12
230 mm

Scharf/Stumpf - Sharp/Blunt
Tagliente/Smusso - Cortante/Romo
Tranchant/Mousse

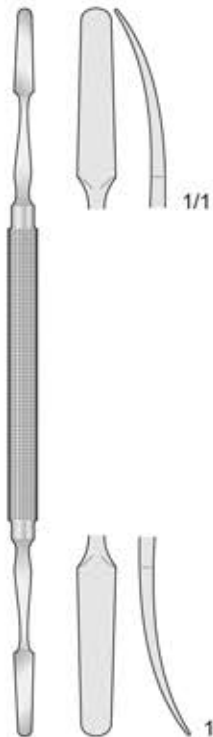

KILLIAN
KO-11
180 mm



KILLIAN
KO-13
220 mm

Scharf/Stumpf
Sharp/Blunt
Tagliente/Smusso
Cortante/Romo
Tranchant/Mousse



PIERCE
KO-64
210 mm

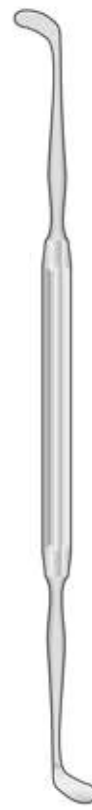

PENNINGTON
KO-65
210 mm

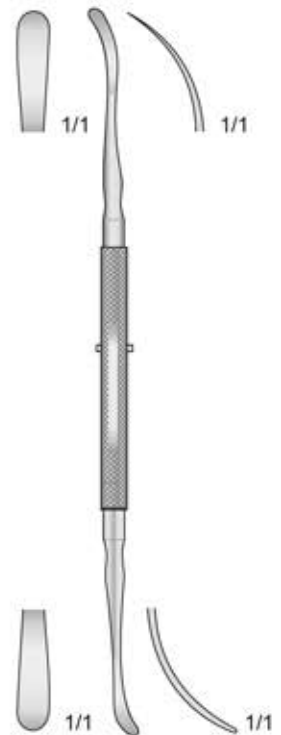

ROGER
KO-66
180 mm

Raspatorien

Raspatories

Periostotomi

Legras

Rugines

Raspatorien, Elevatorien, Flachmeißel - Raspatories, Elevators, Chisels



CARTER
KO-67
210 mm

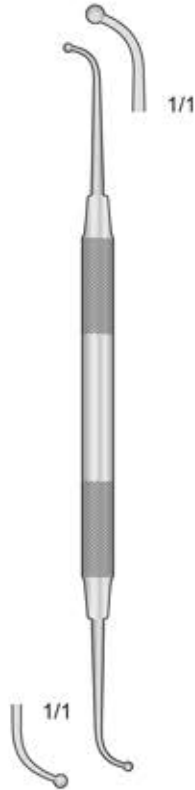

712-18
180 mm

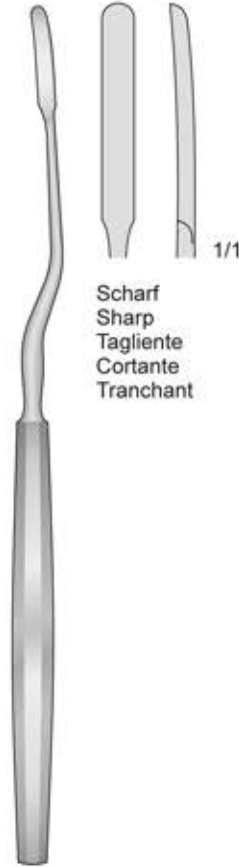

MASING
KO-68
220 mm



SEWALL
KO-69
200 mm

Scharf
Sharp
Tagliente
Cortante
Tranchant

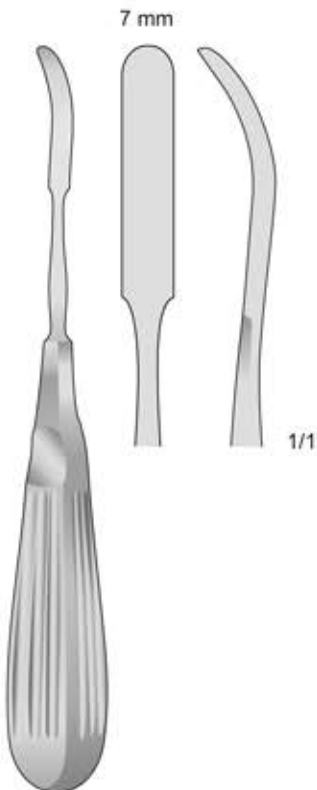

JOSEPH
FK-82
180 mm



COTTLE
DO-211
180 mm

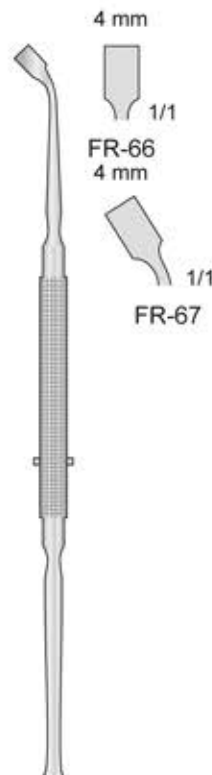

FREER
FR-66/FR-67
190 mm



TG-11
160 mm

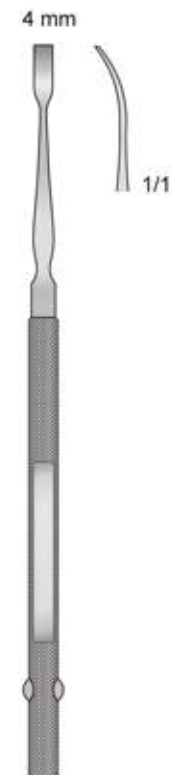

FREER
TG-23
160 mm

Raspatorien

Raspatories

Periostotomi

Legras

Rugines

Septum Elevatorien - Periosteal Elevators - Elevatori per il setto nasale
 Elevadores para el tabique nasal - Elévateurs pour cloison nasale

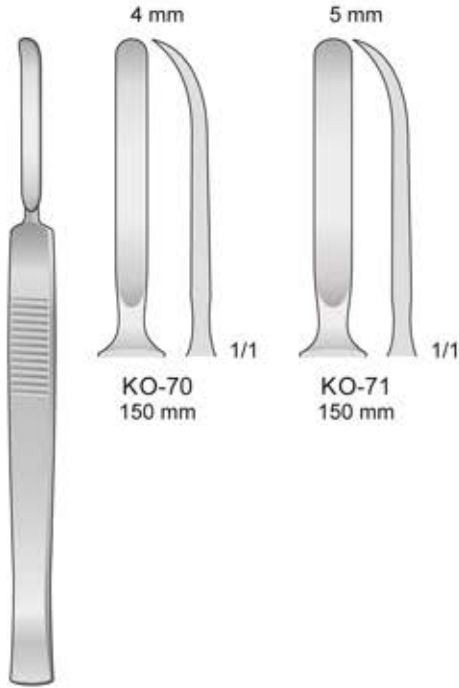

Mc KENTY
 KO-70/KO-71
 150 mm

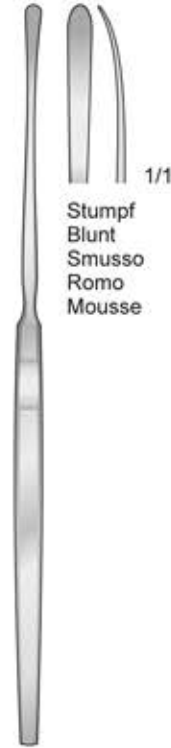

KO-72
 180 mm



WALTON
 DO-292/DO-296
 160 mm

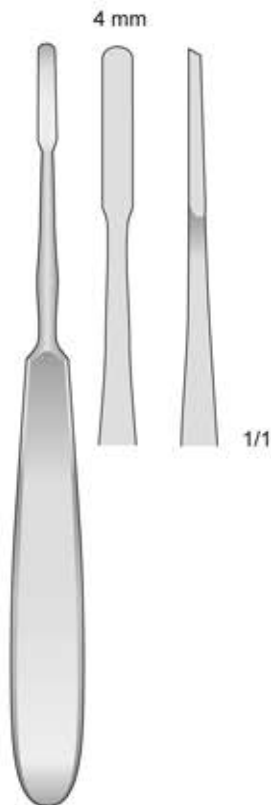
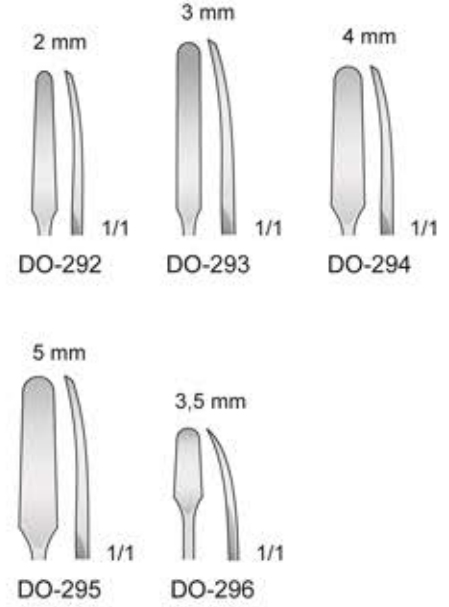

FOMON
 FK-264
 170 mm

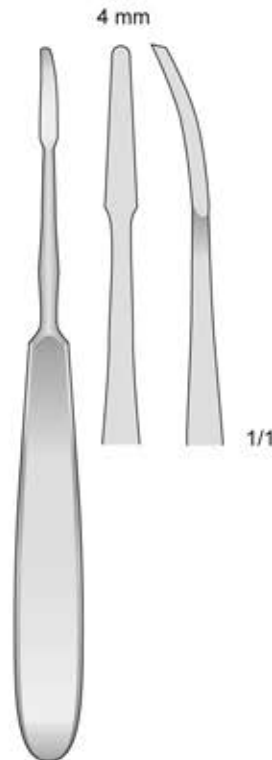

JOSEPH
 FK-265
 160 mm

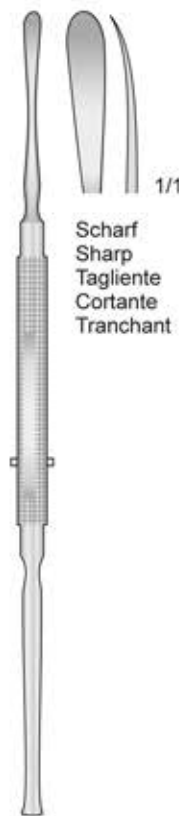

FREER
 FR-64
 190 mm

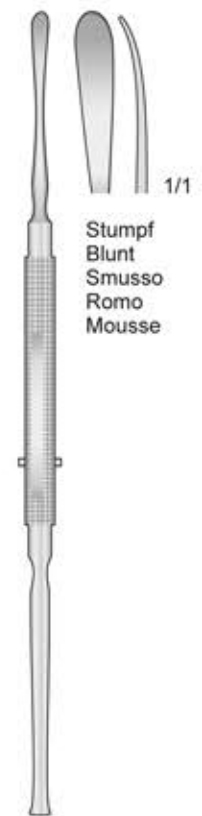

FREER
 FR-65
 190 mm

Raspatorien - Scharf
Raspatories - Sharp
Periostotomi - Taglienti
Legras - Cortante
Rugines - Tranchant

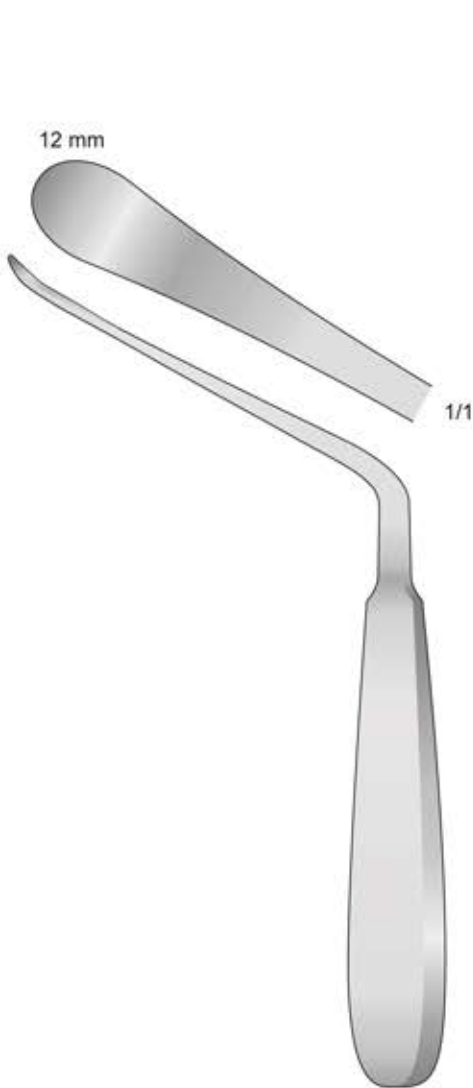

DO-125
210 mm

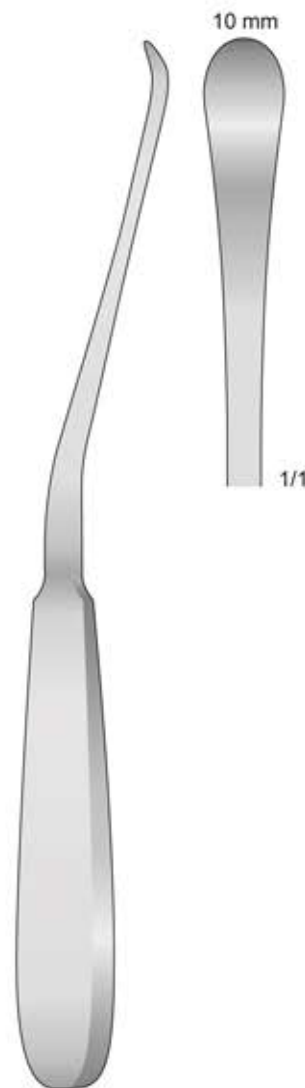

DO-126
235 mm

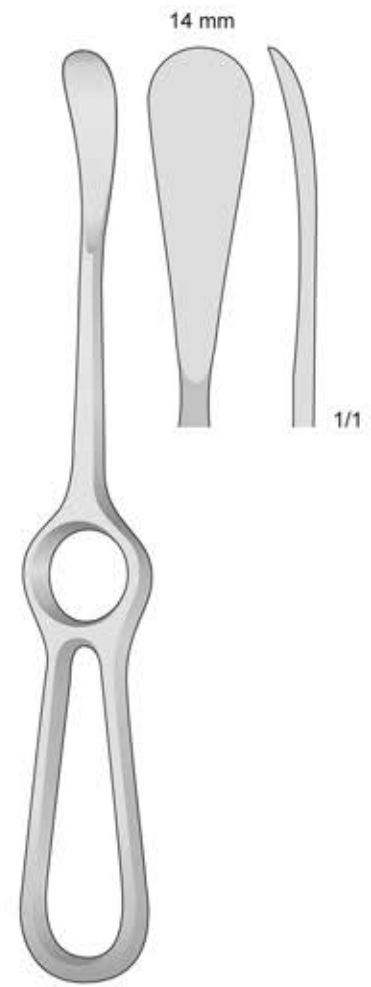

SEDILLOT
BT-37
210 mm

Periosteal elevators

Scharf
Sharp
Taglienti
Cortante
Tranchant

6 mm



OBWEGESER
DO-59
175 mm

7 mm



OBWEGESER
DO-63
175 mm

9 mm



OBWEGESER
DO-67
175 mm

11 mm



OBWEGESER
DO-65
175 mm

Raspatorien, Elevatorien
Raspatories, Elevators

Massiv - Solid - Manico pieno - Massif

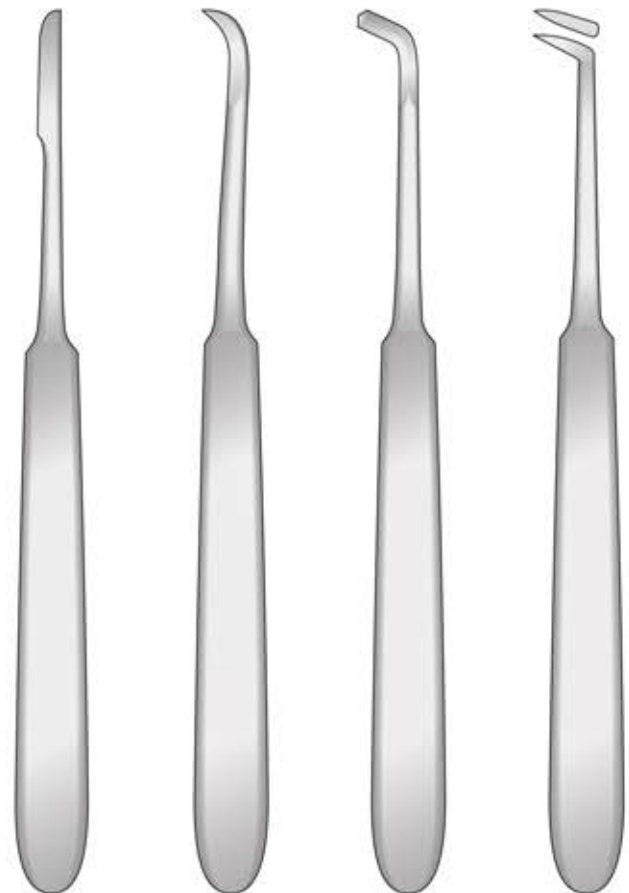
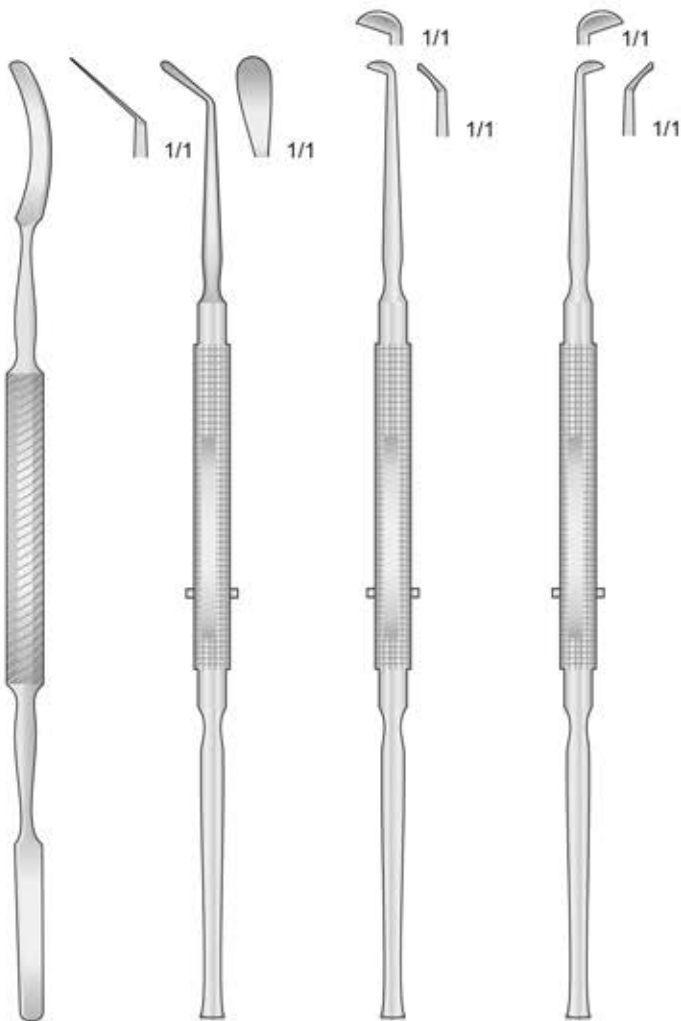

MC DONALD
KO-38
190 mm

FREER
FR-100

FREER
FR-166

FREER
FR-167

CH-11
150 mm

CH-12
150 mm

CH-13
150 mm

CH-14
145 mm

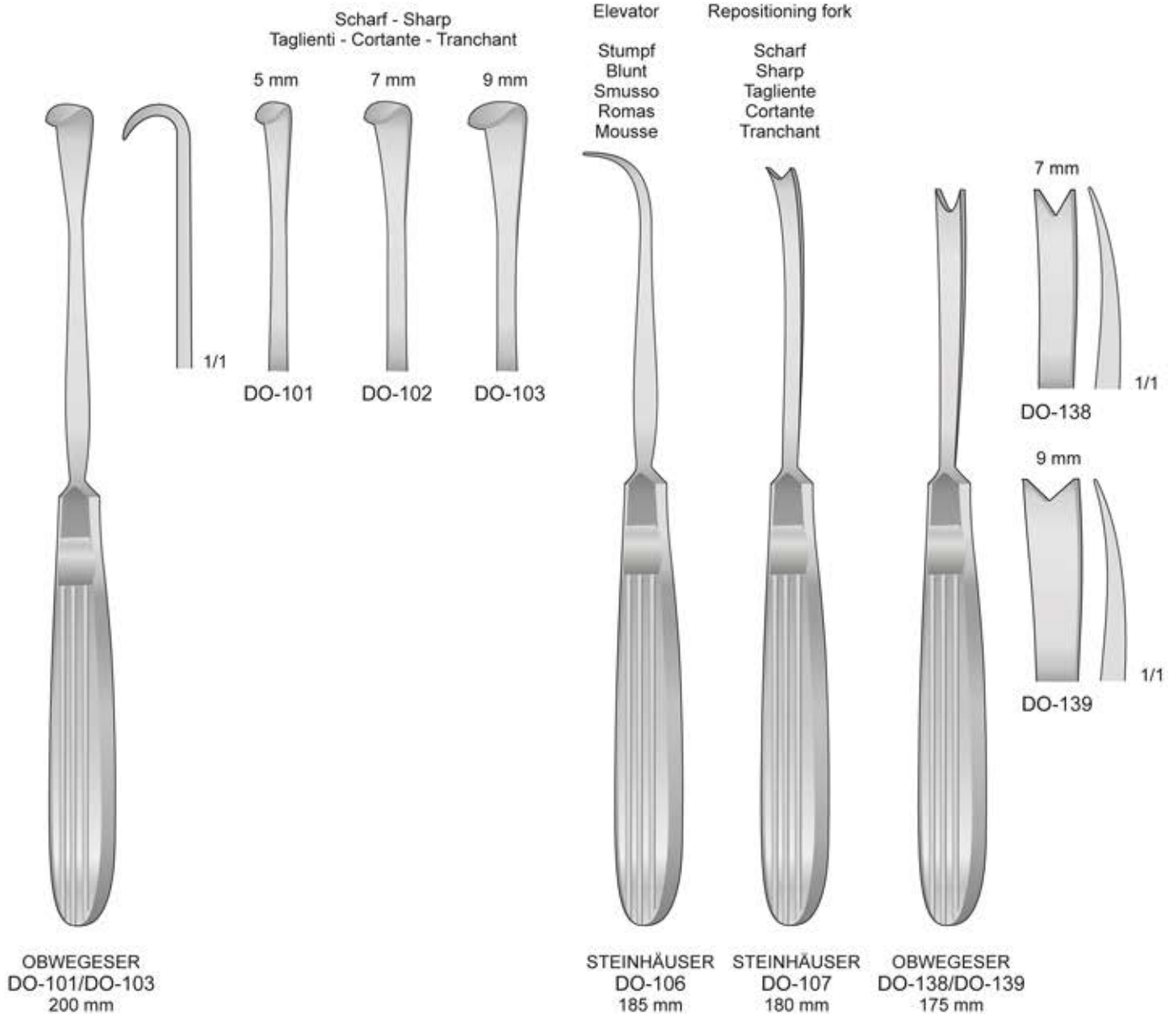

Raspatorien

Periosteal Raspatories

Periostotomi - Raspatori

Periostotomos - Legras

Rugines à périostomie

15 mm

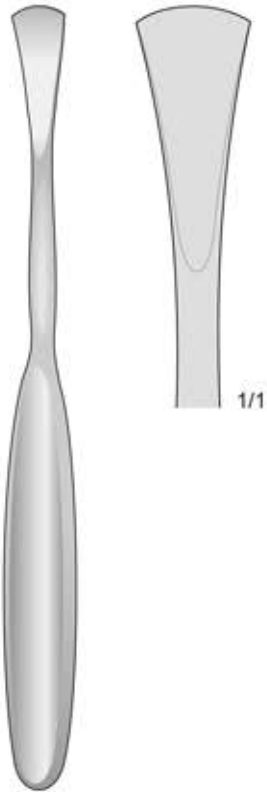

CUSHING
FK-252
190 mm

8 mm



ADSON
FK-260/FK-263
170 mm

7 mm



7 mm



7 mm

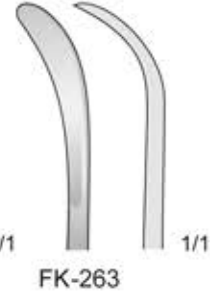

FK-260

FK-261

FK-262

FK-263

2,5 mm

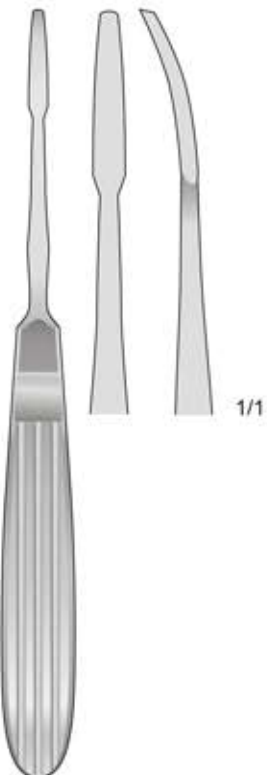

JOSEPH
FK-80
170 mm

7 mm

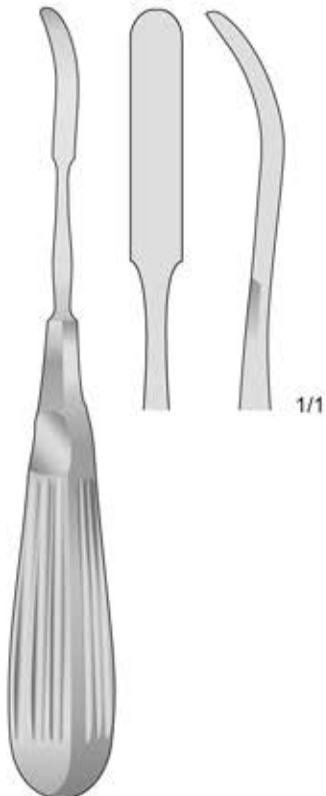

JOSEPH
FK-82
180 mm

10 mm



MOLT
MO-15
160 mm

10 mm

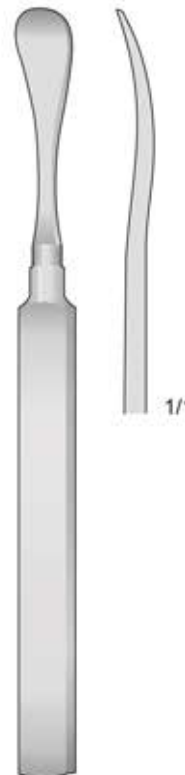

HENAHAN
BT-05/BT-07
175 mm

12 mm



BT-05

BT-06

15 mm



BT-07

Raspatorien

Periosteal Raspatories

Periostotomi - Raspatori

Periostotomos - Legras

Rugines à périostomie

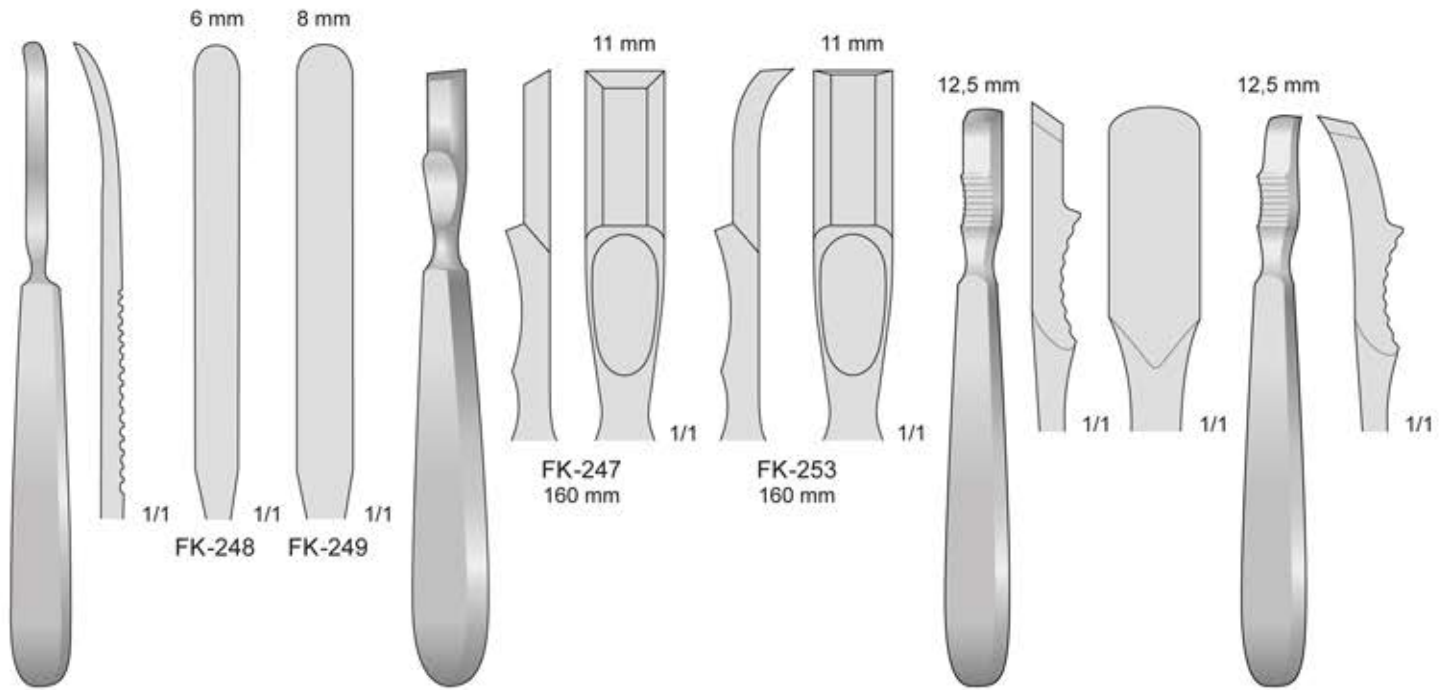

FK-248/FK-249
170 mm

FARABEUF-COLLIN
FK-247/FK-253
160 mm

FARABEUF
FK-250
150 mm

FARABEUF
FK-251
150 mm

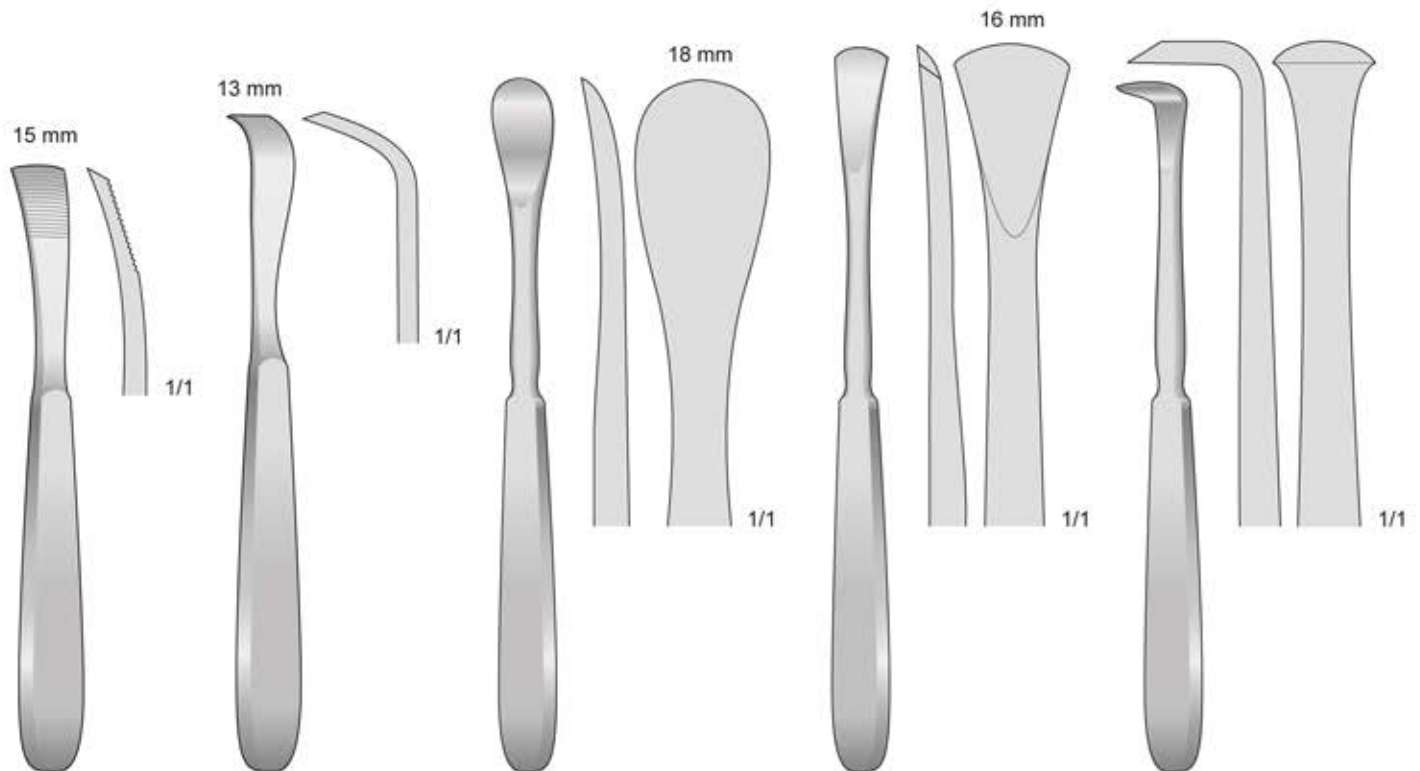

JANSEN
FK-255
165 mm

SCHNEIDER
FK-258
175 mm

SEDILLOT
FK-254
185 mm

LANGENBECK
FK-256
190 mm

LANGENBECK
FK-257
180 mm

8

Knochenmeißel, Hammer
Bone Chisels, Hammers
Scalpelli, Martelli
Cinceles, Martillos
Scalpel, Mallets

Osteotome

Osteotomes

Osteotomi

Osteótomos

Ostéotomes

Septummeißel
 Septum Chisels
 Scalpelli per il setto nasale
 Cinceles para tabique nasal
 Ciseaux-Burins pour la cloison nasale

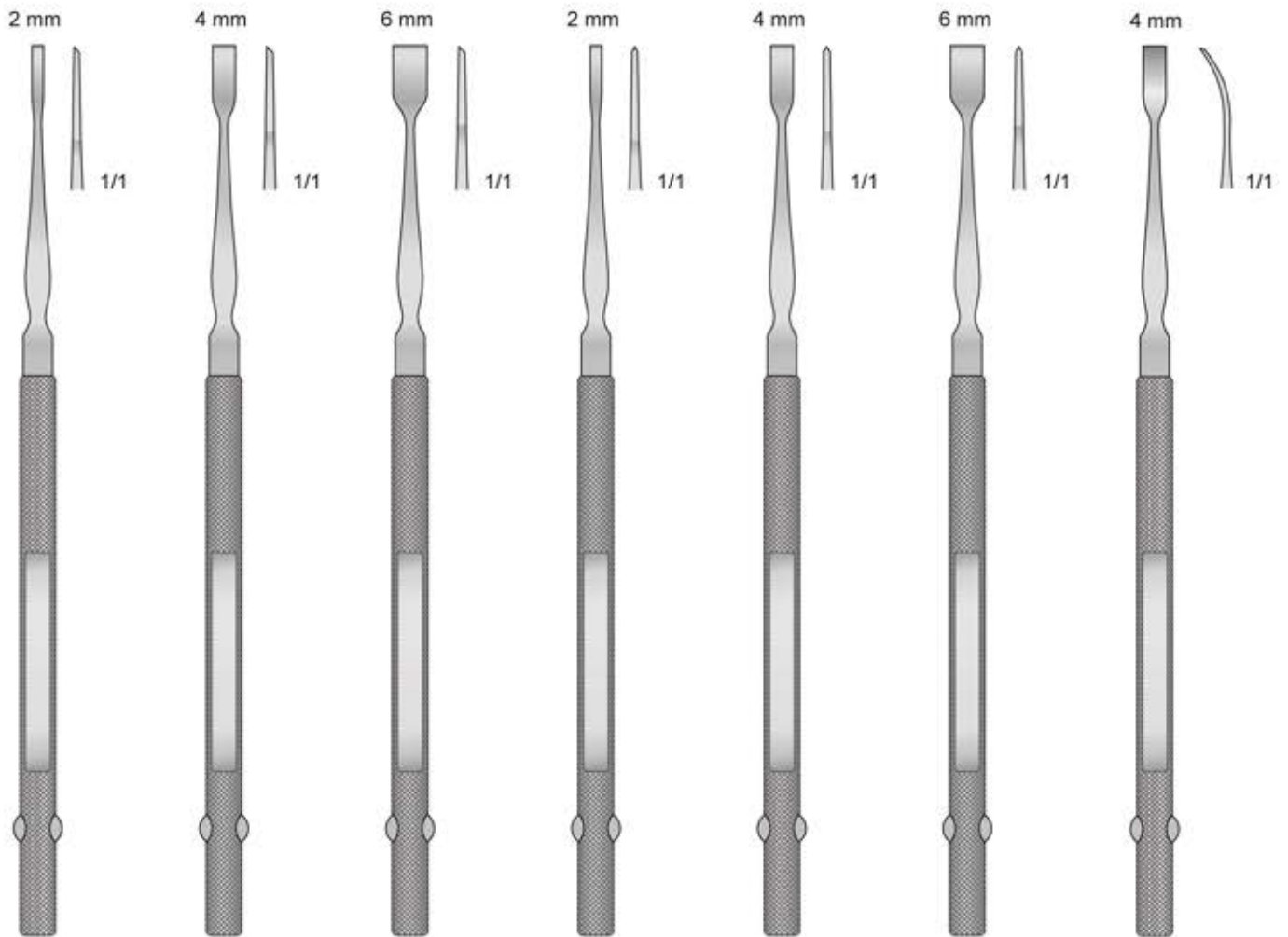

TG-10
160 mm

TG-11
160 mm

TG-12
160 mm

TG-20
160 mm

TG-21
160 mm

TG-22
160 mm

FREER
TG-23
160 mm

Osteotome

Osteotomes

Osteotomi

Osteótomos

Ostéotomes

3,8 mm
1/1



FL-141
170 mm

3,8 mm
1/1

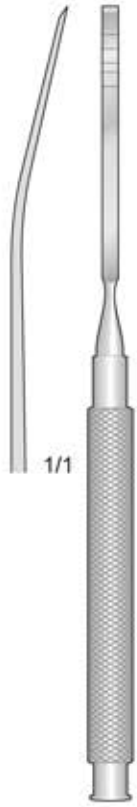

FL-142
170 mm

7,5 mm
1/1



FL-143
170 mm

7,5 mm
1/1

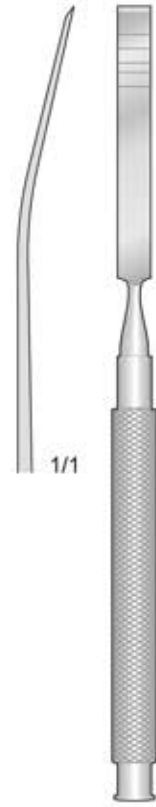

FL-144
170 mm

3 mm
1/1



TG-30
155 mm

6 mm
1/1



TG-31
155 mm

9 mm
1/1



TG-32
155 mm

4 mm
1/1



BUCKLEY
TG-40
160 mm

4 mm
1/1



BUCKLEY
TG-41
160 mm

Septum-Hohlmeißel
Septum Gouges
Sgorbie per il setto nasale
Gubias para el tabique nasal
Gouges pour la cloison nasale

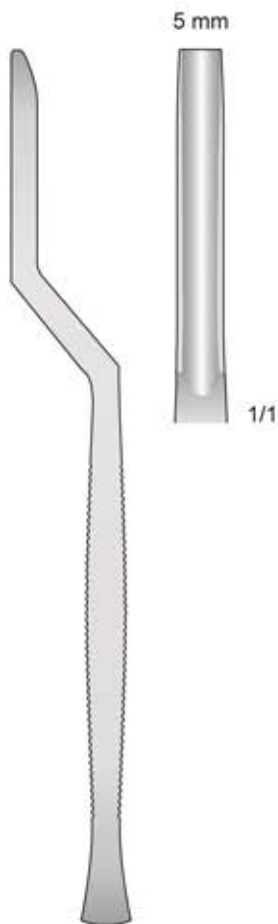

KILLIAN
DO-91
160 mm

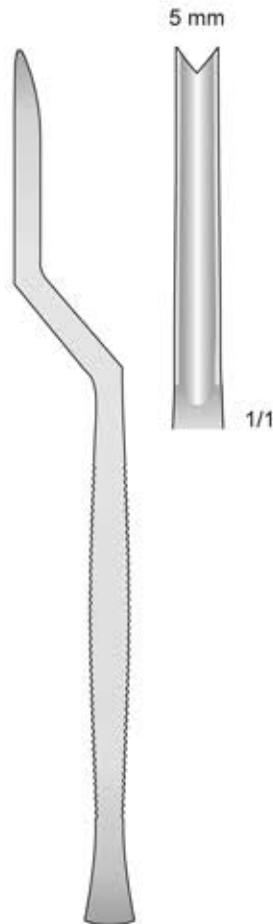

KILLIAN-KLAUS
DO-92
160 mm

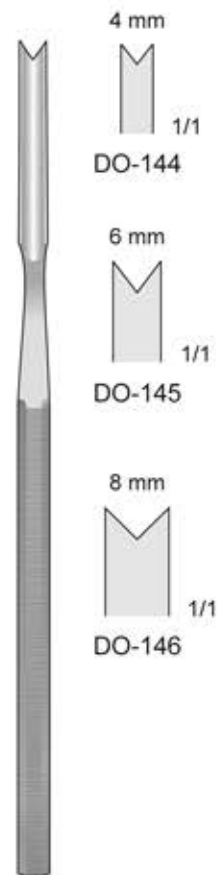

BALLENGER
DO-144/DO-146
150 mm

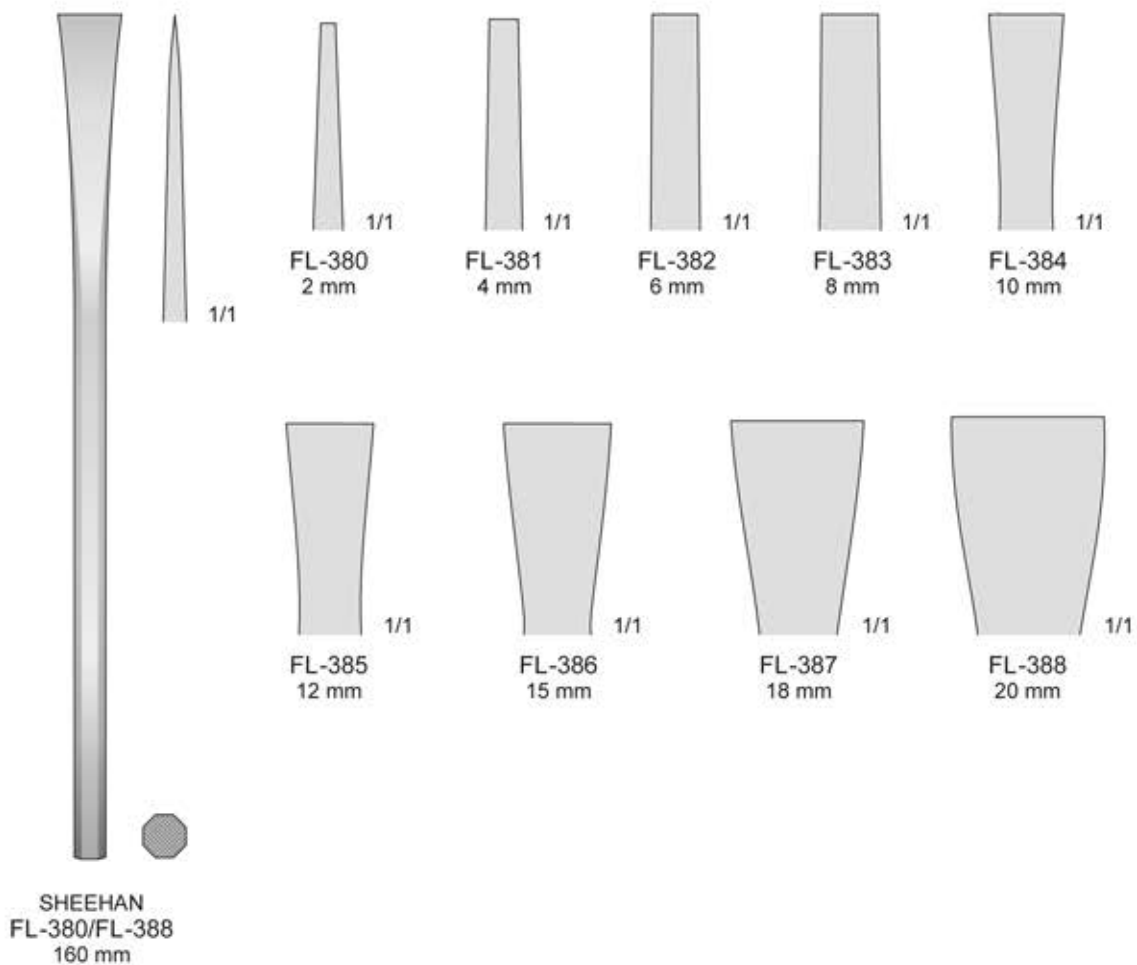

Osteotome -Osteotomes
Osteotomi - Osteótomos - Ostéotomes

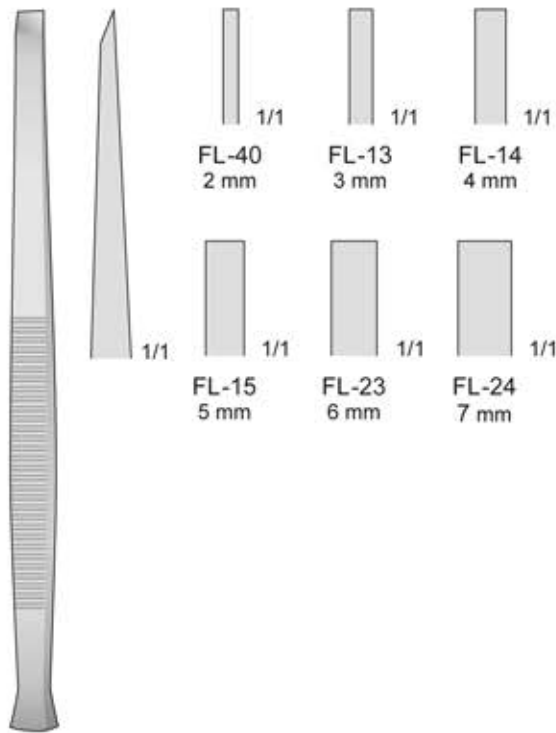

PARTSCH
FL-13/FL-40
140 mm

Hohlmeissel - Gouges
Sgorbie - Gubias - Gouges

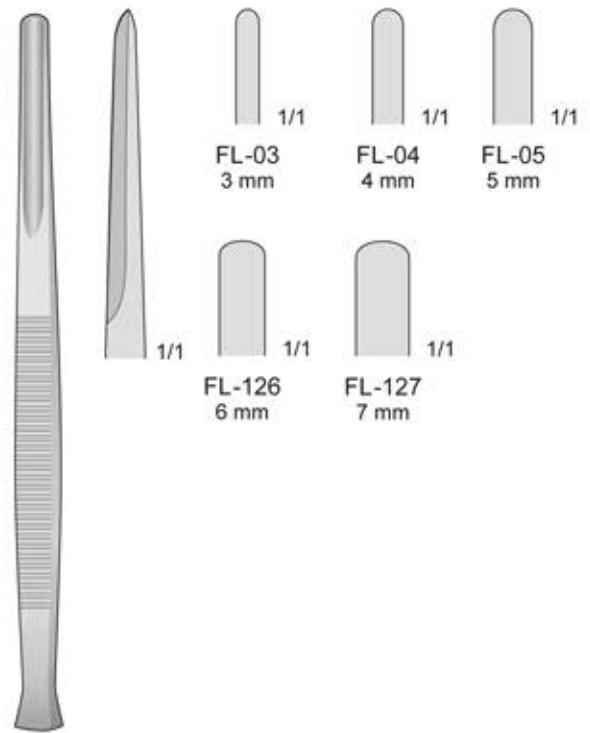

PARTSCH
FL-03/FL-127
140 mm

Osteotome -Osteotomes
Osteotomi - Osteótomos - Ostéotomes

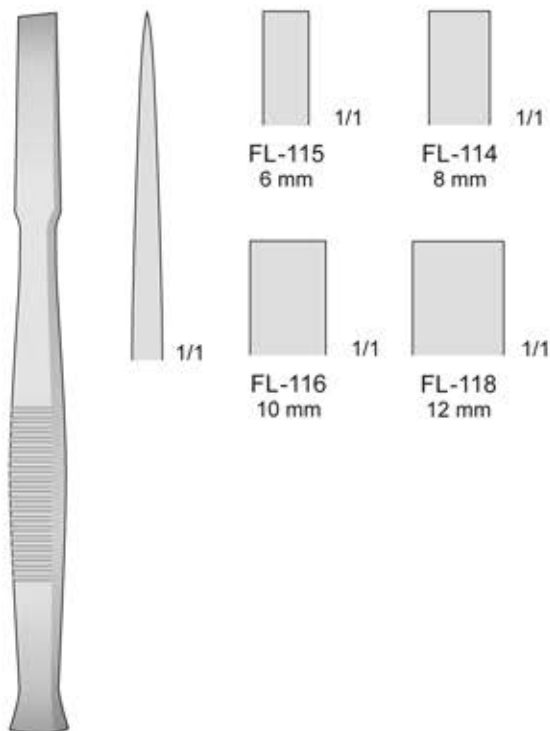

FL-114/FL-118
140 mm

Hohlmeissel - Gouges
Sgorbie - Gubias - Gouges

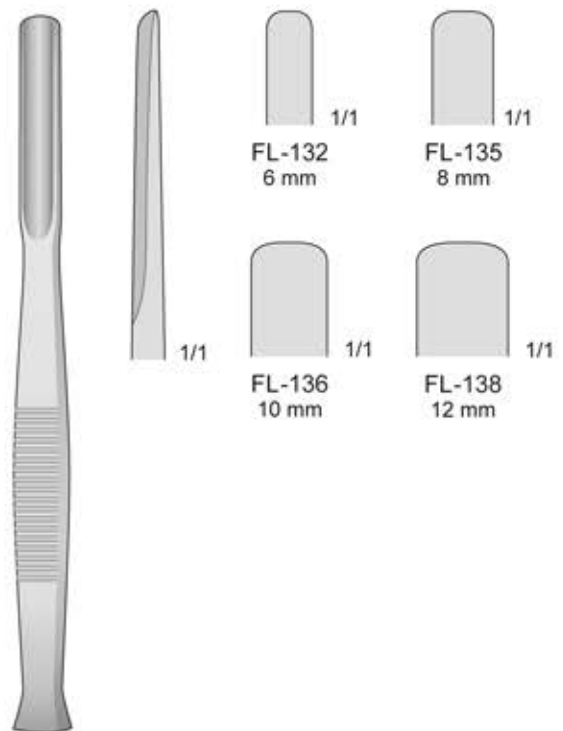

FL-132/FL-138
140 mm

Flachmeißel



WEST
FL-133
160 mm

Hohlmeißel



WEST
FL-134
160 mm



PARTSCH
FL-177/FL-181
170 mm

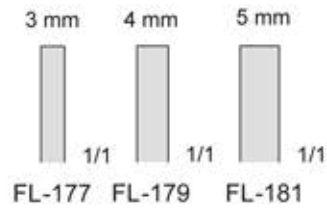

PARTSCH
FL-185/FL-187
170 mm

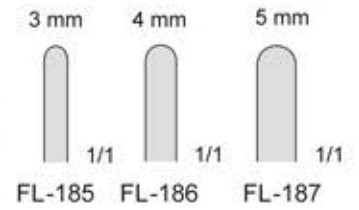
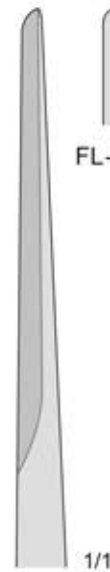

Osteotome

Osteotomes

Osteotomi

Osteótomos

Ostéotomes

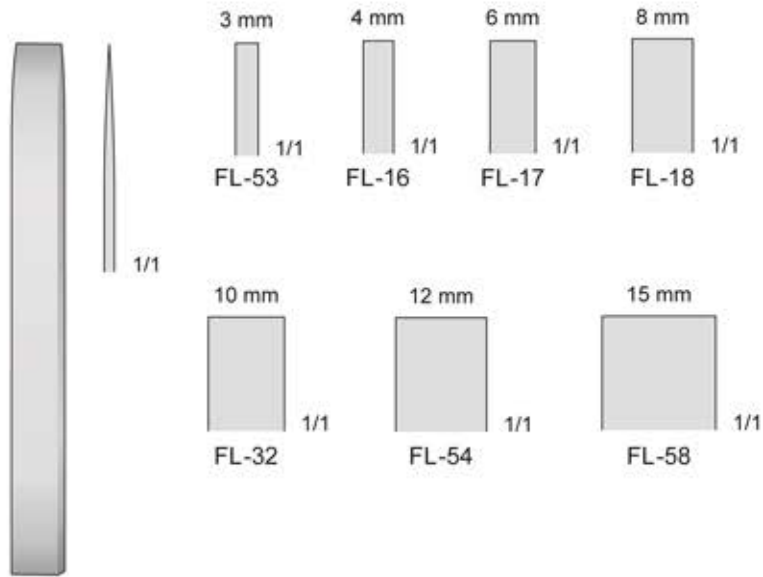

MINI-LAMBOTTE
FL-16/FL-58
125 mm

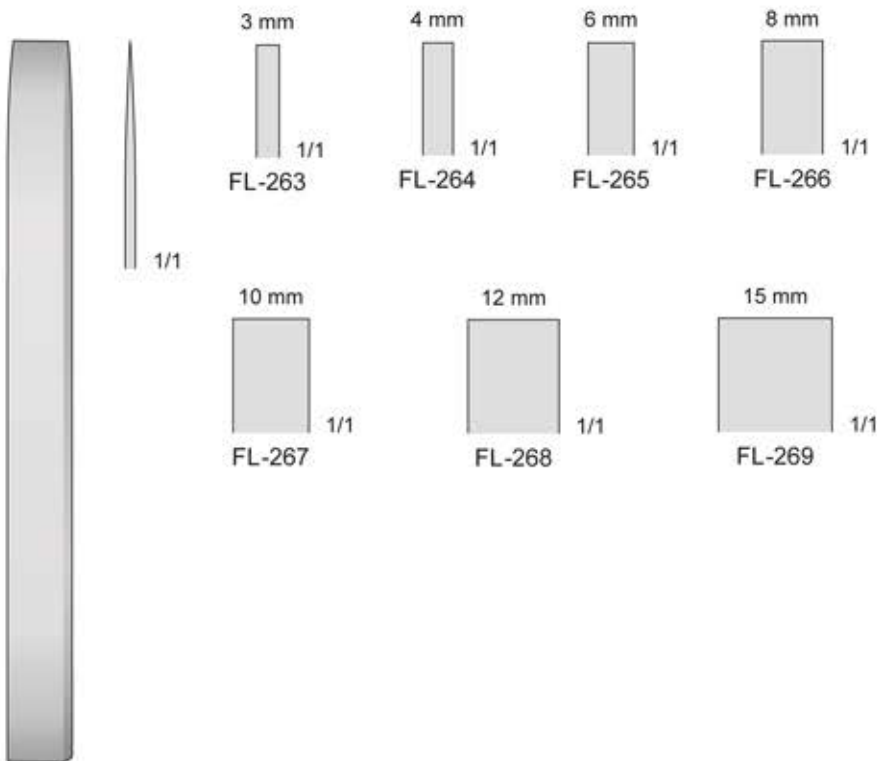

MINI-LAMBOTTE
FL-263/FL-269
170 mm

Osteotome

Osteotomes

Osteotomi

Osteótomos

Ostéotomes

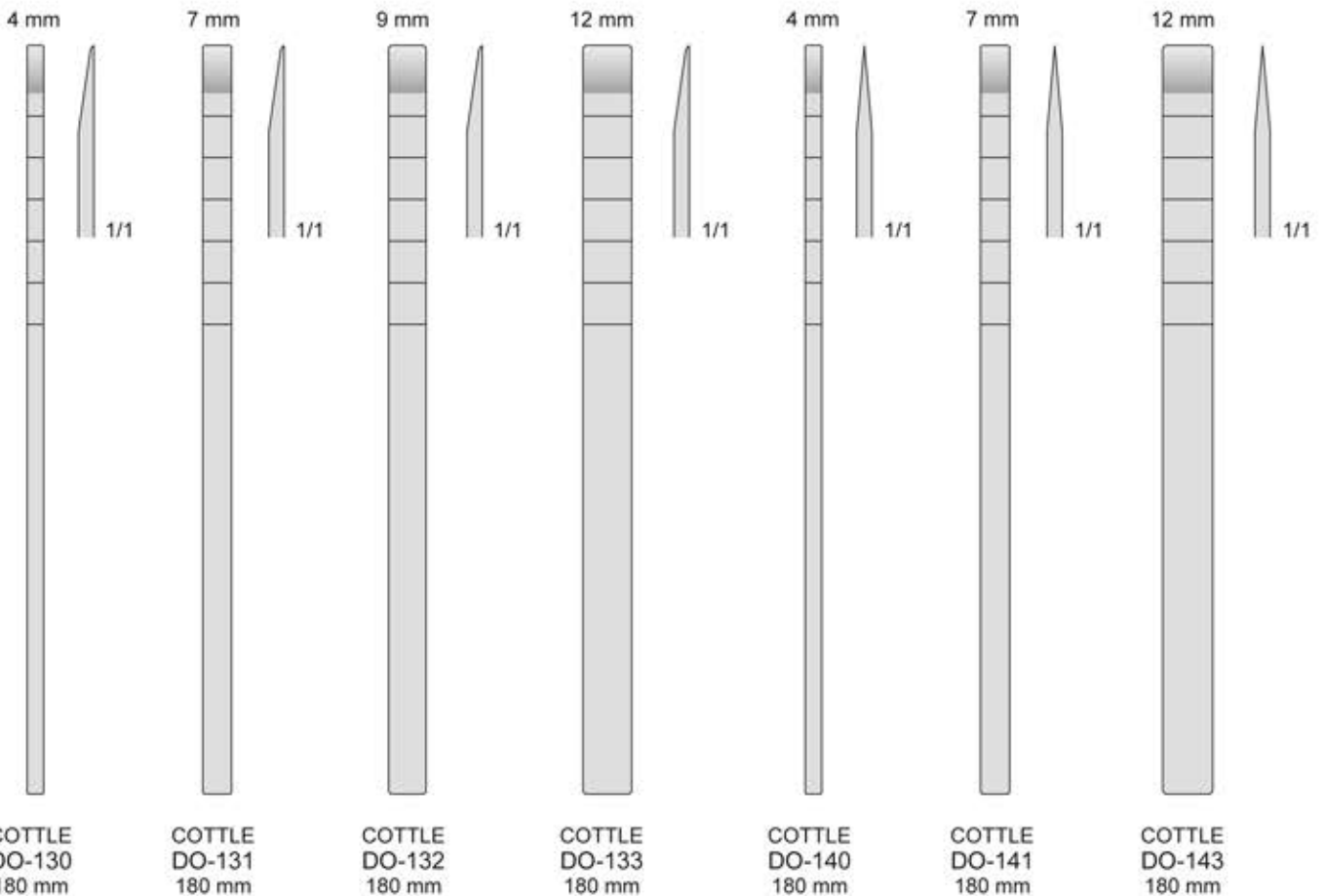

Osteotome

Osteotomes

Osteotomi

Osteótomos

Ostèotomes

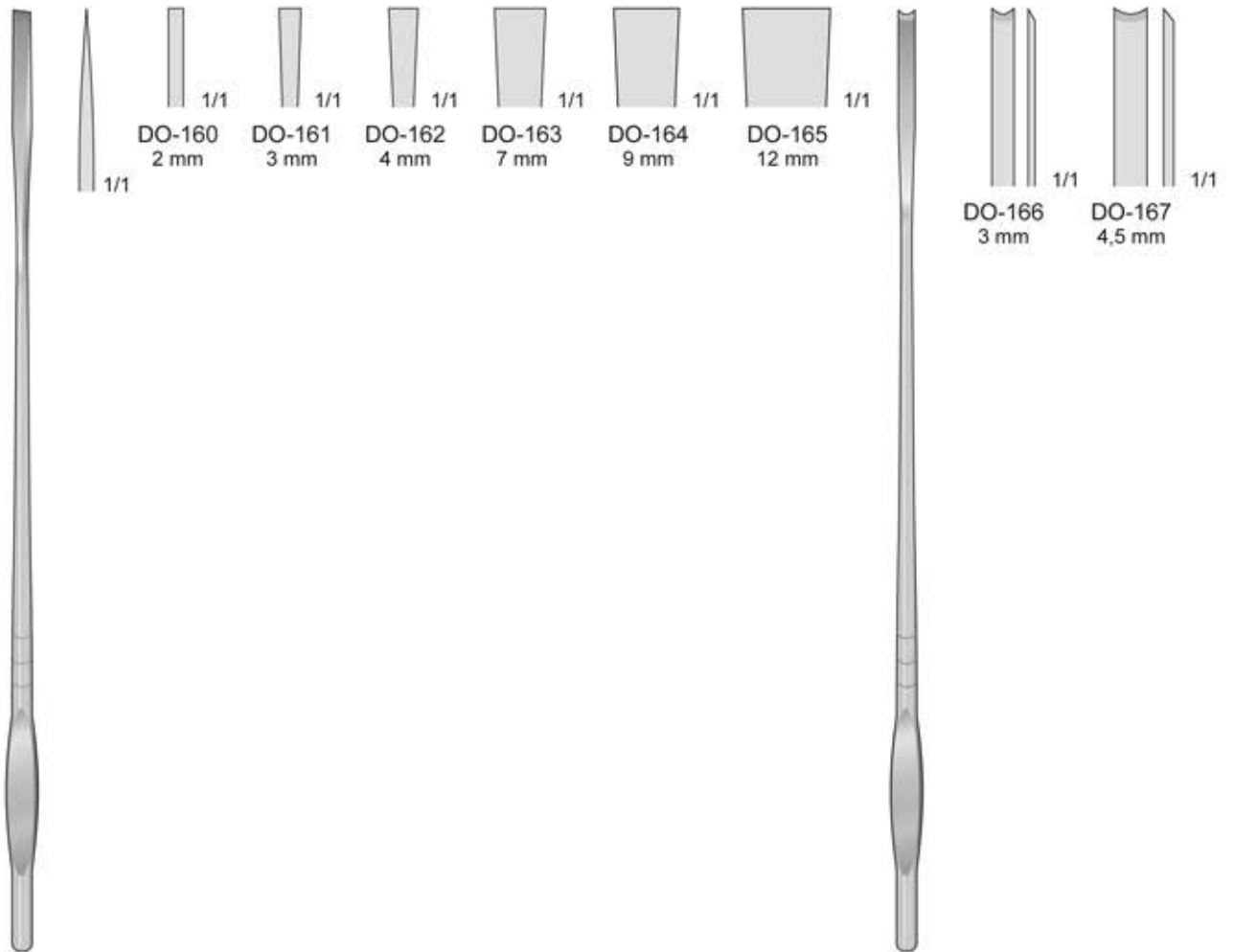

DO-160
2 mm

DO-161
3 mm

DO-162
4 mm

DO-163
7 mm

DO-164
9 mm

DO-165
12 mm

DO-166
3 mm

DO-167
4,5 mm

WALTER
DO-160/DO-165
190 mm

WALTER
DO-166/DO-167
190 mm

Rhinologie

Rhinology

Rinologia

Rinologia

Rhinologie

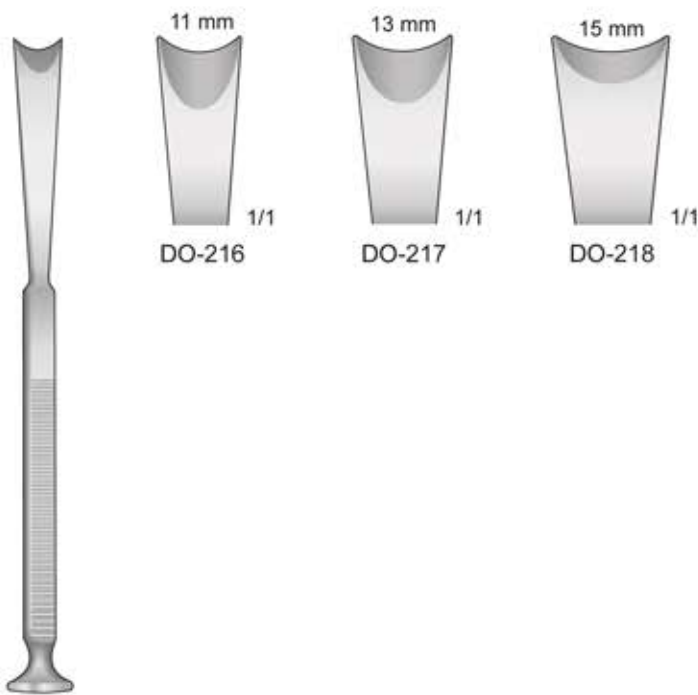

McINDOE
DO-216/DO-218
145 mm



FAULKNER
DO-173
170 mm

Meißel zur endonasalen
Kieferhöhlenöffnung
Antrum Trocar chisel
Sgorbia per l'apertura endonasale
della cavità mascellare
Cinzel para la apertura
endonasal del seno maxilar
Gouge pour l'ouverture de la cavité
endonasale pour sinus maxillaire

Gerade - Straight
Diritto - Rectas
Droites

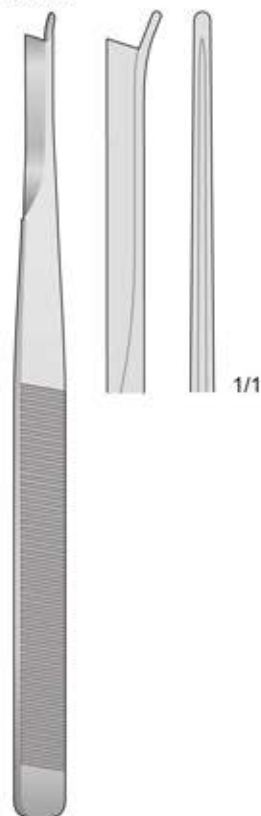

SILVER
DO-34
180 mm

Links - Left
Sinistra - Izquierda
Gauche

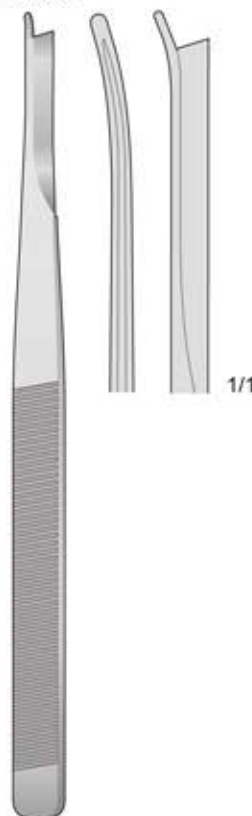

SILVER
DO-35
180 mm

Rechts - Right
Destra - Derecha
Droite

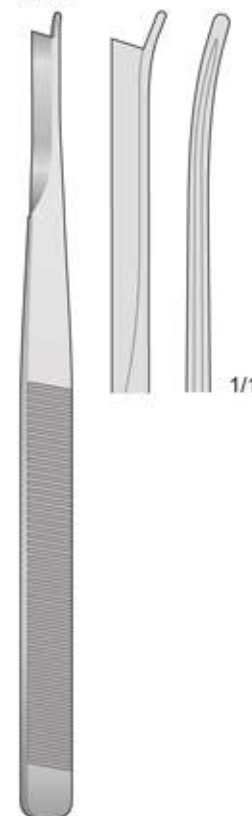

SILVER
DO-36
180 mm

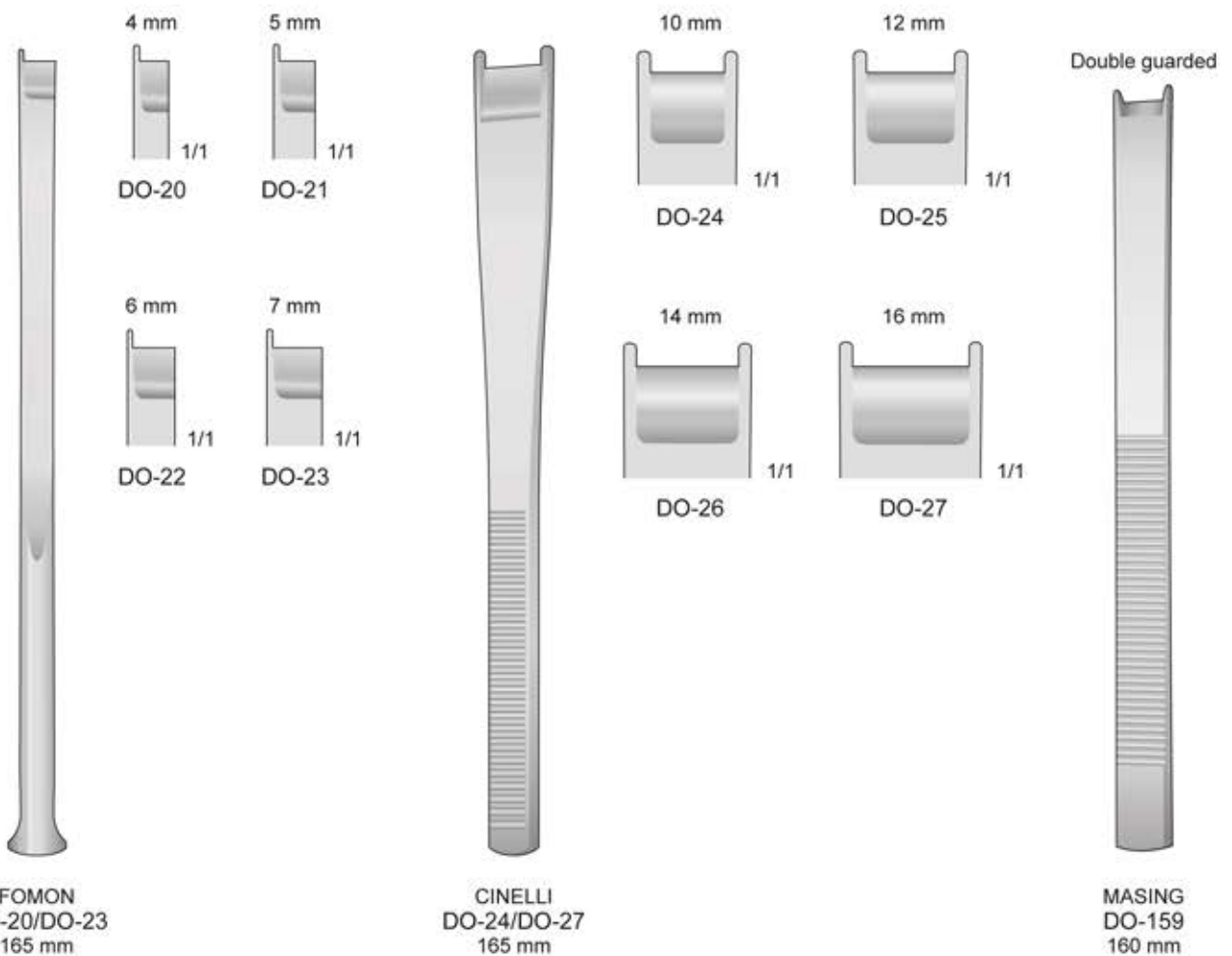

4.0 mm

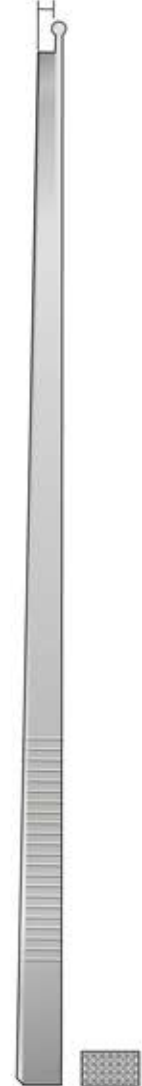

DO-118
200 mm

6.0 mm

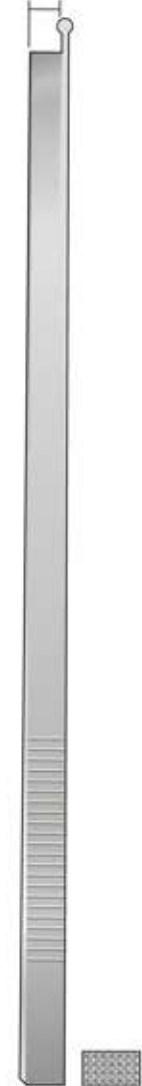

DO-119
200 mm

3.0 mm



DO-84
200 mm

6.0 mm

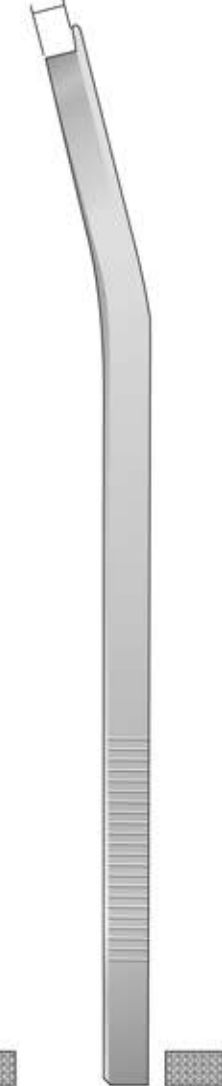

DO-85
200 mm

Osteotome, Osteotomes
Osteotomi, Osteótomos, Ostéotomes



DO-170
10 mm



DO-171
12 mm



DO-172
14 mm



RUBIN
DO-170/DO-172
180 mm

Osteotome

Osteotomes

Osteotomi

Osteótomos

Ostèotomes



DO-180 4 mm
DO-181 6 mm
DO-182 8 mm

EPKER
DO-180/DO-182
180 mm

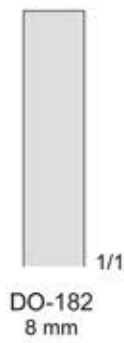
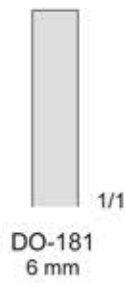
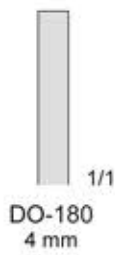

EPKER
DO-183/DO-184
180 mm

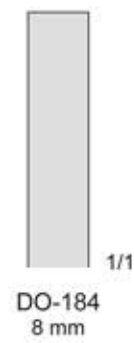
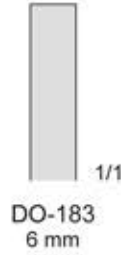

EPKER
DO-185 6 mm
180 mm

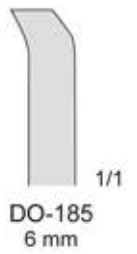

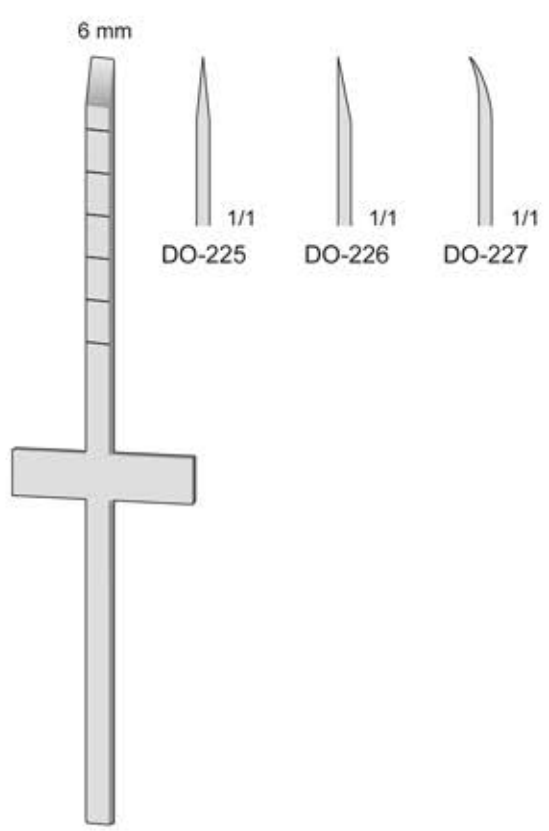

COTTLE
DO-225/DO-227
180 mm

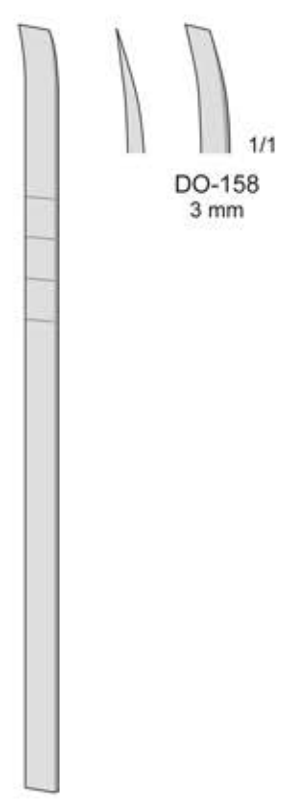

COTTLE
DO-158
180 mm

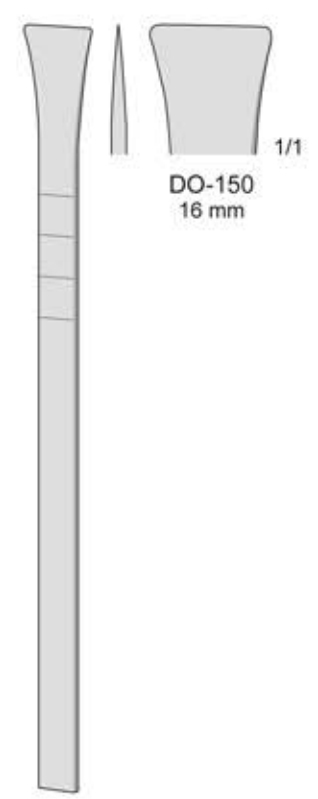

COTTLE
DO-150
180 mm

Osteotome

Osteotomes

Osteotomi

Osteótomos

Ostèotomes

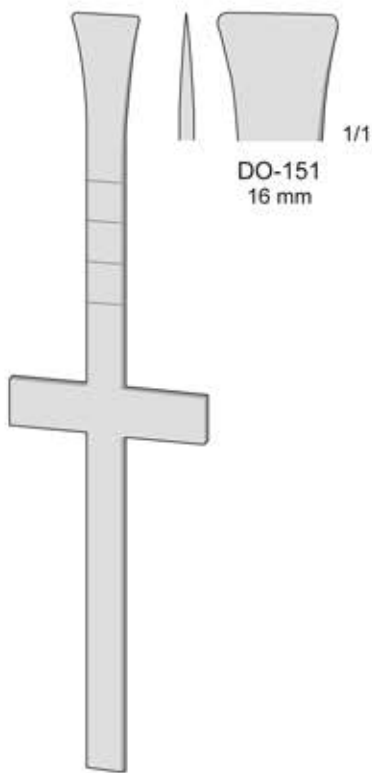

DO-151
16 mm

COTTLE
DO-151
180 mm

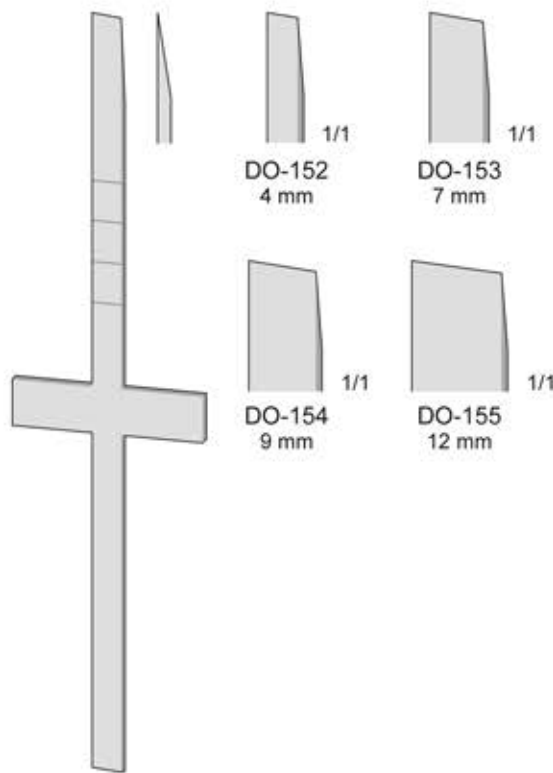

DO-152
4 mm

DO-153
7 mm

DO-154
9 mm

DO-155
12 mm

COTTLE
DO-152/DO-155
180 mm

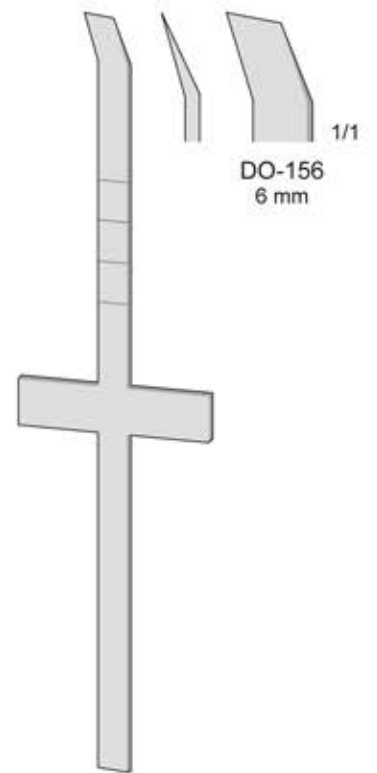

DO-156
6 mm

COTTLE
DO-156
180 mm

Schwingmesser
Swivel Knife
Coltello per setto con lama girevole
Cuchilo para el tabique nasal
Couteau pour la cloison nasale

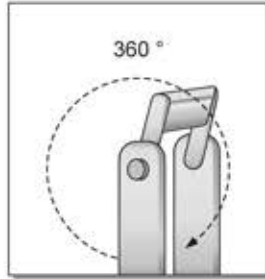

BALLENGER
DO-50/DO-52
200 mm



DO-50
3 mm



DO-51
4 mm



DO-52
5 mm



BALLENGER
DO-53/DO-55
200 mm



DO-53
3 mm



DO-54
4 mm



DO-55
5 mm

Osteotome

Osteotomes

Osteotomi

Osteótomos

Ostèotomes

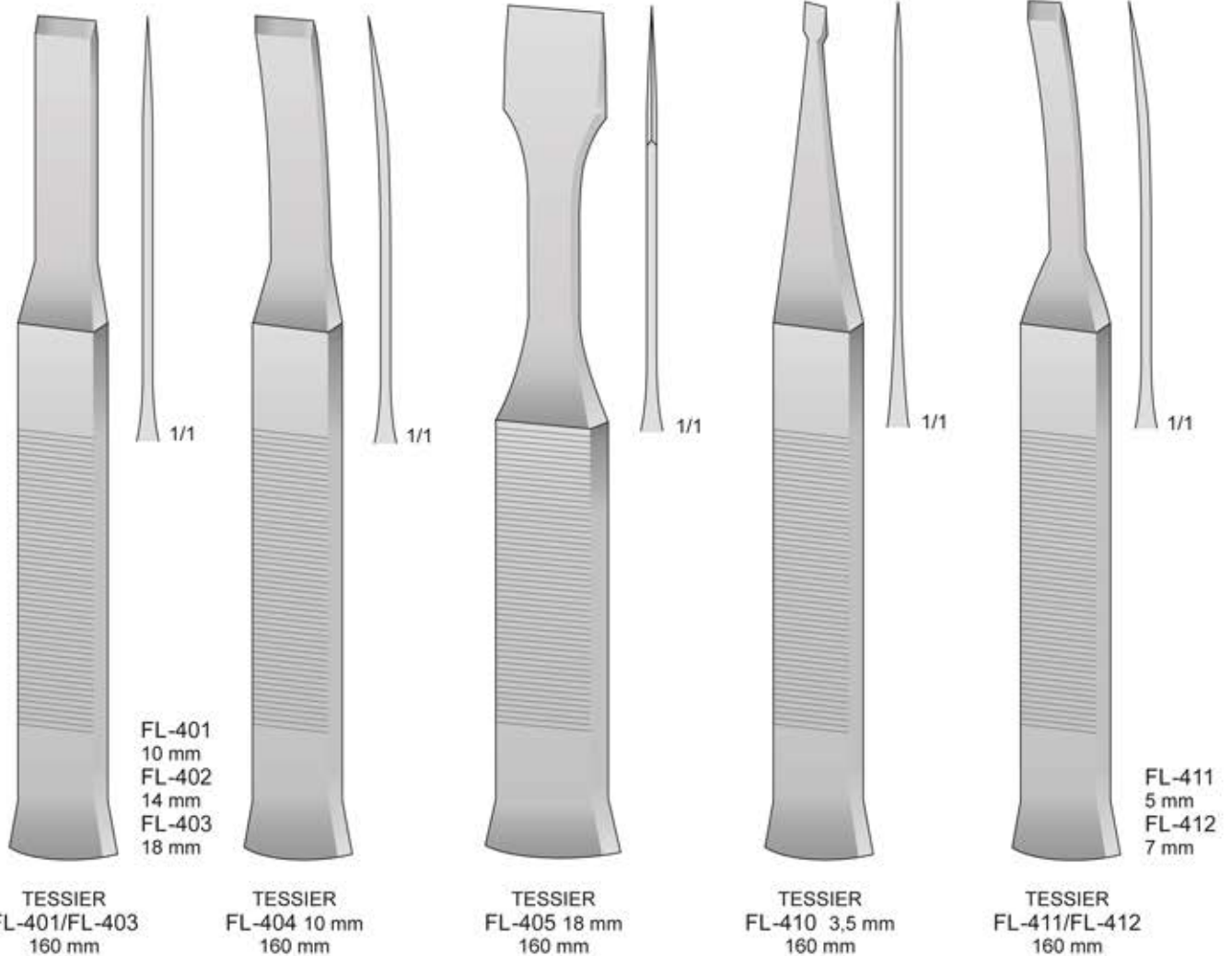



DO-190 4 mm
DO-191 6 mm
DO-192 8 mm

DO-190/DO-192
180 mm



DO-193 4 mm
DO-194 6 mm
DO-195 8 mm

DO-193/DO-195
180 mm



DO-196 6 mm
DO-197 8 mm

DO-196/DO-197
180 mm



FL-307 10 mm
FL-308 15 mm
FL-309 20 mm
FL-310 30 mm

TESSIER
FL-307/FL-310
200 mm

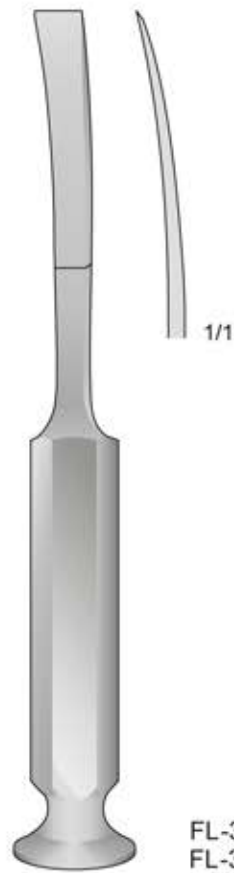

FL-311 10 mm
FL-312 15 mm

TESSIER
FL-311/FL-312
200 mm



SCHNEIDER-SAUERBRUCH
FK-259
190 mm

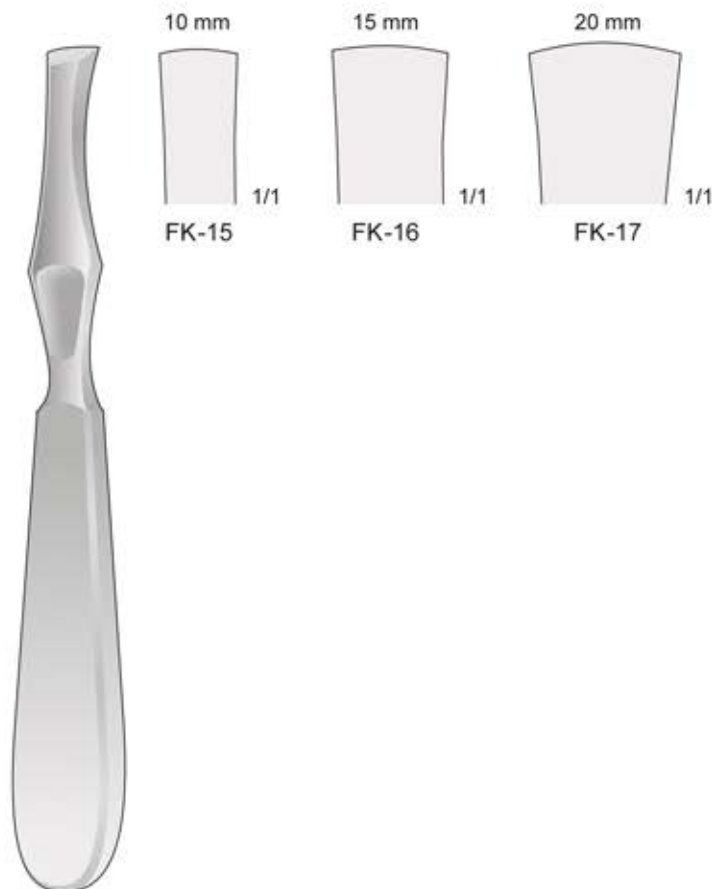

LAMBOTTE
FK-15/FK-17
205 mm

Mit Ferrozellgriff
With Ferrozell handle
Con manico Ferrozell
Con mango de Ferrozell
Avec poignée en Ferrozell



FK-234
180 mm



FK-230
190 mm



FK-232
190 mm

Mit Ferrozellgriff
With Ferrozell handle
Con manico Ferrozell
Con mango de Ferrozell
Avec poignée en Ferrozell

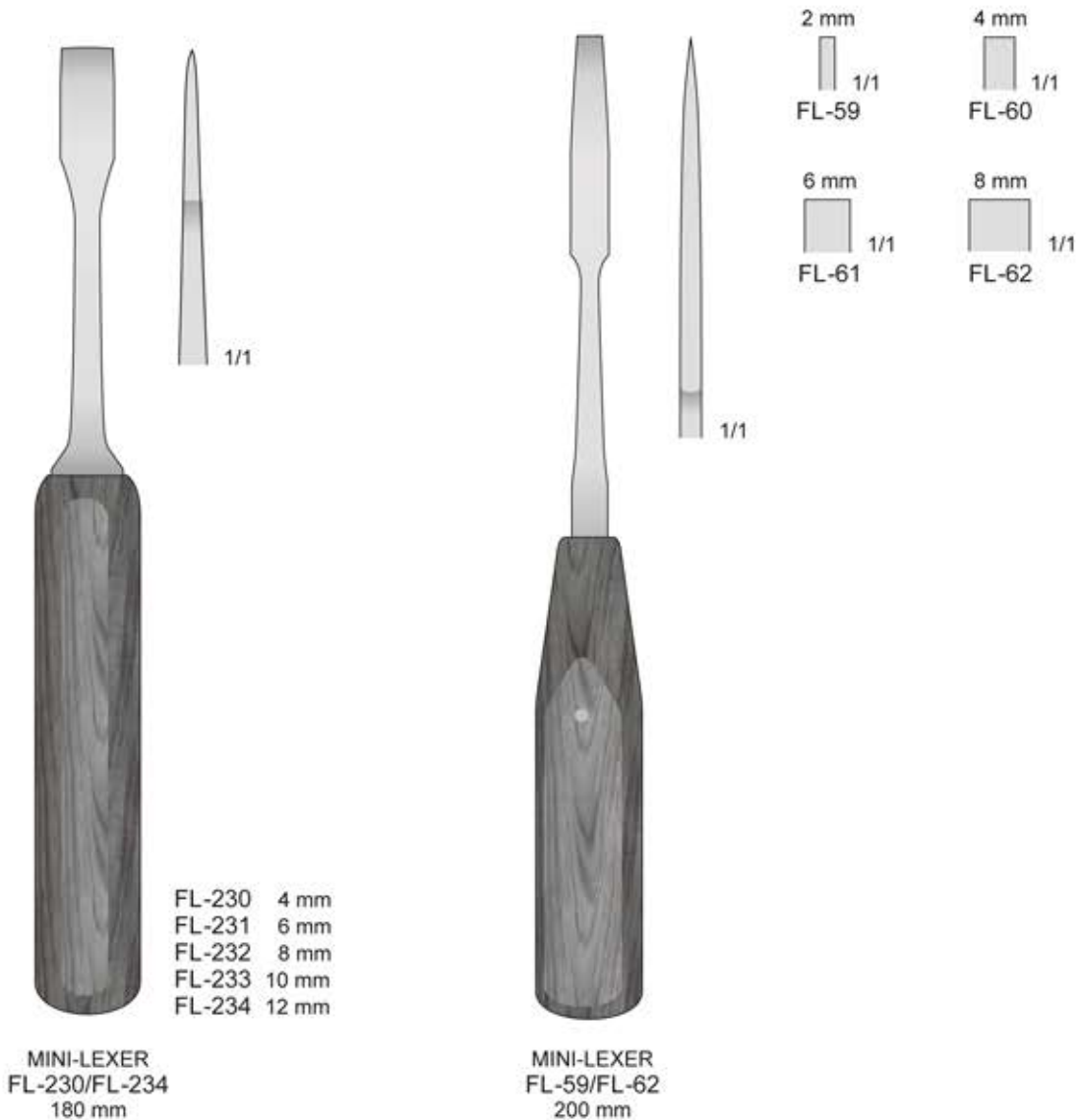

Mit Ferrozellgriff
 With Ferrozell handle
 Con manico Ferrozell
 Con mango de Ferrozell
 Avec poignée en Ferrozell

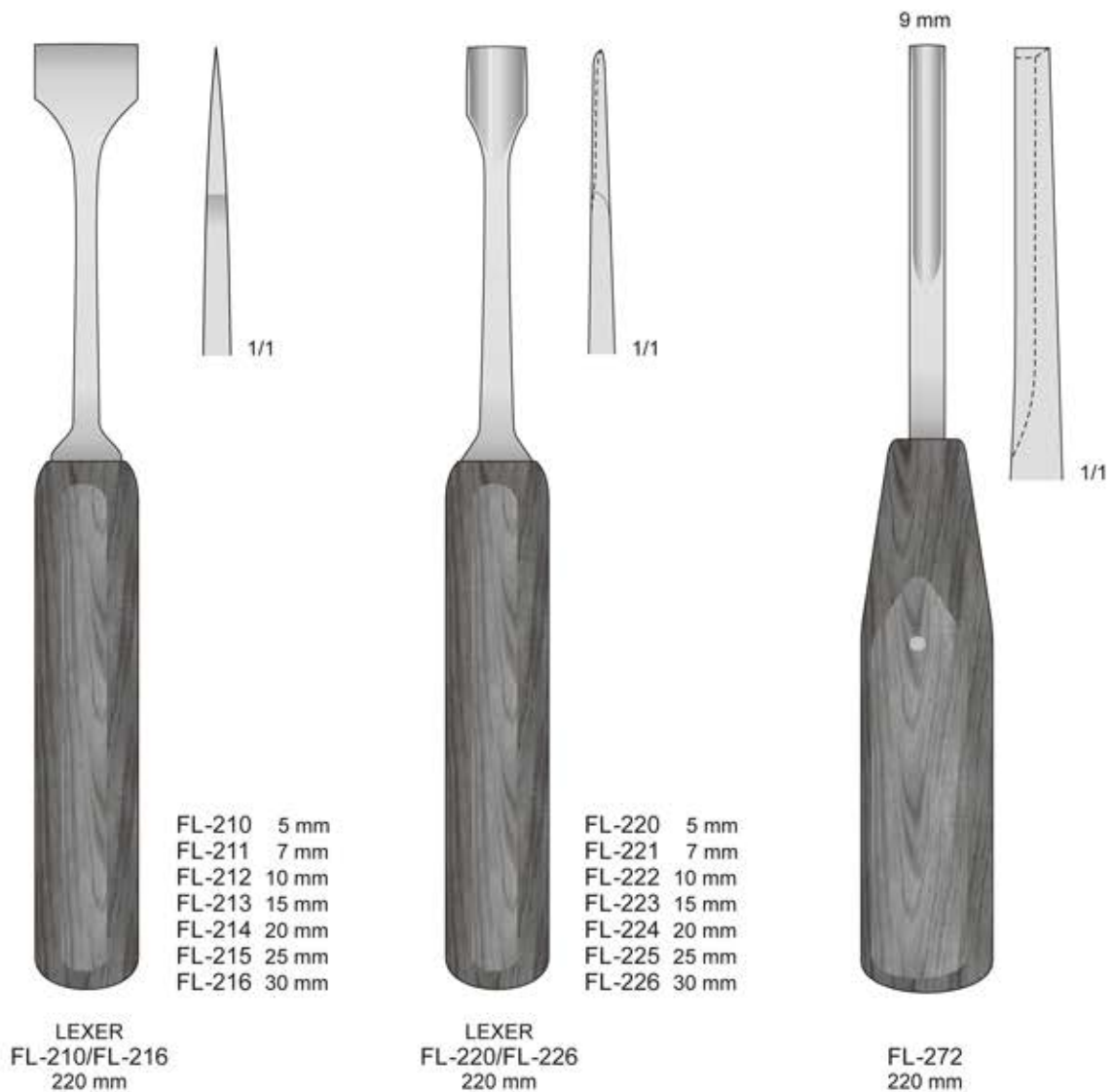

Mit Ferrozellgriff
With Ferrozell handle
Con manico Ferrozell
Con mango de Ferrozell
Avec poignée en Ferrozell



FL-280/FL-281
200 mm

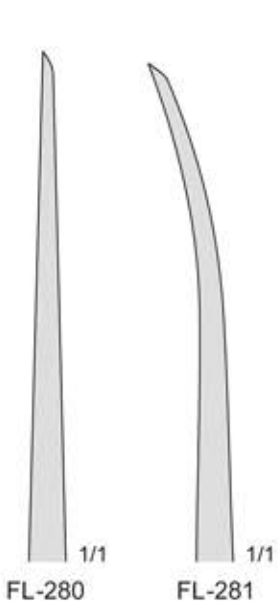

FL-282/FL-283
200 mm

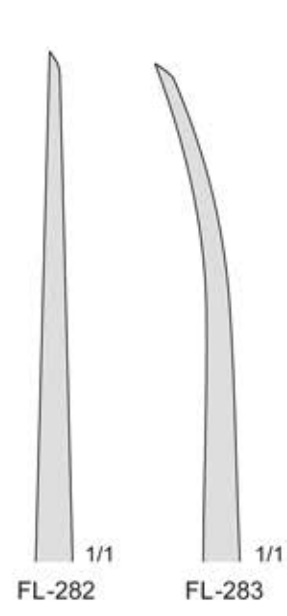

Osteotome

Osteotomes

Osteotomi

Osteótomos

Ostéotomes

Mit Ferrozellgriff
 With Ferrozell handle
 Con manico Ferrozell
 Con mango de Ferrozell
 Avec poignée en Ferrozell

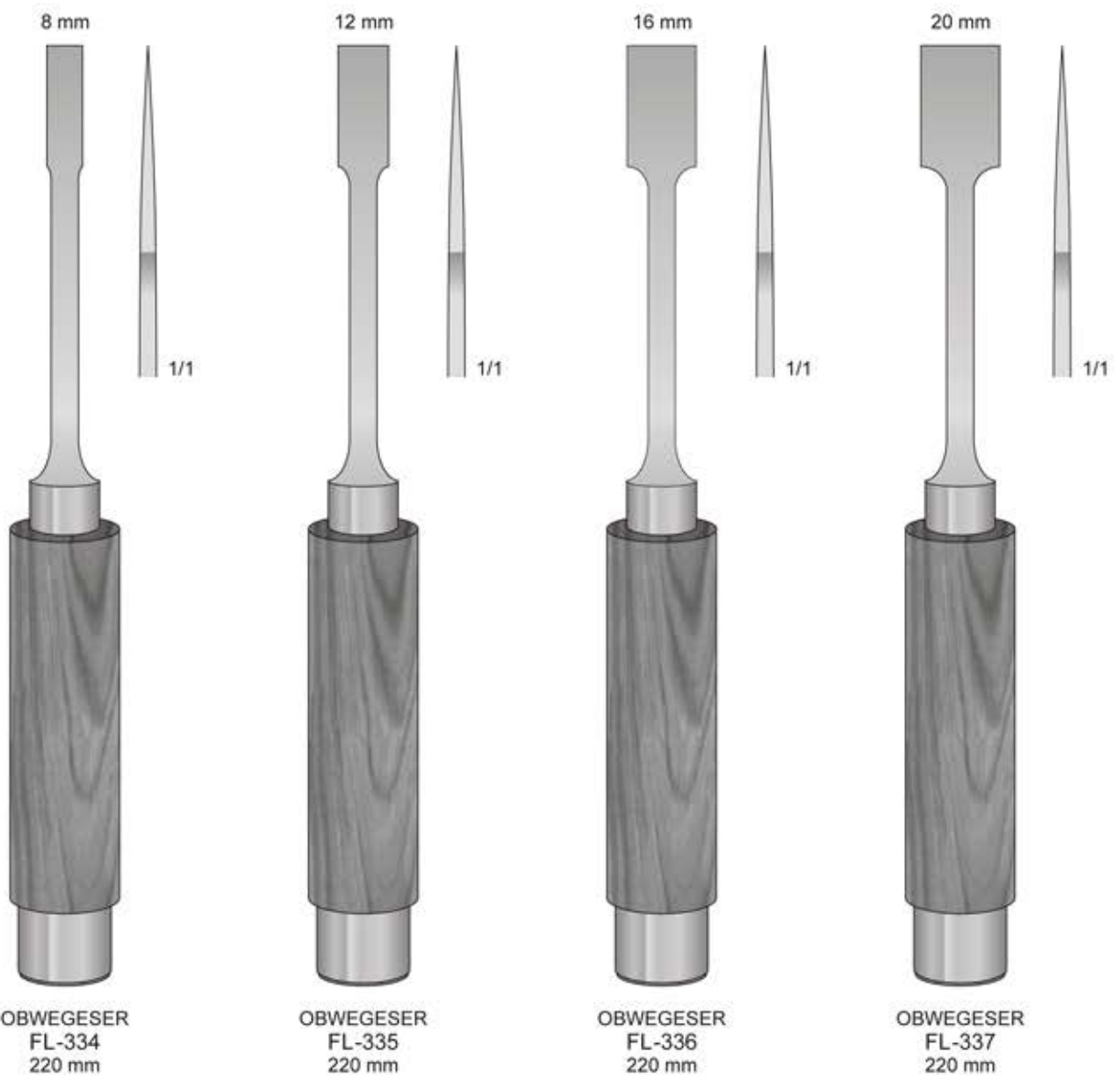

Ø 25 mm - 200 g



FL-11R

Paar Ersatzbacken
 Pair of spare faces
 Coppia di teste
 di ricambio
 Pareja de tapas
 intercambiables
 Paire de faces
 de rechange

MEAD
 FL-11
 200 mm

Ø 20 mm - 160 g

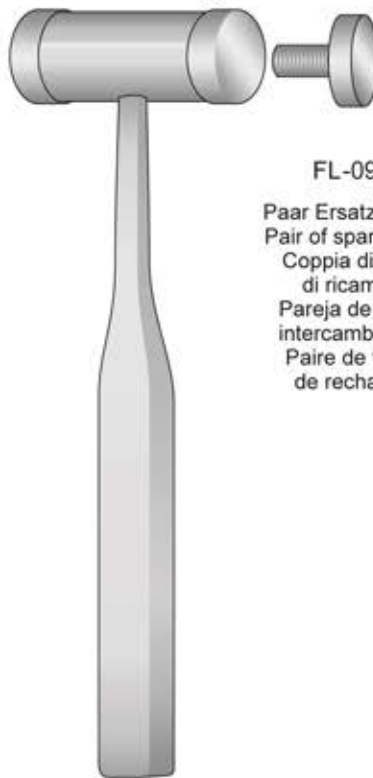

FL-09R

Paar Ersatzbacken
 Pair of spare faces
 Coppia di teste
 di ricambio
 Pareja de tapas
 intercambiables
 Paire de faces
 de rechange

MEAD
 FL-09
 190 mm

Ø 26 mm - 320 g

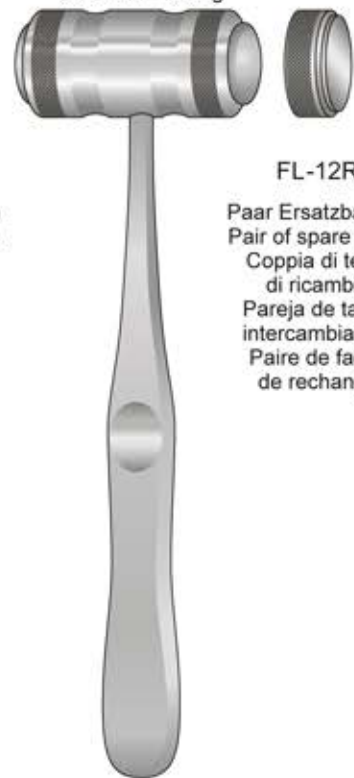

FL-12R

Paar Ersatzbacken
 Pair of spare faces
 Coppia di teste
 di ricambio
 Pareja de tapas
 intercambiables
 Paire de faces
 de rechange

MEAD
 FL-12
 190 mm

Ø 20 mm - 140 g

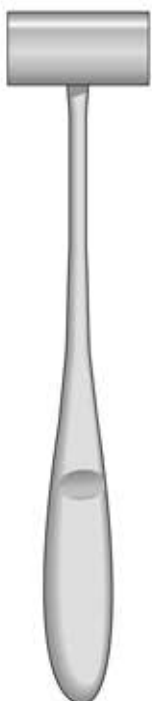

FL-01
 165 mm

Ø 25 mm - 300 g

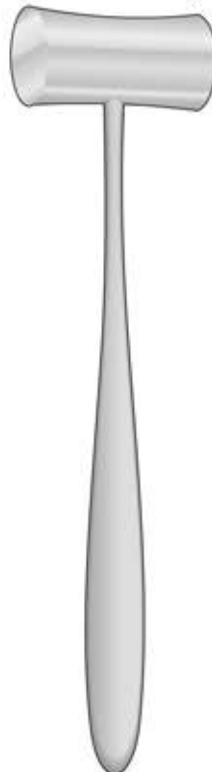

**LUCAE
 FL-10M**
 190 mm

Ø 20 mm - 240 g

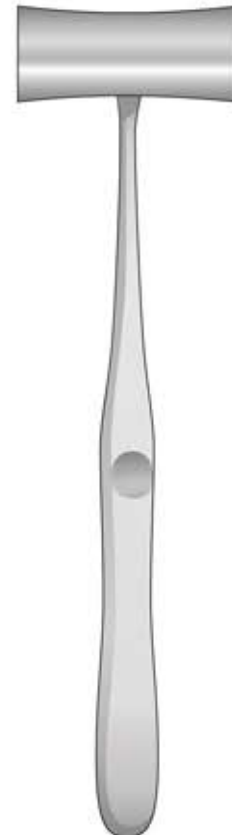

**WILLIGER
 FL-02**
 240 mm

1 Seite flach - 1 Seite convex
 1 Side flat - 1 Side convex
 1 Lato piatto - 1 Lato convesso
 1 Parte plana - 1 Parte convexa
 1 Face plate - 1 Face convexe

Ø 30 mm - 240 g



COTTLE
FL-104
 185 mm

Ø 30 mm - 300 g



BERGMANN
FL-105
 235 mm

Ø 40 mm - 550 g



OMBREDANNE
FL-108
 240 mm



9

Nasenraspeln, Kuretten
Nasal Raspatories, Curettes
Raspe nasali, Cucchiari
Raspadores nasales, Cucharillas
Rugines nasales, Curettes

Knochenfeilen

Bone files

Lime per osso

Limas para huesos

Limes à os



HOWARD
DO-1
180 mm

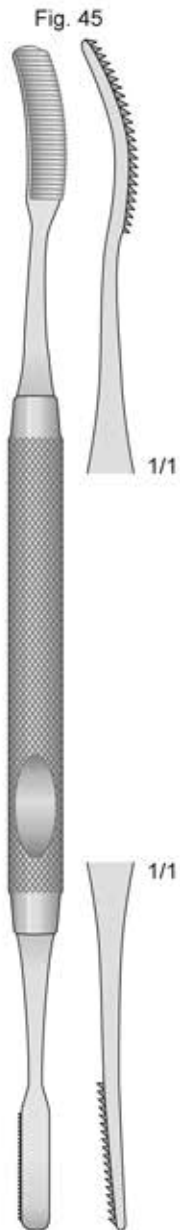

MILLER
DO-2
185 mm

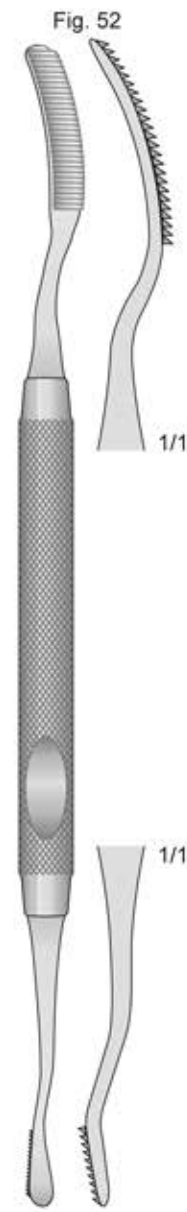

MILLER
DO-3
180 mm

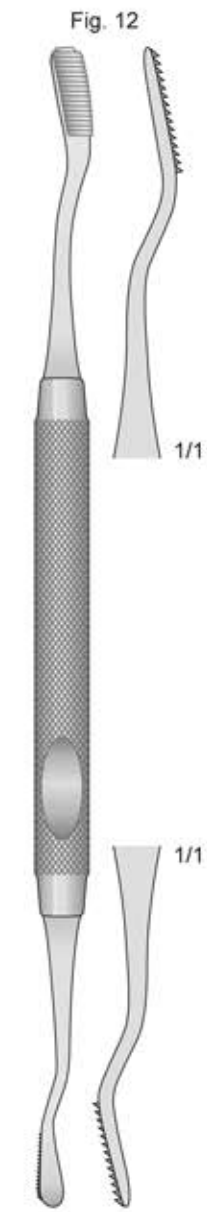

HOWARD
DO-4
170 mm

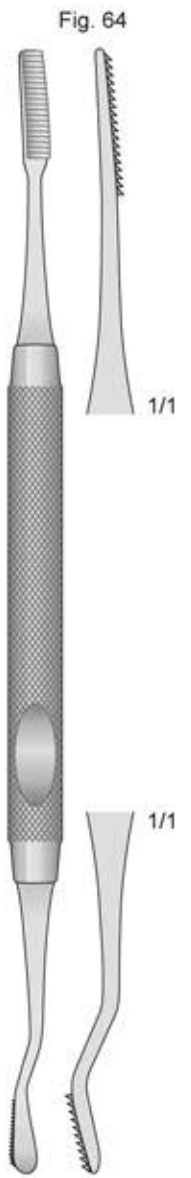

MILLER
DO-5
175 mm

Nasenraspeln - Nasal Rasps
Raspe nasali - Raspadores nasales
Râpes nasales



CONVERSE
FK-174
180 mm

8 mm



8 mm
FK-96
210 mm

2 mm



5 mm
FK-97
210 mm



1/1



1/1

8 mm



8 mm
FK-98
210 mm

8 mm



8 mm
FK-99
210 mm

Knochenfeilen

Bone files

Lime per osso

Limas para huesos

Limes à os

Nasenfeilen
Nasal File
Lima nasale
Lima nasales
Lime nasales

Nasenraspel
Nasal Rasp
Raspa nasale
Raspador nasal
Râpe nasale

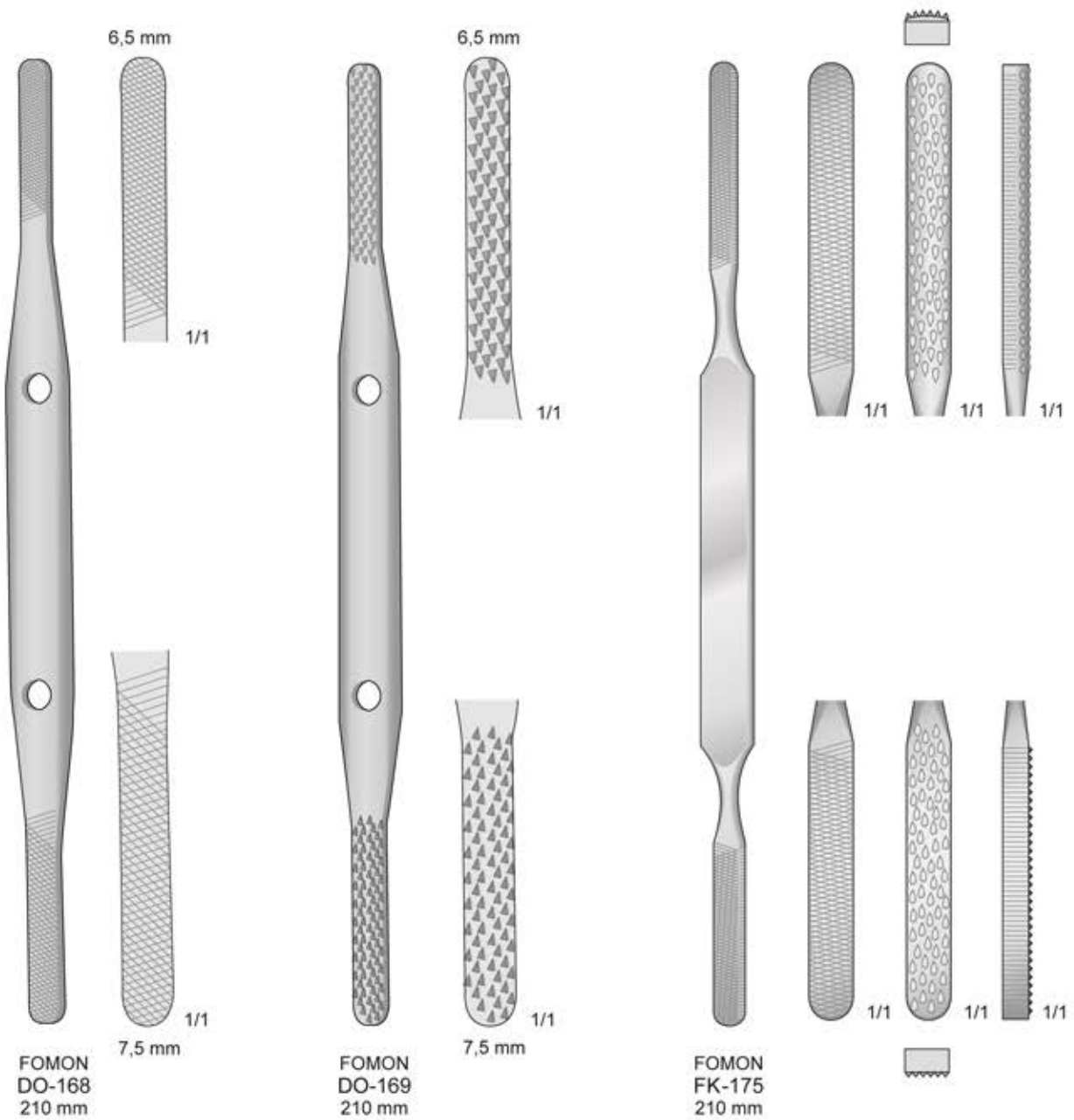

Knochenfeilen

Bone files

Lime per osso

Limas para huesos

Limes à os

Knorpelschaber
Cartilage abraders
Raschiatore per cartilagine
Rascador de cartilago
Grattoir à cartilages



DINGMANN
DO-245
160 mm
1-L



DINGMANN
DO-246
160 mm
2-R



JOSEPH
FK-193
160 mm



FK-193
160 mm

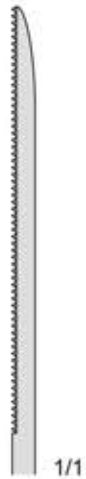

1/1

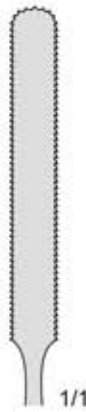

1/1



GALLAHER
FK-194/FK-196
160 mm



FK-194
160 mm



FK-195
160 mm

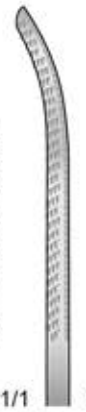

1/1



FK-196
160 mm



1/1

Glabellaraspeln - Nasenraspeln
 Glabella Rasps - Nasal Rasps
 Raspe per glabella - Raspe nasali
 Escofinas para glabella - Raspadores nasales
 Râpes pour la glabelle - Râpes nasales

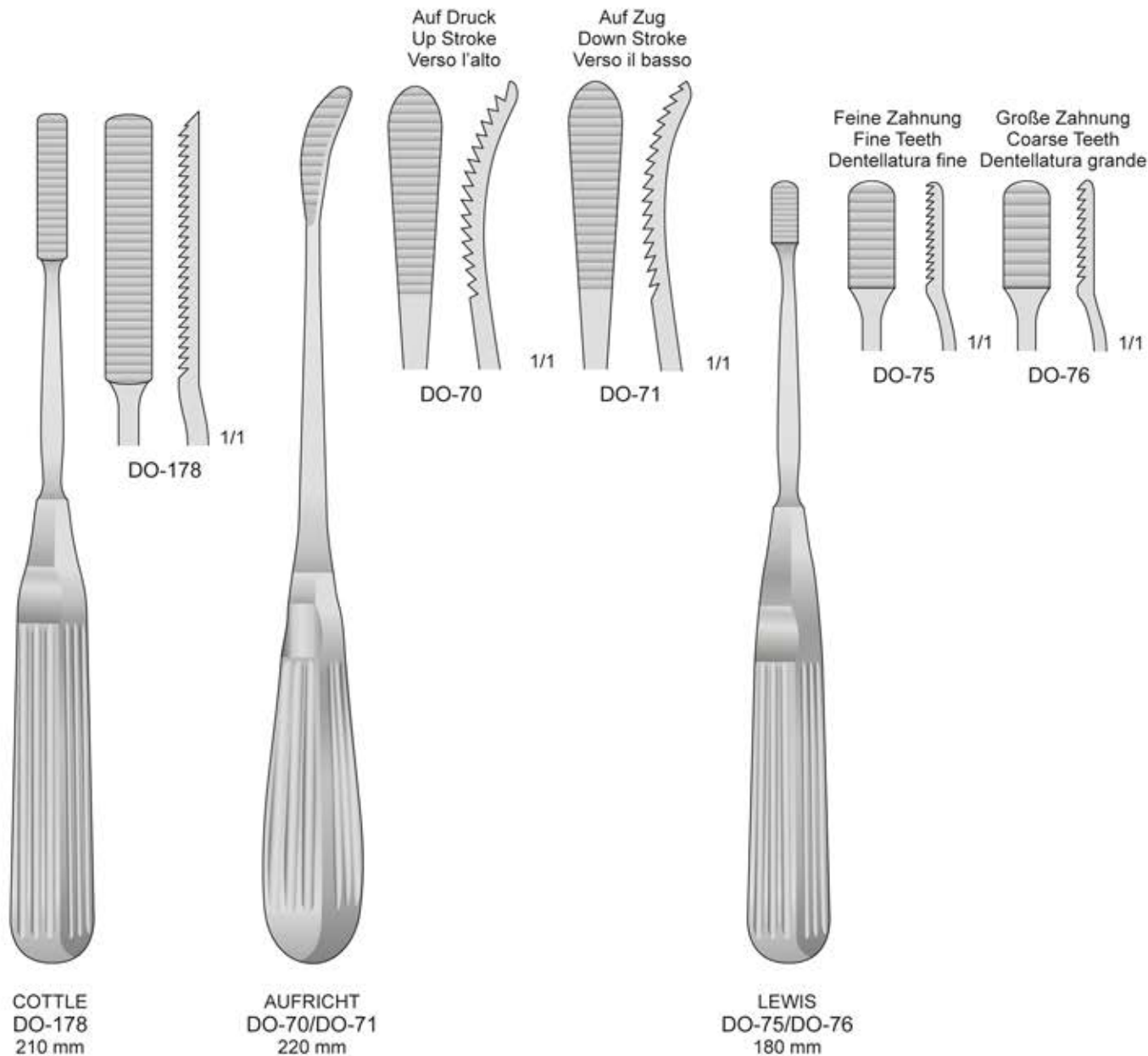

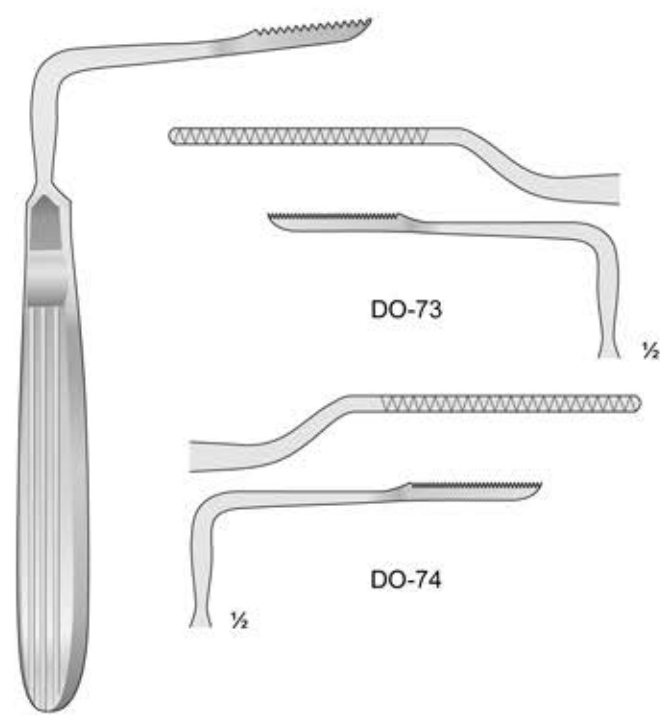

JOSEPH
DO-73/DO-74
135 mm

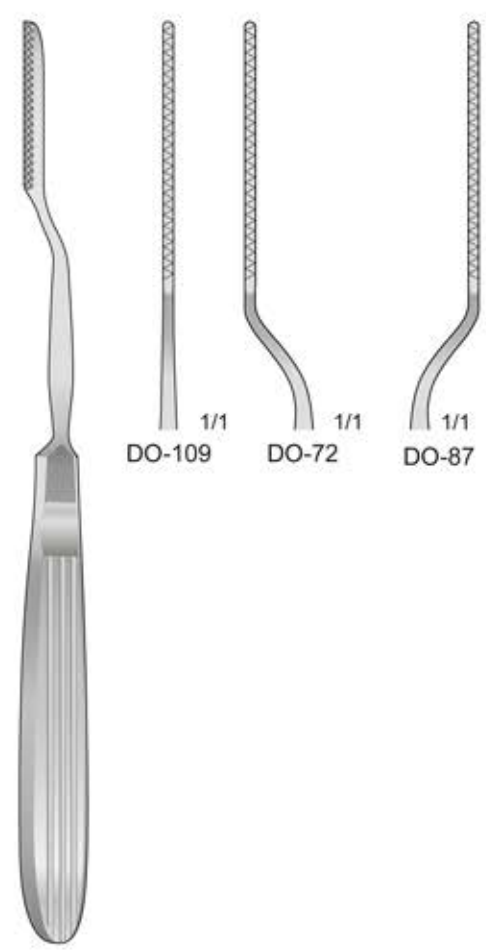

JOSEPH
DO-72/DO-109
190 mm



DO-189
195 mm

Knochenfeilen

Bone files

Lime per osso

Limas para huesos

Limes à os

Nasenraspeln - Nasal Rasps
 Raspe nasali - Escofinas nasales
 Râpes nasales

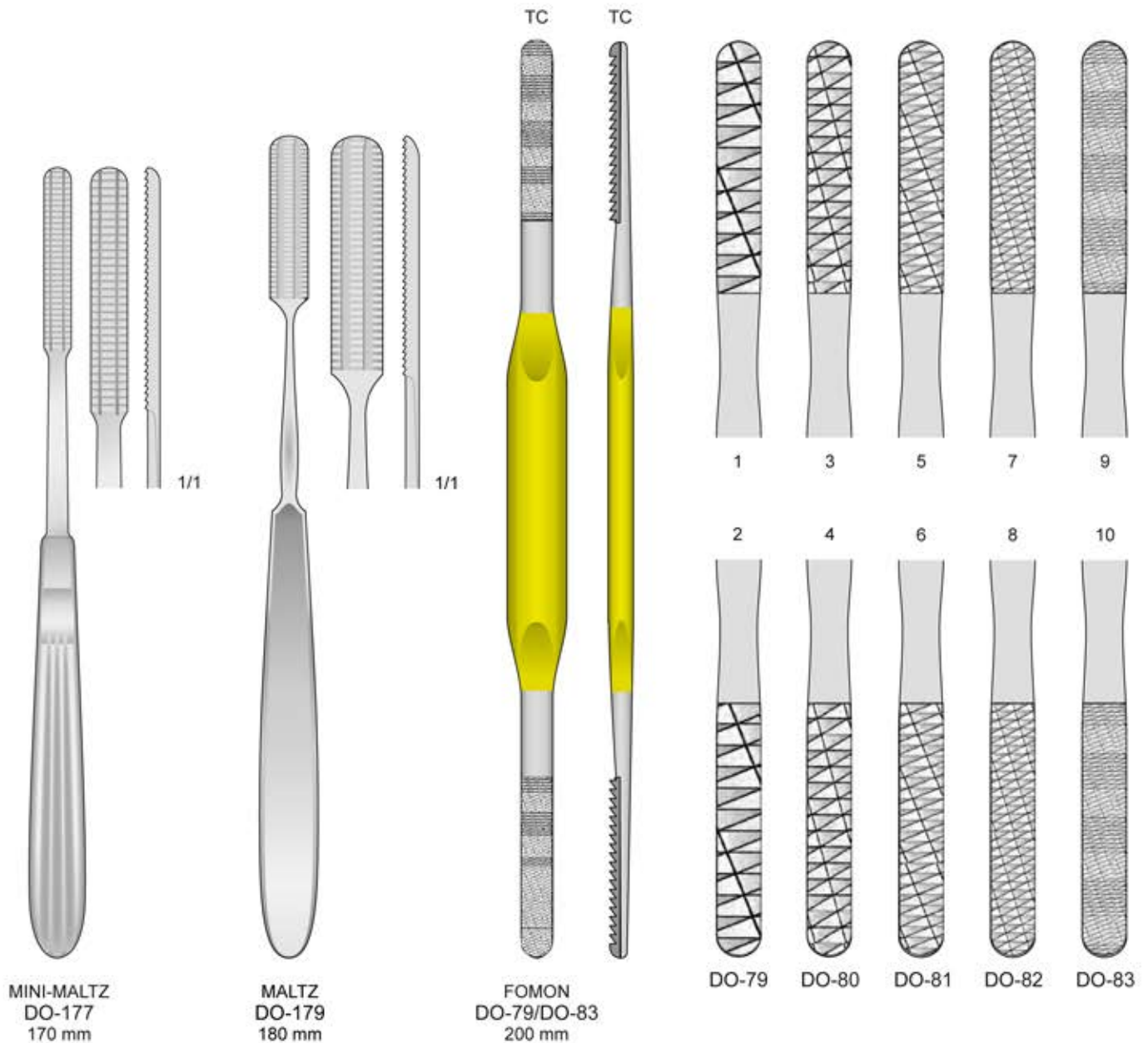

Glabellaraspeln - Nasenraspeln
 Glabella Rasps - Nasal Rasps
 Raspe per glabella - Raspe nasali
 Escofinas para glabella - Raspadores nasales
 Râpes pour la glabelle - Râpes nasales

Mit hartmetalleinsätzen - Tungsten-carbide inserts
 Con inserti al carburo di tungsteno - Escofinas con tungsteno
 Avec plaquettes en carbure de tungstène



DO-312
210 mm

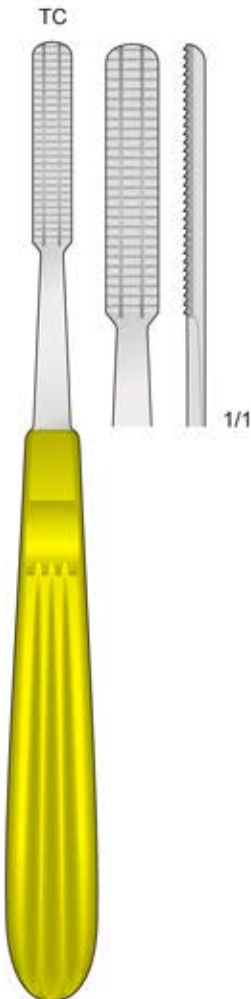

MALTZ
DO-315
170 mm



MALTZ
DO-301/DO-305
195 mm

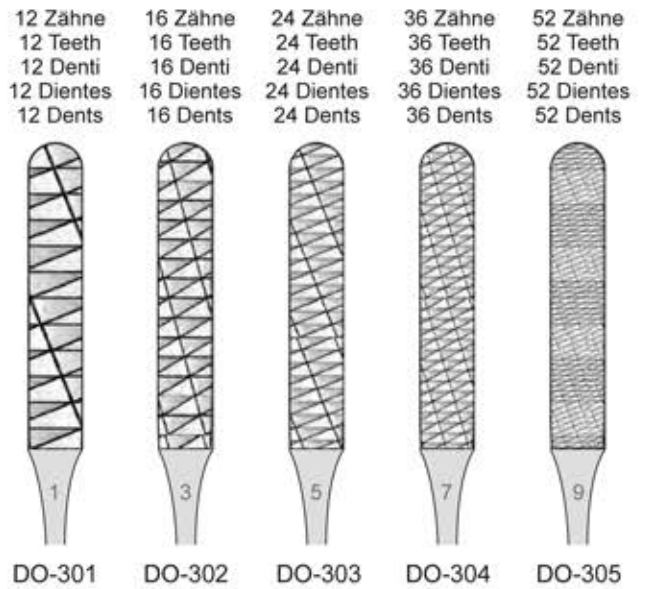

Scharfe Küretten

Sharp curettes

Curette, Cucchiai
taglianti

Cucharillas cortantes

Curettes tranchantes



MARTINI
FK-70
140 mm



WILLIGER
FK-71
145 mm



JACOBSON
FK-75
140 mm



MARTINI
FK-76
140 mm



JANSEN
FK-77
160 mm

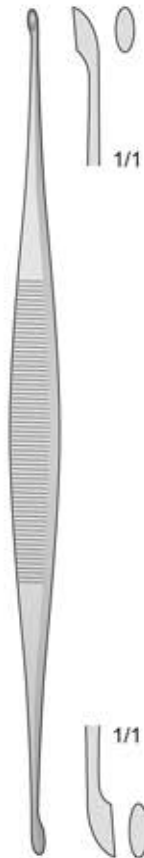

BARTH
FK-78
180 mm

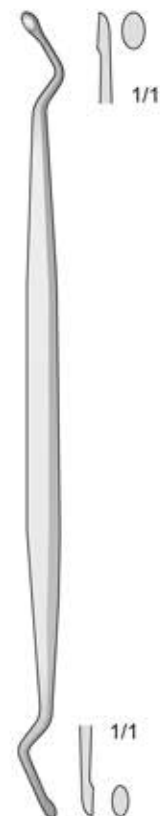

FK-83
160 mm

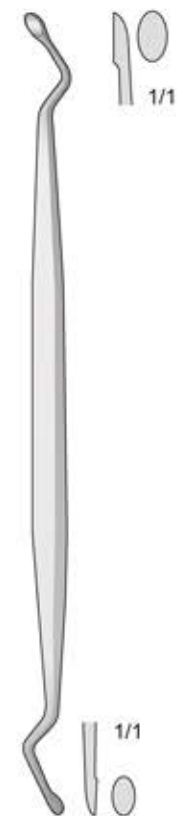

JANSEN
FK-84
160 mm

Scharfe Küretten

Sharp currettes

Curette, Cucchiai
taglienti

Cucharillas cortantes

Curettes tranchantes

Komedonen Instrumente
Comedone Extractors
Schiacciacomedoni
Extractores para comedones
Tire comédons

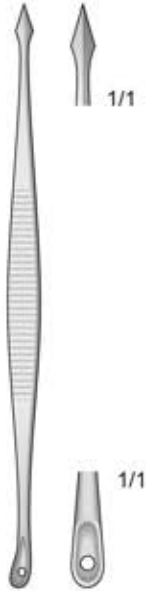

SAALFELD
DS-26
100 mm

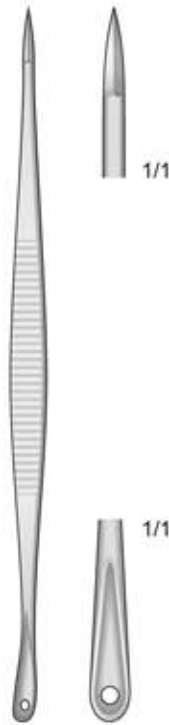

SAALFELD
DS-27
140 mm

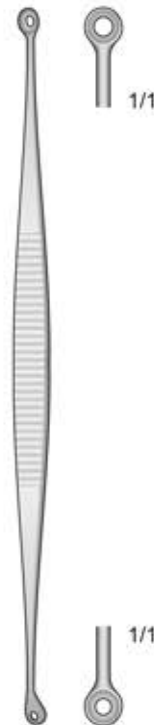

UNNA
DS-28
140 mm

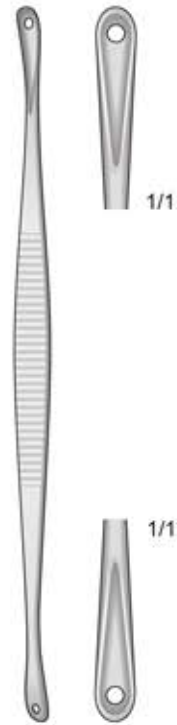

UNNA
DS-29
140 mm

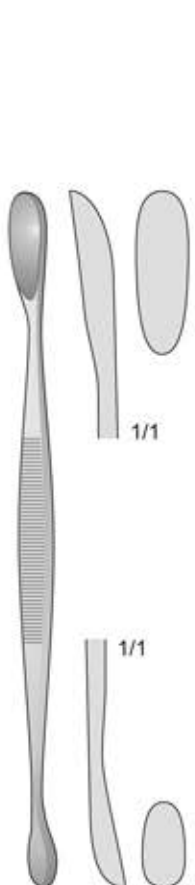

VOLKMANN
FK-79
130 mm

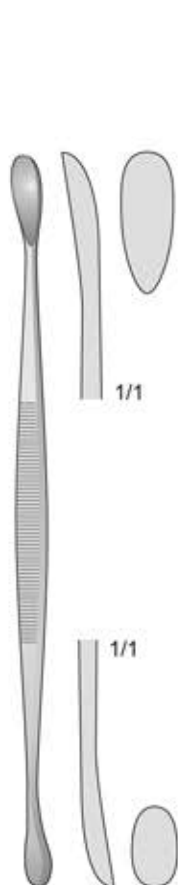

VOLKMANN
FK-72
145 mm

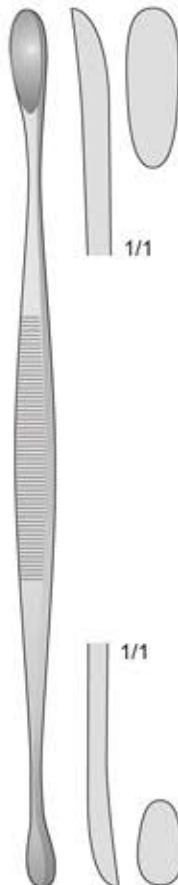

VOLKMANN
FK-73
170 mm

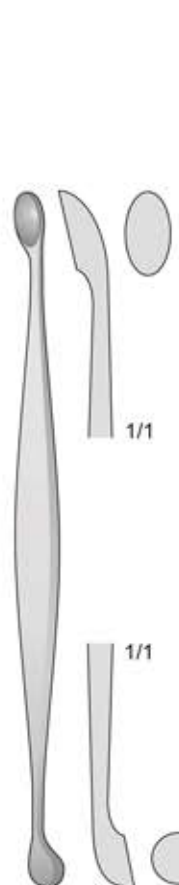

FK-177
130 mm

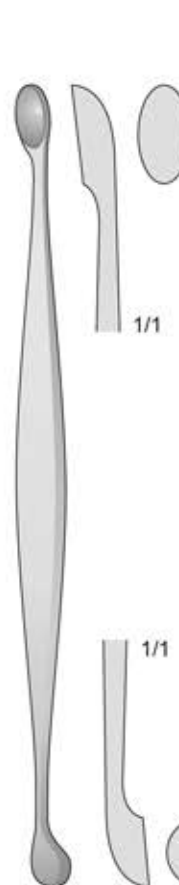

FK-74
160 mm

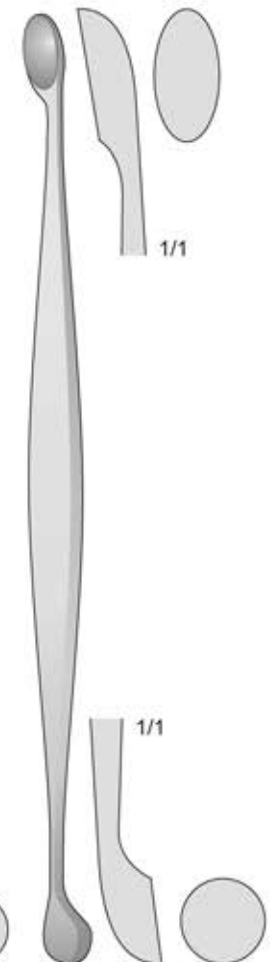

FK-178
200 mm

Scharfe Küretten

Sharp currettes

Curette, Cucchiai
taglianti

Cucharillas cortantes

Curettes tranchantes

Hautstanzen - Dermal punches Offset
Punche da biopsia - Trépanos cutáneos - Trépanos cutanés



FL-150
3 mm

FL-151
4 mm

FL-152
5 mm

FL-153
6 mm

FL-154
8 mm

KEYES
FL-150/FL-154
100 mm



FL-155
3 mm

FL-156
4 mm

FL-157
5 mm

FL-158
6 mm

FL-159
8 mm

KEYES
FL-155/FL-159
90 mm

Lupus Küretten - Lupus Currettes
Curette per Lupus - Curetas para Lupus
Curettes pour les Lupus



FK-136
FK-137
1/1

FK-138
FK-139
1/1

KERPEL
FK-136
FK-138
145 mm



KERPEL
FK-137
FK-139
145 mm

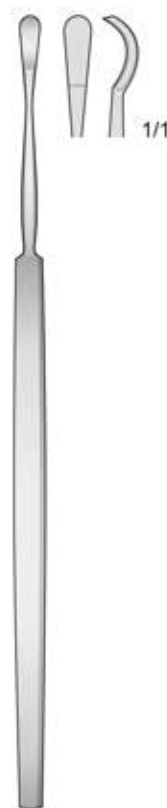

VIDAL
DS-25
140 mm



FOX
DS-30/DS-33
140 mm

3 mm 4 mm 5 mm 6 mm
DS-30 DS-31 DS-32 DS-33
1/1 1/1 1/1 1/1



BRUNS
FK-110/FK-116
165 mm

Fig.000 3 mm	Fig.00 4 mm	Fig.0 5 mm
FK-110	FK-111	FK-112
Fig.1 6 mm		Fig.2 8 mm
FK-113		FK-114
Fig.3 10 mm		Fig.4 12 mm
FK-115		FK-116



SCHEDE
FK-120/FK-126
170 mm

Fig.000 2,5 mm	Fig.00 3,4 mm	Fig.0 4,2 mm
FK-120	FK-121	FK-122
Fig.1 5,2 mm		Fig.2 6,3 mm
FK-123		FK-124
Fig.3 7,4 mm		Fig.4 8 mm
FK-125		FK-126

Scharfe Küretten

Sharp curettes

Curette, Cucchiari
taglianti

Cucharillas cortantes

Curettes tranchantes



VOLKMANN
FK-60/FK-69
170 mm

Fig.0000
2,8 mm
1/1
FK-60

Fig.2
8,5 mm
1/1
FK-65

Fig.000
3,6 mm
1/1
FK-61

Fig.3
10 mm
1/1
FK-66

Fig.00
4,4 mm
1/1
FK-62

Fig.4
11,5 mm
1/1
FK-67

Fig.0
5,2 mm
1/1
FK-63

Fig.5
13 mm
1/1
FK-68

Fig.1
6,8 mm
1/1
FK-64

Fig.6
14,5 mm
1/1
FK-69

Fig. 00
3,4 mm
1/1
FK-197

Fig. 1
5,2 mm
1/1
FK-198



WILLIGER
FK-197/FK-198
170 mm

Marker
Tissue Markers
Marcatore

Semi-Biegsam - Semi-Malleables
Semi-Malleabili - Semi-Maleables
Semi-Malléables

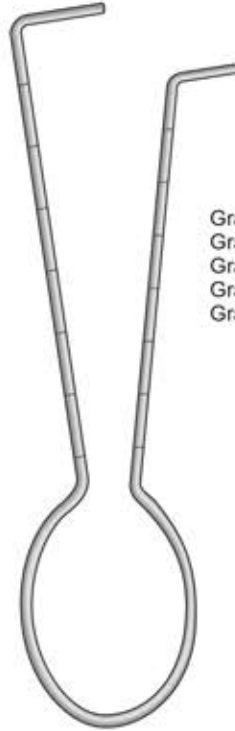

Graduiert cm
Graduated cm
Graduati in cm
Graduadas en cm
Graduée en cm

- ES-14 38 mm
- ES-15 42 mm
- ES-16 45 mm

Areola-Marker
Marca Areola

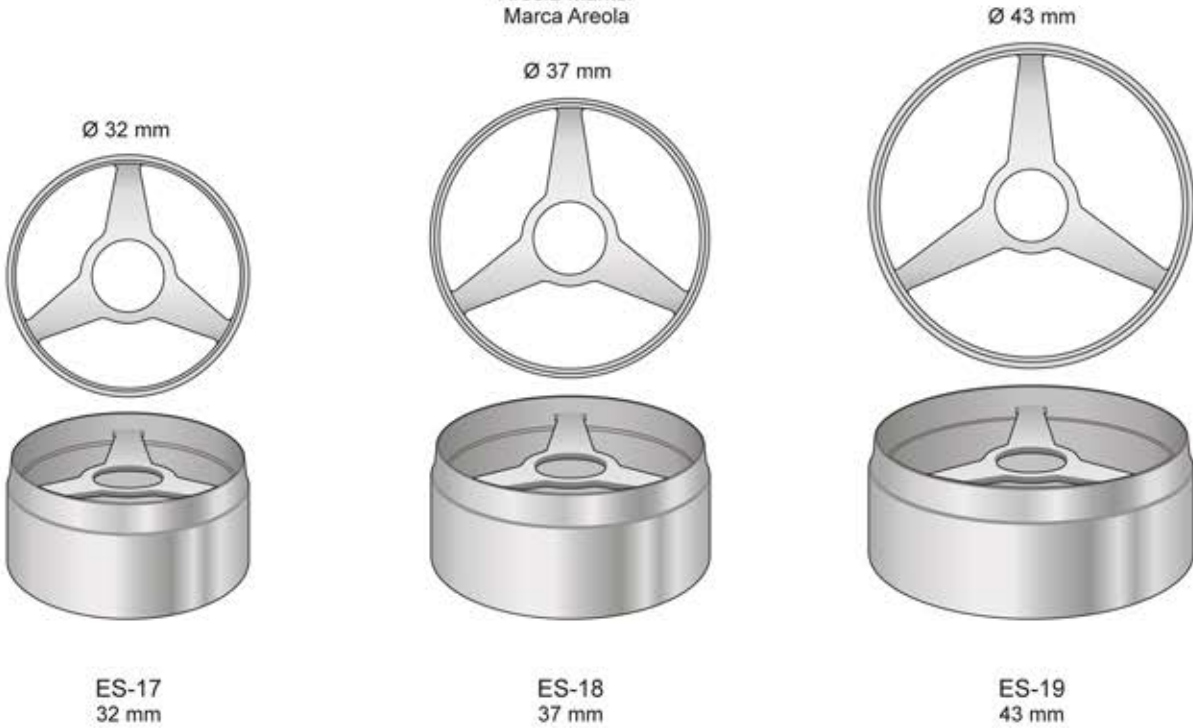

10

Hohlmeißelzangen
Rongeurs
Pinze ossivore
Pinzas gubias
Pincas gouges

Hohlmeißelzangen

Bone rongeurs

Pinze ossivore

Pinza-gubias

Pinces-gouges



MINI-FRIEDMANN
FO-22/FO-24
150 mm

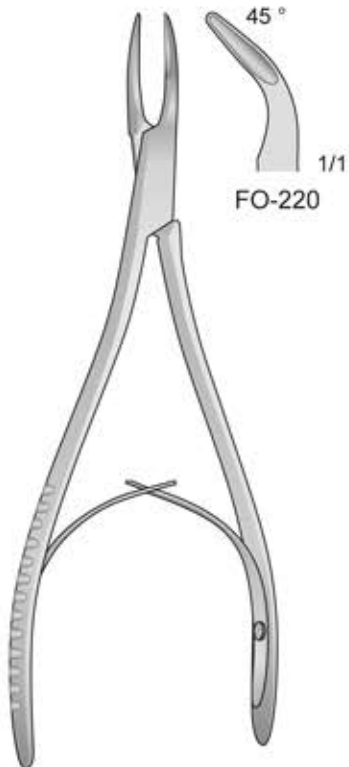

MINI-FRIEDMANN
FO-220
150 mm

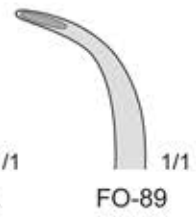
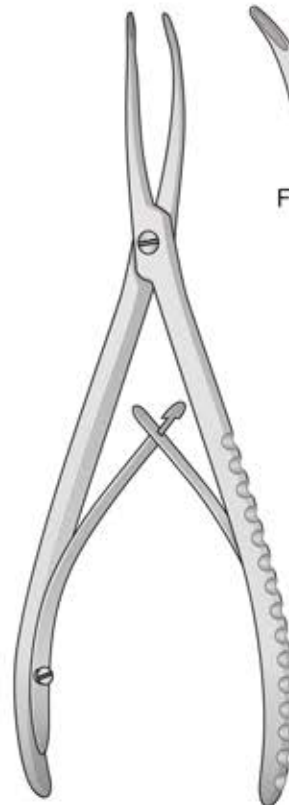

STELLBRINK
FO-88/FO-89
170 mm

Hohlmeißelzangen

Bone rongeurs

Pinze ossivore

Pinza-gubias

Pinces-gouges

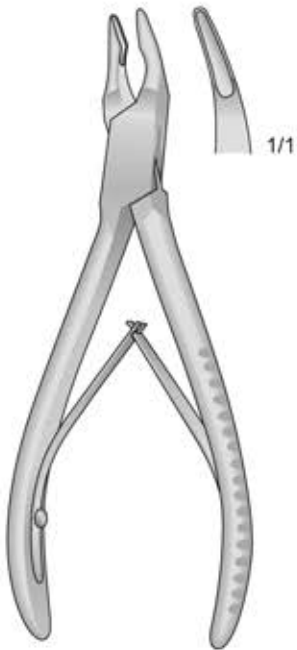

MINI-FRIEDMANN
FO-15
120 mm

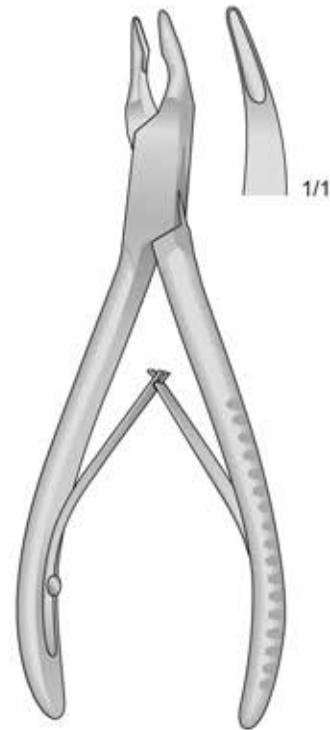

FRIEDMANN
FO-17
140 mm

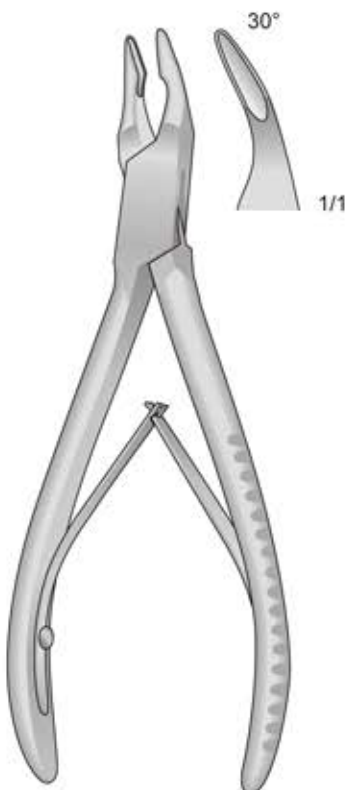

BLUMENTHAL
FO-19
150 mm



MEAD
FO-21
165 mm

Hohlmeißelzangen

Bone rongeurs

Pinze ossivore

Pinza-gubias

Pinces-gouges

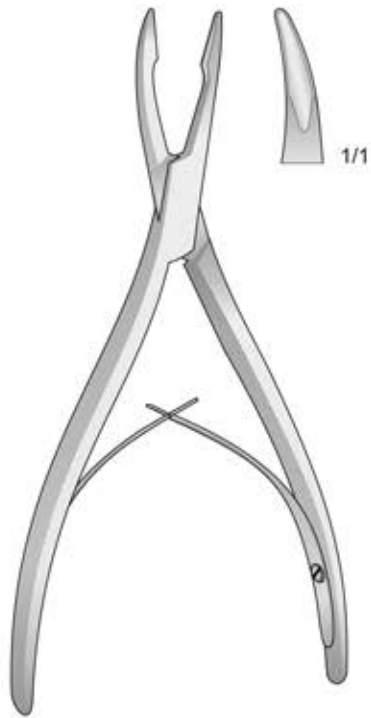

FRIEDMANN
FO-16
160 mm

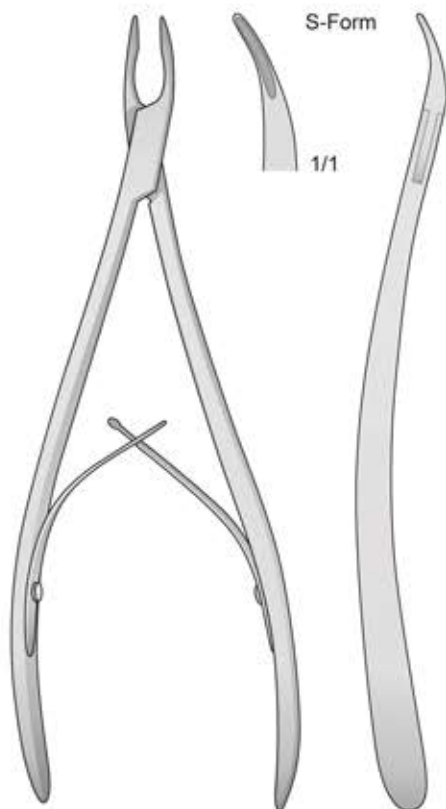

STELLBRINK
FO-87
190 mm

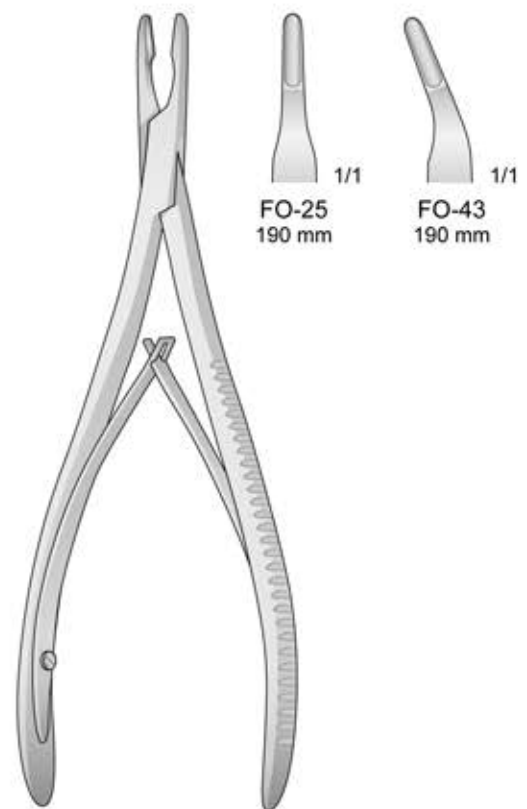

LEMPERT
FO-25/FO-43
190 mm

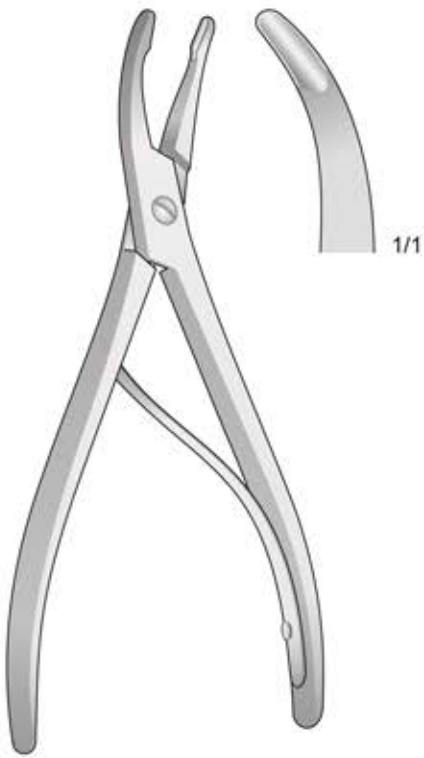

LUER
FO-18
155 mm

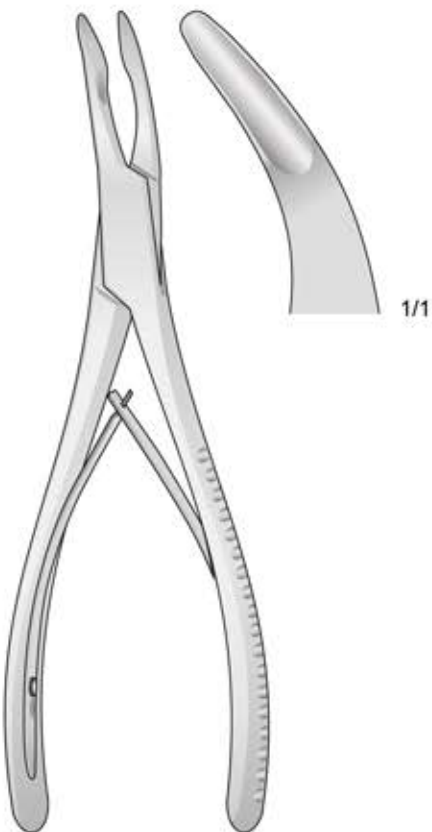

OLIVECRONA
FO-45
190 mm

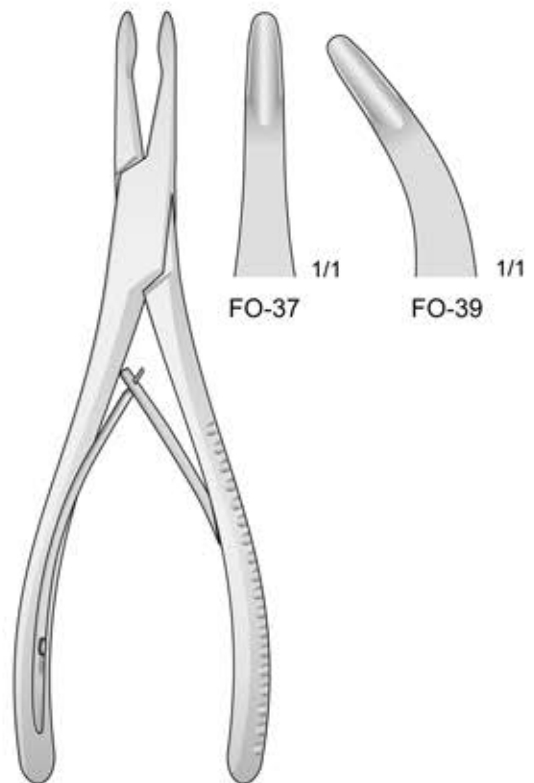

JANSEN
FO-37/FO-39
170 mm

Hohlmeißelzangen

Bone rongeurs

Pinze ossivore

Pinza-gubias

Pinces-gouges

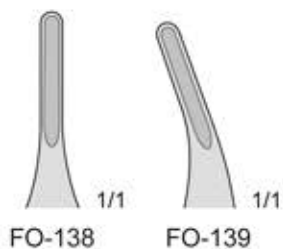
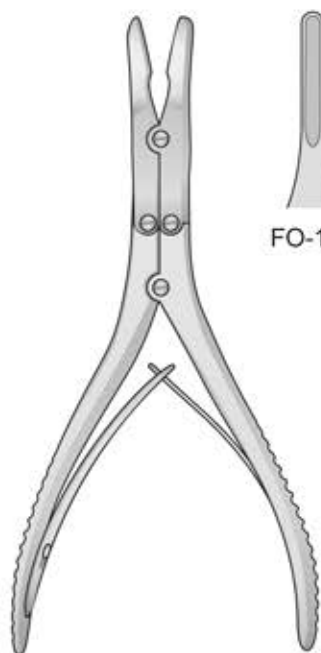

RUSKIN
FO-138/FO-139
150 mm

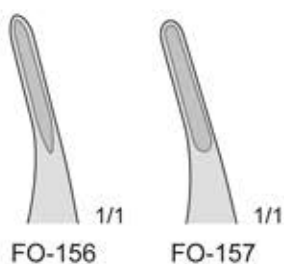
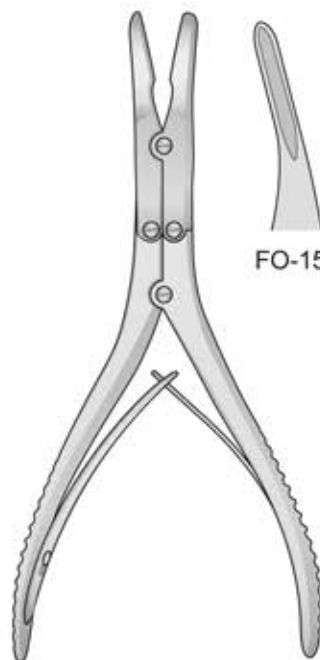

KLEINERT-KUTZ
FO-156/FO-157
155 mm

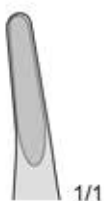

BEYER
FO-20
180 mm

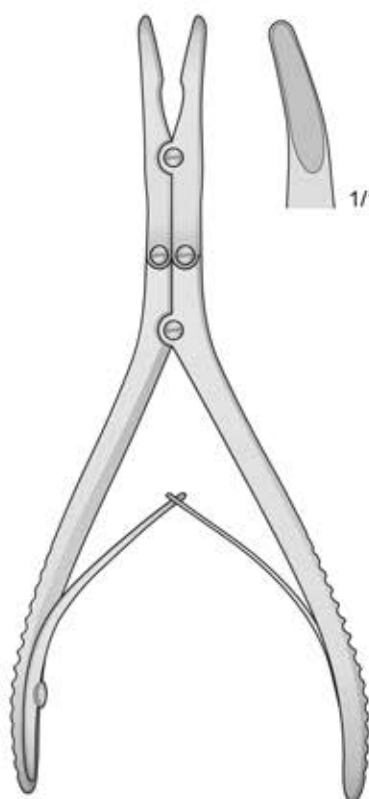

ZAUFAL-JANSEN
FO-34
180 mm

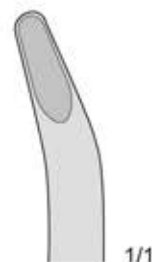
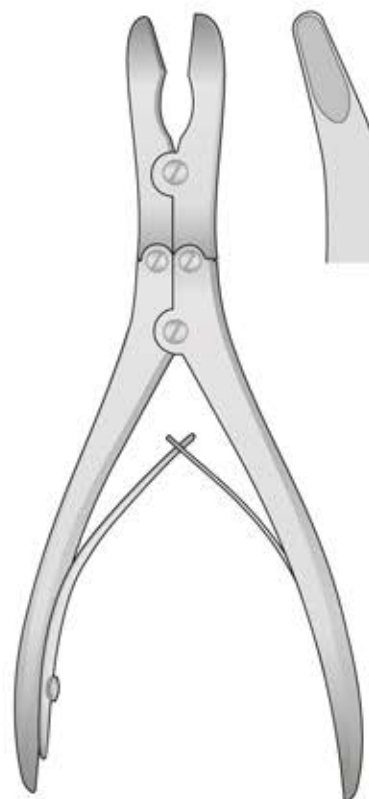

RUSKIN-STILLE
FO-35
180 mm

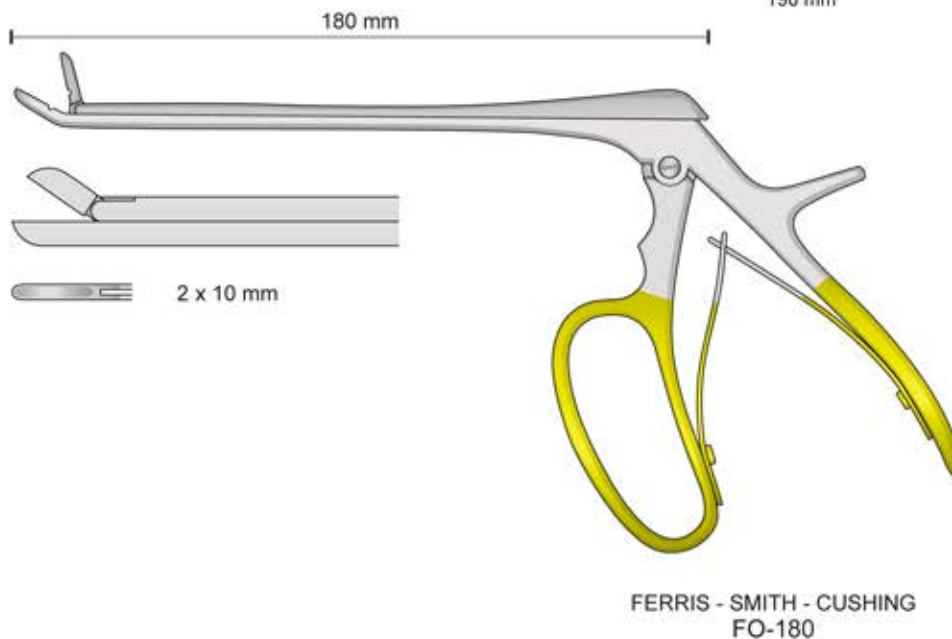
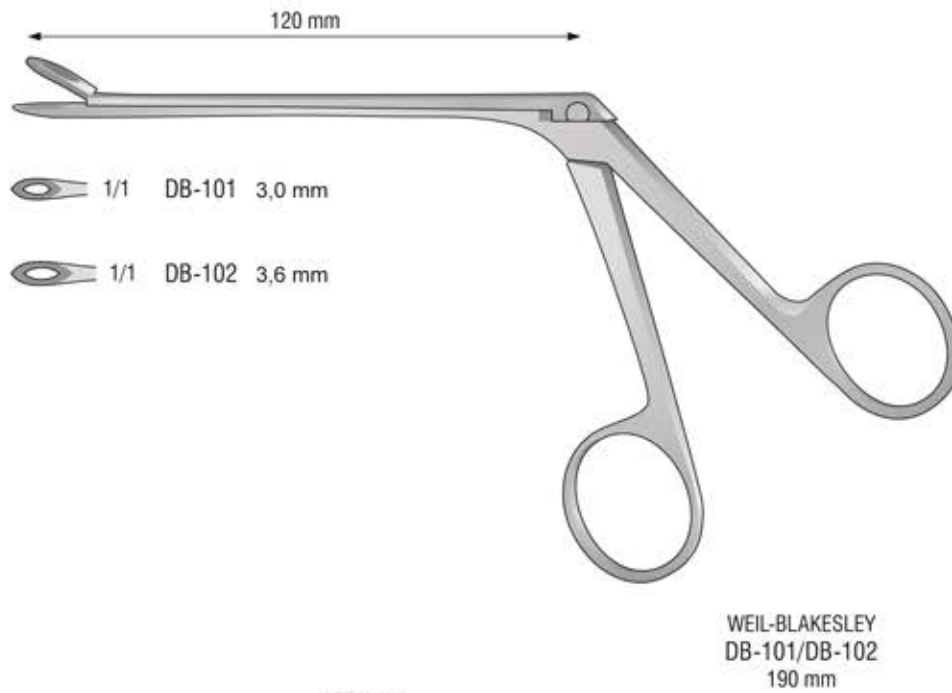
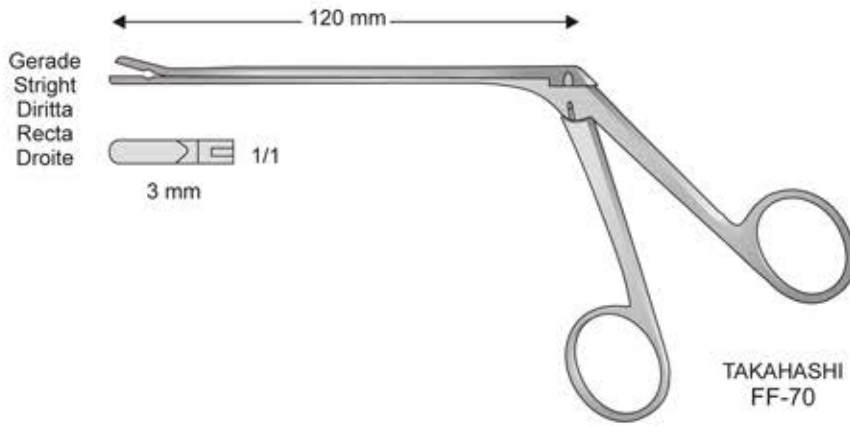

Pinze ossivore

Bone Cutting Forceps

Knochensplitterzangen

Pinces coupantes à os

Pinza cortante para huesos

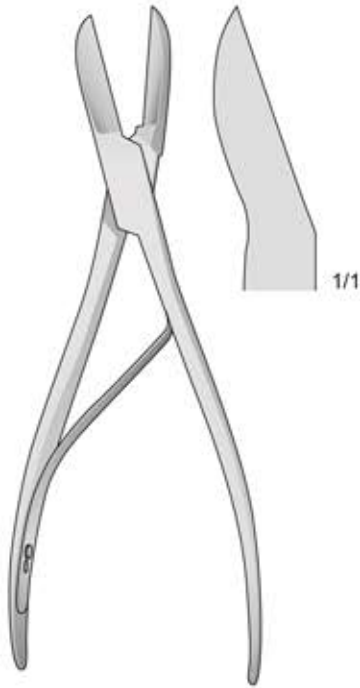

LISTON
LX-109
170 mm

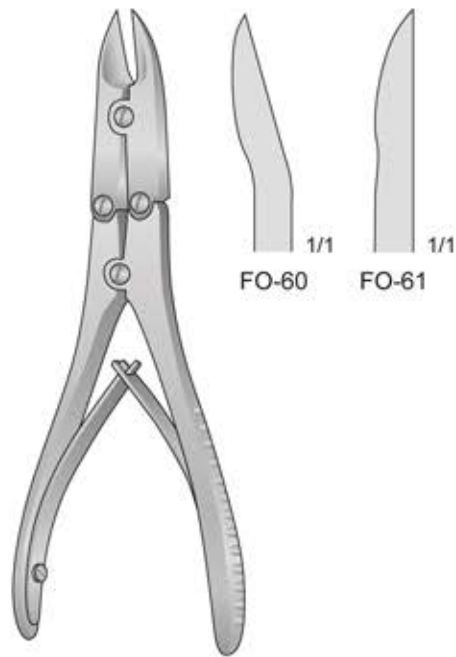

BÖHLER
FO-60/FO-61
150 mm

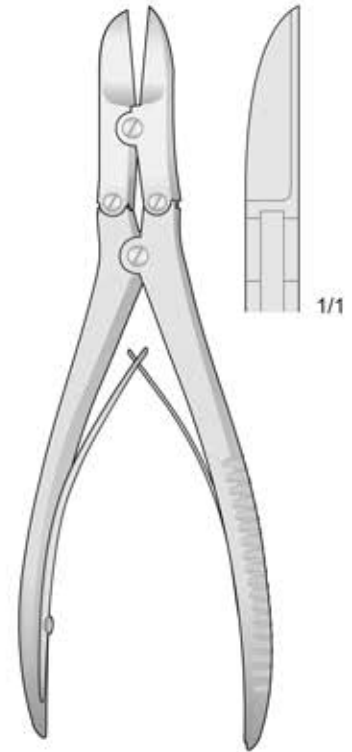

RUSKIN-LISTON
FO-108
190 mm

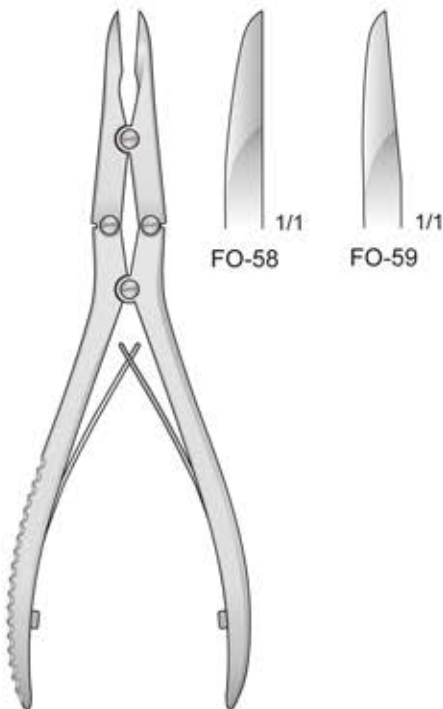

FO-58/FO-59
180 mm

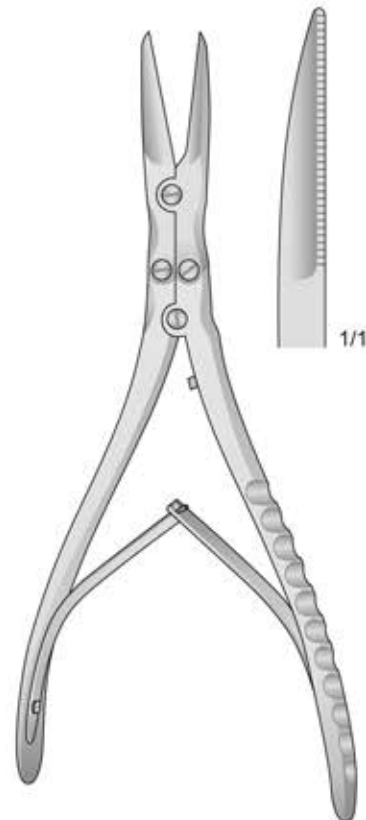

FO-146
215 mm

Zange mit Zahnsperre
Forceps with ratchet fixation
Pinza con cremagliera
Davier à crémaillère



FO-47
140 mm



DINGMANN
FO-130

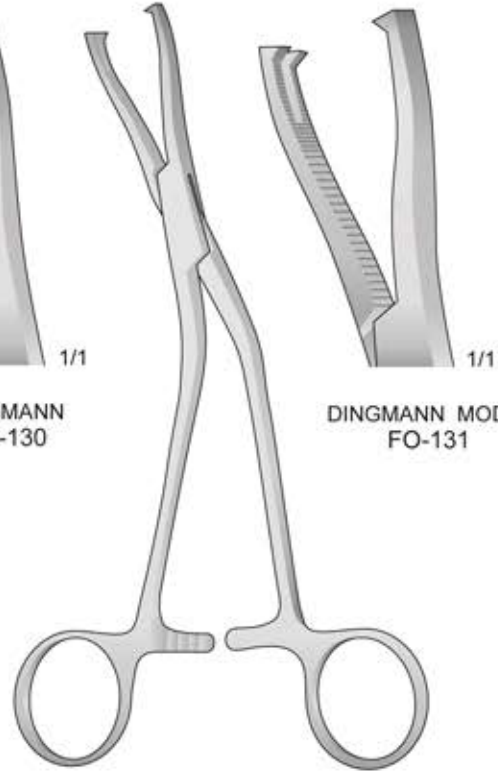

DINGMANN
FO-130/FO-131
190 mm

DINGMANN MODIF.
FO-131

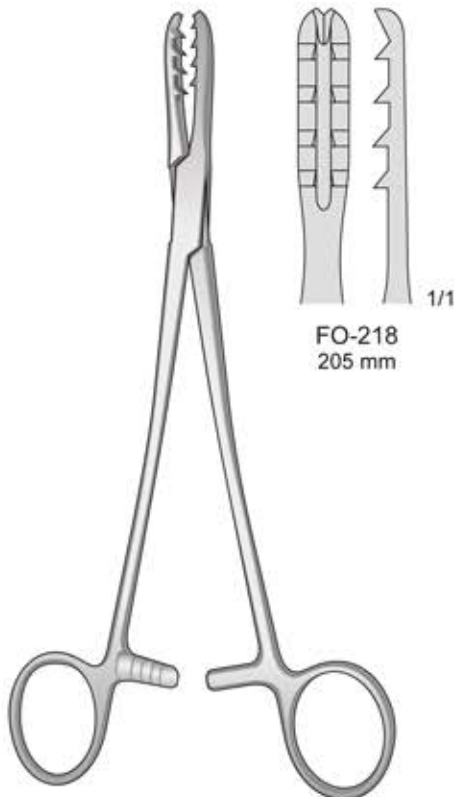

BIRCHER-GANSKE
FO-218
205 mm

FO-218
205 mm

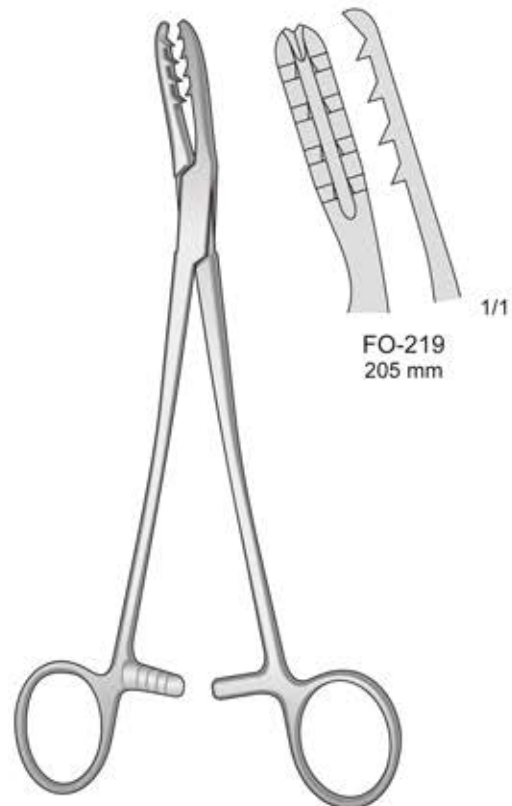

BIRCHER-GANSKE
FO-219
205 mm

FO-219
205 mm

Drahtschneidezangen

Wire cutting pliers

Tronchesi per fili
metallici

Cortador de agujas
kirschner

Pinces à couper le fil

Für weichen Draht Ø 2 mm
Für harten Draht Ø 1,5 mm
For soft wire Ø 2 mm
For hard wire Ø 1,5 mm
Per filo leggero Ø 2 mm
Per filo duro Ø 1,5 mm
Para alambres ligero Ø 2 mm
Para alambres duro 1,5 mm
Pour fil léger Ø 2 mm
Pour fil dur Ø 1,5 mm

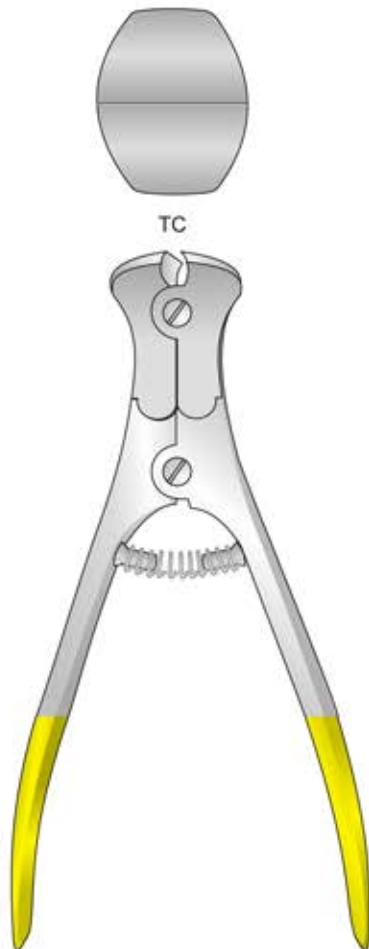

LX-102
145 mm

Für weichen Draht Ø 2 mm
Für harten Draht Ø 1,6 mm
For soft wire Ø 2 mm
For hard wire Ø 1,6 mm
Per filo leggero Ø 2 mm
Per filo duro Ø 1,6 mm
Para alambres ligero Ø 2 mm
Para alambres duro Ø 1,6 mm
Pour fil léger Ø 2 mm
Pour fil dur Ø 1,6 mm

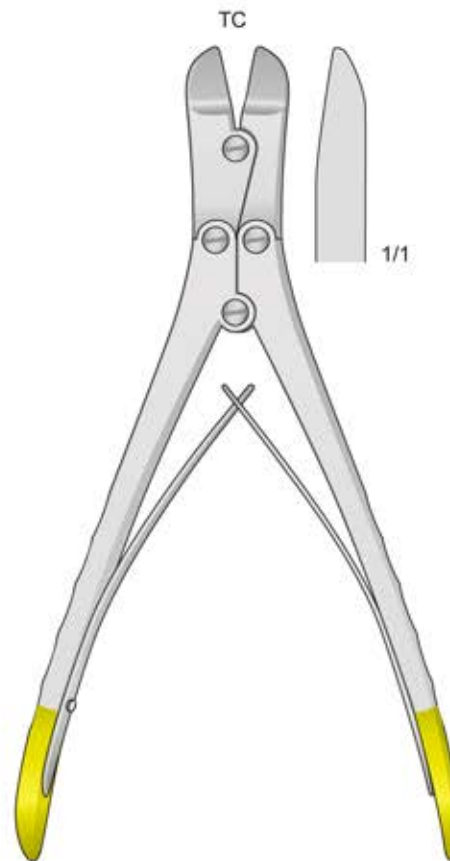

LX-103
170 mm

Extraktionszangen
für Bohrdrähte

Extraction pliers
for boring wires

Pinze per estrazione
fili metallici

Pinzas para extracción
de hilo metálico

Pinces pour
l'extraction des broches

Draht- und Blechschere gezahnt - Wire cutting scissor serrated
Forbice universale dentellata - Tijeras para cortar hilo de acero dentadas
Ciseaux à couper les fils métalliques

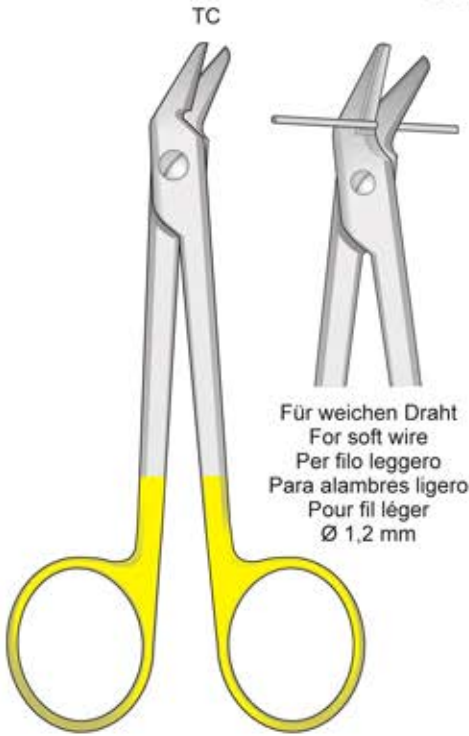

DP-120
120 mm

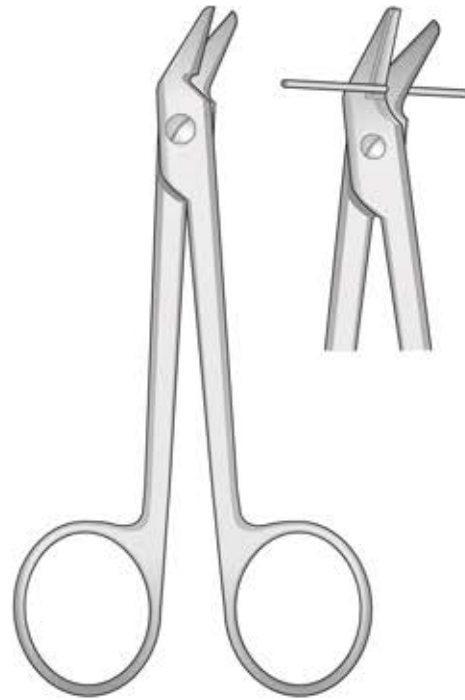

DP-90
120 mm

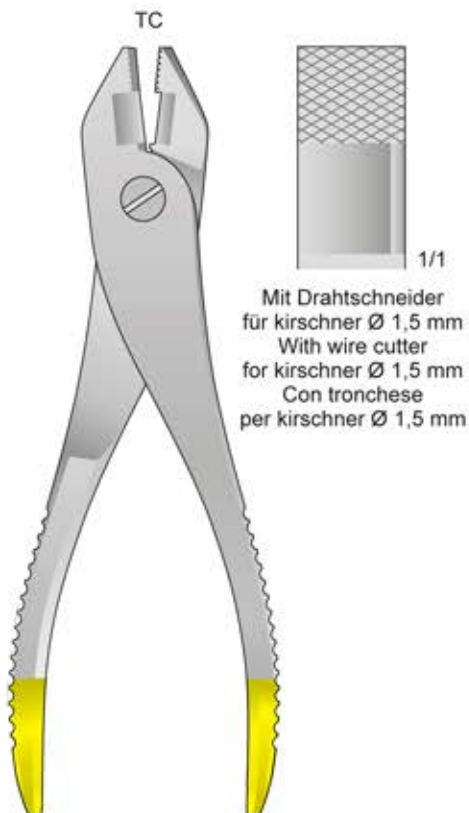

LX-125
220 mm

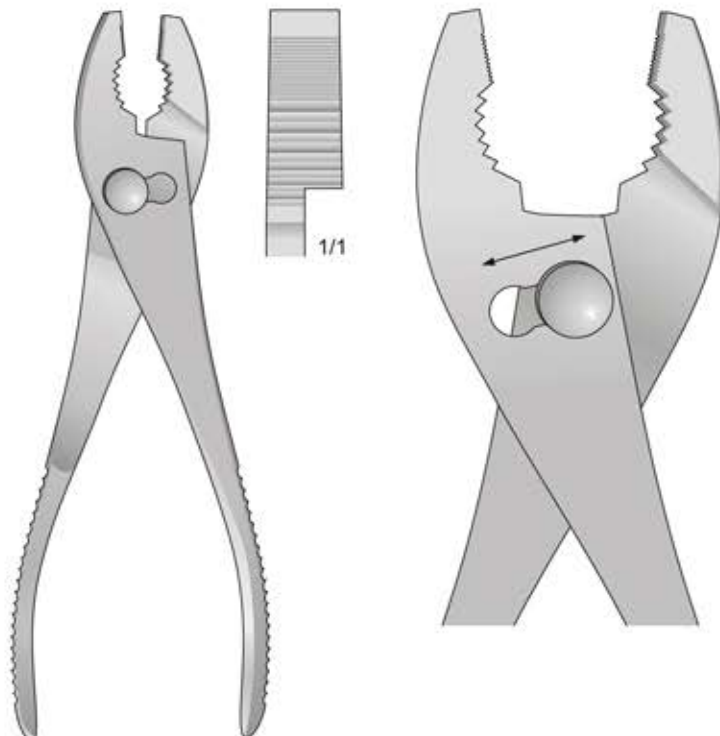

VH-40
200 mm

Extraktionszangen
für Bohrdrähte

Extraction pliers
for boring wires

Pinze per estrazione
fili metallici

Pinzas para extracción
de hilo metálico

Pinces pour
l'extraction des broches

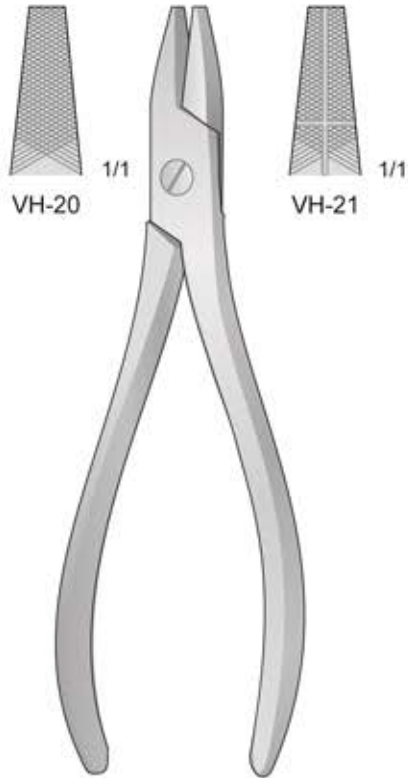

VH-20/VH-21
175 mm

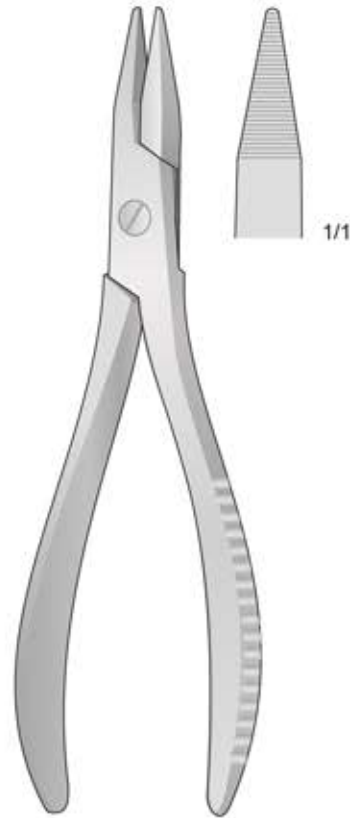

VH-23
190 mm

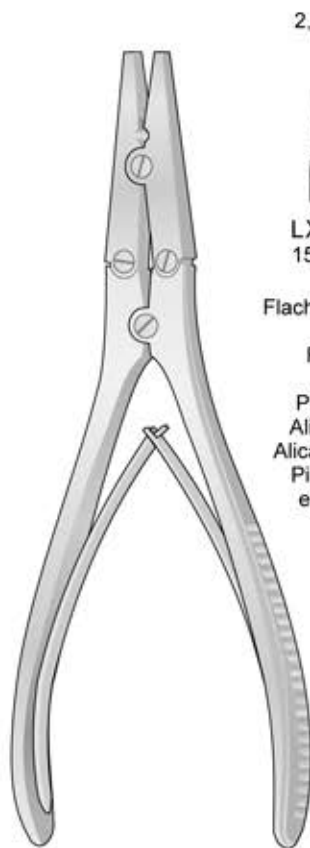

LX-138/LX-139

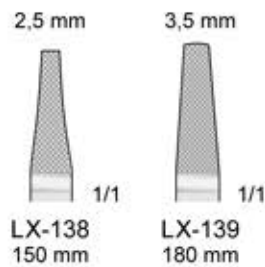

Flachzange, Extraktionszange
für Bohrdrähte
Flat pliers, Extraction
pliers for wires
Pinze per estrazione fili
Alicates para extracción,
Alicates para sacar alambre
Pince plate, Pinces pour
extraction des broches

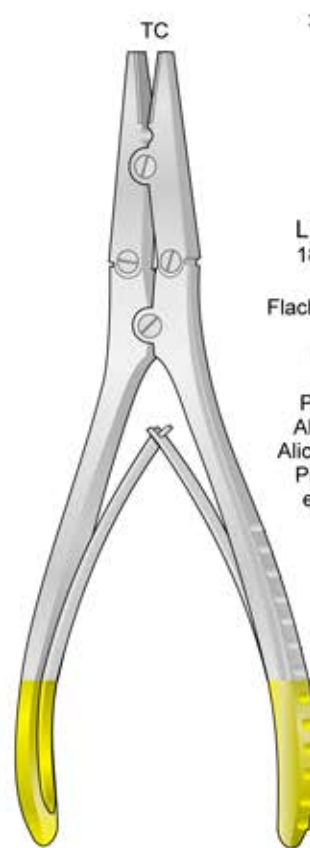

LX-140/LX-141

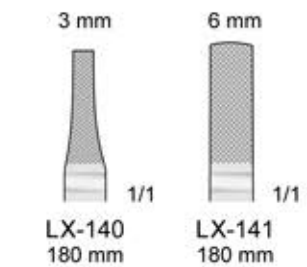

Flachzange, Extraktionszange
für Bohrdrähte
Flat pliers, Extraction
pliers for wires
Pinze per estrazione fili
Alicates para extracción,
Alicates para sacar alambre
Pince plate, Pinces pour
extraction des broches

Für Kinder
For children
Per bambini
Para niños
Pour enfants

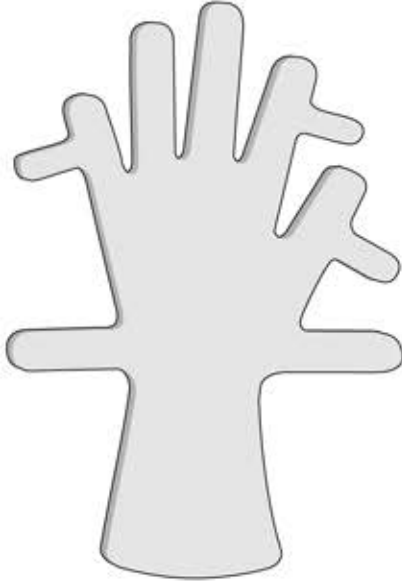

FO-299

Für Erwachsene - For adults - Per adulti
Para adultos - Pour adultes

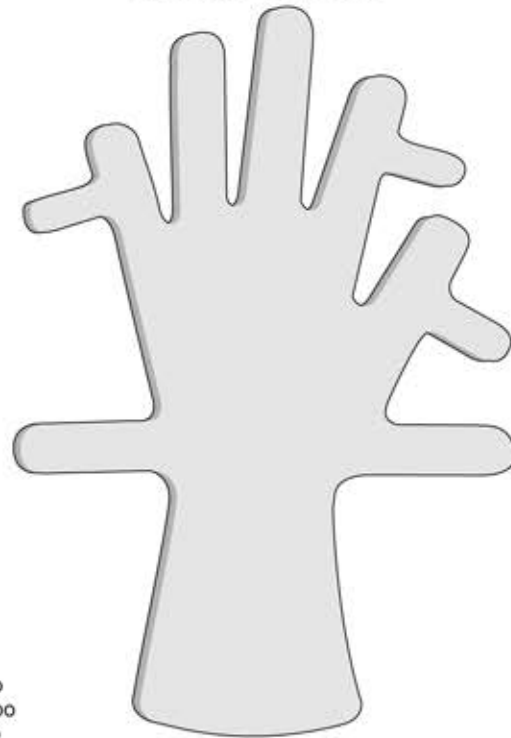

FO-300

Bleihände
Lead hands
Mani di piombo
Manos de plombo
Main de plomb

Nagel -Ausreisszange
Nail extracting forceps
Pinza per estrazione delle unghie
Pinzas para arrancar uñas
Pince pour extraire les ongles

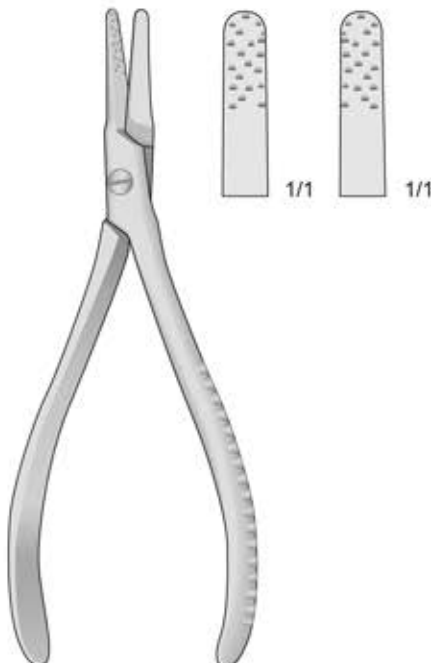

RADOLF
FO-159
135 mm

Nagelspaltzange
Nail nipper
Pinza per unghie
Pinzas corta uñas
Pince à ongles

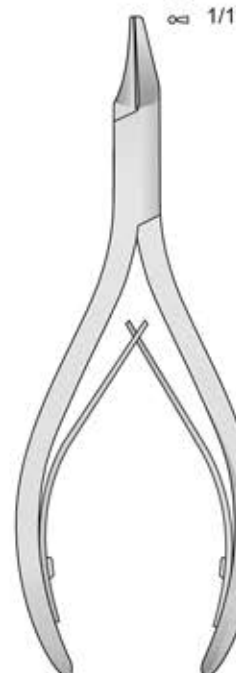

DP-09
135 mm

Repositionszangen

Reposition forceps

Pinze per riposizione

Pinzas para reducci3n

Pinces de reposicion

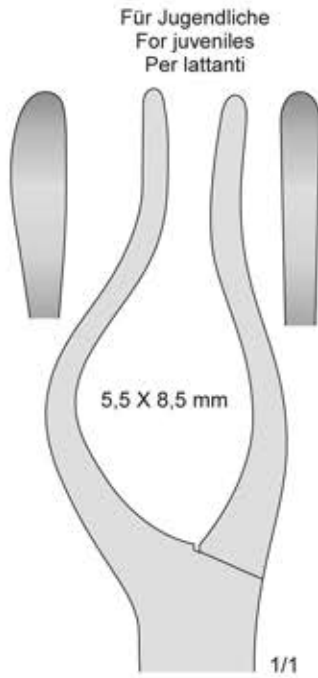

DO-10 L
DO-11 R
225 mm

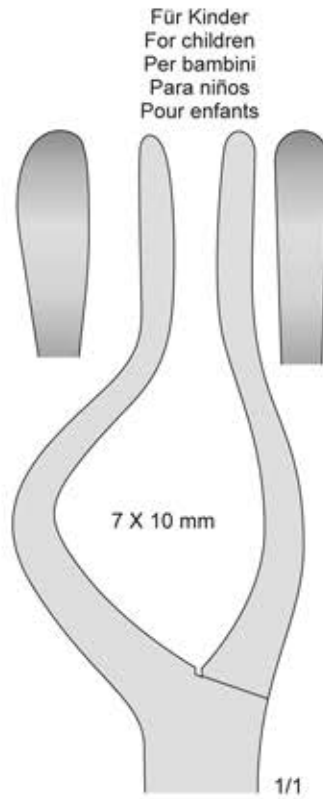

DO-12 L
DO-13 R
235 mm

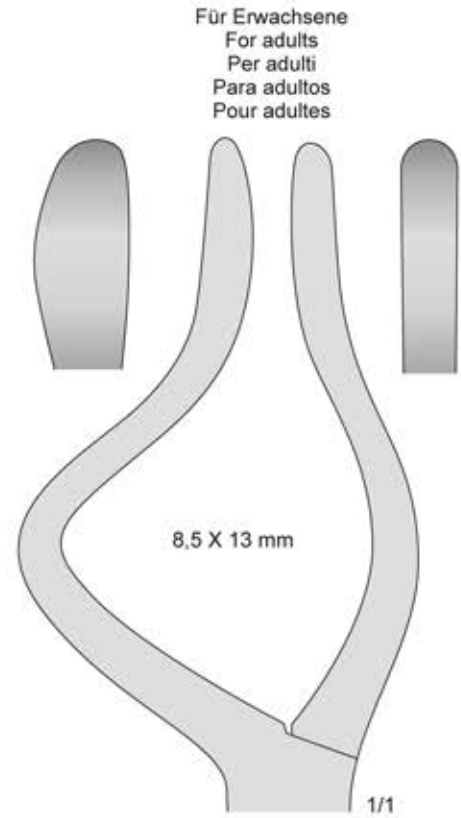

DO-14 L
DO-15 R
240 mm

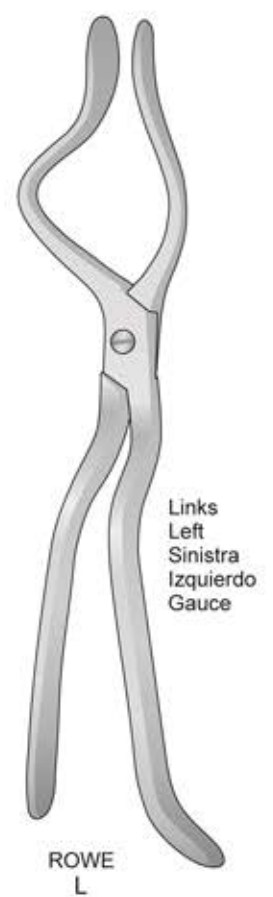
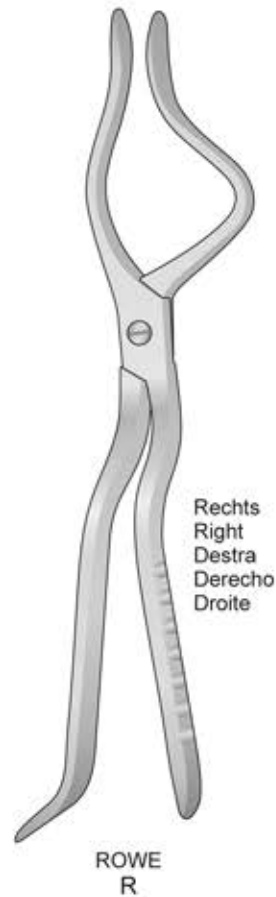
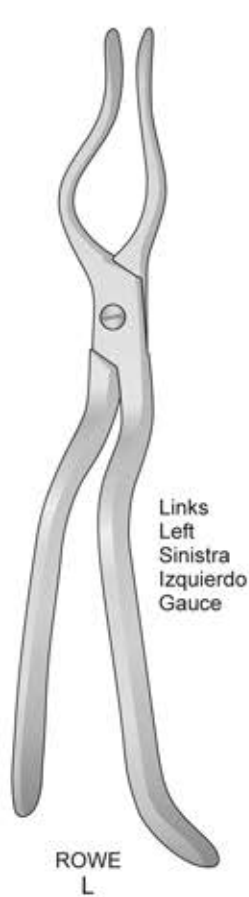
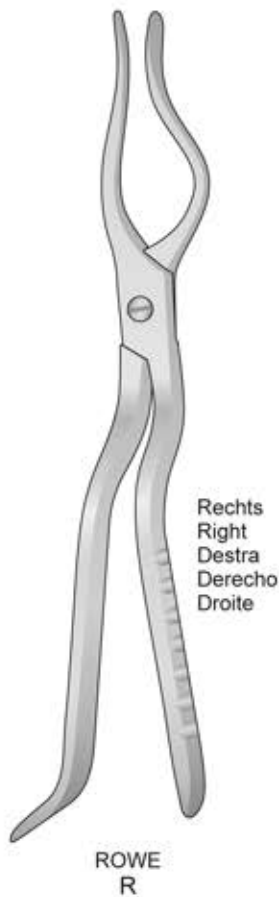

Rhinologie
Septumzangen

Rhinology
Septum Forceps

Rinologia
Pinze per setto nasale

Rinologia
Pinzas para tabique
nasal

Rhinologie
Pincés pour la cloison
nasale



COTTLE-WALSHAM
DO-147/DO-149
230 mm

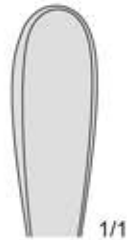

DO-147

Links
Left
Sinistra
Izquierdo
Gauze

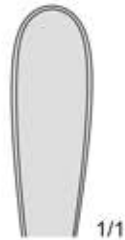

DO-148

Gerade
Straight
Diritto
Recto
Droite

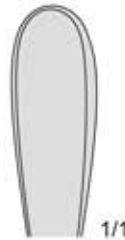

DO-149

Rechts
Right
Destra
Derecho
Droite

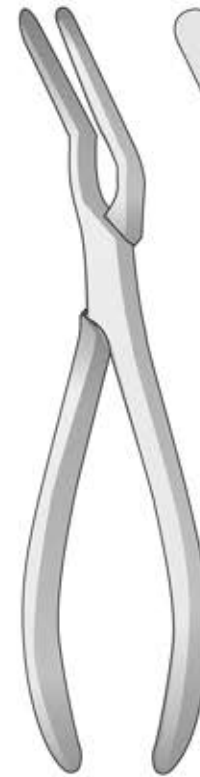

ASCH
DO-157
230 mm

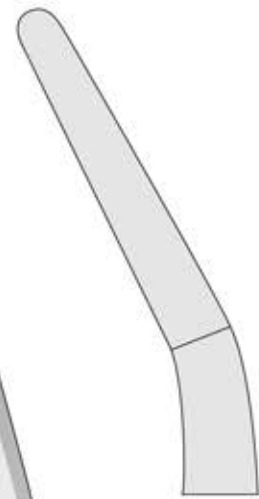

1/1

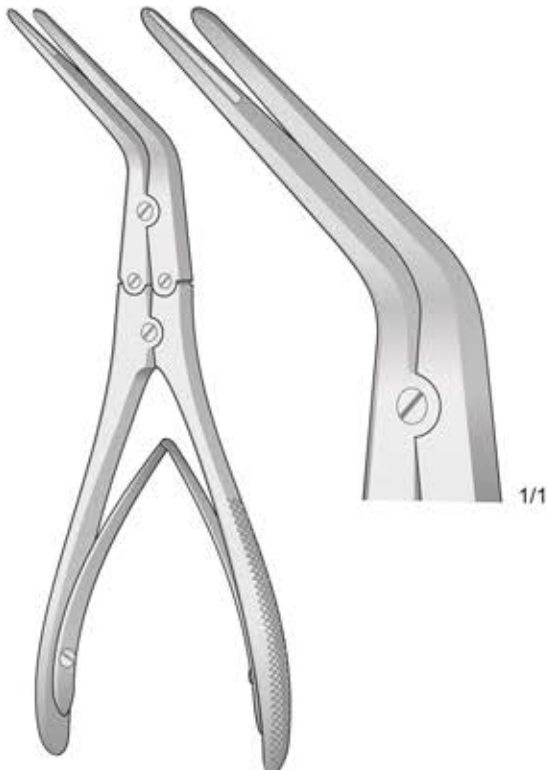

KRESSNER
FO-141
200 mm

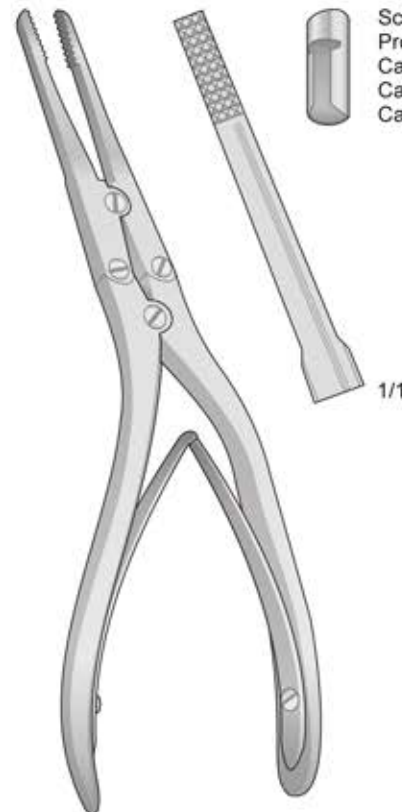

RUBIN
FO-142
210 mm



Schutzkappe
Protection Cap
Calotta protettiva
Caperuza protectora
Capuchon protecteur

1/1

Rhinologie

Rhinology

Rinologia

Rinologia

Rhinologie



Stumpf
Blunt
Smussa
Romo
Mousse

Septumfraktur-Elevatorium
Septum Displacer
Elevatore per fratture del setto
Elevador para fracturas
del tabique nasal
Elévateur pour fractures
de la cloison nasale

GOLDMANN
DO-288
200 mm

10 mm



Stumpf
Blunt
Smussa
Romo
Mousse

Nasenfraktur-Elevatorium
Nasal Fracture Elevator
Elevatore per fratture nasali
Elevador para fracturas nasales
Elévateur pour fractures nasales

BOIES
DO-289
200 mm

Septum bone cutting and
breaking forceps curved to the left,
sharp spoons

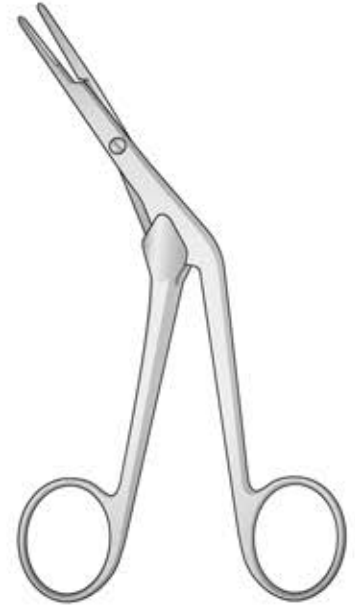

CRAIG
FO-490
165 mm

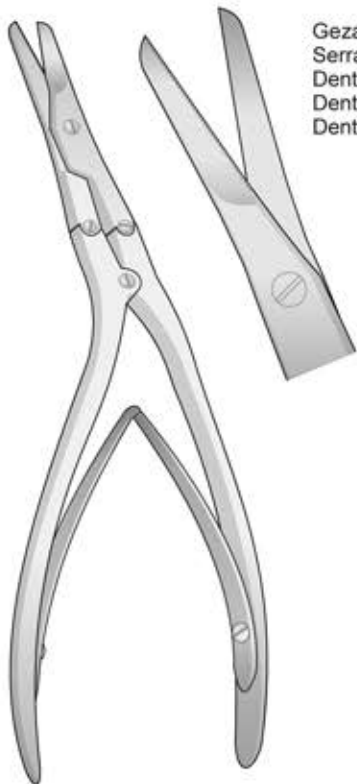

Gezahnt
Serrated
Dentellata
Dentada
Dentéle

CAPLAN
FO-144
200 mm

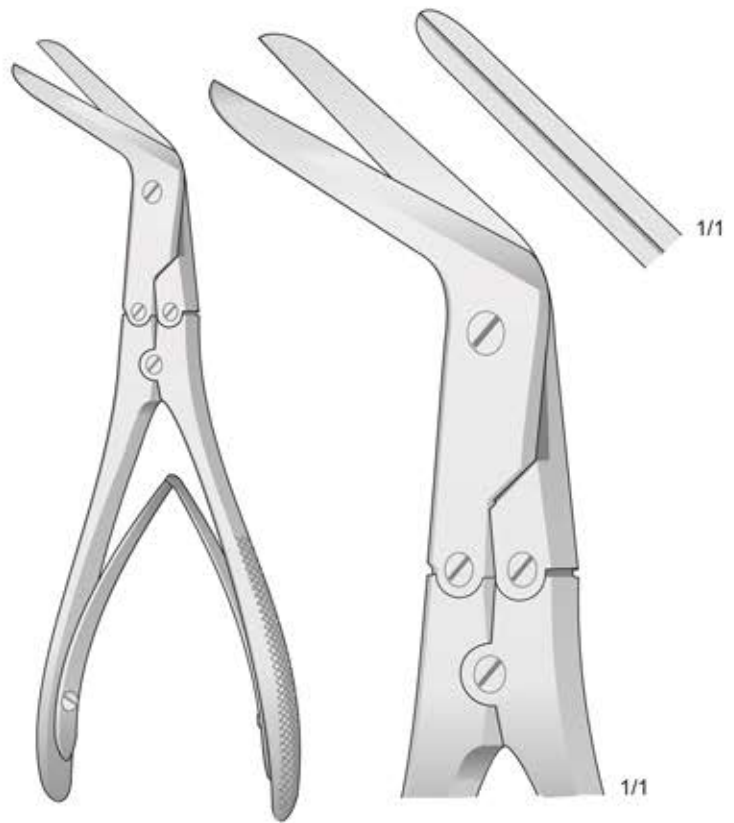

KILLIAN
FO-143
210 mm

11

Saugkanülen, Nagelzangen

Suction Tubes, Nail Nippers

Cannule per aspirazione, Tronchesi per unghie

Cánulas de aspiración, Pinzas para uñas

Canules d'aspiration, Pinces pour ongles

Saugkanülen

Suctions tubes

Cannule per
aspirazione

Cánulas de aspiración

Canules aspiratrices



Rostfrei
Stainless steel
Acciaio chirurgico
Acero
Acier

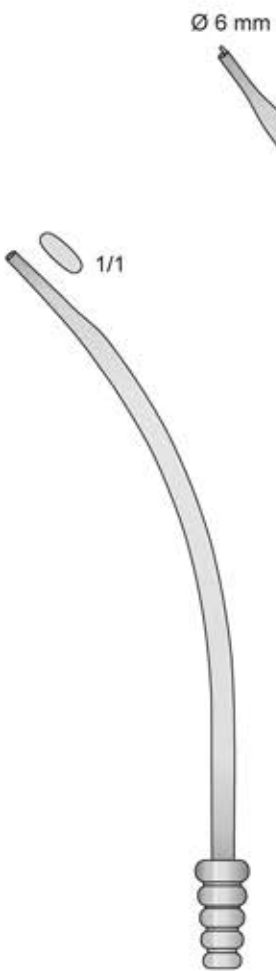

GF-20
180 mm



GF-104
240 mm



GF-110
230 mm



NUBOER
GF-98
210 mm

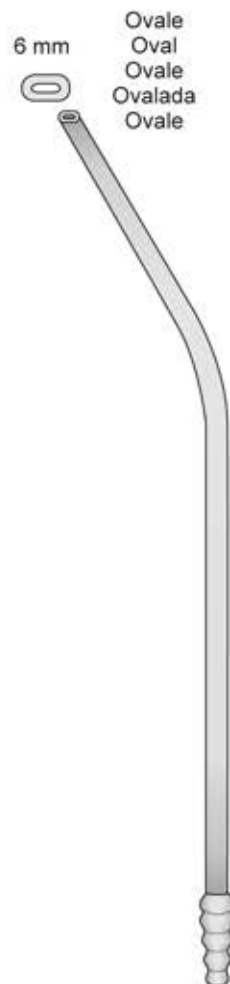

NUBOER
GF-99
210 mm

Saugkanülen

Suctions tubes

Cannule per aspirazione

Cánulas aspiradoras

Canules aspiratrices

Saugraspatorium Scharf - Raspatories, Scharp
 Raschietti taglienti - Raspador cortante - Rugine tranchante

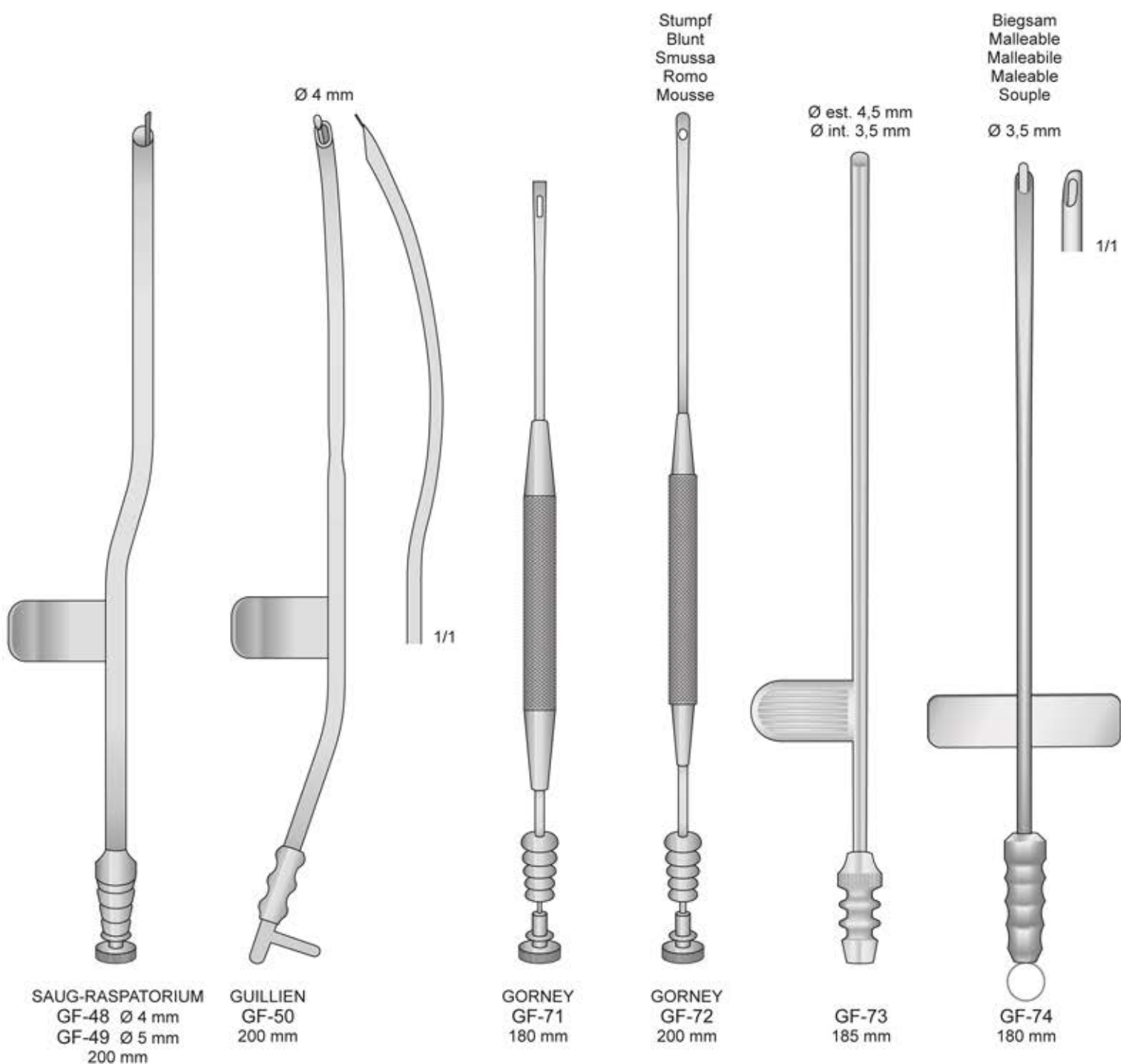

Char. 6	= 2 mm
Char. 7	= 2,5 mm
Char. 9	= 3 mm
Char. 10	= 3,3 mm
Char. 12	= 4 mm
Char. 15	= 5 mm

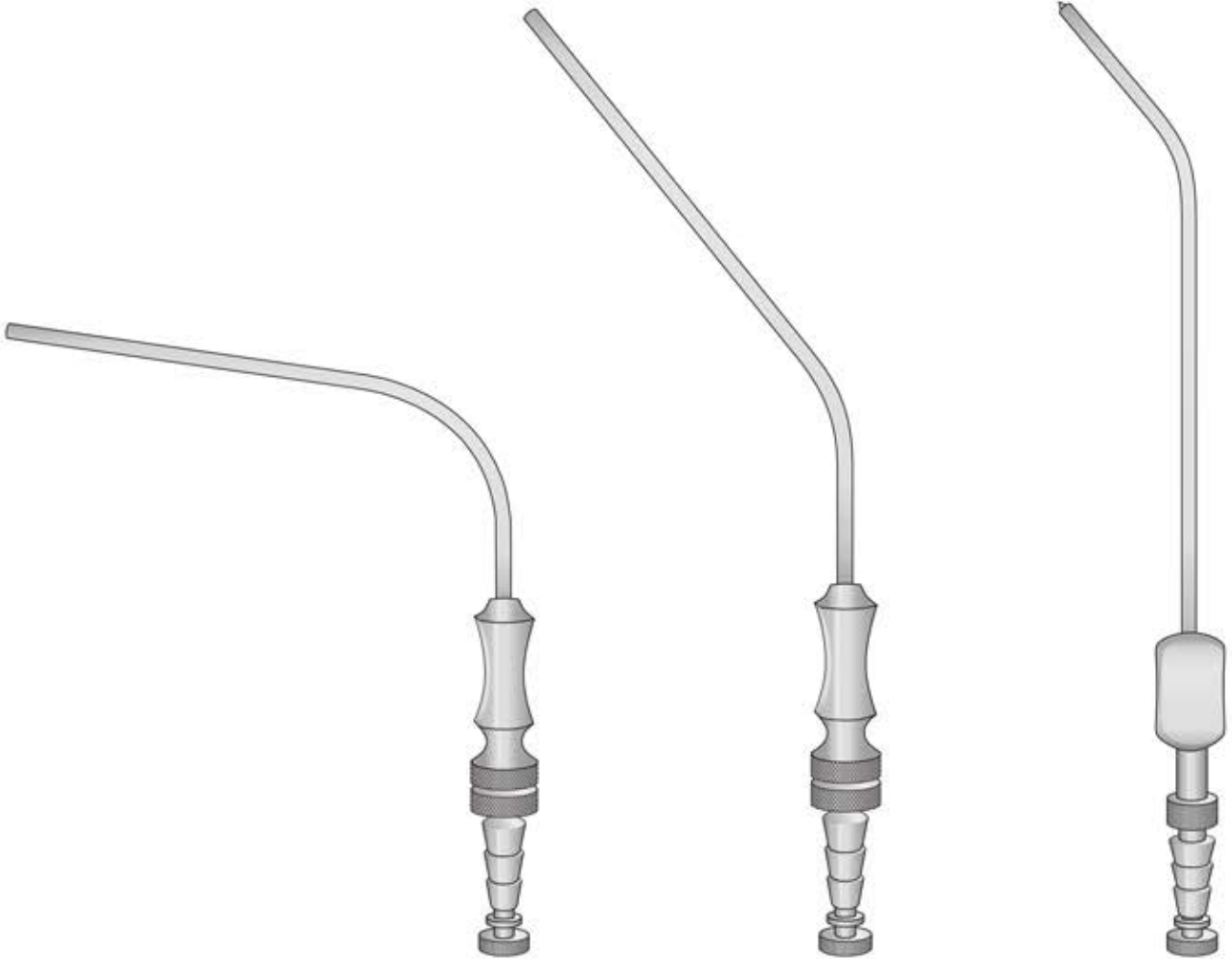

FERGUSSON
 GF-140 Ch. 6
 GF-141 Ch. 7
 GF-142 Ch. 9
 GF-143 Ch. 12
 GF-144 Ch. 15
 180 mm

FRAZIER
 GF-240 Ch. 6
 GF-241 Ch. 7
 GF-242 Ch. 9
 GF-243 Ch. 12
 GF-244 Ch. 15
 180 mm

PLESTER
 GF-150 Ch. 6
 GF-151 Ch. 7
 GF-152 Ch. 9
 GF-153 Ch. 12
 GF-154 Ch. 15
 200 mm

Saugkanülen

Suctions tubes

Cannule per aspirazione

Cánulas aspiradoras

Canules aspiratrices

Char. 3	= 1 mm
Char. 5	= 1,7 mm
Char. 7	= 2,5 mm
Char. 10	= 3,3 mm
Char. 12	= 4 mm

Mit Unterbrecherplatte
 With finger cut-off
 Con placca d'interruzione
 Con placa desconnectadora
 Avec plaque interruptrice

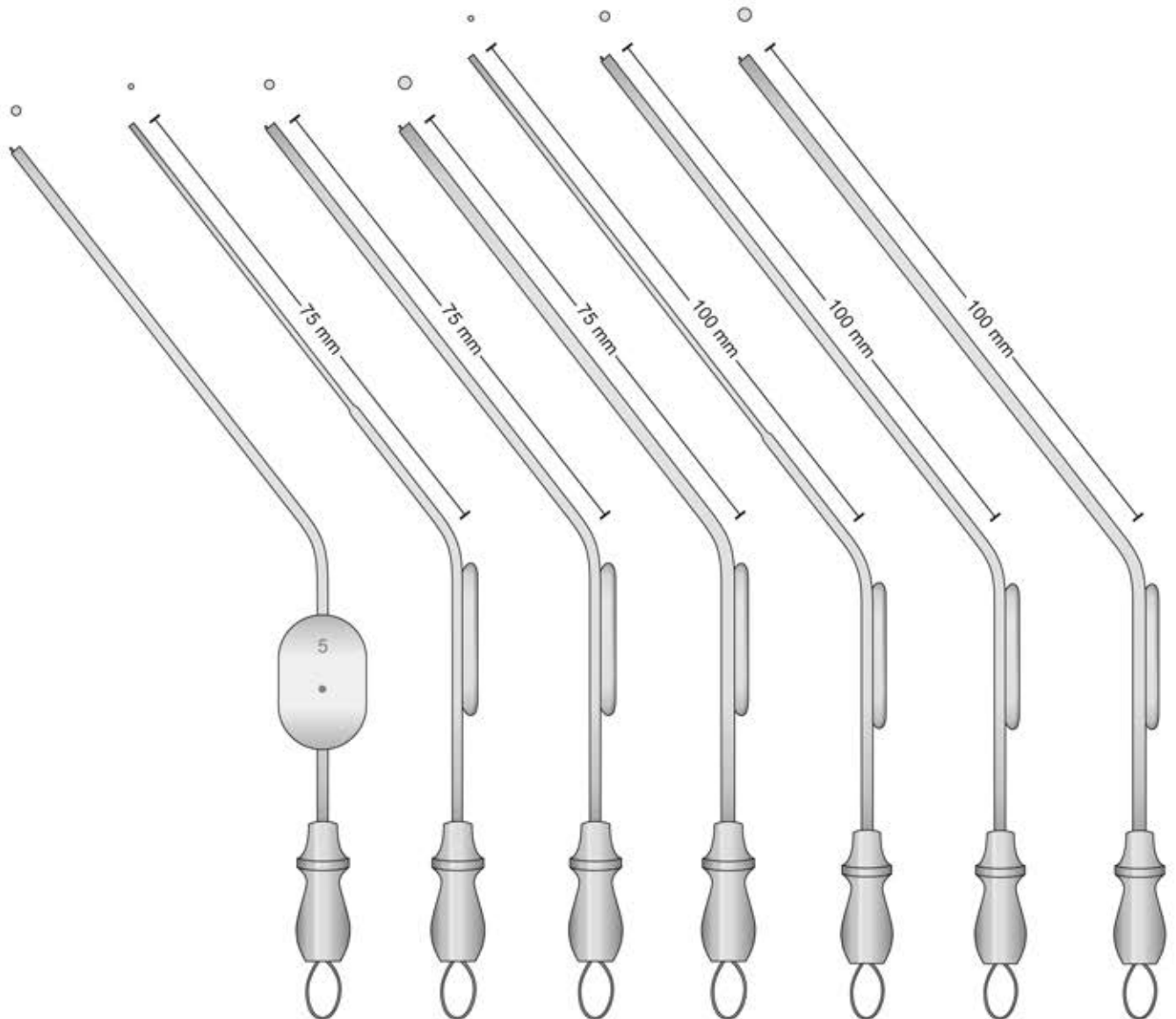

BELLUCCI
 GF-232
 Charr. 5

BARON
 GF-43
 Charr. 3

BARON
 GF-45
 Charr. 5

BARON
 GF-47
 Charr. 7

BARON
 GF-63
 Charr. 3

BARON
 GF-65
 Charr. 5

BARON
 GF-67
 Charr. 7

House Saug- und Spülrohr, Luer Konus

Saugrohr
Suction tube
Tubo per aspirazione
Tube d'aspiration

Spülrohr
Irrigation tube
Tubo per irrigazione
Tube d'irrigation

Char. 3	= 1 mm
Char. 5	= 1,7 mm
Char. 7	= 2,5 mm
Char. 10	= 3,3 mm
Char. 12	= 4 mm
Char. 14	= 4,6 mm

Char. 2	= 0,6 mm
Char. 4	= 1,21 mm
Char. 5	= 1,7 mm
Char. 7	= 2,5 mm
Char. 8	= 2,4 mm
Char. 12	= 4 mm



HOUSE
GF-53
Charr. 3/2

HOUSE
GF-55
Charr. 5/4

HOUSE
GF-57
Charr. 7/5

HOUSE
GF-56
Charr. 10/7

HOUSE
GF-59
Charr. 12/8

HOUSE
GF-58
Charr. 14/12

Saugkanülen

Suctions tubes

Cannule per aspirazione

Cánulas aspiradoras

Canules aspiratrices

Oberfläche Geschwärzt
Surface Black-finish
Superficie colorata nera
Surface noircie

Oberfläche Geschwärzt
Surface Black-finish
Superficie colorata nera
Surface noircie

Biegsam
Malleable
Malleabile
Malleable
Malléables
Ø 3 mm

Biegsam
Malleable
Malleabile
Malleable
Malléables
Ø 3 mm

Biegsam
Malleable
Malleabile
Malleable
Malléables
Ø 3 mm

Biegsam
Malleable
Malleabile
Malleable
Malléables
Ø 3 mm



WERTHEIMER
GF-69
160 mm

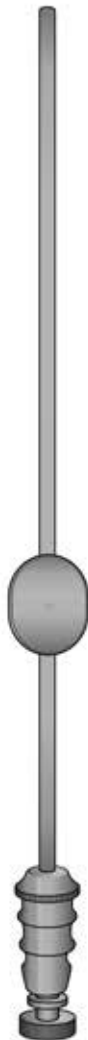

FRAZIER
GF-70
160 mm



WERTHEIMER
GF-60
200 mm



FRAZIER
GF-61
200 mm



ADSON
GF-41 ch. 12 = Ø 4 mm
GF-42 ch. 15 = Ø 5 mm
210 mm

GF-97
Komplettset mit:
Set complete with:
Set completo con:
Set completos con:
Set complet avec:
GF-92 - GF-93 - GF-94 - GF-96

Gummiball - Rubber bulb
Pompeta in gomma - Pera de goma
Poire en caoutchouc

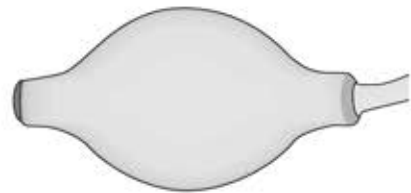

GF-96

Schlauch - Silikon
Flexible tube - Silicone
Raccordo in silicone per cannule
Autoclavabile
Tubo flexible de silicona
Tuyau - Silicone

2 mt.



TS-50
2 mt.



HARTMANN
GF-111/GF-113
170 mm

GF-111 - Ø 1,5 mm
GF-112 - Ø 2 mm
GF-113 - Ø 2,5 mm



GF-94
160 mm

Ø 4 mm

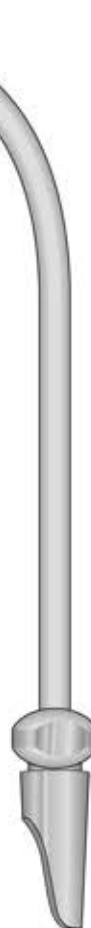

GF-93
145 mm



GF-92
65 mm

65 mm

Saugkanülen

Suctions tubes

Cannule per aspirazione

Cánulas aspiradoras

Canules aspiratrices

Kiefer und Stirnhöhlen-Spülkanülen
Antrum and frontal sinus wash cannulas
Cannule per lavaggio dei seni frontali e mascellari
Cánulas lavadores para seno maxilar y seno frontal
Canules pour le lavage du sinus maxillaire et frontal

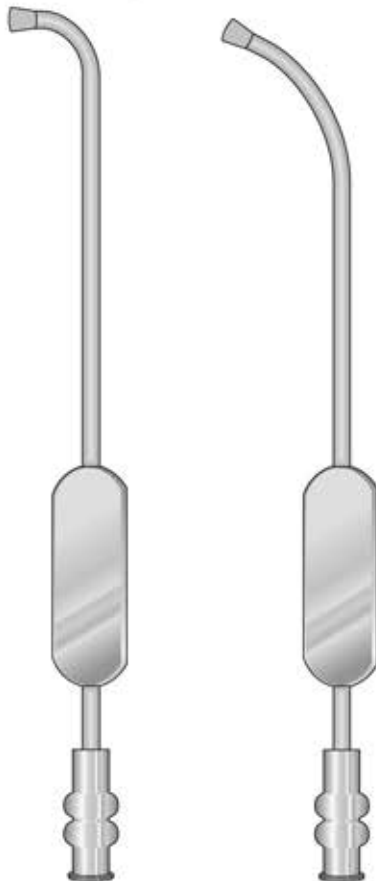

KILLIAN
GF-85 Ø 3 mm
GF-87 Ø 4 mm
145 mm

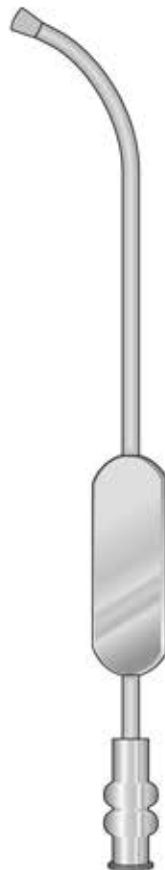

KILLIAN
GF-86 Ø 3 mm
GF-88 Ø 4 mm
145 mm



GF-256 Ø 4,5 mm
GF-257 Ø 5,5 mm
175 mm

Ø Innen
Ø Inside
Ø Interno
Ø Interior
Ø Intérieur



MAGILL
GF-100 Ø 1 mm
200 mm

Ø Innen
Ø Inside
Ø Interno
Ø Interior
Ø Intérieur

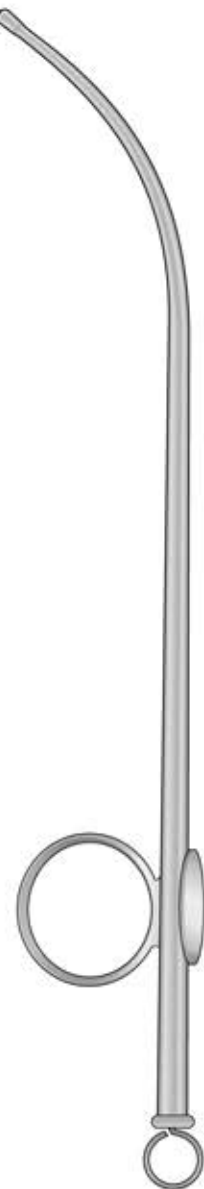

MAGILL
GF-101 Ø 1 mm
GF-102 Ø 2 mm
GF-103 Ø 3 mm
200 mm

Mikro
Saugkanülen

Micro
Suctions Tubes

Micro cannule
per aspirazione

MicroCánulas
aspiradoras

Micro Canules
aspiratrices

Infiltration Kanüle
Infiltration Cannula
Aghi-Cannula da infiltrazione
Aguja de infiltración
Aiguille pour infiltration

6 Loch
6 Openings
6 Fori
6 Bucos
6 Troues
Ø 1,5 mm

6 Loch - 6 Openings
6 Fori - 6 Bucos
6 Troues
Ø 1,5 mm

6 Loch
6 Openings
6 Fori
6 Bucos
6 Troues
Ø 1,3 mm

Ø 2,5 mm

Ø 2 mm

Ø 3 mm

Ø 2 mm

Ø 3 mm

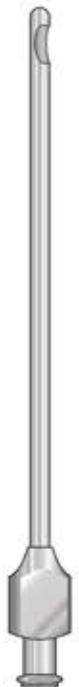

ES-05
70 mm



ES-06
110 mm



ES-07
110 mm



ES-08
110 mm



ES-09
110 mm

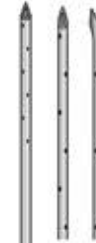
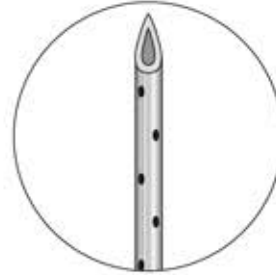

ES-34
120 mm



ES-35
200 mm



ES-36
270 mm

Mikro
Saugkanülen

Micro
Suctions Tubes

Micro cannule
per aspirazione

MicroCánulas
aspiradoras

Micro Canules
aspiratrices

Infiltration Kanüle
Infiltration Cannula
Aghi-Cannula da infiltrazione
Aguja de infiltración
Aiguille pour infiltration

10 Loch
10 Openings
10 Fori
10 Bucos
10 Troues
Ø 1.5 mm

3 Loch
3 Openings
3 Fori
3 Bucos
3 Troues
Ø 2.0 mm

5 Loch
5 Openings
5 Fori
5 Bucos
5 Troues
Ø 3.0 mm

2 Loch
2 Openings
2 Fori
2 Bucos
2 Troues
Ø 3.0 mm

5 Loch - 5 Openings
5 Fori - 5 Bucos
5 Troues
Ø 2.0 mm Ø 2.0 mm

7 Loch
7 Openings
7 Fori
7 Bucos
7 Troues
Ø 1.5 mm

2 Loch
2 Openings
2 Fori
2 Bucos
2 Troues
Ø 2.0 mm

5 Loch
5 Openings
5 Fori
5 Bucos
5 Troues
Ø 2.0 mm

5 Loch
5 Openings
5 Fori
5 Bucos
5 Troues
Ø 1.5 mm

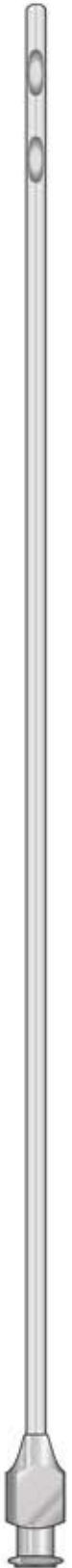

ES-41
100 mm

ES-51
150 mm

ES-52
150 mm

ES-53
150 mm

ES-54
200 mm

ES-55
200 mm

ES-56
200 mm

ES-59
200 mm

ES-57
300 mm

ES-58
300 mm

Makro
Saugkanülen

Macro
Suctions Tubes

Macro cannule
per aspirazione

MacroCánulas
aspiradoras

Macro Canules
aspiratrices

1 Loch - 1 Opening
1 Foro - 1 Bucos
1 Trou

Ø 4 mm

Ø 5 mm

Ø 6 mm

Ø 2 mm

Ø 3 mm

Ø 4 mm

Ø 3 mm

Ø 4 mm

Ø 5 mm

1/1

1/1

1/1

1/1

1/1

1/1

1/1

1/1

1/1

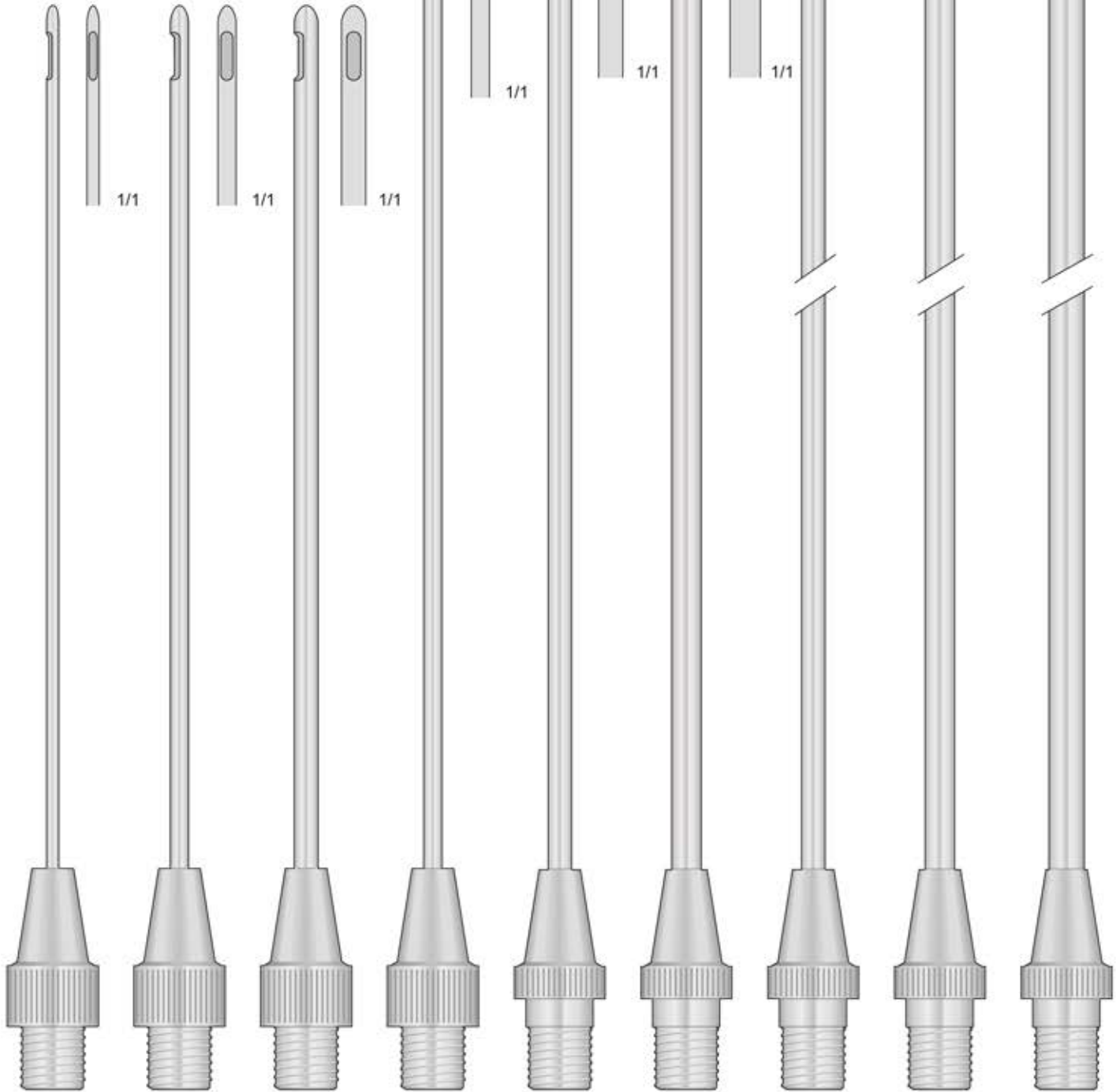

ES-77
150 mm

ES-60
150 mm

ES-61
150 mm

ES-62
200 mm

ES-68
200 mm

ES-69
200 mm

ES-70
300 mm

ES-71
300 mm

ES-82
300 mm

Makro
Saugkanülen

Macro
Suctions Tubes

Macro cannule
per aspirazione

MacroCánulas
aspiradoras

Macro Canules
aspiratrices

3 Loch - 3 Openings
3 Fori - 3 Bucos
3 Trous

Ø 3 mm

Ø 4 mm

Ø 5 mm

Ø 6 mm

Ø 3 mm

Ø 4 mm

Ø 3 mm

Ø 3 mm

Ø 4 mm

1/1

1/1

1/1

1/1

1/1

1/1

1/1

1/1

1/1

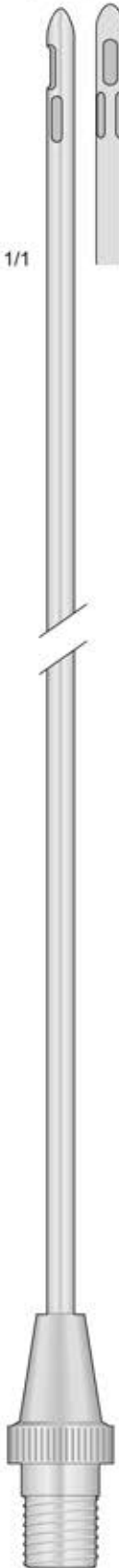
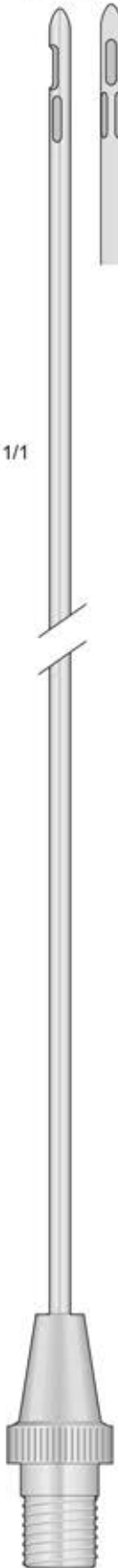
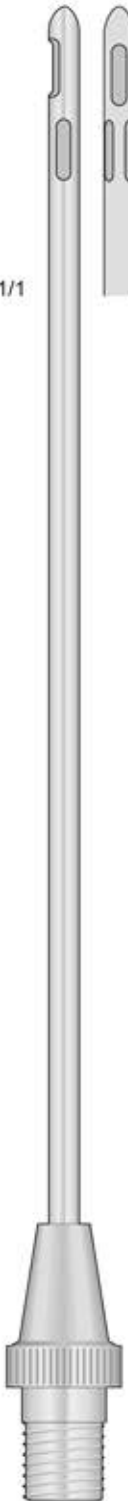
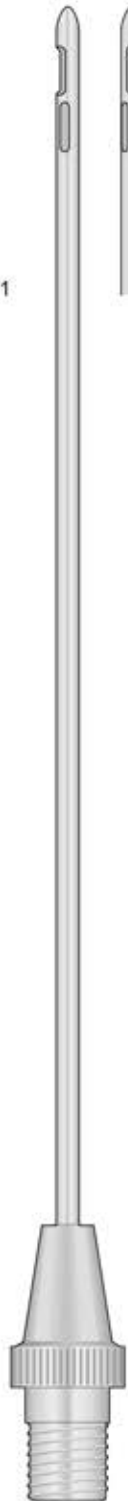
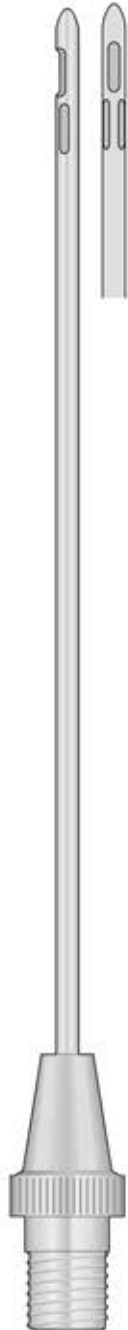

ES-83
150 mm

ES-84
150 mm

ES-79
200 mm

ES-85
200 mm

ES-63
200 mm

ES-66
300 mm

ES-67
300 mm

ES-76
300 mm

ES-81
300 mm

Makro
Saugkanülen

Macro
Suctions Tubes

Macro cannule
per aspirazione

MacroCánulas
aspiradoras

Macro Canules
aspiratrices

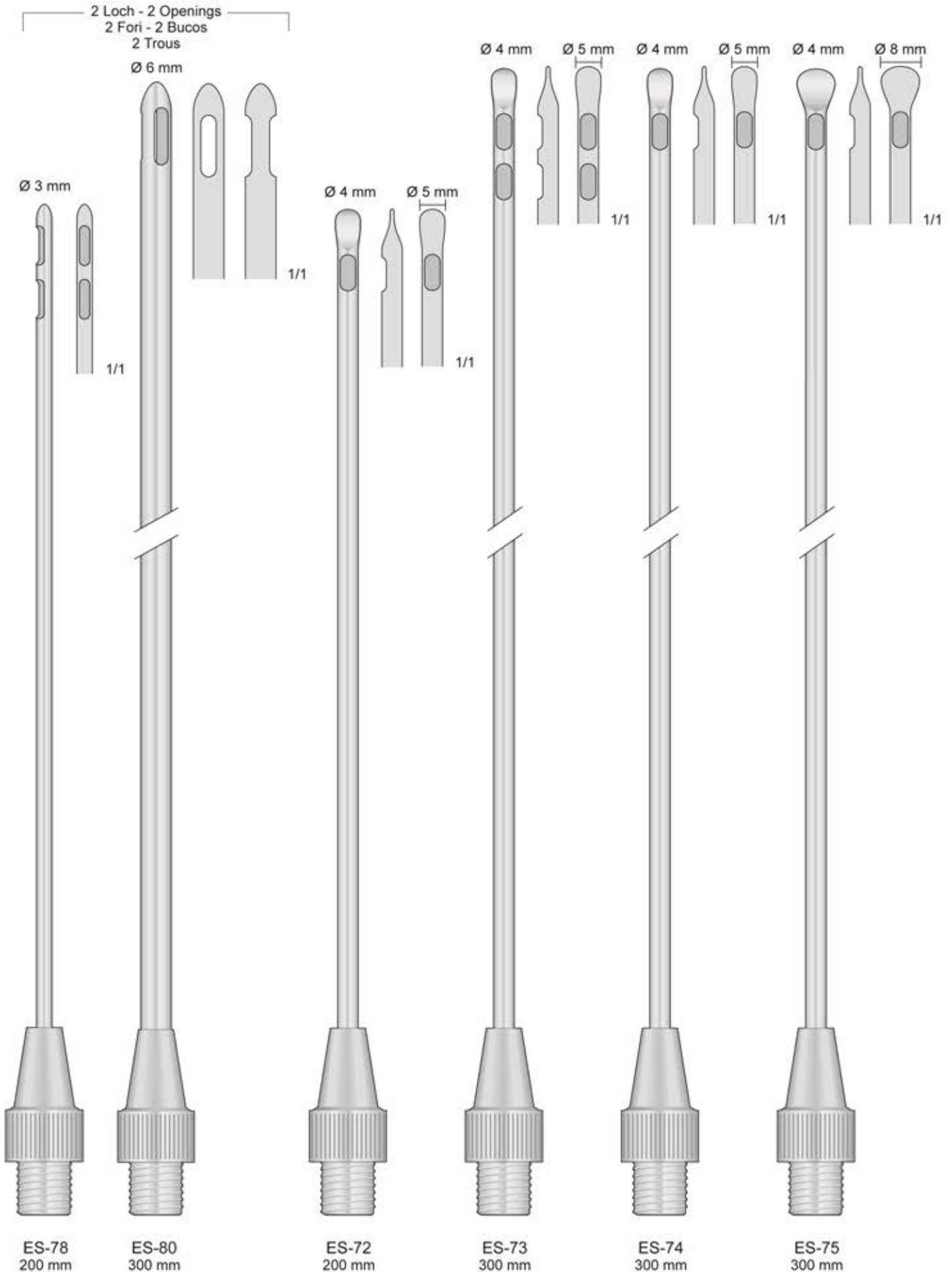

Makro
Saugkanülen

Macro
Suctions Tubes

Macro cannule
per aspirazione

MacroCánulas
aspiradoras

Macro Canules
aspiratrices

Biegsam - Malleable
Malleabile - Maleable - Souple

Ø 4 mm Ø 5 mm

Biegsam
Malleable
Malleabile
Maleable
Souple

Ø 3 mm

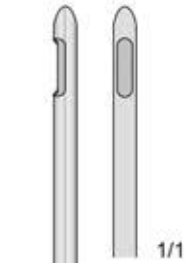

1/1



ES-92
200 mm

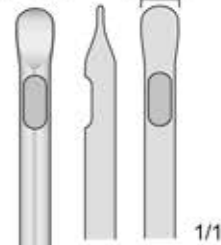

1/1

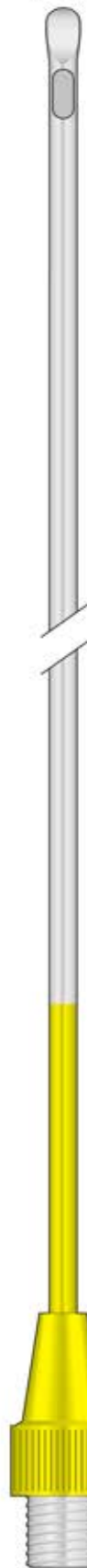

ES-102
300 mm

Alu-Griff
Aluminium Handle
Manico in Alluminio
Mango de aluminio
Manche à aluminium

Ø 18 mm



115 mm

ES-39
145 mm

Griff Rostfrei
Stainless Steel Handle
Manico in acciaio Inox
Mango de acero
inoxidable
Manche en
acier inoxydable

Ø 15 mm



130 mm

ES-49
165 mm

Alu-Griff Blau
Blue Aluminium Handle
Manico in Alluminio blu
Mango à aluminium azul
Manche de aluminium bleu

Ø 18 mm

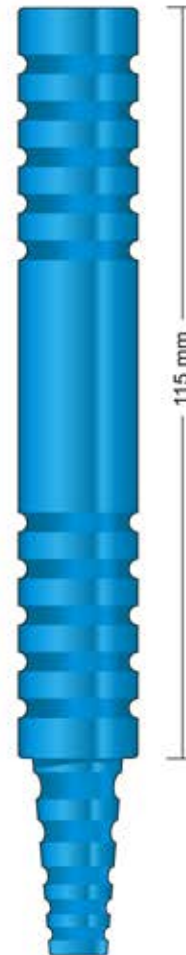

115 mm

ES-50
145 mm

The LUER-LOCK
to LUER-LOCK
Transfer System

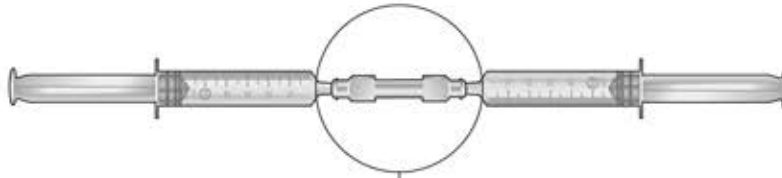

Spritzenstop, zur Gewinnung
eines Vakuums in der Spritze
Stop for syringes,
lock maintains vacuum in the syringe
Stop per siringhe
Stop pour siringe

Rostfreies Verbindungsteil
zum Spritze
Connection Piece for Suction
Raccordo Inox per siringa
Adapter en acier pour siringe

Ø est. 9 mm



Ø int. 10 mm

ES-01
40 mm

Raccordo per
due siringhe



Luer Lock

Luer Lock

1/1

ES-03
37 mm



ES-111
115 mm



ES-112
115 mm



OL-01
120 mm



OL-02
110 mm



OL-03
110 mm



OL-04
110 mm



OL-05
110 mm

Nadel für Biopsie
Kanülenreinigungsbürsten

Biopsy needles
Cleaning brush for tubes

Aghi da biopsia
Scovolini per pulizia cannule

Agujas para Biopsia
Cepillo para limpiar cánulas

Aiguilles pour Biopsie
Brosse de nettoyage pour canules

Sterilisier bar
Autoclavable
Autoclavabile
Esterilizabile
Stérilisable

Handwaschbürste
Nail brushes
Spazzola per unghie
Cepillos de uñas
Brosse à ongles



GF-200
4 x 11 cm

Punktionskanülen mit Luer-Lock Ansatz
Puncture needles with Luer-Lock connector
Cannule per puntura con innesto Luer-Lock
Cánulas para punción con cono Luer-Lock
Canules à ponctions avec embout Luer-Lock

Ø 2 mm



2/1

Reinigungsbürsten
Cleaning brushes
Spazzole per pulire
Cepillos de limpieza
Brosses à lavement



OL-41 - 1,30 x 80 mm
OL-42 - 1,50 x 80 mm
OL-43 - 1,65 x 80 mm

TUOHY
OL-41/OL-43



OL-44 - 0,70 x 80 mm
OL-45 - 0,70 x 90 mm
OL-46 - 1,00 x 80 mm
OL-47 - 1,00 x 90 mm
OL-48 - 1,20 x 90 mm
OL-49 - 1,20 x 100 mm

QUINKE
OL-44/OL-49

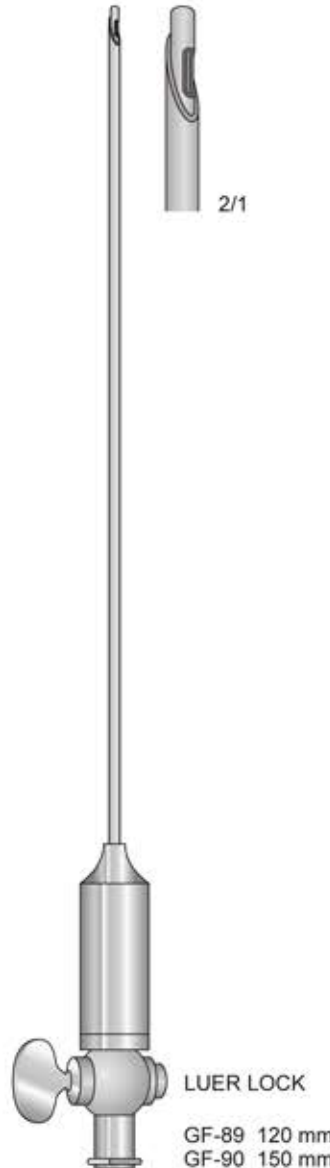

LUER LOCK

GF-89 120 mm
GF-90 150 mm

VERESS
GF-89/GF-90

GF-40
235 mm

GF-188
220 mm

Nagelzangen

Nail Nippers

Tronchesi per unghie

Pinzas para cortar uñas

Pinces pour couper ongles

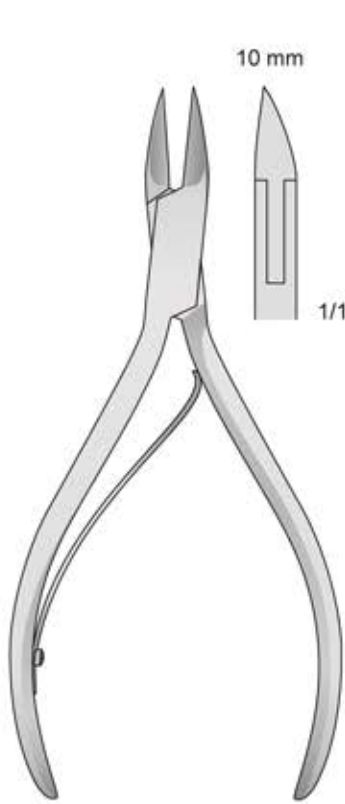

GS-42
100 mm

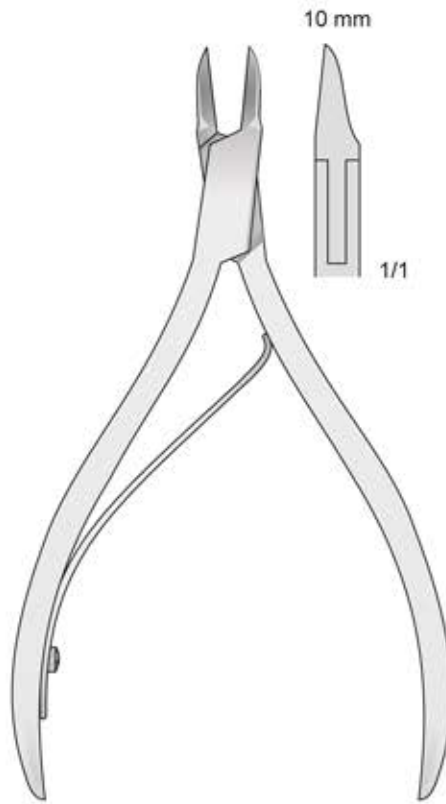

GS-43
110 mm

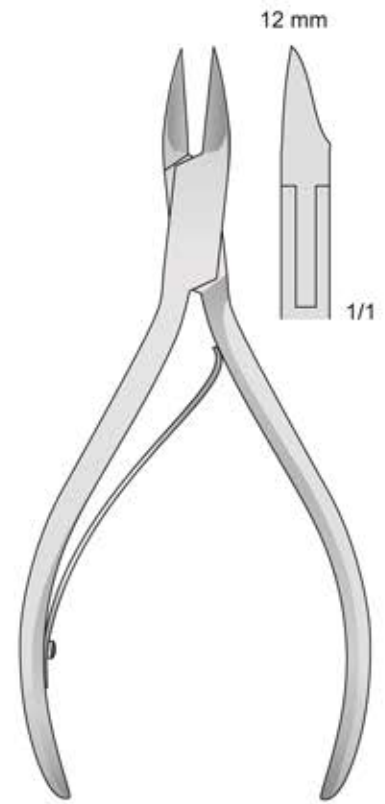

GS-44
110 mm

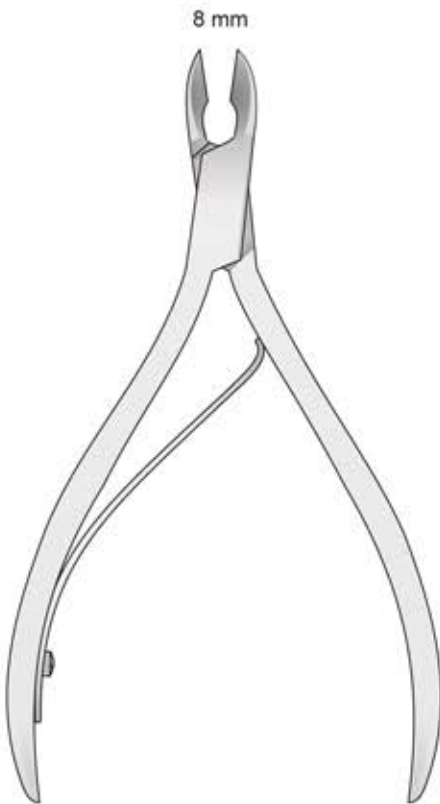

GS-41
110 mm

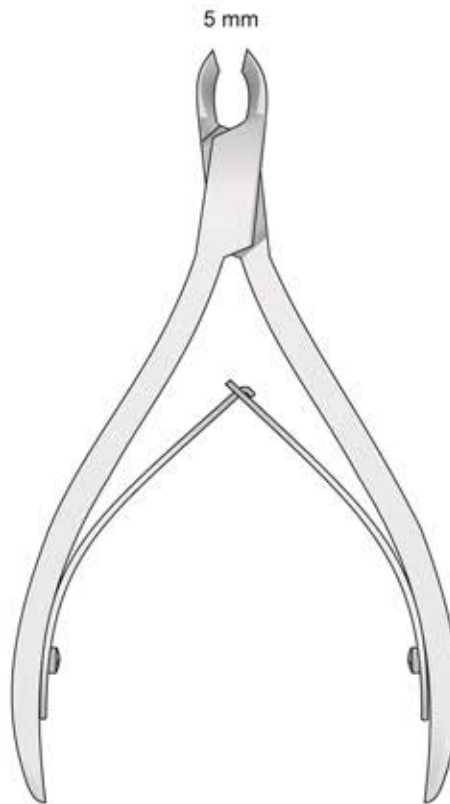

GS-45
110 mm

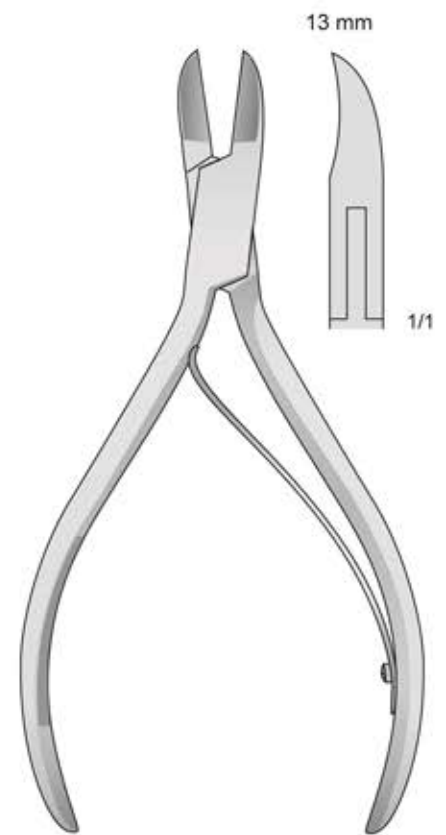

GS-21
120 mm

Nagelzangen

Nail Nippers

Tronchesi per unghie

Pinzas para cortar uñas

Pinces pour couper ongles

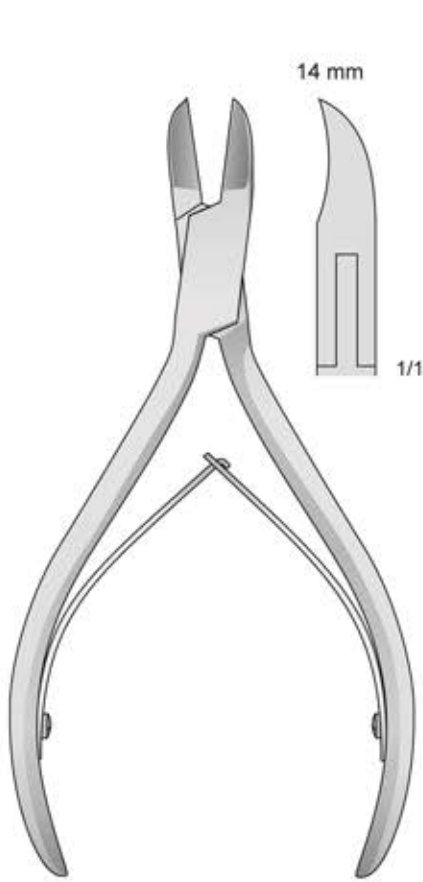

GS-32
120 mm

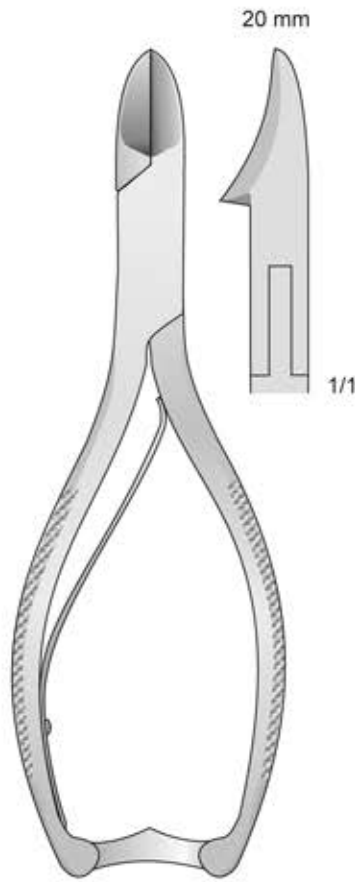

GS-20
135 mm

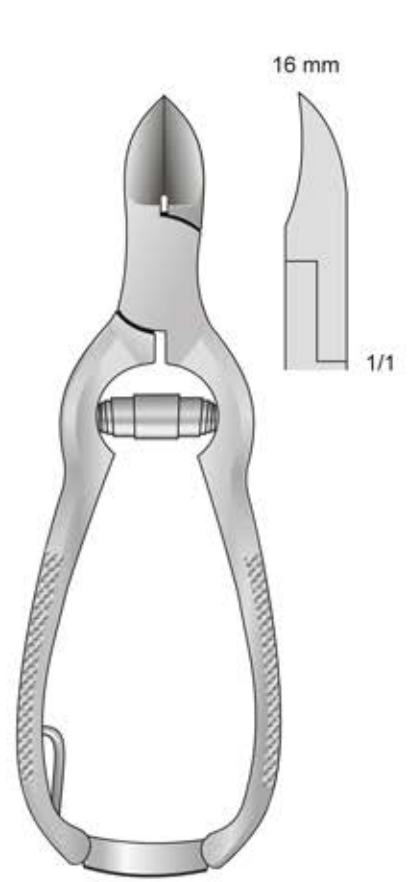

GS-46
120 mm

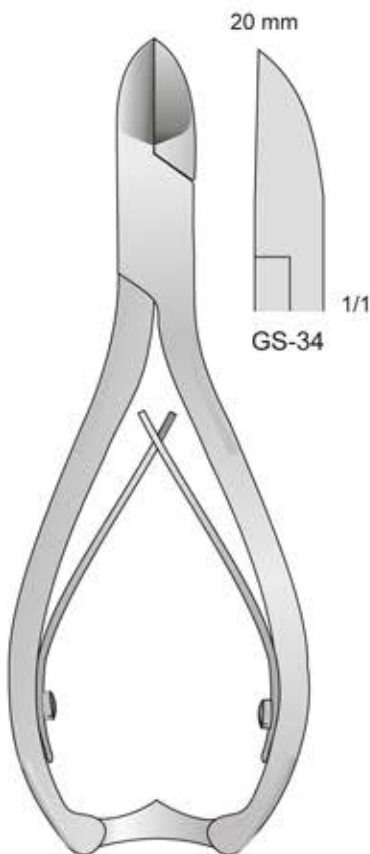

GS-34/GS-35
140 mm

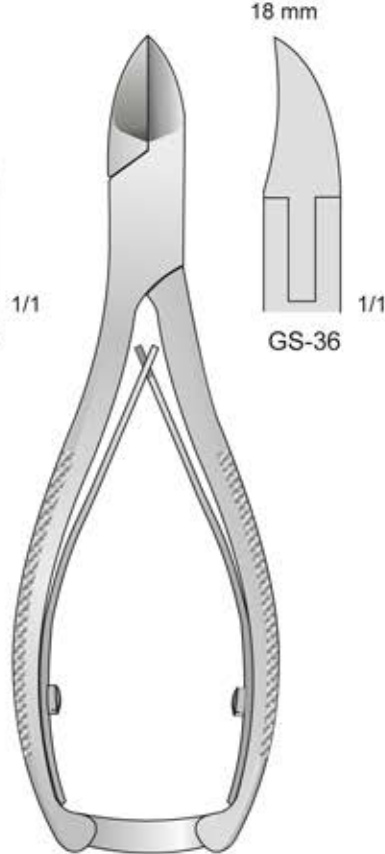
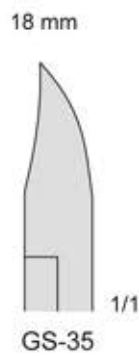

GS-36/GS-48
140 mm

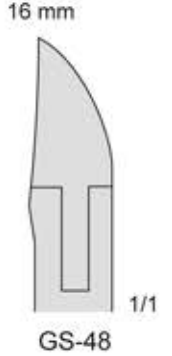
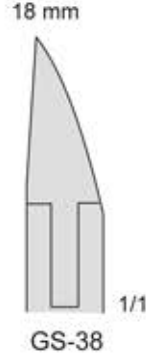
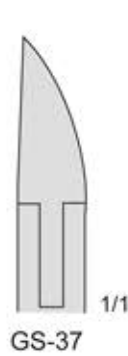
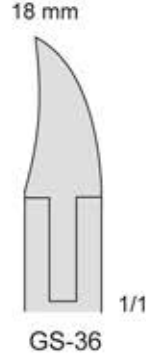

Eckenzangen
Fusspflege Instrumente

Nail corner forceps
Chiropody instruments

Tronchesi per unghie
Strumenti per pedicure

Corta uñas
Instrumentos para pedicure

Pinces à ongles
Instruments pour pedicure

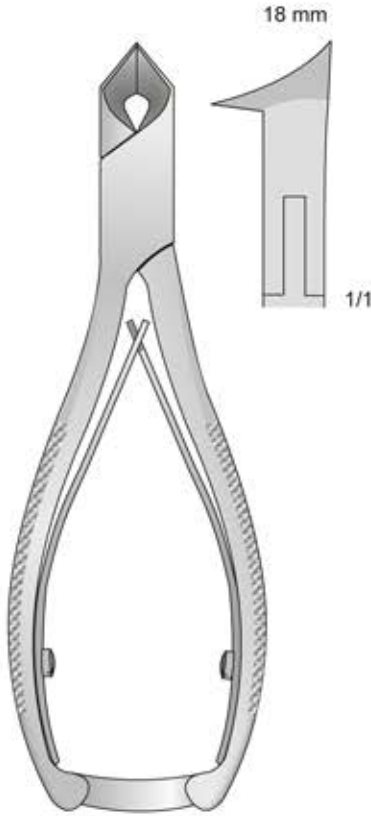

GS-50
135 mm

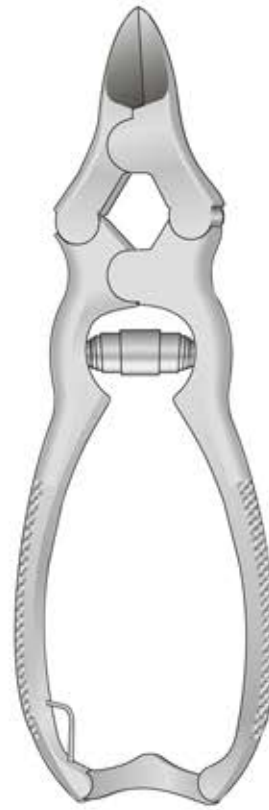

GS-19/GS-22
155 mm

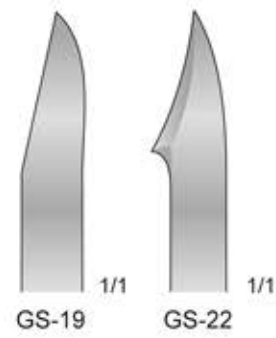

GS-19
1/1

GS-22
1/1

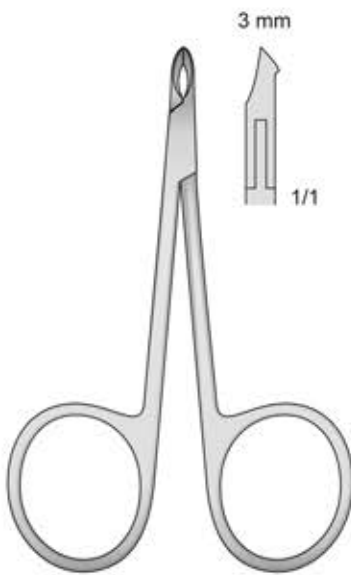

GS-40
85 mm



WARWICK-JAMES
DL-20
155 mm

Instrumente für eingewachsene Nägel
Forceps for ingrown nails
Strumento per unghie incarnite
Instrumento para cortar uñas
Pince pour fendre les ongles incarnés

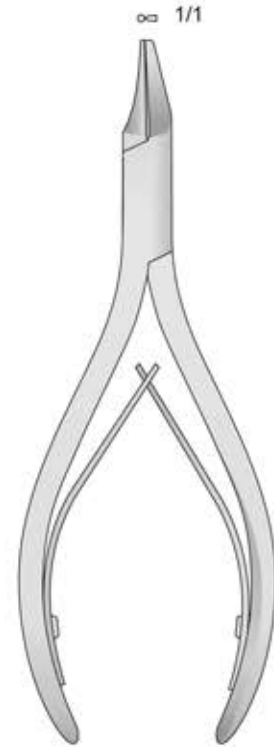

DP-09
135 mm



Wasserlösliche Schmiermittel von chirurgische Instrumenten
 Lubrificant Oil for surgical instruments
 Olio lubrificante per strumenti chirurgici
 Lubrificante para instrumentos
 Entretien pour instruments

RODHOIL

Schmiermittel mit hoher Dichte. Es sichert den perfekten Gebrauch und die Leichtgängigkeit aller chirurgischen Instrumente. Man gibt es auf die Verbindungen und Gelenke und in alle beweglichen Teile, die Reibungen unterworfen sind.

RODHOIL

Lubricant to high density. It assures the perfect utility and fluency of all the surgical instruments. For apply in to loosens, join and in all the parts in subject movement subject to attrition.

RODHOIL

Lubrificante ad alta densità. Assicura la perfetta funzionalità e scorrevolezza di tutti gli strumenti chirurgici. Da applicare negli snodi, giunture e in tutte le parti in movimento soggette ad attrito.



DB-OLR
50 cc

Das wasserlösliche Schmiermittel verlängert die Lebensdauer von chirurgische Instrumenten
 Soluble lubricant extends useful life of surgical instruments
 Lubrificante anticorrosivo e detergente per strumenti chirurgici
 Lubrificante soluble en agua, so uso prolonga la duraciòn de los instrumentos quirùrgicos
 Lubrifiant soluble dans l'eau prolonge la vie des instruments chirurgicaux

CLEANLACT

Reinigungskonzentrat für chirurgische Instrumente. Es wirkt antibakteriell, nicht-ätzend und schmierig. Es garantiert die perfekte Erhaltung aller Instrumente aus Stahl, entfernt eventuelle Flecken, Ränder, und Bräunungen von Sterilisationen, Desinfektionen und Reinigungen mit hartem Wasser. Es sollte regelmäßig verwendet werden.

CLEANLACT

Product concentrated for surgical instruments. It explains an action anti-corrosive, antibacterium and lubricant. It guarantees the perfect maintenance of all the instruments in steel eliminating eventual stains and burnishes to sterilization, disinfection and to washings with hard waters. It used periodically.

CLEANLACT

Prodotto concentrato per strumenti chirurgici. Esplica un azione anticorrosiva batteriostatica e lubrificante. Garantisce il perfetto mantenimento di tutti gli strumenti in acciaio eliminando eventuali macchie, aloni e bruniture dovute a sterilizzazioni, disinfezioni e a lavaggi con acque dure. Va usato periodicamente.



DB-50M
500 cc

DB-1L
1000 cc

Schleifsteine - Sharpening stones
Pietre di Arkansas per affilatura strumenti
Materiales para afilar - Pierres d'affutage

Schleifstein-Öl
Oil for grinding stones
Olio per affilatura strumenti
Huile d'affutage



DB-299
ARKANSAS
conica n° 299



DB-OL
30 cc



DB-96
ARKANSAS
n° 8



DB-6A
ARKANSAS
n° 6A



DB-4
ARKANSAS
n° 4



DB-22A
ARKANSAS

Gefäße aus Edelstahl

Stainless Steel
Receptacles

Recipienti in acciaio
inossidabile

Recipientes de acero
inoxidable

Réceptientes en acier
inoxydable



CS-51 Ø 50 mm h 100 mm
CS-52 Ø 50 mm h 150 mm
CS-55 Ø 80 mm h 180 mm

Runder Sterilbehälter mit Ausguss
Lotion bowls capsules
Capsule inox con fondo piano e becco
Cubetas de acero inoxidable
Cuvettes de acier inoxydable



CS-01 Ø 40 mm 15 cc
CS-02 Ø 60 mm 75 cc
CS-03 Ø 80 mm 225 cc
CS-04 Ø 100 mm 325 cc
CS-05 Ø 120 mm 500 cc
CS-06 Ø 150 mm 600 cc



CS-80 Ø 180 mm 1000 cc
CS-81 Ø 200 mm 1450 cc
CS-82 Ø 220 mm 2000 cc
CS-83 Ø 240 mm 3300 cc

Nierenschalen
Kidney bowls
Bacinelle reniformi
Riñoneras
Bassins réniformes



BR-20 200 mm
BR-25 250 mm
BR-28 280 mm

Schalen
Trays
Vassoi porta-strumenti
Bandejas
Bassins



VS-20 210 x 110 x 25 mm
VS-26 250 x 180 x 30 mm
VS-30 300 x 220 x 30 mm

Gefäße aus Edelstahl

Stainless Steel
Cassettes

Recipienti in acciaio
inossidabile

Recipientes de acero
inoxidable

Réipientes en acier
inoxydable

Nadelkassetten
Needle Cases
Scatole per aghi
Estuches para agujas
Boîtes pour aiguilles

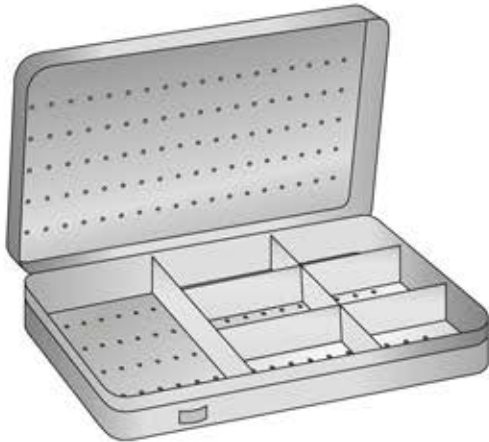

BS-27
150 x 90 x 20 mm

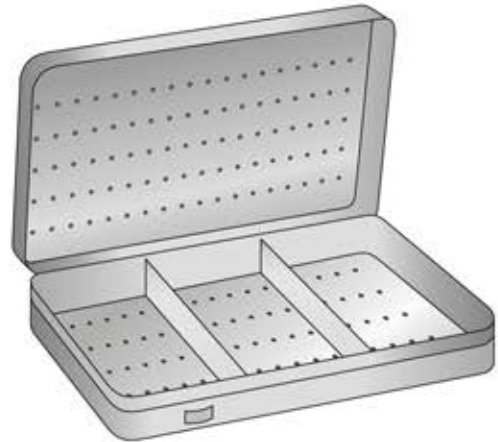

BS-23
150 x 90 x 20 mm

Deckel und Boden perforiert
Perforated lid and bottom
Coperchio e base perforati
Tapa y fondo perforado
Couvercle et fond perforé

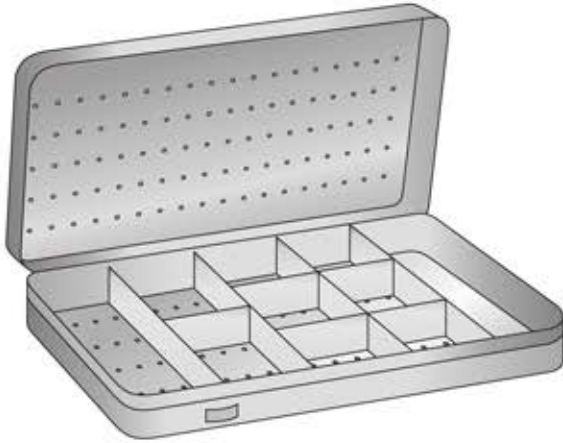

BS-28
220 x 120 x 20 mm

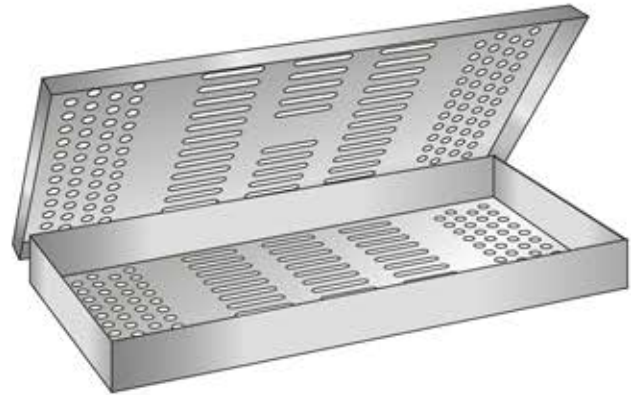

BS-41
275 x 130 x 25 mm

Mit 2 Sterilisiergestelle
With 2 Sterilizing Racks
Con 2 Supporti per sterilizzazione
Con 2 Bastidores para esterilización
Avec 2 Cadres de stérilisation

Mit Sterilisiergestelle und Trenneinteilung
With Sterilizing Rack and Compartments
Con Supporto per sterilizzazione e scomparti
Con Cuadro de esterilización y compartimentos
Avec Cadre de stérilisation et compartimentée

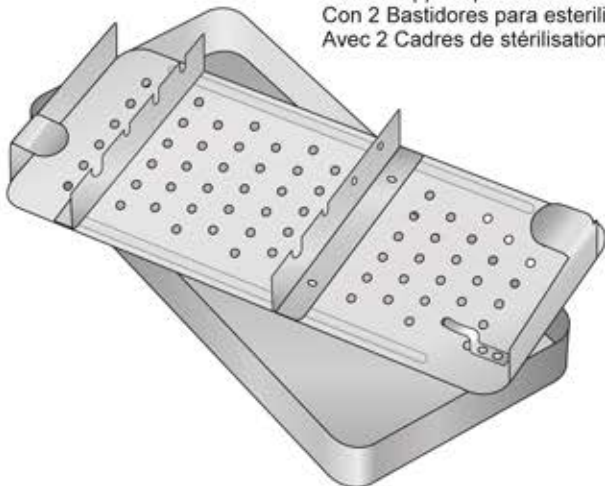

BS-30 180 x 90 x 35 mm

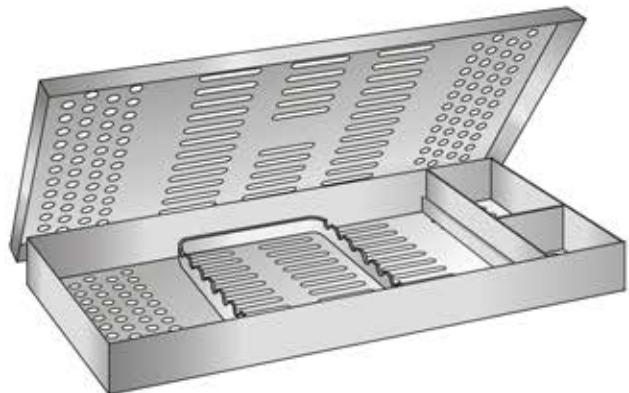

BS-40 275 x 130 x 25 mm
BS-42 285 x 190 x 25 mm

Gefäße aus Edelstahl

Stainless Steel
Cassettes

Recipienti in acciaio
inossidabile

Recipientes de acero
inoxidable

Réceptacles en acier
inoxydable

Tray Inox mit Silikoneinrichtung - Stainless Steel Cassettes with Silicone Racks
Tray Inox con griglia in silicone - Recipientes de acero con equipo de silicona
Cassettes en acier avec aménagement en silicone

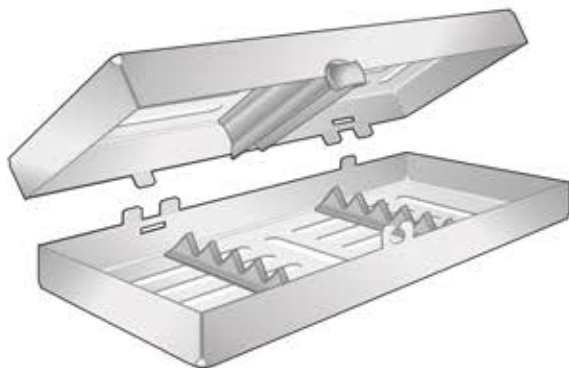

BS-59 Für 5 Instrumente
185 x 75 x 35 mm For 5 Instruments
Per 5 strumenti
Para 5 instrumentos
Pour 5 instruments

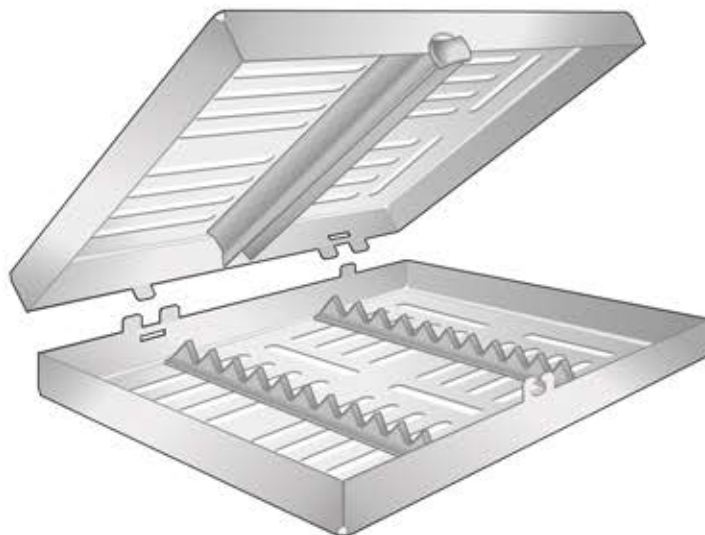

BS-60 Für 10 Instrumente
185 x 135 x 35 mm For 10 Instruments
Per 10 strumenti
Para 10 instrumentos
Pour 10 instruments

BS-61 Für 20 Instrumente
290 x 185 x 35 mm For 20 Instruments
Per 20 strumenti
Para 20 instrumentos
Pour 20 instruments

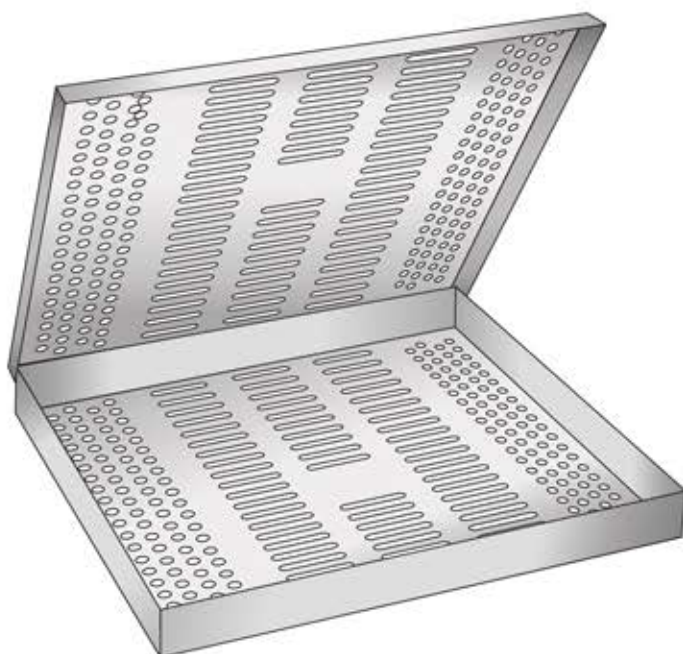

BS-43
285 x 190 x 25 mm

Instrumentenkästen
Instrument Boxes
Cestelli rettangolari
Cajas para instrumentos
Panier rectangulaire

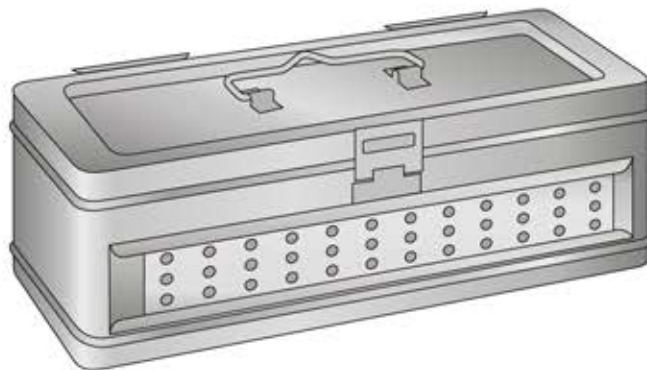

CS-32 300 x 150 x 60 mm
CS-33 300 x 150 x 90 mm
CS-34 300 x 150 x 180 mm

Sterilisierbar - Autoclavable
Autoclavabili - Esterilizabile
Stérilisable

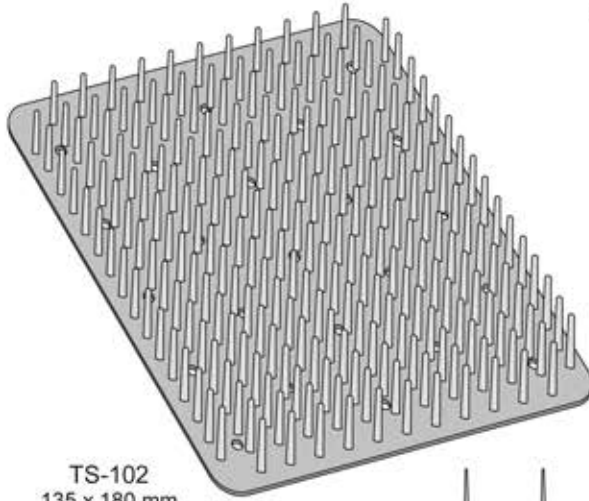

TS-102
135 x 180 mm

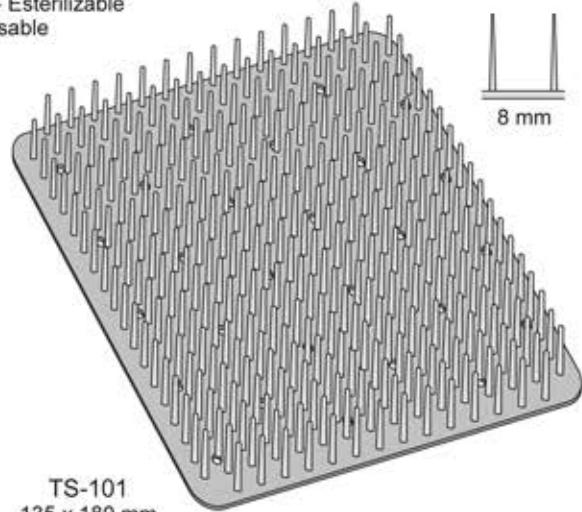
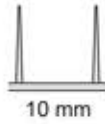

TS-101
135 x 180 mm



Silikon Matten
Matte en silicone
Tappeti in aghi di silicone
Tapete en agujas de silicona
Tapis en Silicone

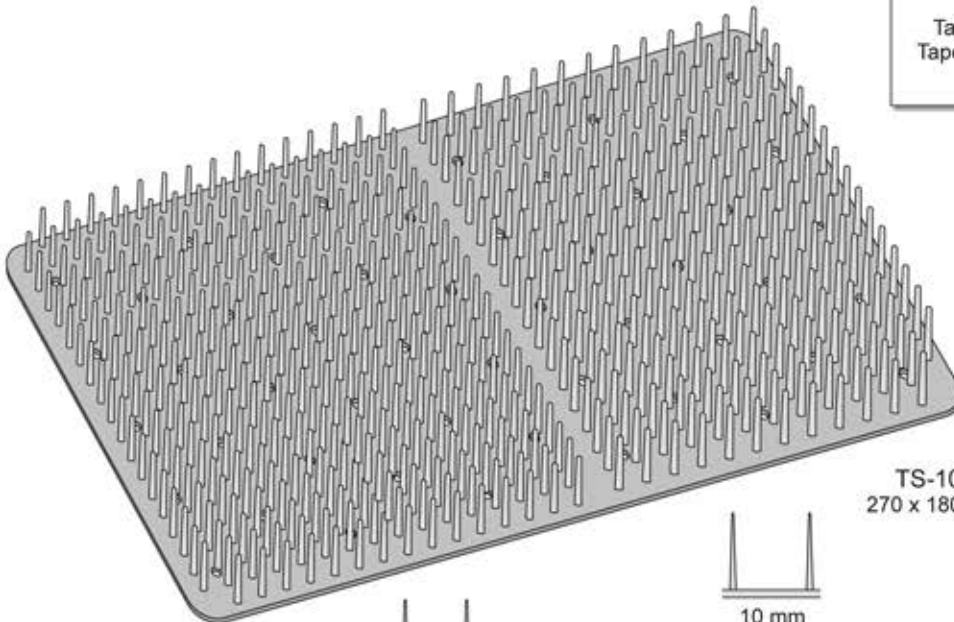

TS-104
270 x 180 mm

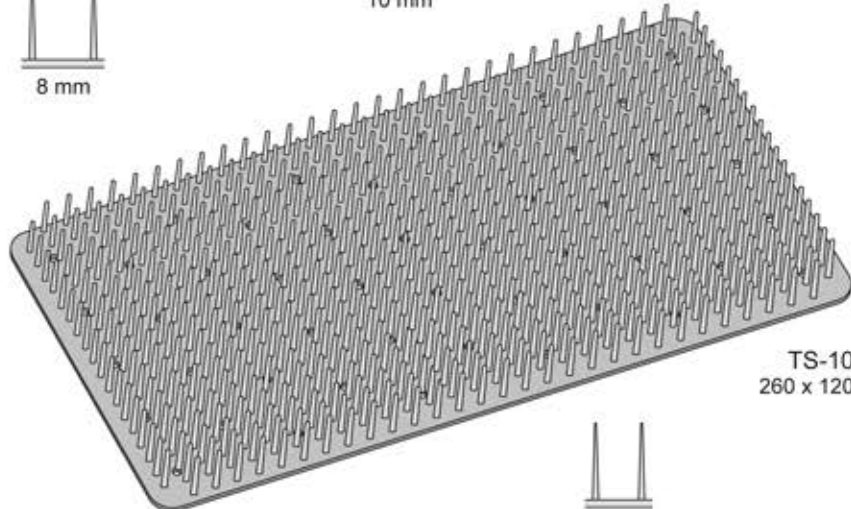
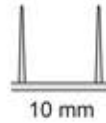

TS-103
260 x 120 mm



Sterilisierzangen

Sterilizing forceps

Pinze per sterilizzazione

Pinzas para
esterilizaci3n

Pinces 3 st6rilisation

Sterilisierzangen zum Fassen und Halten Steriler Instrumente
Sterilizing forceps for picking up and holding of sterile instruments
Pinze per prelevare strumenti sterilizzati
Pinzas para esterilizaci3n
Pinces pour saisir les objets st6rilis6s



GS-02
145 mm



DAVIS
GS-03
160 mm



DAVIS
GS-04
200 mm

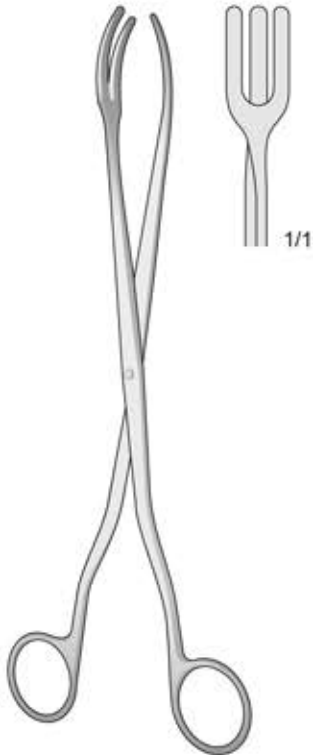

GS-10
200 mm

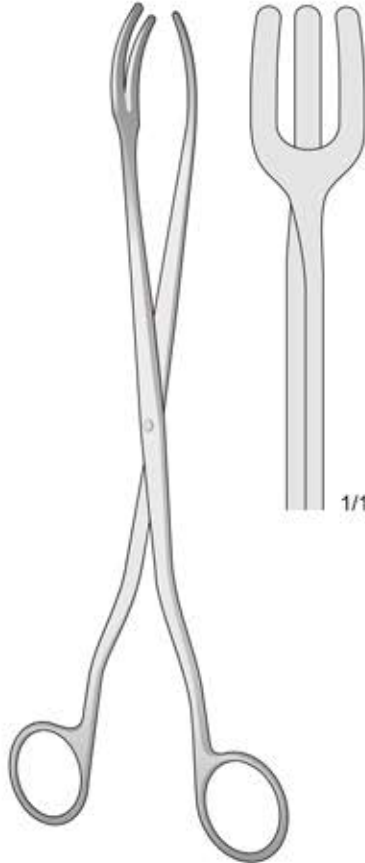

GS-11
300 mm

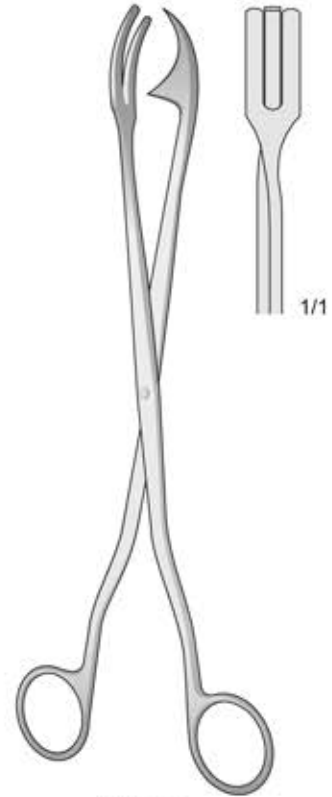

ROGGE
GS-06
230 mm

Sterilisierzangen

Sterilizing forceps

Pinze per sterilizzazione

Pinzas para
esterilizaci3n

Pinces 3 st3rilisation

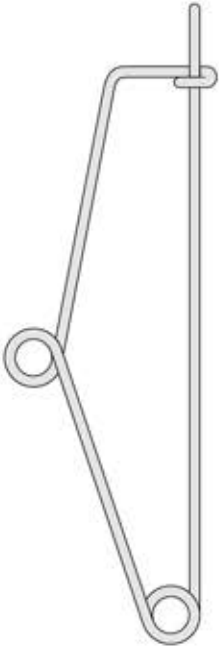

MAYO
GS-01
140 mm

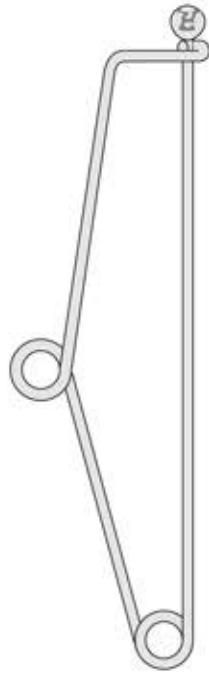

MAYO
GS-07
140 mm



BUNT
GS-09
110 mm

Sterilisierzangen zum Fassen und
Halten Steriler Instrumente
Sterilizing forceps for picking
up and holding of sterile instruments
Pinze per prelevare strumenti sterilizzati
Pinzas para esterilizaci3n
Pinces pour instruments st3rilis3s

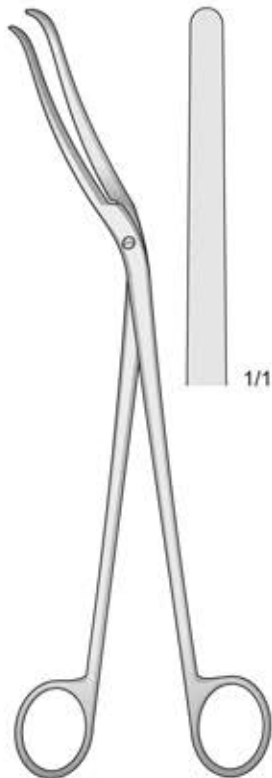

CHEATTLE
GS-05
265 mm

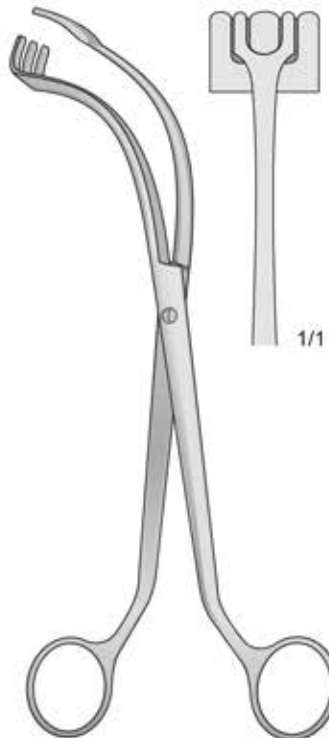

COLLIN
GS-30
250 mm

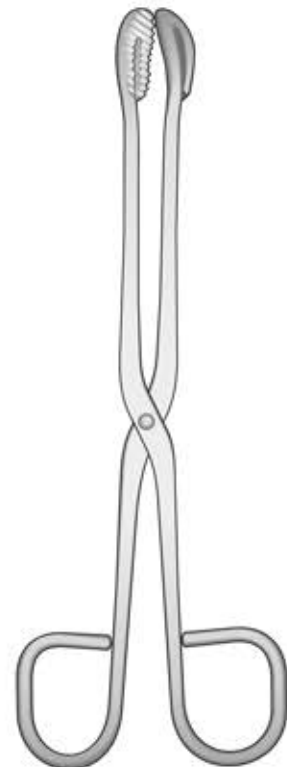

GS-13 200 mm
GS-14 300 mm

A

ADSON, Absaugkanülen	293
- Wundhaken	193
- Raspatorien	218
- Chirurgische Pinzetten	87, 88, 101, 104
ADSON-BROWN, Chirurgische Pinzetten	87, 88
ALDERDYCE, Raspatorien	209
ALLIS, Gewebe Fasszange	110
ALM, Wundspreizer	191
Mundsperrerr	165 - 168
ARKANSAS, Schleifesteine	310
ARRUGA, Nadelhalter	154
ASCH, Rhinologie	282
AUFRIECHT, Wundspreizer	170, 197
- Knochenfeilen	257
AUFRIECHT-WALTER, Wundspreizer	170
AUSTIN, Chirurgische Pinzetten	86
AXENFELD, Wundspreizer	176
AYERS, Mikro Pinzetten	99

B

BABBUSH, Elevators	209
BABY-ADSON, Arterienklemmen und Ligaturklemmen	127
BABY-ALLIS, Gewebe Fasszange	110
BABY-CRILE, Arterienklemmen	120
BABY-CRILE-WOOD, Nadelhalter	147
BABY-METZENBAUM, Feine Scheren	34
BABY-MIXTER, Arterienklemmen und Ligaturklemmen	127
BACKHAUS, Tuchklemmen	112
BALLENGER, Osteotome	225
- Skalpelle	12
- Rhinologie	238
BALLENGER-HAYEK, Raspatorien	211
BARON, Absaugkanülen	291
BARRAQUER, Wundhaken	174
- Mikro Nadelhalter	134, 136
- Cilienpinzetten	106
BARTH, Sharfe Löffel	261
BEASLEY-BACOCK, Chirurgische Pinzetten	87
BEAUPRE, Cilienpinzetten	106
BECKMANN, Nasen Spekula	200
BEER, Cilienpinzetten	106
BELLUCCI, Absaugkanülen	291
- Mikro Ohrzängchen	158
BENGOLEA, Arterienklemmen	126
BERGMANN, Chirurgische Hämmer	249
BEYER, Hohlmeißelzange	273
BIEMER, Approximatoren	157
- Gefäß Clips	155
BIEMER-MÜLLER, Approximatoren	157
BIRCHER-GANSKE, Hohlmeißelzange	276
BIRKETT, Arterienklemmen	126
BIRO, Feine Scheren	22
BISHOP-HARMON, Mikro Pinzetten	100
Skalpelle	6 - 12
BLUMENTHAL, Hohlmeißelzange	270
BÖHLER, Hohlmeißelzange	275
BOIES, Rhinologie	283
BONN, Mikro Pinzetten	100
BONNEY, Chirurgische Pinzetten	102
BOYNTON, Nadelhalter	154
BOWMANN, Sonden	160
BRAUN, Arterienklemmen	114
BROCK, Mikro Scheren	17
- Mikro Pinzetten	81
- Mikro Nadelhalter	133
BRÜNING, Skalpelle	12
BRUNS, Sharfe Löffel	264
BUCKLEY, Osteotome	224
BUNT, Sterilisierzange	316

C

Absaugkanülen	287 - 302
---------------	-----------

CAPLAN, Knochensplitterscheren	47
- Rhinologie	283
CARTER, Raspatorien	212
CASPAR, Scalpellgriffe	9
CASTROVIEJO, Mikro Nadelhalter	136, 137
- Nadelhalter	138, 140
- Meßinstrumente	4
CHADWICK, Feine Scheren	22
CHEATTLE, Sterilisierzange	316
CINELLI, Feine Scheren	34
- Rhinologie	233
COLLIN, Sterilisierzange	316
CONVERSE, Skalpelle	11
- Wundspreizer	172
- Knochenfeilen	254
- Nadelhalter	145
CONWAY, Wundspreizer	179
CORN, Chirurgische Pinzetten	86
CORONAL, Wundspreizer	190
COTTLE, Skalpelle	11
- Wundspreizer	172, 175, 177, 179
- Chirurgische Scheren	23, 46, 64
- Knochenfeilen	257
- Chirurgische Hämmer	249
- Mikro Pinzetten	99
- Osteotome	230, 236, 237
- Raspatorien	210, 211, 212
- Rhinologie	201
- Knorpelquetsche	175
COTTLE-KNAPP, Feine Scissors	24
COTTLE-MASING, Feine Scissors	22
COTTLE-NEIVERT, Wundspreizer	175
COTTLE-WALSHAM, Rhinologie	282
CRAIG, Rhinologie	283
CRILE, Arterienklemmen	119, 120
CRILE-MURRAY, Nadelhalter	141
CRILE-WOOD, Nadelhalter	141, 147, 153
Sharfe Löffel	261 - 265
CUSHING, Wundspreizer	178, 181, 182
- Periostotome	218
- Chirurgische Pinzetten	93, 102
CUSHING-KOCHER, Wundspreizer	182

D

DANDY, Arterienklemmen	119
DAVIS, Wundhaken	206
- Sterilisierzange	315
DAVIS-BOYLE, Mundsperrerr	166
DEAN, Chirurgische Scheren	45
DEAVER, Chirurgische Scheren	32
- Wundhaken	184
DERF, Nadelhalter	141, 145
DESMARRES, Wundhaken	179
- Wundhaken Isoliert	130
- Mikro Pinzetten	99
DE BAKEY, Atraumatische Pinzetten	96, 97, 98
- Chirurgische Pinzetten	103
- Nadelhalter	150
DE MARTEL, Feine Arterienklemmen	111
DIEFFENBACH, Gefäßclips	155
DIETRICH, Nadelhalter	138
DINGMANN, Mundsperrerr	167
- Hohlmeißelzange	276
- Knochenfeilen	256
Dissektoren	205 - 208
Wundhaken	172 - 197
DIXON-LOVELACE, Arterienklemmen	126
DUNN-DAUTREY, Wundhaken	171
DUPLAY, Nasen Spekula	3

E

ELSCHNIG, Chirurgische Pinzetten	100
EPKER, Osteotome	235

F

FACE-LIFT, Chirurgische Scheren	67, 69
- Wellenschliff Scheren	70
FAGER, Dissektoren - Separatores	206
FARABEUF, Wundhaken	180
- Periostotome	219
FARABEUF-COLLIN, Raspatorien	219
FAULKNER, Rhinologie	232
FAURE, Tuchklemmen	112
FEICHENFELD, Splitterpinzetten	106
FERGUSSON, Absaugkanülen	290
FERRIS-SMITH-CUSHING, Knochensplitterscheren	274
FINSEN, Wundhaken	191
FOERSTER-BALLENGER, Tamponzangen	115
FOMON, Skalpelle	11
- Wundhaken	175
- Chirurgische Scheren	45, 46, 64
- Feine Scheren	34
- Knochenfeilen	255, 259
- Periostotome	213
- Rhinologie	233
Scheren	15 - 75
FOSTER-GILLIES, Nadelhalter	144
FOX, Scharfe Löffel	263
FRAZIER, Absaugkanülen	290, 293
FREEMAN, Wundhaken	190
- Chirurgische Scheren	66, 71
- Wellenschliff Scheren	72
FREEMAN-GORNEY, Chirurgische Scheren	66, 71
FREEMAN-KAYE, Chirurgische Scheren	66, 67, 73
FREER, Osteotome	223
- Skalpelle	12
- Mikro Wundhaken	175
- Periostotome	209, 212, 213, 216
FRIEDMANN, Hohlmeißelzangen	270, 271

G

GALLAHER, Knochenfeilen	256
GEMINI, Arterienklemmen	129
GERALD, Chirurgische Pinzetten	95, 104
GERALD-BROWN, Chirurgische Pinzetten	95
GIDEF, Feine Arterienklemmen	118
GIESSEN, Wundhaken	180
GILLIES, Mikro Wundhaken	173
- Atraumatische Pinzetten	98
- Nadelhalter	144, 148
GIUNTA-NASAL, Wellenschliff Scheren	70
GLASSMAN, Chirurgische Scheren	27
GOLDMANN, Rhinologie	283
GOLDMAN-FOX, Chirurgische Scheren	25, 49, 53
- Feine Scheren	25
GOOD, Tonsillenschere	43
GORNEY, Absaugkanülen	289
- Wundhaken	190
- Chirurgische Scheren	43, 73
- Hohlmeißelzange	47
- Wellenschliff Scheren	67, 68, 70, 72
GRAEFE, Feine Scheren	22
- Mikro Pinzetten	99
- Chirurgischen Pinzetten	86, 100
GREEN, Mikro Pinzetten	99
GREENBERG-PAR, Nasal Scheren	48, 54
GREGORY, Chirurgische Scheren	69
GROSS, Tamponzange	115
GRUENWALD, Chirurgische Pinzetten	105
GUILLIEN, Absaugkanülen	289
GUTHRIE, Mikro Wundhaken	173, 174

H

HABERER, Wundhaken	168
HALSEY, Nadelhalter	141, 145
HALSTED, Arterienklemmen	120
- Feine Arterienklemmen	118

HALSTED-MOSQUITO, Arterienklemmen	120
- Feine Arterienklemmen	117
HARRINGTON, Wundhaken	185
HARTMANN, Zungendrucker	169
- Absaugkanülen	294
- Rhinologie	198, 199
- Spekula für Erwachsene	3
HARTMANN-BABY-MOSQUITO, Feine Arterienklemmen	117
HEANEY(HEGAR), Nadelhalter	142
HEGAR, Nadelhalter	142, 146
HEGAR-MAYO-STILLE, Nadelhalter	153
HEISS, Arterienklemmen	126
HENAHAN, Periostotome	218
HEYMANN, Chirurgische Scheren	46
HEYMANN-KNIGHT, Chirurgische Scheren	45
HOUSE, Absaugkanülen	292
- Wundhaken	178
HOWARD, Knochenfeilen	253
HOWARTH, Periostotome	211
HUNT, Mikro Pinzetten	99
HUNTER, Splitterpinzetten	106

I

IRIS, Chirurgische Scheren	50, 53
- Feine Scheren	20
- Links Scheren	52
- Wellenschliff Scheren	65

J

JACOBSON, Sharfe Löffel	261
- Mikro Scheren	16
- Mikro Nadelhalter	135
- Nadelhalter	139
JACOBSON-MICRO, Feine Arterienklemmen	111
JAEGER, Mikro Wundhaken	174
JAMESON, Chirurgische Scheren	23
JAMESON-WERBER, Chirurgische Scheren	23
JANSEN, Sharfe Löffel	261
- Hohlmeißelzange	272
- Chirurgische Pinzetten	105
- Raspatorien	219
JONES, Tuchklemmen	112, 114
JOSEPH, Skalpelle	11, 12
- Wundhaken	175
- Chirurgische Scheren	33, 64
- Knochenfeilen	256
- Periostotome	212, 213, 218
- Rhinologie	258

K

KAHN, Chirurgische Scheren	44
KAYE, Feine Scheren	19
KAYE-FACE-LIFT, Chirurgische Scheren	71
KELLY, Chirurgische Scheren	28, 54
- Arterienklemmen	123
KERPEL, Sharfe Löffel	263
KERSCHNER, Mikro Wundhaken	173
KEYES, Rhinologie	263
KILLIAN, Osteotome	225
- Absaugkanülen	295
- Periostotome	211
- Rhinologie	198, 199, 283
KILLIAN-KLAUS, Osteotome	225
KILNER, Wundhaken	172
- Chirurgische Scheren	23, 27, 48, 54
- Wellenschliff Scheren	70
KILNER-DOUGHTY, Mundsperrer	165
KIRBY, Wundhaken	175, 179
KLAR-EVATEUR, Wundhaken	179
KLEINERT-KUTZ, Hohlmeißelzange	273
KNAPP, Mikro Wundhaken	174
KOCHER, Wundhaken	182
- Arterienklemmen	121, 123, 125

Alphabetisches Inhaltsverzeichnis	Alphabetical index	Indice alfabetico
KOCHER-OCHSNER, Arterienklemmen		122
KÖNIG, Elevatorien		205
KRESSNER, Rhinologie		282
KUHNT, Chirurgische Pinzetten		100

L

LA GRANGE, Feine Scheren		25, 49
LAMBERT, Mikro Pinzetten		99
LAMBOTTE, Periostotome - Raspatorien		242
LANGENBECK, Periostotome		209, 219
Laryngoskope		3
LEMPERT, Hohlmeißelzange		271
LERICHE, Arterienklemmen		119
LEXER, Osteotome		245
- Chirurgische Scheren		41, 62
LEWIS, Knochenfeilen		257
LICHTENBERG, Nadelhalter		154
LIEBERMANN-TENNANT, Mikro Wundhaken		173
Knochenfeilen		253 - 260
LISTER, Arterienklemmen		114
LISTON, Hohlmeißelzange		275
LITTAUER, Cilienpinzetten		106
LITTLER, Feine Scheren		34
LOCKLIN, Chirurgische Scheren		24, 28
LOCKLIN MOD., Chirurgische Scheren		24
LOGAN, Wundhaken		191
LORNA, Tuchklemmen		113
LOVE, Wundhaken		178
LUCAE, Chirurgische Hämmer		248
- Chirurgische Pinzetten		105
LUENEBURG, Elevatorien		205
LUER, Wundhaken		178
- Hohlmeißelzange		272

M

MacCOLLUM-DINGMAN, Dissektorien		189
MAGILL, Absaugkanülen		295
MAIER, Tamponzange		116
MALINIAC, Wundhaken		197
MALTZ, Skalpelle		12
- Knochenfeilen		259
- Rhinologie		260
MARTINI, Sharfe Löffel		261
Chirurgische Hämmer		249 - 250
MASING, Skalpelle		12
- Periostotome		210, 212
- Rhinologie		233
MATHIEU, Nadelhalter		154
MAYO, Chirurgische Scheren		39, 40, 51, 63
- Sterilisierzange		316
MAYO-HEGAR, Nadelhalter		142, 146
MAYO-HEGAR-FINO, Nadelhalter		147
MAYO-HEGAR-HEANEY, Nadelhalter		146
MAYO-LEXER, Chirurgische Scheren		63
MAYO-NOBLE, Chirurgische Scheren		39
MAYO-STILLE, Chirurgische Scheren		42, 62
MC DONALD, Periostotome		216
MC INDOE, Rhinologie		232
- Atraumatische Pinzetten		98
MC INTOSH, Set Laryngoskope		3
MC IVOR, Mundsperrerr		166
MC KENTY, Periostotome		211, 213
MC PHERSON, Chirurgische Pinzetten		100
MEAD, Chirurgische Hämmer		248
- Periostotome		209
- Hohlmeißelzange		270
MEDHORN, Gefäßclips		155
METZENBAUM, Chirurgische Scheren		33, 35, 36, 48, 50, 58
- Wellenschliff Scheren		65
METZENBAUM-FINO, Chirurgische Scheren		35, 36, 53, 59, 60, 61
MICRO-HALSTED, Feine Arterienklemmen		117
MICRO-IRIS, Feine Scheren		20
MICRO-RYDER, Nadelhalter		151, 152
MICRO-VASCULAR, Nadelhalter		150
MILLARD, Wundhaken		172, 190

MILLER, Knochenfeilen		253
MILLIGAN, Dissektorien - Separatoren		206
MINI-FRIEDMANN, Hohlmeißelzange		269, 270
MINI-GILLIES, Nadelhalter		144, 148
MINI-LAMBOTTE, Osteotome		229
MINI-LEXER, Osteotome		244
MINI-MALTZ, Knochenfeilen		259
MINI-OLSEN-HEGAR, Nadelhalter		143
MINI-ROUX, Wundhaken		181
MOD. MARTIN, Watterträger		161
MODELL WIEN, Nasen Spekula		200
MOLT, Mundsperrerr		218
MÜLLER, Approximatoren		157

N

NEIVERT, Wundhaken		177
NELSON-METZENBAUM, Chirurgische Scheren		37
NEWS, Wundhaken		178
NOYES, Mikro Scheren		15
NUBOER, Absaugkanülen		288

O

OBWEGESER, Ligaturnadel		159
- Wundhaken		170, 183
- Osteotome		247
- Periostotome		215, 217
O'BRIEN, Ligatur Scheren		74
O'CONNOR, Mikro Wundhaken		174
OLIVECRONA, Dissektorien		207
- Hohlmeißelzange		272
OLSEN-HEGAR, Nadelhalter		143, 149
OMBREDANNE, Chirurgische Hämmer		249
Osteotome		223 - 248
ORINGER, Mundsperrerr		169
OVERHOLT, Arterienklemmen		128
OVERHOLT-GEISSENDORFER, Arterienklemmen		128

P

PARKER-LANGENBECK, Wundhaken		180
PAR-TYPE, Chirurgische Scheren		54
PARTSCH, Osteotome - Hohlmeißel		227, 228
PAPAVERO-HARTMANN, Rhinologie		201
PAUL, Wundhaken		176
PEAN, Arterienklemmen		121, 124
- Feine Arterienklemmen		118
PEAN-MURPHY, Arterienklemmen		114
PECK-JOSEPH, Chirurgische Scheren		53
PEET, Feine Arterienklemmen		111
PENFIELD, Wundhaken		208
PENNINGTON, Periostotome		211
Periostotome		209 - 219
PERRY, Chirurgische Pinzetten		85
PIERCE, Periostotome		211
Arterienklemmen		109 - 130
Pinzetten		79 - 106
PITANGUI, Markator		109
PLESTER, Absaugkanülen		290
- Wundhaken		194
Nadelhalter		133 - 154
POTTS-SMITH, Chirurgische Pinzetten		92, 102
POTTS-YASARGIL, Mikro Scheren		16

Q

QUINBY, Feine Scheren		22
QUINKE, Nadel für Biopsie		303

R

RADOLF, Handchirurgie		280
RAGNELL, Wundhaken		180

- Mikro Feine Scheren	19
RAGNELL-DAVIS, Wundhaken	180
RAMPLEY, Tamponzange	116
RANKIN, Arterienklemmen	123
REYNOLDS, Feine Scheren	26
Rhinologie	198 - 201
ROCHESTER-PEAN, Arterienklemmen	122, 129
ROGER, Periostotome	211
ROGGE, Sterilisierzange	315
ROLLET, Mikro Wundhaken	174
ROWE, Knochen Chirurgie	281
ROSE, Wundhaken	178
ROSTKOWSKI, Wundhaken	179
ROUX, Wundhaken	181
ROUX-MAGNUS, Wundhaken	181
RUBIN, Rhinologie	234, 282
RUSKIN, Hohlmeißelzange	273
RUSKIN-LISTON, Hohlmeißelzange	275
RUSKIN-STILLE, Hohlmeißelzange	273
RYDER, Nadelhalter	152

S

SAALFELD, Sharfe Löffel	262
SACHS, Dissektoren - Separatoren	206
SALZBURG, Periostotome	210
SAROT, Nadelhalter	149
SAUG-RASPATORIUM, Absaugkanülen	289
SCHAEDEL, Tuchklemmen	112
SCHEDE, Sharfe Löffel	264
SCHNEIDER, Periostotome	219
SCHNEIDER-SAUERBRUCH, Periostotome - Raspatorien	242
SCHWECKENDIEK, Tonsillenscheren	43
SCOVILLE, Wundhaken	182
SEDILLOT, Periostotome	214, 219
SEMKEN, Chirurgische Pinzetten	87, 92, 101
SENN-GREEN, Wundhaken	180
SENN-MILLER, Wundhaken	177
SEWALL, Periostotome	212
SHEA, Chirurgische Scheren	33
SHEEHAN, Osteotome	226
SILVER, Rhinologie	232
SIMON, Wundhaken	184
SPENCER, Ligaturscheren	74
STACKE, Sonden	160
STEINHÄUSER, Periostotome	217
STELLA, Chirurgische Scheren	68
STELLBRINK, Hohlmeißelzange	269, 271
STEVENS, Feine Scheren	19, 26, 48
STILLE, Chirurgische Scheren	42
- Anatomische Pinzetten	90
STITCH, Feine Scheren	19
Meßinstrumente	4 - 5
SWEDISH MOD., Nadelhalter	149

T

TAKAHASHI, Hohlmeißelzange	274
TAYLOR, Chirurgische Pinzetten	102
TENNANT, Chirurgische Pinzetten	100
TESSIER, Osteotome	239, 241
THOREK, Chirurgische Scheren	38
TIECK-HALLE, Nasen Spekula	200
TOBOLD, Zungendrucker	169
TOENNIS, Chirurgische Scheren	38
TOENNIS-ADSON, Chirurgische Scheren	38, 64
TROELTSCH, Chirurgische Pinzetten	105
TUFFIER, Wundhaken	168
TUOHY, Biopsie Kanülen	303

U

UNIVERSAL, Watterträger	161
UNNA, Sharfe Löffel	262

V

VANNAS, Mikro Scheren	15
VARADY, Haken Stripper	195
VERESS, Biopsie Nadel	303
VIDAL, Scharfe Löffel	263
VISE, Mikro Pinzetten	79
VOLKMANN, Sharfe Löffel	262, 265

W

WALTER, Osteotome	231
WALTON, Feine Scheren	19, 34
- Periostotome	213
WANGENSTEEN, Chirurgische Pinzetten	102
WARWICK-JAMES, Eckenzangen	306
WEBSTER, Nadelhalter	145
WEIL-BLAKESLEY, Hohlmeißelzange	274
WEITLANER, Wundhaken	192, 193
WERTHEIMER, Absaugkanülen	293
WEST, Osteotome - Hohlmeißel	228
WESTCOTT, Mikro Scheren	15
WHITEHEAD-JENNINGS, Mundsperrer	165
WIEDER, Zungencrücker	169
WIENER, Mikro Wundhaken	174
WILLIGER, Sharfe Löffel	261, 265
- Elevatoren	205
- Chirurgische Hammer	248
WILMER, Feine Scheren	22
WULLSTEIN, Wundhaken	192
- Mikro Ohrzängchen	158

Y

YANCOSKIE, Wundhaken	190
YANKAUER, Dissektoren	206
- Drahtumführungsnadel	159
YASARGIL, Mikro Scheren	16

Z

ZAUFAL-JANSEN, Hohlmeißelzangen	273
---------------------------------	-----

A

ADSON, Suctions tubes	293
- Retractor	193
- Periosteal	218
- Tissue Forceps	87, 88, 101, 104
ADSON-BROWN, Tissue Forceps	87, 88
ALDERDYCE, Periosteal	209
ALLIS, Gum and Tissue Forceps	110
ALM, Retractors	191
Mouth Gags	165 - 168
ARKANSAS, Accessories for re-sharpening	310
ARRUGA, Needle holders	154
ASCH, Rhinology	282
AUFRIEHT, Retractors	170, 197
- Bone files	257
AUFRIEHT-WALTER, Retractors	170
AUSTIN, Tissue Forceps	86
AXENFELD, Retractors	176
AYERS, Delicate Forceps	99

B

BABBUSH, Periosteal	209
BABY-ADSON, Hemostatic Forceps and Ligature	127
BABY-ALLIS, Gum and Tissue Forceps	110
BABY-CRILE, Hemostatic Forceps	120
BABY-CRILE-WOOD, Needle Holders	147
BABY-METZENBAUM, Delicate Scissors	34
BABY-MIXTER, Hemostatic Forceps and Ligature	127
BACKHAUS, Towel Clamps	112
BALLENGER, Osteotome	225
- Knives	12
- Rhinology	238
BALLENGER-HAYEK, Periosteal	211
BARON, Suction Tubes	291
BARRAQUER, Retractors	174
- Micro Needle Holders	134, 136
- Cilia Forceps	106
BARTH, Curettes	261
BEASLEY-BACOCK, Tissue Forceps	87
BEAUPRE, Cilia Forceps	106
BECKMANN, Nasal Specula	200
BEER, Cilia Forceps	106
BELLUCCI, Suction Tubes	291
- Micro Ear forceps	158
BENGOLEA, Hemostatic Forceps	126
BERGMANN, Surgical Mallets	249
BEYER, Bone cutting Forceps	273
BIEMER, Approssimator	157
- Vascular Clamps	155
BIEMER-MÜLLER, Approssimator	157
BIRCHER-GANSKE, Bone surgery	276
BIRKETT, Hemostatic Forceps	126
BIRO, Delicate Scissors	22
BISHOP-HARMON, Micro forceps	100
Knives	6 - 12
BLUMENTHAL, Bone cutting Forceps	270
BÖHLER, Bone cutting Forceps	275
BOIES, Rhinology	283
BONN, Micro Forceps	100
BONNEY, Tissue Forceps	102
BOYNTON, Needle Holders	154
BOWMANN, Probes	160
BRAUN, Hemostatic Forceps	114
BROCK, Micro Scissors	17
- Micro Forceps	81
- Micro Needle Holders	133
BRÜNINGS, Scalpel	12
BRUNS, Curettes	264
BUCKLEY, Osteotome	224
BUNT, Sterilizing Instruments	316

C

Suction tubes	287 - 302
---------------	-----------

CAPLAN, Bone Cutting Scissors	47
- Rhinology	283
CARTER, Periosteal	212
CASPAR, Scalpel handles	9
CASTROVIEJO, Micro Needle Holders	136, 137
- Needle Holders	138, 140
- Measuring Instruments	4
CHADWICK, Delicate Scissors	22
CHEATTLE, Sterilizing Instruments	316
CINELLI, Delicate Scissors	34
- Rhinology	233
COLLIN, Sterilizing Instruments	316
CONVERSE, Scalpel	11
- Retractors	172
- Bone Files	254
- Needle Holders	145
CONWAY, Retractors	179
CORN, Tissue Forceps	86
CORONAL, Retractor	190
COTTLE, Knives	11
- Retractors	172, 175, 177, 179
- Tissue Forceps	23, 46, 64
- Bone files	257
- Surgical Mallets	249
- Micro Forceps	99
- Osteotome	230, 236, 237
- Periosteal	210, 211, 212
- Rhinology	201
- Bone crusher	175
COTTLE-KNAPP, Delicate Scissors	24
COTTLE-MASING, Delicate Scissors	22
COTTLE-NEIVERT, Retractors	175
COTTLE-WALSHAM, Rhinology	282
CRAIG, Rhinology	283
CRILE, Hemostatic Forceps	119, 120
CRILE-MURRAY, Micro Needle Holders	141
CRILE-WOOD, Needle Holders	141, 147, 153
Curettes	261 - 265
CUSHING, Retractors	178, 181, 182
- Periosteal	218
- Tissue Forceps	93, 102
CUSHING-KOCHER, Retractors	182

D

DANDY, Operating Scissors	119
DAVIS, Retractors	206
- Sterilizing Instruments	315
DAVIS-BOYLE, Mouth gags	166
DEAN, Serrated Scissors	45
DEAVER, Operating Scissors	32
- Retractors	184
DERF, Needle Holders	141, 145
DESMARRES, Retractors	179
- Isolated Retractor	130
- Micro Forceps	99
DE BAKEY, Atraumatic Forceps	96, 97, 98
- Tissue Forceps	103
- Needle Holders	150
DE MARTEL, Delicate Hemostatic Forceps	111
DIEFFENBACH, Clamps	155
DIETRICH, Needle Holders	138
DINGMANN, Mouth gags	167
- Bone surgery	276
- Bone files	256
Dissector	205 - 208
Retractors	172 - 197
DIXON-LOVELACE, Hemostatic Forceps	126
DOCKHORN, Retractors	171
DUPLAY, Nasal specula	3

E

ELSCHNIG, Tissue Forceps	100
EPKER, Osteotome	235

F

FACE-LIFT, Operating Scissors	67, 69
- Wellenschliff Scissors	70
FAGER, Retractors	206
FARABEUF, Retractors	180
- Periosteal	219
FARABEUF-COLLIN, Raspatories	219
FAULKNER, Rhinology	232
FAURE, Towel Clamps	112
FEICHENFELD, Splinter Forceps	106
FERGUSON, Suction Tubes	290
FERRIS-SMITH-CUSHING, Bone cutting Forceps	274
FINSEN, Retractors	191
FOERSTER-BALLENGER, Sponge and Dressing Forceps	115
FOMON, Scalpel	11
- Retractors	175
- Operating Scissors	45, 46, 64
- Delicate Scissors	34
- Bone files	255, 259
- Periosteal	213
- Rhinology	233
Scissors	15 - 75
FOSTER-GILLIES, Needle Holders	144
FOX, Curettes	263
FRAZIER, Suction Tubes	290, 293
FREEMAN, Retractors	190
- Operating Scissors	66, 71
- Wellenschliff Scissors	72
FREEMAN-GORNEY, Operating Scissors	66, 71
FREEMAN-KAYE, Operating Scissors	66, 67, 73
FREER, Osteotome	223
- Knives	12
- Micro Retractors	175
- Periosteal	209, 212, 213, 216
FRIEDMANN, Bone cutting Forceps	270, 271

G

GALLAHER, Bone files	256
GEMINI, Hemostatic Forceps	129
GERALD, Tissue Forceps	95, 104
GERALD-BROWN, Tissue Forceps	95
GIDEF, Delicate Hemostatic Forceps	118
GIESSEN, Retractors	180
GILLIES, Micro Retractors	173
- Atraumatic Forceps	98
- Needle Holders	144, 148
GIUNTA-NASAL, Wellenschliff Scissors	70
GLASSMAN, Operating Scissors	27
GOLDMANN, Rhinology	283
GOLDMAN-FOX, Operating Scissors	25, 49, 53
- Delicate Scissors	25
GOOD, Tonsil Scissors	43
GORNEY, Suction Tubes	289
- Retractor	190
- Operating Scissors	43, 73
- Bone Cuttinf Scissors	47
- Wellenschliff Scissors	67, 68, 70, 72
GRAEFE, Delicate Scissors	22
- Micro Forceps	99
- Tissue Forceps	86, 100
GREEN, Micro Forceps	99
GREENBERG-PAR, Nasal Scissors	48, 54
GREGORY, Operating Scissors	69
GROSS, Hemostatic Forceps	115
GRUENWALD, Ear Forceps	105
GUILLIEN, Suction Tubes	289
GUTHRIE, Micro Retractors	173, 174

H

HABERER, Retractors	168
HALSEY, Needle Holders	141, 145
HALSTED, Hemostatic Forceps	120
- Delicate Hemostatic Forceps	118

HALSTED-MOSQUITO, Hemostatic Forceps	120
- Delicate Hemostatic Forceps	117
HARRINGTON, Retractors	185
HARTMANN, Tongue Forceps	169
- Suction Tubes	294
- Rhinology	198, 199
- Adult Specula	3
HARTMANN-BABY-MOSQUITO, Delicate Hemostatic Forceps	117
HEANEY(HEGAR), Needle Holders	142
HEGAR, Needle Holders	142, 146
HEGAR-MAYO-SEELEY, Needle Holders	153
HEISS, Hemostatic Forceps	126
HENAHAN, Periosteal	218
HEYMANN, Operating Scissors	46
HEYMANN-KNIGHT, Operating Scissors	45
HOUSE, Suction Tubes	292
- Retractor	178
HOWARD, Bone files	253
HOWART, Periosteal	211
HUNT, Micro Forceps	99
HUNTER, Splinter Forceps	106

I

IRIS, Operating Scissors	50, 53
- Delicate Scissors	20
- Left Scissors	52
- Wellenschliff Scissors	65

J

JACOBSON, Curettes	261
- Micro Scissors	16
- Micro Needle Holders	135
- Needle Holders	139
JACOBSON-MICRO, Delicate Hemostatic Forceps	111
JAEGER, Micro Retractors	174
JAMESON, Operating Scissors	23
JAMESON-WERBER, Operating Scissors	23
JANSEN, Curettes	261
- Bone cutting Forceps	272
- Tissue Forceps	105
- Raspatories	219
JONES, Towel Clamps	112, 114
JOSEPH, Knives	11, 12
- Retractors	175
- Operating Scissors	33, 64
- Bone files	256
- Periosteal	212, 213, 218
- Rhinology	258

K

KAHN, Operating Scissors	44
KAYE, Delicate Scissors	19
KAYE-FACE-LIFT, Operating Scissors	71
KELLY, Operating Scissors	28, 54
- Hemostatic Forceps	123
KERPEL, Curettes	263
KERSCHNER, Micro Retractors	173
KEYES, Rhinology	263
KILLIAN, Osteotome	225
- Suction Tubes	295
- Periosteal	211
- Rhinology	198, 199, 283
KILLIAN-KLAUS, Osteotome	225
KILNER, Retractors	172
- Operating Scissors	23, 27, 48, 54
- Wellenschliff Scissors	70
KILNER-DOUGHTY, Mouth gags	165
KIRBY, Retractors	175, 179
KLAR-EVATEUR, Retractors	179
KLEINERT-KUTZ, Bone cutting Forceps	273
KNAPP, Micro Retractors	174
KOCHER, Retractors	182
- Hemostatic Forceps	121, 123, 125

Alphabetisches Inhaltsverzeichnis	Alphabetical index	Indice alfabetico
KOCHER-OCHSNER, Hemostatic Forceps		122
KÖNIG, Elevator		205
KRESSNER, Rhinology		282
KUHNT, Tissue Forceps		100

L

LA GRANGE, Delicate Scissors	25, 49	
LAMBERT, Micro Forceps	99	
LAMBOTTE, Periosteal - Raspatories	242	
LANGENBECK, Periosteal	209, 219	
Laryngoscopes	3	
LEMPERT, Bone cutting Forceps	271	
LERICHE, Hemostatic Forceps	119	
LEXER, Osteotome	245	
- Operating Scissors	41, 62	
LEWIS, Bone files	257	
LICHTENBERG, Needle Holders	154	
LIEBERMANN-TENNANT, Micro Retractors	173	
Bone files	253 - 260	
LISTER, Hemostatic Forceps	114	
LISTON, Bone cutting Forceps	275	
LITTAUER, Cilia Forceps	106	
LITTLER, Delicate Scissors	34	
LOCKLIN, Operating Scissors	24, 28	
LOCKLIN MOD., Operating Scissors	24	
LOGAN, Retractors	191	
LORNA, Towel clamps	113	
LOVE, Retractors	178	
LUCAE, Surgical Mallets	248	
- Tissue Forceps	105	
LUENEBURG, Elevator	205	
LUER, Bone cutting Forceps	178	
- Bone Cutting Forceps	272	

M

MacCOLLUM-DINGMAN, Dissector	189	
MAGILL, Suction Tubes	295	
MAIER, Towel Clamps	116	
MALINIAC, Nasal Retractor	197	
MALTZ, Knives	12	
- Bone Files	259	
- Rhinology	260	
MARTINI, Curettes	261	
Surgical Mallets	249 - 250	
MASING, Knives	12	
- Periosteal	210, 212	
- Rhinology	233	
MATHIEU, Needle Holders	154	
MAYO, Operating Scissors	39, 40, 51, 63	
- Sterilizing Instruments	316	
MAYO-HEGAR, Needle Holders	142, 146	
MAYO-HEGAR-FINO, Needle Holders	147	
MAYO-HEGAR-HEANEY, Needle Holders	146	
MAYO-LEXER, Operating Scissors	63	
MAYO-NOBLE, Operating Scissors	39	
MAYO-STILLE, Operating Scissors	42, 62	
MC DONALD, Periosteal	216	
MC INDOE, Rhinology	232	
- Atraumatic Forceps	98	
MC INTOSH, Set Laryngoscopes	3	
MC IVOR, Mouth gags	166	
MC KENTY, Periosteal	211, 213	
MC PHERSON, Tissue Forceps	100	
MEAD, Surgical Mallets	248	
- Periosteal	209	
- Bone cutting Forceps	270	
MEDHORN, Vascular Clamps	155	
METZENBAUM, Operating Scissors	33, 35, 36, 48, 50, 58	
- Wellenschliff Scissors	65	
METZENBAUM-FINO, Operating Scissors	35, 36, 53, 59, 60, 61	
MICRO-HALSTED, Delicate Hemostatic Forceps	117	
MICRO-IRIS, Delicate Scissors	20	
MICRO-RYDER, Needle Holders	151, 152	
MICRO-VASCULAR, Needle Holders	150	
MILLARD, Retractors	172, 190	

Indice alfabetico	Indice alfabético	Index alphabétiques
MILLER, Bone files		253
MILLIGAN, Retractors		206
MINI-FRIEDMANN, Bone cutting Forceps		269, 270
MINI-GILLIES, Needle Holders		144, 148
MINI-LAMBOTTE, Osteotome		229
MINI-LEXER, Osteotome		244
MINI-MALTZ, Bone Files		259
MINI-OLSEN-HEGAR, Needle Holders		143
MINI-ROUX, Retractors		181
MOD. MARTIN, Cotton Applicators		161
MODELL WIEN, Nasal Specula		200
MOLT, Periosteal		218
MÜLLER, Approssimator		157

N

NEIVERT, Retractors	177
NELSON-METZENBAUM, Operating Scissors	37
NEWS, Retractor	178
NOYES, Micro Scissors	15
NUBOER, Suction Tubes	288

O

OBWEGESER, Ligature Needle	159
- Retractors	170, 183
- Osteotome	247
- Periosteal	215, 217
O'BRIEN, Suturing Scissors	74
O'CONNOR, Micro Retractors	174
OLIVECRONA, Dissectors	207
- Bone cutting Forceps	272
OLSEN-HEGAR, Needle Holder	143, 149
OMBREDANNE, Surgical Mallets	249
Osteotome	223 - 248
ORINGER, Mouth gags	169
OVERHOLT, Hemostatic Forceps	128
OVERHOLT-GEISSENDORFER, Hemostatic Forceps	128

P

PARKER-LANGENBECK, Retractors	180
PAR-TYPE, Nasal Scissors	54
PARTSCH, Osteotome - Gouges	227, 228
PAPAVERO-HARTMANN, Rhinology	201
PAUL, Retractors	176
PEAN, Hemostatic Forceps	121, 124
- Delicate Hemostatic Forceps	118
PEAN-MURPHY, Hemostatic Forceps	114
PECK-JOSEPH, Operating Scissors	53
PEET, Delicate Hemostatic Forceps	111
PENFIELD, Retractors	208
PENNINGTON, Periosteal	211
Periosteal	209 - 219
PERRY, Tissue Forceps	85
PIERCE, Periosteal	211
Emostatic Forceps	109 - 130
Forceps	79 - 106
PITANGUI, Marker	109
PLESTER, Suction Tubes	290
- Retractors	194
Needle Holders	133 - 154
POTTS-SMITH, Tissue Forceps	92, 102
POTTS-YASARGIL, Micro Scissors	16

Q

QUINBY, Delicate Scissors	22
QUINKE, Biopsy Needle	303

R

RADOLF, Nail Extracting Forceps	280
RAGNELL, Retractors	180

- Micro Delicate Scissors	19
RAGNELL-DAVIS, Retractors	180
RAMPLEY, Sponge and Dressing Forceps	116
RANKIN, Hemostatic Forceps	123
REYNOLDS, Delicate Scissors	26
Rhinology	198 - 201
ROCHESTER-PEAN, Hemostatic Forceps	122, 129
ROGER, Periosteal	211
ROGGE, Sterilizing Instruments	315
ROLLET, Micro Retractors	174
ROWE, Bone surgery	281
ROSE, Retractor	178
ROSTKOWSKI, Retractors	179
ROUX, Retractors	181
ROUX-MAGNUS, Retractors	181
RUBIN, Rhinology	234, 282
RUSKIN, Bone cutting Forceps	273
RUSKIN-LISTON, Bone cutting Forceps	275
RUSKIN-STILLE, Bone cutting Forceps	273
RYDER, Needle Holders	152

S

SAALFELD, Curettes	262
SACHS, Dissectors	206
SALZBURG, Periosteal	210
SAROT, Needle Holders	149
SAUG-RASPATORIUM, Suction Tubes	289
SCHAEDEL, Towel clamps	112
SCHEDE, Curettes	264
SCHNEIDER, Periosteal	219
SCHNEIDER-SAUERBRUCH, Periosteal - Raspatories	242
SCHWACKENDIEK, Tonsil Scissors	43
SCOVILLE, Retractors	182
SEDILLOT, Periosteal	214, 219
SEMKEN, Tissue Forceps	87, 92, 101
SENN-GREEN, Retractors	180
SENN-MILLER, Retractors	177
SEWALL, Periosteal	212
SHEA, Operating Scissors	33
SHEEHAN, Osteotomes	226
SILVER, Rhinology	232
SIMON, Retractors	184
SPENCER, Ligature Scissors	74
STACKE, Probes	160
STEINHÄUSER, Periosteal	217
STELLA, Operating Scissors	68
STELLBRINK, Bone cutting Forceps	269, 271
STEVENS, Delicate Scissors	19, 26, 48
STILLE, Operating Scissors	42
- Dressing Forceps	90
STITCH, Delicate Scissors	19
Measuring Instruments	4 - 5
SWEDISH MOD., Needle Holders	149

T

TAKAHASHI, Bone Cutting Forceps	274
TAYLOR, Tissue Forceps	102
TENNANT, Tissue Forceps	100
TESSIER, Osteotome	239, 241
THOREK, Operating Scissors	38
TIECK-HALLE, Nasal Specula	200
TOBOLD, Tongue Forceps	169
TOENNIS, Operating Scissors	38
TOENNIS-ADSON, Operating Scissors	38, 64
TROELTSCH, Tissue Forceps	105
TUFFIER, Retractors	168
TUOHY, Biopsy Needle	303

U

UNIVERSAL, Cotton Applicators	161
UNNA, Curettes	262

V

VANNAS, Micro Scissors	15
VARADY, Vein Stripper	195
VERESS, Biopsy Needles	303
VIDAL, Curettes	263
VISE, Micro Forceps	79
VOLKMANN, Curettes	262, 265

W

WALTER, Osteotome	231
WALTON, Delicate Scissors	19, 34
- Periosteal	213
WANGESTEEN, Tissue Forceps	102
WARWICK-JAMES, Nail Scissors	306
WEBSTER, Needle Holders	145
WEIL-BLAKESLEY, Bone cutting Forceps	274
WEITLANER, Retractors	192, 193
WERTHEIMER, Suction Tubes	293
WEST, Osteotome - Gouges	228
WESTCOTT, Micro Scissors	15
WHITEHEAD-JENNINGS, Mouth gags	165
WIEDER, Tongue Forceps	169
WIENER, Micro Retractors	174
WILLIGER, Curettes	261, 265
- Elevator	205
- Surgical Mallets	248
WILMER, Forbici delicate	22
WULLSTEIN, Retractors	192
- Micro Ear forceps	158

Y

YANCOSKIE, Retractor	190
YANKAUER, Dissector	206
- Wire Guides	159
YASARGIL, Micro Scissors	16

Z

ZAUFAL-JANSEN, Bone cutting Forceps	273
-------------------------------------	-----

A

ADSON, Cannule per aspirazione	293
- Divaricatore	193
- Periostotomo	218
- Pinzette chirurgiche	87, 88, 101, 104
ADSON-BROWN, Pinzette chirurgiche	87, 88
ALDERDYCE, Periostotomi	209
ALLIS, Pinze per tessuti	110
ALM, Divaricatori	191
Apribocca	165 - 168
ARKANSAS, Pietre ed accessori	310
ARRUGA, Port'aghi	154
ASCH, Rinologia	282
AUFRIEHT, Divaricatori	170, 197
- Lime per osso	257
AUFRIEHT-WALTER, Divaricatori	170
AUSTIN, Pinzette chirurgiche	86
AXENFELD, Divaricatori	176
AYERS, Micro Pinzette	99

B

BABBUSH, Periostotomi	209
BABY-ADSON, Pinze emostatiche per preparazione e legature	127
BABY-ALLIS, Pinze per tessuti	110
BABY-CRILE, Pinze emostatiche	120
BABY-CRILE-WOOD, Port'aghi	147
BABY-METZENBAUM, Forbici delicate	34
BABY-MIXTER, Pinze emostatiche per preparazione e legature	127
BACKHAUS, Fissateli	112
BALLENGER, Osteotomo	225
- Bisturi	12
- Rinologia	238
BALLENGER-HAYEK, Periostotomo	211
BARON, Cannule per aspirazione	291
BARRAQUER, Divaricatore	174
- Micro Port'aghi	134, 136
- Pinzette depilatorie	106
BARTH, Curette	261
BEASLEY-BACOCK, Pinzetta chirurgica	87
BEAUPRE, Pinzette depilatorie	106
BECKMANN, Speculum nasale	200
BEER, Pinzette depilatorie	106
BELLUCCI, Cannule per aspirazione	291
- Micro Pinze auricolari	158
BENGOLEA, Pinze emostatiche	126
BERGMANN, Martello chirurgico	249
BEYER, Pinze ossivore	273
BIEMER, Approssimatori	157
- Clamps vascolari	155
BIEMER-MÜLLER, Approssimatori	157
BIRCHER-GANSKE, Chirurgia ossea	276
BIRKETT, Pinze emostatiche	126
BIRO, Forbici delicate	22
BISHOP-HARMON, Micro Pinzette	100
Bisturi	6 - 12
BLUMENTHAL, Pinze ossivore	270
BÖHLER, Pinze ossivore	275
BOIES, Rinologia	283
BONN, Micro Pinzette	100
BONNEY, Pinzette chirurgiche	102
BOYNTON, Port'aghi	154
BOWMANN, Sonde bottonute	160
BRAUN, Pinza emostatica	114
BROCK, Micro Forbici	17
- Micro Pinzette	81
- Micro Port'aghi	133
BRÜNINGS, Bisturi	12
BRUNS, Curette	264
BUCKLEY, Osteotomo	224
BUNT, Pinze per sterilizzazione	316

C

Cannule d'aspirazione	287 - 302
-----------------------	-----------

CAPLAN, Forbici ossivore	47
- Rinologia	283
CARTER, Periostotomo	212
CASPAR, Manico per bisturi	9
CASTROVIEJO, Micro Port'aghi	136, 137
- Port'aghi	138, 140
- Strumenti per misurazione	4
CHADWICK, Forbici delicate	22
CHEATTLE, Pinze per sterilizzazione	316
CINELLI, Forbici delicate	34
- Rinologia	233
COLLIN, Pinze per sterilizzazione	316
CONVERSE, Bisturi	11
- Divaricatori	172
- Lime per osso	254
- Port'aghi	145
CONWAY, Divaricatori	179
CORN, Pinzette chirurgiche	86
CORONAL, Divaricatore	190
COTTLE, Bisturi	11
- Divaricatori	172, 175, 177, 179
- Forbici chirurgiche	23, 46, 64
- Lima per osso	257
- Martello chirurgico	249
- Micro Pinzette	99
- Osteotomi	230, 236, 237
- Periostotomi	210, 211, 212
- Rinologia	201
- Strumento per cartilagine	175
COTTLE-KNAPP, Forbici delicate	24
COTTLE-MASING, Forbici delicate	22
COTTLE-NEIVERT, Divaricatore	175
COTTLE-WALSHAM, Rinologia	282
CRAIG, Rinologia	283
CRILE, Pinze emostatiche	119, 120
CRILE-MURRAY, Port'aghi	141
CRILE-WOOD, Port'aghi	141, 147, 153
Curette	261 - 265
CUSHING, Divaricatori	178, 181, 182
- Periostotomo	218
- Pinzette chirurgiche	93, 102
CUSHING-KOCHER, Divaricatore	182

D

DANDY, Pinze emostatiche	119
DAVIS, Dissettori - Separatori	206
- Pinze per sterilizzazione	315
DAVIS-BOYLE, Apri bocca	166
DEAN, Forbici chirurgiche	45
DEAVER, Forbici chirurgiche	32
- Divaricatori	184
DERF, Port'aghi	141, 145
DESMARRES, Divaricatori	179
- Divaricatore isolato	130
- Micro Pinzette	99
DE BAKEY, Pinzette atraumatiche	96, 97, 98
- Pinzette chirurgiche	103
- Port'aghi	150
DE MARTEL, Pinza emostatica delicata	111
DIEFFENBACH, Clamps	155
DIETRICH, Port'aghi	138
DINGMANN, Apri bocca	167
- Chirurgia ossea	276
- Lime per osso	256
Dissettori	205 - 208
Divaricatori	172 - 197
DIXON-LOVELACE, Pinze emostatiche	126
DUNN-DAUTREY, Divaricatori	171
DUPLAY, Speculum nasale	3

E

ELSCHNIG, Pinzette chirurgiche	100
EPKER, Osteotomi	235

F

FACE-LIFT, Forbici chirurgiche	67, 69
- Forbici Wellenschliff	70
FAGER, Dissettori - Separatori	206
FARABEUF, Divaricatore	180
- Periostotomi	219
FARABEUF-COLLIN, Raspatore	219
FAULKNER, Rinologia	232
FAURE, Fissateli	112
FEICHENFELD, Pinzette per frammenti e schegge	106
FERGUSSON, Cannule per aspirazione	290
FERRIS-SMITH-CUSHING, Pinze ossivore	274
FINSEN, Divaricatori	191
FOERSTER-BALLENGER, Pinze per tamponi	115
FOMON, Bisturi	11
- Divaricatori	175
- Forbici chirurgiche	45, 46, 64
- Forbici delicate	34
- Lime per osso	255, 259
- Periostotomo	213
- Rinologia	233
Forbici	15 - 75
FOSTER-GILLIES, Port'aghi	144
FOX, Curette	263
FRAZIER, Cannule per aspirazione	290, 293
FREEMAN, Divaricatori	190
- Forbici chirurgiche	66, 71
- Forbici Wellenschliff	72
FREEMAN-GORNEY, Forbici chirurgiche	66, 71
FREEMAN-KAYE, Forbici chirurgiche	66, 67, 73
FREER, Battitori - Osteotomi	223
- Bisturi	12
- Micro Divaricatore	175
- Periostotomi	209, 212, 213, 216
FRIEDMANN, Pinze ossivore	270, 271

G

GALLAHER, Lime per osso	256
GEMINI, Pinze emostatiche	129
GERALD, Pinzette chirurgiche	95, 104
GERALD-BROWN, Pinzette chirurgiche	95
GIDEF, Pinzette emostatiche delicate	118
GIESSEN, Divaricatori	180
GILLIES, Micro divaricatori	173
- Pinzette atraumatiche	98
- Port'aghi	144, 148
GIUNTA-NASAL, Forbici Wellenschliff	70
GLASSMAN, Forbici chirurgiche	27
GOLDMANN, Rinologia	283
GOLDMAN-FOX, Forbici chirurgiche	25, 49, 53
- Forbici delicate	25
GOOD, Forbici per tonsille	43
GORNEY, Cannule per aspirazione	289
- Divaricatore	190
- Forbici chirurgiche	43, 73
- Forbici ossivore	47
- Forbici Wellenschliff	67, 68, 70, 72
GRAEFE, Forbici delicate	22
- Micro Pinzette da fissazione	99
- Pinzette chirurgiche	86, 100
GREEN, Micro Pinzette da fissazione	99
GREENBERG-PAR, Forbici nasali	48, 54
GREGORY, Forbici chirurgiche	69
GROSS, Pinze per tamponi	115
GRÜENWALD, Pinzette auricolari	105
GUILLIEN, Cannule per aspirazione	289
GUTHRIE, Micro divaricatori	173, 174

H

HABERER, Divaricatori	168
HALSEY, Port'aghi	141, 145
HALSTED, Pinze emostatiche	120
- Pinze emostatiche delicate	118

HALSTED-MOSQUITO, Pinze emostatiche	120
- Pinze emostatiche delicate	117
HARRINGTON, Divaricatori	185
HARTMANN, Abbassa lingua	169
- Cannule per aspirazione	294
- Rinologia	198, 199
- Speculum per adulti	3
HARTMANN-BABY-MOSQUITO, Pinze emostatiche	117
HEANEY(HEGAR), Port'aghi	142
HEGAR, Port'aghi	142, 146
HEGAR-MAYO-SEELEY, Port'aghi	153
HEISS, Pinze emostatiche	126
HENAHAN, Periostotomo	218
HEYMANN, Forbici chirurgiche	46
HEYMANN-KNIGHT, Forbici chirurgiche	45
HOUSE, Cannule per aspirazione	292
- Divaricatore	178
HOWARD, Lime per osso	253
HOWARTH, Periostotomo	211
HUNT, Micro pinzette	99
HUNTER, Pinzette per frammenti e schegge	106

I

IRIS, Forbici chirurgiche	50, 53
- Forbici delicate	20
- Forbici per mancini	52
- Forbici Wellenschliff	65

J

JACOBSON, Curette	261
- Micro forbici	16
- Micro Port'aghi	135
- Port'aghi	139
JACOBSON-MICRO, Pinze emostatiche delicate	111
JAEGER, Micro Divaricatori	174
JAMESON, Forbici chirurgiche	23
JAMESON-WERBER, Forbici chirurgiche	23
JANSEN, Curette	261
- Pinze ossivore	272
- Pinzette auricolari	105
- Raspatore	219
JONES, Fissateli	112, 114
JOSEPH, Bisturi	11, 12
- Divaricatore	175
- Forbici chirurgiche	33, 64
- Lime per osso	256
- Periostotomi	212, 213, 218
- Rinologia	258

K

KAHN, Forbici chirurgiche	44
KAYE, Forbici delicate	19
KAYE-FACE-LIFT, Forbici chirurgiche	71
KELLY, Forbici chirurgiche	28, 54
- Pinze emostatiche	123
KERPEL, Curette	263
KERSHNER, Micro Divaricatori	173
KEYES, Rinologia	263
KILLIAN, Osteotomo	225
- Cannule per aspirazione	295
- Periostotomo	211
- Rinologia	198, 199, 283
KILLIAN-KLAUS, Osteotomo	225
KILNER, Divaricatori	172
- Forbici chirurgiche	23, 27, 48, 54
- Forbici Wellenschliff	70
KILNER-DOUGHTY, Apri bocca	165
KIRBY, Divaricatori	175, 179
KLAR-EVATEUR, Divaricatore	179
KLEINERT-KUTZ, Pinze ossivore	273
KNAPP, Micro divaricatore	174
KOCHER, Divaricatori	182
- Pinze emostatiche	121, 123, 125

Alphabetisches Inhaltsverzeichnis	Alphabetical index	Indice alfabetico
KOCHER-OCHSNER, Pinze emostatiche		122
KÖNIG, Elevatori		205
KRESSNER, Rinologia		282
KUHNT, Pinzette Chirurgiche		100

L

LA GRANGE, Forbici delicate	25, 49	
LAMBERT, Micro Pinzette	99	
LAMBOTTE, Periostotomi - Raspatori	242	
LANGENBECK, Periostotomi	209, 219	
Laringoscopi	3	
LEMPERT, Pinze ossivore	271	
LERICHE, Pinze emostatiche	119	
LEXER, Osteotomi	245	
- Forbici chirurgiche	41, 62	
LEWIS, Lime per osso	257	
LICHTENBERG, Port'aghi	154	
LIEBERMANN-TENNANT, Micro Divaricatori	173	
Lime per osso	253 - 260	
LISTER, Pinze emostatiche	114	
LISTON, Pinze ossivore	275	
LITTAUER, Pinzette depilatorie	106	
LITTLER, Forbici delicate	34	
LOCKLIN, Forbici chirurgiche	24, 28	
LOCKLIN MOD., Forbici chirurgiche	24	
LOGAN, Divaricatori	191	
LORNA, Fissateli	113	
LOVE, Divaricatori	178	
LUCAE, Martello chirurgico	248	
- Pinzette auricolari	105	
LUENEBURG, Elevatori	205	
LUER, Divaricatore	178	
- Pinze ossivore	272	

M

MacCOLLUM-DINGMAN, Dissettori	189	
MAGILL, Cannule per aspirazione	295	
MAIER, Pinze per tamponi	116	
MALINIAC, Retrattore nasale	197	
MALTZ, Bisturi	12	
- Lime per osso	259	
- Rinologia	260	
MARTINI, Curette	261	
Martelli chirurgici	249 - 250	
MASING, Bisturi	12	
- Periostotomi	210, 212	
- Rinologia	233	
MATHIEU, Port'aghi	154	
MAYO, Forbici chirurgiche	39, 40, 51, 63	
- Pinze per sterilizzazione	316	
MAYO-HEGAR, Port'aghi	142, 146	
MAYO-HEGAR-FINO, Port'aghi	147	
MAYO-HEGAR-HEANEY, Port'aghi	146	
MAYO-LEXER, Forbici chirurgiche	63	
MAYO-NOBLE, Forbici chirurgiche	39	
MAYO-STILLE, Forbici chirurgiche	42, 62	
MC DONALD, Periostotomo	216	
MC INDOE, Rinologia	232	
- Pinze atraumatiche	98	
MC INTOSH, Set laringoscopi	3	
MC IVOR, Apri bocca	166	
MC KENTY, Periostotomi	211, 213	
MC PHERSON, Pinzette chirurgiche	100	
MEAD, Martello chirurgico	248	
- Periostotomo	209	
- Pinze ossivore	270	
MEDHORN, Clamps vascolari	155	
METZENBAUM, Forbici chirurgiche	33, 35, 36, 48, 50, 58	
- Forbici Wellenschliff	65	
METZENBAUM-FINO, Forbici chirurgiche	35, 36, 53, 59, 60, 61	
MICRO-HALSTED, Pinze emostatiche delicate	117	
MICRO-IRIS, Forbici delicate	20	
MICRO-RYDER, Port'aghi	151, 152	
MICRO-VASCULAR, Port'aghi	150	
MILLARD, Divaricatori	172, 190	

MILLER, Lime per osso	253
MILLIGAN, Dissettori - Separatori	206
MINI-FRIEDMANN, Pinze ossivore	269, 270
MINI-GILLIES, Port'aghi	144, 148
MINI-LAMBOTTE, Osteotomi	229
MINI-LEXER, Osteotomo	244
MINI-MALTZ, Lime per osso	259
MINI-OLSEN-HEGAR, Port'aghi	143
MINI-ROUX, Divaricatori	181
MOD. MARTIN, Porta cotone	161
MODELL WIEN, Speculum nasale	200
MOLT, Periostotomo	218
MÜLLER, Approssimatori	157

N

NEIVERT, Divaricatori	177
NELSON-METZENBAUM, Forbici chirurgiche	37
NEWS, Divaricatore	178
NOYES, Micro forbici	15
NUBOER, Cannule per aspirazione	288

O

OBWEGESER, Aghi per legature	159
- Divaricatori	170, 183
- Osteotomi	247
- Periostotomi	215, 217
O'BRIEN, Forbici per suture	74
O'CONNOR, Divaricatori	174
OLIVECRONA, Dissettori - Separatori	207
- Pinze ossivore	272
OLSEN-HEGAR, Port'aghi	143, 149
OMBREDANNE, Martello chirurgico	249
Osteotomi	223 - 248
ORINGER, Apri bocca	169
OVERHOLT, Pinze emostatiche	128
OVERHOLT-GEISSENDORFER, Pinze emostatiche	128

P

PARKER-LANGENBECK, Divaricatore	180
PAR-TYPE, Forbici nasali	54
PARTSCH, Osteotomi - Scalpelli	227, 228
PAPAVERO-HARTMANN, Rinologia	201
PAUL, Divaricatori	176
PEAN, Pinze emostatiche	121, 124
- Pinze emostatiche delicate	118
PEAN-MURPHY, Pinze emostatiche	114
PECK-JOSEPH, Forbici chirurgiche	53
PEET, Pinze emostatiche delicate	111
PENFIELD, Dissettori	208
PENNINGTON, Periostotomo	211
Periostotomi	209 - 219
PERRY, Pinzette per dissezione	85
PIERCE, Periostotomo	211
Pinze emostatiche	109 - 130
Pinzette	79 - 106
PITANGUI, Marcatore	109
PLESTER, Cannule per aspirazione	290
- Divaricatori	194
Port'aghi	133 - 154
POTTS-SMITH, Pinzette chirurgiche	92, 102
POTTS-YASARGIL, Micro forbici	16

Q

QUINBY, Forbici delicate	22
QUINKE, Aghi da biopsia	303

R

RADOLF, Chirurgia della mano	280
RAGNELL, Divaricatori	180

- Micro Forbici delicate	19
RAGNELL-DAVIS, Divaricatori	180
RAMPLEY, Pinze per tamponi	116
RANKIN, Pinze emostatiche	123
REYNOLDS, Forbici delicate	26
Rinologia	198 - 201
ROCHESTER-PEAN, Pinze emostatiche	122, 129
ROGER, Periostotomo	211
ROGGE, Pinze per sterilizzazione	315
ROLLET, Micro Divaricatori	174
ROWE, Pinze per riposizione	281
ROSE, Divaricatore	178
ROSTKOWSKI, Divaricatori	179
ROUX, Divaricatori	181
ROUX-MAGNUS, Divaricatori	181
RUBIN, Rinologia	234, 282
RUSKIN, Pinze ossivore	273
RUSKIN-LISTON, Pinze ossivore	275
RUSKIN-STILLE, Pinze ossivore	273
RYDER, Port'aghi	152

S

SAALFELD, Schiaccia comedoni	262
SACHS, Dissettori - Separatori	206
SALZBURG, Periostotomi	210
SAROT, Port'aghi	149
SAUG-RASPATORIUM, Cannule per aspirazione	289
SCHAEDEL, Fissateli	112
SCHEDE, Curette	264
SCHNEIDER, Periostotomo	219
SCHNEIDER-SAUERBRUCH, Periostotomi - Raspatori	242
SCHWACKENDIEK, Forbici per tonsille	43
SCOVILLE, Divaricatori	182
SEDILLOT, Periostotomo	214, 219
SEMKEN, Pinzette chirurgiche	87, 92, 101
SENN-GREEN, Divaricatori	180
SENN-MILLER, Divaricatori	177
SEWALL, Periostotomo	212
SHEA, Forbici chirurgiche	33
SHEEHAN, Osteotomi	226
SILVER, Rinologia	232
SIMON, Divaricatore	184
SPENCER, Forbici per suture	74
STACKE, Sonda bottonute	160
STEINHÄUSER, Periostotomi	217
STELLA, Forbici chirurgiche	68
STELLBRINK, Pinze ossivore	269, 271
STEVENS, Forbici delicate	19, 26, 48
STILLE, Forbici chirurgiche	42
- Pinzette anatomiche	90
STITCH, Forbici delicate	19
Strumenti per misurazione	4 - 5
SWEDISH MOD., Port'aghi	149

T

TAKAHASHI, Pinze ossivore	274
TAYLOR, Pinzette chirurgiche	102
TENNANT, Pinzette chirurgiche	100
TESSIER, Osteotomi	239, 241
THOREK, Forbici chirurgiche	38
TIECK-HALLE, Speculum nasale	200
TOBOLD, Abbassalingua	169
TOENNIS, Forbici chirurgiche	38
TOENNIS-ADSON, Forbici chirurgiche	38, 64
TROELTSH, Pinzette auricolari	105
TUFFIER, Divaricatori	168
TUOHY, Agghi da biopsia	303

U

UNIVERSAL, Porta cotone	161
UNNA, Schiaccia comedoni	262

V

VANNAS, Micro forbici	15
VARADY, Uncini per vene	195
VERESS, Agghi da biopsia	303
VIDAL, Curette	263
VISE, Micro Pinzette	79
VOLKMANN, Curette	262, 265

W

WALTER, Osteotomi	231
WALTON, Forbici delicate	19, 34
- Periostotomo	213
WANGESTEEN, Pinzette chirurgiche	102
WARWICK-JAMES, Tronchesi per unghie	306
WEBSTER, Port'aghi	145
WEIL-BLAKESLEY, Pinze ossivore	274
WEITLANER, Divaricatori	192, 193
WERTHEIMER, Cannule per aspirazione	293
WEST, Osteotomi - Scalpelli	228
WESTCOTT, Micro forbici	15
WHITEHEAD-JENNINGS, Apri bocca	165
WIEDER, Abbassalingua	169
WIENER, Micro divaricatori	174
WILLIGER, Curette	261, 265
- Elevatori	205
- Martello chirurgico	248
WILMER, Forbici delicate	22
WULLSTEIN, Divaricatori	192
- Micro Pinze auricolari	158

Y

YANCOSKIE, Divaricatore	190
YANKAUER, Dissettore	206
- Passafili	159
YASARGIL, Micro forbici	16

Z

ZAUFAL-JANSEN, Pinze ossivore	273
-------------------------------	-----

A

ADSON, Cánulas aspiradoras	293
- Separadores	193
- Periostotomos	218
- Pinzas quirúrgicas	87, 88, 101, 104
ADSON-BROWN, Pinzas quirúrgicas	87, 88
ALDERDYCE, Periostotomos	209
ALLIS, Pinzas para coger las encias	110
ALM, Separadores	191
Abrebocas	165 - 168
ARKANSAS, Accesorios para el reafilado	310
ARRUGA, Portaagujas	154
ASCH, Rinología	282
AUFRIEHT, Separadores	170, 197
- Limas para huesos	257
AUFRIEHT-WALTER, Separadores	170
AUSTIN, Pinzas quirúrgicas	86
AXENFELD, Separadores	176
AYERS, Pinzas finos	99

B

BABBUSH, Periostotomos	209
BABY-ADSON, Pinzas hemostáticas y para ligadura	127
BABY-ALLIS, Pinzas para coger las encias	110
BABY-CRILE, Pinzas hemostáticas	120
BABY-CRILE-WOOD, Portaagujas	147
BABY-METZENBAUM, Tijeras finas	34
BABY-MIXTER, Pinzas hemostáticas y para ligadura	127
BACKHAUS, Pinzas de campo	112
BALLENGER, Batidor - Osteótomos	225
- Bisturías	12
- Rinología	238
BALLENGER-HAYEK, Periostotomos	211
BARON, Cánulas aspiradoras	291
BARRAQUER, Separadores	174
- Micro portaagujas	134, 136
- Pinzas depilatorie	106
BARTH, Cucharillas cortantes	261
BEASLEY-BACOCK, Pinzas quirúrgicas	87
BEAUPRE, Pinzas depilatorie	106
BECKMANN, Espéculos nasales	200
BEER, Pinzas depilatorie	106
BELLUCCI, Cánulas aspiradoras	291
- Pinzas auriculares finas	158
BENGOLEA, Pinzas hemostáticas	126
BERGMANN, Martillos quirúrgicos	249
BEYER, Pinzas para huesos	273
BIEMER, Aproximadores	157
- Clamps vasculares	155
BIEMER-MÜLLER, Aproximadores	157
BIRCHER-GANSKE, Pinzas para Cirugía ósea	276
BIRKETT, Pinzas hemostáticas	126
BIRO, Tijeras finas	22
BISHOP-HARMON, Micro Pinzas	100
Bisturías	6 - 12
BLUMENTHAL, Pinzas para huesos	270
BÖHLER, Pinzas para huesos	275
BOIES, Rinología	283
BONN, Micro Pinzas	100
BONNEY, Pinzas quirúrgicas	102
BOYNTON, Portaagujas	154
BOWMANN, Estiletes	160
BRAUN, Pinzas hemostáticas	114
BROCK, Micro Tijeras	17
- Micro Pinzas	81
- Micro Portaagujas	133
BRÜNINGS, Bisturías	12
BRUNS, Cucharillas cortantes	264
BUCKLEY, Osteótomos	224
BUNT, Pinzas para esterilización	316

C

Cánulas aspiradoras	287 - 302
---------------------	-----------

CAPLAN, Tijeras para huesos	47
- Rinología	283
CARTER, Periostotomos	212
CASPAR, Mango de bisturías	9
CASTROVIEJO, Micro portaagujas	136, 137
- Portaagujas	138, 140
- Instrumentos para medir	4
CHADWICK, Tijeras finas	22
CHEATTLE, Pinzas para esterilización	316
CINELLI, Tijeras finas	34
- Rinología	233
COLLIN, Pinzas para esterilización	316
CONVERSE, Bisturías	11
- Separadores	172
- Limas para huesos	254
- Portaagujas	145
CONWAY, Separadores	179
CORN, Pinzas quirúrgicas	86
CORONAL, Separadores	190
COTTLE, Bisturías	11
- Separadores	172, 175, 177, 179
- Tijeras quirúrgicas	23, 46, 64
- Limas para huesos	257
- Martillos quirúrgicos	249
- Micro Pinzas	99
- Osteótomos	230, 236, 237
- Periostotomos	210, 211, 212
- Rinología	201
- Instrumentos para magullar cartílagos	175
COTTLE-KNAPP, Tijeras finas	24
COTTLE-MASING, Tijeras finas	22
COTTLE-NEIVERT, Separadores	175
COTTLE-WALSHAM, Rinología	282
CRAIG, Rinología	283
CRILE, Pinzas hemostáticas	119, 120
CRILE-MURRAY, Portaagujas	141
CRILE-WOOD, Portaagujas	141, 147, 153
Cucharillas cortantes	261 - 265
CUSHING, Separadores	178, 181, 182
- Periostotomos	218
- Pinzas quirúrgicas	93, 102
CUSHING-KOCHER, Separadores	182

D

DANDY, Pinzas hemostáticas	119
DAVIS, Disecadores - Descoladores	206
- Pinzas pala sterilización	315
DAVIS-BOYLE, Abrebocas	166
DEAN, Tijeras quirúrgicas	45
DEAVER, Tijeras quirúrgicas	32
- Separadores	184
DERF, Portaagujas	141, 145
DESMARRES, Separadores	179
- Separadores aislado	130
- Micro Pinzas	99
DE BAKEY, Pinzas atraumáticas	96, 97, 98
- Pinzas quirúrgicas	103
- Portaagujas	150
DE MARTEL, Pinzas hemostáticas finas	111
DIEFFENBACH, Clamps vasculares	155
DIETRICH, Portaagujas	138
DINGMANN, Abrebocas	167
- Pinzas para Cirugía ósea	276
- Limas para huesos	256
Disecadores	205 - 208
Separadores	172 - 197
DIXON-LOVELACE, Pinzas hemostáticas	126
DUNN-DAUTREY, Separadores	171
DUPLAY, Espéculos nasales	3

E

ELSCHNIG, Pinzas quirúrgicas	100
EPKER, Osteótomos	235

F

FACE-LIFT, Tijeras quirúrgicas	67, 69
- Tijeras Wellenschliff	70
FAGER, Disecadores - Descoladores	206
FARABEUF, Separadores	180
- Periostotomos	219
FARABEUF-COLLIN, Descoladores	219
FAULKNER, Rinología	232
FAURE, Pinzas de campo	112
FEICHENFELD, Pinzas para espinas	106
FERGUSON, Cánulas aspiradoras	290
FERRIS-SMITH-CUSHING, Pinzas para huesos	274
FINSEN, Separadores	191
FOERSTER-BALLENGER, Pinzas para tampones	115
FOMON, Bisturios	11
- Separadores	175
- Tijeras quirúrgicas	45, 46, 64
- Tijeras finas	34
- Limas para huesos	255, 259
- Periostotomos	213
- Rinología	233
Tijeras	15 - 75
FOSTER-GILLIES, Portaagujas	144
FOX, Cucharillas cortantes	263
FRAZIER, Cánulas aspiradoras	290, 293
FREEMAN, Separadores	190
- Tijeras quirúrgicas	66, 71
- Tijeras Wellenschliff	72
FREEMAN-GORNEY, Tijeras quirúrgicas	66, 71
FREEMAN-KAYE, Tijeras quirúrgicas	66, 67, 73
FREER, Batidor - Osteótomos	223
- Bisturios	12
- Micro Separadores	175
- Periostotomos	209, 212, 213, 216
FRIEDMANN, Pinzas para huesos	270, 271

G

GALLAHER, Limas para huesos	256
GEMINI, Pinzas hemostáticas	129
GERALD, Pinzas quirúrgicas	95, 104
GERALD-BROWN, Pinzas quirúrgicas	95
GIDEF, Pinzas hemostáticas finas	118
GIESSEN, Separadores	180
GILLIES, Micro Separadores	173
- Pinzas Atraumáticas	98
- Portaagujas	144, 148
GIUNTA-NASAL, Tijeras Wellenschliff	70
GLASSMAN, Tijeras quirúrgicas	27
GOLDMANN, Rinología	283
GOLDMAN-FOX, Tijeras quirúrgicas	25, 49, 53
- Tijeras finas	25
GOOD, Tijeras para amígdalas	43
GORNEY, Cánulas aspiradoras	289
- Separadores	190
- Tijeras quirúrgicas	43, 73
- Tijeras para huesos	47
- Tijeras Wellenschliff	67, 68, 70, 72
GRAEFE, Tijeras finas	22
- Micro Pinzas	99
- Pinzas quirúrgicas	86, 100
GREEN, Micro Pinzas	99
GREENBERG-PAR, Tijeras	48, 54
GREGORY, Tijeras quirúrgicas	69
GROSS, Pinzas para tampones	115
GRUENWALD, Pinzas auriculares	105
GUILLIEN, Cánulas aspiradoras	289
GUTHRIE, Micro separadores	173, 174

H

HABERER, Separadores	168
HALSEY, Portaagujas	141, 145
HALSTED, Pinzas hemostáticas	120
- Pinzas hemostáticas finas	118

HALSTED-MOSQUITO, Pinzas hemostáticas	120
- Pinzas hemostáticas finas	117
HARRINGTON, Separadores	185
HARTMANN, Bejalenguas	169
- Cánulas aspiradoras	294
- Rinología	198, 199
- Espéculos para adultos	3
HARTMANN-BABY-MOSQUITO, Pinzas hemostáticas	117
HEANEY(HEGAR), Portaagujas	142
HEGAR, Portaagujas	142, 146
HEGAR-MAYO-SEELEY, Portaagujas	153
HEISS, Pinzas hemostáticas	126
HENAHAN, Periostotomos	218
HEYMANN, Tijeras quirúrgicas	46
HEYMANN-KNIGHT, Tijeras quirúrgicas	45
HOUSE, Cánulas aspiradoras	292
- Separadores	178
HOWARD, Limas para huesos	253
HOWARTH, Periostotomos	211
HUNT, Micro Pinzas	99
HUNTER, Pinzas para espinas	106

I

IRIS, Tijeras quirúrgicas	50, 53
- Tijeras finas	20
- Tijeras para zurdos	52
- Tijeras Wellenschliff	65

J

JACOBSON, Cucharillas cortante	261
- Micro Tijeras	16
- Micro Portaagujas	135
- Portaagujas	139
JACOBSON-MICRO, Pinzas hemostáticas finas	111
JAEGER, Micro Separadores	174
JAMESON, Tijeras quirúrgicas	23
JAMESON-WERBER, Tijeras quirúrgicas	23
JANSEN, Cucharillos cortantes	261
- Pinzas para huesos	272
- Pinzas auriculares	105
- Descoladores	219
JONES, Pinzas de campo	112, 114
JOSEPH, Bisturios	11, 12
- Separadores	175
- Tijeras quirúrgicas	33, 64
- Limas para huesos	256
- Periostotomos	212, 213, 218
- Rinología	258

K

KAHN, Tijeras quirúrgicas	44
KAYE, Tijeras finas	19
KAYE-FACE-LIFT, Tijeras quirúrgicas	71
KELLY, Tijeras quirúrgicas	28, 54
- Pinzas hemostáticas	123
KERPEL, Cucharillos cortantes	263
KERSCHNER, Micro Separadores	173
KEYES, Rinología	263
KILLIAN, Osteótomos	225
- Cánulas aspiradoras	295
- Periostotomos	211
- Rinología	198, 199, 283
KILLIAN-KLAUS, Osteótomos	225
KILNER, Separadores	172
- Tijeras quirúrgicas	23, 27, 48, 54
- Tijeras Wellenschliff	70
KILNER-DOUGHTY, Abrebocas	165
KIRBY, Separadores	175, 179
KLAR-EVATEUR, Separadores	179
KLEINERT-KUTZ, Pinzas para huesos	273
KNAPP, Micro Separadores	174
KOCHER, Separadores	182
- Pinzas hemostáticas	121, 123, 125

Alphabetisches Inhaltsverzeichnis	Alphabetical index	Indice alfabetico
KOCHER-OCHSNER, Pinzas hemostáticas		122
KÖNIG, Elevadores		205
KRESSNER, Rinología		282
KUHNT, Pinzas quirúrgicas		100

L

LA GRANGE, Tijeras finas	25, 49
LAMBERT, Micro Pinzas	99
LAMBOTTE, Periostotomos	242
LANGENBECK, Periostotomos	209, 219
Laringoscopios	3
LEMPERT, Pinzas para huesos	271
LERICHE, Pinzas hemostáticas	119
LEXER, Osteótomos	245
- Tijeras quirúrgicas	41, 62
LEWIS, Limas para huesos	257
LICHTENBERG, Portaagujas	154
LIEBERMANN-TENNANT, Micro Separadores	173
Limas para huesos	253 - 260
LISTER, Pinzas hemostáticas	114
LISTON, Pinzas para huesos	275
LITTAUER, Pinzas depilatorie	106
LITTLER, Tijeras finas	34
LOCKLIN, Tijeras quirúrgicas	24, 28
LOCKLIN MOD., Tijeras quirúrgicas	24
LOGAN, Separadores	191
LORNA, Pinzas de campo	113
LOVE, Separadores	178
LUCAE, Martillos quirúrgicos	248
- Pinzas auriculares	105
LUENEBURG, Elevadores	205
LUER, Separadores	178
- Pinzas para huesos	272

M

MacCOLLUM-DINGMAN, Disecadores	189
MAGILL, Cánulas aspiradoras	295
MAIER, Pinzas para tampones	116
MALINIAC, Separadores	197
MALTZ, Bisturios	12
- Limas para huesos	259
- Rinología	260
MARTINI, Cucharillo cortantes	261
Martillos quirúrgicos	249 - 250
MASING, Bisturios	12
- Periostotomos	210, 212
- Rinología	233
MATHIEU, Portaagujas	154
MAYO, Tijeras quirúrgicas	39, 40, 51, 63
- Pinzas para esterilización	316
MAYO-HEGAR, Portaagujas	142, 146
MAYO-HEGAR-FINO, Portaagujas	147
MAYO-HEGAR-HEANEY, Portaagujas	146
MAYO-LEXER, Tijeras quirúrgicas	63
MAYO-NOBLE, Tijeras quirúrgicas	39
MAYO-STILLE, Tijeras quirúrgicas	42, 62
MC DONALD, Periostotomos	216
MC INDOE, Rinología	232
- Pinzas Atraumaticas	98
MC INTOSH, Set Laringoscopios	3
MC IVOR, Abrebocas	166
MC KENTY, Periostotomos	211, 213
MC PHERSON, Pinzas quirúrgicas	100
MEAD, Martillos quirúrgicos	248
- Periostotomos	209
- Pinzas para huesos	270
MEDHORN, Clamps Vasculares	155
METZENBAUM, Tijeras quirúrgicas	33, 35, 36, 48, 50, 58
- Tijeras Wellenschliff	65
METZENBAUM-FINO, Tijeras quirúrgicas	35, 36, 53, 59, 60, 61
MICRO-HALSTED, Pinzas hemostáticas finas	117
MICRO-IRIS, Tijeras finas	20
MICRO-RYDER, Portaagujas	151, 152
MICRO-VASCULAR, Portaagujas	150
MILLARD, Separadores	172, 190

Indice alfabetico	Indice alfabético	Index alphabétiques
MILLER, Limas para huesos		253
MILLIGAN, Disecadores - Descoladores		206
MINI-FRIEDMANN, Pinzas para huesos		269, 270
MINI-GILLIES, Portaagujas		144, 148
MINI-LAMBOTTE, Osteótomos		229
MINI-LEXER, Osteótomos		244
MINI-MALTZ, Limas para huesos		259
MINI-OLSEN-HEGAR, Portaagujas		143
MINI-ROUX, Separadores		181
MOD. MARTIN, Porta-algodón		161
MODELL WIEN, Espéculos nasales		200
MOLT, Periostótomos		218
MÜLLER, Approximatores		157

N

NEIVERT, Separadores	177
NELSON-METZENBAUM, Tijeras quirúrgicas	37
NEWS, Separadores	178
NOYES, Micro Tijeras	15
NUBOER, Cánulas aspiradoras	288

O

OBWEGESER, Aguja para ligaduras	159
- Separadores	170, 183
- Osteótomos	247
- Periostótomos	215, 217
O'BRIEN, Tijeras para sutura	74
O'CONNOR, Micro Separadores	174
OLIVECRONA, Disecadores - Descoladores	207
- Pinzas para huesos	272
OLSEN-HEGAR, Portaagujas	143, 149
OMBREDANNE, Martillos quirúrgicos	249
Osteótomos	223 - 248
ORINGER, Abrebocas	169
OVERHOLT, Pinzas hemostáticas	128
OVERHOLT-GEISSENDORFER, Pinzas hemostáticas	128

P

PARKER-LANGENBECK, Separadores	180
PAR-TYPE, Tijeras nasal	54
PARTSCH, Osteótomos	227, 228
PAPAVERO-HARTMANN, Espéculos nasale	201
PAUL, Separadores	176
PEAN, Pinzas hemostáticas	121, 124
- Pinzas hemostáticas finas	118
PEAN-MURPHY, Pinzas hemostáticas	114
PECK-JOSEPH, Tijeras quirúrgicas	53
PEET, Pinzas hemostáticas finas	111
PENFIELD, Disecadores	208
PENNINGTON, Periostótomos	211
Periostótomos	209 - 219
PERRY, Pinzas para diseccion	85
PIERCE, Periostótomos	211
Pinzas hemostáticas	109 - 130
Pinzas	79 - 106
PITANGUI, Marcador	109
PLESTER, Cánulas aspiradoras	290
- Separadores	194
Portaagujas	133 - 154
POTTS-SMITH, Pinzas quirúrgicas	92, 102
POTTS-YASARGIL, Micro Tijeras	16

Q

QUINBY, Tijeras finas	22
QUINKE, Aguja para biopsia	303

R

RADOLF, Pinza para arrancar uñas	280
RAGNELL, Separadores	180

- Micro Tijeras finas	19
RAGNELL-DAVIS, Separadores	180
RAMPLEY, Pinzas para tampones	116
RANKIN, Pinzas hemostáticas	123
REYNOLDS, Tijeras finas	26
Rinología	198 - 201
ROCHESTER-PEAN, Pinzas hemostáticas	122, 129
ROGER, Periostótomos	211
ROGGE, Pinzas para esterilización	315
ROLLET, Micro Separadores	174
ROWE, Pinza para huesos	281
ROSE, Separadores	178
ROSTKOWSKI, Separadores	179
ROUX, Separadores	181
ROUX-MAGNUS, Separadores	181
RUBIN, Rinología	234, 282
RUSKIN, Pinzas para huesos	273
RUSKIN-LISTON, Pinzas para huesos	275
RUSKIN-STILLE, Pinzas para huesos	273
RYDER, Portaagujas	152

S

SAALFELD, Cucharillos cortantes	262
SACHS, Disecadores - Descoladores	206
SALZBURG, Periostótomos	210
SAROT, Portaagujas	149
SAUG-RASPATORIUM, Cánulas aspiradoras	289
SCHAEDEL, Pinzas de campo	112
SCHUDE, Cucharillos cortantes	264
SCHNEIDER, Periostótomos	219
SCHNEIDER-SAUERBRUCH, Periostótomos	242
SCHWACKENDIEK, Tijeras para amígdalas	43
SCOVILLE, Separadores	182
SEDILLOT, Periostótomos	214, 219
SEMKEN, Pinzas quirúrgicas	87, 92, 101
SENN-GREEN, Separadores	180
SENN-MILLER, Separadores	177
SEWALL, Periostótomos	212
SHEA, Tijeras quirúrgicas	33
SHEEHAN, Osteótomos	226
SILVER, Rinología	232
SIMON, Separadores	184
SPENCER, Tijeras para ligadura	74
STACKE, Estiletes	160
STEINHÄUSER, Periostótomos	217
STELLA, Tijeras quirúrgicas	68
STELLBRINK, Pinzas para huesos	269, 271
STEVENS, Tijeras finas	19, 26, 48
STILLE, Tijeras quirúrgicas	42
- Pinzas anatómica	90
STITCH, Tijeras finas	19
Instrumentos para medir	4 - 5
SWEDISH MOD., Portaagujas	149

T

TAKAHASHI, Pinzas para huesos	274
TAYLOR, Pinzas quirúrgicas	102
TENNANT, Pinzas quirúrgicas	100
TESSIER, Osteótomos	239, 241
THOREK, Tijeras quirúrgicas	38
TIECK-HALLE, Espéculos nasales	200
TOBOLD, Bejalenguas	169
TOENNIS, Tijeras quirúrgicas	38
TOENNIS-ADSON, Tijeras quirúrgicas	38, 64
TROELTSCH, Pinzas auriculares	105
TUFFIER, Separadores	168
TUOHY, Agujas para biopsia	303

U

UNIVERSAL, Porta-algodón	161
UNNA, cucharillos cortantes	262

V

VANNAS, Micro Tijeras	15
VARADY, Instrumentos para várices	195
VERESS, Agujas para biopsia	303
VIDAL, Cucharillos cortantes	263
VISE, Micro Pinzas	79
VOLKMANN, Cucharillos cortantes	262, 265

W

WALTER, Osteótomos	231
WALTON, Tijeras finas	19, 34
- Periostótomos	213
WANGESTEEN, Pinzas quirúrgicas	102
WARWICK-JAMES, Instrumentos para pedicura	306
WEBSTER, Portaagujas	145
WEIL-BLAKESLEY, Pinzas para huesos	274
WEITLANER, Separadores	192, 193
WERTHEIMER, Cánulas aspiradoras	293
WEST, Osteótomos	228
WESTCOTT, Micro Tijeras	15
WHITEHEAD-JENNINGS, Abrebocas	165
WIEDER, Bejalenguas	169
WIENER, Micro Separadores	174
WILLIGER, Cucharillos cortantes	261, 265
- Elevadores	205
- Martillos quirúrgicos	248
WILMER, Tijeras finas	22
WULLSTEIN, Separadores	192
- Pinzas auriculares finas	158

Y

YANCOSKIE, Separadores	190
YANKAUER, Disecadores	206
- Agujas para ligaduras	159
YASARGIL, Micro Tijeras	16

Z

ZAUFAL-JANSEN, Pinzas para huesos	273
-----------------------------------	-----

A

ADSON, Canules aspiratrices	293
- Ecarteur	193
- Rugines	218
- Pincettes chirurgicales	87, 88, 101, 104
ADSON-BROWN, Pincettes chirurgicales	87, 88
ALDERDYCE, Rugines	209
ALLIS, Pincettes pour saisir les tissus	110
ALM, Ecarteurs	191
Ecarteurs buccaux	165 - 168
ARKANSAS, Pierres d'affûtage	310
ARRUGA, Porte aiguilles	154
ASCH, Rhinologie	282
AUFRIEHT, Ecarteurs	170, 197
- Limes à os	257
AUFRIEHT-WALTER, Ecarteurs	170
AUSTIN, Pincettes chirurgicales	86
AXENFELD, Ecarteurs	176
AYERS, Micro pincettes	99

B

BABBUSH, Rugines	209
BABY-ADSON, Pincettes hémostatiques et à ligatures	127
BABY-ALLIS, Pincettes pour saisir les tissus	110
BABY-CRILE, Pincettes hémostatiques	120
BABY-CRILE-WOOD, Porte aiguilles	147
BABY-METZENBAUM, Ciseaux délicats	34
BABY-MIXTER, Pincettes hémostatiques et à ligatures	127
BACKHAUS, Pincettes pour fixer les compresses	112
BALLENGER, Ostéotomes	225
- Bistouris	12
- Rhinologie	238
BALLENGER-HAYEK, Rugines	211
BARON, Canules aspiratrices	291
BARRAQUER, Ecarteurs	174
- Micro porte aiguilles	134, 136
- Pincettes à épiler	106
BARTH, Curettes	261
BEASLEY-BACOCK, Pincettes chirurgicales	87
BEAUPRE, Pincettes à épiler	106
BECKMANN, Spécimens nasaux	200
BEER, Pincettes à épiler	106
BELLUCCI, Canules aspiratrices	291
- Micro Pincettes auriculaires	158
BENGOLEA, Pincettes hémostatiques	126
BERGMANN, Maillets chirurgicales	249
BEYER, Pincettes à os	273
BIEMER, Approximateurs	157
- Clamps vasculaires	155
BIEMER-MÜLLER, Approximateurs	157
BIRCHER-GANSKE, Pincettes pour chirurgie osseuse	276
BIRKETT, Pincettes hémostatiques	126
BIRO, Ciseaux délicats	22
BISHOP-HARMON, Micro Pincettes	100
Bistouris	6 - 12
BLUMENTHAL, Pincettes à os	270
BÖHLER, Pincettes à os	275
BOIES, Rhinologie	283
BONN, Micro Pincettes	100
BONNEY, Pincettes chirurgicales	102
BOYNTON, Porte aiguilles	154
BOWMANN, Sondes	160
BRAUN, Pincettes hémostatiques	114
BROCK, Micro Ciseaux	17
- Micro Pincettes	81
- Micro Porte aiguilles	133
BRÜNINGS, Bistouris	12
BRUNS, Curettes tranchantes	264
BUCKLEY, Ostéotomes	224
BUNT, Pincettes à stérilisation	316

C

Canules aspiratrices	287 - 302
----------------------	-----------

CAPLAN, Ciseaux à os	47
- Rhinologie	283
CARTER, Rugines	212
CASPAR, Manche de bistouris	9
CASTROVIEJO, Micro porte aiguilles	136, 137
- Porte aiguilles	138, 140
- Instruments à mesurer	4
CHADWICK, Ciseaux délicats	22
CHEATTLE, Pincettes à stérilisation	316
CINELLI, Ciseaux délicats	34
- Rhinologie	233
COLLIN, Pincettes à stérilisation	316
CONVERSE, Bistouris	11
- Ecarteurs	172
- Lime à os	254
- Porte aiguilles	145
CONWAY, Ecarteurs	179
CORN, Pincettes chirurgicales	86
CORONAL, Ecarteur	190
COTTLE, Bistouris	11
- Ecarteurs	172, 175, 177, 179
- Ciseaux chirurgicales	23, 46, 64
- Limes à os	257
- Maillets chirurgicales	249
- Micro pincettes	99
- Ostéotomes	230, 236, 237
- Rugines	210, 211, 212
- Rhinologie	201
- Instruments à écraser le cartilage	175
COTTLE-KNAPP, Ciseaux délicats	24
COTTLE-MASING, Ciseaux délicats	22
COTTLE-NEIVERT, Ecarteurs	175
COTTLE-WALSHAM, Rhinologie	282
CRAIG, Rhinologie	283
CRILE, Pincettes hémostatiques	119, 120
CRILE-MURRAY, Porte aiguilles	141
CRILE-WOOD, Porte aiguilles	141, 147, 153
Curettes	261 - 265
CUSHING, Ecarteurs	178, 181, 182
- Rugines	218
- Pincettes chirurgicales	93, 102
CUSHING-KOCHER, Ecarteurs	182

D

DANDY, Pincettes hémostatiques	119
DAVIS, Dissecteurs - Séparateurs	206
- Pincettes à stérilisation	315
DAVIS-BOYLE, Ecarteur buccal	166
DEAN, Ciseaux chirurgicales	45
DEAVER, Ciseaux chirurgicales	32
- Ecarteurs	184
DERF, Porte aiguilles	141, 145
DESMARRES, Ecarteurs	179
- Ecarteur à enduit plastique isolant	130
- Micro Pincettes	99
DE BAKEY, Pincettes atraumatiques	96, 97, 98
- Pincettes chirurgicales	103
- Porte aiguilles	150
DE MARTEL, Pincettes hémostatiques	111
DIEFFENBACH, Clamps	155
DIETRICH, Porte aiguilles	138
DINGMANN, Ecarteur buccal	167
- Pincettes pour chirurgie osseuse	276
- Limes à os	256
Dissecteurs	205 - 208
Ecarteurs	172 - 197
DIXON-LOVELACE, Pincettes hémostatiques	126
DUNN-DAUTREY, Ecarteurs	171
DUPLAY, Spécimens nasaux	3

E

ELSCHNIG, Pincettes chirurgicales	100
EPKER, Ostéotomes	235

F

FACE-LIFT, Ciseaux chirurgiques	67, 69
- Ciseaux Wellenschliff	70
FAGER, Dissecteur - Separateurs	206
FARABEUF, Ecarteurs	180
- Rugines	219
FARABEUF-COLLIN, Rugines	219
FAULKNER, Rhinologie	232
FAURE, Pincés pour fixer les compresses	112
FEICHENFELD, Pincés à échardes	106
FERGUSSON, Canules aspiratrices	290
FERRIS-SMITH-CUSHING, Pincés à os	274
FINSEN, Ecarteurs	191
FOERSTER-BALLENGER, Pincés à tampons	115
FOMON, Bistouris	11
- Ecarteurs	175
- Ciseaux chirurgiques	45, 46, 64
- Ciseaux délicate	34
- Limes à os	255, 259
- Rugines	213
- Rhinologie	233
Ciseaux	15 - 75
FOSTER-GILLIES, Porte aiguilles	144
FOX, Curettes	263
FRAZIER, Canules aspiratrices	290, 293
FREEMAN, Ecarteurs	190
- Ciseaux chirurgiques	66, 71
- Ciseaux Wellenschliff	72
FREEMAN-GORNEY, Ciseaux chirurgiques	66, 71
FREEMAN-KAYE, Ciseaux chirurgiques	66, 67, 73
FREER, Pylons - Ostéotomes	223
- Bistouris	12
- Micro Ecarteurs	175
- Rugines	209, 212, 213, 216
FRIEDMANN, Pincés à os	270, 271

G

GALLAHER, Limes à os	256
GEMINI, Pincés hemostatiques	129
GERALD, Pincés chirurgiques	95, 104
GERALD-BROWN, Pincés chirurgiques	95
GIDEF, Pincés hemostatiques délicate	118
GIESSEN, Ecarteurs	180
GILLIES, Micro ecarteurs	173
- Pincés atraumatiques	98
- Porte aiguilles	144, 148
GIUNTA-NASAL, Ciseaux Wellenschliff	70
GLASSMAN, Ciseaux chirurgiques	27
GOLDMANN, Rhinologie	283
GOLDMAN-FOX, Ciseaux chirurgiques	25, 49, 53
- Ciseaux délicate	25
GOOD, Ciseaux pour les amygdales	43
GORNEY, Canules aspiratrices	289
- Ecarteur	190
- Ciseaux chirurgiques	43, 73
- Ciseaux à os	47
- Ciseaux Wellenschliff	67, 68, 70, 72
GRAEFE, Ciseaux délicate	22
- Micro Pincés	99
- Pincés chirurgiques	86, 100
GREEN, Micro Pincés	99
GREENBERG-PAR, Ciseaux nasaux	48, 54
GREGORY, Ciseaux chirurgiques	69
GROSS, Pincés à tampons	115
GRUENWALD, Pincés auriculaires	105
GUILLIEN, Canules aspiratrices	289
GUTHRIE, Micro ecarteurs	173, 174

H

HABERER, Ecarteurs	168
HALSEY, Porte aiguilles	141, 145
HALSTED, Pincés hemostatiques	120
- Pincés hemostatiques délicate	118

HALSTED-MOSQUITO, Pincés hemostatiques	120
- Pincés hemostatiques délicate	117
HARRINGTON, Ecarteurs	185
HARTMANN, Abaisse langue	169
- Canules aspiratrices	294
- Rhinologie	198, 199
- Spéculum pour adultes	3
HARTMANN-BABY-MOSQUITO, Pincés hemostatiques	117
HEANEY(HEGAR), Porte aiguilles	142
HEGAR, Porte aiguilles	142, 146
HEGAR-MAYO-SEELEY, Porte aiguilles	153
HEISS, Pincés hemostatiques	126
HENAHAN, Rugines	218
HEYMANN, Ciseaux chirurgiques	46
HEYMANN-KNIGHT, Ciseaux chirurgiques	45
HOUSE, Canules aspiratrices	292
- Ecarteur	178
HOWARD, Limes à os	253
HOWARTH, Rugines	211
HUNT, Micro pincés	99
HUNTER, Pincés à échardes	106

I

IRIS, Ciseaux chirurgiques	50, 53
- Ciseaux délicate	20
- Gauche Ciseaux	52
- Ciseaux Wellenschliff	65

J

JACOBSON, Curettes tranchantes	261
- Micro Ciseaux	16
- Micro porte aiguilles	135
- Porte aiguilles	139
JACOBSON-MICRO, Pincés hemostatiques délicate	111
JAEGER, Micro Ecarteurs	174
JAMESON, Ciseaux chirurgiques	23
JAMESON-WERBER, Ciseaux chirurgiques	23
JANSEN, Curettes tranchantes	261
- Pincés à os	272
- Pincés auriculaires	105
- Rugines	219
JONES, Pincés pour fixer les compresses	112, 114
JOSEPH, Bistouris	11, 12
- Ecarteurs	175
- Ciseaux chirurgiques	33, 64
- Limes à os	256
- Rugines	212, 213, 218
- Rhinologie	258

K

KAHN, Ciseaux chirurgiques	44
KAYE, Ciseaux délicate	19
KAYE-FACELIFT, Ciseaux chirurgiques	71
KELLY, Ciseaux chirurgiques	28, 54
- Pincés hemostatiques	123
KERPEL, Curettes tranchantes	263
KERSCHNER, Micro Ecarteurs	173
KEYES, Rhinologie	263
KILLIAN, Ostéotomes	225
- Canules aspiratrices	295
- Rugines	211
- Rhinologie	198, 199, 283
KILLIAN-KLAUS, Ostéotomes	225
KILNER, Ecarteurs	172
- Ciseaux chirurgiques	23, 27, 48, 54
- Ciseaux Wellenschliff	70
KILNER-DOUGHTY, Ecarteur buccal	165
KIRBY, Ecarteurs	175, 179
KLAR-EVATEUR, Ecarteurs	179
KLEINERT-KUTZ, Pincés à os	273
KNAPP, Micro ecarteurs	174
KOCHER, Ecarteurs	182
- Pincés hemostatiques	121, 123, 125

Alphabetisches Inhaltsverzeichnis	Alphabetical index	Indice alfabetico	Indice alfabético	Index alphabétiques
KOCHER-OCHSNER, Pincés hemostátiques		122		
KÖNIG, Elevateur		205		
KRESSNER, Rhinologie		282		
KUHNT, Pincés chirurgiques		100		
L				
LA GRANGE, Ciseaux délicate		25, 49		
LAMBERT, Micro Pincés		99		
LAMBOTTE, Rugines à periostomie		242		
LANGENBECK, Rugines		209, 219		
Laryngoscopes		3		
LEMPERT, Pincés à os		271		
LERICHE, Pincés hemostátiques		119		
LEXER, Ostéotomes		245		
- Ciseaux chirurgiques		41, 62		
LEWIS, Limes à os		257		
LICHTENBERG, Porte aiguilles		154		
LIEBERMANN-TENNANT, Micro Ecarteurs		173		
Lime à os		253 - 260		
LISTER, Pincés hemostátiques		114		
LISTON, Pincés à os		275		
LITTAUER, Pincés à épiler		106		
LITTLER, Ciseaux délicate		34		
LOCKLIN, Ciseaux chirurgiques		24, 28		
LOCKLIN MOD., Ciseaux chirurgiques		24		
LOGAN, Ecarteurs		191		
LORNA, Pincés pour fixer les compresses		113		
LOVE, Ecarteurs		178		
LUCAE, Maillets chirurgiques		248		
- Pincés auriculaires		105		
LUENEBURG, Elevateur		205		
LUER, Ecarteur		178		
- Pincés à os		272		
M				
MacCOLLUM-DINGMAN, Dissecteur		189		
MAGILL, Canules aspiratrices		295		
MAIER, Pincés à tampons		116		
MALINIAC, Ecarteurs nasaux		197		
MALTZ, Bistouris		12		
- Lime à os		259		
- Rhinologie		260		
MARTINI, Curettes tranchantes		261		
Maillets chirurgiques		249 - 250		
MASING, Bistouris		12		
- Rugines		210, 212		
- Rhinologie		233		
MATHIEU, Porte aiguilles		154		
MAYO, Ciseaux chirurgiques		39, 40, 51, 63		
- Pincés à stérilisation		316		
MAYO-HEGAR, Porte aiguilles		142, 146		
MAYO-HEGAR-FINO, Porte aiguilles		147		
MAYO-HEGAR-HEANEY, Porte aiguilles		146		
MAYO-LEXER, Ciseaux chirurgiques		63		
MAYO-NOBLE, Ciseaux chirurgiques		39		
MAYO-STILLE, Ciseaux chirurgiques		42, 62		
MC DONALD, Rugines		216		
MC INDOE, Rhinologie		232		
- Pincés Atraumatiques		98		
MC INTOSH, Set Laryngoscopes		3		
MC IVOR, Ecarteur buccal		166		
MC KENTY, Rugines		211, 213		
MC PHERSON, Pincés chirurgiques		100		
MEAD, Maillets chirurgiques		248		
- Rugines		209		
- Pincés à os		270		
MEDHORN, Clamps vasculaires		155		
METZENBAUM, Ciseaux chirurgiques		33, 35, 36, 48, 50, 58		
- Ciseaux Wellenschliff		65		
METZENBAUM-FINO, Ciseaux chirurgiques		35, 36, 53, 59, 60, 61		
MICRO-HALSTED, Pincés hemostátiques délicate		117		
MICRO-IRIS, Ciseaux délicate		20		
MICRO-RYDER, Porte aiguilles		151, 152		
MICRO-VASCULAR, Porte aiguilles		150		
MILLARD, Ecarteurs		172, 190		
MILLER, Limes à os		253		
MILLIGAN, Dissecteur - Separateur		206		
MINI-FRIEDMANN, Pincés à os		269, 270		
MINI-GILLIES, Porte aiguilles		144, 148		
MINI-LAMBOTTE, Ostéotomes		229		
MINI-LEXER, Ostéotomes		244		
MINI-MALTZ, Lime à os		259		
MINI-OLSEN-HEGAR, Porte aiguilles		143		
MINI-ROUX, Ecarteurs		181		
MOD. MARTIN, Porte coton		161		
MODELL WIEN, Spéculum nasaux		200		
MOLT, Rugines		218		
MÜLLER, Approximateur		157		
N				
NEIVERT, Ecarteurs		177		
NELSON-METZENBAUM, Ciseaux chirurgiques		37		
NEWS, Ecarteur		178		
NOYES, Micro Ciseaux		15		
NUBOER, Canules aspiratrices		288		
O				
OBWEGESER, Aiguilles pour ligatures		159		
- Ecarteurs		170, 183		
- Ostéotomes		247		
- Rugines		215, 217		
O'BRIEN, Ciseaux à ligatures		74		
O'CONNOR, Micro Ecarteurs		174		
OLIVECRONA, Dissecteur - Separateur		207		
- Pincés à os		272		
OLSEN-HEGAR, Porte aiguilles		143, 149		
OMBREDANNE, Maillets chirurgiques		249		
Ostéotomes		223 - 248		
ORINGER, Ecarteur buccal		169		
OVERHOLT, Pincés hemostátiques		128		
OVERHOLT-GEISSENDORFER, Pincés hemostátiques		128		
P				
PARKER-LANGENBECK, Ecarteurs		180		
PAR-TYPE, Ciseaux nasaux		54		
PARTSCH, Ostéotomes - Scalpel		227, 228		
PAPAVERO-HARTMANN, Rhinologie		201		
PAUL, Ecarteurs		176		
PEAN, Pincés hemostátiques		121, 124		
- Pincés hemostátiques délicate		118		
PEAN-MURPHY, Pincés hemostátiques		114		
PECK-JOSEPH, Ciseaux chirurgiques		53		
PEET, Pincés hemostátiques délicate		111		
PENFIELD, Ecarteurs		208		
PENNINGTON, Rugines		211		
Rugines		209 - 219		
PERRY, Pincés chirurgiques		85		
PIERCE, Rugines		211		
Pincés hemostátiques		109 - 130		
Pincés		79 - 106		
PITANGUI, Marcateur		109		
PLESTER, Canules aspiratrices		290		
- Ecarteurs		194		
Porte Aiguilles		133 - 154		
POTTS-SMITH, Pincés chirurgiques		92, 102		
POTTS-YASARGIL, Micro Ciseaux		16		
Q				
QUINBY, Ciseaux délicate		22		
QUINKE, Aiguilles à biopsie		303		
R				
RADOLF, Pincés pour extraire les ongles		280		
RAGNELL, Ecarteurs		180		

- Micro Ciseaux délicate	19
RAGNELL-DAVIS, Ecarteurs	180
RAMPLEY, Pincés à tampons	116
RANKIN, Pincés hemostatiques	123
REYNOLDS, Ciseaux délicate	26
Rhinologie	198 - 201
ROCHESTER-PEAN, Pincés hemostatiques	122, 129
ROGER, Rugines	211
ROGGE, Pincés à stérilisation	315
ROLLET, Micro Ecarteurs	174
ROWE, Pincés à riposition	281
ROSE, Ecarteur	178
ROSTKOWSKI, Ecarteurs	179
ROUX, Ecarteurs	181
ROUX-MAGNUS, Ecarteurs	181
RUBIN, Rhinologie	234, 282
RUSKIN, Rhinologie	273
RUSKIN-LISTON, Pincés à os	275
RUSKIN-STILLE, Pincés à os	273
RYDER, Porte aiguilles	152

S

SAALFELD, Curettes tranchantes	262
SACHS, Dissecteur - Separateur	206
SALZBURG, Rugines	210
SAROT, Porte aiguilles	149
SAUG-RASPATORIUM, Canules aspiratrices	289
SCHAEDEL, Pincés pour fixer les compresses	112
SCHEDE, Curettes tranchantes	264
SCHNEIDER, Rugines	219
SCHNEIDER-SAUERBRUCH, Rugines à périostomie	242
SCHWACKENDIEK, Ciseaux pour les amygdales	43
SCOVILLE, Ecarteurs	182
SEDILLOT, Rugines	214, 219
SEMKEN, Pincés chirurgiques	87, 92, 101
SENN-GREEN, Ecarteurs	180
SENN-MILLER, Ecarteurs	177
SEWALL, Rugines	212
SHEA, Ciseaux chirurgiques	33
SHEEHAN, Ostéotomes	226
SILVER, Rhinologie	232
SIMON, Ecarteurs	184
SPENCER, Ciseaux à ligatures	74
STACKE, Sondes	160
STEINHÄUSER, Rugines	217
STELLA, Ciseaux chirurgiques	68
STELLBRINK, Pincés à os	269, 271
STEVENS, Ciseaux délicate	19, 26, 48
STILLE, Ciseaux chirurgiques	42
- Pincés anatomiques	90
STITCH, Ciseaux délicate	19
Instruments à mesurer	4 - 5
SWEDISH MOD., Porte aiguilles	149

T

TAKAHASHI, Pincés à os	274
TAYLOR, Pincés chirurgiques	102
TENNANT, Pincés chirurgiques	100
TESSIER, Ostéotomes	239, 241
THOREK, Ciseaux chirurgiques	38
TIECK-HALLE, Spéculums nasaux	200
TOBOLD, Abaisse langue	169
TOENNIS, Ciseaux chirurgiques	38
TOENNIS-ADSON, Ciseaux chirurgiques	38, 64
TROELTSCH, Pincés auriculaires	105
TUFFIER, Ecarteurs	168
TUOHY, Aiguilles à biopsie	303

U

UNIVERSAL, Porte-coton	161
UNNA, Curettes tranchantes	262

V

VANNAS, Micro Ciseaux	15
VARADY, Stripper à anneau	195
VERESS, Aiguilles à biopsie	303
VIDAL, Curettes tranchantes	263
WISE, Micro Pincés	79
VOLKMANN, Curettes tranchantes	262, 265

W

WALTER, Ostéotomes	231
WALTON, Ciseaux délicate	19, 34
- Rugines	213
WANGESTEEN, Pincés chirurgiques	102
WARWICK-JAMES, Pincés à ongles	306
WEBSTER, Porte aiguilles	145
WEIL-BLAKESLEY, Pincés à os	274
WEITLANER, Ecarteurs	192, 193
WERTHEIMER, Canules aspiratrices	293
WEST, Ostéotomes - Scalpel	228
WESTCOTT, Micro Ciseaux	15
WHITEHEAD-JENNINGS, Ecarteur buccal	165
WIEDER, Abaisse langue	169
WIENER, Micro Ecarteurs	174
WILLIGER, Curettes tranchantes	261, 265
- Elevateur	205
- Maillets chirurgiques	248
WILMER, Ciseaux délicate	22
WULLSTEIN, Ecarteurs	192
- Micro Pincés auriculaires	158

Y

YANCOSKIE, Ecarteur	190
YANKAUER, Dissecteur	206
- Aiguilles passe-fils	159
YASARGIL, Micro ciseaux	16

Z

ZAUFAL-JANSEN, Pincés à os	273
----------------------------	-----



Nummernverzeichnis		Alphanumerical index		Indice alfanumerico		Indice alfanumérico		Index alphanumériques	
Articolo	Pagina	Articolo	Pagina	Articolo	Pagina	Articolo	Pagina	Articolo	Pagina
712-18	212	BD-57	86	BD-124	89	BD-213	101		
		BD-58	86	BD-126	89	BD-214	101		
718-24G	209	BD-59	86	BD-127	91	BD-215	101		
		BD-60	84	BD-128	93	BD-216	101		
AA-S104	3	BD-60T	104	BD-129	93	BD-217	101		
AA-S503	3	BD-61	90	BD-130	99	BD-218	102		
		BD-62	84	BD-131	99	BD-219	102		
AB-04	3	BD-62T	104	BD-132	99	BD-220	102		
AB-05	3	BD-63	90	BD-133	93	BD-221	103		
AB-06	3	BD-64	84	BD-134	93	BD-222	103		
AB-07	3	BD-65	90	BD-135	99	BD-223	103		
AB-09	3	BD-66	84	BD-136	99	BD-224	103		
AB-32R	3	BD-67	90	BD-138	94	BD-225	103		
AB-41R	3	BD-68	84	BD-139	94	BD-226	102		
		BD-70	88	BD-140	99	BD-227	102		
BB-36	9	BD-71	88	BD-141	88	BD-228	102		
BB-46	9	BD-72	88	BD-144	91	BD-229	103		
BB-48	9	BD-73	88	BD-145	87	BD-230	101		
BB-50	9	BD-74	89	BD-146	105	BD-231	101		
BB-52	9	BD-75	89	BD-147	105	BD-232	102		
		BD-75T	104	BD-148	90	BD-233	102		
BD-04	86	BD-76	89	BD-149	94	BD-234	102		
BD-05	85	BD-78	89	BD-160	96	BD-235	79		
BD-06	85	BD-79	89	BD-160T	103	BD-236	79		
BD-07	86	BD-80	96	BD-161	96	BD-237	79		
BD-09	93	BD-80T	103	BD-161T	103	BD-238	86		
BD-09T	104	BD-81	96	BD-162	96	BD-239	86		
BD-10	89	BD-81T	103	BD-162T	103	BD-240	90		
BD-10IS	130	BD-82	96	BD-163	96	BD-241	90		
BD-14	92	BD-83	96	BD-163T	103	BD-242	90		
BD-15	92	BD-84	96	BD-164	96	BD-243	90		
BD-16	90	BD-84T	103	BD-165	97	BD-244	90		
BD-18	93	BD-85	96	BD-166	97	BD-245	90		
BD-19	93	BD-86	96	BD-167	97	BD-246	90		
BD-20	93	BD-86T	103	BD-168	97	BD-247	90		
BD-20IS	130	BD-87	96	BD-169	97	BD-248	90		
BD-21	92	BD-88	96	BD-170	97	BD-249	90		
BD-22	105	BD-89	96	BD-171	97	BD-250	101		
BD-23	89	BD-90	88	BD-172	97	BD-251	101		
BD-23IS	130	BD-91	92	BD-173	97	BD-252	102		
BD-24	89	BD-92	88	BD-174	106	BD-255	100		
BD-24IS	130	BD-93	88	BD-177	88	BD-256	100		
BD-25	89	BD-95	92	BD-178	88	BD-260	99		
BD-26	89	BD-96	86	BD-179	105	BD-261	99		
BD-30	88	BD-97	89	BD-180	93	BD-263	99		
BD-30T	104	BD-98	89	BD-181	93	BD-271	91		
BD-31	88	BD-99	89	BD-182	93	BD-272	91		
BD-31T	104	BD-100	89	BD-183	93	BD-273	91		
BD-32	85	BD-101	105	BD-186	98	BD-273IS	130		
BD-33	85	BD-102	105	BD-190	98	BD-274	91		
BD-34	85	BD-104	93	BD-191	98	BD-275	91		
BD-35	85	BD-105	89	BD-192	98	BD-276	91		
BD-36	85	BD-106	94	BD-193	105	BD-277	91		
BD-38	93	BD-107	94	BD-194	86	BD-277IS	130		
BD-39	93	BD-108	94	BD-194IS	130	BD-278	91		
BD-40	85	BD-109	91	BD-195	86	BD-279	98		
BD-41	85	BD-110	91	BD-196	86	BD-280	98		
BD-42	85	BD-111	91	BD-200	84	BD-281	92		
BD-42T	104	BD-112	91	BD-201	84	BD-282	92		
BD-43	85	BD-113	91	BD-202	84	BD-287	92		
BD-43T	104	BD-114	91	BD-203	84	BD-288	92		
BD-44	87	BD-115	94	BD-205	84	BD-289	92		
BD-45	87	BD-116	94	BD-206	84	BD-290	92		
BD-46	87	BD-117	94	BD-207	87	BD-291	92		
BD-47	87	BD-118	94	BD-208	87	BD-292	92		
BD-51	87	BD-119	94	BD-209	87	BD-300	101		
BD-53	92	BD-120	106	BD-210	101	BD-333	99		
BD-54	92	BD-122	106	BD-211	101	BD-334	99		
BD-56	86	BD-123	106	BD-212	101	BD-342	172		

Nummernverzeichnis		Alphanumerical index		Indice alfanumerico		Indice alfanumérico		Index alphanumériques	
Articolo	Pagina	Articolo	Pagina	Articolo	Pagina	Articolo	Pagina	Articolo	Pagina
BD-343	172	BS-28	312	BT-160	184	BT-401	181		
		BS-30	312	BT-162	184	BT-402	181		
BF-01	116	BS-40	312	BT-163	184	BT-403	181		
BF-02	116	BS-41	312	BT-167	184	BT-404	181		
BF-05	116	BS-42	312	BT-190	177	BT-405	181		
BF-06	116	BS-43	313	BT-191	177	BT-406	181		
BF-07	116	BS-59	313	BT-192	177	BT-490	130		
BF-08	116	BS-60	313	BT-193	177	BT-491	130		
BF-11	115	BS-61	313	BT-194	177	BT-492	130		
BF-13	115			BT-195	177	BT-493	130		
BF-14	115	BT-05	218	BT-196	172	BT-500	186		
BF-15	115	BT-06	218	BT-197	172	BT-501	186		
BF-20	114	BT-07	218	BT-198	172	BT-501R	186		
BF-24	114	BT-09	179	BT-199	172	BT-502	186		
BF-26	114	BT-15	173	BT-200	175	BT-502R	186		
BF-30	116	BT-16	173	BT-203	173	BT-503	187		
BF-31	116	BT-18	177	BT-204	173	BT-503R	187		
BF-38	112	BT-19	177	BT-207	173	BT-504	187		
BF-40	112	BT-20	180	BT-208	173	BT-504R	187		
BF-41	112	BT-22	172	BT-210	175			BV-07	192
BF-42	112	BT-25	180	BT-211	175	BV-08	191		
BF-43	112	BT-26	180	BT-212	175	BV-09	192		
BF-44	112	BT-27	180	BT-213	175	BV-10	191		
BF-45	112	BT-28	179	BT-214	175	BV-12	191		
BF-46	112	BT-37	214	BT-215	175	BV-20	193		
BF-48	112	BT-38	177	BT-216	175	BV-21	193		
BF-50	113	BT-39	177	BT-217	175	BV-22	193		
BF-52	113	BT-40	177	BT-218	175	BV-23	193		
BF-58	114	BT-41	177	BT-226	172	BV-36	191		
BF-74	113	BT-42	177	BT-228	184	BV-37	191		
BF-75	113	BT-44	177	BT-229	184	BV-38	191		
BF-76	113	BT-45	177	BT-230	174	BV-39	191		
BF-77	113	BT-46	177	BT-231	174	BV-45	191		
BF-78	115	BT-48	180	BT-232	174	BV-47	191		
BF-79	115	BT-49	180	BT-233	174	BV-48	191		
BF-94	115	BT-50	176	BT-234	174	BV-49	191		
BF-95	115	BT-51	176	BT-235	174	BV-51	191		
		BT-52	176	BT-236	174	BV-68	193		
BM-01	149	BT-54	176	BT-237	174	BV-70	193		
BM-02	149	BT-55	176	BT-238	176	BV-90	194		
BM-03	149	BT-56	176	BT-239	176	BV-91	194		
BM-04	149	BT-57	175	BT-240	176	BV-92	194		
BM-28	159	BT-70	179	BT-241	176	BV-93	194		
BM-61	143	BT-71	179	BT-242	176	BV-111	192		
BM-62	143	BT-72	179	BT-243	175	BV-112	192		
BM-63	143	BT-73	179	BT-244	179			CH-11	216
BM-64	143	BT-74	179	BT-245	179	CH-12	216		
BM-74	159	BT-75	179	BT-273	172	CH-13	216		
BM-87	155	BT-76	179	BT-282	181	CH-14	216		
BM-88	155	BT-77	179	BT-283	181			CS-01	311
BM-89	155	BT-79	179	BT-284	181			CS-02	311
BM-90	155	BT-92	183	BT-285	181			CS-03	311
BM-96	155	BT-93	183	BT-286	181			CS-04	311
BM-97	155	BT-94	183	BT-287	181			CS-05	311
BM-98	155	BT-95	183	BT-288	181			CS-06	311
BM-99	155	BT-96	183	BT-289	181			CS-32	313
BM-100	155	BT-100	183	BT-291	180			CS-33	313
BM-101	155	BT-113	182	BT-296	178			CS-34	313
BM-140	155	BT-114	182	BT-297	178			CS-51	311
BM-141	155	BT-115	182	BT-298	178			CS-52	311
BM-142	155	BT-116	182	BT-299	178			CS-55	311
BM-151	159	BT-117	182	BT-312	182			CS-80	311
		BT-118	182	BT-341	185			CS-81	311
BR-20	311	BT-152	183	BT-342	185			CS-82	311
BR-25	311	BT-153	183	BT-381	170			CS-83	311
BR-28	311	BT-154	183	BT-382	177				
		BT-155	183	BT-383	177				
BS-23	312	BT-156	183	BT-387	170				
BS-27	312	BT-157	183	BT-388	170				

Nummernverzeichnis		Alphanumerical index		Indice alfanumerico		Indice alfanumérico		Index alphanumériques	
Articolo	Pagina	Articolo	Pagina	Articolo	Pagina	Articolo	Pagina	Articolo	Pagina
DA-07	86	DO-74	258	DO-178	257	DS-33	263		
		DO-75	257	DO-179	259				
DB-1L	309	DO-76	257	DO-180	235	ES-01	302		
DB-4	310	DO-79	259	DO-181	235	ES-03	302		
DB-6A	310	DO-80	259	DO-182	235	ES-05	296		
DB-22A	310	DO-81	259	DO-183	235	ES-06	296		
DB-50M	309	DO-82	259	DO-184	235	ES-07	296		
DB-86	158	DO-83	259	DO-185	235	ES-08	296		
DB-91	158	DO-84	234	DO-189	258	ES-09	296		
DB-93	158	DO-85	234	DO-190	240	ES-14	266		
DB-96	310	DO-87	258	DO-191	240	ES-15	266		
DB-101	274	DO-91	225	DO-192	240	ES-16	266		
DB-102	274	DO-92	225	DO-193	240	ES-17	266		
DB-106	158	DO-94	171	DO-194	240	ES-18	266		
DB-205	158	DO-95	171	DO-195	240	ES-19	266		
DB-215	158	DO-96	171	DO-196	240	ES-34	296		
DB-299	310	DO-97	171	DO-197	240	ES-35	296		
DB-OL	310	DO-101	217	DO-200	197	ES-36	296		
DB-OLR	309	DO-102	217	DO-211	212	ES-39	301		
		DO-103	217	DO-213	178	ES-41	297		
DL-20	306	DO-106	217	DO-214	178	ES-45	106		
		DO-107	217	DO-215	178	ES-46	106		
DEAN	45	DO-109	258	DO-216	232	ES-48	106		
		DO-111	210	DO-217	232	ES-49	301		
DO-1	253	DO-118	234	DO-218	232	ES-50	301		
DO-2	253	DO-119	234	DO-225	236	ES-51	297		
DO-3	253	DO-125	214	DO-226	236	ES-52	297		
DO-4	253	DO-126	214	DO-227	236	ES-53	297		
DO-5	253	DO-130	230	DO-240	210	ES-54	297		
DO-08	169	DO-131	230	DO-241	210	ES-55	297		
DO-09	169	DO-132	230	DO-244	210	ES-56	297		
DO-10	281	DO-133	230	DO-245	256	ES-57	297		
DO-11	281	DO-138	217	DO-246	256	ES-58	297		
DO-12	281	DO-139	217	DO-259	172	ES-59	297		
DO-13	281	DO-140	230	DO-264	172	ES-60	298		
DO-14	281	DO-141	230	DO-288	283	ES-61	298		
DO-15	281	DO-142	170	DO-289	283	ES-62	298		
DO-20	233	DO-143	230	DO-292	213	ES-63	299		
DO-21	233	DO-144	225	DO-293	213	ES-64	106		
DO-22	233	DO-145	225	DO-294	213	ES-65	106		
DO-23	233	DO-146	225	DO-295	213	ES-66	299		
DO-24	233	DO-147	282	DO-296	213	ES-67	299		
DO-25	233	DO-148	282	DO-301	260	ES-68	298		
DO-26	233	DO-149	282	DO-302	260	ES-69	298		
DO-27	233	DO-150	236	DO-303	260	ES-70	298		
DO-30	159	DO-151	237	DO-304	260	ES-71	298		
DO-31	159	DO-152	237	DO-305	260	ES-72	300		
DO-34	232	DO-153	237	DO-312	260	ES-73	300		
DO-35	232	DO-154	237	DO-315	260	ES-74	300		
DO-36	232	DO-155	237	DO-401	197	ES-75	300		
DO-40	170	DO-156	237			ES-76	299		
DO-41	170	DO-157	282	DP-09	280, 306	ES-77	298		
DO-47	210	DO-158	236	DP-90	278	ES-78	300		
DO-48	197	DO-159	233	DP-120	278	ES-79	299		
DO-50	238	DO-160	231			ES-80	300		
DO-51	238	DO-161	231	DR-40	111	ES-81	299		
DO-52	238	DO-162	231			ES-82	298		
DO-53	238	DO-163	231	DS-15	178	ES-83	299		
DO-54	238	DO-164	231	DS-16	178	ES-84	299		
DO-55	238	DO-165	231	DS-19	178	ES-85	299		
DO-59	215	DO-166	231	DS-20	178	ES-92	301		
DO-60	210	DO-167	231	DS-25	263	ES-102	301		
DO-63	215	DO-168	255	DS-26	262	ES-111	302		
DO-65	215	DO-169	255	DS-27	262	ES-112	302		
DO-67	215	DO-170	234	DS-28	262	ES-120	190		
DO-70	257	DO-171	234	DS-29	262	ES-121	190		
DO-71	257	DO-172	234	DS-30	263	ES-122	190		
DO-72	258	DO-173	232	DS-31	263	ES-123	190		
DO-73	258	DO-177	259	DS-32	263	ES-124	190		

Nummernverzeichnis		Alphanumerical index		Indice alfanumerico		Indice alfanumérico		Index alphanumériques	
Articolo	Pagina	Articolo	Pagina	Articolo	Pagina	Articolo	Pagina	Articolo	Pagina
ES-125	190	FD-105	134	FE-30	156	FG-41	45		
ES-126	190	FD-106	134	FE-31	156	FG-43	34		
ES-127	190	FD-107	134	FE-32	156	FG-44	34		
ES-128	190	FD-108	134	FE-33	156	FG-45	38		
ES-131	188	FD-113	134	FE-34	156	FG-46	38		
ES-132	188	FD-114	134	FE-35	156	FG-47	32		
ES-133	188	FD-115	134	FE-36	156	FG-48	32		
ES-134	188	FD-116	134	FE-37	156	FG-49	32		
ES-135	188	FD-117	106	FE-38	156	FG-50	26		
ES-140	189	FD-128	138	FE-39	156	FG-51	26		
ES-141	189	FD-137	16	FE-40	156	FG-52	26		
ES-142	189	FD-138	16	FE-41	156	FG-53	26		
ES-143	188	FD-148	139	FE-42	156	FG-54	26		
ES-145	188	FD-149	139	FE-43	156	FG-55	26		
ES-150	195	FD-152	136	FE-44	156	FG-56	26		
ES-151	195	FD-153	136	FE-45	156	FG-57	26		
ES-152	195	FD-172	140	FE-46	156	FG-58	23		
ES-153	195	FD-173	140	FE-47	156	FG-59	23		
ES-200	109	FD-186	16	FE-48	156	FG-60	38		
ES-201	109	FD-187	16	FE-49	156	FG-61	38		
ES-202	109	FD-191	16	FE-50	156	FG-63	64		
		FD-201	81	FE-51	156	FG-64	64		
FB-107	195	FD-202	81	FE-52	156	FG-65	38		
FB-108	195	FD-203	81, 133	FE-53	156	FG-66	27		
FB-109	195	FD-204	81, 133	FE-54	156	FG-67	27		
FB-120	111	FD-211	133	FE-55	156	FG-68	27		
FB-390	196	FD-213	133	FE-56	156	FG-69	27		
FB-392	196	FD-218	139	FE-57	156	FG-73	38		
FB-394	196	FD-219	139	FE-58	156	FG-74	38		
FB-395	196	FD-221	17	FE-59	156	FG-75	38		
FB-396	196	FD-223	17	FE-60	156	FG-90	33		
FB-397	196	FD-246	135			FG-91	33		
FB-398	196	FD-247	135	FF-70	274	FG-92	53		
FB-400	196	FD-248	135			FG-93	34		
		FD-249	135	FG-1	20	FG-94	22		
FD-06	15	FD-306	17	FG-1SC	50	FG-95	34		
FD-08	15	FD-307	17	FG-1TC	53	FG-98	53		
FD-10	15	FD-310	17	FG-2	20	FG-99	45		
FD-12	15	FD-311	17	FG-2SC	50	FG-100	34		
FD-13	15	FD-500	155	FG-2TC	53	FG-101	21		
FD-14	136	FD-501	155	FG-3	22	FG-102	21		
FD-16	136	FD-502	155	FG-4	20	FG-103	21		
FD-17	136	FD-503	155	FG-5	20	FG-104	20		
FD-18	136	FD-504	155	FG-6C	27	FG-105	21		
FD-19	136	FD-505	155	FG-6R	27	FG-108	22		
FD-20	136	FD-506	155	FG-7	46	FG-109	22		
FD-21	137	FD-507	157	FG-8	46	FG-110	47		
FD-22	137	FD-508	157	FG-9	46	FG-112	24		
FD-23	137	FD-509	157	FG-10	43	FG-113	24		
FD-24	134	FD-510	157	FG-11L	52	FG-116	44		
FD-25	137	FD-511	157	FG-12L	52	FG-117	32		
FD-27	138	FD-512	157	FG-13	20	FG-122	22		
FD-28	137	FD-513	157	FG-14	36	FG-123	23		
FD-29	137	FD-514	157	FG-15	20	FG-124	23		
FD-30	139	FD-515	157	FG-16	32	FG-125	43		
FD-31	140	FD-517	157	FG-17	32	FG-126	43		
FD-32	139	FD-518	157	FG-18	32	FG-127	43		
FD-33	138	FD-519	157	FG-19C	27	FG-128	43		
FD-34	140	FD-520	157	FG-19R	27	FG-135	43		
FD-35	138			FG-21	23	FG-136	43		
FD-36	140	FE-21	156	FG-22	23	FG-146	34		
FD-37	140	FE-22	156	FG-23	21	FG-147	33		
FD-39	138	FE-23	156	FG-24	21	FG-148	33		
FD-45	15	FE-24	156	FG-28	36	FG-151	74		
FD-46	15	FE-25	156	FG-30	22	FG-153	64		
FD-63	135	FE-26	156	FG-36	23	FG-154	64		
FD-79	15	FE-27	156	FG-37	23	FG-156	24		
FD-80	15	FE-28	156	FG-38	22	FG-157	24		
FD-81	15	FE-29	156	FG-39	22	FG-158	24		

Nummernverzeichnis		Alphanumerical index		Indice alfanumerico		Indice alfanumérico		Index alphanumériques	
Articolo	Pagina	Articolo	Pagina	Articolo	Pagina	Articolo	Pagina	Articolo	Pagina
FG-159	24	FK-110	264	FL-23	227	FL-267	229		
FG-165	64	FK-111	264	FL-24	227	FL-268	229		
FG-166	64	FK-112	264	FL-32	229	FL-269	229		
FG-167	53	FK-113	264	FL-40	227	FL-272	245		
FG-168	53	FK-114	264	FL-53	229	FL-280	246		
FG-182	44	FK-115	264	FL-54	229	FL-281	246		
FG-183	44	FK-116	264	FL-58	229	FL-282	246		
FG-184	44	FK-120	264	FL-59	244	FL-283	246		
FG-185	44	FK-121	264	FL-60	244	FL-307	241		
FG-186	44	FK-122	264	FL-61	244	FL-308	241		
FG-187	44	FK-123	264	FL-62	244	FL-309	241		
FG-200	18	FK-124	264	FL-104	249	FL-310	241		
FG-201	18	FK-125	264	FL-105	249	FL-311	241		
FG-202	18	FK-126	264	FL-108	249	FL-312	241		
FG-203	18	FK-136	263	FL-114	227	FL-334	247		
FG-204	18	FK-137	263	FL-115	227	FL-335	247		
FG-205	18	FK-138	263	FL-116	227	FL-336	247		
FG-206	18	FK-139	263	FL-118	227	FL-337	247		
FG-207	18	FK-174	254	FL-126	227	FL-380	226		
FG-208	18	FK-175	255	FL-127	227	FL-381	226		
FG-209	19	FK-177	262	FL-132	227	FL-382	226		
FG-210	19	FK-178	262	FL-133	228	FL-383	226		
FG-211	19	FK-193	256	FL-134	228	FL-384	226		
FG-212	19	FK-194	256	FL-135	227	FL-385	226		
FG-215	19	FK-195	256	FL-136	227	FL-386	226		
FG-216	19	FK-196	256	FL-138	227	FL-387	226		
FG-217	19	FK-197	265	FL-141	224	FL-388	226		
FG-218	19	FK-198	265	FL-142	224	FL-401	239		
FG-219	19	FK-230	243	FL-143	224	FL-402	239		
		FK-232	243	FL-144	224	FL-403	239		
FK-1	28	FK-234	243	FL-150	263	FL-404	239		
FK-1TC	54	FK-247	219	FL-151	263	FL-405	239		
FK-2	28	FK-248	219	FL-152	263	FL-410	239		
FK-2TC	54	FK-249	219	FL-153	263	FL-411	239		
FK-10	28	FK-250	219	FL-154	263	FL-412	239		
FK-12	209	FK-251	219	FL-155	263				
FK-15	242	FK-252	218	FL-156	263	FM-1	35		
FK-16	242	FK-253	219	FL-157	263	FM-1F	35		
FK-17	242	FK-254	219	FL-158	263	FM-1SC	50		
FK-60	265	FK-255	219	FL-159	263	FM-2	35		
FK-61	265	FK-256	219	FL-177	228	FM-2F	35		
FK-62	265	FK-257	219	FL-179	228	FM-2SC	50		
FK-63	265	FK-258	219	FL-181	228	FM-3	35		
FK-64	265	FK-259	242	FL-185	228	FM-3F	35		
FK-65	265	FK-260	218	FL-186	228	FM-3SC	50		
FK-66	265	FK-261	218	FL-187	228	FM-4	35		
FK-67	265	FK-262	218	FL-210	245	FM-4F	35		
FK-68	265	FK-263	218	FL-211	245	FM-4SC	50		
FK-69	265	FK-264	213	FL-212	245	FM-5	39		
FK-70	261	FK-265	213	FL-213	245	FM-5SC	51		
FK-71	261			FL-214	245	FM-6	39		
FK-72	262	FL-01	248	FL-215	245	FM-6SC	51		
FK-73	262	FL-02	248	FL-216	245	FM-7	31		
FK-74	262	FL-03	227	FL-220	245	FM-7L	52		
FK-75	261	FL-04	227	FL-221	245	FM-8	31		
FK-76	261	FL-05	227	FL-222	245	FM-8L	52		
FK-77	261	FL-09	248	FL-223	245	FM-9	29		
FK-78	261	FL-09R	248	FL-224	245	FM-9L	52		
FK-79	262	FL-10M	248	FL-225	245	FM-10	29		
FK-80	218	FL-11	248	FL-226	245	FM-10L	52		
FK-82	212, 218	FL-11R	248	FL-230	244	FM-11	37		
FK-83	261	FL-12	248	FL-231	244	FM-12	33		
FK-84	261	FL-12R	248	FL-232	244	FM-13	37		
FK-87	28	FL-13	227	FL-233	244	FM-24	39		
FK-88	28	FL-14	227	FL-234	244	FM-24SC	51		
FK-96	254	FL-15	227	FL-263	229	FM-25	39		
FK-97	254	FL-16	229	FL-264	229	FM-25SC	51		
FK-98	254	FL-17	229	FL-265	229	FM-27	30		
FK-99	254	FL-18	229	FL-266	229	FM-28	30		

Nummernverzeichnis

Alphanumerical index

Indice alfanumerico

Indice alfanumérico

Index alphanumériques

Articolo	Pagina	Articolo	Pagina	Articolo	Pagina	Articolo	Pagina
FM-29	30	FM-98	61	FM-300	48	FO-146	275
FM-29L	52	FM-99	61	FM-301	48	FO-156	273
FM-29SC	51	FM-100	65	FM-305	70	FO-157	273
FM-30	30	FM-102	65	FM-306	71	FO-159	280
FM-30L	52	FM-104	65	FM-307	71	FO-180	274
FM-30SC	51	FM-109	33	FM-310	71	FO-190	47
FM-31	30	FM-110	42	FM-311	66	FO-218	276
FM-32	30	FM-111	42	FM-312	67	FO-219	276
FM-33	30	FM-112	37	FM-316	54	FO-220	269
FM-34	30	FM-113	37	FM-317	54	FO-299	280
FM-35	29	FM-114	37	FM-320	68	FO-300	280
FM-36	29	FM-115	37	FM-321	68	FO-490	283
FM-37	29	FM-116	37	FM-323	68		
FM-38	29	FM-117	37	FM-324	73	FR-10	205
FM-39	29	FM-118	54	FM-325	66	FR-11	12
FM-40	29	FM-119	54	FM-326	66	FR-12	11
FM-41	31	FM-120	36	FM-328	72	FR-15	209
FM-42	31	FM-121	36	FM-329	72	FR-18	12
FM-43	31	FM-122	36	FM-330	71	FR-19	12
FM-44	31	FM-126	33	FM-331	72	FR-48	11
FM-45	31	FM-127	33	FM-334	66	FR-49	12
FM-46	31	FM-130	62	FM-335	67	FR-64	213
FM-47	34	FM-131	62	FM-336	73	FR-65	213
FM-48	34	FM-132	62	FM-337	73	FR-66	212
FM-49	30	FM-133	62	FM-338	67	FR-67	212
FM-50	55	FM-134	62	FM-339	69	FR-100	216
FM-51	55	FM-135	62	FM-340	69	FR-166	216
FM-52	55	FM-136	62	FM-341	68	FR-167	216
FM-53	55	FM-137	62	FM-342	69	FR-168	12
FM-54	56	FM-139	63	FM-343	70	FR-169	12
FM-55	56	FM-140	63	FM-344	70	FR-175	12
FM-56	56	FM-141	63	FM-350	54	FR-176	11
FM-57	56	FM-142	63	FM-351	70	FR-177	12
FM-58	57	FM-143	63				
FM-59	57	FM-145	57	FO-15	270	FREER	209
FM-60	57	FM-146	57	FO-16	271		
FM-61	57	FM-147	57	FO-17	270	GF-20	288
FM-62	30	FM-148	55	FO-18	272	GF-40	303
FM-63	30	FM-149	55	FO-19	270	GF-41	293
FM-66	58	FM-150	55	FO-20	273	GF-42	293
FM-67	58	FM-151	56	FO-21	270	GF-43	291
FM-68	58	FM-152	56	FO-22	269	GF-45	291
FM-69	58	FM-153	56	FO-23	269	GF-47	291
FM-70	36	FM-160	58	FO-24	269	GF-48	289
FM-71	36	FM-161	58	FO-25	271	GF-49	289
FM-72	31	FM-162	58	FO-34	273	GF-50	289
FM-73	31	FM-163	58	FO-35	273	GF-53	292
FM-74	36	FM-180	41	FO-37	272	GF-55	292
FM-75	36	FM-181	41	FO-39	272	GF-56	292
FM-76	42	FM-188	39	FO-43	271	GF-57	292
FM-77	42	FM-189	39	FO-45	272	GF-58	292
FM-78	42	FM-201	59	FO-47	276	GF-59	292
FM-79	42	FM-202	60	FO-58	275	GF-60	293
FM-80	40	FM-203	59	FO-59	275	GF-61	293
FM-81	40	FM-204	60	FO-60	275	GF-63	291
FM-82	40	FM-205	59	FO-61	275	GF-65	291
FM-83	40	FM-206	60	FO-63	47	GF-67	291
FM-84	40	FM-207	59	FO-87	271	GF-69	293
FM-85	40	FM-208	60	FO-88	269	GF-70	293
FM-86	41	FM-209	59	FO-89	269	GF-71	289
FM-87	41	FM-210	60	FO-108	275	GF-72	289
FM-88	41	FM-211	59	FO-130	276	GF-73	289
FM-89	41	FM-212	60	FO-131	276	GF-74	289
FM-90	61	FM-294	48	FO-138	273	GF-75	287
FM-91	61	FM-295	48	FO-139	273	GF-76	287
FM-92	61	FM-296	48	FO-141	282	GF-77	287
FM-94	61	FM-297	48	FO-142	282	GF-85	295
FM-96	53, 61	FM-298	48	FO-143	283	GF-86	295
FM-97	61	FM-299	48	FO-144	47, 283	GF-87	295

Nummernverzeichnis		Alphanumerical index		Indice alfanumerico		Indice alfanumérico		Index alphanumériques	
Articolo	Pagina	Articolo	Pagina	Articolo	Pagina	Articolo	Pagina	Articolo	Pagina
GF-88	295	GS-21	304	KO-71	213	MF-102T	104		
GF-89	303	GS-22	306	KO-72	213	MF-103	95		
GF-90	303	GS-23	75			MF-104	95		
GF-92	294	GS-24	75	LB-10	7	MF-105	95		
GF-93	294	GS-25	75	LB-11	7	MF-110	80		
GF-94	294	GS-26	75	LB-12	7	MF-111	80		
GF-96	294	GS-27	75	LB-13	7	MF-112	80		
GF-97	294	GS-28	75	LB-15	7	MF-113	80		
GF-98	288	GS-29	75	LB-20	8	MF-114	80		
GF-99	288	GS-30	316	LB-21	8	MF-115	80		
GF-100	295	GS-32	305	LB-22	8	MF-124	82		
GF-101	295	GS-34	305	LB-23	8	MF-125	82		
GF-102	295	GS-35	305	LB-25	8	MF-126	82		
GF-103	295	GS-36	305	LB-40	10	MF-127	82		
GF-104	288	GS-37	305	LB-361	9	MF-128	82		
GF-110	288	GS-38	305	LB-362	9	MF-129	82		
GF-111	294	GS-40	306	LB-363	9	MF-142T	82		
GF-112	294	GS-41	304	LB-364	9	MF-143T	82		
GF-113	294	GS-42	304	LB-365	9	MF-148	82		
GF-140	290	GS-43	304	LB-366	9	MF-149	82		
GF-141	290	GS-44	304	LB-367	9	MF-150	100		
GF-142	290	GS-45	304	LB-368	9	MF-175	100		
GF-143	290	GS-46	305	LB-369	9	MF-176	100		
GF-144	290	GS-48	305			MF-177	100		
GF-150	290	GS-50	306	LG-1	25	MF-178	100		
GF-151	290			LG-1SC	49	MF-179	100		
GF-152	290	KO-1	205	LG-2SC	49	MF-180	100		
GF-153	290	KO-2	205			MF-181	100		
GF-154	290	KO-11	211	LK-1	24	MF-182	100		
GF-188	303	KO-12	211	LK-2	28	MF-230	100		
GF-200	303	KO-13	211	LK-3	24	MF-235	100		
GF-232	291	KO-14	207	LK-4	28	MF-342T	82		
GF-240	290	KO-15	207			MF-343T	82		
GF-241	290	KO-16	207	LS-04	5	MF-354T	83		
GF-242	290	KO-17	207	LS-06	5	MF-355T	83		
GF-243	290	KO-18	206	LS-07	5	MF-356T	83		
GF-244	290	KO-19	206	LS-08	5	MF-357T	83		
GF-256	295	KO-20	209	LS-09	5	MF-358T	83		
GF-257	295	KO-21	206			MF-359T	83		
		KO-24	206	LX-102	277	MF-362T	83		
GFC	25	KO-25	206	LX-103	277	MF-363T	83		
GFC-S	21	KO-26	206	LX-109	275	MF-364T	83		
GFC-SC	49	KO-27	206	LX-125	278	MF-365T	83		
GFC-TC	53	KO-28	206	LX-138	279				
		KO-29	206	LX-139	279	MO-15	218		
GFR	25	KO-30	211	LX-140	279				
GFR-S	21	KO-38	216	LX-141	279	NK-1	9		
GFR-SC	49	KO-39	209			NK-2	9		
GFR-TC	53	KO-40	208	MA-B1	6	NK-12	10		
		KO-41	208	MA-B2	7	NK-80	174		
GFS	25	KO-42	208	MA-B3	6	NK-82	174		
GFS-SC	49	KO-43	208	MA-B3M	6	NK-83	174		
		KO-44	208	MA-B4	8	NK-84	174		
GS-01	316	KO-46	211	MA-B7	6	NK-86	174		
GS-02	315	KO-47	207	MA-B7K	6	NK-100	11		
GS-03	315	KO-48	207	MA-B8	7	NK-101	11		
GS-04	315	KO-49	207	MA-B9	7	NK-102	11		
GS-05	316	KO-50	207	MA-B10	8	NK-144	179		
GS-06	315	KO-54	206			NK-145	179		
GS-07	316	KO-61	211	MEAD	209	NK-251	180		
GS-09	316	KO-62	211			NK-420	173		
GS-10	315	KO-63	211	MF-04	79	NK-421	173		
GS-11	315	KO-64	211	MF-81	79	NK-422	173		
GS-13	316	KO-65	211	MF-82	79	NK-430	11		
GS-14	316	KO-66	211	MF-93	79	NK-431	11		
GS-16	10	KO-67	212	MF-94	79	NK-432	11		
GS-18	10	KO-68	212	MF-101	95	NK-433	11		
GS-19	306	KO-69	212	MF-101T	104				
GS-20	305	KO-70	213	MF-102	95	OL-01	302		

Nummernverzeichnis		Alphanumerical index		Indice alfanumerico		Indice alfanumérico		Index alphanumériques	
Articolo	Pagina	Articolo	Pagina	Articolo	Pagina	Articolo	Pagina	Articolo	Pagina
OL-02	302	OM-145	166	P-66	126	P-200	126		
OL-03	302	OM-146	166	P-67	126	P-205	126		
OL-04	302	OM-160	165	P-68	118	P-206	126		
OL-05	302	OM-161	165	P-69	118	P-207	111		
OL-41	303	OM-162	165	P-70	125	P-208	126		
OL-42	303	OM-163	165	P-71	125	P-209	126		
OL-43	303	OM-164	165	P-72	125	P-210	129		
OL-44	303	OM-170	166	P-73	125	P-215	129		
OL-45	303	OM-171	166	P-74	125	P-216	129		
OL-46	303	OM-172	166	P-75	125	P-217	129		
OL-47	303	OM-173	166	P-76	125	P-221	122		
OL-48	303	OM-174	166	P-77	125	P-230	120		
OL-49	303			P-79	123	P-231	120		
		OR-11	4	P-81	119	P-232	120		
OM-06	169	OR-13	4	P-82	119	P-233	120		
OM-08	169	OR-15	4	P-84	123	P-234	120		
OM-20	198	OR-17	4	P-85	123	P-235	120		
OM-21	198	OR-19	4	P-86	119	P-236	120		
OM-22	198	OR-40	5	P-87	119	P-237	120		
OM-23	198	OR-45	5	P-89	123	P-238	120		
OM-24	198			P-91	118	P-239	120		
OM-25	201	P-08	114	P-92	118	P-240	120		
OM-26	198	P-09	114	P-93	118	P-241	120		
OM-27	201	P-15	127	P-94	118	P-242	120		
OM-28	201	P-16	119	P-95	117	P-243	120		
OM-29	201	P-17	118	P-96	117	P-244	120		
OM-31	198	P-18	122	P-97	117	P-245	120		
OM-32	199	P-19	122	P-98	117	P-246	123		
OM-34	199	P-20	124	P-100	110	P-247	123		
OM-36	199	P-21	124	P-101	117	P-248	126		
OM-38	199	P-22	124	P-102	117	P-249	126		
OM-39	201	P-23	124	P-115	110	P-250	121		
OM-48	200	P-24	124	P-118	110	P-251	121		
OM-49	200	P-25	124	P-119	110	P-252	121		
OM-51	200	P-26	124	P-120	117	P-253	121		
OM-53	200	P-28	122	P-121	117	P-254	121		
OM-54	200	P-29	122	P-122	119	P-255	121		
OM-56	200	P-30	124	P-132	110	P-256	121		
OM-57	200	P-31	124	P-133	110	P-257	121		
OM-59	200	P-32	124	P-134	110	P-258	121		
OM-74	169	P-33	124	P-135	117	P-259	121		
OM-75	169	P-34	124	P-136	127	P-260	121		
OM-76	169	P-35	124	P-137	127	P-261	121		
OM-77	169	P-36	124	P-138	127	P-262	121		
OM-80	168	P-38	122	P-139	127	P-263	121		
OM-81	168	P-39	122	P-142	128	P-266	111		
OM-82	168	P-40	125	P-143	128	P-267	111		
OM-85	168	P-41	125	P-144	128				
OM-87	168	P-42	125	P-145	128	PF-7	160		
OM-88	168	P-43	125	P-146	128	PF-14	160		
OM-99	168	P-44	125	P-147	128	PF-15	160		
OM-101	168	P-45	125	P-148	128	PF-20	160		
OM-102	168	P-46	125	P-160	128	PF-21	160		
OM-103	168	P-47	125	P-161	128	PF-22	160		
OM-104	168	P-49	123	P-162	128	PF-23	160		
OM-110	167	P-50	110	P-163	128	PF-25	160		
OM-111	167	P-51	110	P-164	128	PF-26	160		
OM-112	167	P-53	110	P-165	128	PF-27	160		
OM-113	167	P-54	123	P-166	128	PF-28	160		
OM-114	167	P-55	123	P-170	127	PF-29	160		
OM-136	165	P-56	122	P-171	127	PF-30	160		
OM-137	165	P-57	122	P-172	127	PF-31	160		
OM-138	165	P-58	122	P-173	127	PF-32	160		
OM-139	165	P-59	122	P-191	129	PF-33	160		
OM-140	166	P-61	119	P-192	129	PF-34	160		
OM-141	166	P-62	119	P-193	129	PF-35	160		
OM-142	166	P-63	119	P-194	129	PF-36	160		
OM-143	166	P-64	119	P-195	129	PF-37	160		
OM-144	166	P-65	126	P-196	129	PF-38	160		

Nummernverzeichnis		Alphanumerical index		Indice alfanumerico		Indice alfanumérico		Index alphanumériques	
Articolo	Pagina	Articolo	Pagina	Articolo	Pagina	Articolo	Pagina	Articolo	Pagina
PF-40	161	PH-112	150						
PF-41	161	PH-113	150	VS-20	311				
PF-43	161	PH-114	150	VS-26	311				
PF-44	160	PH-120	146	VS-30	311				
PF-46	161	PH-121	146						
PF-48	161	PH-122	146	WG-10	205				
PF-49	161	PH-123	146	WG-12	205				
PF-50	161	PH-124	146	WG-14	205				
PF-51	161	PH-125	146						
PF-52	161	PH-127	147						
PF-62	161	PH-128	147						
PF-63	161	PH-129	147						
PF-64	161	PH-130	153						
		PH-132	149						
		PH-133	149						
PH-38	141	PH-134	149						
PH-39	141	PH-140	151						
PH-40	142	PH-141	151						
PH-41	142	PH-142	151						
PH-42	142	PH-143	151						
PH-43	142	PH-144	151						
PH-44	142	PH-145	151						
PH-45	142								
PH-48	141	PO-50	154						
PH-52	142	PO-51	154						
PH-53	145	PO-52	154						
PH-54	147	PO-55	154						
PH-58	153	PO-56	154						
PH-59	146	PO-59	144						
PH-61	141	PO-85	154						
PH-62	141	PO-86	154						
PH-63	141	PO-87	154						
PH-64	141	PO-89	144						
PH-65	145	PO-97	148						
PH-66	145	PO-97L	148						
PH-67	145	PO-99	148						
PH-68	145	PO-99L	148						
PH-69	145	PO-104	144						
PH-70	142	PO-105	144						
PH-71	147								
PH-72	146	SC-1	74						
PH-73	145	SC-2	74						
PH-74	142	SC-5	74						
PH-75	146	SC-9	74						
PH-76	146	SC-12	74						
PH-77	147								
PH-78	142	TG-10	223						
PH-79	147	TG-11	212, 223						
PH-80	152	TG-12	223						
PH-81	152	TG-20	223						
PH-82	152	TG-21	223						
PH-83	152	TG-22	223						
PH-84	152	TG-23	212, 223						
PH-85	147	TG-30	224						
PH-90	147	TG-31	224						
PH-95	146	TG-32	224						
PH-96	146	TG-40	224						
PH-97	146	TG-41	224						
PH-99	153								
PH-100	153	TS-50	294						
PH-101	150	TS-101	314						
PH-102	150	TS-102	314						
PH-103	150	TS-103	314						
PH-104	150	TS-104	314						
PH-106	149								
PH-107	149	VH-20	279						
PH-108	149	VH-21	279						
PH-109	150	VH-23	279						
PH-110	150	VH-40	278						
PH-111	150								

German quality - nothing less



BROMED
INSTRUMENTS

Addendum



Chirurgia Plastica
Cirugía Plástica
Chirurgie Plastique

Plastische Chirurgie
Plastic Surgery

Wundhaken mit
Fiberoptikstab

Retractors with
Fiber optic

Divaricatore con
fibra ottica

Retractor con
iluminación de luz fría

Ecarteur avec illumination
à lumière froide

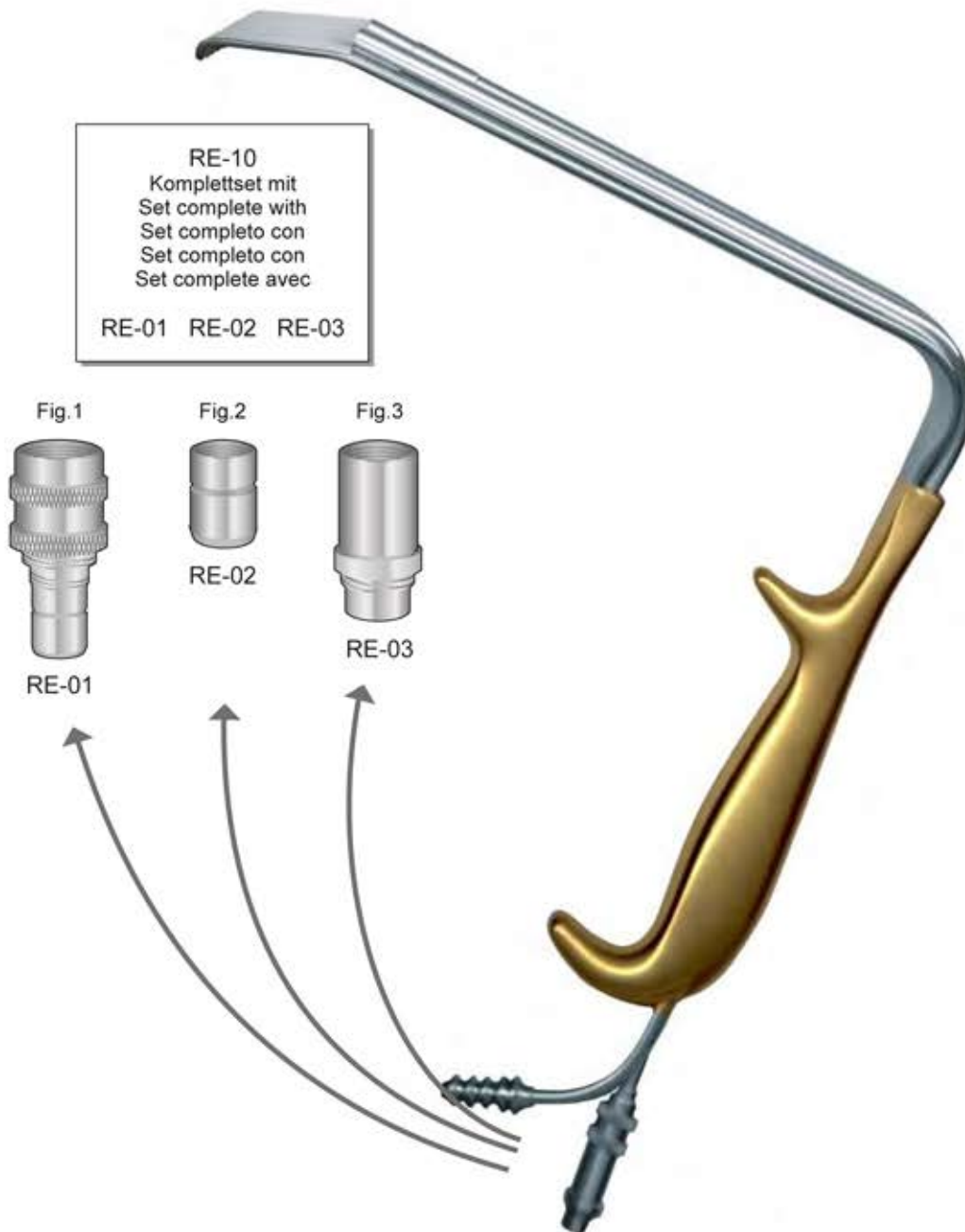

Fiber Optic Retractor - Divaricatore a fibra ottica

Advantages - Vantaggi

Sterilizable. Removable. Protected fiber-optic piece
Oval Shaped optic end for great light field
Retractor with concave blade for added operative space and visibility
Equiped with universal adapters WOLF, STORZ, OLYMPUS
German Stainless Steel, cool Fiber optic light sterilizable till 134°C

Asportabile e sterilizzabile. Fibra ottica protetta su tutto lo strumento per garantire una maggiore stabilità e sicurezza del movimento
Progettato e realizzato per garantire all'operatore massima maneggevolezza ed alta intensità di luce fredda in tutte quelle situazioni che comportano una visione operatoria a cielo chiuso
Grazie ai suoi tre attacchi universali WOLF, STORZ e OLYMPUS, facilita l'operatore nel potersi muovere da un ambito ambulatoriale ad uno ospedaliero senza dover rinunciare a un campo visivo indispensabile per la sua professione
Acciaio tedesco Fiber Optic luce fredda, Sterilizzabile fino a 134°C

Sizes - Misure dei divaricatori:

BT-501	90 x 24 mm	RE-01	Fig.1
BT-502	115 x 24 mm	RE-02	Fig.2
BT-503	150 x 36 mm	RE-03	Fig.3
BT-504	190 x 30 mm	RE-10	Set Fig.1 + Fig.2 + Fig.3

Wundhaken mit
Fiberoptikstab oval

Retractors with
Fiber optic oval

Divaricatori a
fibre ottiche ovale

Retractor con
iluminación de luz fría

Ecarteur avec
illumination à lumière froide

Wundhaken mit Fiberoptikstab
Retractors with Fiber optic illumination
Divaricatori con illuminazione a fibre ottiche
Retractor con iluminación de luz fría
Ecarteur avec illumination à lumière froide

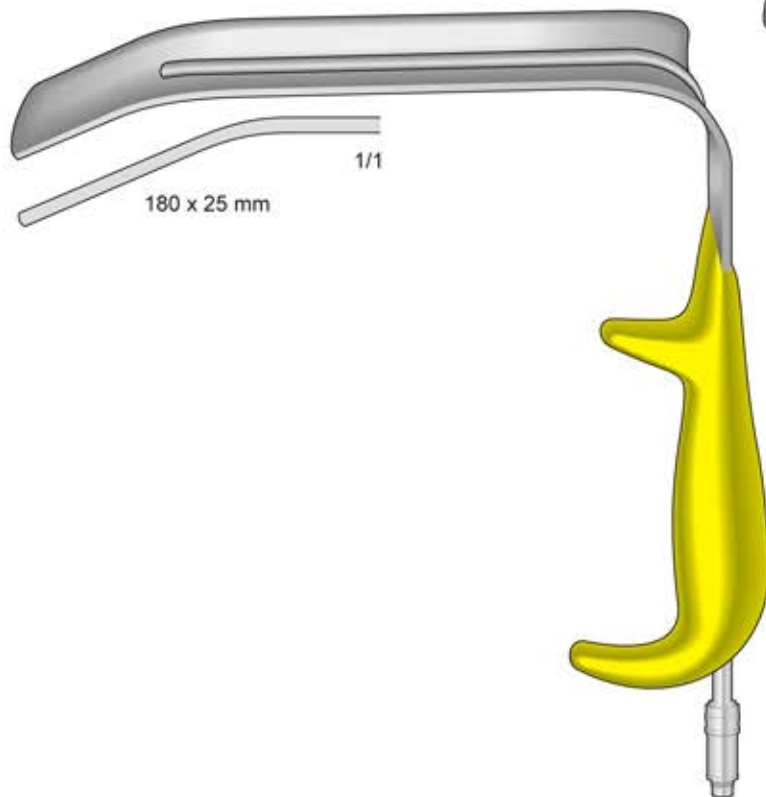

BT-505

Wundhaken - Retractor
Divaricatore - Separador
Ecarteur

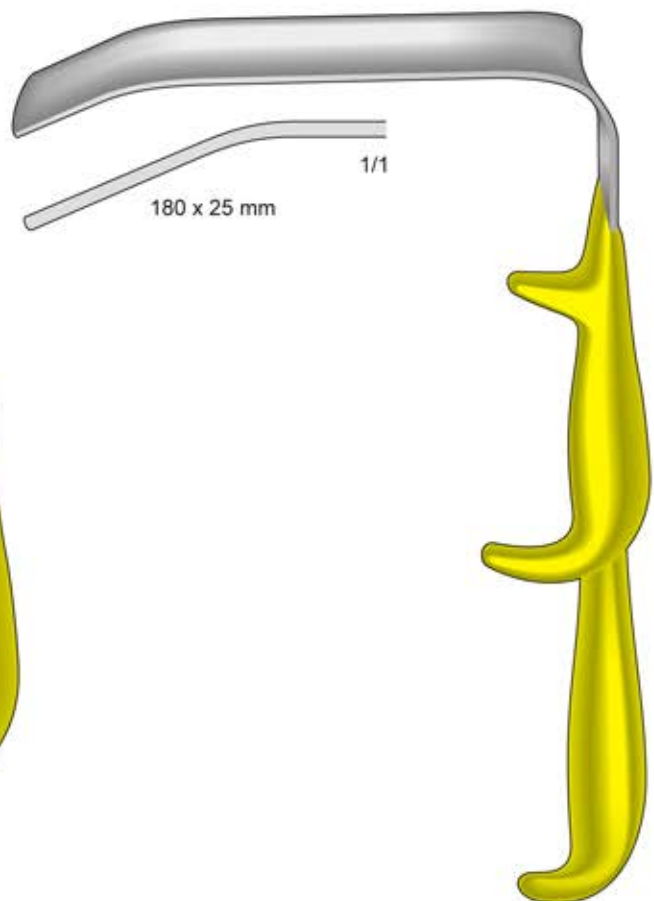

BT-510

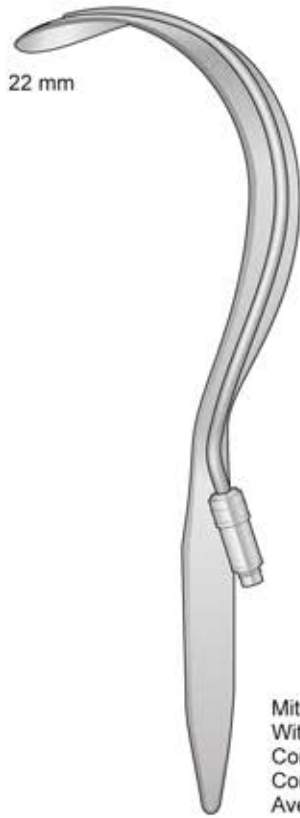

22 mm

Mit Fiberoptikstab
With Fiber optic
Con illuminazione a fibre ottiche
Con iluminación de luz fría
Avec illumination à lumière froide

DEAVER
BT-511
215 mm

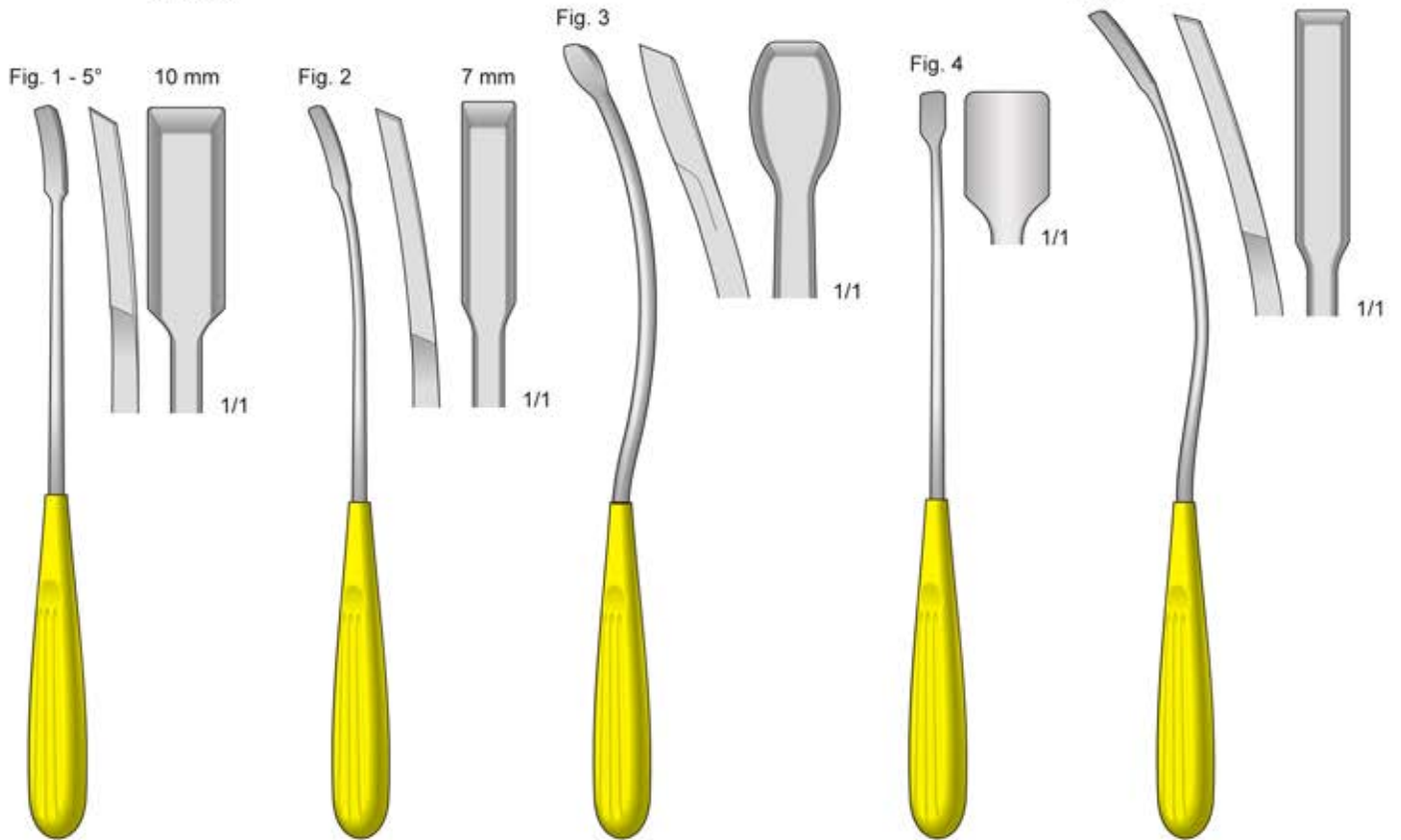

Fig. 1 - 5°

10 mm

Fig. 2

7 mm

Fig. 3

Fig. 4

Fig. 5

1/1

1/1

1/1

1/1

1/1

ES-131
240 mm

ES-132
240 mm

ES-133
265 mm

ES-134
250 mm

ES-135
280 mm

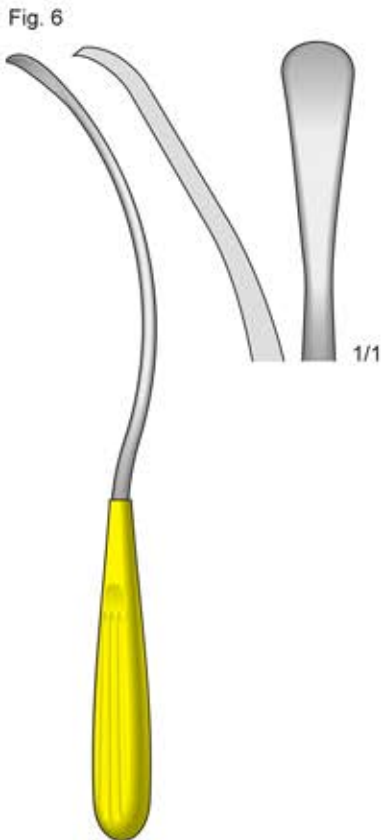

ES-136
255 mm

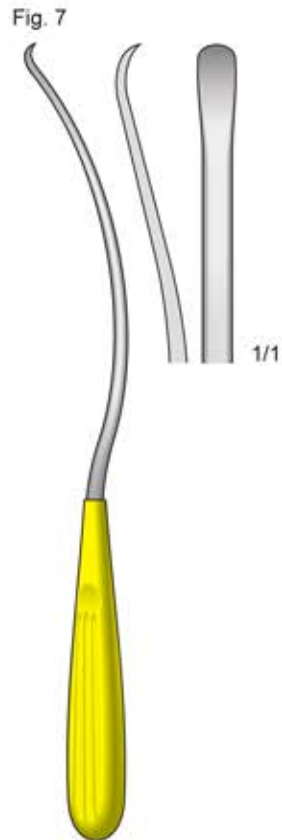

ES-137
260 mm

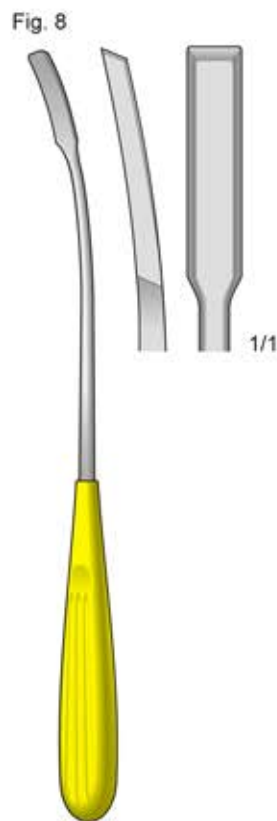

ES-138
250 mm

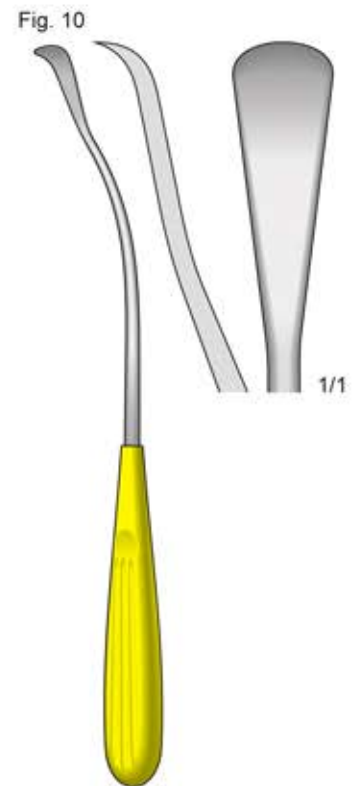

ES-139
230 mm

Dissektoren
Elevatoren

Dissectors
Elevators

Dissettori
Elevatori

Separadores
Elevadores

Dissecteurs
Elevateurs



ES-216
235 mm



ES-217
235 mm

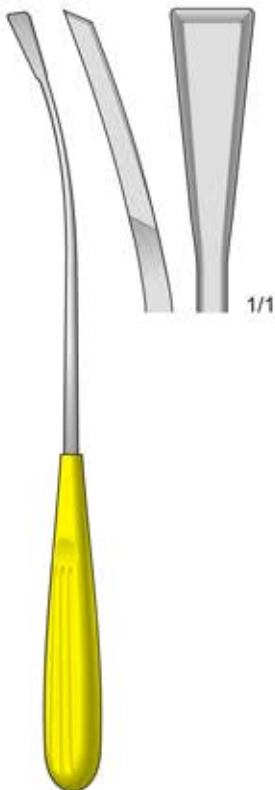

ES-211
240 mm

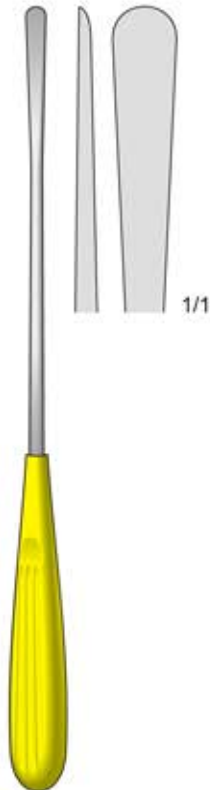

ES-212
240 mm

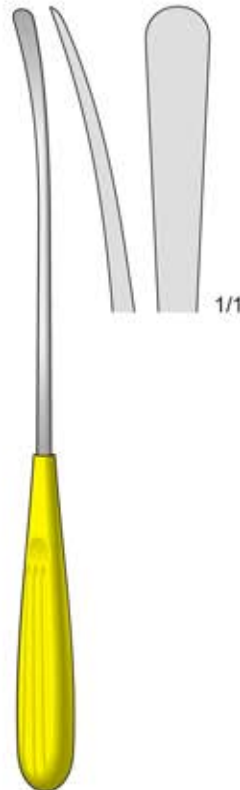

ES-213
240 mm

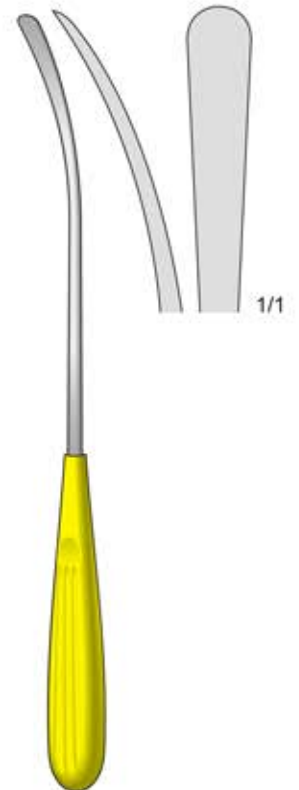

ES-215
240 mm

Rostfrei - Stainless Steel
 Acciaio - Acero
 Acer

Schwarz Verchromt
 Black anodized
 Cromato nero
 Cromado en negro
 Chromé noir

22x14 mm

100 mm

1/1



MENEGHINI
 OM-230
 200 mm

Rostfrei - Stainless Steel
Acciaio - Acero
Acer

Schwarz Verchromt
Black anodized
Cromato nero
Cromado en negro
Chromé noir

24x14 mm

85 mm

1/1



MENEGHINI
OM-231
180 mm

Dissector
Wundhaken

Dissector
Retractors

Dissettori
Divaricatori

Disecadores
Separadores

Dissecteur
Ecarteur

Modello
Standard

Modello
Fine

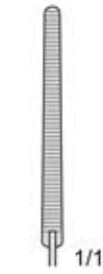
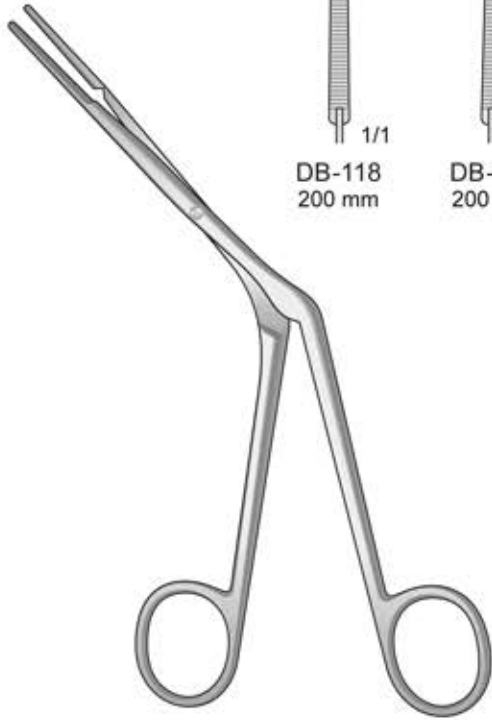

DB-118
200 mm

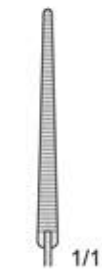

DB-119
200 mm

WESTMACOTT
DB-118/DB-119
200 mm

23 mm



FACE-LIFT
ES-163
120 mm



CONVERSE
DO-207
50 mm



1/1
Halb-Biegsam
Semi-malleable
Semi malleabile
Semi maleable
Semi-souple

ES-219
270 mm

Spatulated
Breast



ES-144
330 mm

Spatulated Ovale
Breast



ES-149
390 mm

Dissector
Wundhaken

Dissector
Retractors

Dissettori
Divaricatori

Disecadores
Separadores

Dissecteur
Ecarteur



ES-110
125 mm



BT-21
110 mm



JAEGER
OM-09
110 mm

Nasenflügelhaken
Alar Retractor
Divaricatore per alette nasali
Separador para las alas nasales
Ecarteur pour les ailes du nez

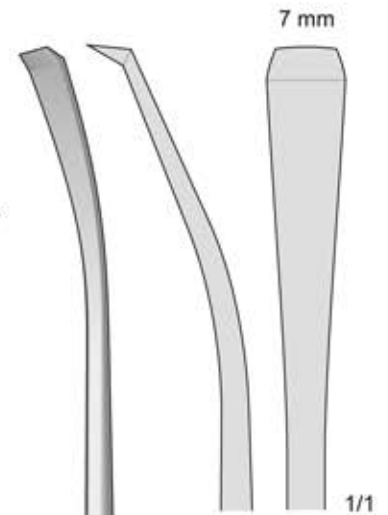

Measuring and Sculpturing
the lateral crus in open Rhinoplasty
Scultura delle crus laterali
nella Rinoplastica aperta

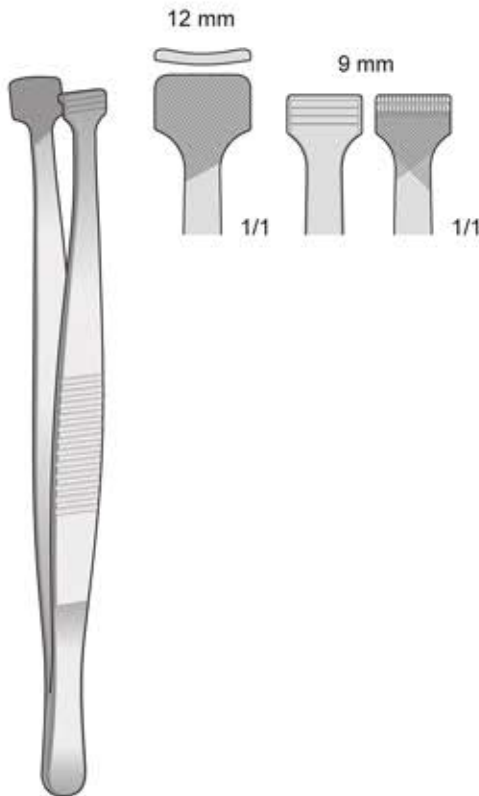

MENEGHINI
BD-350
125 mm



MICHELI-PELLEGRINI
FR-190
150 mm

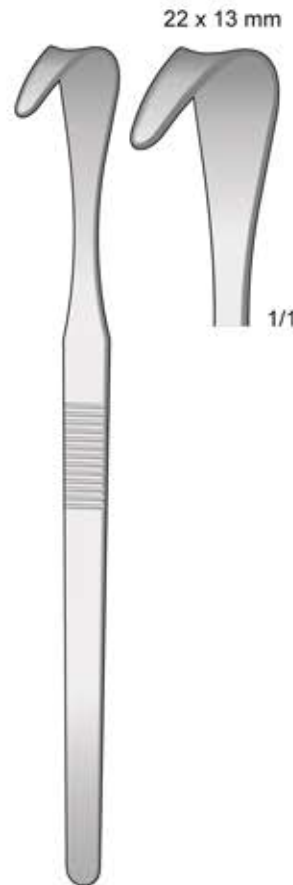

COTTLE
BT-138
150 mm



MENEGHINI
ES-221
215 mm

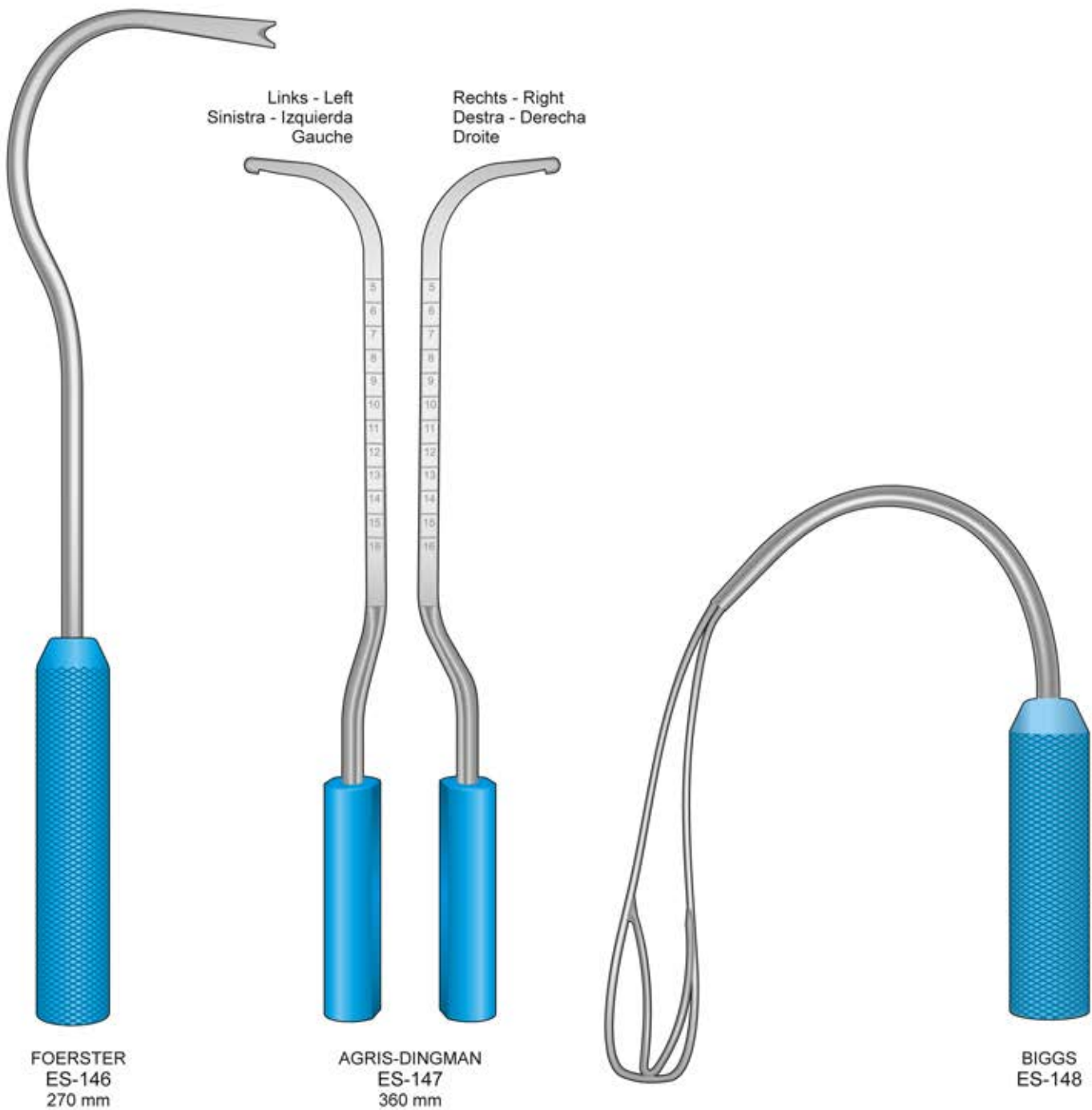

Areola-Marker

Areola Marking

Marca Areola

Apuntar Areola

Couteaux à mamelles

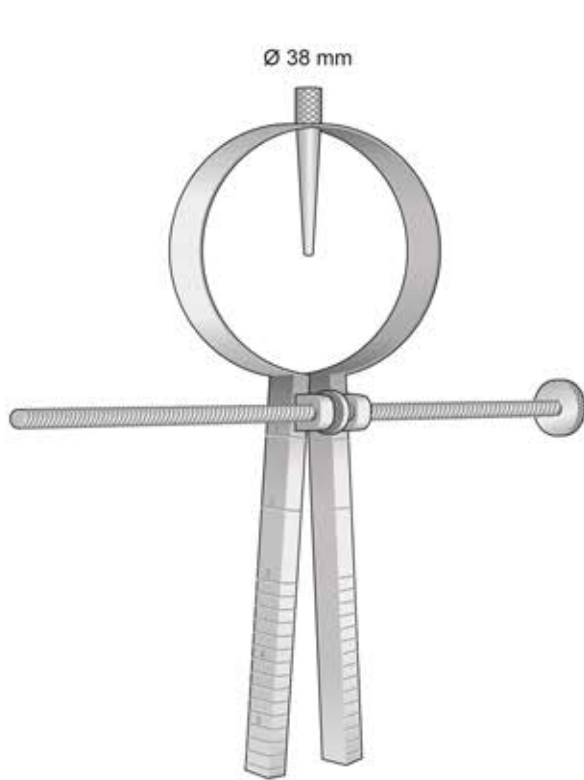

ES-164
105 mm

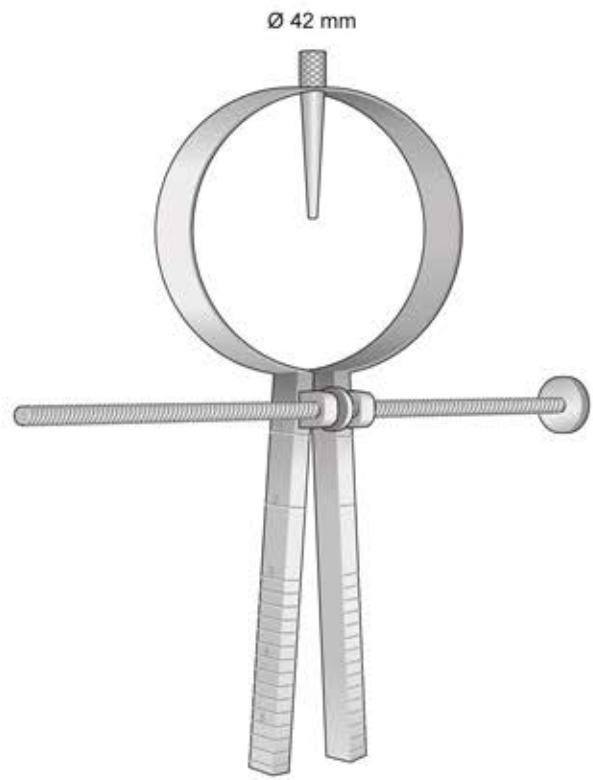

ES-165
110 mm

Scharf - Sharp
Taglienti - Cortante
Tranchant

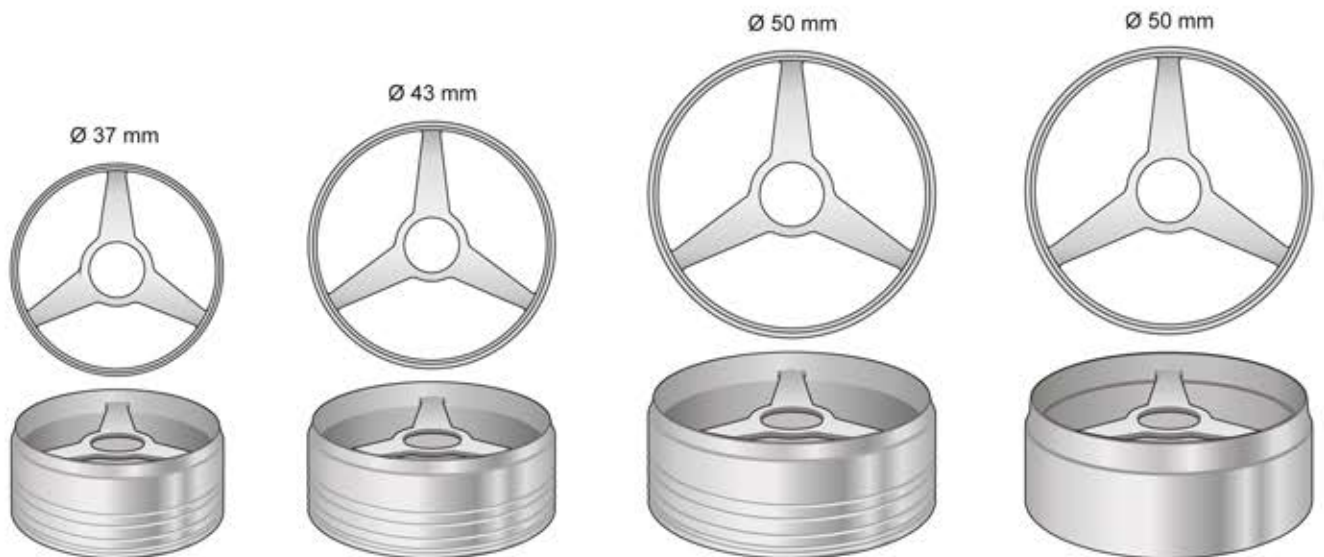

ES-18S
37 mm

ES-19S
43 mm

ES-20S
50 mm

ES-20
50 mm

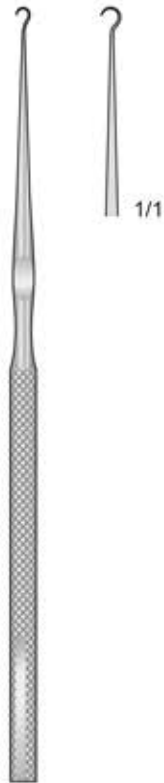

KILNER
 BT-53
 150 mm



FRAZIER
 BT-362 130 mm
 BT-363 180 mm



FRAZIER
 BT-364 130 mm
 BT-365 180 mm

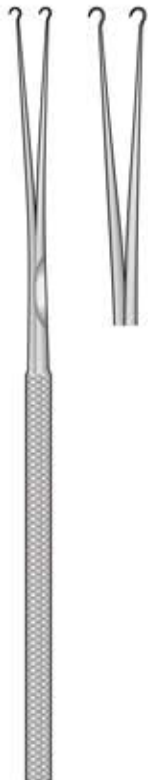

BARSKY
 BT-370
 150 mm

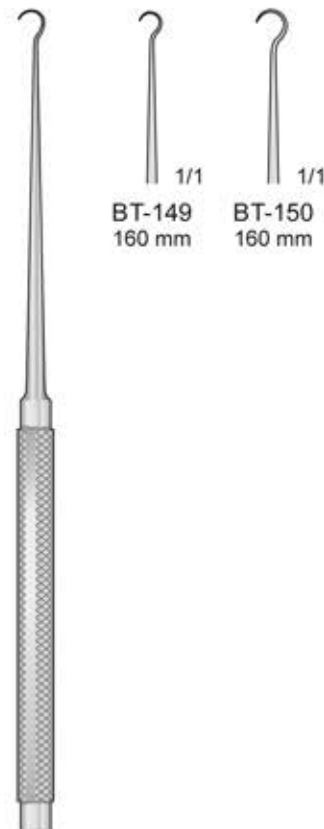

KLEINERT-KUTZ
 BT-149/BT-150
 160 mm

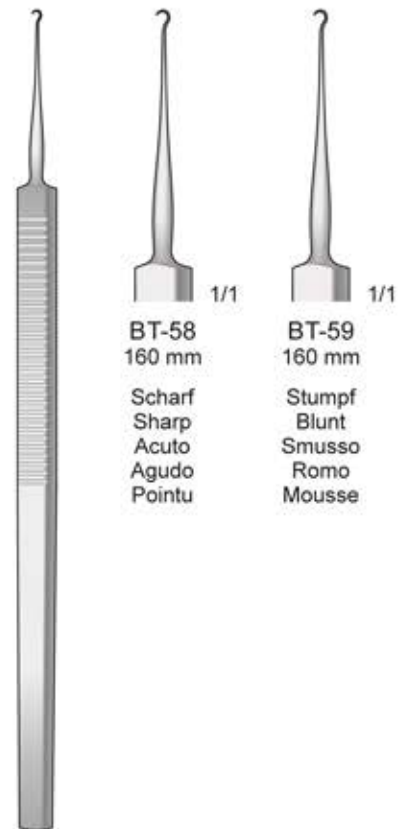

GRAEFE
 BT-58/BT-59
 160 mm

BT-58
 160 mm
 Scharf
 Sharp
 Acuto
 Agudo
 Pointu

BT-59
 160 mm
 Stumpf
 Blunt
 Smusso
 Romo
 Mousse

Wundhaken mit
Fiberoptikstab oval

Retractors with
Fiber optic oval

Divaricatore a
fibra ottica ovale

Retractor con
iluminación de luz fría

Ecarteur avec
illumination à lumière froide

Sterilizable. Removable. Protected fiber-optic piece
Oval Shaped optic end for great light field
Retractor with concave blade for added operative space and visibility
Equiped with universal adapters WOLF, STORZ, OLYMPUS

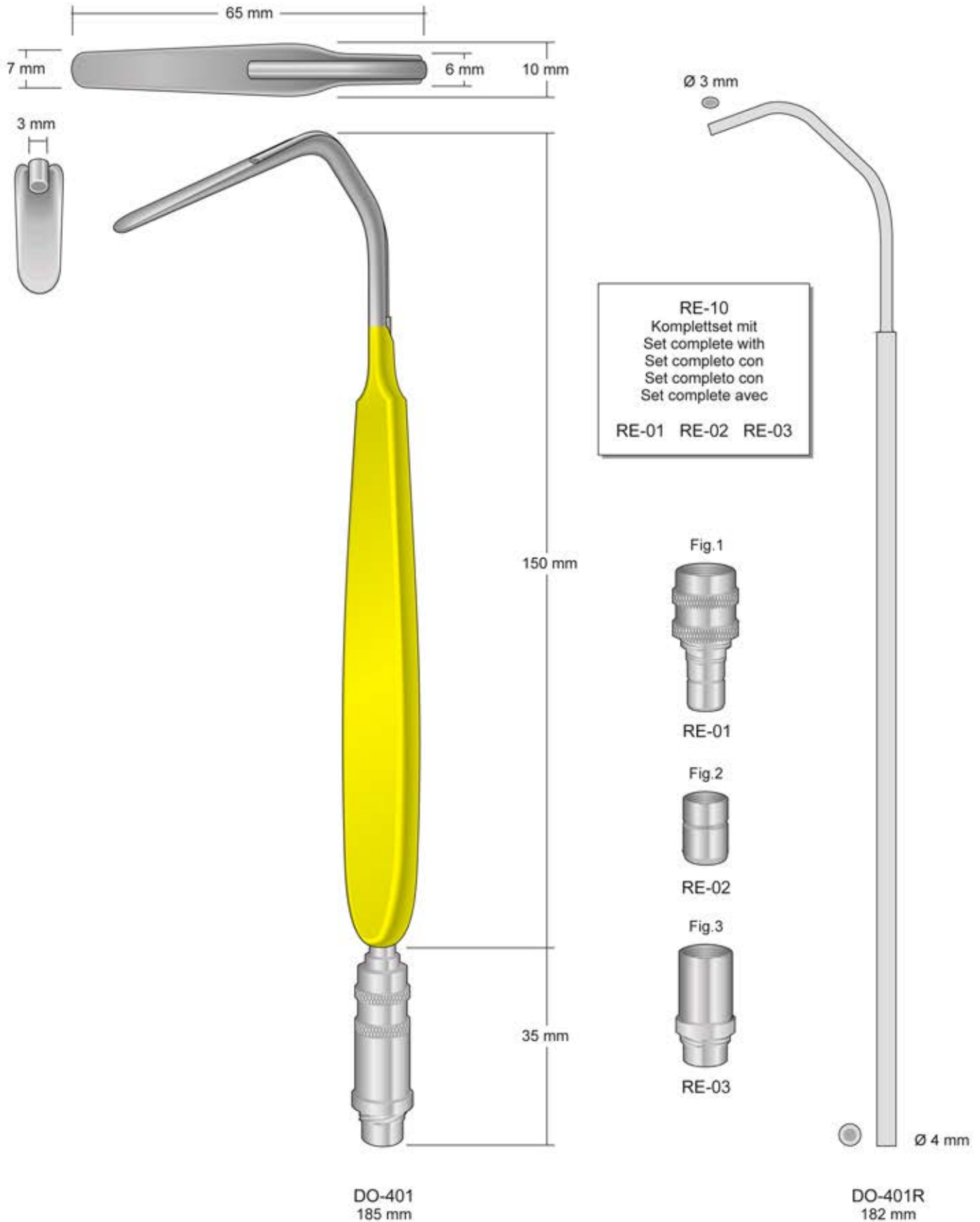

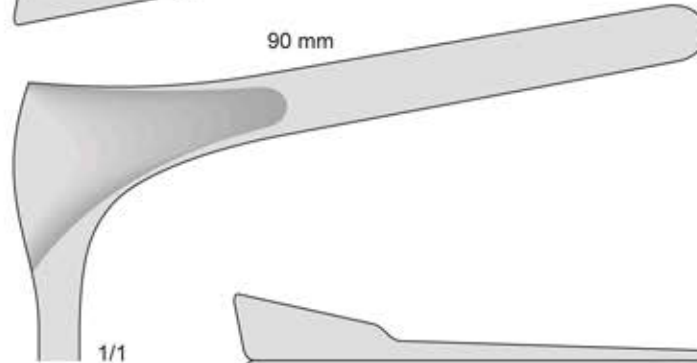
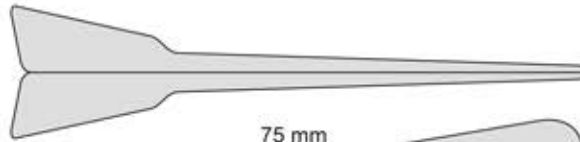

90 mm

 1/1
 OM-192L
 150 mm

75 mm

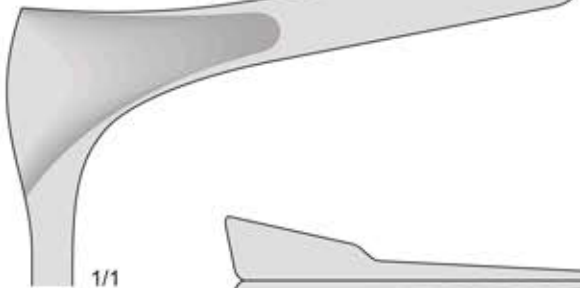
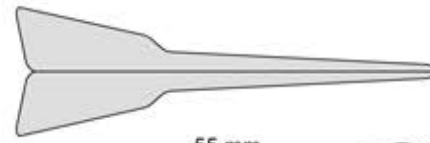
 1/1
 OM-192
 150 mm

55 mm

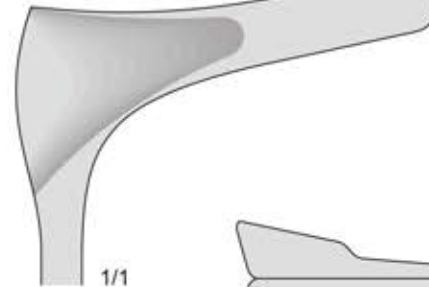
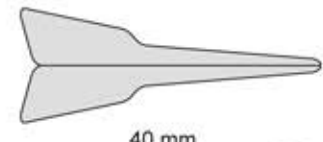

 1/1
 OM-191
 140 mm

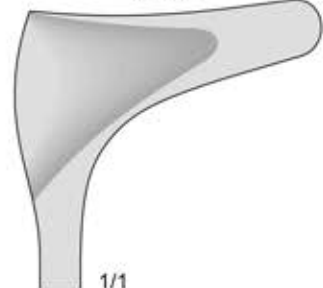
40 mm

 1/1
 OM-190
 130 mm

 Dünnes Blatt
 Thin valve
 Valve piatte

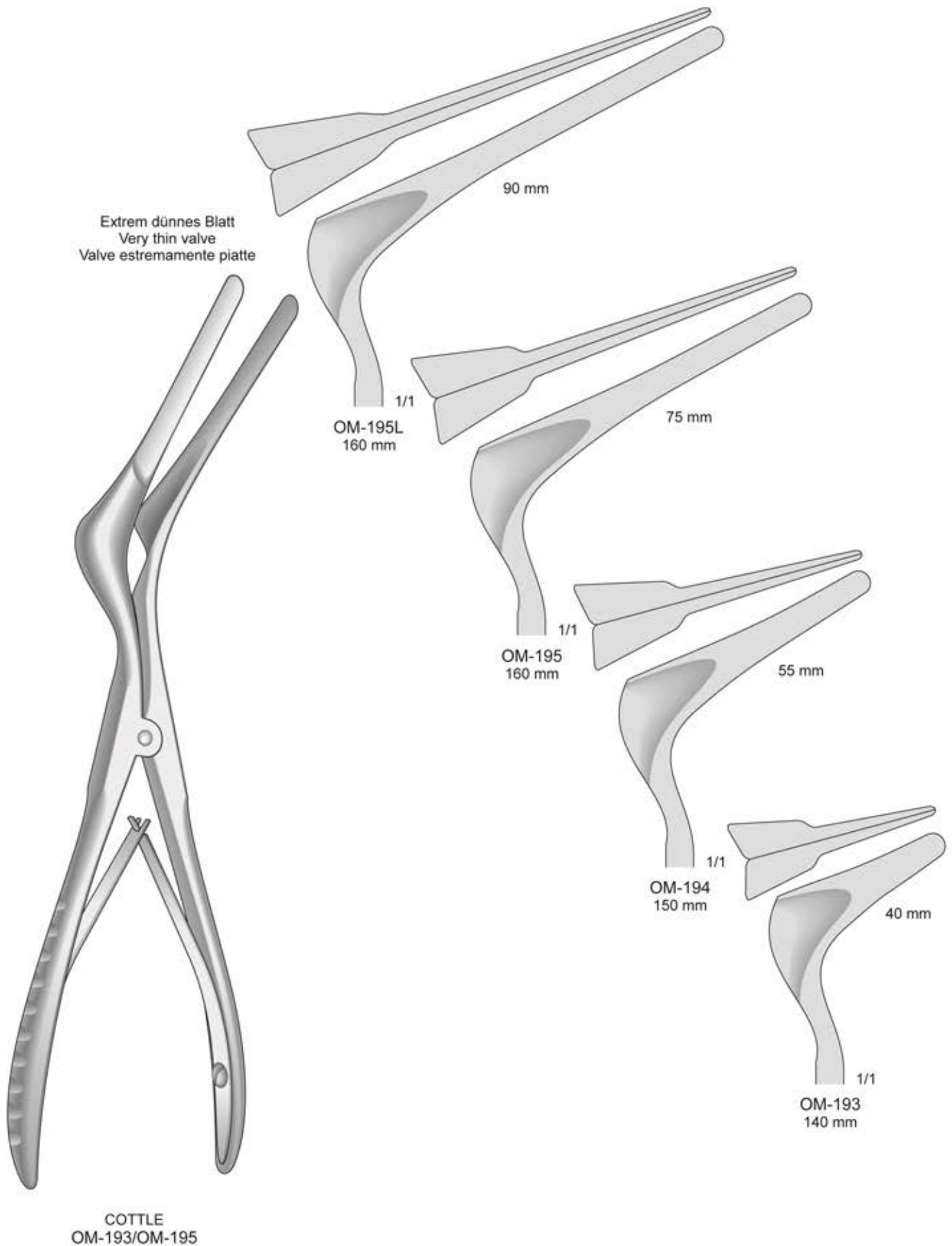
 KILLIAN
 OM-190/OM-192



Schwarz Verchromt
Black Finish
Cromato nero

Extrem dünnes Blatt
Very thin valve
Valve estremamente piatte



COTTLE
OM-196/OM-198

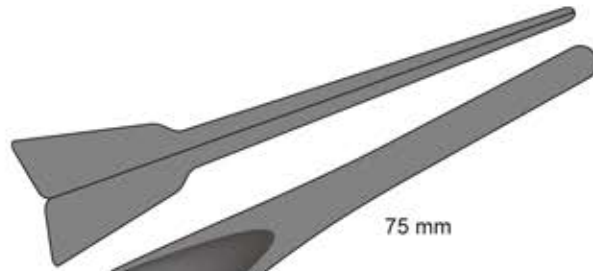

75 mm

1/1
OM-198
160 mm



55 mm

1/1
OM-197
150 mm

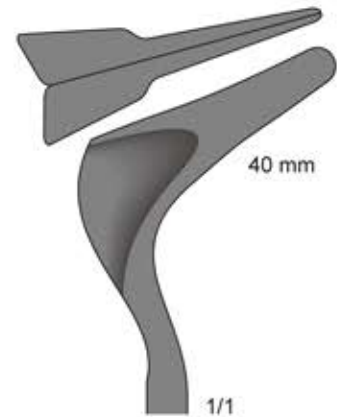

40 mm

1/1
OM-196
140 mm

Nasen Spekula

Nasal specula

Speculum nasali

Espéculos nasales

Spéculums nasaux

Mit Fiberoptikstab
With Fiber optic illumination
Con illuminazione a fibre ottiche
Con iluminación de luz fría
Avec illumination à lumière froide

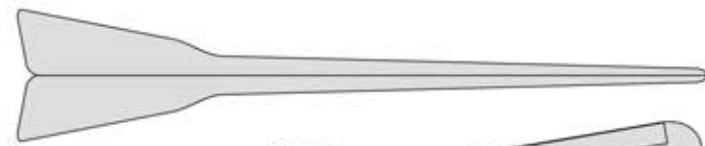

90 mm

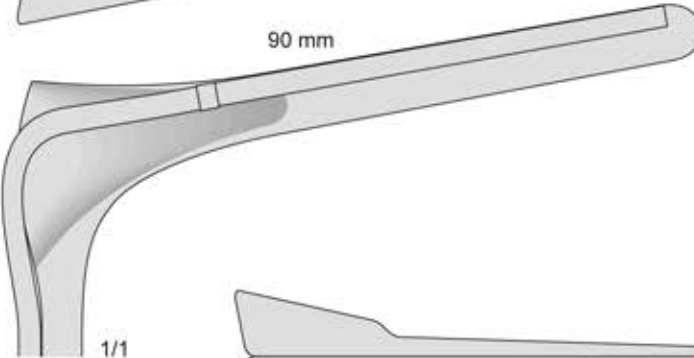

1/1

OM-243
150 mm

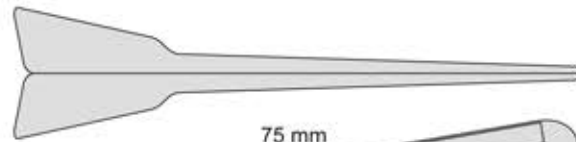

75 mm

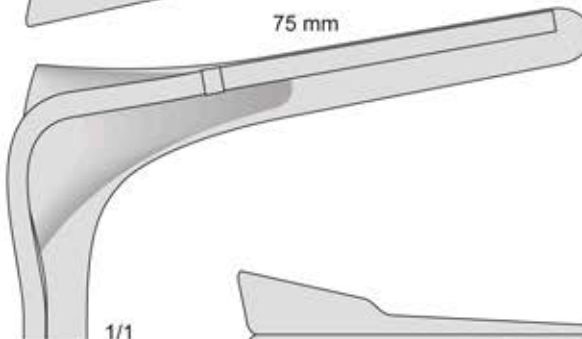

1/1

OM-242
150 mm

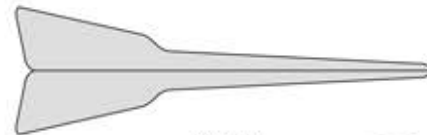

55 mm

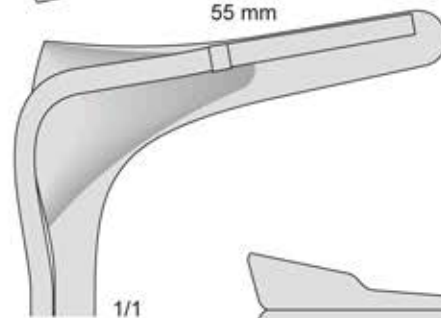

1/1

OM-241
140 mm

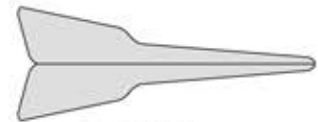

40 mm



1/1

OM-240
130 mm

Dünnes Blatt
Thin valve
Valve plate



KILLIAN
OM-240/OM-243

Faßzange - Grasping Forceps
 Pinza da presa - Pinza para agarrar
 Pincès à préhension

130 mm

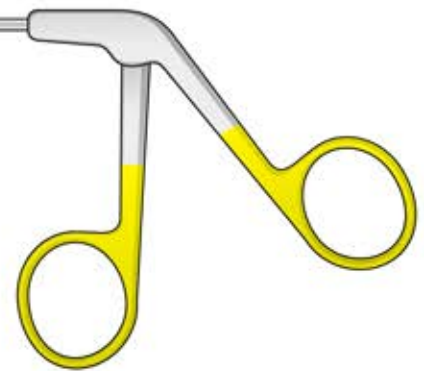
 Ohne Sperre
 Without catch
 Senza cremagliera
 Sin cremallera
 Sans crémaillère

FO-350

 Hakenstanzen mit Schaufel - Hook Punches with Scoop
 Pinze per biopsia con pala - Pinzas para biopsia con pala
 Pincès à biopsie à pelle

130 mm



L = 5,0 mm B = 1,6 mm

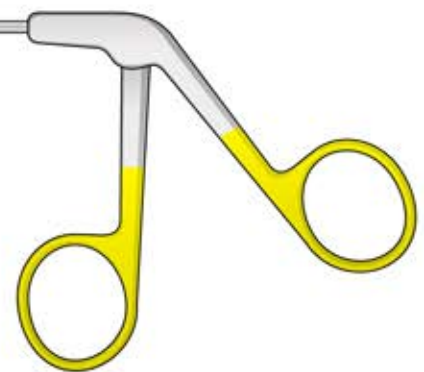

FO-370/FO-372

 Gerade - Straight
 Diritta - Recto - Droit

 FO-370
 Ø 2,7 mm

 30° rechts - right
 destra - derecha - droite

 FO-371
 Ø 2,7 mm

 30° links - left - sinistra
 izquierda - gauche

 FO-372
 Ø 2,7 mm

 Gerade - Straight
 Diritta - Recto - Droit

 FO-390
 Ø 2,7 mm

 30° rechts - right
 destra - derecha - droite

 FO-391
 Ø 2,7 mm

 30° links - left - sinistra
 izquierda - gauche

 FO-392
 Ø 2,7 mm

15° auf - up - sopra

 FO-397
 Ø 2,7 mm

 Hakenschere - Hook Scissors
 Pinze a gancio - Tijeras de gancho
 Pincès - ciseaux

130 mm

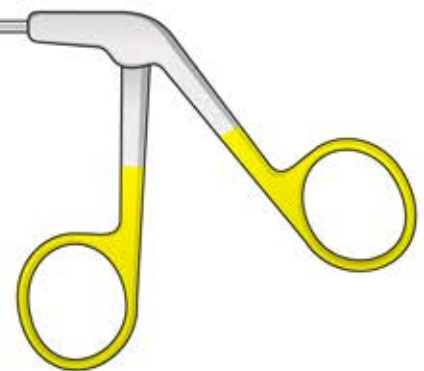
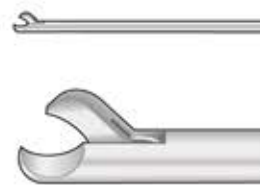

FO-390/FO-397

Scheren Gezahnt

Serrated scissors

Forbici dentellate

Tijeras dentadas

Ciseaux dentelé

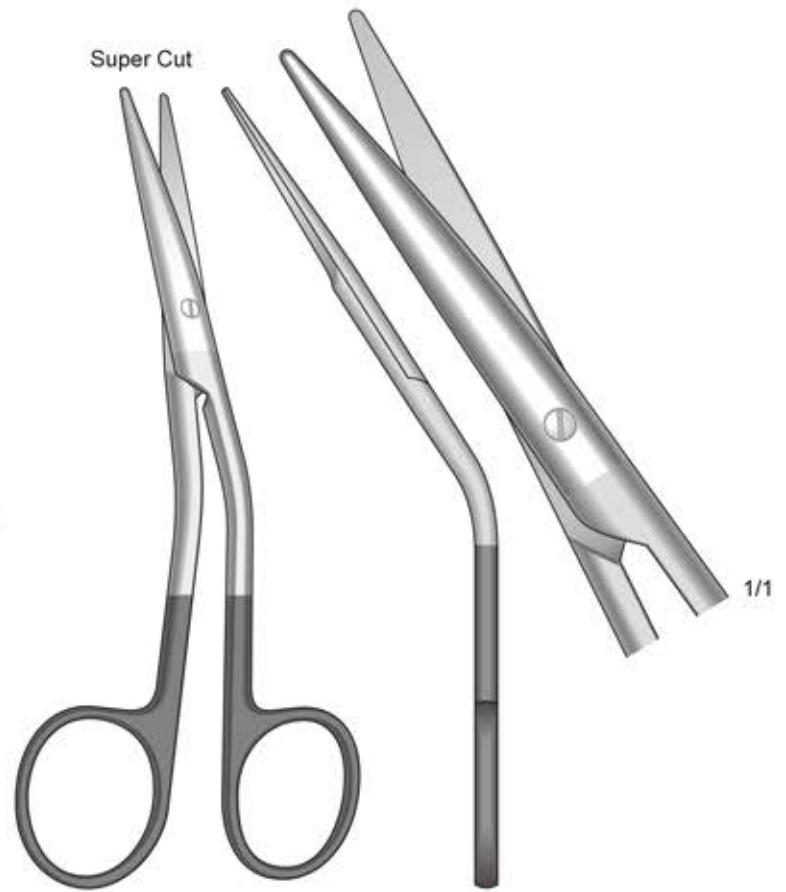

FOMON
FG-192
130 mm

COTTLE
FG-193
160 mm

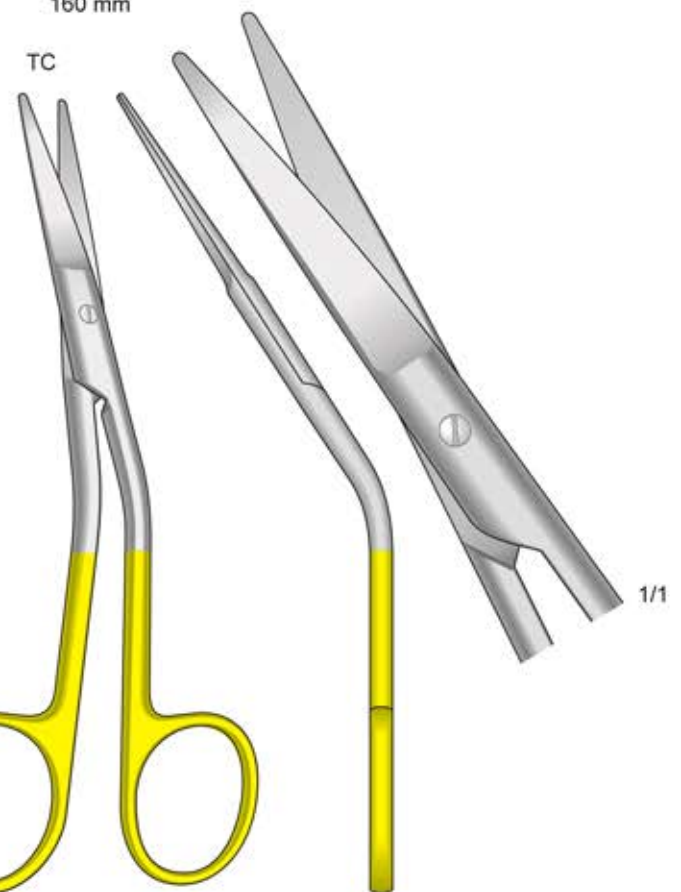
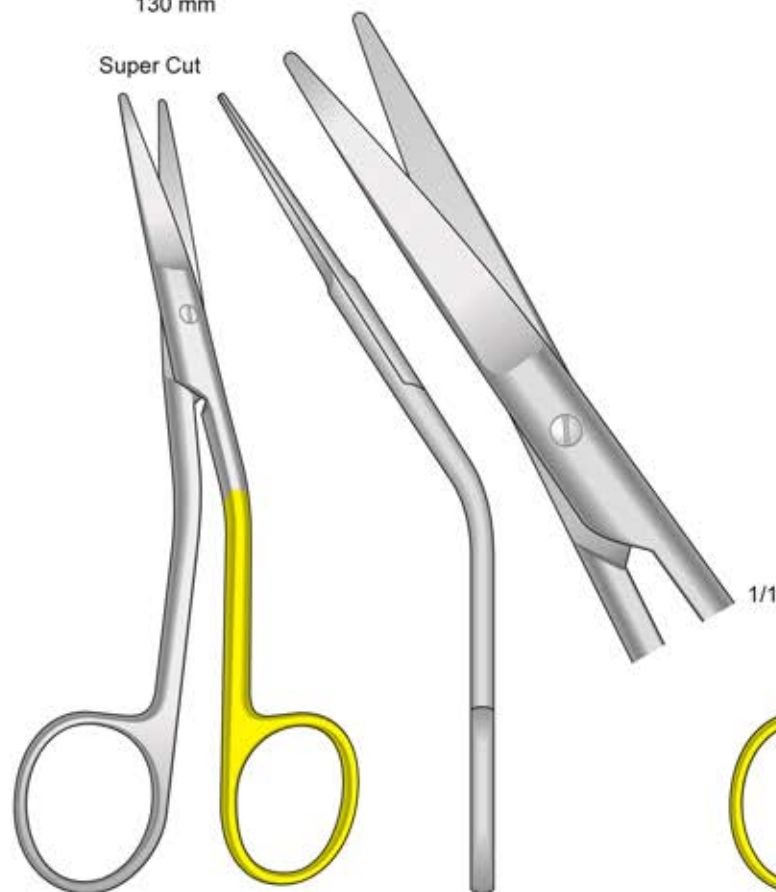

COTTLE
FG-194
160 mm

COTTLE
FG-195
160 mm

Mit einer Schneide gezahnt
 With one blade serrated
 Con una lama zigrinata
 Con una hoja dentada
 Avec lame dentèle

Super Cut

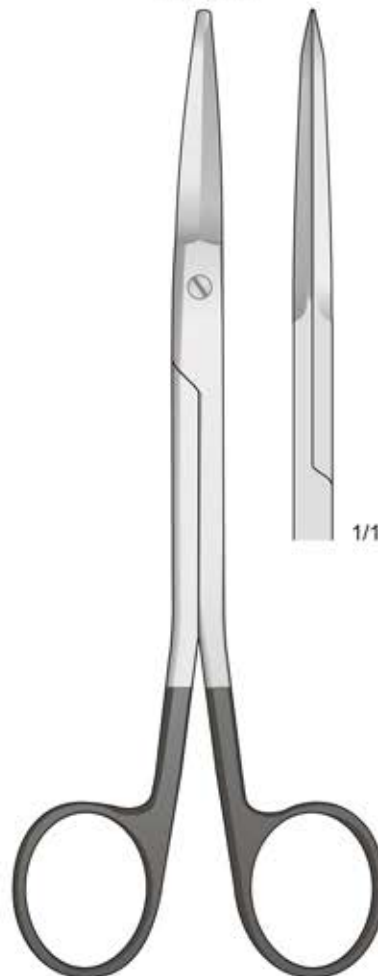

FACE-LIFT
 FM-308
 160 mm

Mit einer Schneide gezahnt
 With one blade serrated
 Con una lama zigrinata
 Con una hoja dentada
 Avec lame dentèle

Super Cut

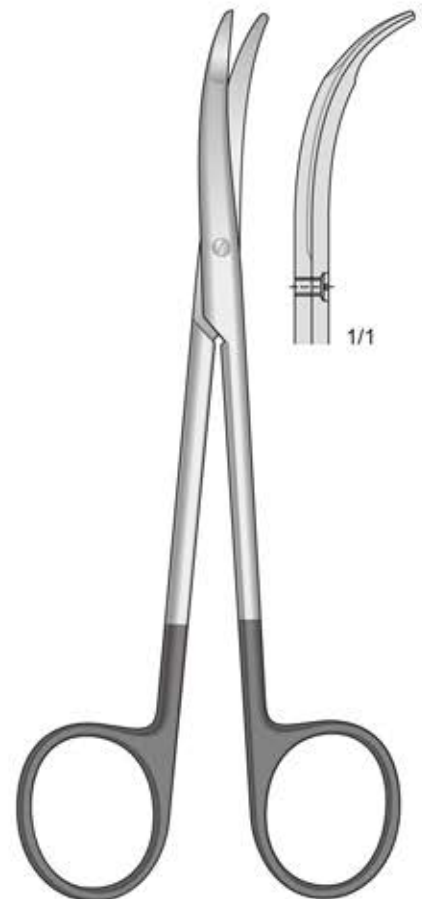

FOMON
 FG-163
 140 mm

Mit einer Schneide gezahnt
 With one blade serrated
 Con una lama zigrinata
 Con una hoja dentada
 Avec lame dentèle

Super Cut

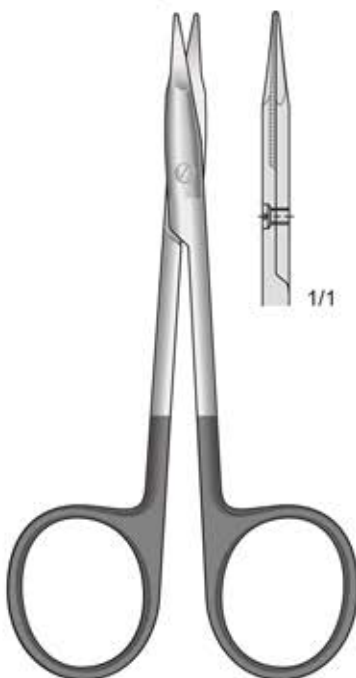

STEVENS
 FM-302
 105 mm

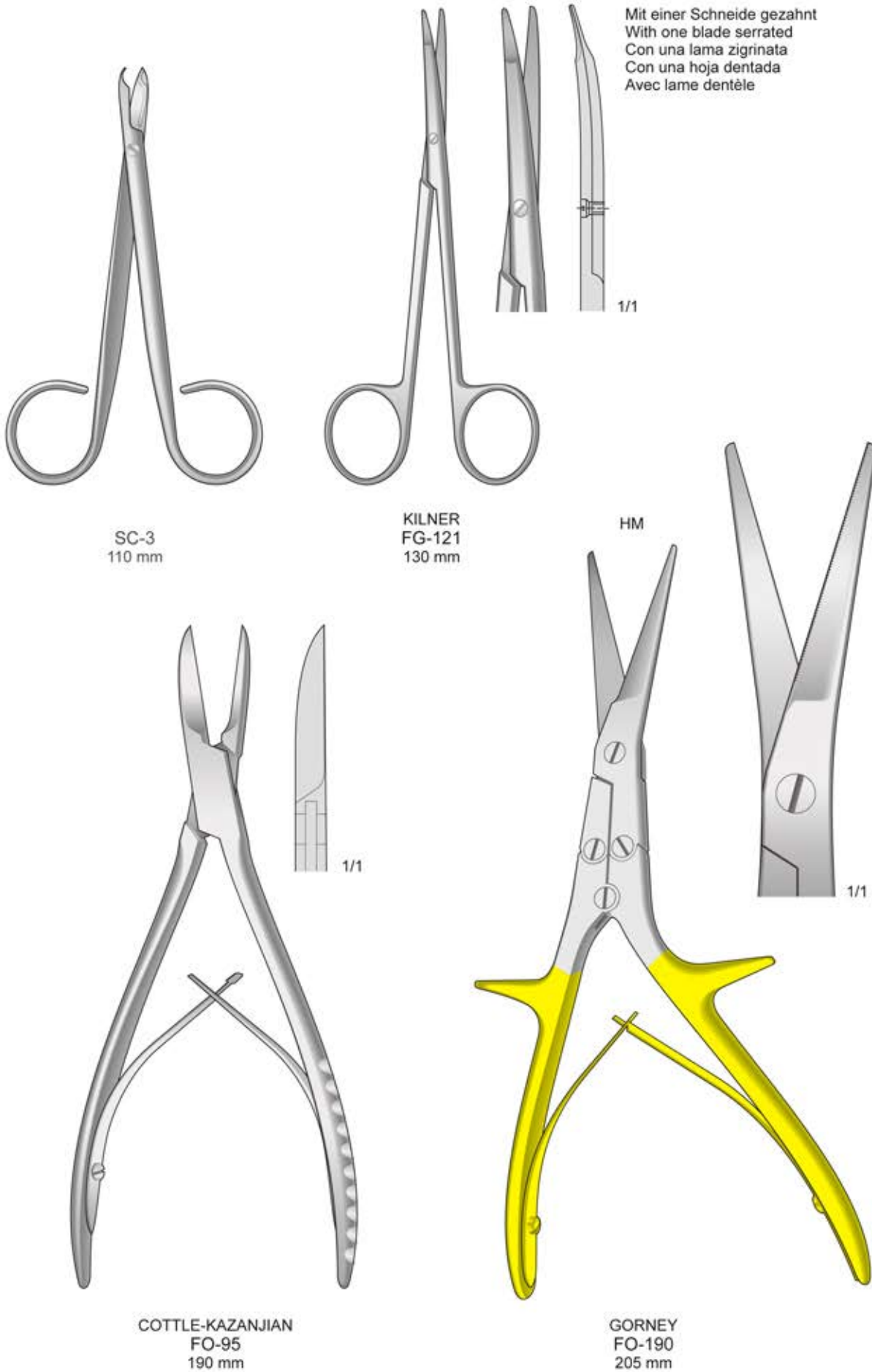

Osteotome

Osteotomes

Osteotomi

Osteótomos

Ostéotomes

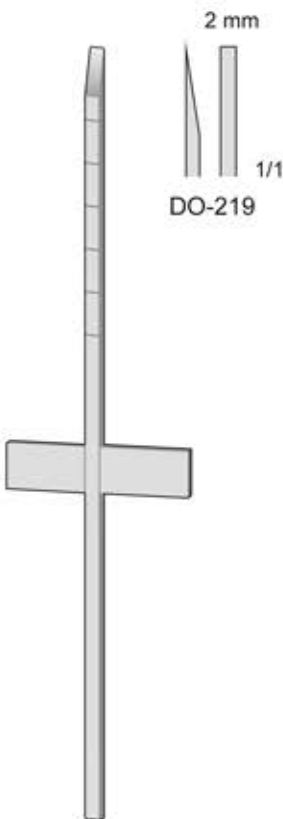
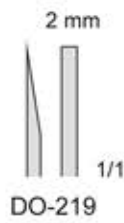
JOSEPH
FR-34
150 mmTESSIER
FL-413/FL-416
160 mmFL-413
2 mmFL-414
3 mmFL-415
5 mmFL-416
7 mmCOTTLE
DO-219
180 mm

DO-219

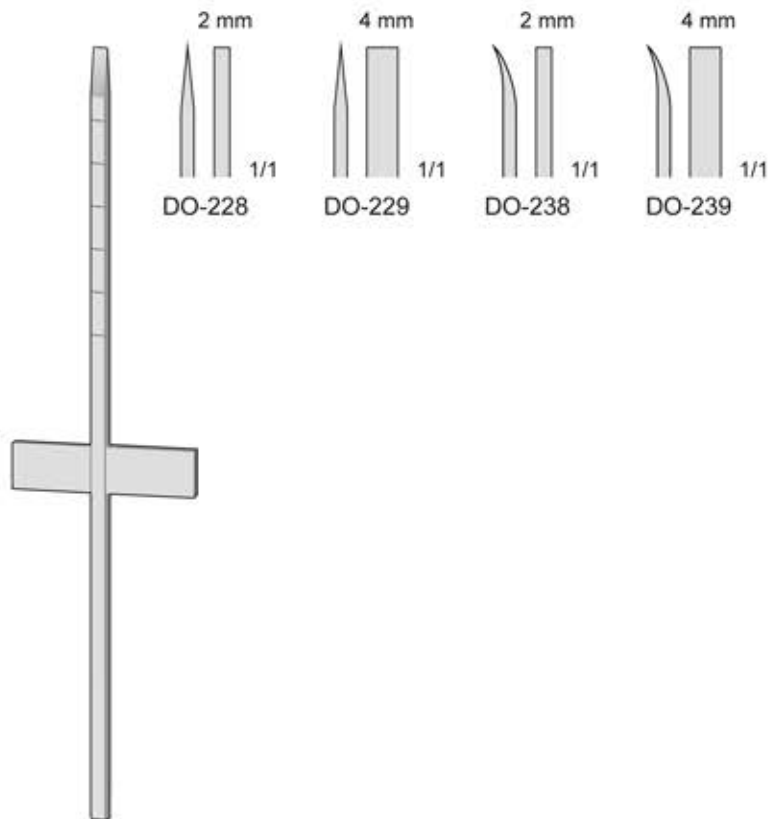
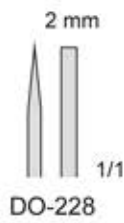
COTTLE
DO-228/DO-239
180 mm

DO-228

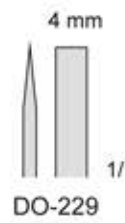

DO-229

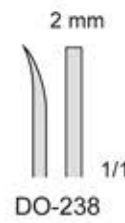

DO-238

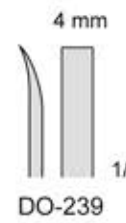

DO-239

Osteotome

Osteotomes

Osteotomi

Osteótomos

Ostéotomes

2 mm

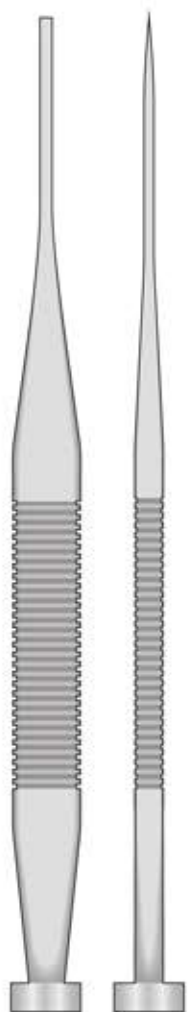

DO-113
170 mm

3 mm

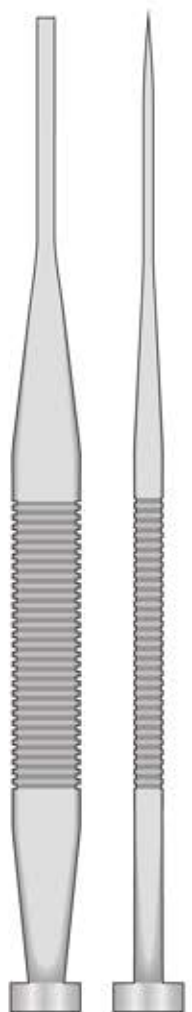

DO-114
170 mm

4 mm

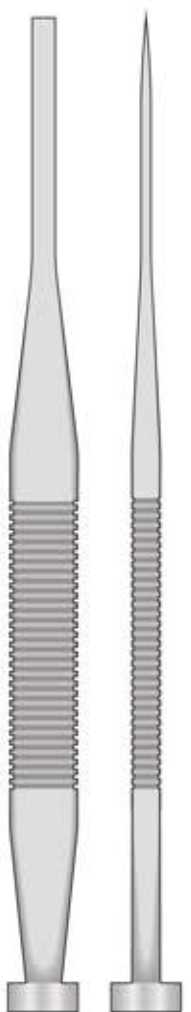

DO-115
170 mm

4 mm

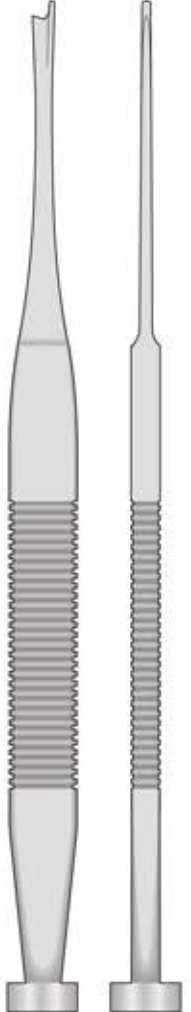

DO-116
170 mm



DO-135
185 mm

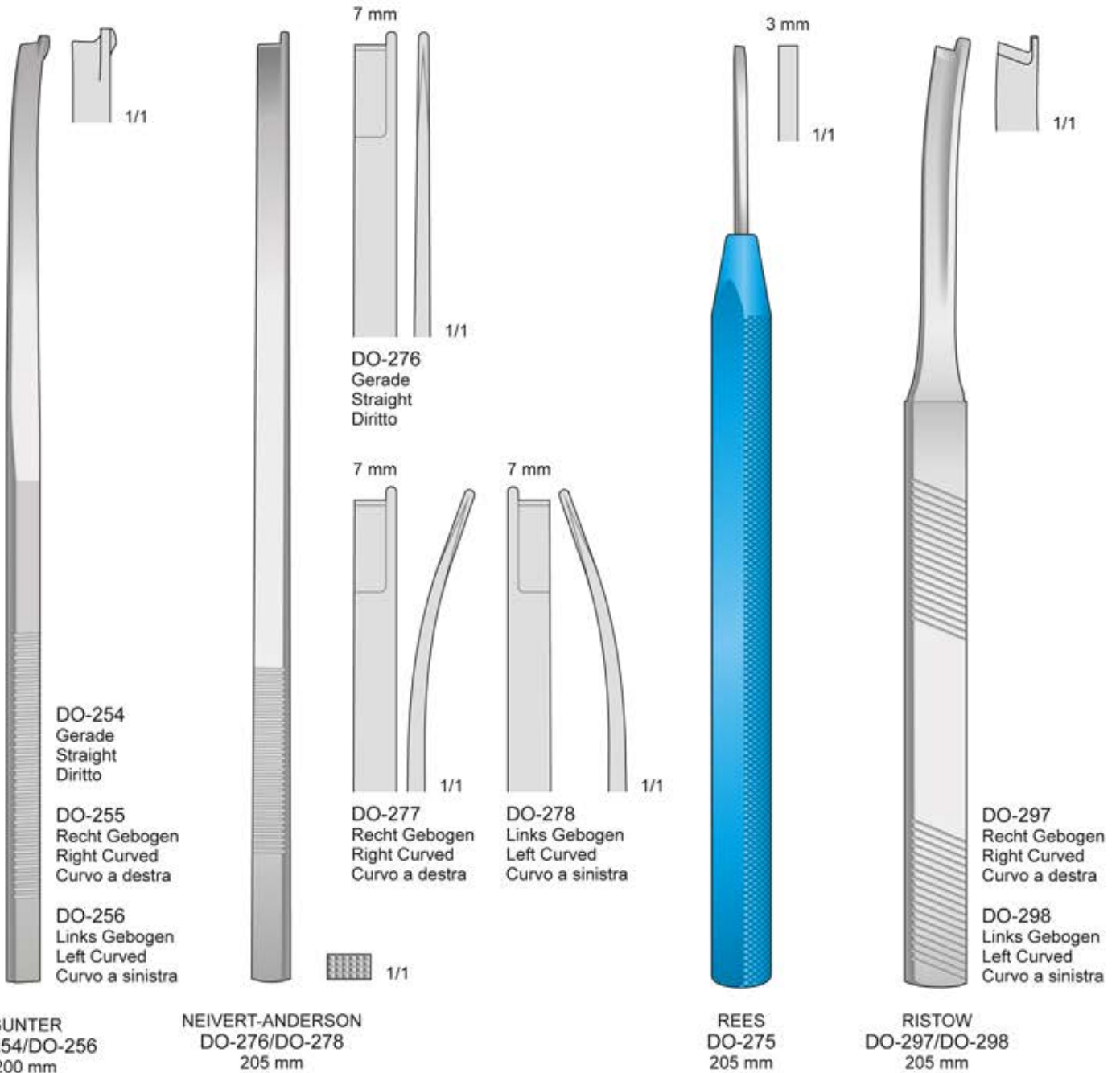

Osteotome

Osteotomes

Osteotomi

Osteótomos

Ostéotomes



PARKES
DO-253
180 mm

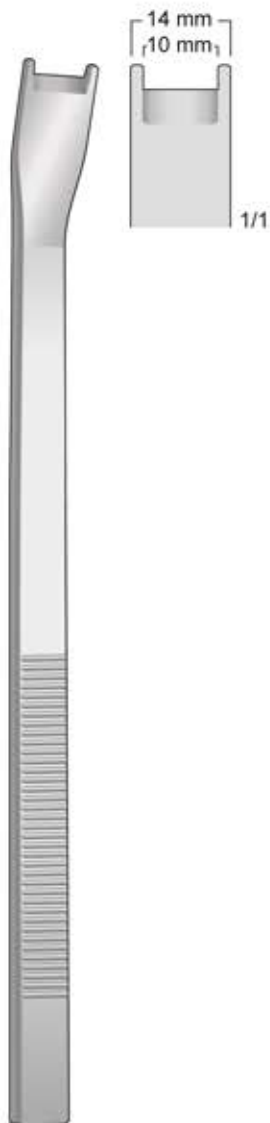

DANIEL
DO-268
180 mm

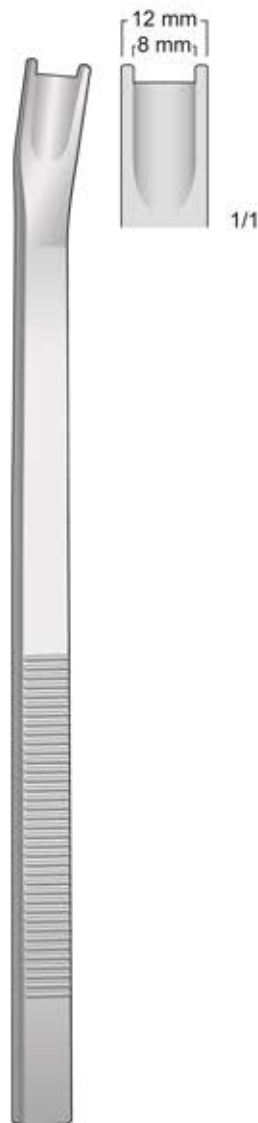

DANIEL
DO-269
180 mm



DO-321
Angolato 10°
DO-322
Angolato 20°
SHEEN
DO-321/DO-322
180 mm



PARKES
DO-320
180 mm

Osteotome mit
 Doppelt Protezion

 Osteotome with
 Double Guarded

 Osteotomi con
 doppia protezione

 Osteotom con
 doble protezion

 Osteotome avec
 double protection

 DO-208
 160 mm

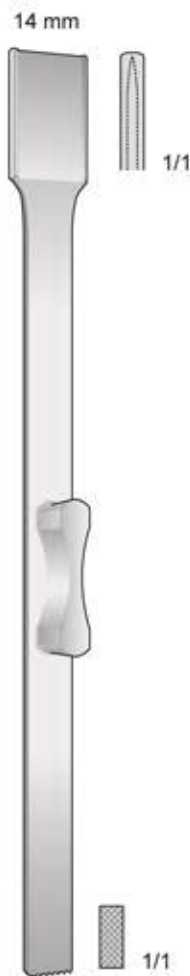
 DO-209
 160 mm

 DO-210
 160 mm

 DO-300
 190 mm

 DO-267
 190 mm

Knochenfeilen

Bone files

Lime per osso

Limas para huesos

Limes à os

Universal Adapter for Syringe

Aluminium Blau
Aluminium Blue
Alluminio Blu
Aluminio Azul
Aluminium Bleu



ES-02

Diamantaufage
Diamond Jaw
Punte diamantate

7 mm

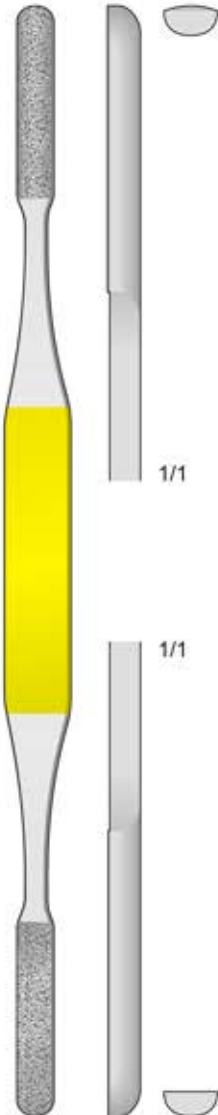

DO-316
215 mm

Griff Rostfrei
Stainless Steel Handle
Manico in acciaio Inox
Mango de acero
inoxidable
Manche en
acier inoxydable

Ø 15 mm



ES-29
195 mm

Rostfreies Verbindungsteil
zum Kanüle-Nadel
Connection piece
for cannula-needles
Raccordo inox
per cannula-ago
Juntura inox
para jeringa-agujas
Adapter en acier
pour canule-aiguilles



ES-04

Intranasal Brecher
Intranasal Hammer
Martello intranasale



QUISLING
FL-137
175 mm

Mikro Precision Pinzetten

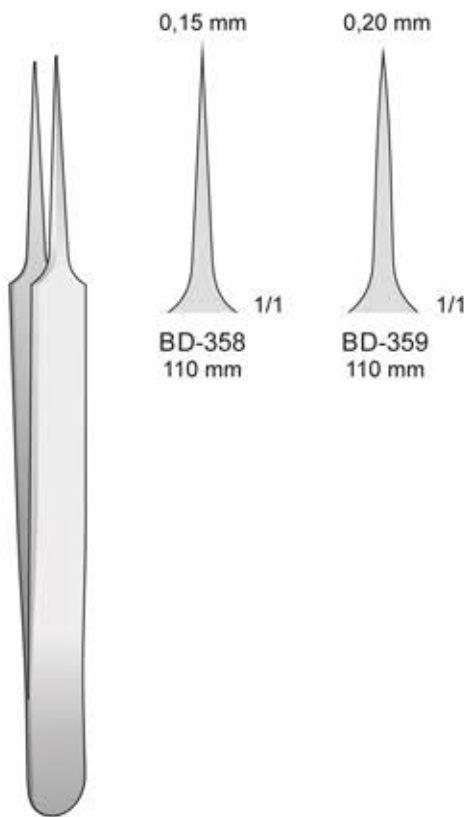
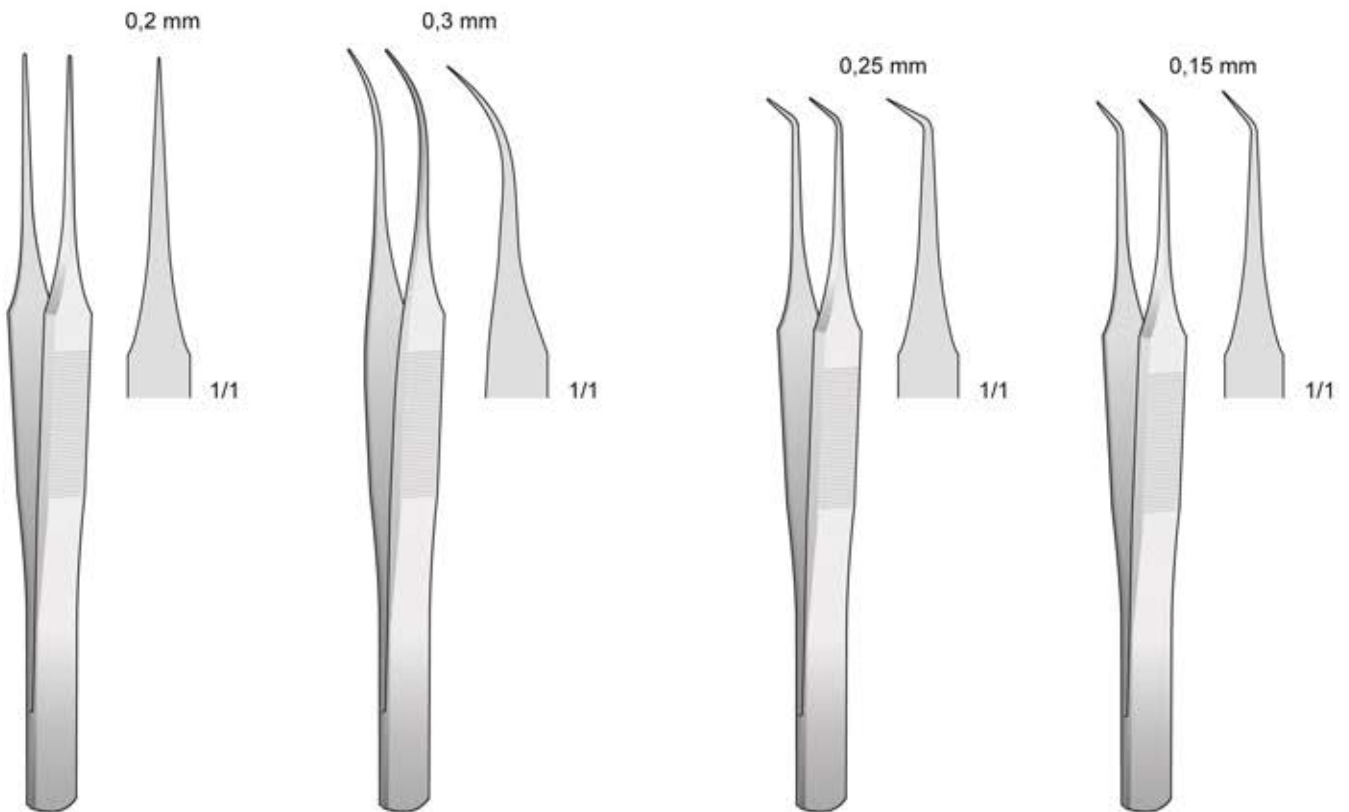
 BD-358/BD-359
 110 mm

 BD-360
 110 mm

 BD-361
 110 mm

 BD-362
 100 mm

 BD-363
 100 mm

Mikro Pinzetten

Delicate forceps

Micro Pinzette

Pinzas finos

Micro pinces

Mikro Precision Pinzetten

Mikro diamantiertes Maul - Micro Diamond Jaw
Micro punta diamantata - Micro boca diamantada
Micro mors diamanté



1/1

1x2 Zähne
1x2 Tooth
1x2 Denti
1x2 Dientes
1x2 Dents



1/1

9x9 Zähne
9x9 Tooth
9x9 Denti
9x9 Dientes
9x9 Dents

CASTROVIEJO
BD-347 0.5 mm
BD-348 0.9 mm
120 mm

BROWN
BD-349
120 mm



0,4 mm



1/1

BD-364
110 mm



0,4 mm



1/1

BD-365
110 mm



0,4 mm



1/1

BD-366
130 mm



0,4 mm



1/1

BD-367
130 mm

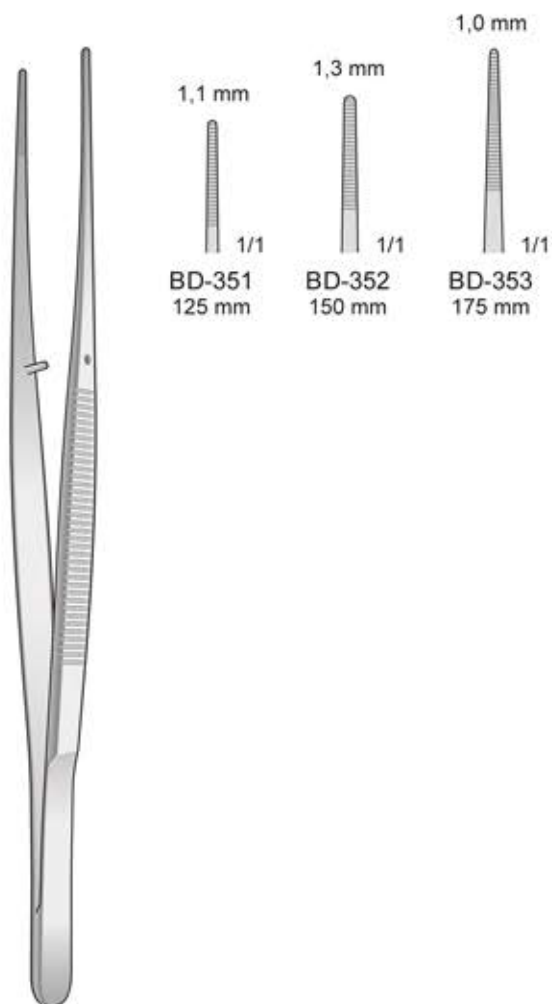

BD-351/BD-353

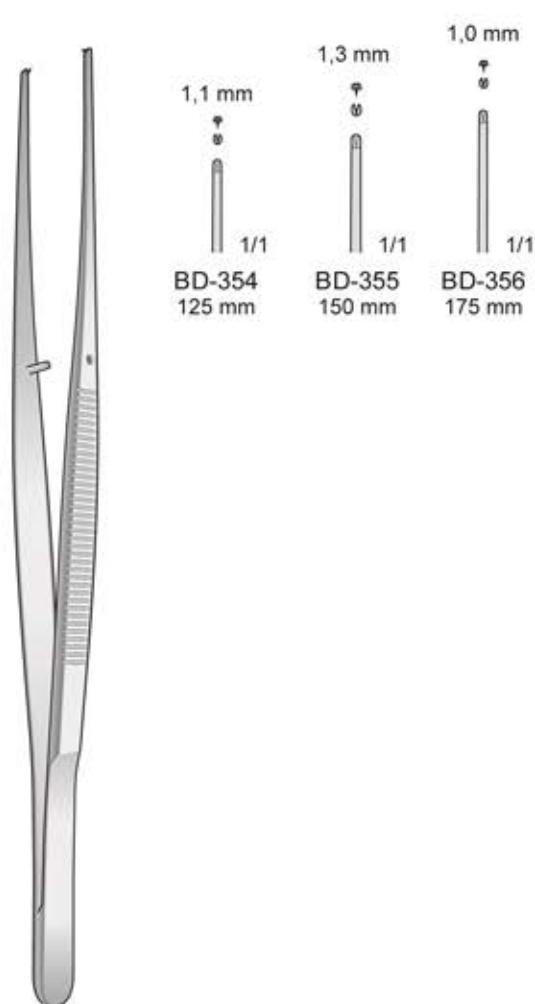

BD-354/BD-355

Chirurgische Pinzetten
Anatomische Pinzetten

Tissue forceps
Dressing forceps

Pinzette chirurgische
Pinzette anatomiche

Pinzas chirùrgicas
Pinzas de diseccion

Pinces chirurgicales
Pinces anatomiques

Mit Fadenplatte
With tying platform
Con piano prendifilo
Con piattaforma
Avec plateau pour monofil

1,0 mm

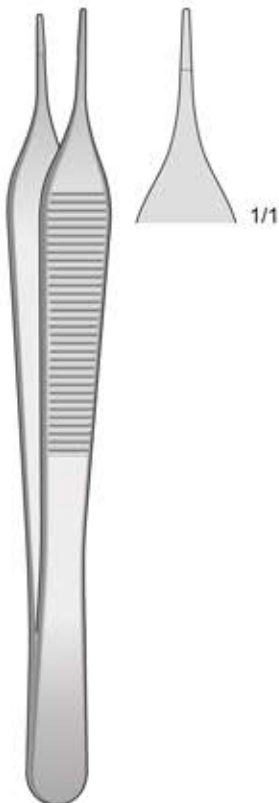

ADSON
BD-370
120 mm

Mit Fadenplatte
With tying platform
Con piano prendifilo
Con piattaforma
Avec plateau pour monofil

1,0 mm

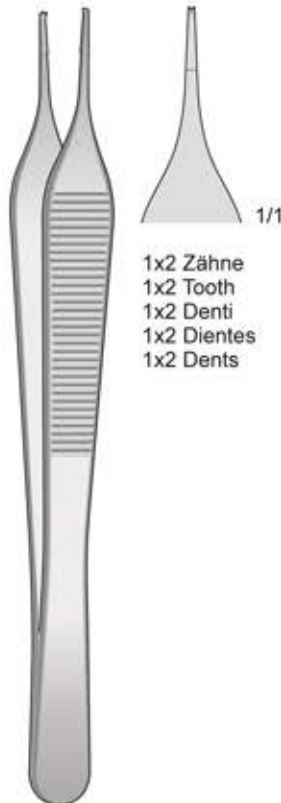

ADSON
BD-371
120 mm

1x2 Zähne
1x2 Tooth
1x2 Denti
1x2 Dientes
1x2 Dents

Extra fein
Extra fine
Extra fine

Gebogen
Curved
Curva

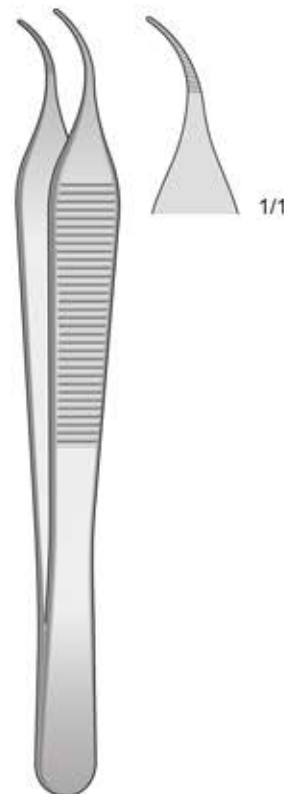

MICRO-ADSON
BD-372
120 mm

Extra fein
Extra fine
Extra fine

Gebogen
Curved
Curva

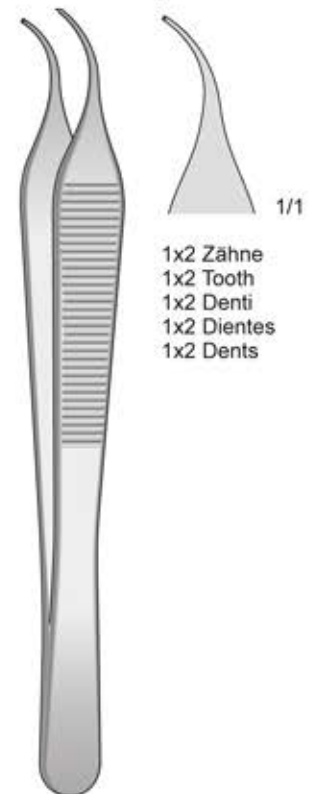

MICRO-ADSON
BD-373
120 mm

1x2 Zähne
1x2 Tooth
1x2 Denti
1x2 Dientes
1x2 Dents

Chirurgische Pinzetten
 Anatomische Pinzetten

 Tissue forceps
 Dressing forceps

 Pinzette chirurgiche
 Pinzette anatomiche

 Pinzas quirúrgicas
 Pinzas de disección

 Pincas quirúrgicas
 Pincas anatómicas

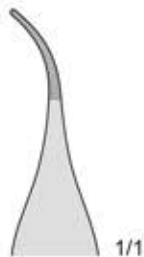
 MICRO-ADSON
 BD-374
 150 mm

1/1

 MICRO-ADSON
 BD-375
 150 mm

1/1

 1x2 Zähne
 1x2 Tooth
 1x2 Denti
 1x2 Dientes
 1x2 Dents

 Kreuzgerieft
 Cross serrated
 Zigrinata a croce
 Estriada a cruz
 Striéé

 Abgewinkelt
 Angled
 Angolata

 MICRO-ADSON
 BD-376
 120 mm

1/1

 1x2 Zähne
 1x2 Tooth
 1x2 Denti
 1x2 Dientes
 1x2 Dents

 ADSON-BROWN
 BD-253
 120 mm

1/1

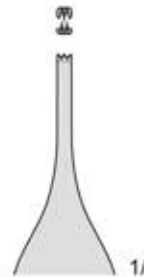
 ADSON
 BD-377
 120 mm

1/1

 2x3 Zähne
 2x3 Tooth
 2x3 Denti
 2x3 Dientes
 2x3 Dents

TC

Chirurgische Pinzetten
Anatomische Pinzetten

Tissue forceps
Dressing forceps

Pinzette chirurgiche
Pinzette anatomiche

Pinzas quirúrgicas
Pinzas de diseccion

Pinces quirurgicales
Pinces anatomiques

Standard



ADSON
BD-380
150 mm



1/1

Standard



ADSON
BD-381
150 mm



1/1

1x2 Zähne
1x2 Tooth
1x2 Denti
1x2 Dientes
1x2 Dents



ADSON-BROWN
BD-382
150 mm



1/1

9x9 Zähne
9x9 Tooth
9x9 Denti
9x9 Dientes
9x9 Dents

Makro
 Absaugkanülen

 Macro
 Suctions Tubes

 Macro cannule
 per aspirazione

 Macro Cánulas
 aspiradoras

 Macro Canules
 aspiratrices

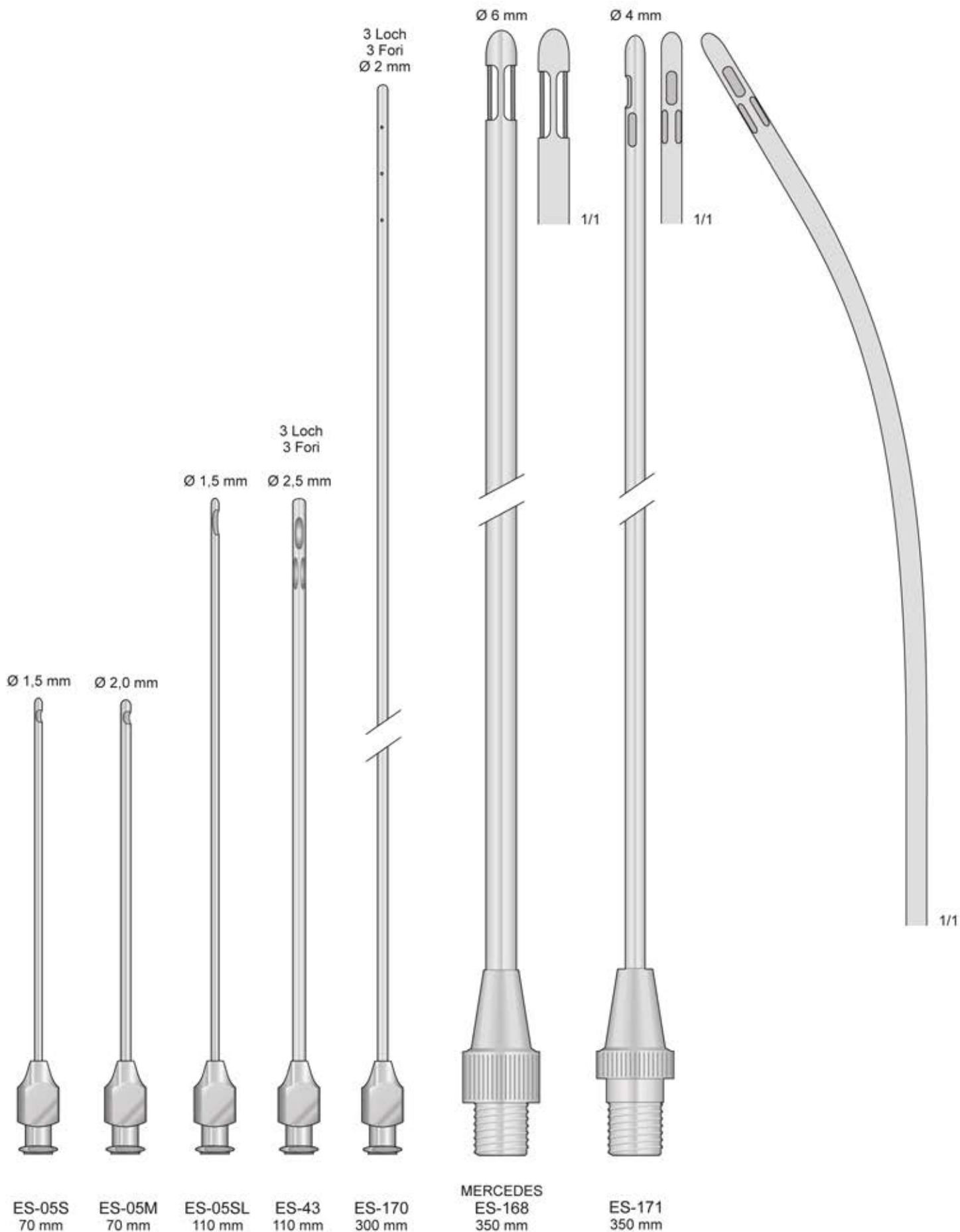
 Absaugkanülen für Fettleibige - Needles and Tubes for obese patients
 Aghi da infiltrazione per grandi obesi - Cánulas aspiradoras para obeso
 Canules aspiratrices pour obèse

Makro
Absaugkanülen

Macro
Suctions Tubes

Macro cannule
per aspirazione

Macro Cánulas
aspiradoras

Macro Canules
aspiratrices

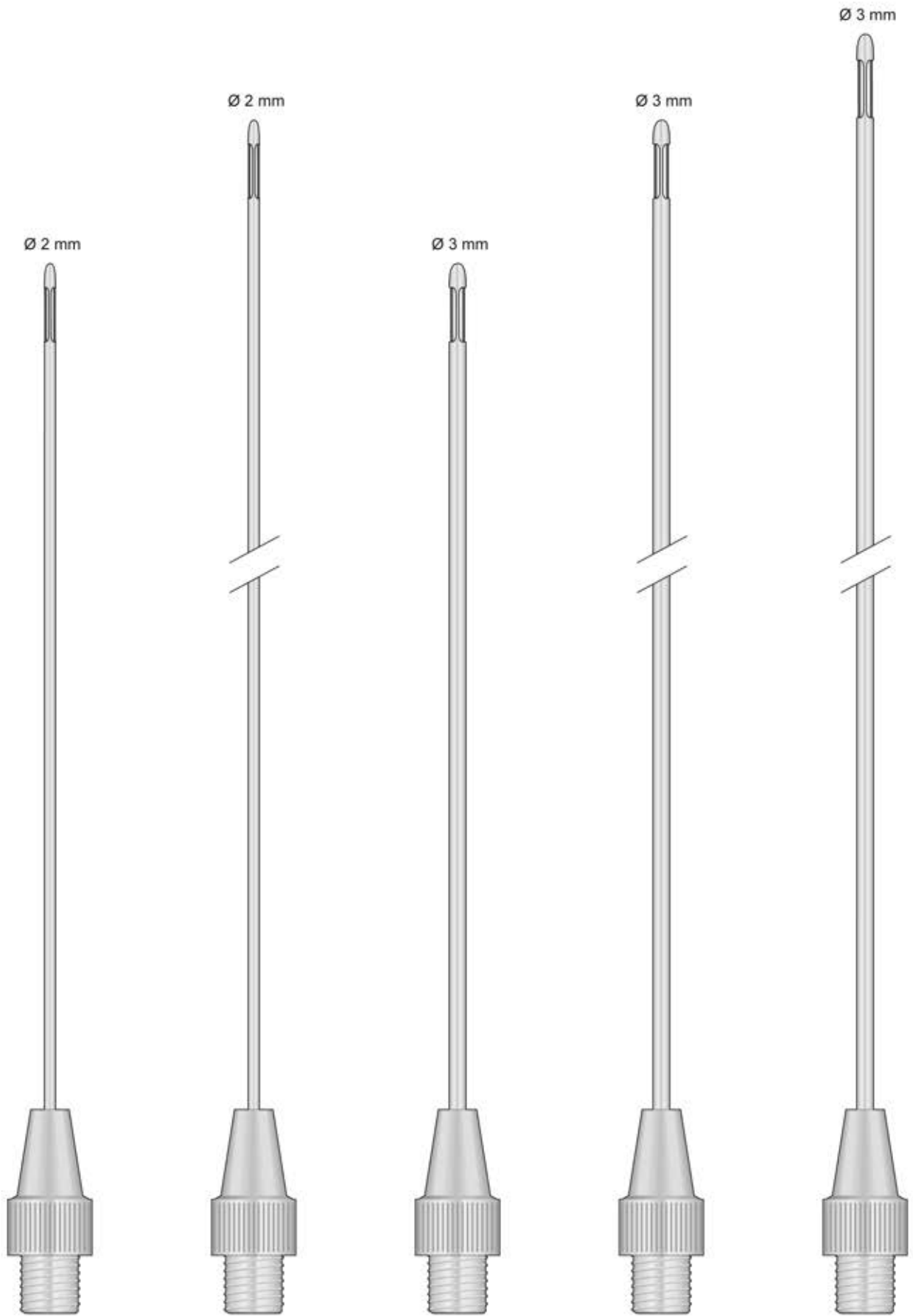

MERCEDES
ES-180
150 mm

MERCEDES
ES-181
250 mm

MERCEDES
ES-182
150 mm

MERCEDES
ES-183
250 mm

MERCEDES
ES-184
300 mm

Makro
 Absaugkanülen

 Macro
 Suctions Tubes

 Macro cannule
 per aspirazione

 Macro Cánulas
 aspiradoras

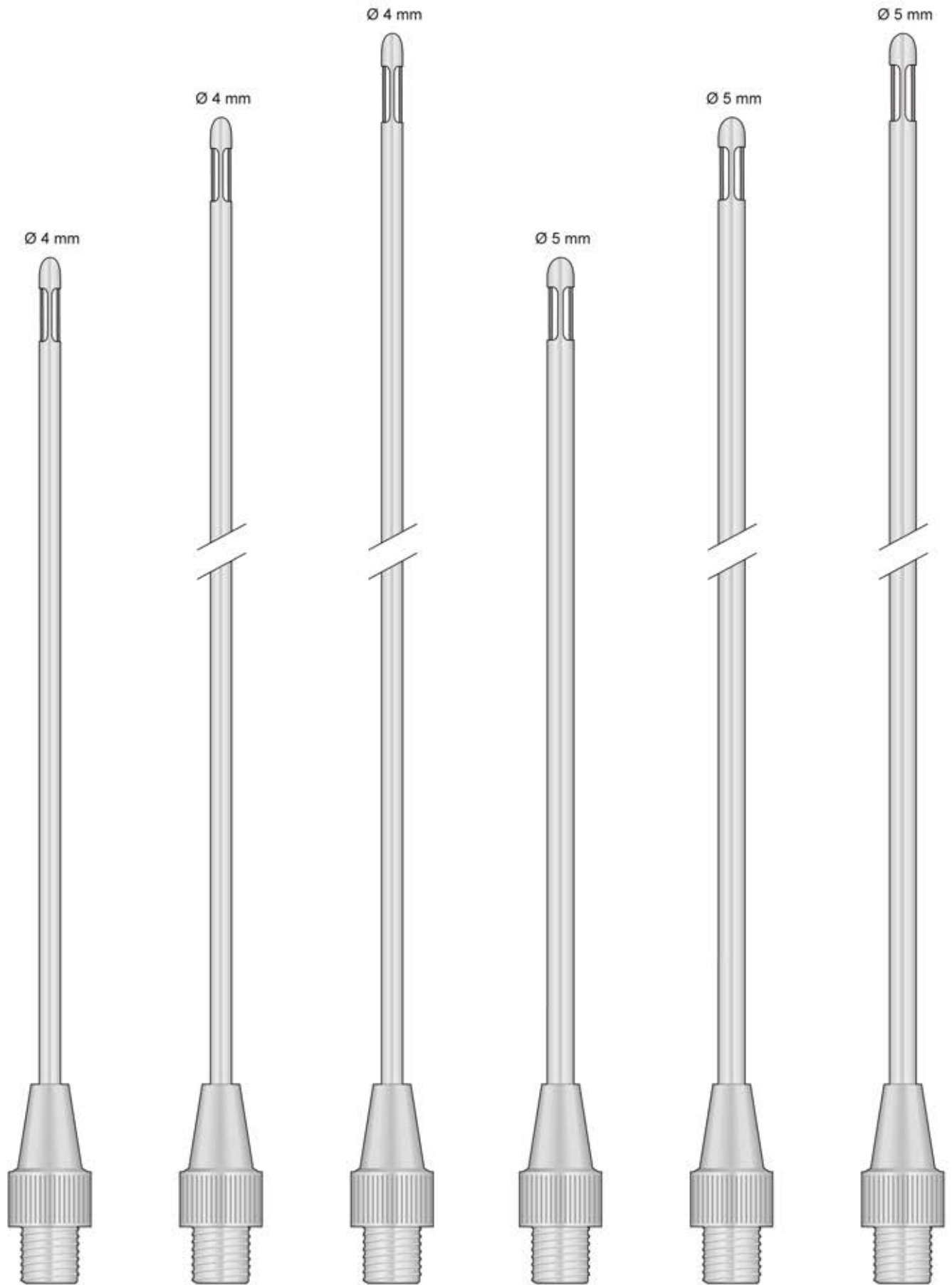
 Macro Canules
 aspiratrices

 MERCEDES
 ES-185
 150 mm

 MERCEDES
 ES-186
 250 mm

 MERCEDES
 ES-187
 300 mm

 MERCEDES
 ES-188
 150 mm

 MERCEDES
 ES-189
 250 mm

 MERCEDES
 ES-190
 300 mm

Absaugkanülen

Suctions Tubes

Cannule per aspirazione

Cánulas aspiradoras

Canules aspiratrices

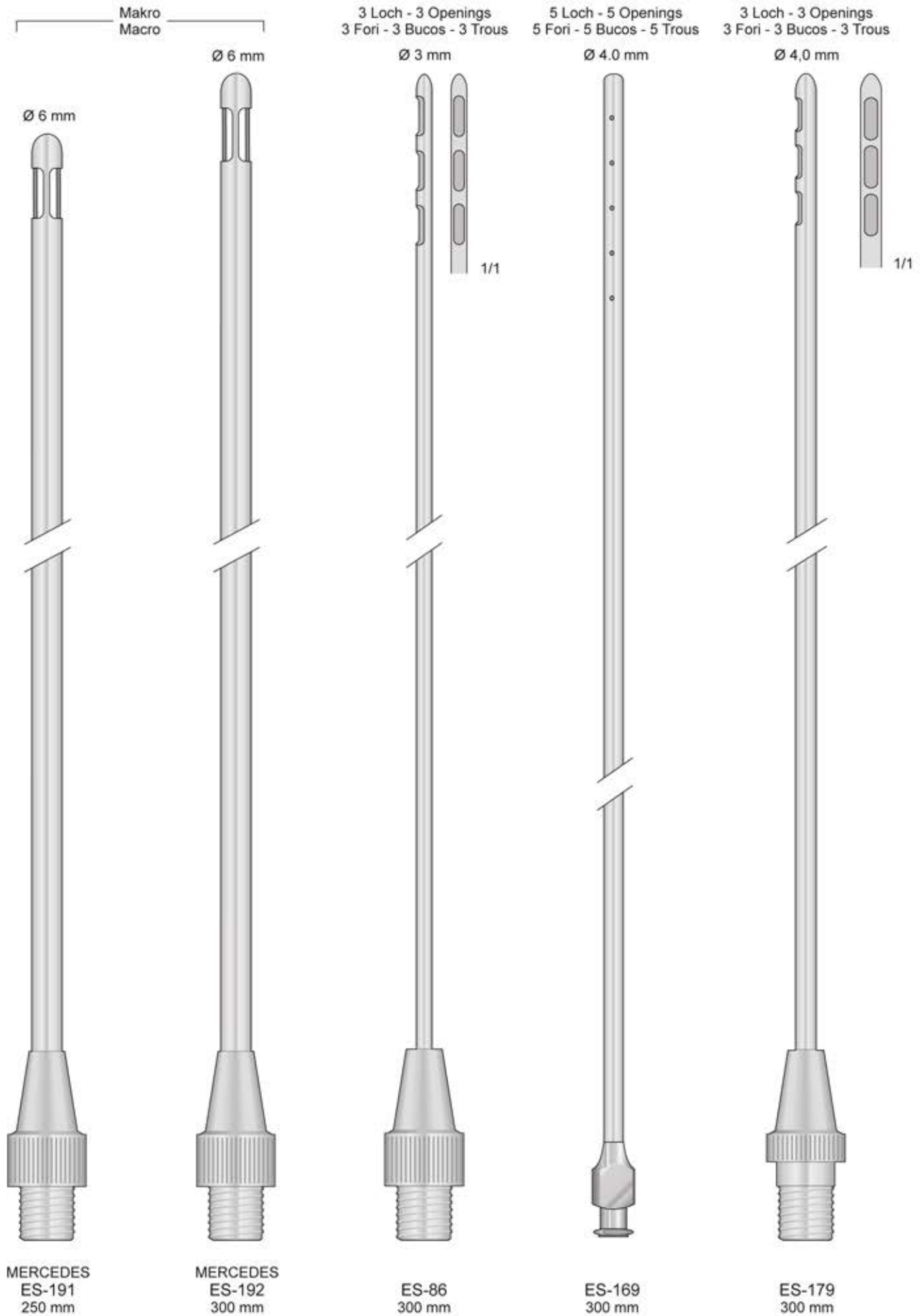

Makro
 Absaugkanülen

 Macro
 Suctions Tubes

 Macro cannule
 per aspirazione

 Macro Cánulas
 aspiradoras

 Macro Canules
 aspiratrices

 Absaugkanülen für Fettleibige - Needles and Tubes for obese patients
 Aghi da infiltrazione per grandi obesi - Cánulas aspiradoras para obeso
 Canules aspiratrices pour obèse

Ø 6 mm

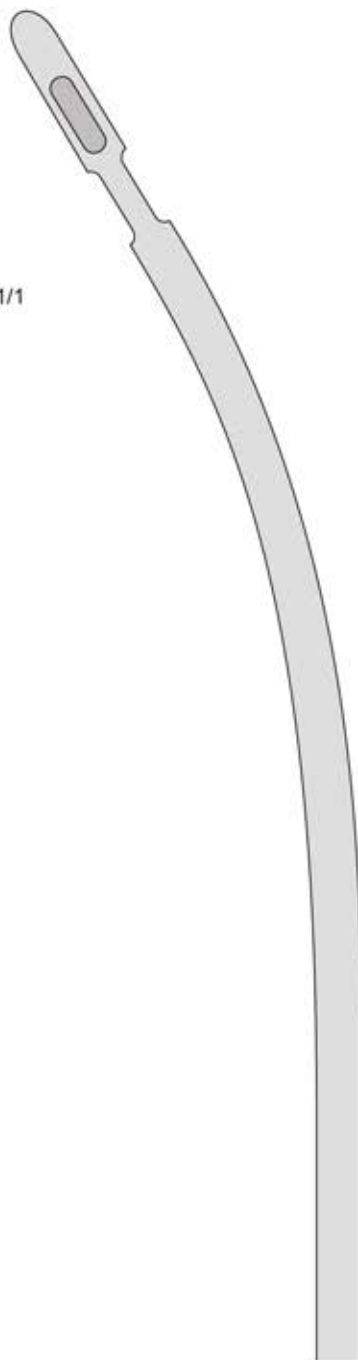
 ES-172
 350 mm

Ø 8 mm

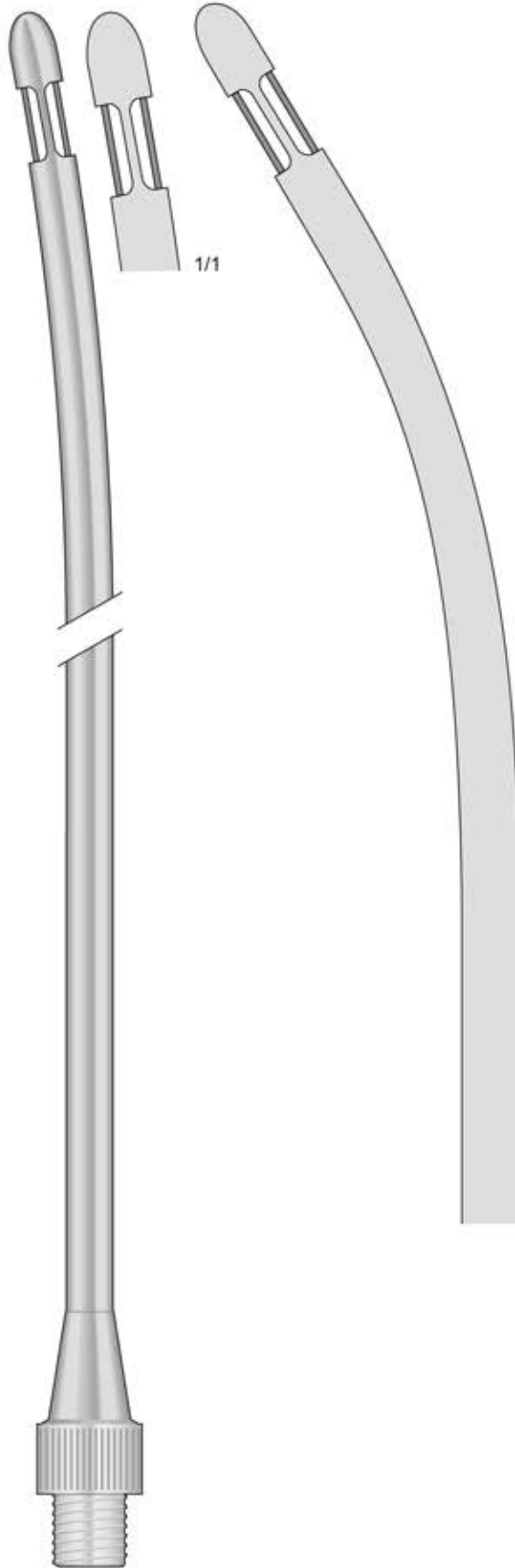
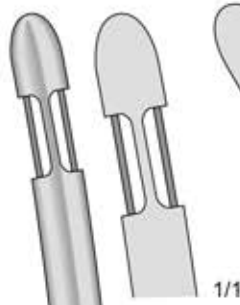
 MERCEDES
 ES-173
 350 mm

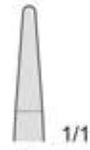
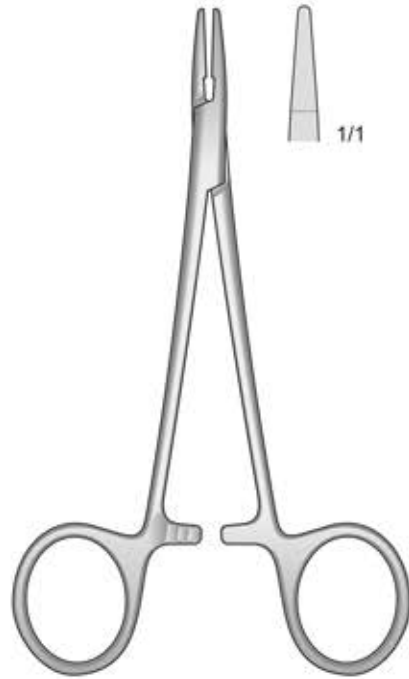

HALSEY
PH-37
130 mm

new



LB-12D



LB-15A



LB-15C



BRACKMANN
GF-238/GF-239
155 mm

GF-238 4x5 FR
GF-239 5x7 FR

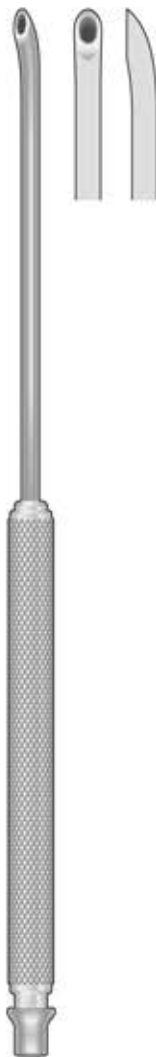

FREER
GF-79
185 mm

Raspatorien, Dissektoren
Raspatories, Dissector
Raschiatori, Dissettori
Separadores
Rugines



DINGMANN
DO-265
155 mm
1-L



DINGMANN
DO-266
155 mm
2-R

Dermatome komplett mit 1 auswechselbarer Klinge und 2 Spannplatten
 Dermatome complete with 1 interchangeable blade and 2 skin plates
 Dermatomo a mano, con una lama intercambiabile, completo di 2 placche per stendere la pelle
 Dermatomo completo, con 1 hoja intercambiabile y 2 placas para extender la piel
 Dermatome avec 1 lame interchangeable et 2 plaques pour tendre la peau

Einstellbar von 0,1 bis 3,0 mm
 Adjustable from 0,1 to 3,0 mm
 Regolazione da 0,1 a 3,0 mm
 Regulable de 0,1 hasta 3,0 mm
 Réglable en épaisseur de 0,1 à 3,0 mm

Einstellbar von 0,1 bis 4,0 mm
 Adjustable from 0,1 to 4,0 mm
 Regolazione da 0,1 a 4,0 mm
 Regulable de 0,1 hasta 4,0 mm
 Réglable en épaisseur de 0,1 à 4,0 mm

Für handelsübliche Rasierklingen
 For usual razor blades
 Per lamette standard
 Para hojas de afeitar usuales
 Pour lames de rasoir modèle standard

Spanplatte
 Skin Fixing Plate
 Placca per stendere la pelle
 Placa para extender la piel
 Plaque pour tendre la peau



SCHINK
DE-10



SILVER
DE-11
190 mm

Ersatzklinge, allein
 Spare Blade only
 Lama di ricambio sola
 Hoja de repuesto
 Lame de rechange, seule



SILVER
DE-12
43 mm



SCHINK
DE-13
300 mm

Ersatzklinge, allein
 Spare Blade only
 Lama di ricambio sola
 Hoja de repuesto
 Lame de rechange, seule



SCHINK
DE-14
102 mm

Dermatome

Dermatomes

Dermatomi

Dermatómos

Dermatomes

Dermatome komplett mit 1 auswechselbarer Klinge und 2 Spannplatten
 Dermatome complete with 1 interchangeable blade and 2 skin plates
 Dermatomo a mano, con una lama intercambiabile, completo di 2 placche per stendere la pelle
 Dermatomo completo, con 1 hoja intercambiabile y 2 placas para extender la piel
 Dermatome avec 1 lame interchangeable et 2 plaques pour tendre la peau

Einstellbar von 0,1 bis 1,5 mm
 Adjustable from 0,1 to 1.5 mm
 Regolazione da 0,1 a 1,5 mm
 Regulable de 0,1 hasta 1,5 mm
 Réglable en épaisseur de 0,1 à 1,5 mm



WATSON
DE-15
300 mm



COBBETT
DE-16
300 mm



HUMBY
DE-17
320 mm

Ersatzklinge, allein
 Spare Blade only
 Lama di ricambio sola
 Hoja de repuesto
 Lame de rechange, seule



HUMBY
DE-18
157 mm

450 gr.

 Ferrozell-Hämmer
 Hammer in Ferrozell
 Martello in Ferrozell
 Martillo en Ferrozell
 Marteau dans Ferrozell

Ø 50 mm

 FL-129
 260 mm

Ø 4.0 mm

 FISCHER
 FO-235
 310 mm

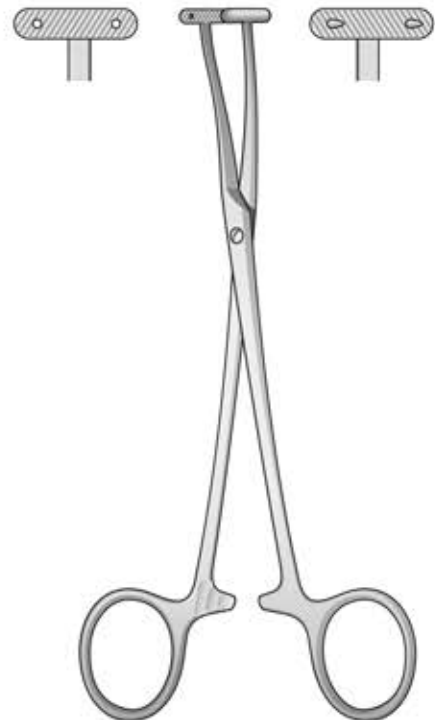
 Kopfhautklemme
 Scalp Haemostatic forceps
 Pinza emostatica per il cuoio capelluto
 Pinza hemostáticas para pericraneo

 DE MARTEL
 FB-119
 145 mm

Kanülenreinigungs-
bürsten

Cleaning brush
for tubes

Scovolini per
pulizia cannule

Cepillo para
limpiar cánulas

Brosse de nettoyage
pour canules



GF-182
215 mm



GF-183
300 mm

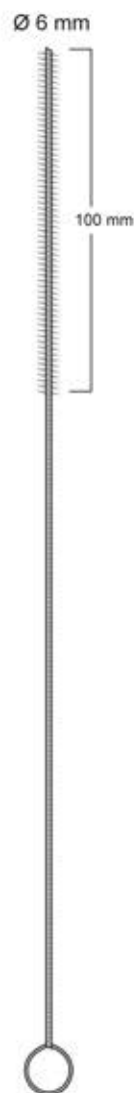

GF-185
300 mm

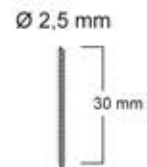

GF-186
500 mm

Super Cut

Mit einer Schneide gezahnt
 With one blade serrated
 Con una lama dentellata
 Con una hoja dentada
 Avec une lame dentée

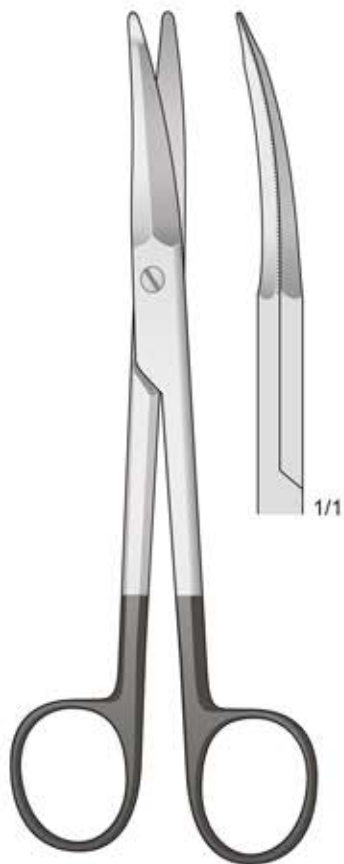

REES-FACE-LIFT
FM-304
 150 mm

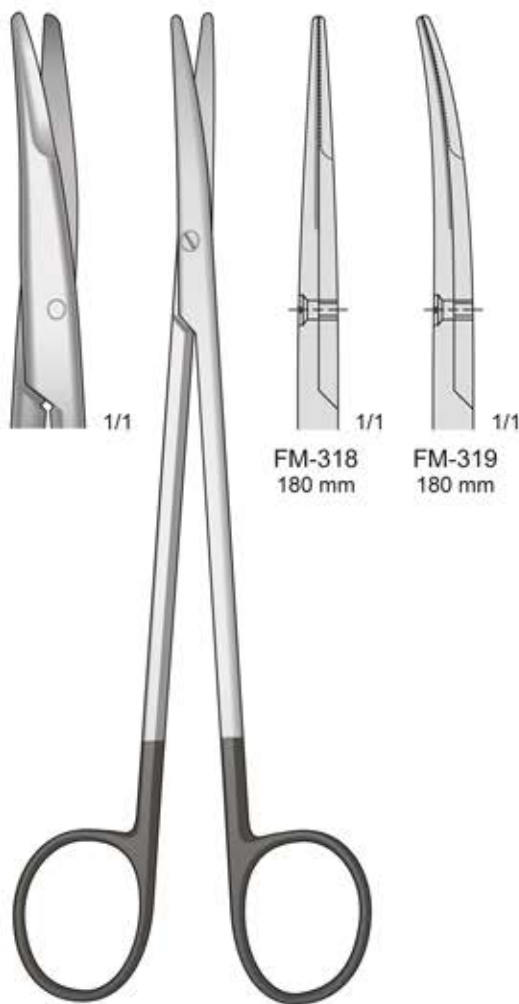

FM-318
 180 mm

FM-319
 180 mm

METZENBAUM
FM-318/FM-319
 180 mm

Super Cut

Mit einer Schneide gezahnt
With one blade serrated
Con una lama dentellata
Con una hoja dentada
Avec une lame dentée

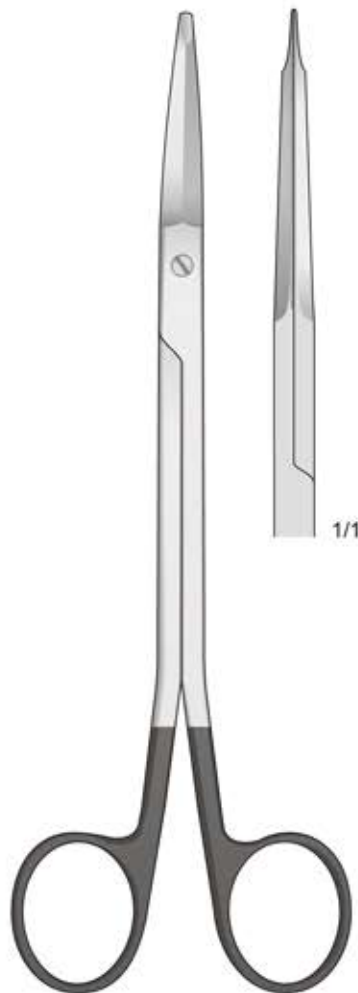

FREEMANN-KAYE
FM-332
180 mm

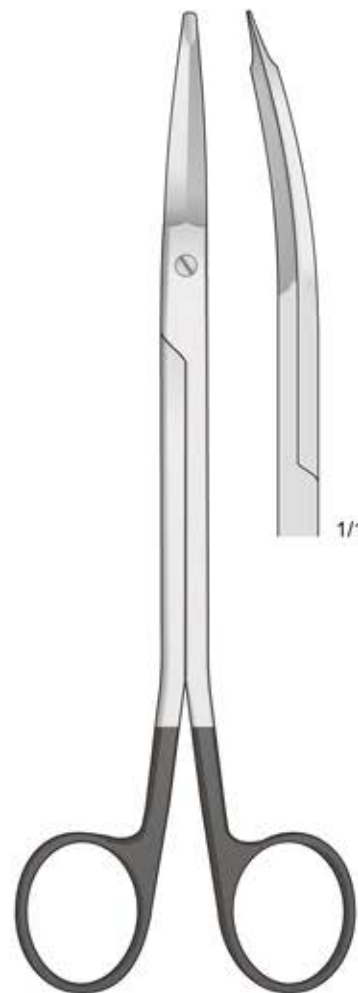

FREEMANN-KAYE
FM-333
180 mm

Vergoldet Super Cut

Mit einer Schneide gezahnt
 With one blade serrated
 Con una lama dentellata
 Con una hoja dentada
 Avec une lame dentée

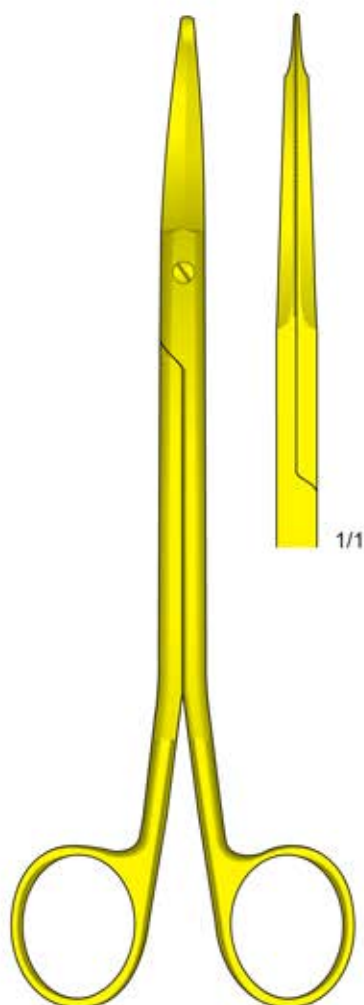

FREEMAN KAYE
 FM-332G
 180 mm

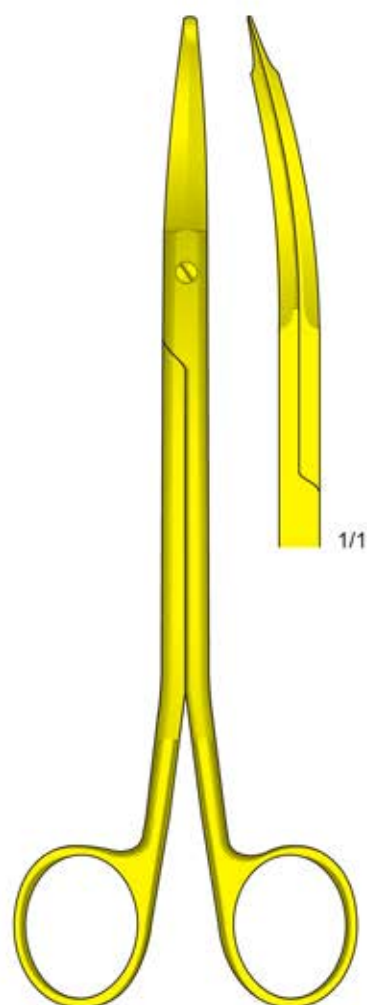

FREEMAN KAYE
 FM-333G
 180 mm

Vergoldet Super Cut

Mit einer Schneide gezahnt
With one blade serrated
Con una lama dentellata
Con una hoja dentada
Avec une lame dentée

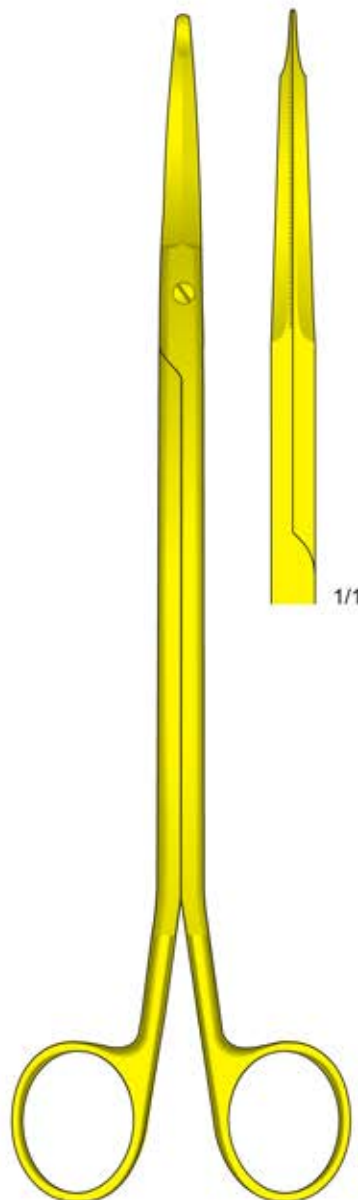

GORNEY
FM-313G
230 mm

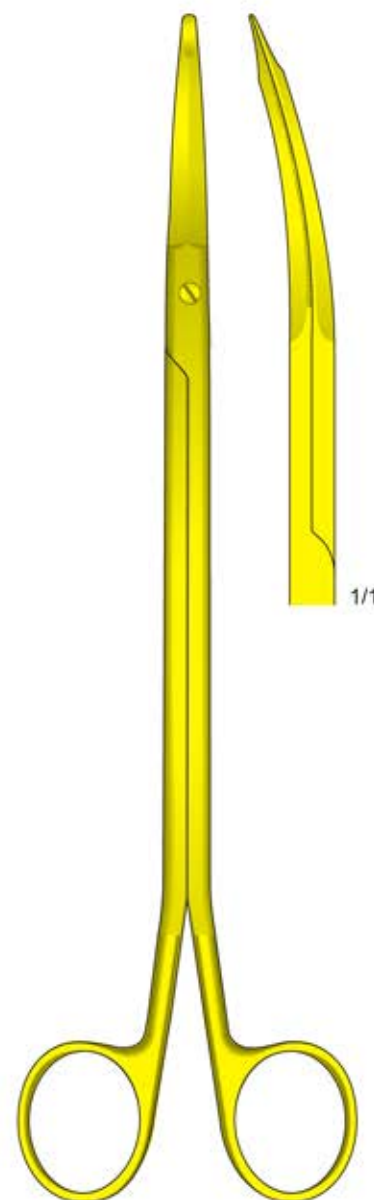

GORNEY
FM-314G
230 mm



HARTMANN-HALLE
 OM-108M
 150 mm

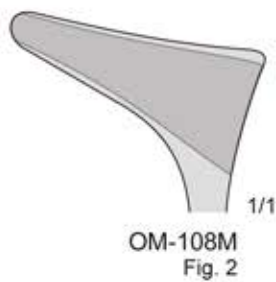

OM-108M
 Fig. 2



HARTMANN-HALLE
 OM-106/OM-109
 150 mm



OM-106
 Fig. 00

Kinder
 Children
 Bambini
 Niños
 Enfants

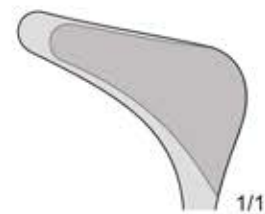

OM-107
 27 mm
 Fig. 1

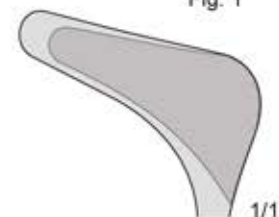

OM-108
 31 mm
 Fig. 2

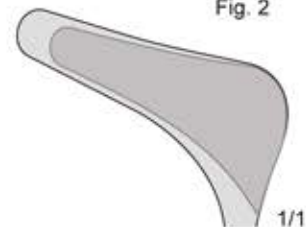

OM-109
 35 mm
 Fig. 3

ES-150
 Komplettsset mit 3 Stück - Set complete with 3 pieces
 Set completo con 3 pezzi - Set completo con 3 piezas
 Set complete avec 3 pièces

 ES-151 + ES-152 + ES-153

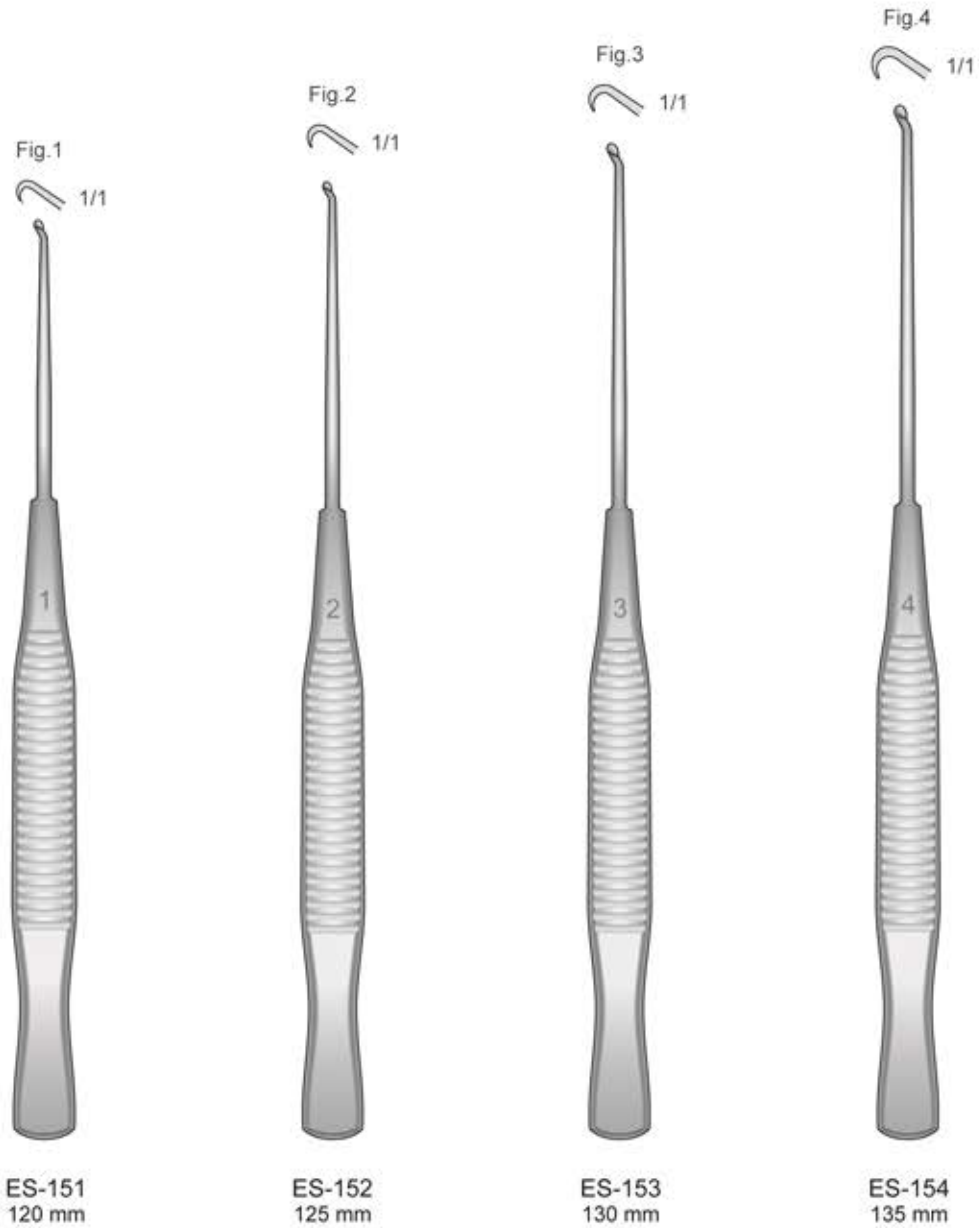

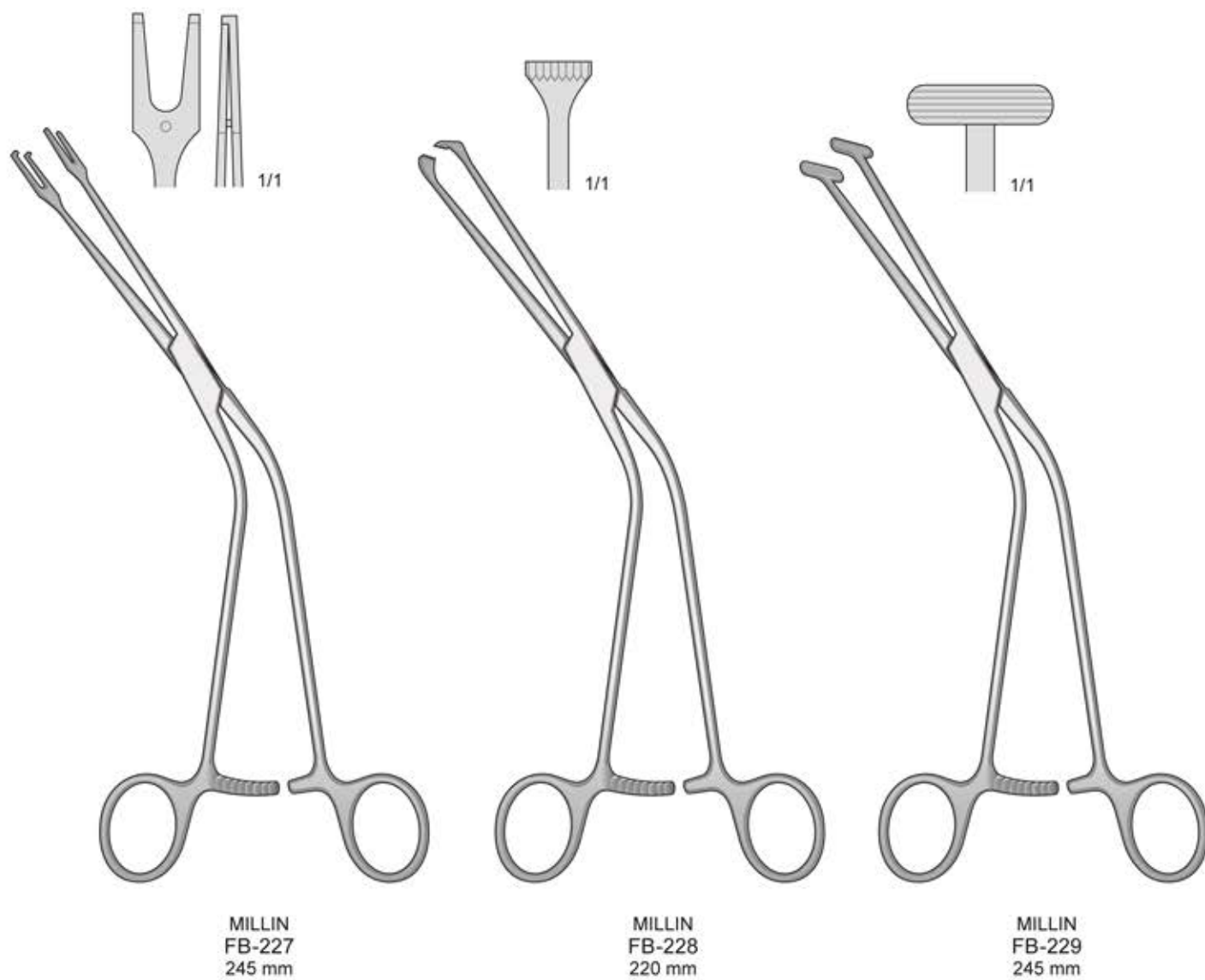

Atraumatische - Atraumatic
Atraumatische - Atraumáticas
Atraumatiques

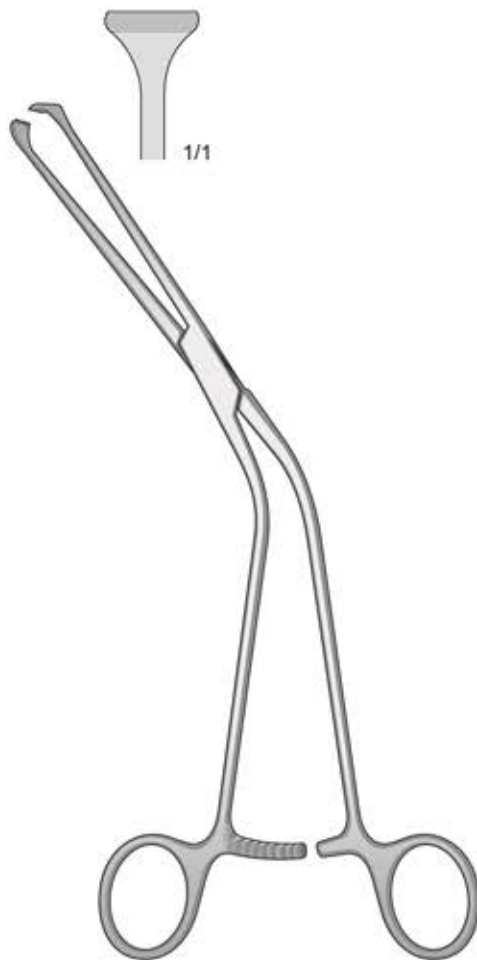

MILLIN
FB-230
220 mm

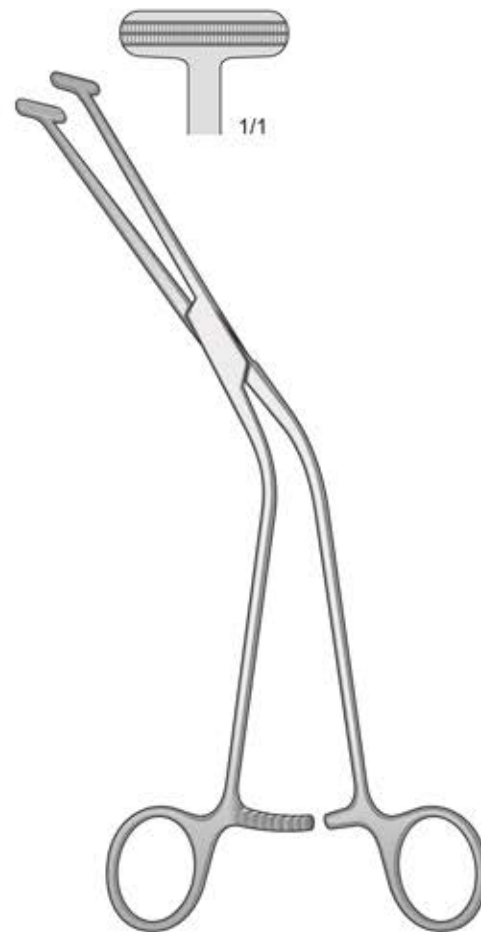

MILLIN
FB-231
245 mm

Alogena



HT-250S

 Fiberglas-Lichtkabel
 Fiber Optic Cable
 Cavo a fibre ottiche

HT-131K Ø 3,5 mm - 230 cm

HT-134K Ø 4,8 mm - 300 cm

Xenon



HT-180X

Xenon



HT-300X

 Fiberglas-Lichtkabel
 Fiber Optic Cable
 Cavo a fibre ottiche
 per alte temperature

HT-1331K Ø 3,5 mm - 230 cm

HT-1332K Ø 3,5 mm - 300 cm

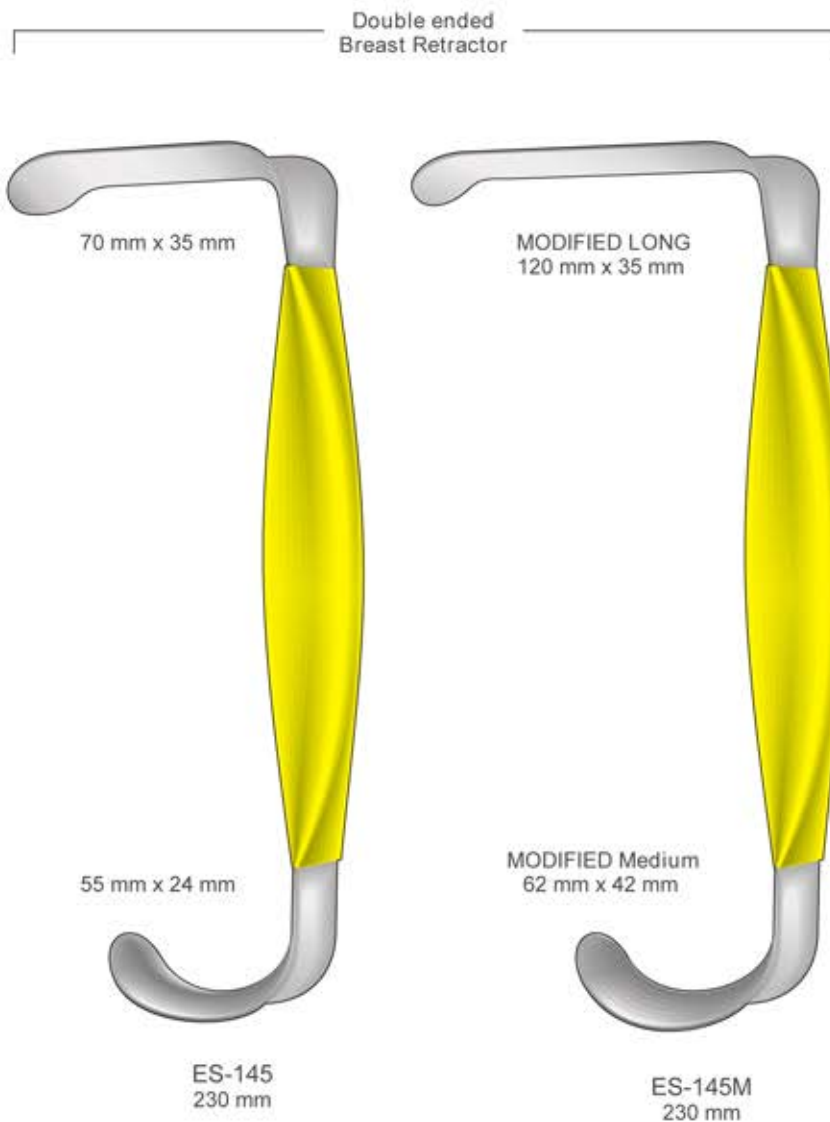

Mit Absaugkanülen
With Suction Tube
Con aspirazione
Con aspiración
Avec aspiration



Raccordo per
 due siringhe

 ES-03
 21 mm

 Raccordo
 Luer Lock

 ES-306
 34 mm

 ES-301
 160 mm

 ES-302
 155 mm

 ES-303
 155 mm

Kanüle
für Liposculture

Cannula
for Liposculture

Cannule da
Liposcultura

Cánulas de
Liposcultura

Canules pour
liposculture

Luer-Lock Cannule

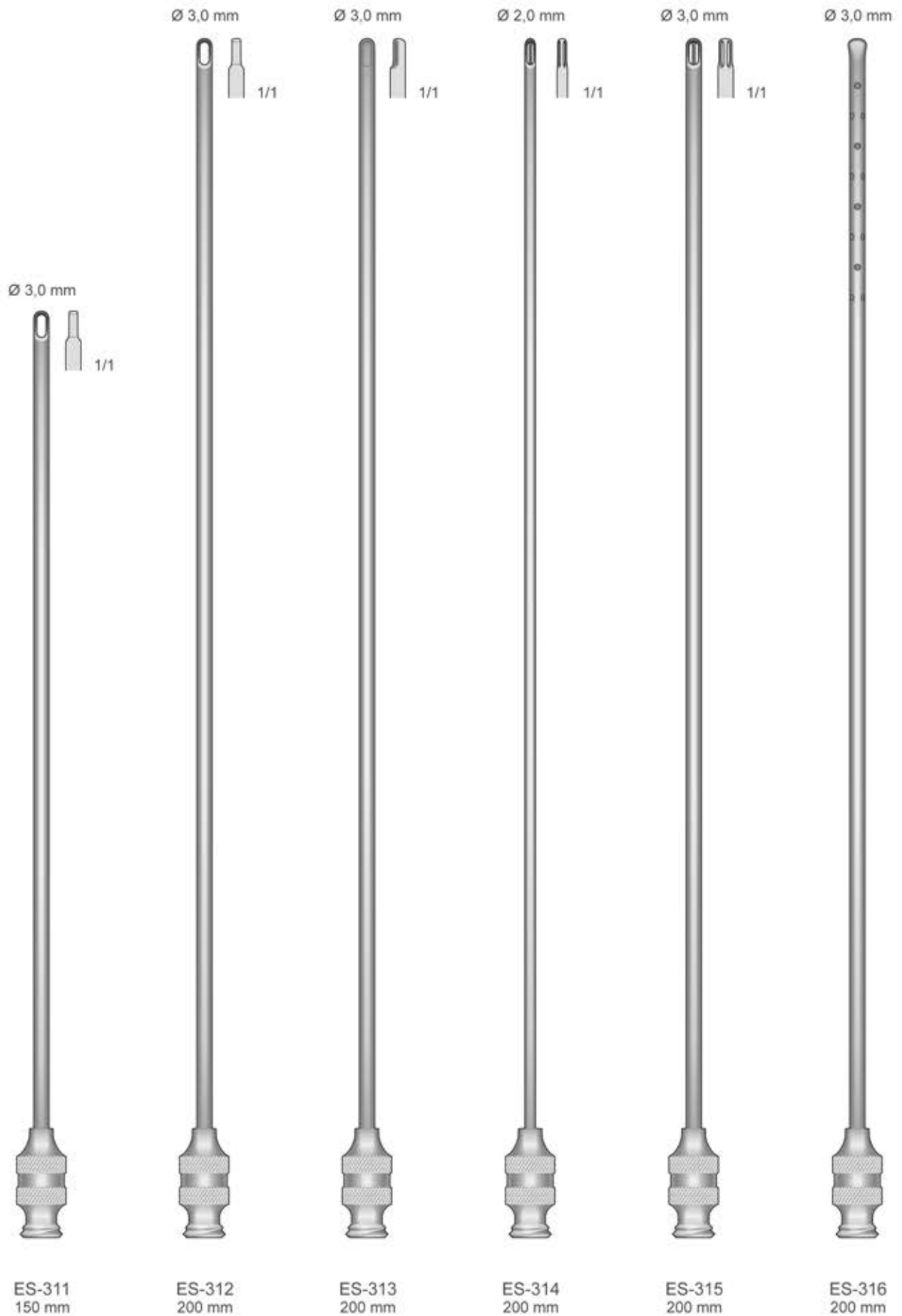

Kanüle
 für Liposculture

 Cannula
 for Liposculture

 Cannule da
 Liposcultura

 Cánulas de
 Liposcultura

 Canules pour
 liposculture

Luer-Lock Cannule

Ø 2,0 mm

Ø 3,0 mm

Ø 3,0 mm

Ø 2,5 mm

Ø 3,0 mm

Ø 3,0 mm

Ø 3,0 mm

 ES-317
 200 mm

 ES-318
 200 mm

 ES-319
 300 mm

 ES-320
 250 mm

 ES-321
 200 mm

 ES-322
 300 mm

 ES-323
 250 mm

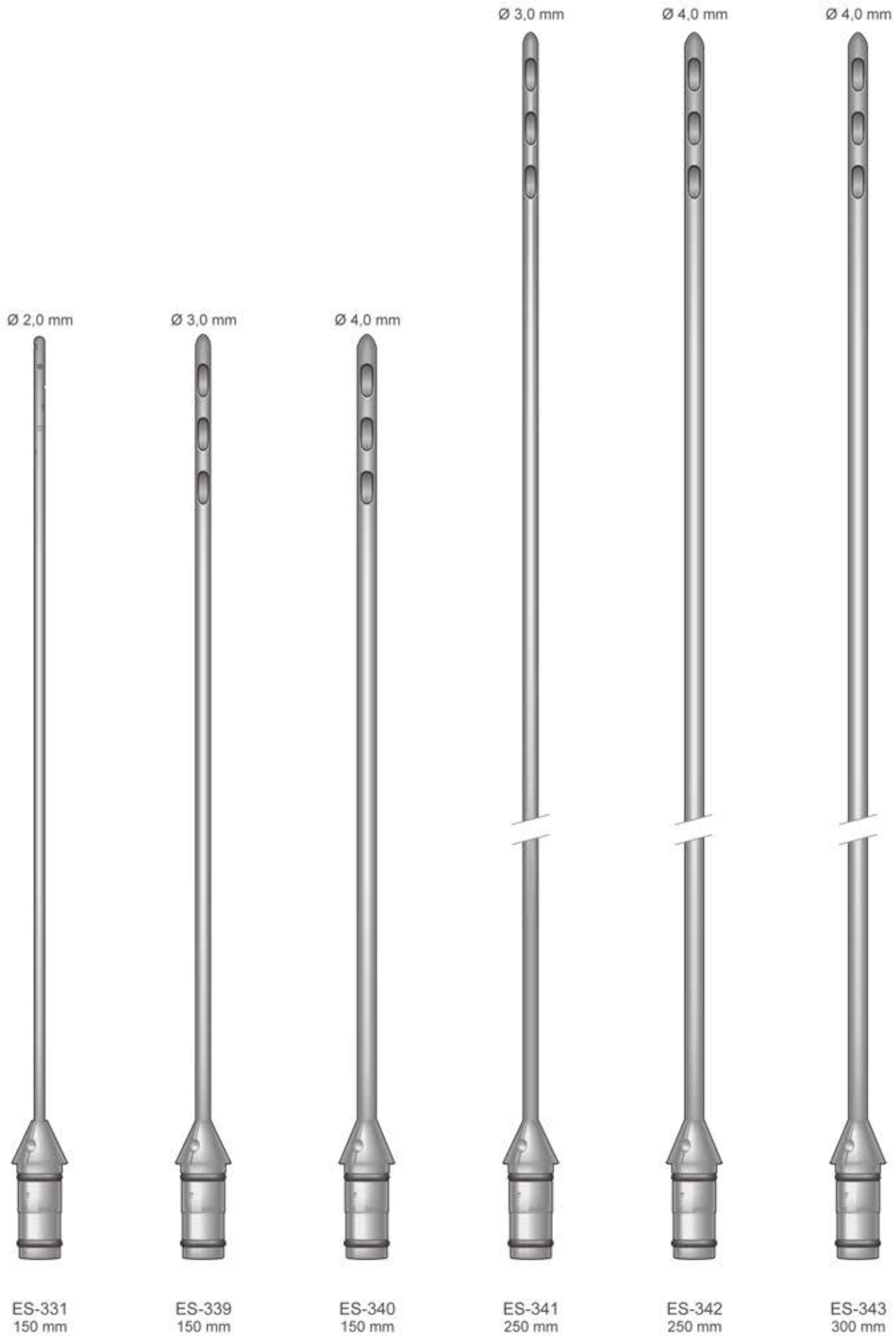

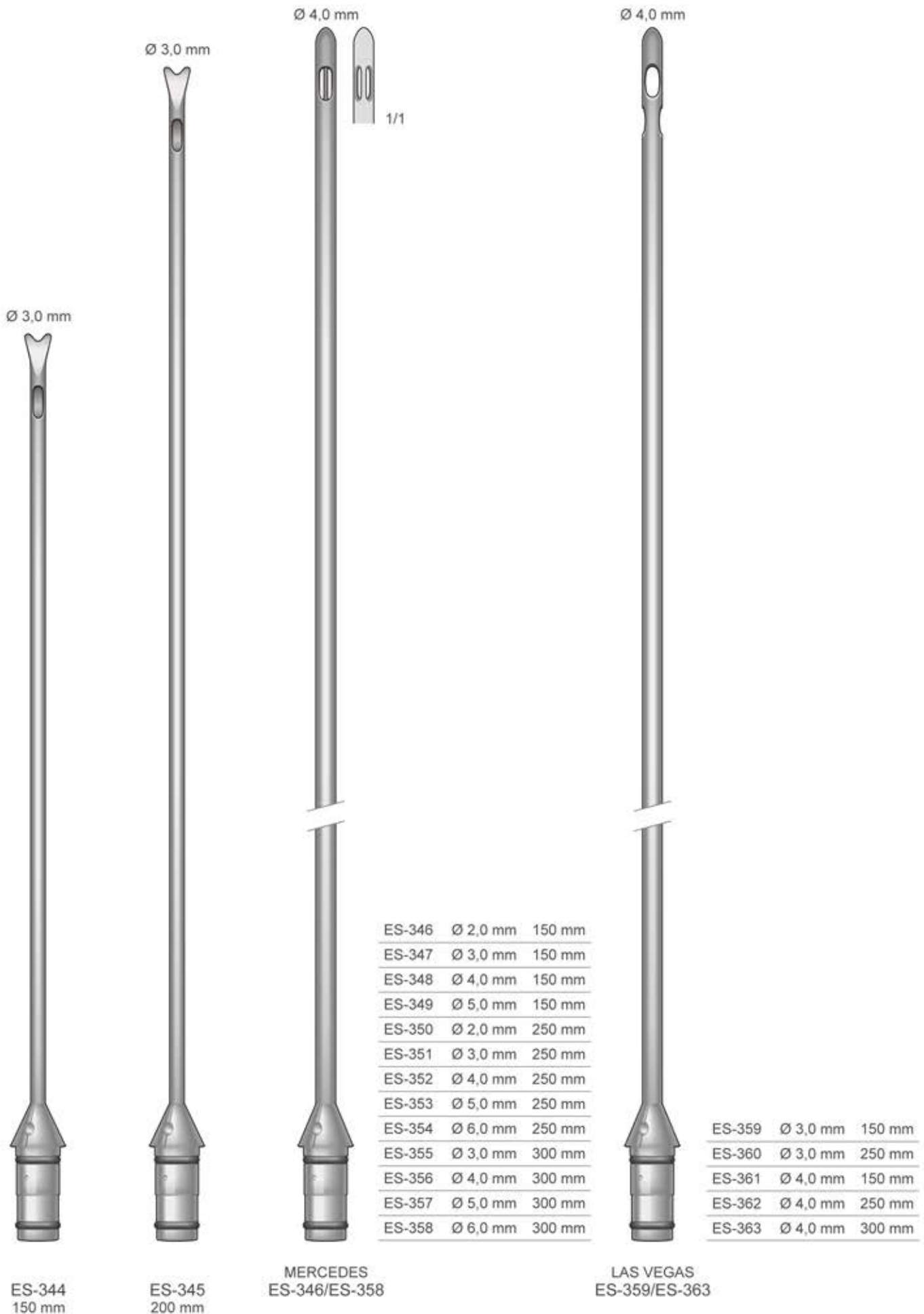

ES-346	Ø 2,0 mm	150 mm
ES-347	Ø 3,0 mm	150 mm
ES-348	Ø 4,0 mm	150 mm
ES-349	Ø 5,0 mm	150 mm
ES-350	Ø 2,0 mm	250 mm
ES-351	Ø 3,0 mm	250 mm
ES-352	Ø 4,0 mm	250 mm
ES-353	Ø 5,0 mm	250 mm
ES-354	Ø 6,0 mm	250 mm
ES-355	Ø 3,0 mm	300 mm
ES-356	Ø 4,0 mm	300 mm
ES-357	Ø 5,0 mm	300 mm
ES-358	Ø 6,0 mm	300 mm

ES-359	Ø 3,0 mm	150 mm
ES-360	Ø 3,0 mm	250 mm
ES-361	Ø 4,0 mm	150 mm
ES-362	Ø 4,0 mm	250 mm
ES-363	Ø 4,0 mm	300 mm

 ES-344
 150 mm

 ES-345
 200 mm

 MERCEDES
 ES-346/ES-358

 LAS VEGAS
 ES-359/ES-363

Ø 3,0 mm



ES-364
250 mm

Ø 3,0 mm



ES-365/ES-366

ES-365	Ø 3,0 mm	150 mm
ES-366	Ø 3,0 mm	200 mm

Pinza per rimozione punti metallici

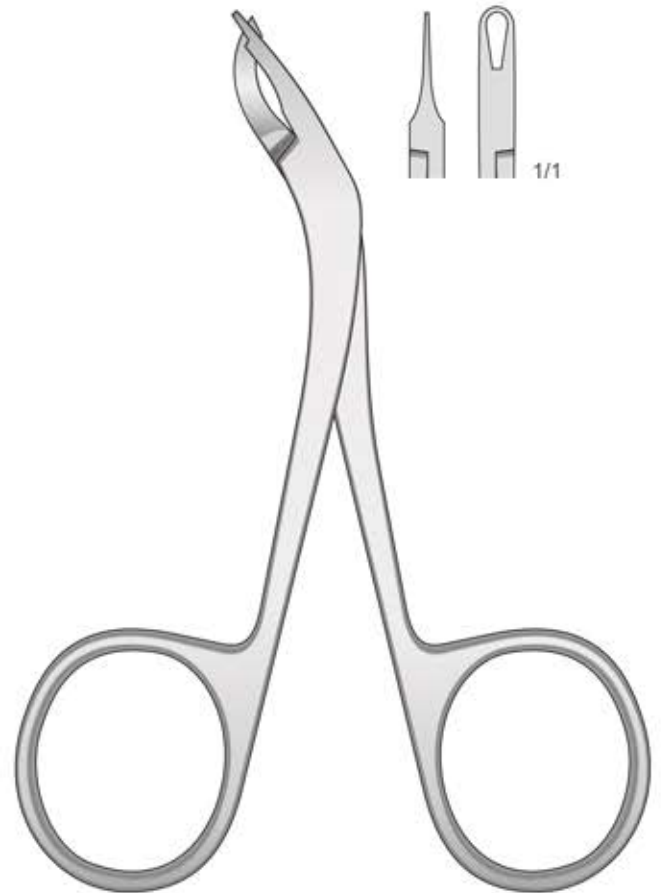

BF-64
115 mm

Art.	Art.	Art.	Art.	Art.	Art.	Art.	Art.	Art.	Art.
BD-253	34	DO-115	25	ES-163	10	ES-360	60	LB-12D	41
BD-347	31	DO-116	25	ES-164	13	ES-361	60	LB-15A	41
BD-348	31	DO-135	25	ES-165	13	ES-362	60	LB-15C	41
BD-349	31	DO-207	10	ES-168	36	ES-363	60		
BD-350	11	DO-208	28	ES-169	39	ES-371	61	OM-09	11
BD-351	32	DO-209	28	ES-170	36			OM-106	50
BD-352	32	DO-210	28	ES-171	36	FB-119	44	OM-107	50
BD-353	32	DO-219	24	ES-172	40	FB-227	52	OM-108	50
BD-354	32	DO-228	24	ES-173	40	FB-228	52	OM-108M	50
BD-355	32	DO-229	24	ES-179	39	FB-229	52	OM-109	50
BD-356	32	DO-238	24	ES-180	37	FB-230	53	OM-190	16
BD-358	30	DO-239	24	ES-181	37	FB-231	53	OM-191	16
BD-359	30	DO-253	27	ES-182	37			OM-192	16
BD-360	30	DO-254	26	ES-183	37	FG-121	23	OM-192L	16
BD-361	30	DO-255	26	ES-184	37	FG-163	22	OM-193	17
BD-362	30	DO-256	26	ES-185	38	FG-192	21	OM-194	17
BD-363	30	DO-265	41	ES-186	38	FG-193	21	OM-195	17
BD-364	31	DO-266	41	ES-187	38	FG-194	21	OM-195L	17
BD-365	31	DO-267	28	ES-188	38	FG-195	21	OM-196	18
BD-366	31	DO-268	27	ES-189	38			OM-197	18
BD-367	31	DO-269	27	ES-190	38	FL-129	44	OM-198	18
BD-370	33	DO-275	26	ES-191	39	FL-137	29	OM-230	8
BD-371	33	DO-276	26	ES-192	39	FL-413	24	OM-231	8
BD-372	33	DO-277	26	ES-211	7	FL-414	24	OM-240	19
BD-373	33	DO-278	26	ES-212	7	FL-415	24	OM-241	19
BD-374	34	DO-297	26	ES-213	7	FL-416	24	OM-242	19
BD-375	34	DO-298	26	ES-215	7			OM-243	19
BD-376	34	DO-300	28	ES-216	7	FM-302	22		
BD-377	34	DO-316	29	ES-217	7	FM-304	46	PH-37	41
BD-380	35	DO-320	27	ES-219	10	FM-308	22		
BD-381	35	DO-321	27	ES-221	11	FM-313G	49	RE-01	3, 15
BD-382	35	DO-322	27	ES-301	56	FM-314G	49	RE-02	3, 15
		DO-401	15	ES-302	56	FM-318	46	RE-03	3, 15
BF-64	61	DO-401R	15	ES-303	56	FM-319	46	RE-10	3, 15
				ES-306	56	FM-332	47		
BT-21	11	ES-02	29	ES-311	57	FM-332G	48	SC-3	23
BT-53	14	ES-03	56	ES-312	57	FM-333	47		
BT-58	14	ES-04	29	ES-313	57	FM-333G	48		
BT-59	14	ES-05M	36	ES-314	57				
BT-138	11	ES-05S	36	ES-315	57	FO-95	23		
BT-149	14	ES-18S	13	ES-316	57	FO-190	23		
BT-150	14	ES-19S	13	ES-317	58	FO-235	44		
BT-362	14	ES-20S	13	ES-318	58	FO-350	20		
BT-363	14	ES-20	13	ES-319	58	FO-370	20		
BT-364	14	ES-29	29	ES-320	58	FO-371	20		
BT-365	14	ES-43	36	ES-321	58	FO-372	20		
BT-370	14	ES-86	39	ES-322	58	FO-390	20		
BT-501	3	ES-110	11	ES-323	58	FO-391	20		
BT-502	3	ES-130	55	ES-331	59	FO-392	20		
BT-503	3	ES-131	5	ES-339	59	FO-397	20		
BT-504	3	ES-132	5	ES-340	59				
BT-505	4	ES-133	5	ES-341	59	FR-34	24		
BT-510	4	ES-134	5	ES-342	59	FR-190	11		
BT-511	5	ES-135	5	ES-343	59				
		ES-136	6	ES-344	60	GF-79	41		
DB-118	10	ES-137	6	ES-345	60	GF-182	45		
DB-119	10	ES-138	6	ES-346	60	GF-183	45		
		ES-139	6	ES-347	60	GF-185	45		
DE-10	42	ES-144	10	ES-348	60	GF-186	45		
DE-11	42	ES-145	55	ES-349	60	GF-238	41		
DE-12	42	ES-145M	55	ES-350	60	GF-239	41		
DE-13	42	ES-146	12	ES-351	60				
DE-14	42	ES-147	12	ES-352	60	HT-131K	54		
DE-15	43	ES-148	12	ES-353	60	HT-134K	54		
DE-16	43	ES-149	10	ES-354	60	HT-180X	54		
DE-17	43	ES-150	51	ES-355	60	HT-250S	54		
DE-18	43	ES-151	51	ES-356	60	HT-300X	54		
		ES-152	51	ES-357	60	HT-1331K	54		
DO-113	25	ES-153	51	ES-358	60	HT-1332K	54		
DO-114	25	ES-154	51	ES-359	60				