

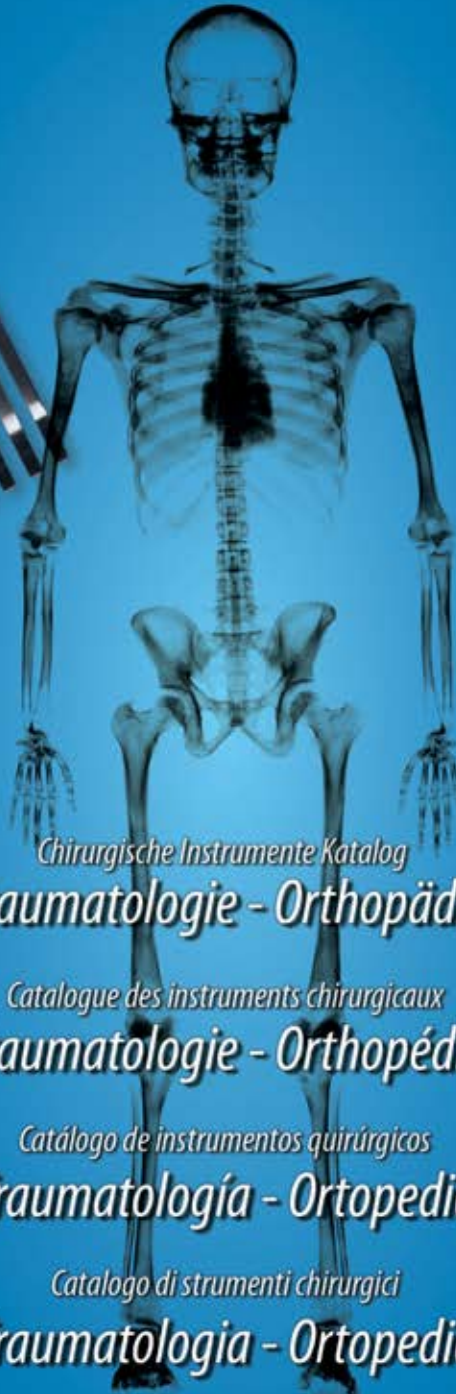

BROMED
INSTRUMENTS

Das Instrument.



Chirurgische Instrumente Katalog

Traumatologie - Orthopädie

Catalogue des instruments chirurgicaux

Traumatologie - Orthopédie

Catálogo de instrumentos quirúrgicos

Traumatología - Ortopedia

Catalogo di strumenti chirurgici

Traumatologia - Ortopedia

Catalogue of Surgical Instruments

Traumatology - Orthopaedics



BROMED
INSTRUMENTS



BROMED
INSTRUMENTS

Traumatology - Orthopaedics

Traumatologie - Orthopädie

Traumatologie - Orthopédie

Traumatología - Ortopedia

Traumatologia - Ortopedia



B. BRAUN
INSTRUMENTS

Table of Contents

Inhaltsverzeichnis

Table des matières

Tabla de contenido

Tavola dei contenuti

BROMED
 INSTRUMENTS

1	Retractors Retraktoren Écarteurs Separadores Divaricatori					
27	Elevators Elevatoren Élévateurs Elevadores Elevatori	Periosteal (Raspatories) Raspatorien Rugines périostiques Periostótomos (Legras) Scollaperiosteo (Periostotomi)	Bone files Knochenfeilen Limes à os Limas para hueso Lime per osso	Sharp Curettes Scharfe Küretten Curettes tranchantes Curetas cortantes Curette taglienti		
63	Surgical Mallets Chirurgische Hämmer Maillets chirurgicaux Martillos quirúrgicos Martelli chirurgici	Tampers Stößels Compacteurs Compactadores Compattatori	Osteotomes Osteotome Ostéotomes Osteótomos Osteotomi	Chisels Meißeln Burins Cinceles ScalPELLI		
87	Bone surgery Knochenchirurgie Chirurgie osseuse Cirugía ósea Chirurgia ossea	Bone Holding Forceps Knochenhaltezange Daviers à os Pinzas de sujeción Pinze per fissare l'osso	Hand Surgery Handchirurgie Chirurgie de la main Cirugía de la mano Chirurgia della mano	Bone Rongeurs Hohlmeißelzangen Pincés gouges Pinzas gubias Pinze ossivore	Bone Cutting Scissors Knochensplitterscheren Ciseaux à os Tijeras para huesos Forbici ossivore	
115	Wires and Nails Bohrdrähte Broches et clous Agujas y clavos Fili e chiodi	Extension Bows Extensionsbügel Étriers d'extension Arcos de tracción Archi da trazione	Twist Drills Spiralbohrer Forets Brocas espirales Maschiatori - Taps	Osteosintese Osteosynthesis Ostéosynthèse Osteosintesis Osteosintesi	Hand Drills Handbohrapparate Perceuses à main Perforadores manuales Perforatori a mano	Screwdrivers Schraubendreher Tournevis Destornilladores Cacciaviti
143	Measuring Instruments Messinstrumente Instruments à mesurer Instrumentos de medición Strumenti per misura					
149	Forceps for plattes Biege und schränkhebel Pincés à courber pour plaques Pinzas para placas Pinze e chiavi per placche	Wire Guides Drahtumführungsnadel Aiguilles passe-fils Agujas pasa hilos Passafili	Needle Holders Nadelhalter Porte-aiguilles Porta-agujas Port'aghi	Cutting Pliers Schneidezangen Pincés coupante Alicates de corte Tronchesi di taglio		
169	Retractors Retraktoren Écarteurs Separadores Divaricatori	Nervhaken Nerve Hooks Crochets à nerfs Ganchos para nervios Uncini per nervi	Micro Dissectors Mikro-Dissektoren Micro Dissecteurs Micro Dissecadores Micro Dissettori			
189	Suction Tubes Saugkanülen Canules d'aspiration Cánulas de aspiración Cannule per aspirazione	Laminectomy Laminektomie Laminectomia Laminectomía Laminectomia	Extension Bows Extensionsbügel Étriers d'extension Arcos de tracción Archi da trazione	Knives Messer Couteaux Cuchillos Coltelli	Bone files Knochenfeilen Limes à os Limas para hueso Lime per osso	Scalpels Skalpelle Bistouris Bisturías Bisturi
207	Towel Clamps Tuchklemmen Pince fixe-compresses Pinzas de campo Fissateli	Scissors Scheren Ciseaux Tijeras Forbici	Tissue Forceps Chirurgische Pinzetten Pincés à tissus Pinzas quirúrgicas Pinzette chirurgiche	Needle Holders Nadelhalter Porte-aiguilles Porta-agujas Port'aghi	Hemostatic Forceps Arterienklemmen Pincés hémostatiques Pinzas hemostáticas Pinzette emostatiche	
221	Alphanumerical Index Alphanumerischen Index Index alphanumérique Índice alfanumérico Índice alfanumerico					



BROMED
INSTRUMENTS

Retractors
Retraktoren
Écarteurs
Separadores
Divaricatori



KOCHER
BT-139
205 mm



KOCHER
BT-140
220 mm

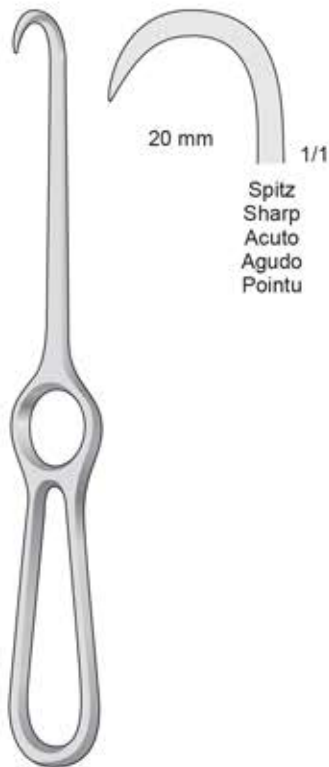

VOLKMANN
BT-126
220 mm

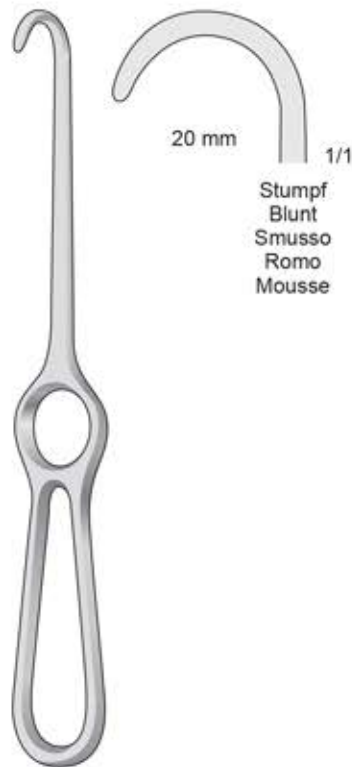

VOLKMANN
BT-127
220 mm

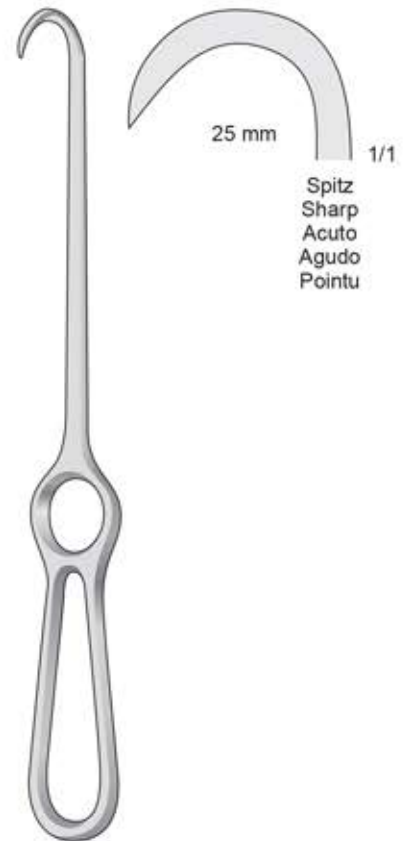

BT-128
245 mm



VOLKMANN
BT-101/BT-108
220 mm

Spitz
Sharp
Acuto
Agudo
Pointu



BT-101
9 x 8 mm



BT-103
9 x 13 mm



BT-105
9 x 19 mm



BT-107
9 x 29 mm

Stumpf
Blunt
Smusso
Romo
Mousse



BT-102
9 x 8 mm



BT-104
9 x 13 mm



BT-106
9 x 19 mm



BT-108
9 x 29 mm

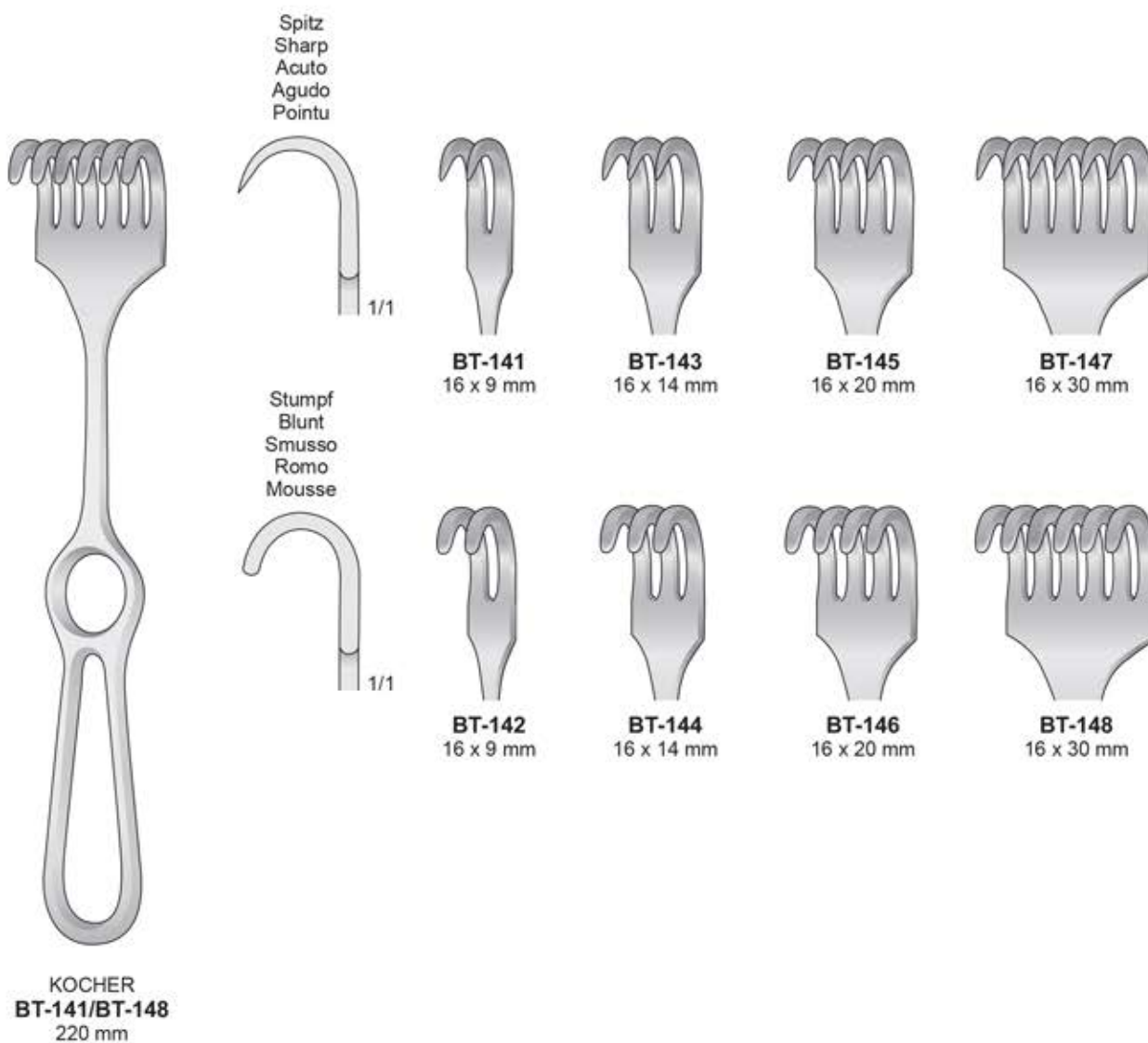

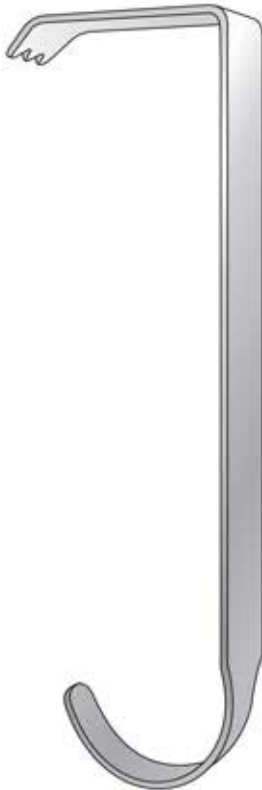

HIBBS
BT-23/BT-24
240 mm



BT-23 75 x 25 mm

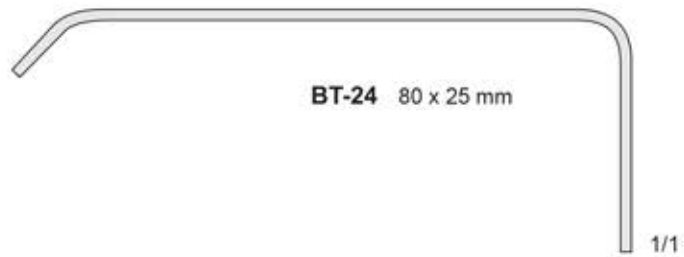

BT-24 80 x 25 mm



36 x 30 mm

OLLIER
BT-124
225 mm



1/1

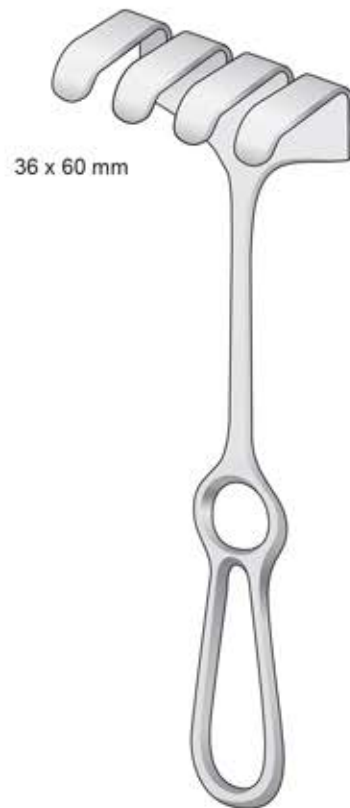

36 x 60 mm

OLLIER
BT-125
225 mm

40 x 40 mm

**BT-120**

45 x 50 mm

**BT-121**

50 x 60 mm

**BT-122**

70 x 70 mm

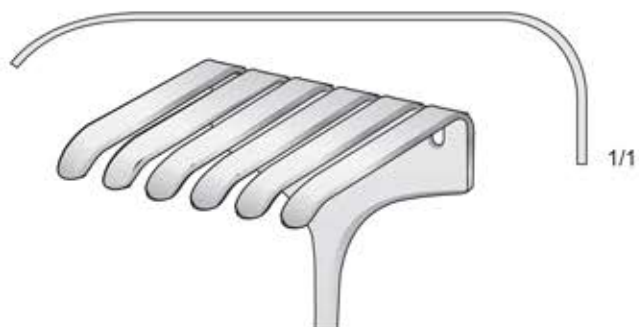
**BT-123****ISRAEL**
BT-120/BT-123
250 mm



WASSMUND
BT-69
220 mm



LANGENBECK
BT-33/BT-43
210 mm

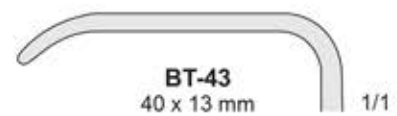
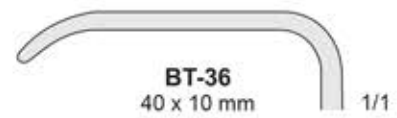

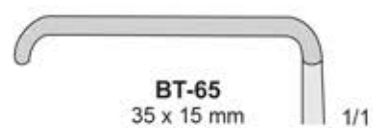
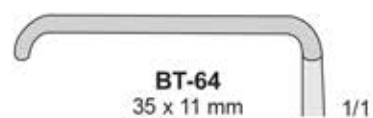
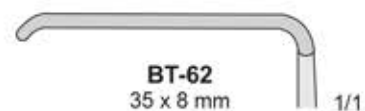

KOCHER-LANGENBECK
BT-60/BT-263
215 mm



SAUERBRUCH
BT-110/BT-112
225 mm



KOCHER
BT-250/BT-254
230 mm

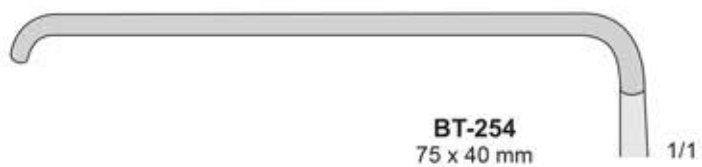
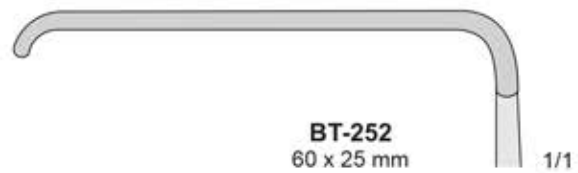
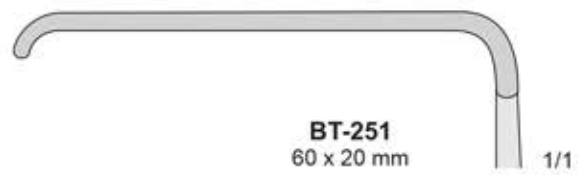
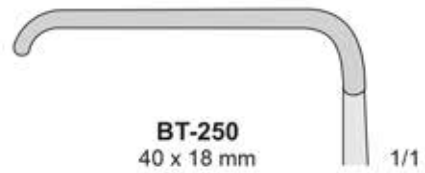



70 x 25 mm

1/1

KOCHER
BT-137
240 mm

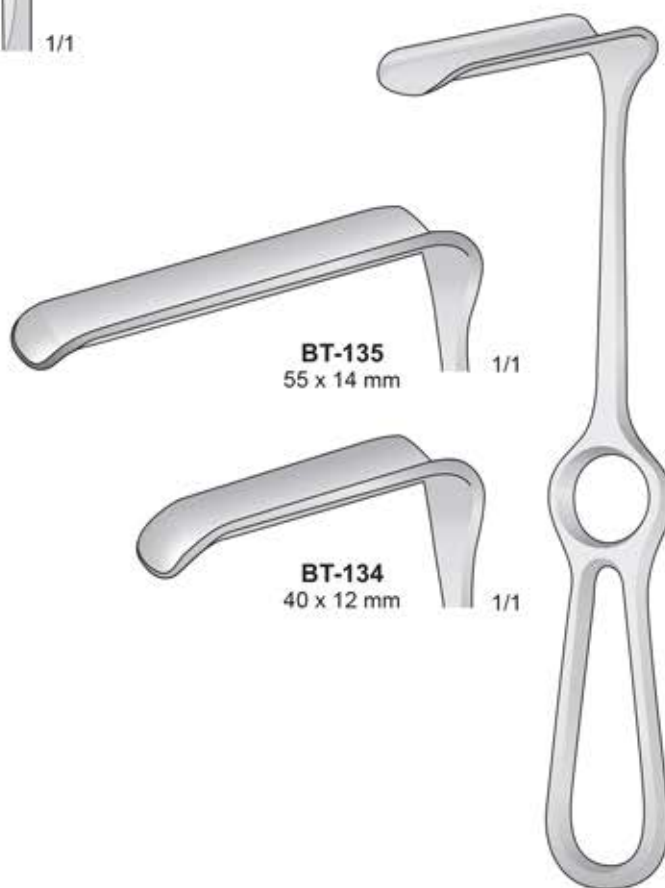

BT-135
55 x 14 mm

1/1

BT-134
40 x 12 mm

1/1

DOCKHORN
BT-134/BT-135
210 mm

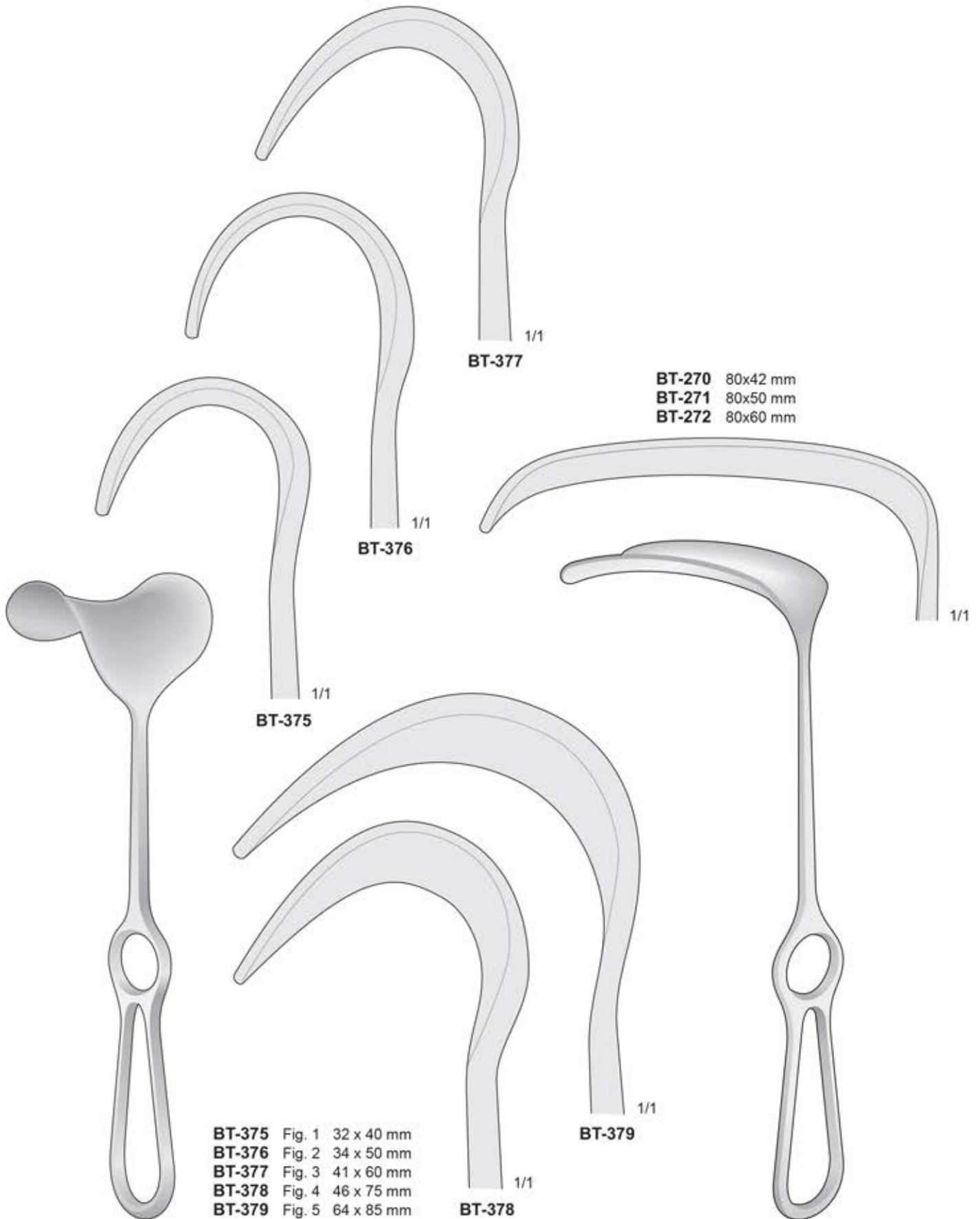

BT-270 80x42 mm
 BT-271 80x50 mm
 BT-272 80x60 mm

BT-375 Fig. 1 32 x 40 mm
 BT-376 Fig. 2 34 x 50 mm
 BT-377 Fig. 3 41 x 60 mm
 BT-378 Fig. 4 46 x 75 mm
 BT-379 Fig. 5 64 x 85 mm

FRITSCH
 BT-375/BT-379
 240 mm

KOCHER
 BT-270/BT-272
 250 mm

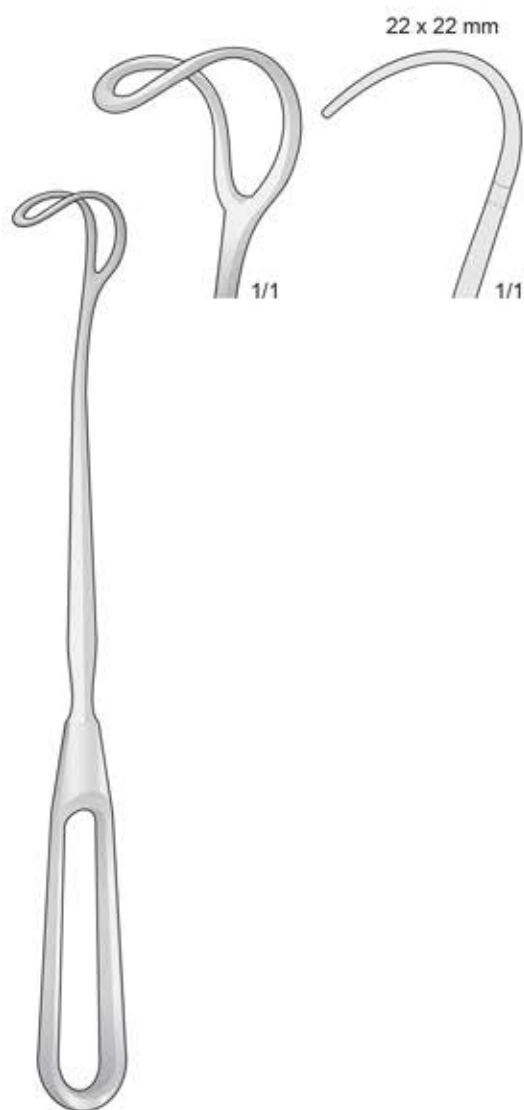

GREENE
BT-131
225 mm

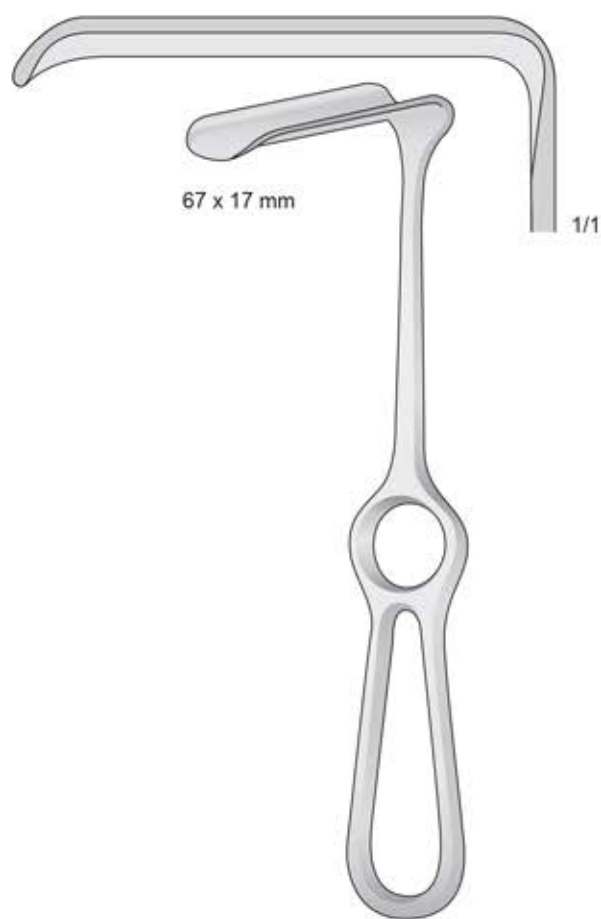

CASPAR
BT-136
210 mm



BT-80
225 mm



BT-180
255 mm



BT-81
225 mm



BT-181
255 mm



BT-82
225 mm



BT-182
255 mm

MIDDELDORPF
BT-80/BT-82
225 mm

MIDDELDORPF
BT-180/BT-182
255 mm

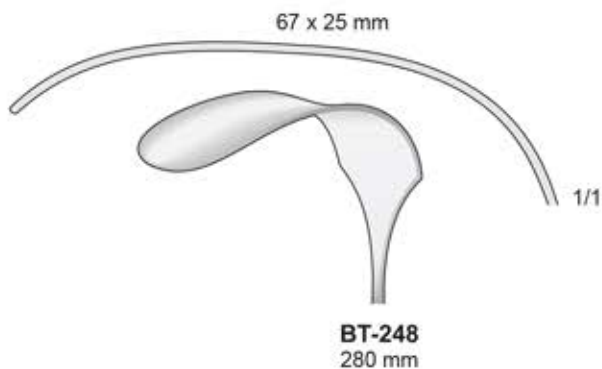
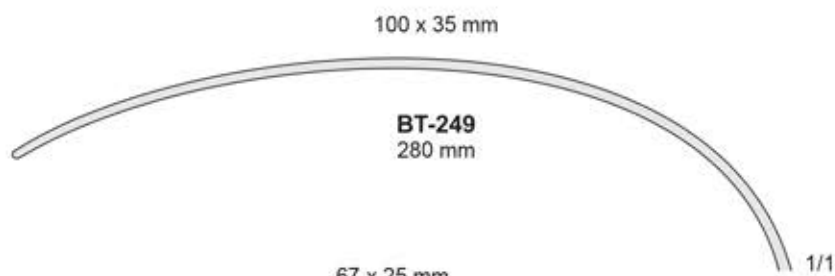

BT-270 80x42 mm
BT-271 80x50 mm
BT-272 80x60 mm

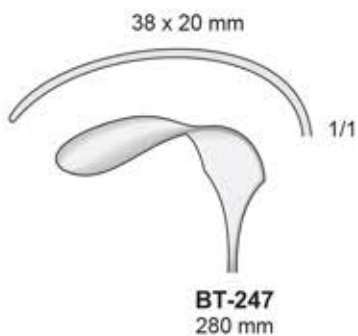

KOCHER
BT-246/BT-249
280 mm

KOCHER
BT-270/BT-272
250 mm

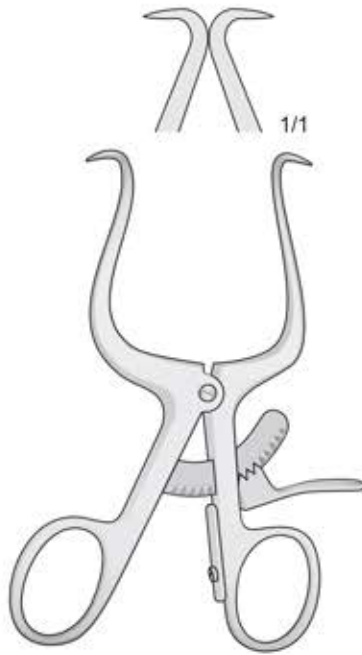

GELPI
BV-14
90 mm

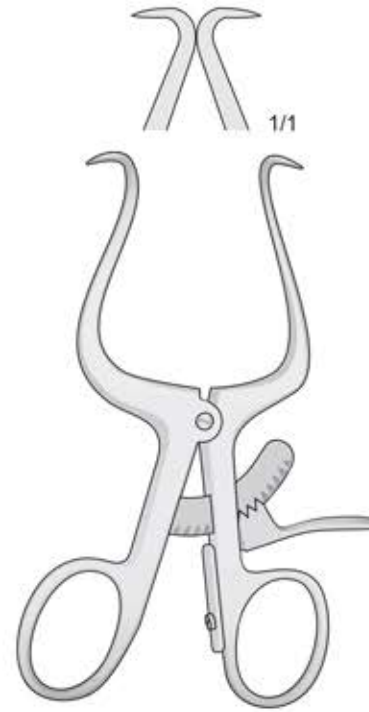

GELPI
BV-15
110 mm



GELPI
BV-16
140 mm



GELPI
BV-17
180 mm

Femur-Wundspreizer für kinder
Femur Retractor for children
Divaricatore femorale per bambini

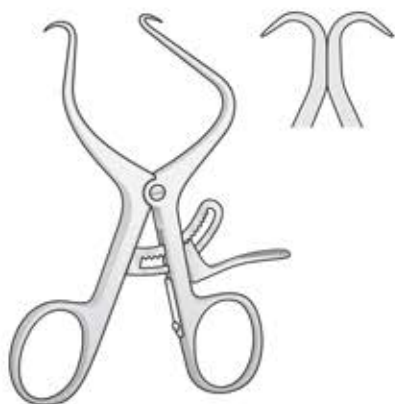

DE BAKEY
BV-315
100 mm

Femur-Wundspreizer
Femur Retractor
Divaricatore femorale

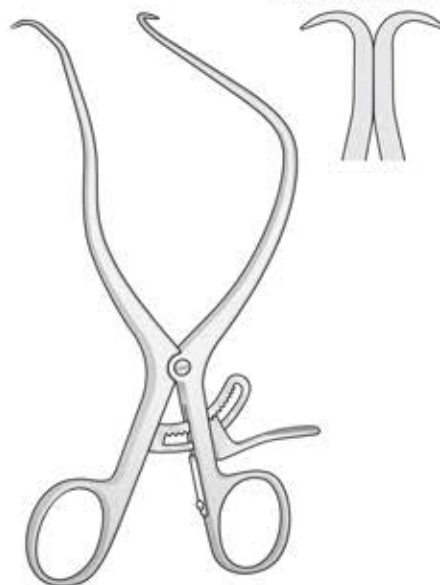

DE BAKEY
BV-316
170 mm

Wundspreizer
Retractors for shoulder
Divaricatori da spalla
Separadores
Écarteurs

Stumpf - Blunt
Smusso - Romo
Mousse



BV-100
215 mm

Stumpf - Blunt
Smusso - Romo
Mousse



KÖLBEL
BV-103
180 mm

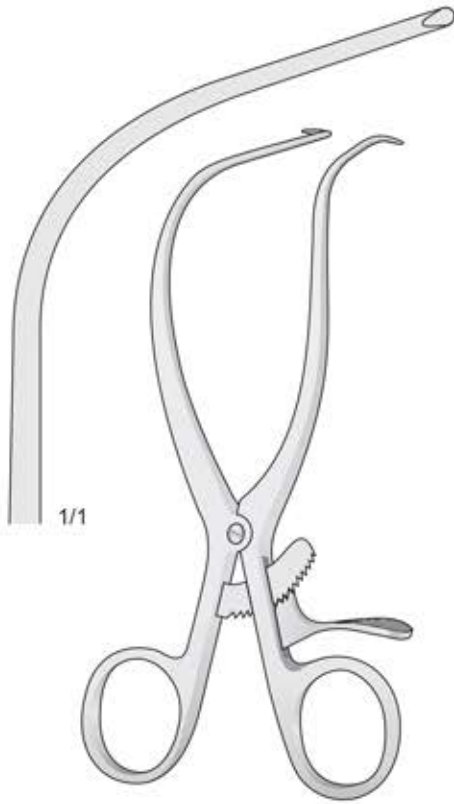

GELPI-SELETZ
BV-11
165 mm

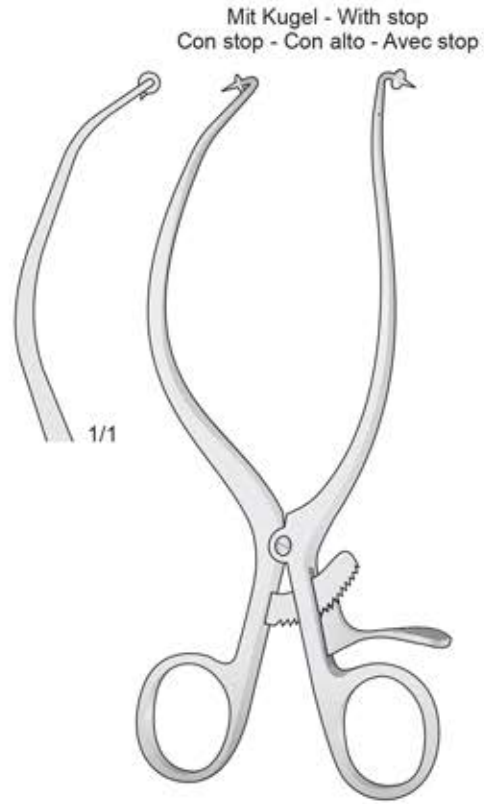

GELPI-LOKTITE
BV-13
190 mm

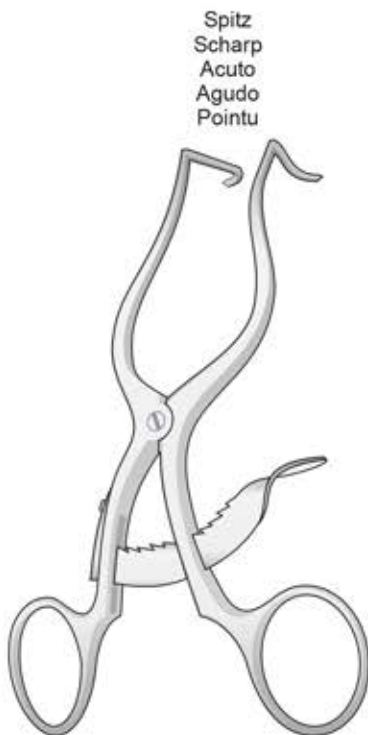

CLOWARD-CONTOUR
BV-108
140 mm

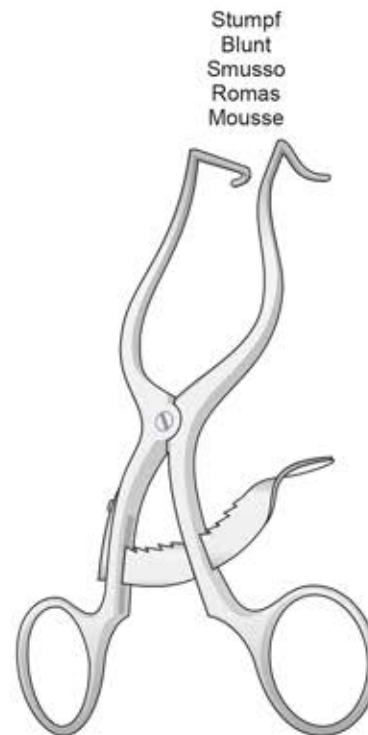

CLOWARD-CONTOUR
BV-109
140 mm

Spitz
Scharp
Acuto
Agudo
Pointu

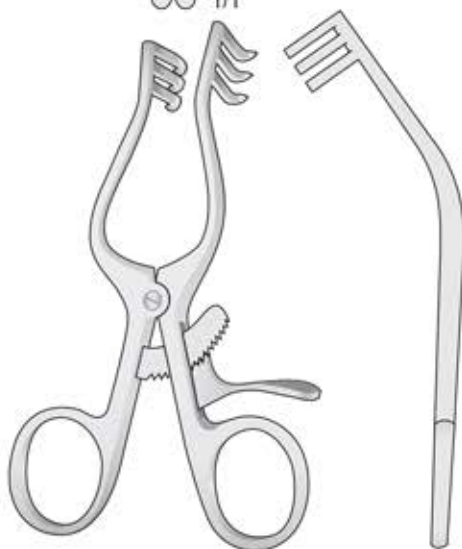

WULLSTEIN
BV-111
105 mm

Stumpf
Blunt
Smusso
Romas
Mousse

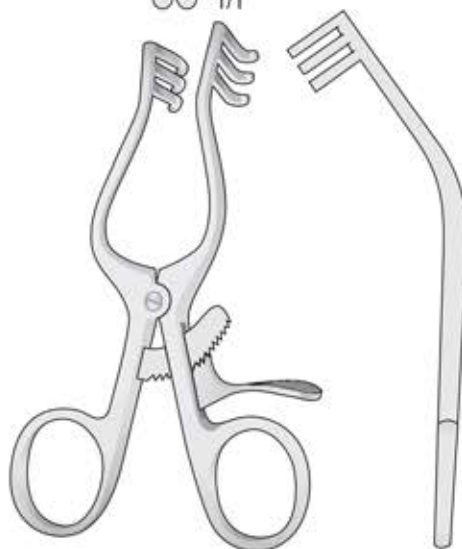

WULLSTEIN
BV-112
105 mm

Spitz
Scharp
Acuto
Agudo
Pointu



WEITLANER
BV-07
110 mm

Stumpf
Blunt
Smusso
Romas
Mousse

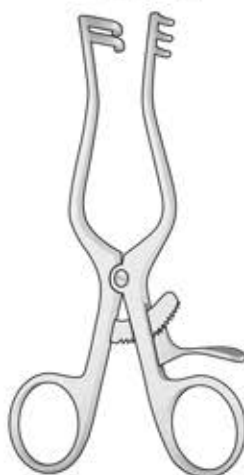

WEITLANER
BV-09
110 mm

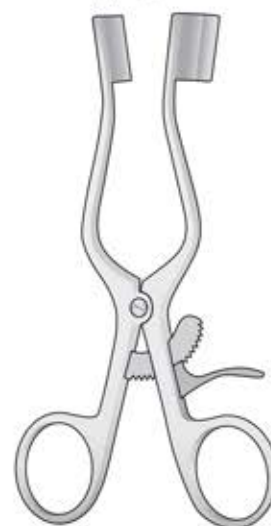
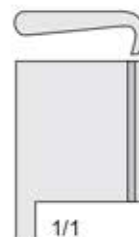

BABY-WEITLANER
BV-26
140 mm

Halbscharf - Semi Sharp - Semi acuto
Semi Agudas - Semi Pointu

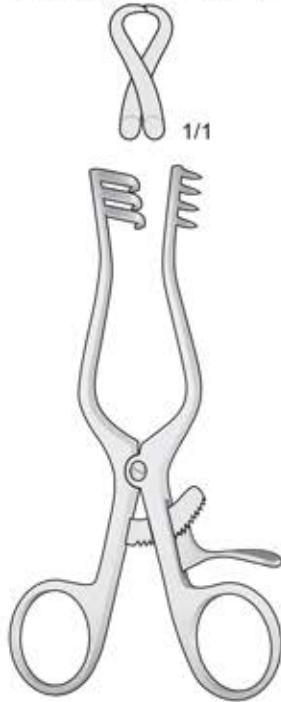

WEITLANER
BV-18
135 mm

Spitz - Sharp - Acuto
Agudas - Pointu

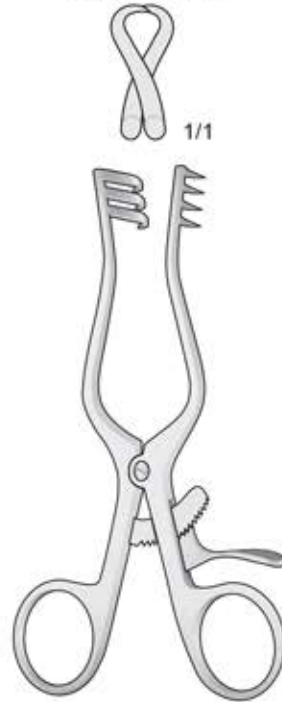

WEITLANER
BV-20
135 mm

Stumpf - Blunt - Smusso
Romas - Mousse

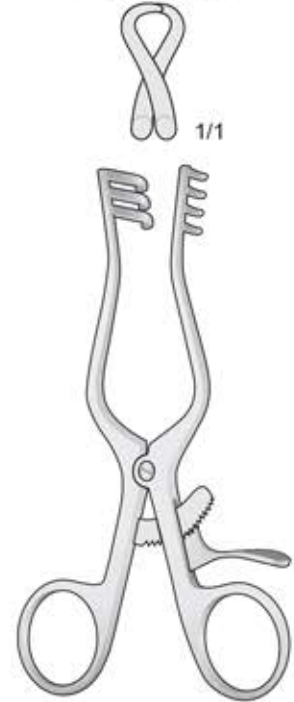

WEITLANER
BV-22
135 mm

Spitz - Sharp - Acuto
Agudas - Pointu



WEITLANER
BV-55
135 mm

Stumpf - Blunt - Smusso
Romas - Mousse



WEITLANER
BV-56
135 mm

Halbscharf - Semi Sharp - Semi acuto
Semi Agudas - Semi Pointu

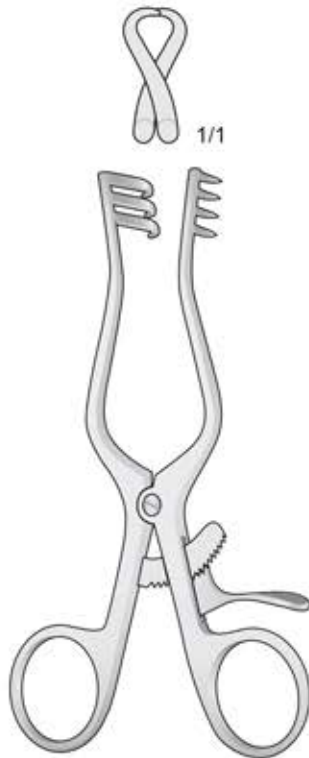

WEITLANER
BV-19
165 mm

Spitz - Sharp - Acuto
Agudas - Pointu

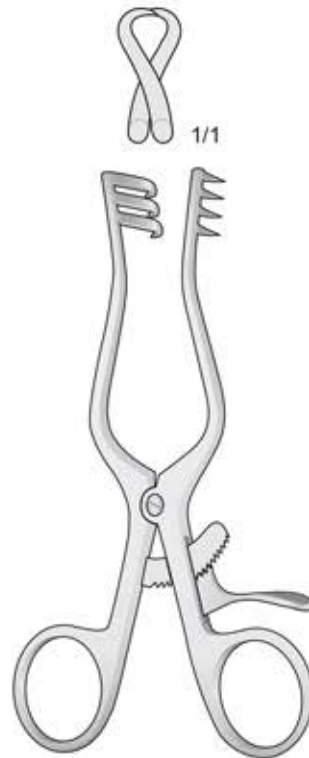

WEITLANER
BV-21
165 mm

Stumpf - Blunt - Smusso
Romas - Mousse

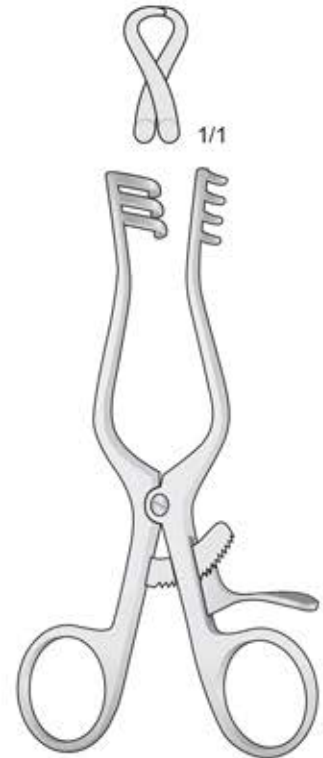

WEITLANER
BV-23
165 mm

Spitz - Sharp - Acuto
Agudas - Pointu

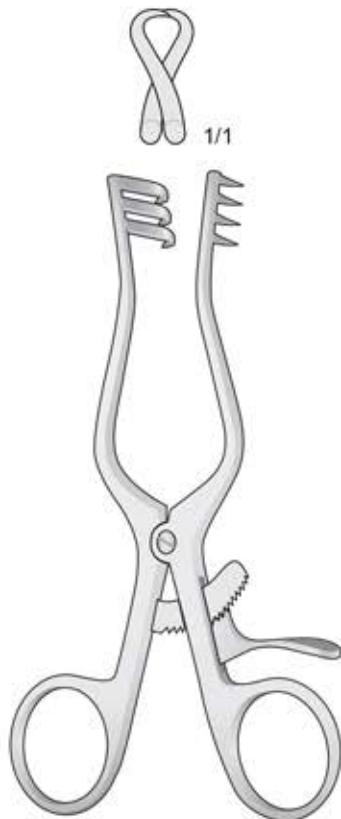

WEITLANER
BV-24
200 mm

Stumpf - Blunt - Smusso
Romas - Mousse

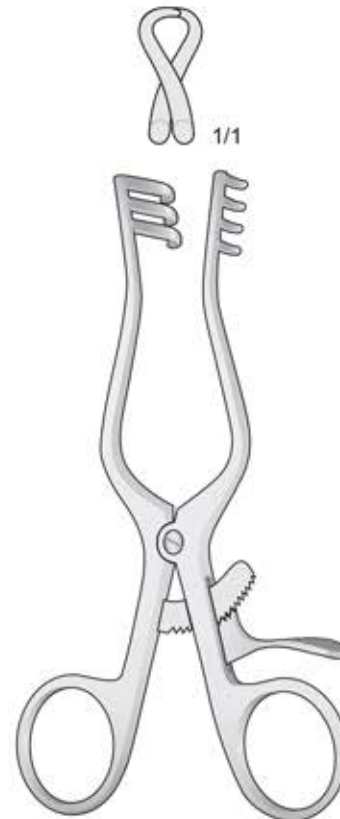

WEITLANER
BV-25
200 mm

Spitz - Sharp - Acuto
Agudas - Pointu

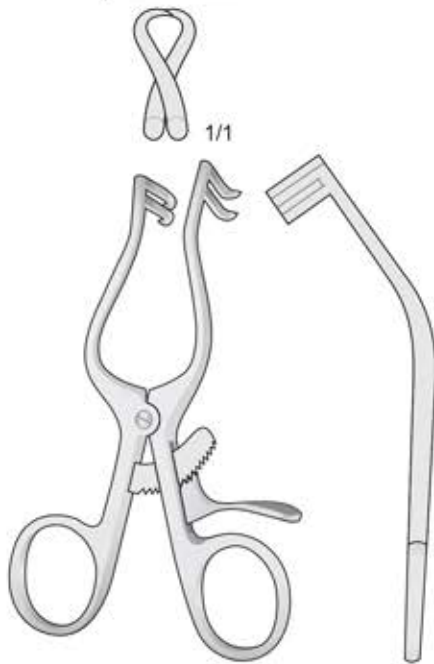

PLESTER
BV-90
110 mm

Stumpf - Blunt - Smusso
Romas - Mousse

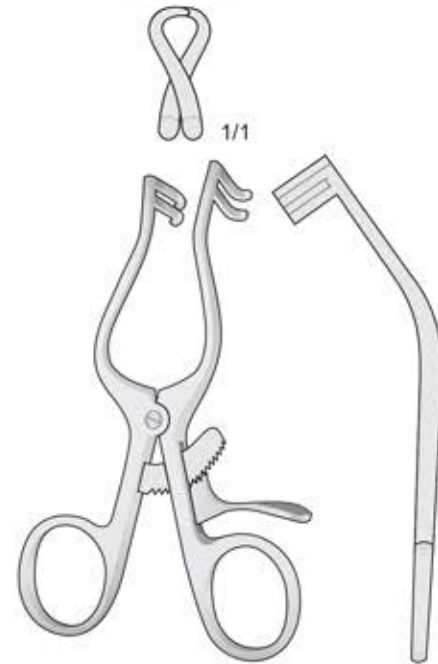

PLESTER
BV-91
110 mm

Spitz - Sharp - Acuto
Agudas - Pointu

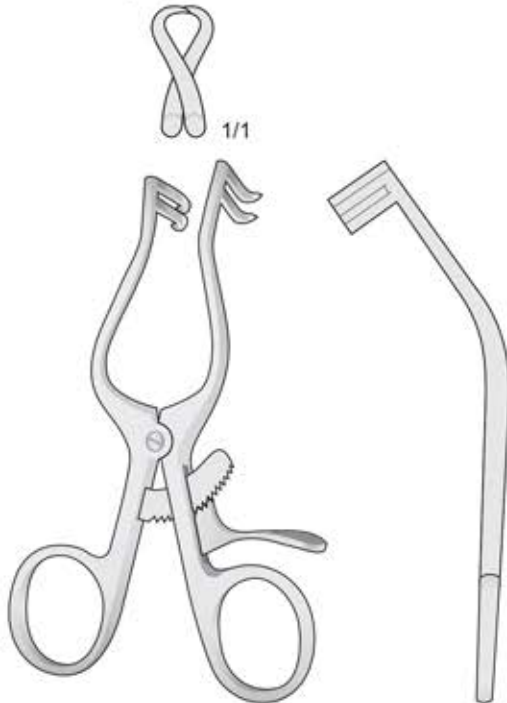

PLESTER
BV-92
135 mm

Stumpf - Blunt - Smusso
Romas - Mousse

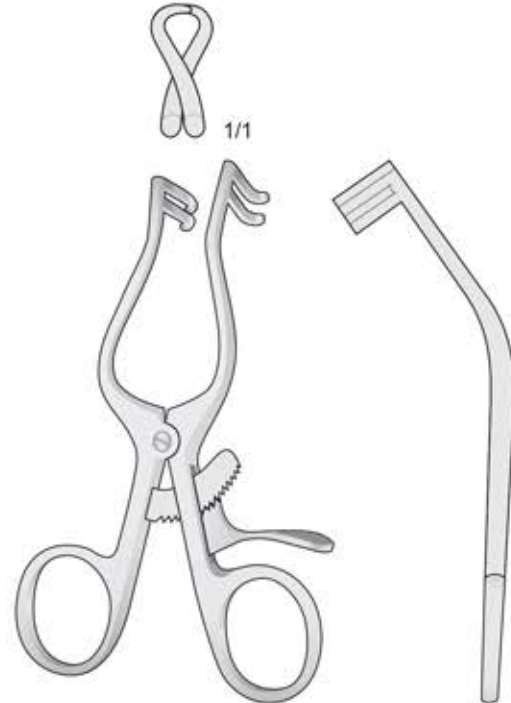

PLESTER
BV-93
135 mm

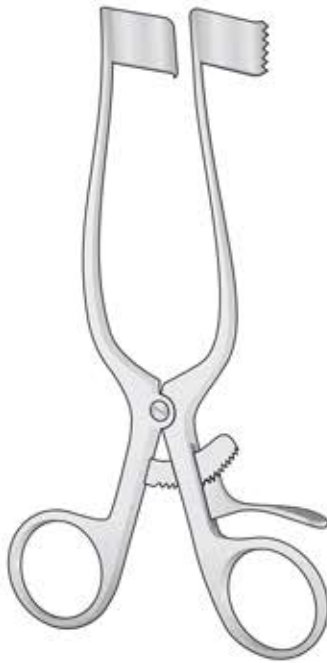

MEYERDING
BV-76 - 32 x 25 mm
BV-77 - 60 x 25 mm
BV-78 - 54 x 25 mm
BV-79 - 60 x 20 mm
 180 mm

Spitz - Sharp - Acuto
 Agudas - Pointu

Stumpf - Blunt - Smusso
 Romas - Mousse

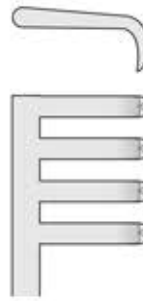

BV-117



BV-118

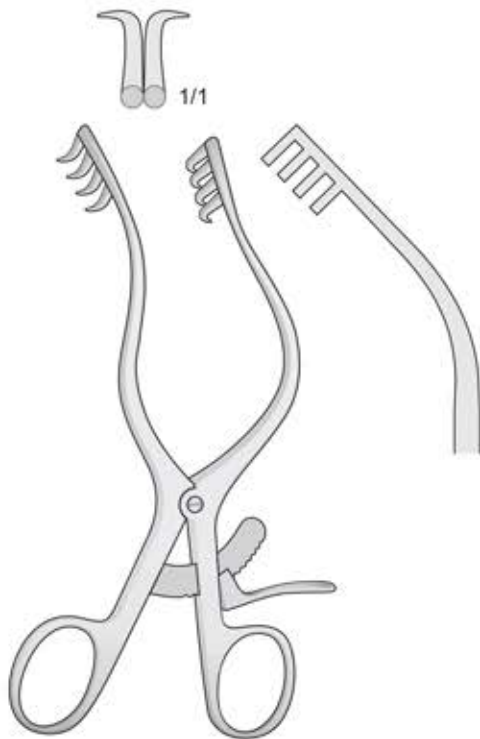

MOLLISON
BV-110
 160 mm

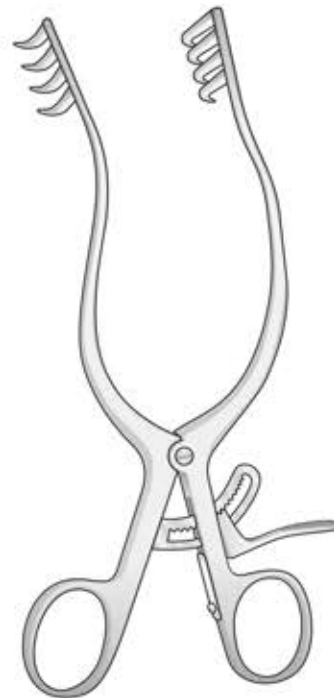

ANDERSON-ADSON
BV-117/BV-118
 200 mm

Spitz - Sharp - Acuto
Agudas - Pointu

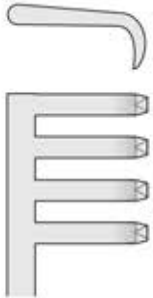

BV-119

Stumpf - Blunt - Smusso
Romas - Mousse



BV-120

4 x 4 Zähne
4 x 4 Teeth
4 x 4 Denti
4 x 4 Dientes
4 x 4 Dents



ADSON
BV-119/BV-120
200 mm

Spitz - Sharp - Acuto
Agudas - Pointu

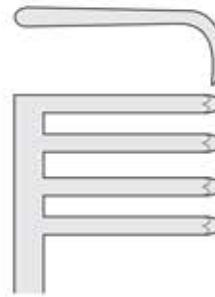

BV-27

Stumpf - Blunt - Smusso
Romas - Mousse

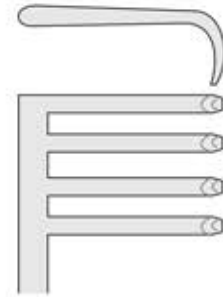

BV-28

4 x 4 Zähne
4 x 4 Teeth
4 x 4 Denti
4 x 4 Dientes
4 x 4 Dents

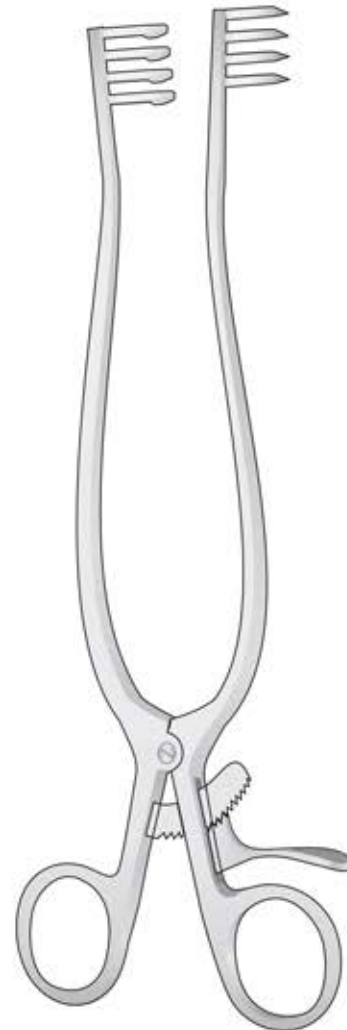

WEITLANER
BV-27/BV-28
250 mm



ADSON
BV-190/BV-193
265 mm

3 x 4 Zähne
3 x 4 Teeth
3 x 4 Denti
3 x 4 Dientes
3 x 4 Dents

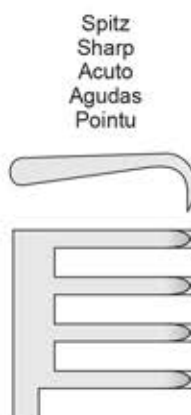

BV-190

Spitz
Sharp
Acuto
Agudas
Pointu

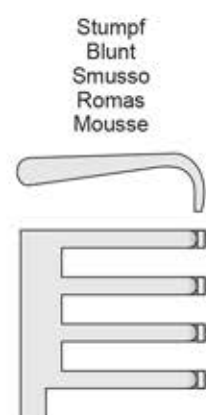

BV-191

Stumpf
Blunt
Smusso
Romas
Mousse

6 x 6 Zähne
6 x 6 Teeth
6 x 6 Denti
6 x 6 Dientes
6 x 6 Dents

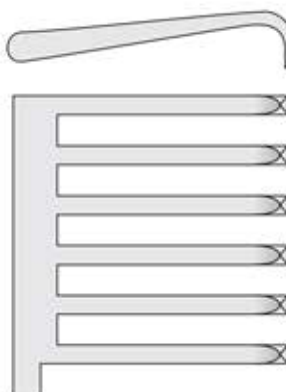

BV-192

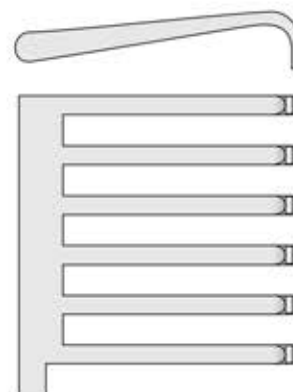

BV-193

Spitz
Scharp
Acuto
Agudo
Pointu



BV-68
140 mm

Stumpf
Blunt
Smusso
Romas
Mousse



BV-70
140 mm

3 x 4 Zähne
3 x 4 Teeth
3 x 4 Denti
3 x 4 Dientes
3 x 4 Dents

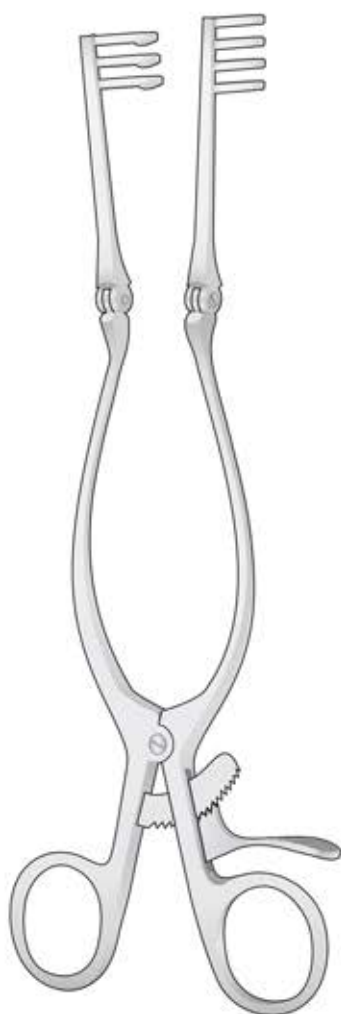

ADSON
BV-68/BV-75

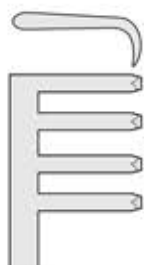

BV-69
165 mm

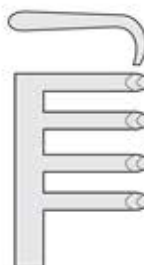

BV-71
165 mm

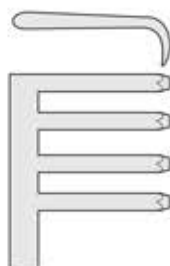

BV-72
200 mm

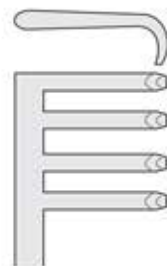

BV-73
200 mm



BV-74
250 mm

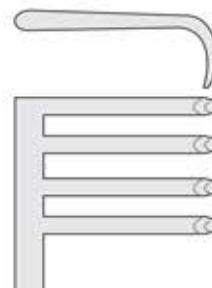

BV-75
250 mm

Elevators

Elevatorien
Élévateurs
Elevadores
Elevatori

Periosteal (Raspatories)

Raspatorien
Rugines périostiques
Periostótomos (Legras)
Scollaperiosteo (Periostotomi)

Bone files

Knochenfeilen
Limes à os
Limas para hueso
Lime per osso

Sharp Curettes

Scharfe Küretten
Curettes tranchantes
Curetas cortantes
Curette taglienti

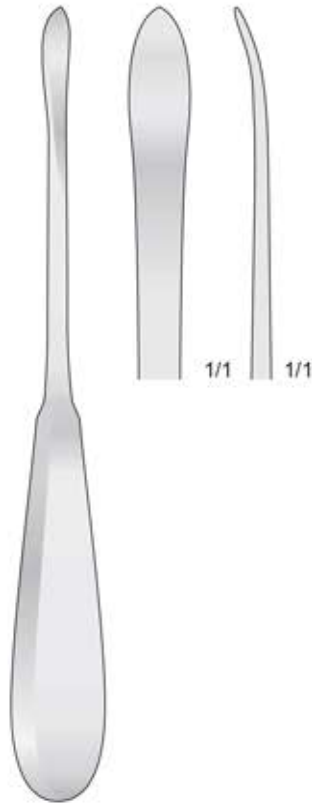

**LANGENBECK
FK-12**
200 mm

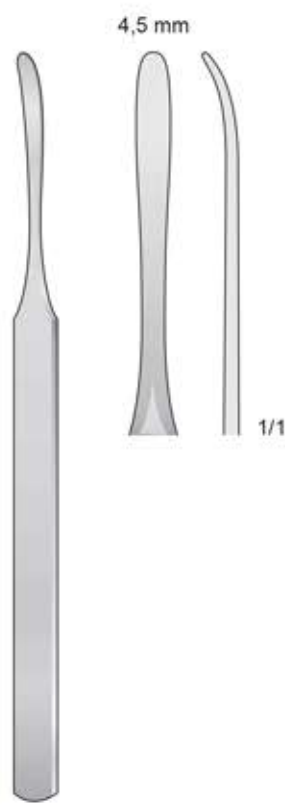

**KÖNIG
KO-1**
155 mm

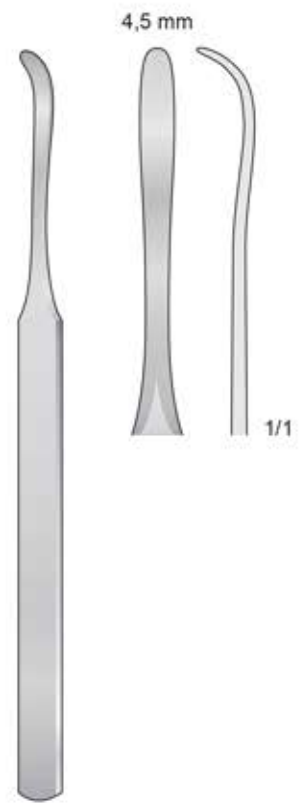

**KÖNIG
KO-2**
155 mm

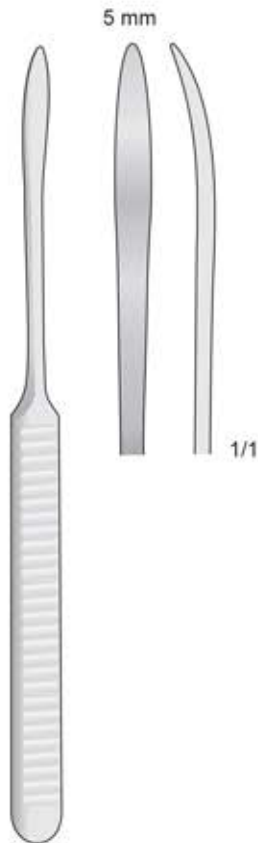

**WILLIGER
WG-10**
165 mm

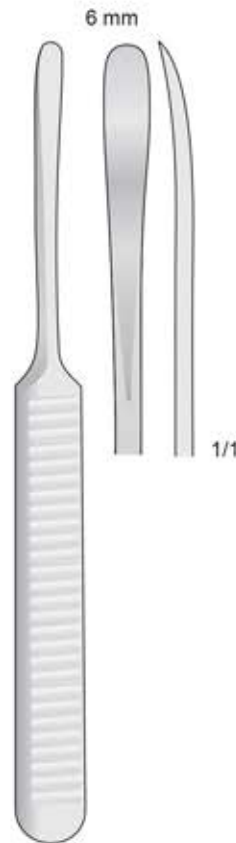

**WILLIGER
WG-12**
160 mm

Raspatorii
Periosteal Raspatories
Periostotomi
Legras periostotomos
Rugines à périostomie

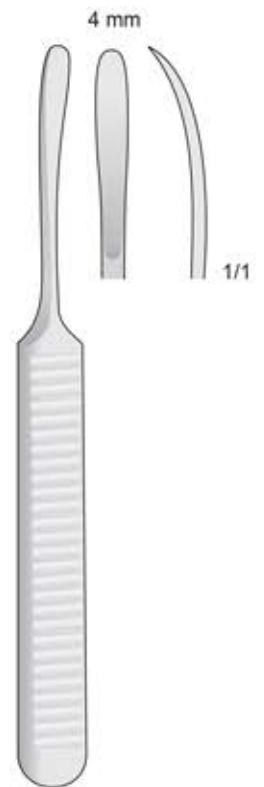

**WILLIGER
WG-14**
140 mm

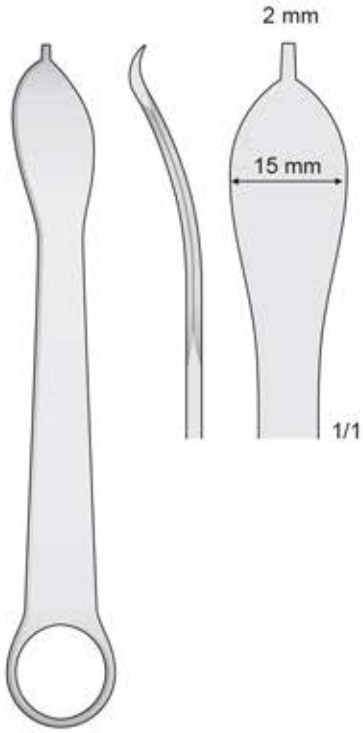

FK-45
120 mm

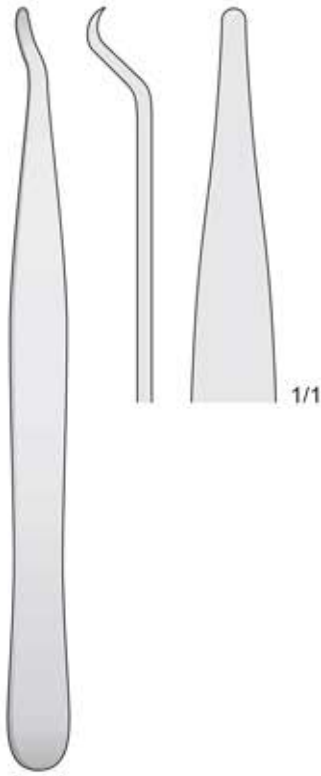

FK-46
140 mm

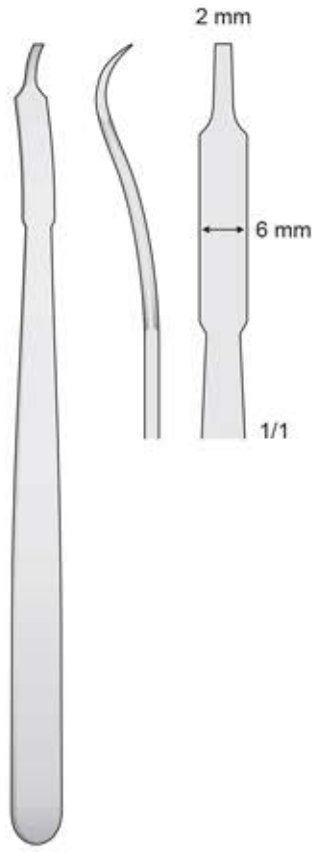

MINI-HOHMANN
FK-48
160 mm

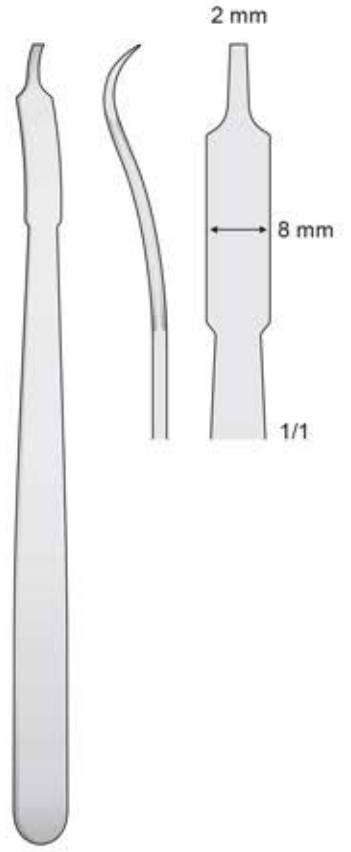

MINI-HOHMANN
FK-49
160 mm

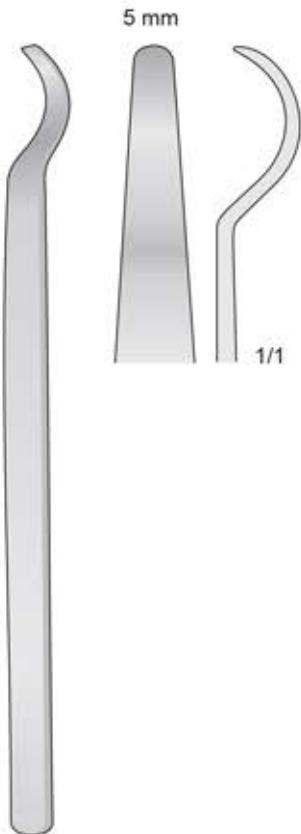

FK-30
150 mm

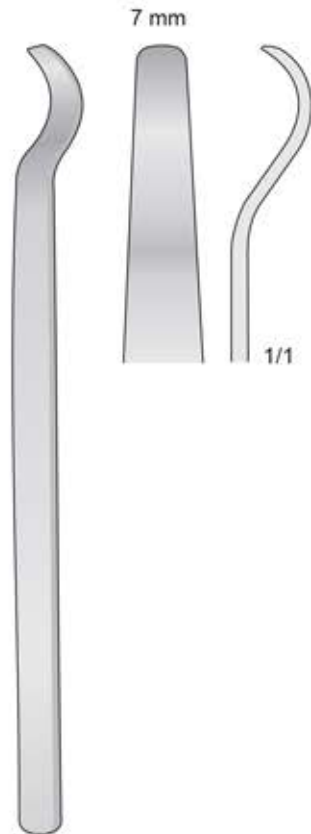

FK-28
150 mm

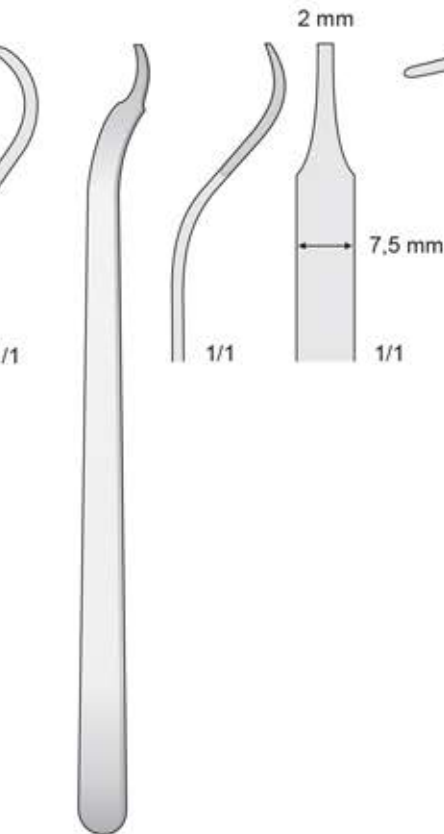

BUCK-GRAMCKO
FK-20
150 mm

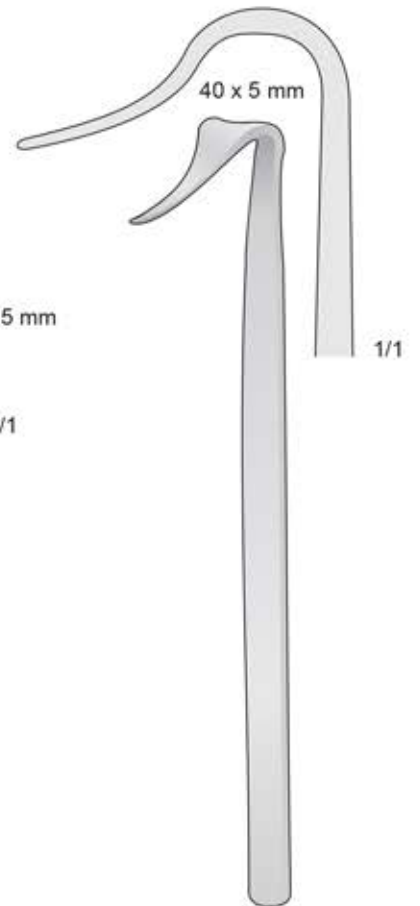

BLOUNT
FK-27
175 mm

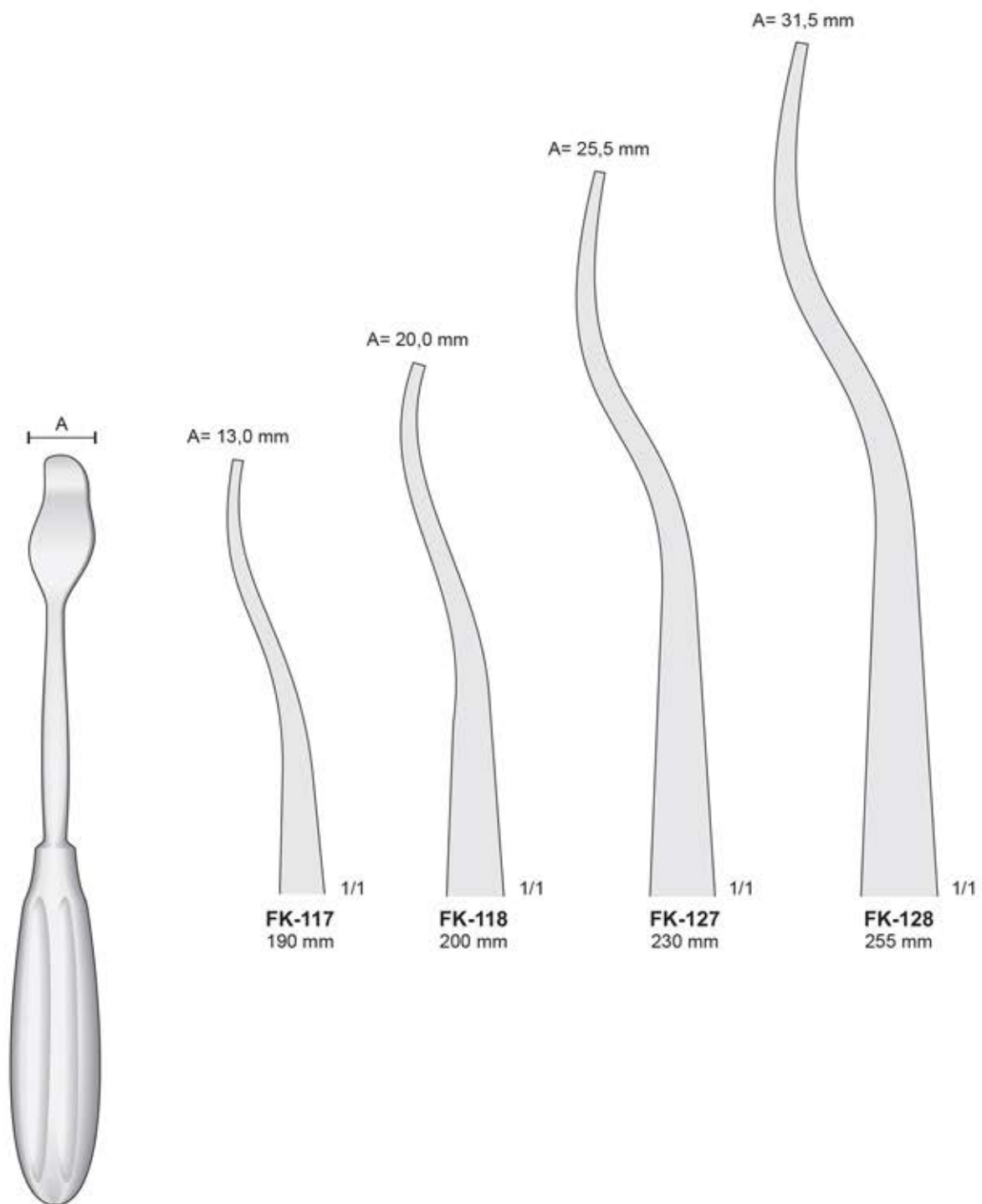

CHANDLER
FK-117/FK-128

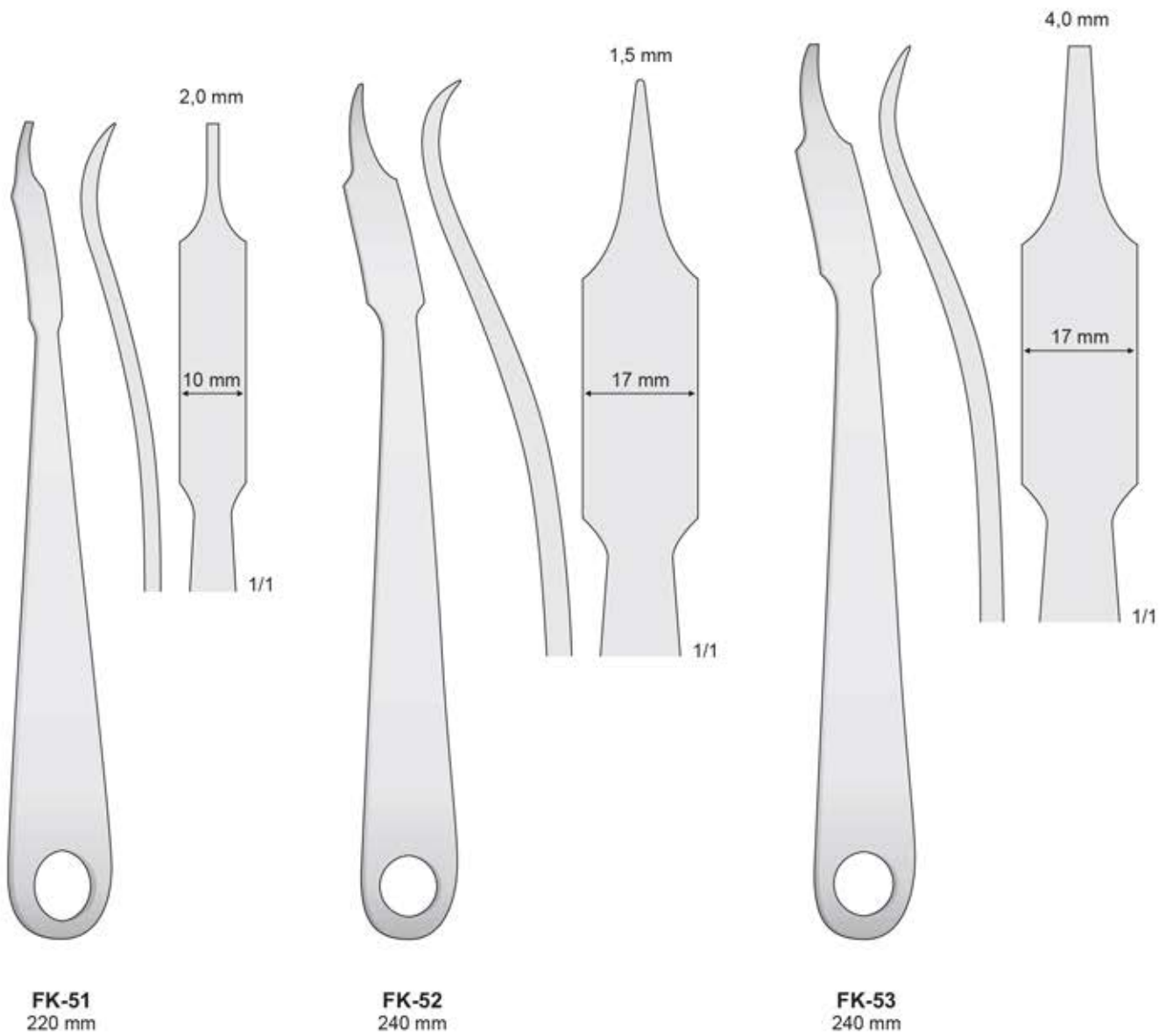



HOHMANN
FK-54/FK-55



7,0 mm

22 mm

FK-54
260 mm

1/1



13,0 mm

34 mm

FK-55
285 mm

1/1

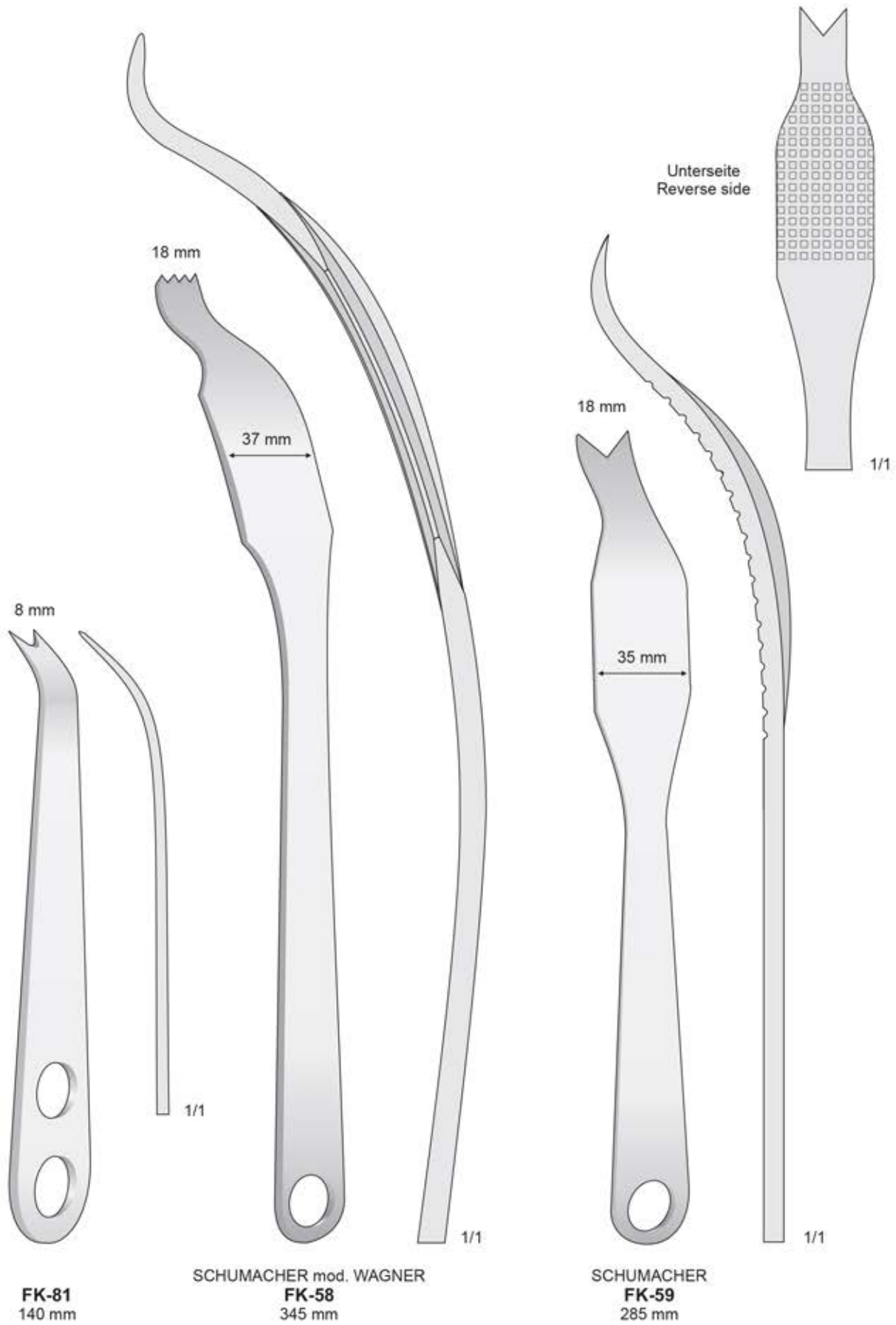

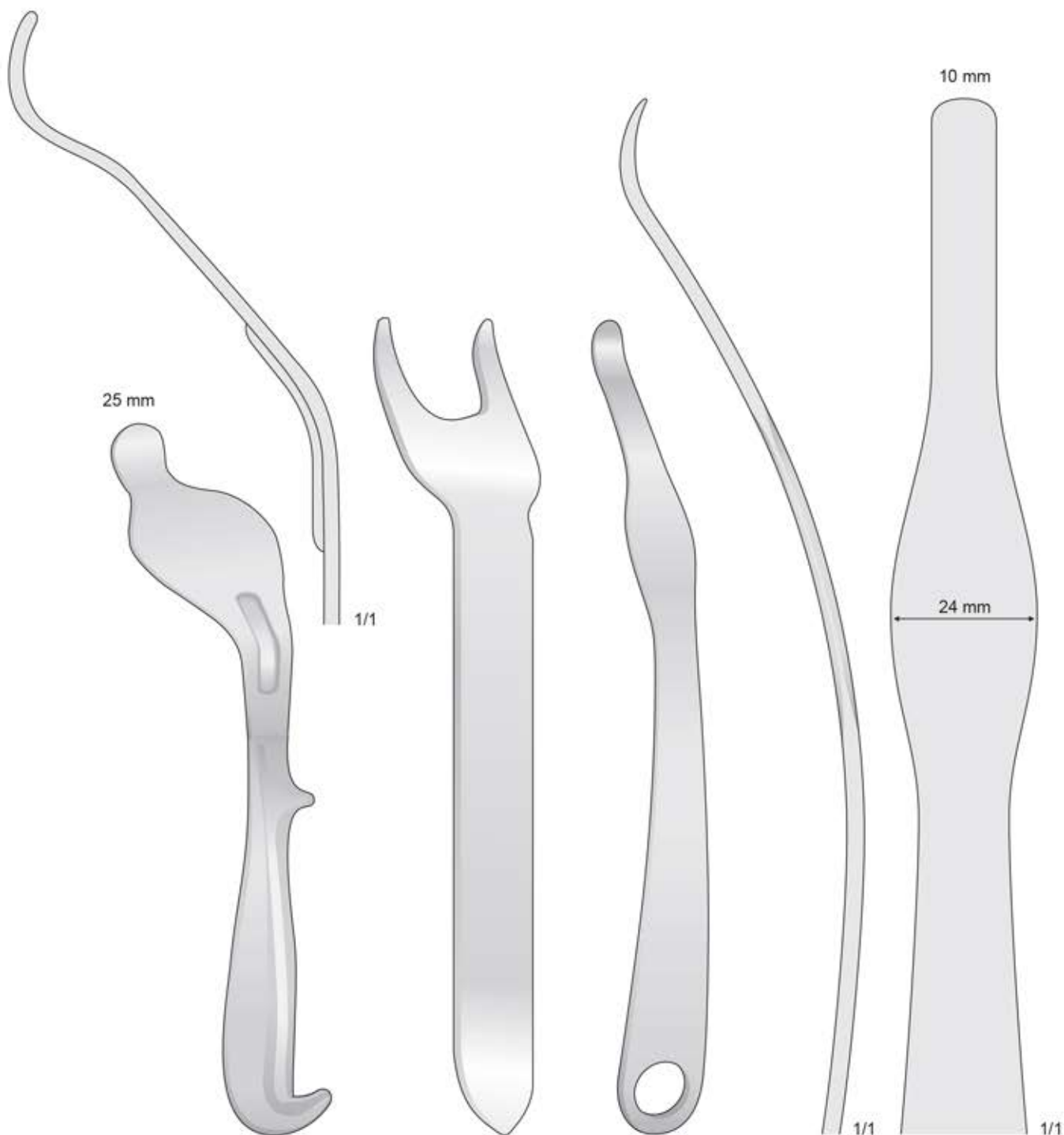

BENNETT
FK-176 43 mm
FK-179 60 mm
 240 mm

BLOUNT
FK-93
 260 mm

FK-56
 260 mm

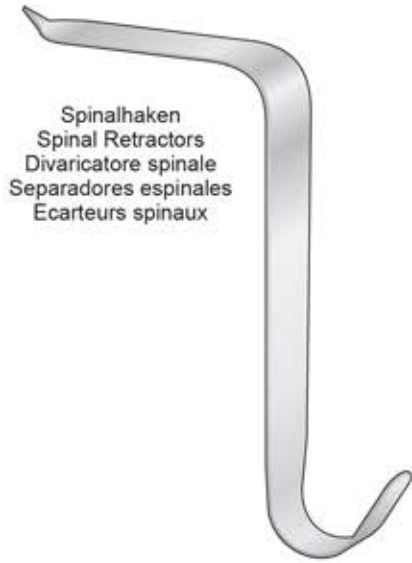

Spinalhaken
Spinal Retractors
Divaricatore spinale
Separadores espinales
Ecarteurs spinaux

TAYLOR
FK-168 75 x 30 mm
FK-169 100 x 30 mm
165 mm

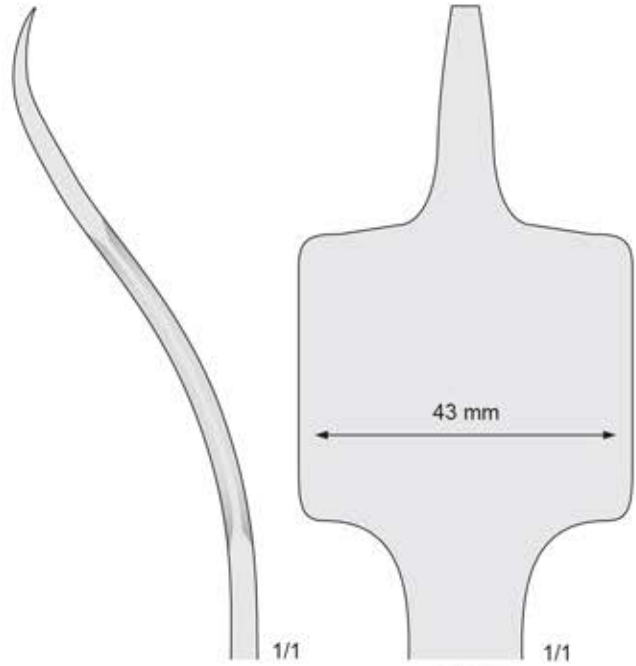

FK-57
240 mm

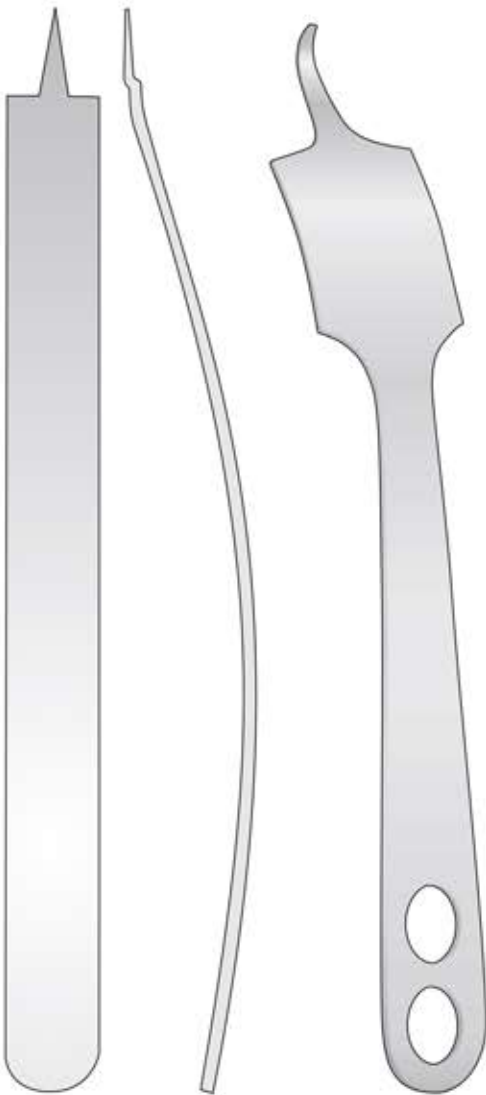

FK-164
250 mm

HOHMANN
FK-47/FK-57
240 mm

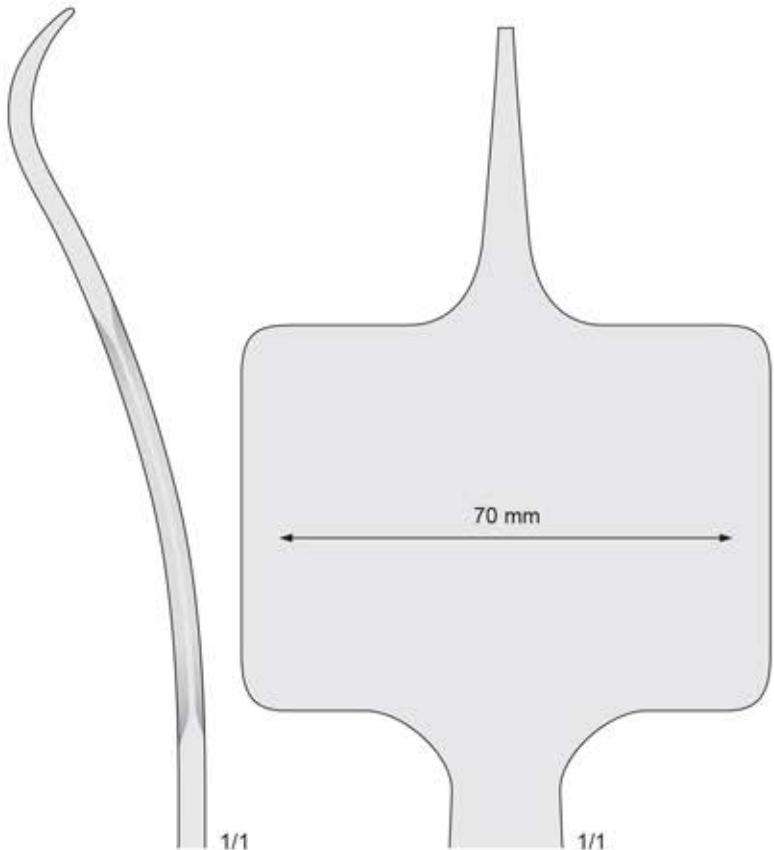

FK-47
240 mm

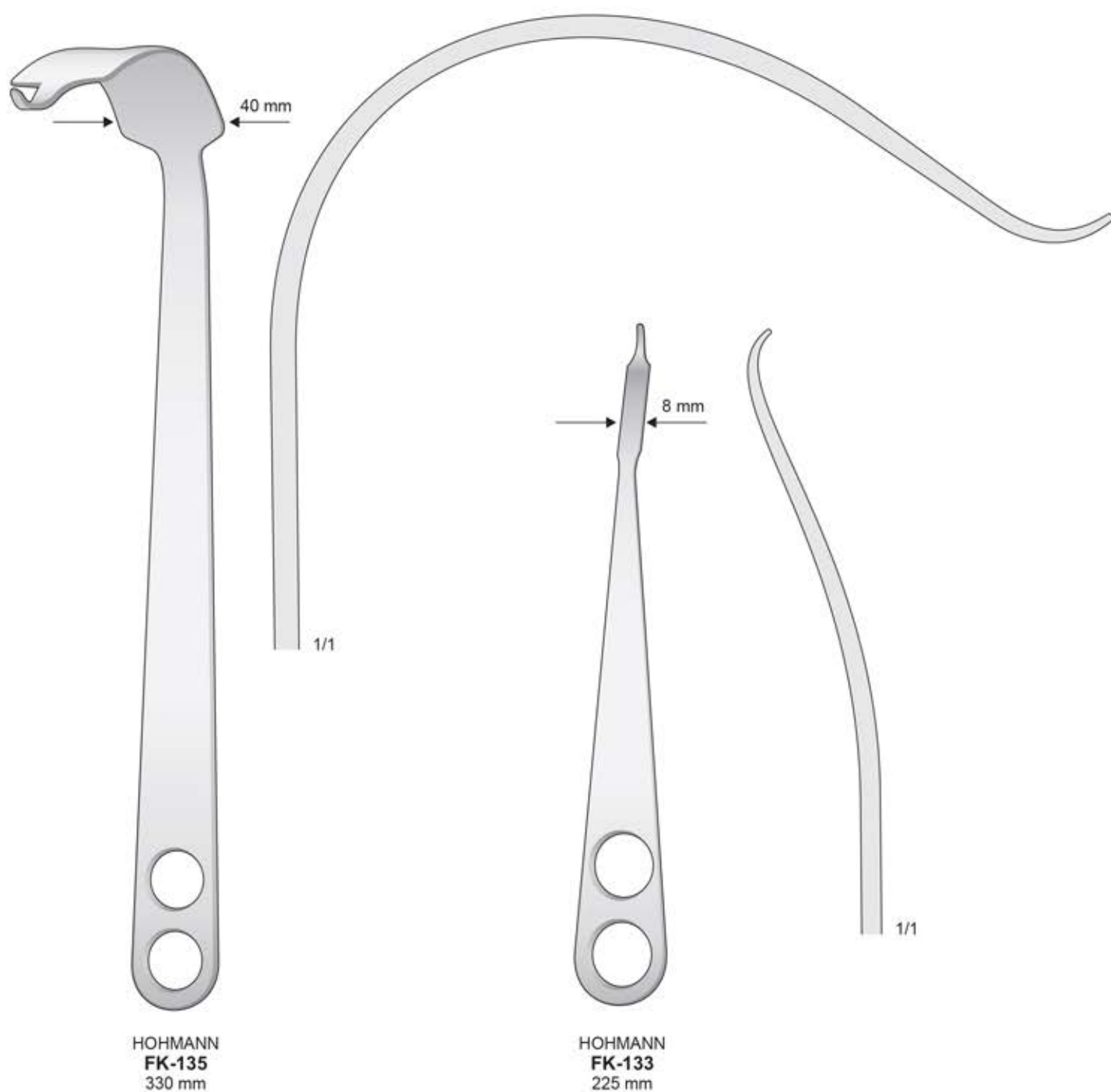

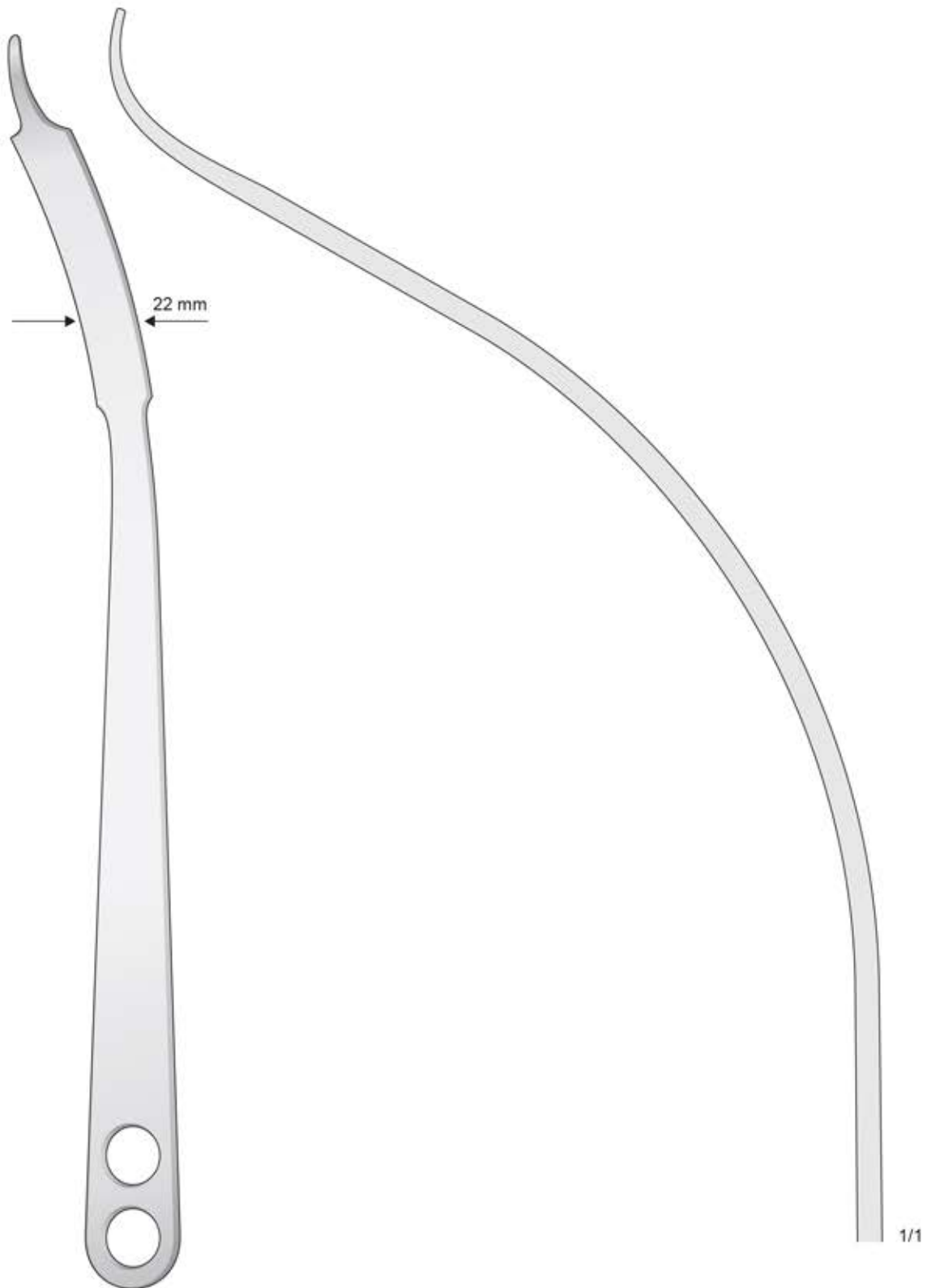

HOHMANN
FK-134
400 mm

1/1

15 mm



CUSHING
FK-252
190 mm

8 mm



FK-260

7 mm



FK-261

7 mm



FK-262

7 mm



FK-263



ADSON
FK-260/FK-263
170 mm

2,5 mm

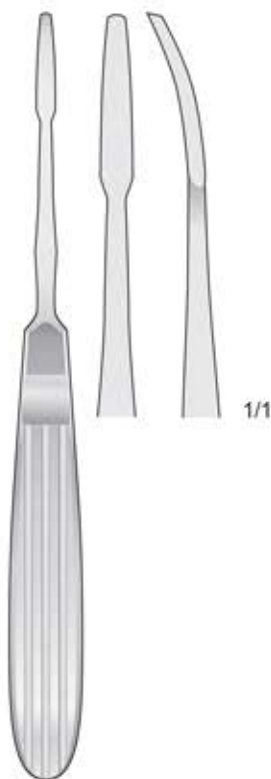

JOSEPH
FK-80
170 mm

4 mm



FOMON
FK-264
170 mm

4 mm



JOSEPH
FK-265
160 mm

7 mm



JOSEPH
FK-82
180 mm

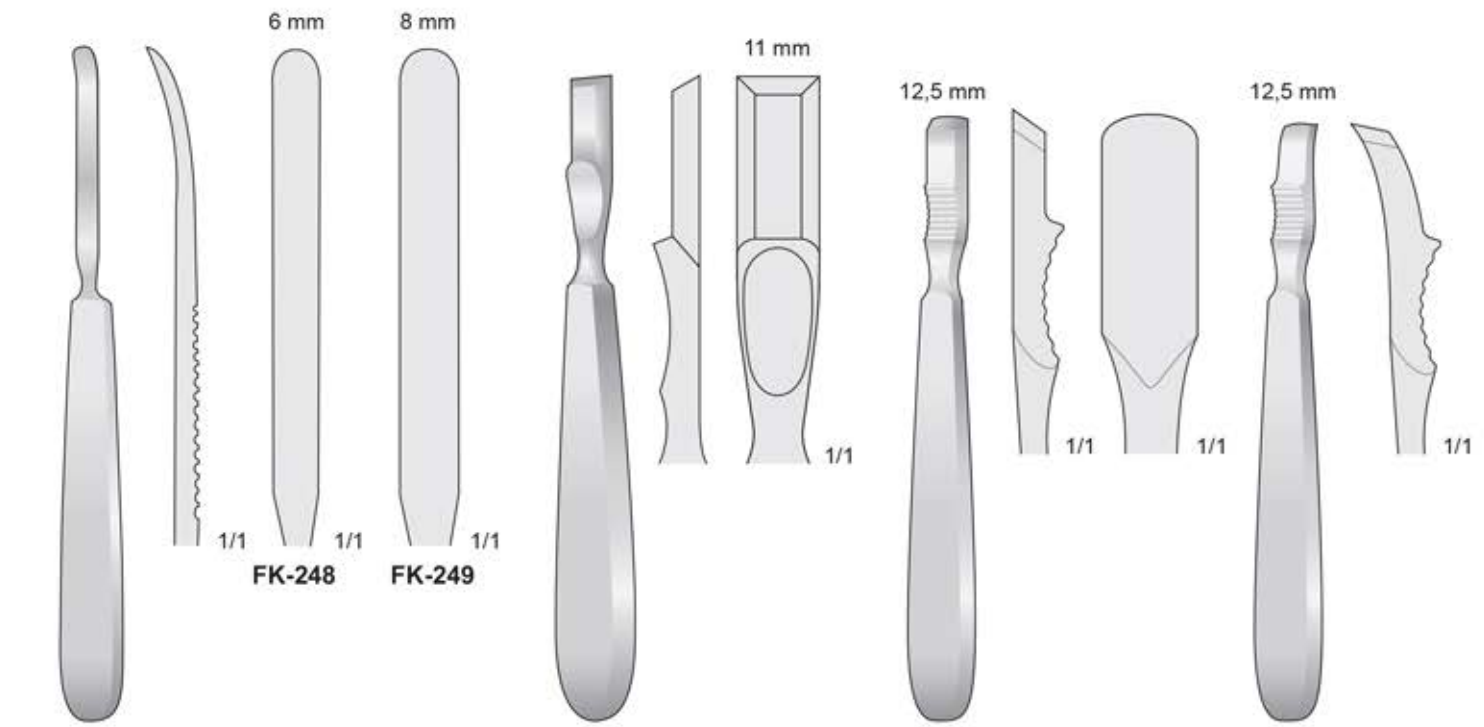

FK-248/FK-249
170 mm

**FARABEUF-COLLIN
FK-247**
160 mm

**FARABEUF
FK-250**
150 mm

**FARABEUF
FK-251**
150 mm

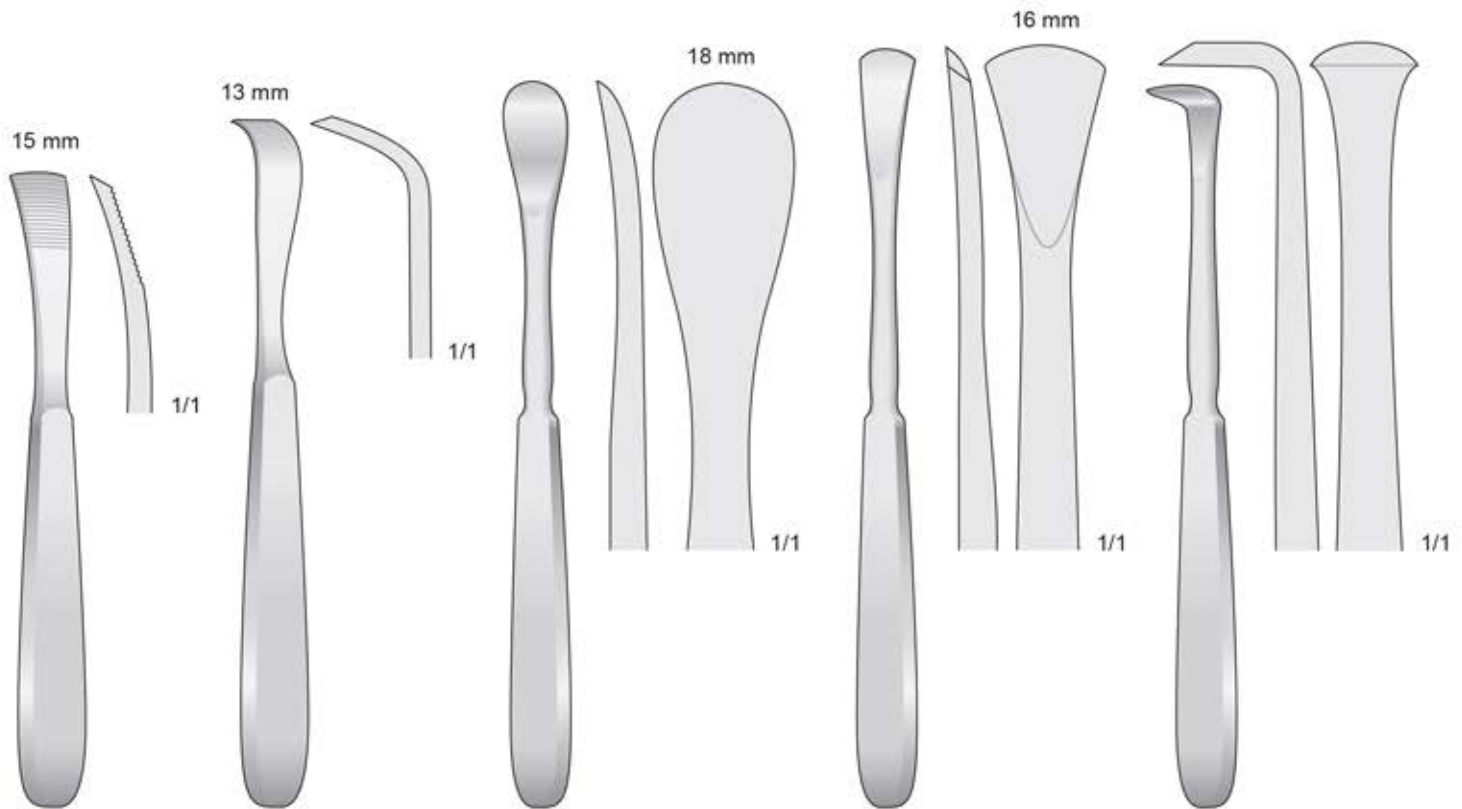

**JANSEN
FK-255**
165 mm

**SCHNEIDER
FK-258**
175 mm

**SEDILLOT
FK-254**
185 mm

**LANGENBECK
FK-256**
190 mm

**LANGENBECK
FK-257**
180 mm

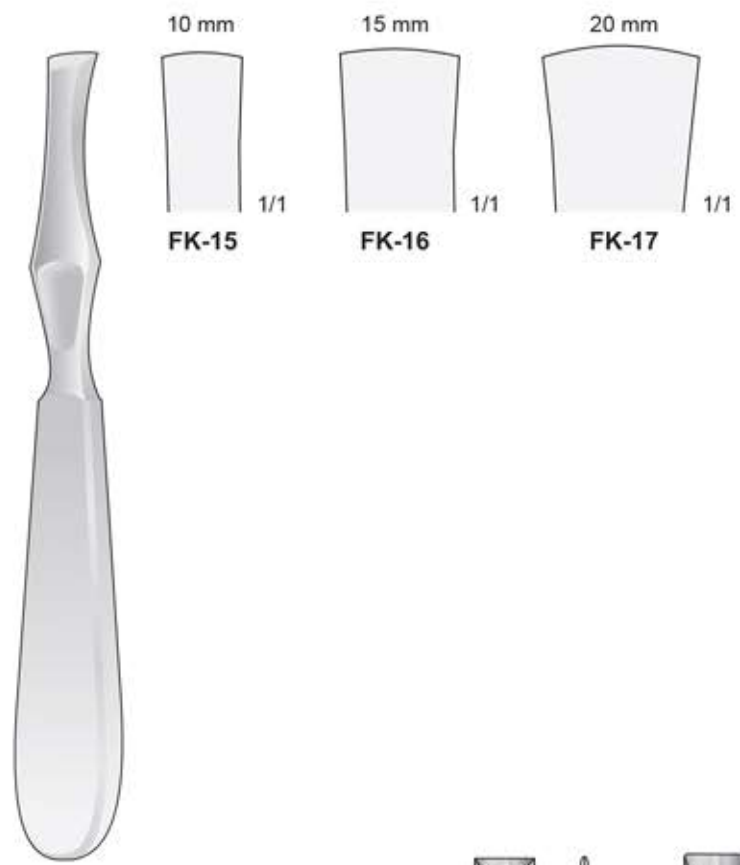

LAMBOTTE
FK-15/FK-17
205 mm

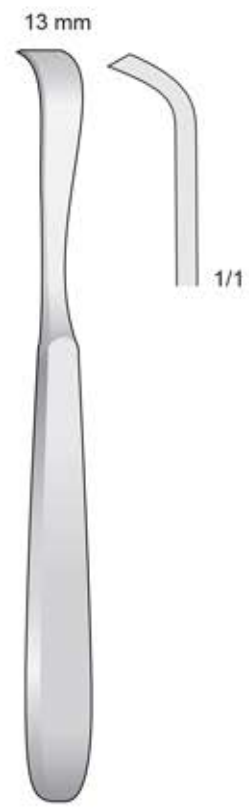

SCHNEIDER-SAUERBRUCH
FK-259
190 mm

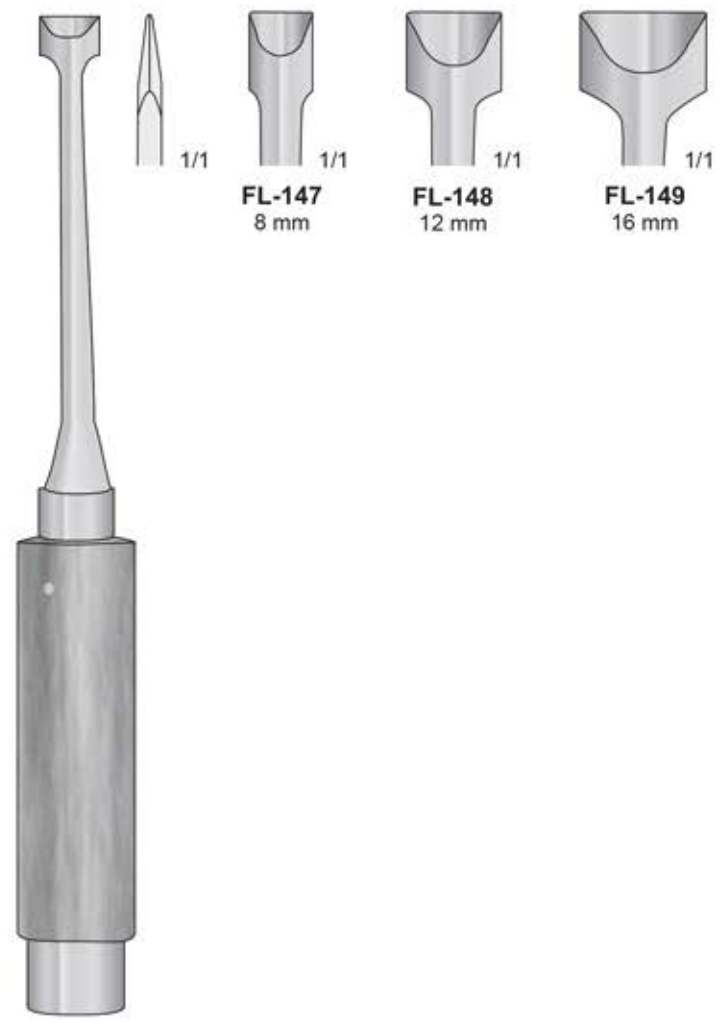

OBWEGESER
FL-147/FL-149
220 mm

Mit Ferrozellgriff
With Ferrozell handle
Con manico Ferrozell
Con mango de Ferrozell
Avec poignée en Ferrozell

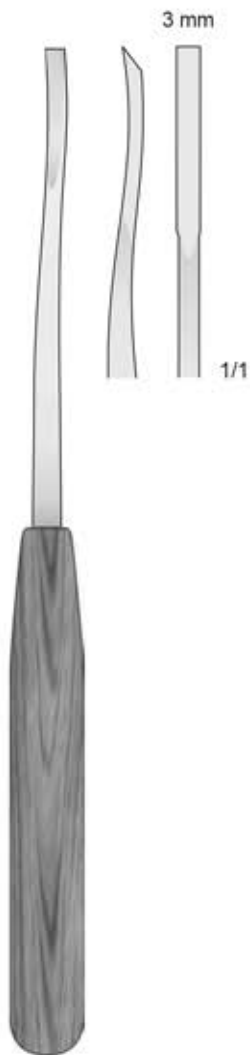

FK-234
180 mm

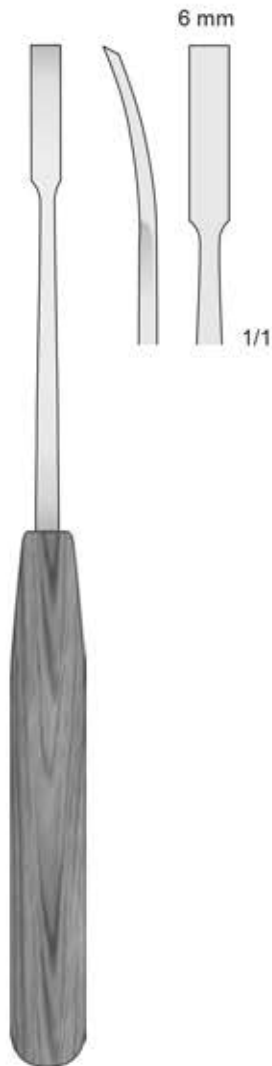

FK-230
190 mm

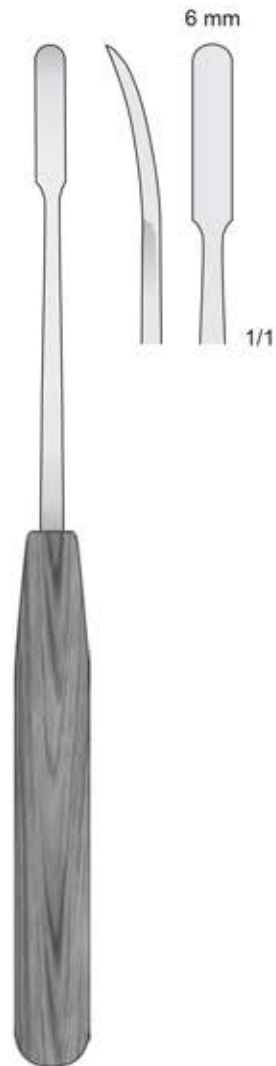

FK-232
190 mm

Mit Ferrozellgriff
 With Ferrozell handle
 Con manico Ferrozell
 Con mango de Ferrozell
 Avec poignée en Ferrozell

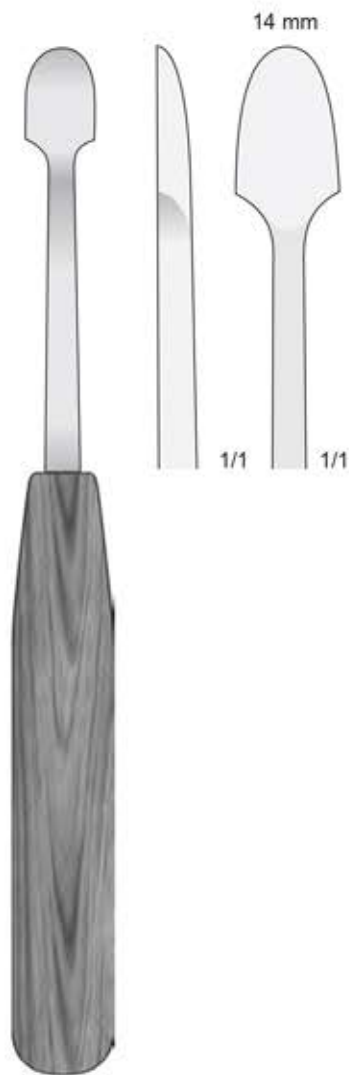

FK-236
200 mm

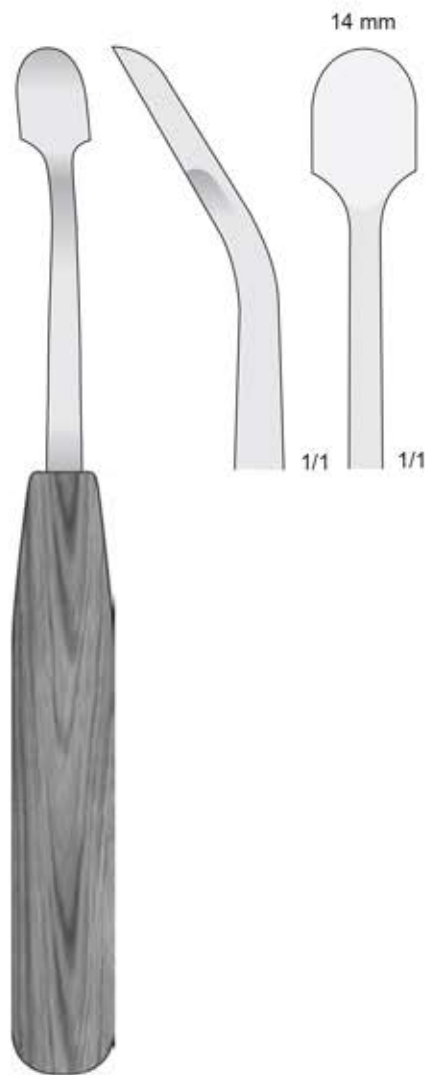

FK-238
200 mm

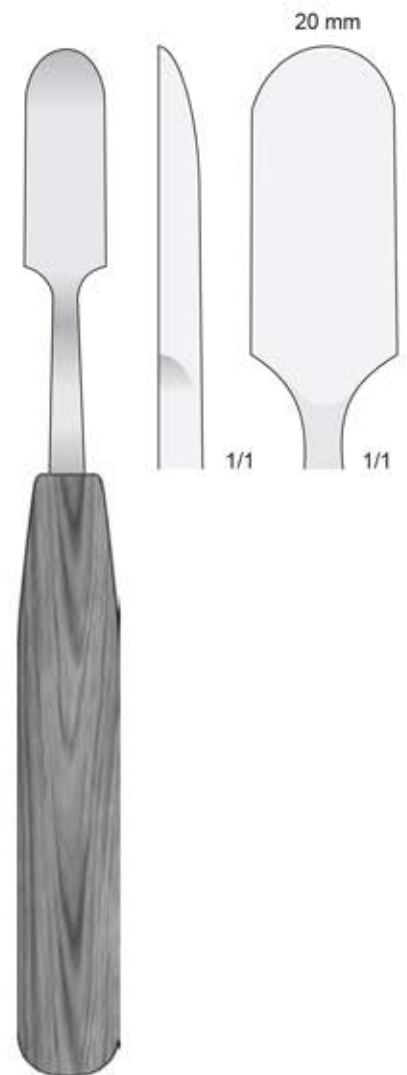

FK-240
200 mm

Mit Ferrozellgriff
With Ferrozell handle
Con manico Ferrozell
Con mango de Ferrozell
Avec poignée en Ferrozell

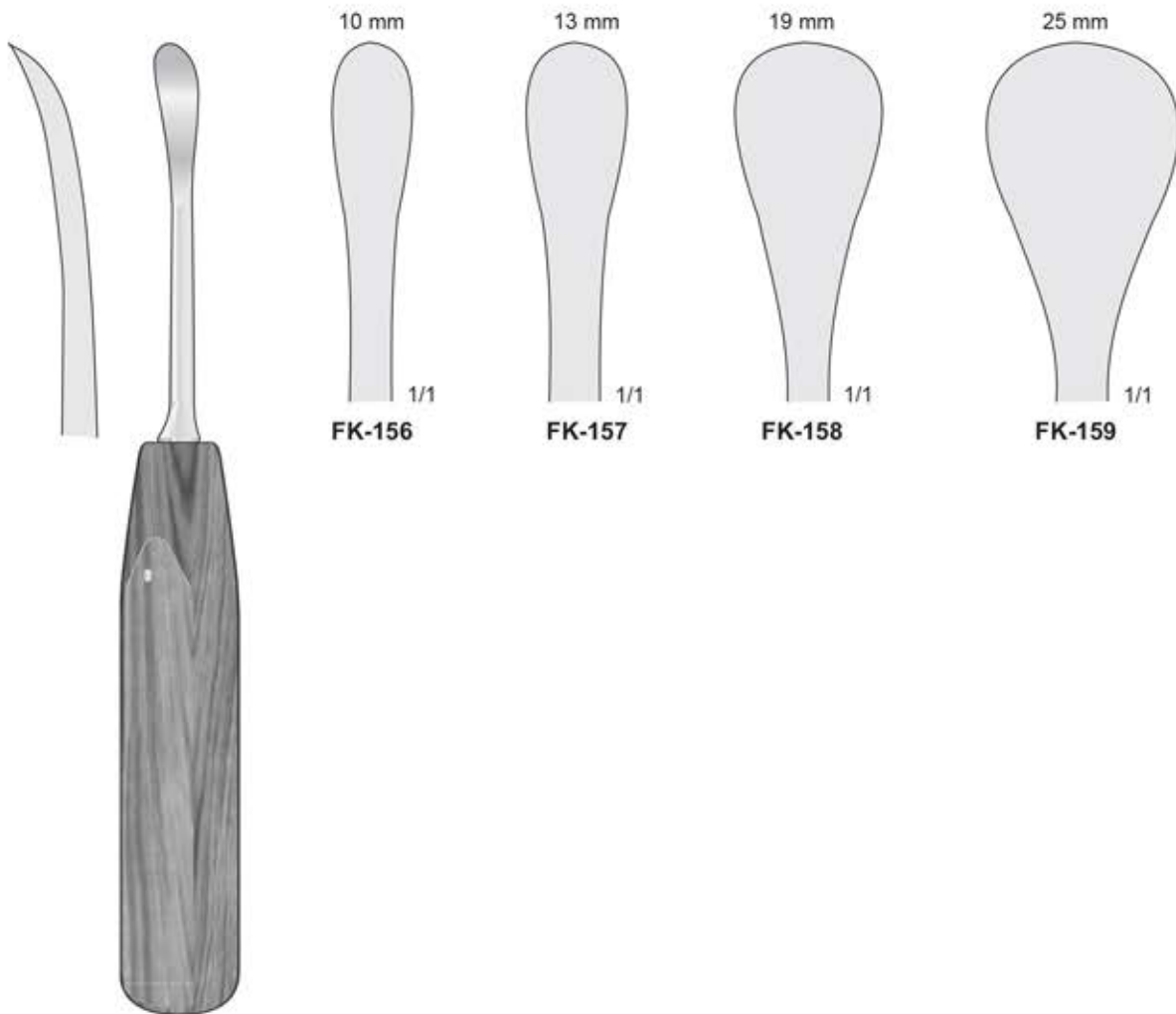

COBB
FK-156/FK-159
250 mm

Fig. 67

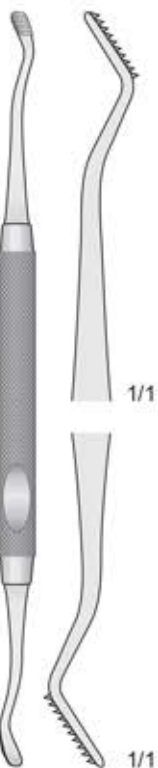

**HOWARD
DO-1**
180 mm

Fig. 45

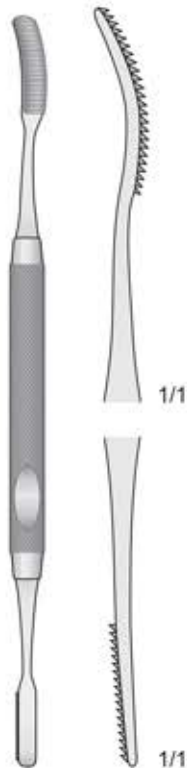

**MILLER
DO-2**
185 mm

Fig. 52

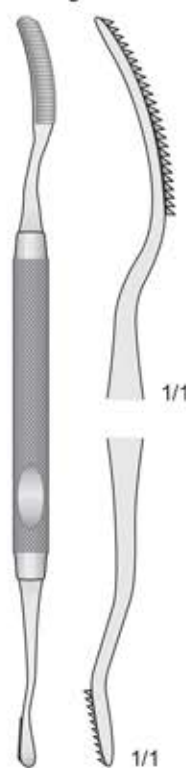

**MILLER
DO-3**
180 mm

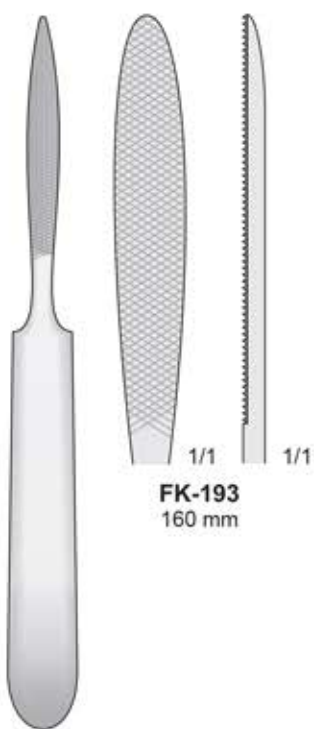

**JOSEPH
FK-193**
160 mm

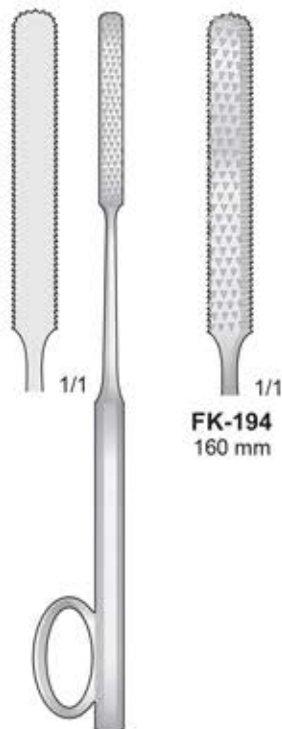

**GALLAHER
FK-194/FK-196**
160 mm

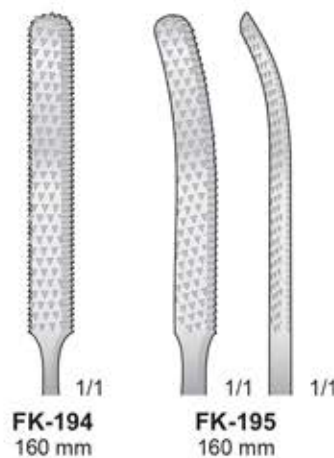

FK-194
160 mm

FK-195
160 mm

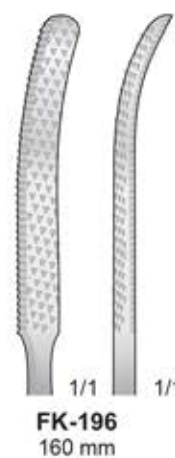

FK-196
160 mm

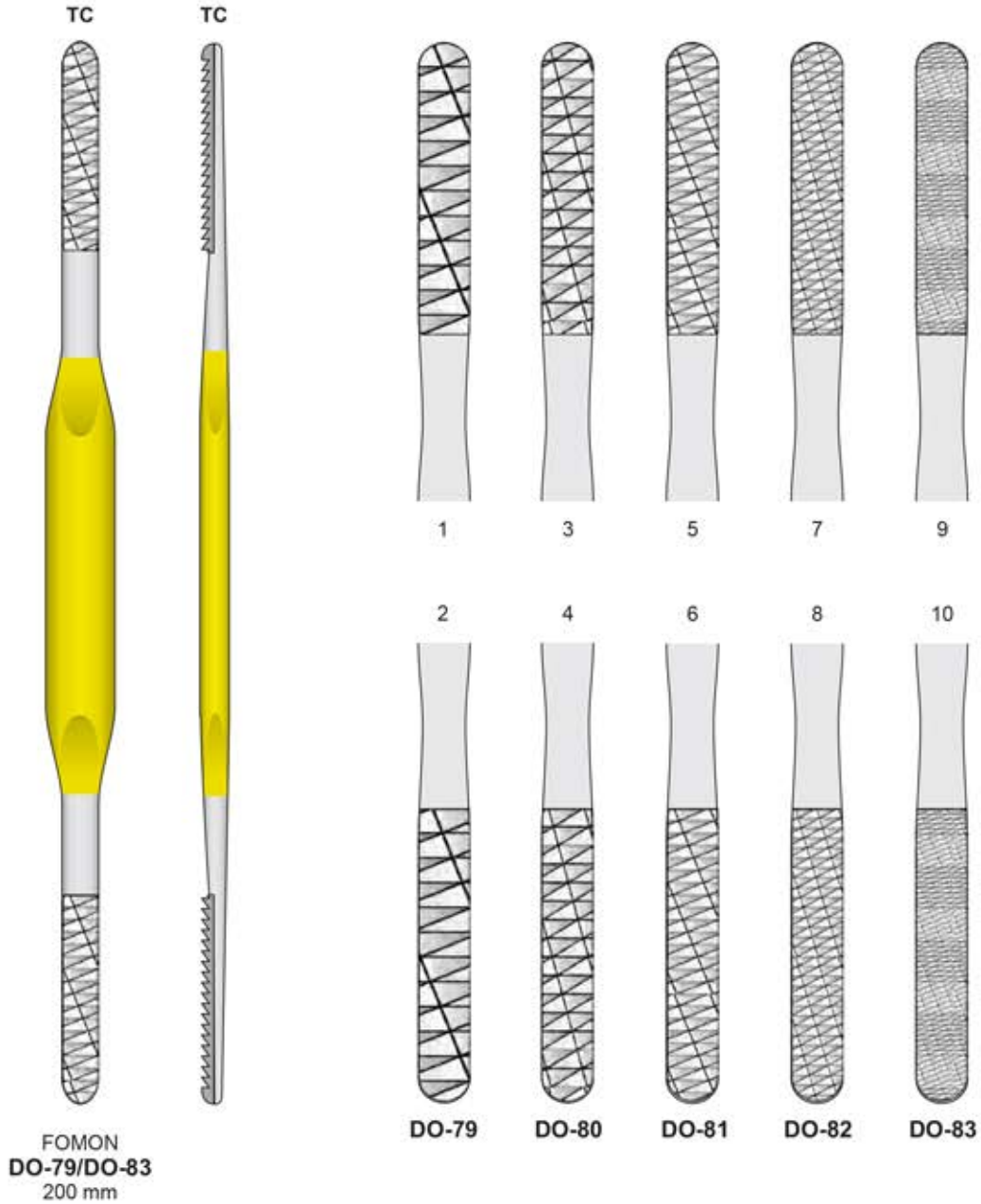

20 mm

**FK-85**
295 mm

13 mm

**FK-86**
240 mm

20 mm

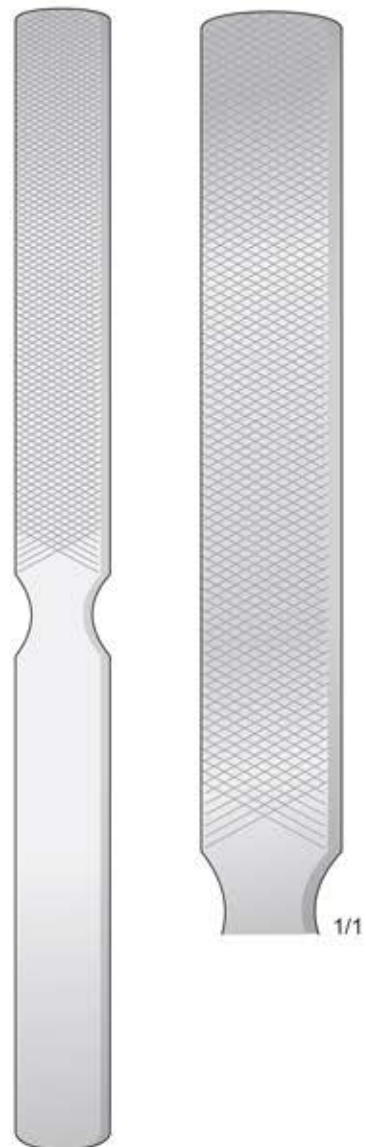
**FK-119**
220 mm



MARTINI
FK-70
140 mm



WILLIGER
FK-71
145 mm



JACOBSON
FK-75
140 mm



MARTINI
FK-76
140 mm

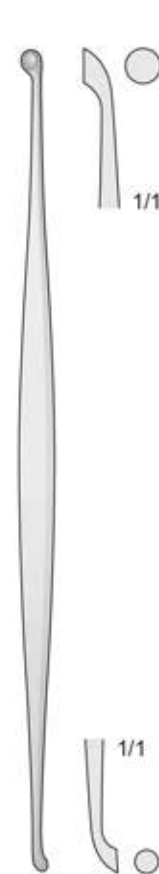

JANZEN
FK-77
160 mm



BARTH
FK-78
180 mm

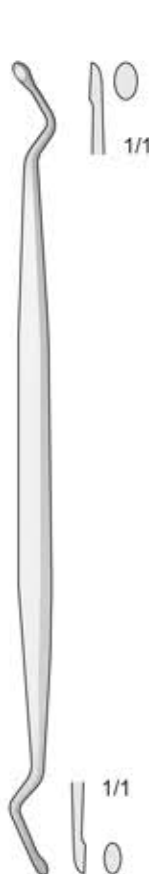

FK-83
160 mm



JANZEN
FK-84
160 mm

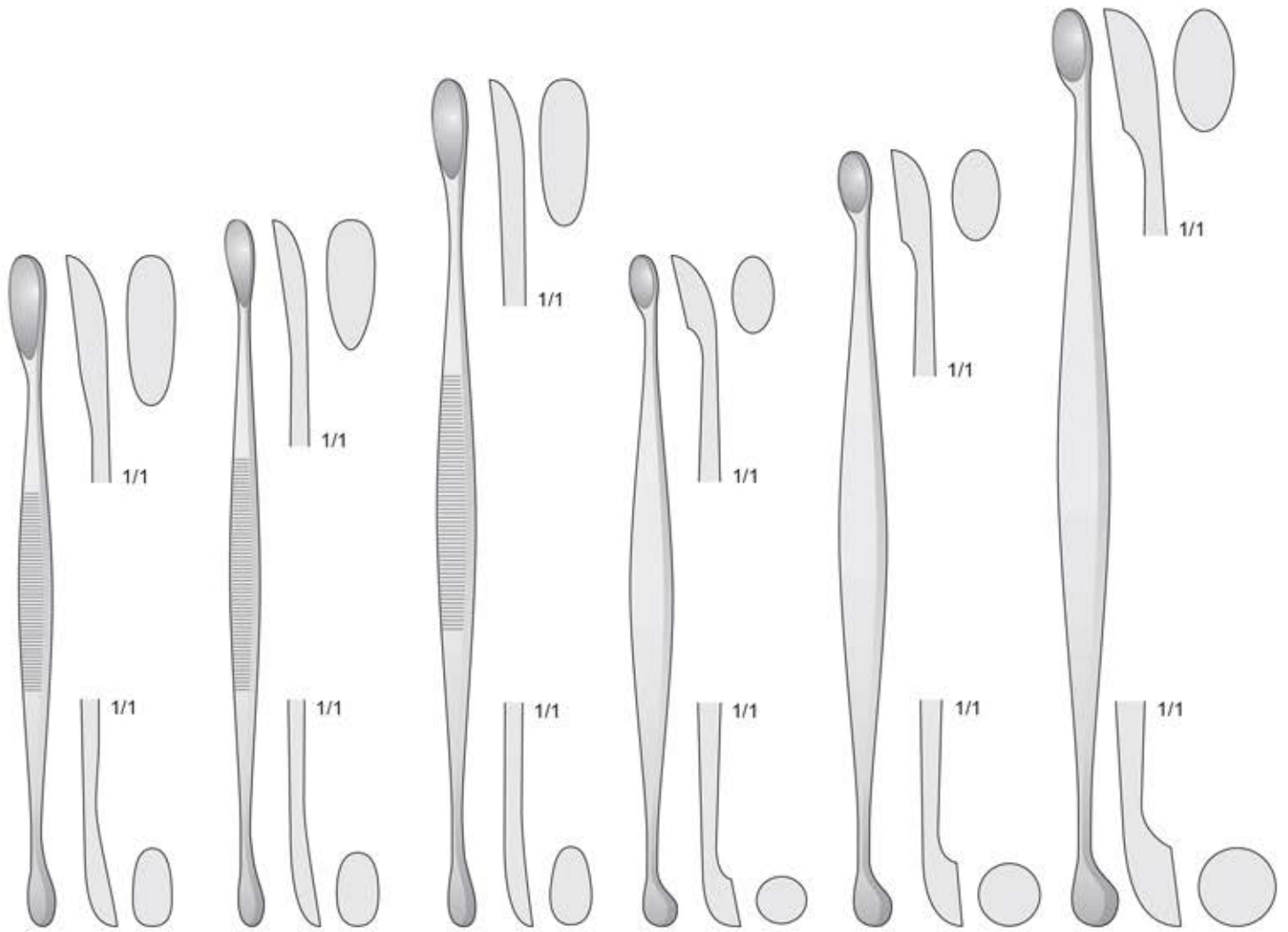

VOLKMANN
FK-79
130 mm

VOLKMANN
FK-72
145 mm

VOLKMANN
FK-73
170 mm

FK-177
130 mm

FK-74
160 mm

FK-178
200 mm

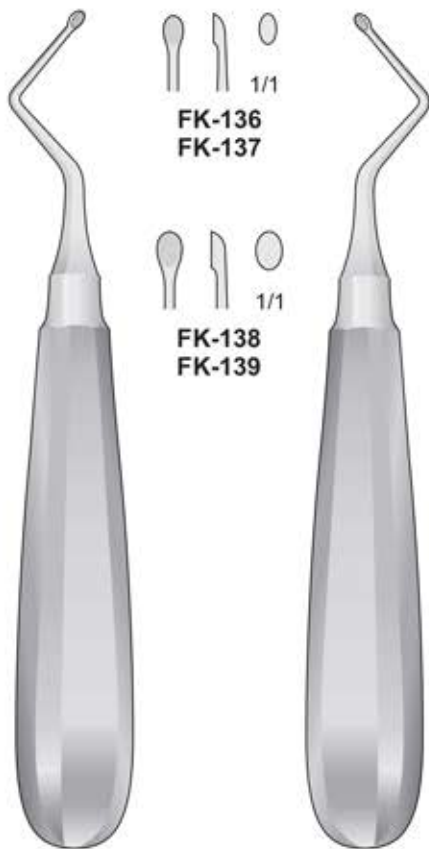

KERPEL
FK-136
FK-138
145 mm

KERPEL
FK-137
FK-139
145 mm



UFFENDORDE
FK-188
170 mm

UFFENDORDE
FK-189
170 mm



BRUNS
FK-110/FK-116
165 mm

- | | | |
|-----------------|----------------|---------------|
| Fig.000
3 mm | Fig.00
4 mm | Fig.0
5 mm |
| | | |
| FK-110 | FK-111 | FK-112 |
| Fig.1
6 mm | Fig.2
8 mm | |
| | | |
| FK-113 | FK-114 | |
| Fig.3
10 mm | Fig.4
12 mm | |
| | | |
| FK-115 | FK-116 | |



SCHEDE
FK-120/FK-126
170 mm

- | | | |
|-------------------|------------------|-----------------|
| Fig.000
2,5 mm | Fig.00
3,4 mm | Fig.0
4,2 mm |
| | | |
| FK-120 | FK-121 | FK-122 |
| Fig.1
5,2 mm | Fig.2
6,3 mm | |
| | | |
| FK-123 | FK-124 | |
| Fig.3
7,4 mm | Fig.4
8 mm | |
| | | |
| FK-125 | FK-126 | |



FK-01/FK-08
180 mm

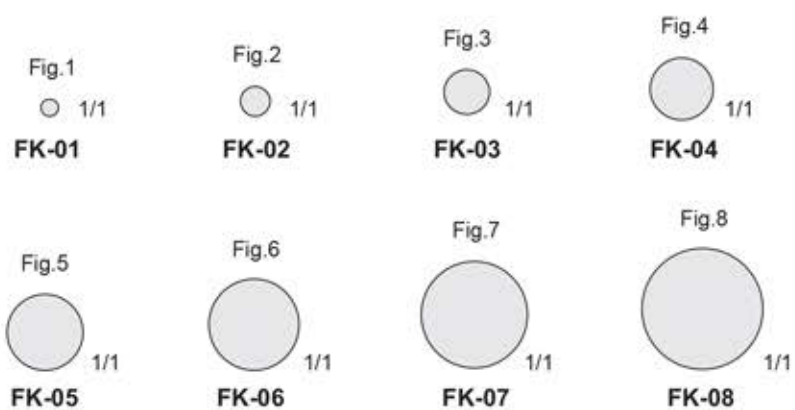

VOLKMANN
FK-60/FK-69
170 mm

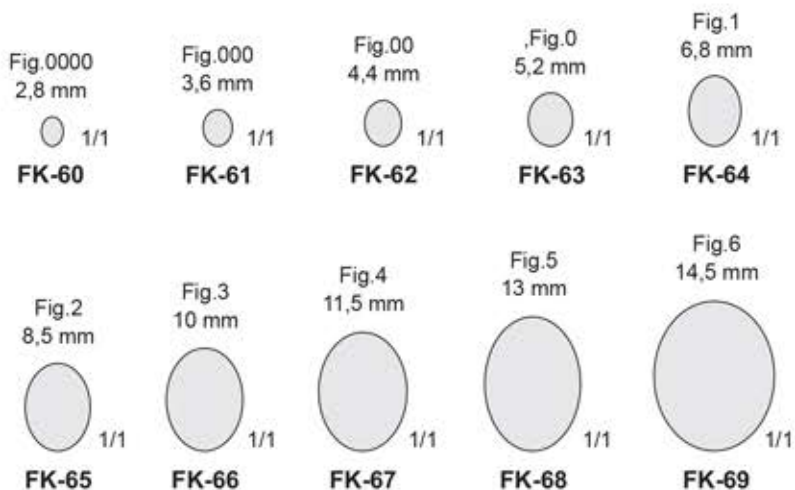



WILLIGER
FK-197/FK-198
170 mm

Fig. 00
3,4 mm
1/1
FK-197

Fig. 1
5,2 mm
1/1
FK-198

Biegsam
Malleable
Malleabile
Maleable
Souple



HALLE
FK-130/FK-132
215 mm

Fig.00
4,4 mm
1/1
FK-130

Fig.0
5,2 mm
1/1
FK-131

Fig.1
6,8 mm
1/1
FK-132

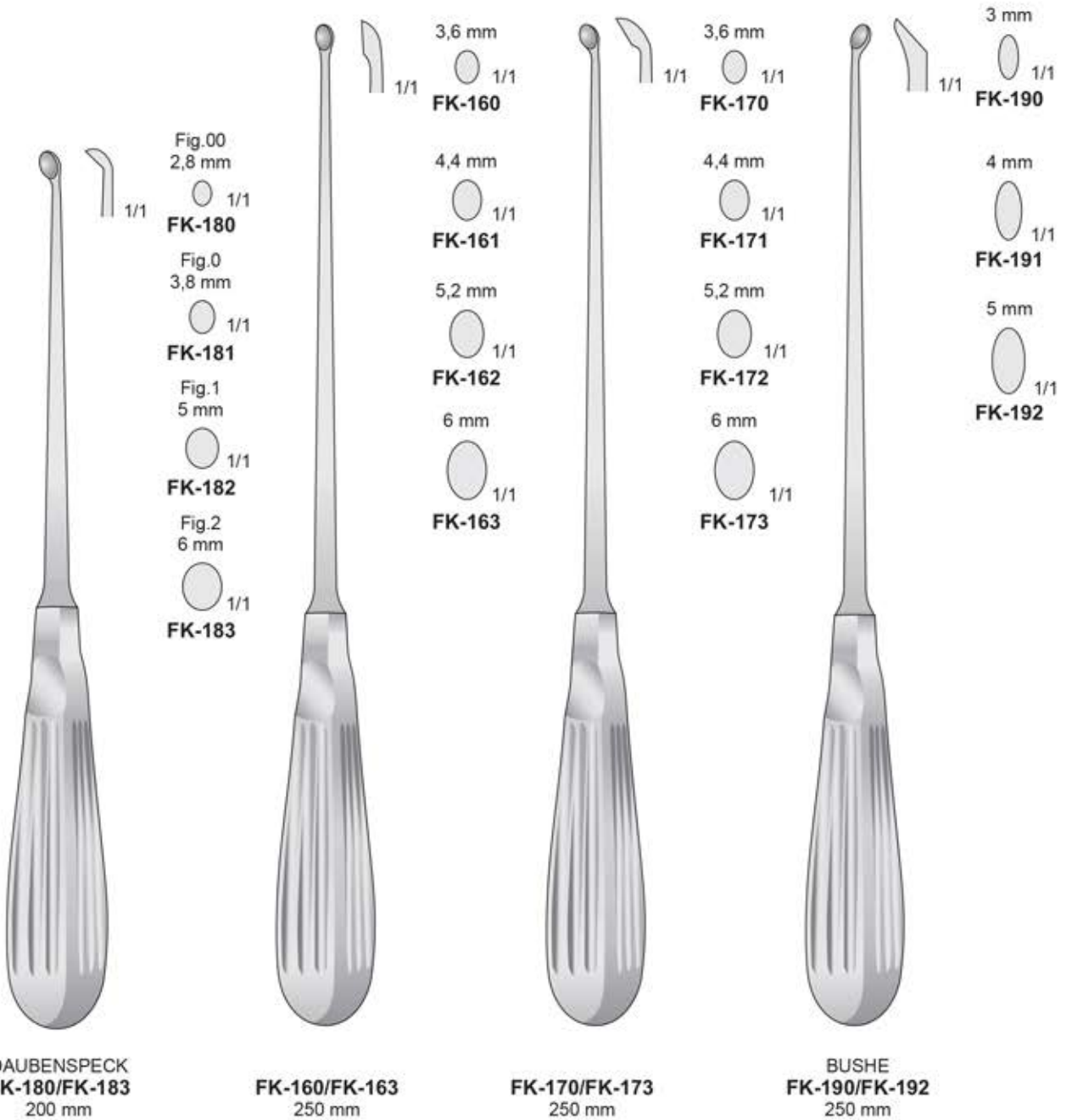

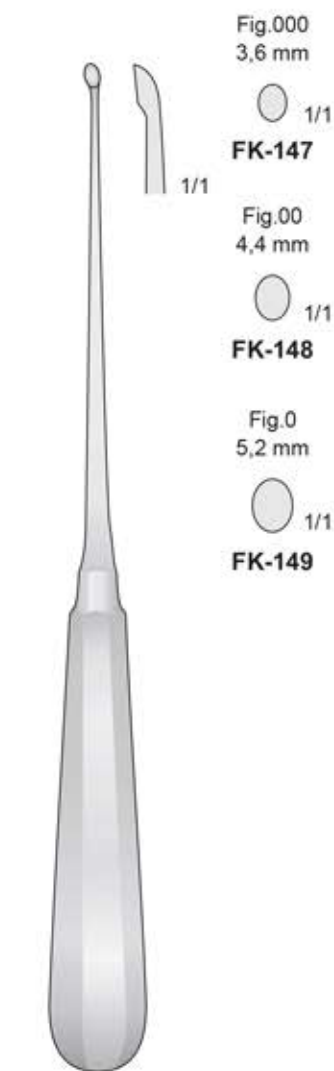

SIMON
FK-147/FK-149
235 mm

Fig.000
3,6 mm
1/1
FK-147

Fig.00
4,4 mm
1/1
FK-148

Fig.0
5,2 mm
1/1
FK-149

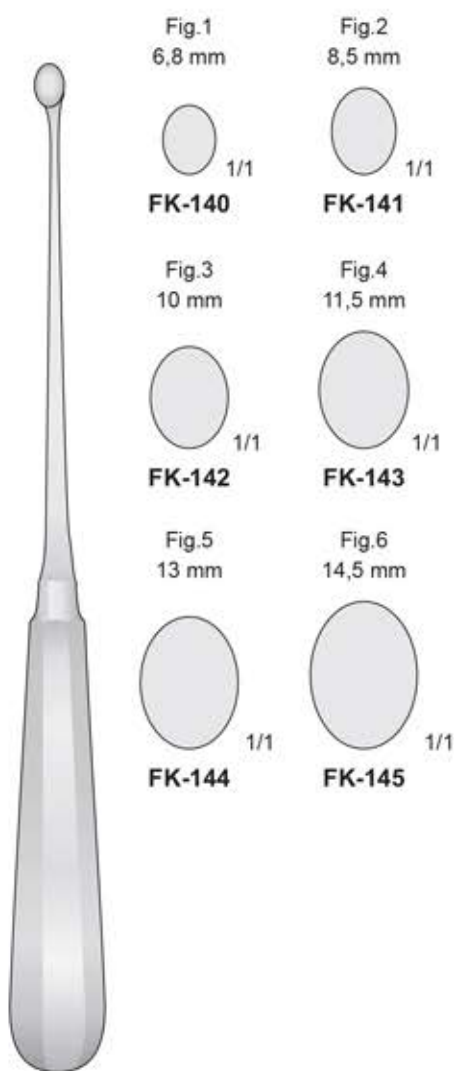

SIMON
FK-140/FK-145
240 mm

Fig.1
6,8 mm
1/1
FK-140

Fig.3
10 mm
1/1
FK-142

Fig.5
13 mm
1/1
FK-144

Fig.2
8,5 mm
1/1
FK-141

Fig.4
11,5 mm
1/1
FK-143

Fig.6
14,5 mm
1/1
FK-145

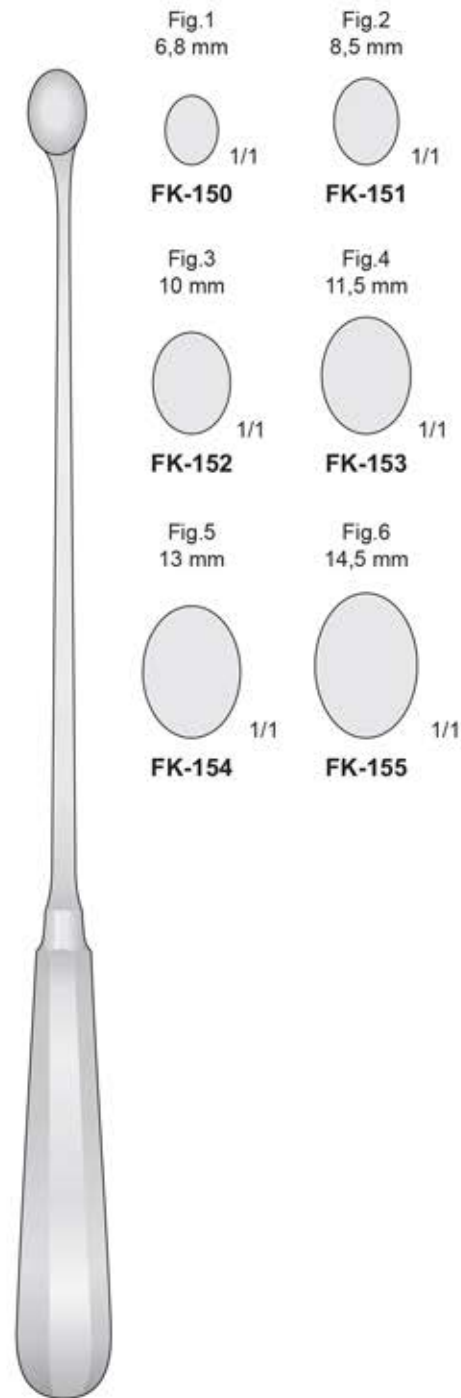

SCHRÖDER
FK-150/FK-155
310 mm

Fig.1
6,8 mm
1/1
FK-150

Fig.3
10 mm
1/1
FK-152

Fig.5
13 mm
1/1
FK-154

Fig.2
8,5 mm
1/1
FK-151

Fig.4
11,5 mm
1/1
FK-153

Fig.6
14,5 mm
1/1
FK-155



BRUNS
FK-280/FK-290
170 mm

Fig.5/0
2.2 mm



1/1

FK-280

Fig.4/0
2.5 mm



1/1

FK-281

Fig.3/0
2.8 mm



1/1

FK-282

Fig.2/0
3.3 mm



1/1

FK-283

Fig.0
3.6 mm



1/1

FK-284

Fig.1
4.3 mm



1/1

FK-285

Fig.2
4.8 mm



1/1

FK-286

Fig.3
5.6 mm



1/1

FK-287

Fig.4
6.0 mm



1/1

FK-288

Fig.5
6.7 mm



1/1

FK-289

Fig.6
8.8 mm











1/1

FK-290











BRUNS
FK-291/FK-299
225 mm

Fig.3/0 2,8 mm  1/1 FK-291	Fig.2/0 3,3 mm  1/1 FK-292	Fig.0 3,6 mm  1/1 FK-293
Fig.1 4,3 mm  1/1 FK-294	Fig.2 4,8 mm  1/1 FK-295	Fig.3 5,6 mm  1/1 FK-296
Fig.4 6,0 mm  1/1 FK-297	Fig.5 6,7 mm  1/1 FK-298	Fig.6 8,8 mm  1/1 FK-299



BRUNS
FK-300/FK-308
225 mm

Fig.3/0 2,8 mm  1/1 FK-300	Fig.2/0 3,3 mm  1/1 FK-301	Fig.0 3,6 mm  1/1 FK-302
Fig.1 4,3 mm  1/1 FK-303	Fig.2 4,8 mm  1/1 FK-304	Fig.3 5,6 mm  1/1 FK-305
Fig.4 6,0 mm  1/1 FK-306	Fig.5 6,7 mm  1/1 FK-307	Fig.6 8,8 mm  1/1 FK-308

Mit Ferrozellgriff - With Ferrozell handle
 Con manico Ferrozell - Con mango de Ferrozell
 Avec manche en Ferrozell



SYPERT
FK-310/FK-313
 380 mm

Fig.0000
 2,8 mm
 1/1
FK-310

Fig.0
 5,2 mm
 1/1
FK-312



Fig.000
 3,6 mm
 1/1
FK-311

Fig.3
 10,0 mm
 1/1
FK-313



SYPERT
FK-314/FK-317
 380 mm

Fig.0000
 2,8 mm
 1/1
FK-314

Fig.0
 5,2 mm
 1/1
FK-316



Fig.000
 3,6 mm
 1/1
FK-315

Fig.3
 10,0 mm
 1/1
FK-317

Mit Ferrozellgriff - With Ferrozell handle
 Con manico Ferrozell - Con mango de Ferrozell
 Avec poignée en Ferrozell

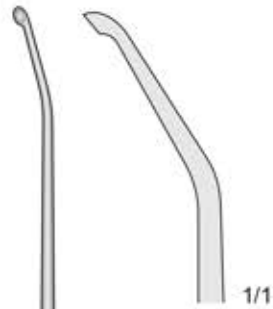

Fig.0000
2,8 mm
1/1
FK-318

Fig.000
3,6 mm
1/1
FK-319



SYPERT
FK-318/FK-319
420 mm

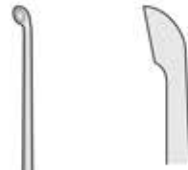

Fig.000
3,6 mm
1/1
FK-320

Fig.00
4,4 mm
1/1
FK-321

Fig.0
5,2 mm
1/1
FK-322



FK-320/FK-322
410 mm



Fig.000
3,6 mm
1/1
FK-323

Fig.00
4,4 mm
1/1
FK-324

Fig.0
5,2 mm
1/1
FK-325



FK-323/FK-325
410 mm

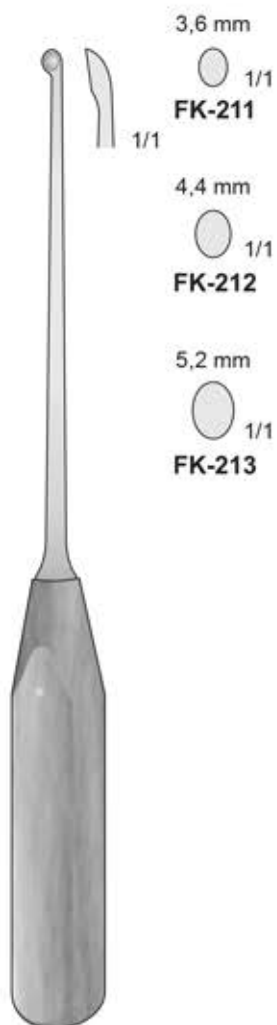

CASPAR
FK-211/FK-213
220 mm

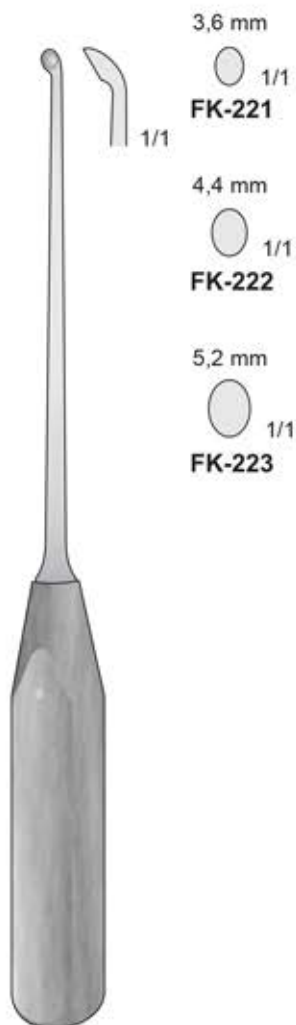

CASPAR
FK-221/FK-223
220 mm

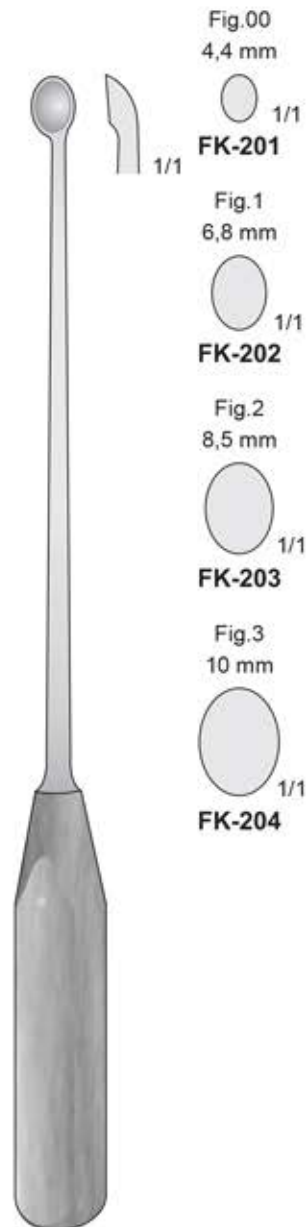

FK-201/FK-204
270 mm

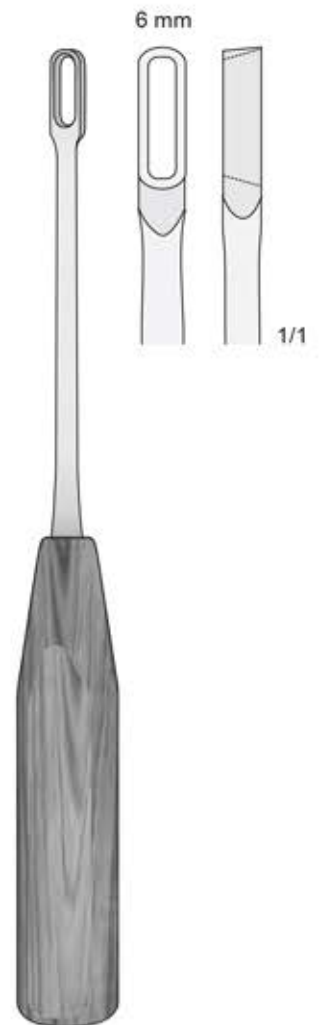

TESSIER
FL-198
220 mm

Femoral prosthesis instrumentation
Strumentario per protesi femorale
Instruments pour prothese femorale

Mit Ferrozellgriff
With Ferrozell handle
Con manico Ferrozell
Avec poignée en Ferrozell

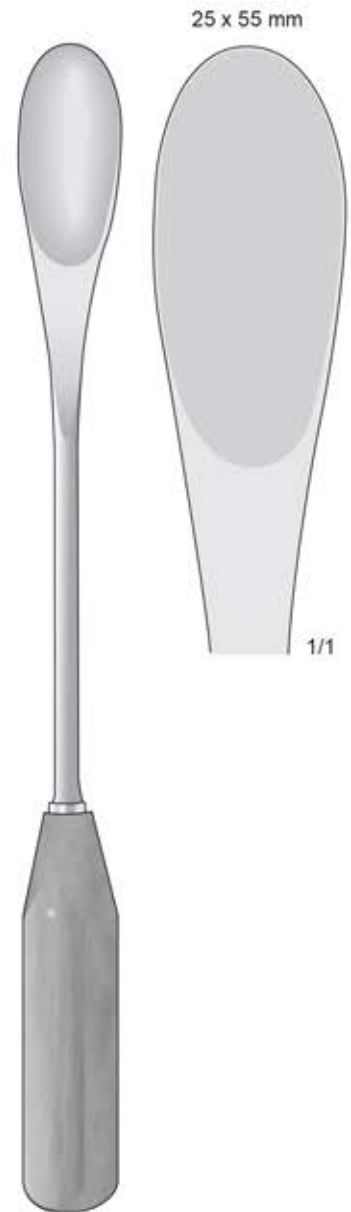
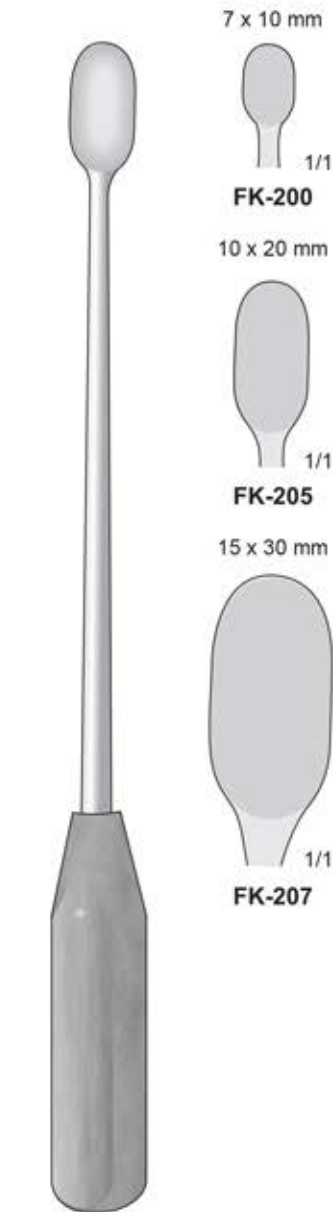
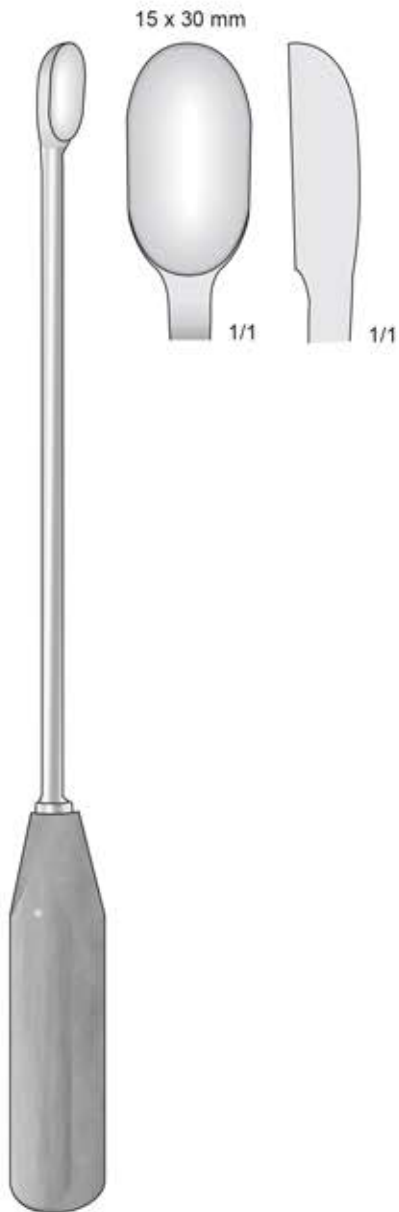

Surgical Mallets
Chirurgische Hämmer
Maillets chirurgicaux
Martillos quirúrgicos
Martelli chirurgici

Tampers
Stößels
Compacteurs
Compactadores
Compattatori

Osteotomes
Osteotome
Ostéotomes
Osteótomos
Osteotomi

Chisels
Meißeln
Burins
Cinceles
Scalpelli



FL-11R

Paar Ersatzbacken
 Pair of spare faces
 Coppia di teste
 di ricambio
 Pareja de tapas
 intercambiables
 Paire de faces
 de rechange

MEAD
FL-11
 200 mm



FL-09R

Paar Ersatzbacken
 Pair of spare faces
 Coppia di teste
 di ricambio
 Pareja de tapas
 intercambiables
 Paire de faces
 de rechange

MEAD
FL-09
 190 mm



FL-12R

Paar Ersatzbacken
 Pair of spare faces
 Coppia di teste
 di ricambio
 Pareja de tapas
 intercambiables
 Paire de faces
 de rechange

MEAD
FL-12
 190 mm



FL-01
 165 mm



LUCAE
FL-10M
 190 mm



WILLIGER
FL-02
 240 mm

1 Seite flach - 1 Seite convex
1 Side flat - 1 Side convex
1 Lato piatto - 1 Lato convesso
1 Parte plana - 1 Parte convexe
1 Face plate - 1 Face convexe

Ø 30 mm - 240 g



COTTLE
FL-104
185 mm

Ø 30 mm - 300 g



BERGMANN
FL-105
235 mm

Ø 45 mm - 300 g



BERGMANN
FL-106
245 mm



FL-107
240 mm



OMBREDANNE
FL-108
240 mm



HEATH
FL-109
185 mm



FL-112
190 mm

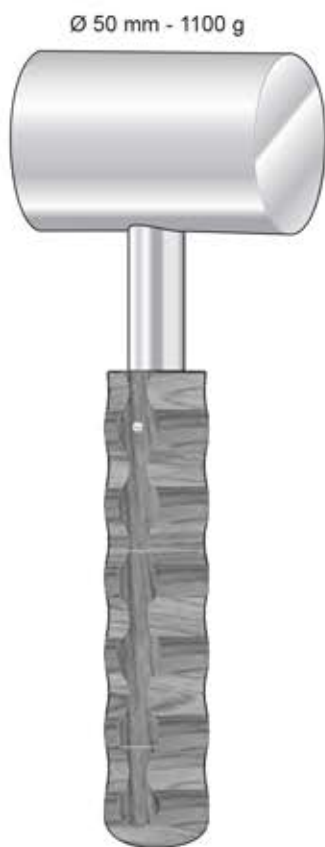

FL-111
200 mm



FL-06
260 mm



FL-113
270 mm



-  **FF-147**
Ø3 mm
-  **FF-148**
Ø5 mm
-  **FF-149**
Ø8 mm

CASPAR
FF-147/FF-149
200 mm



-  **FL-253**
Ø12 mm
-  **FL-254**
Ø14 mm
-  **FL-255**
Ø16 mm

FL-253/FL-255
200 mm



-  **FL-256**
3x8 mm
-  **FL-257**
4x10 mm
-  **FL-258**
5x15 mm
-  **FL-259**
6x20 mm

SYPERT
FL-256/FL-259
290 mm

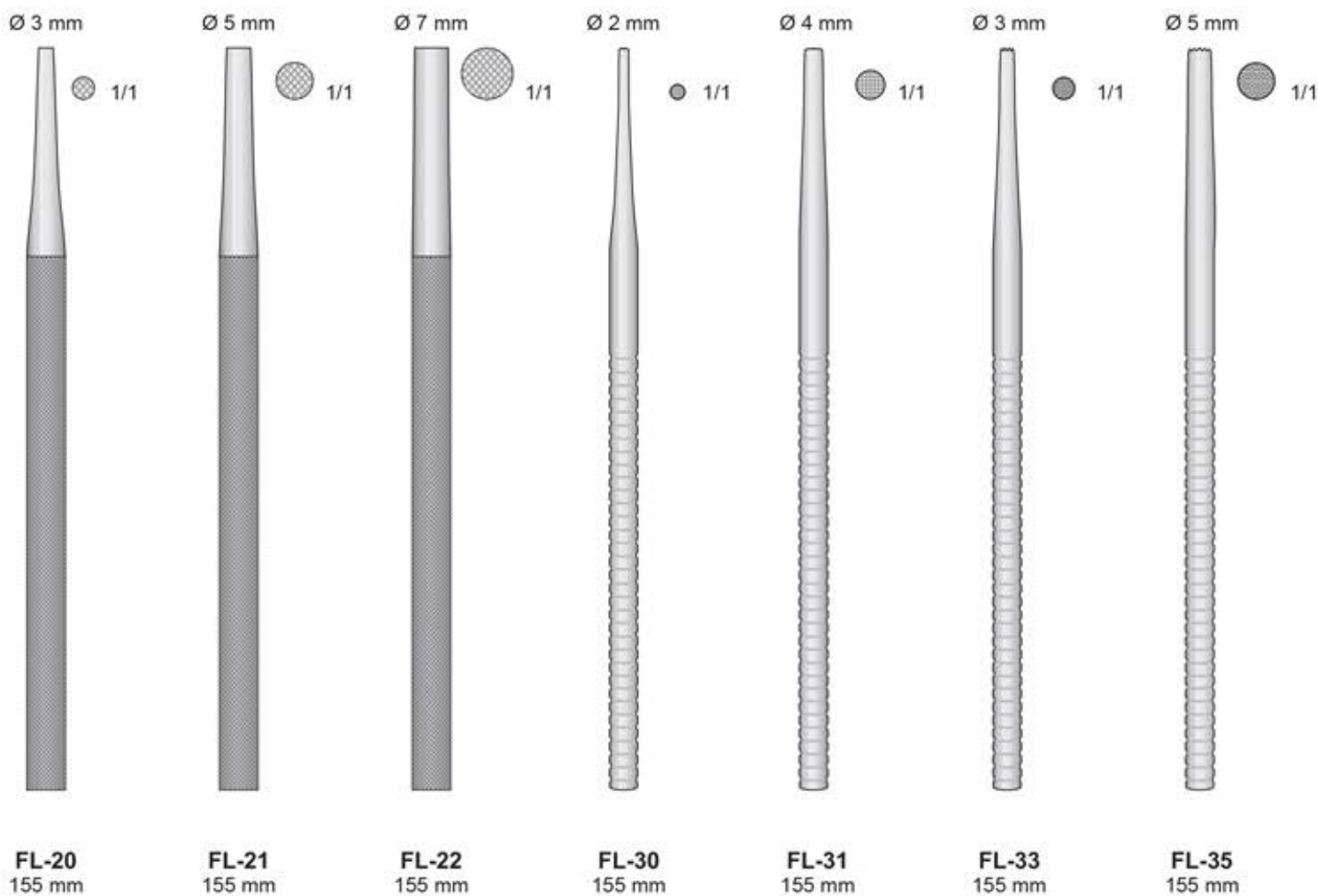
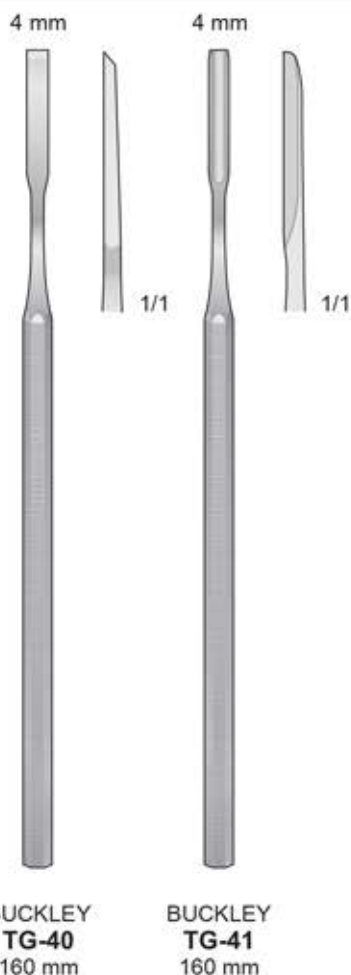

Osteotome -Osteotomes
Osteotomi - Osteótomos - Ostéotomes

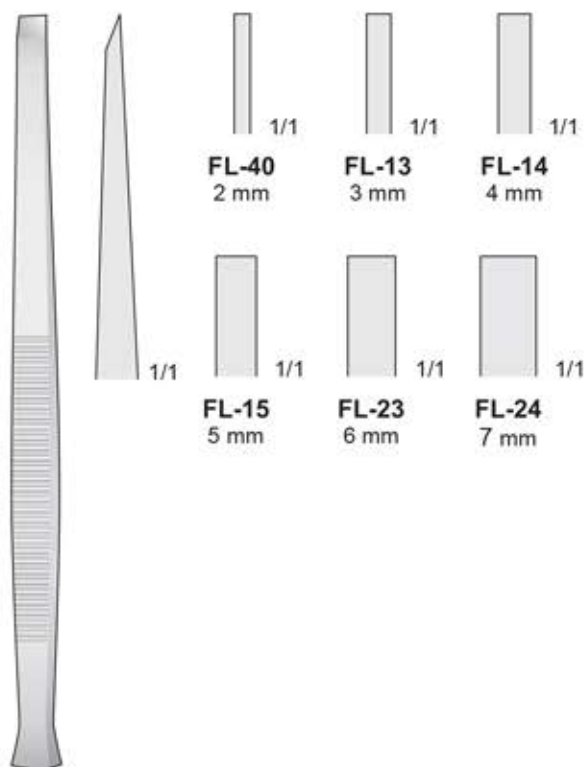

PARTSCH
FL-13/FL-40
140 mm

Hohlmeißel - Gouges
Sgorbie - Gubias - Gouges

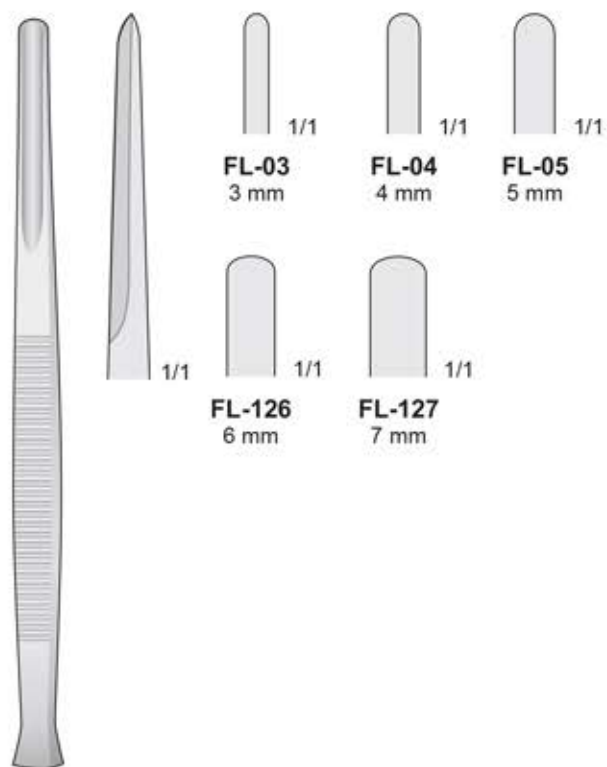

PARTSCH
FL-03/FL-127
140 mm

Osteotome -Osteotomes
Osteotomi - Osteótomos - Ostéotomes

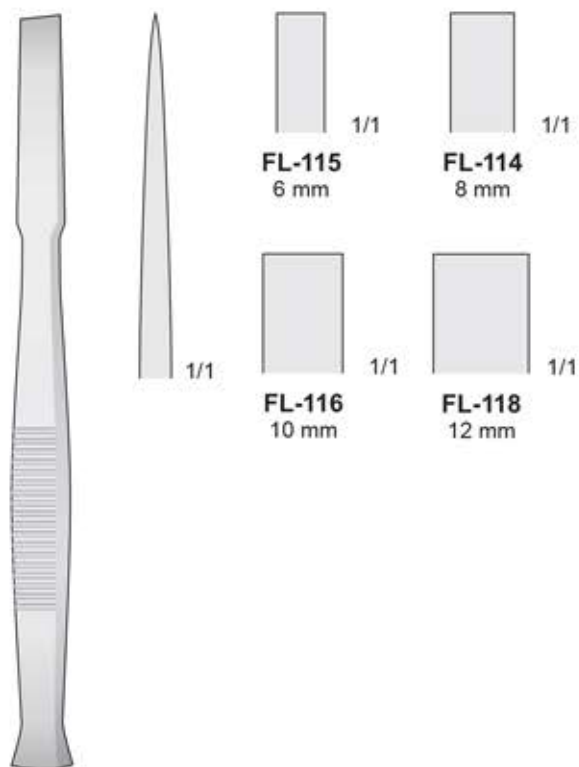

FL-114/FL-118
140 mm

Hohlmeißel - Gouges
Sgorbie - Gubias - Gouges

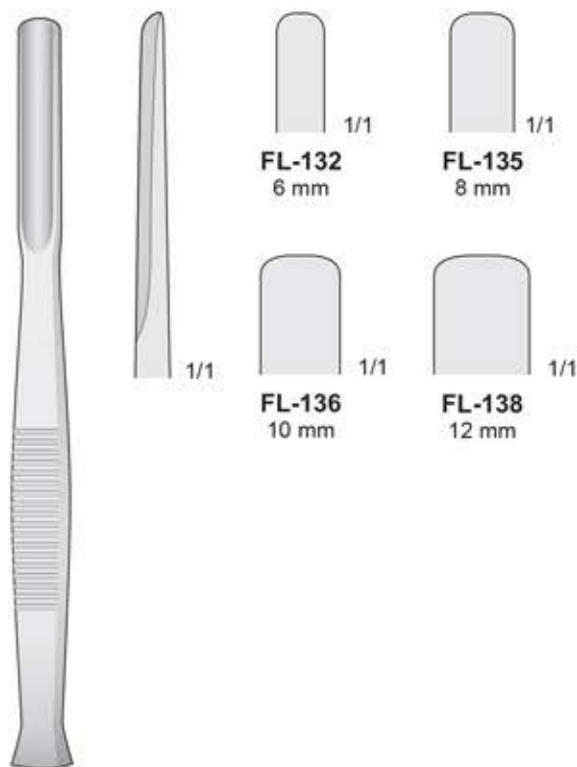

FL-132/FL-138
140 mm

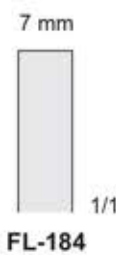
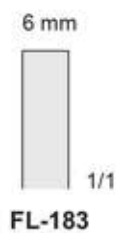
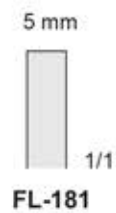
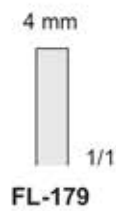
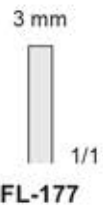

PARTSCH
FL-177/FL-184
170 mm

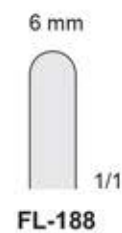
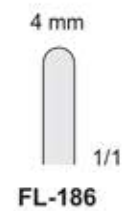
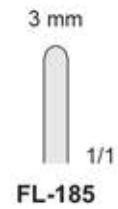

PARTSCH
FL-185/FL-189
170 mm

8 mm

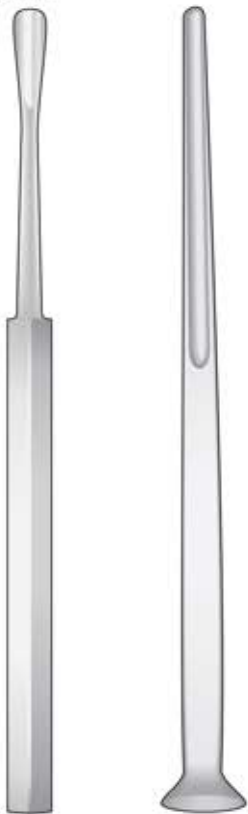

COSCIA
FL-368
180 mm

ALEXANDER
FL-206/FL-209
170 mm

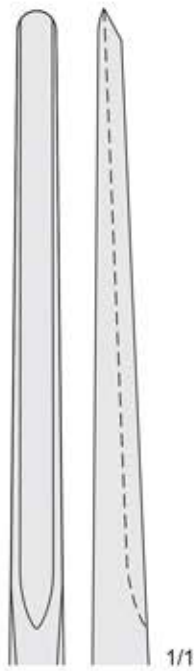

FL-206
5 mm

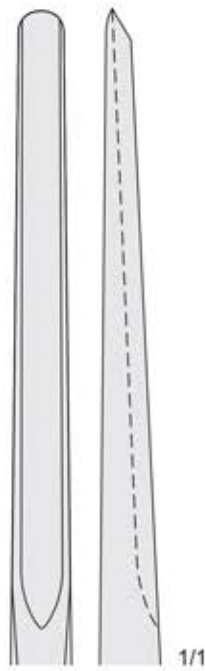

FL-207
7 mm

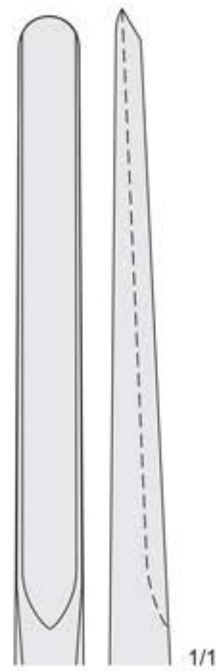

FL-208
9 mm

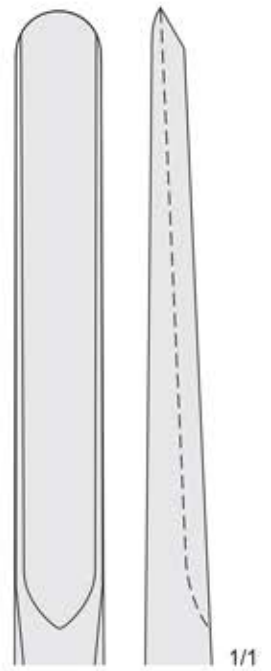

FL-209
11 mm



MINI-LAMBOTTE
FL-16/FL-58
125 mm



1/1

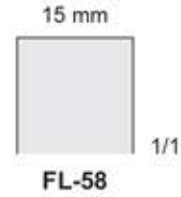
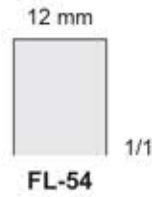
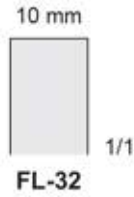
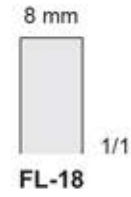
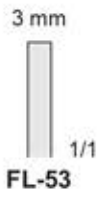

MINI-LAMBOTTE
FL-263/FL-269
170 mm



1/1

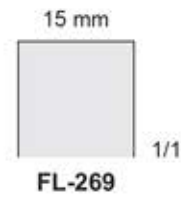
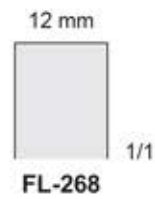
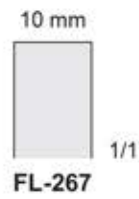
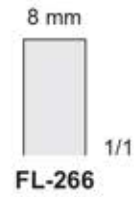
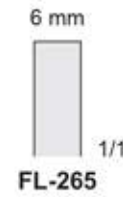
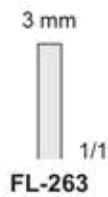



1/1

- FL-41 4 mm
- FL-29 8 mm
- FL-42 10 mm
- FL-34 13 mm
- FL-43 15 mm
- FL-36 18 mm
- FL-44 20 mm
- FL-45 25 mm
- FL-46 30 mm
- FL-47 38 mm
- FL-48 44 mm
- FL-49 50 mm

LAMBOTTE
FL-41/FL-49
250 mm



1/1

- FL-94 8 mm
- FL-95 13 mm
- FL-96 18 mm
- FL-97 25 mm
- FL-98 30 mm
- FL-99 38 mm

LAMBOTTE
FL-94/FL-99
250 mm

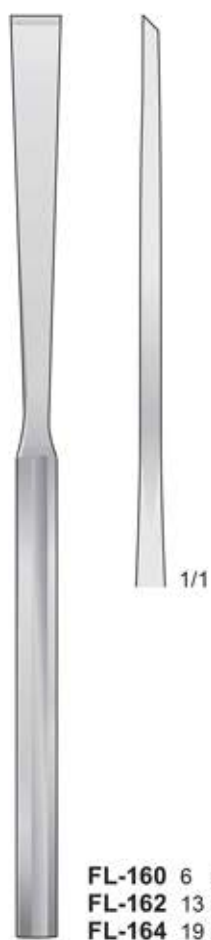

FL-160 6 mm
FL-162 13 mm
FL-164 19 mm

HIBBS
FL-160/FL-164
 230 mm



FL-166 6 mm
FL-168 13 mm
FL-170 19 mm

HIBBS
FL-166/FL-170
 230 mm

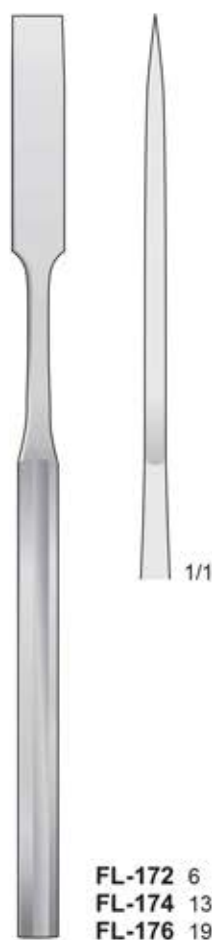

FL-172 6 mm
FL-174 13 mm
FL-176 19 mm

HIBBS
FL-172/FL-176
 230 mm

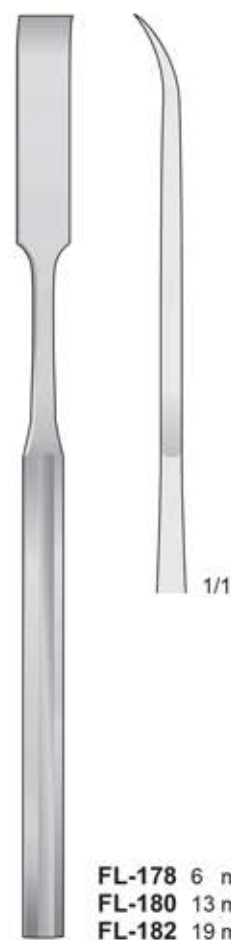

FL-178 6 mm
FL-180 13 mm
FL-182 19 mm

HIBBS
FL-178/FL-182
 230 mm



DO-190/DO-192
180 mm



DO-193/DO-195
180 mm



DO-196/DO-197
180 mm

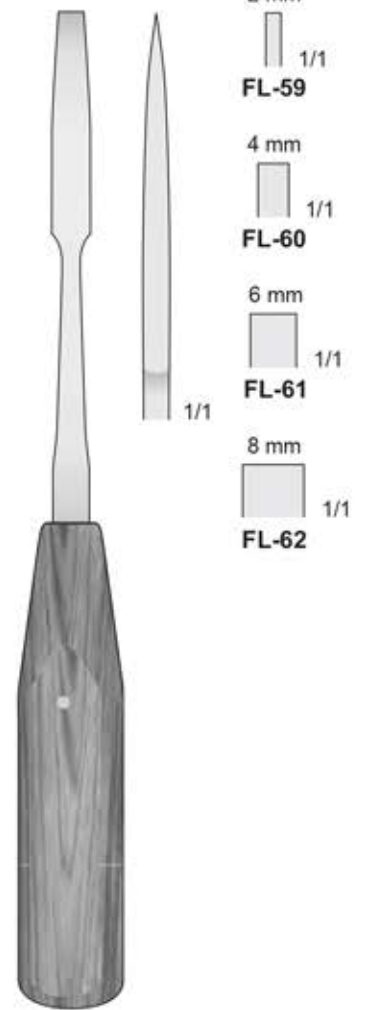

MINI-LEXER
FL-59/FL-62
200 mm

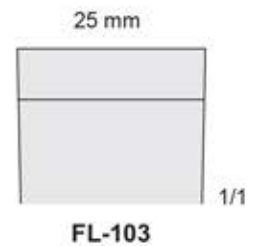
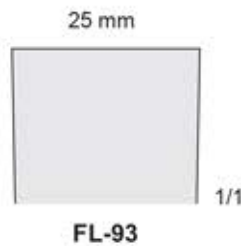
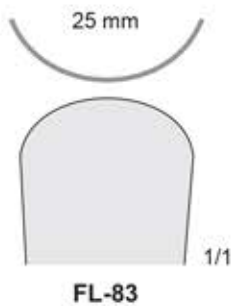
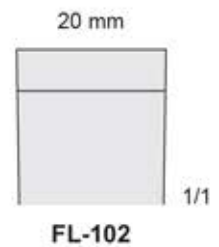
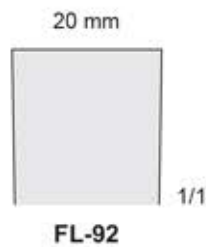
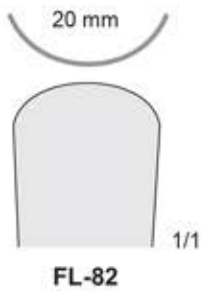
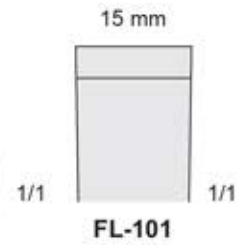
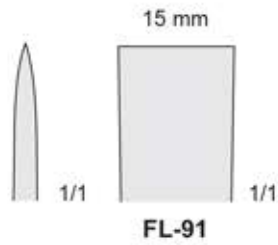
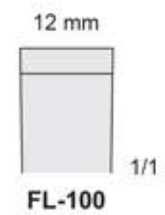
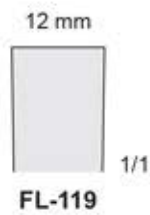
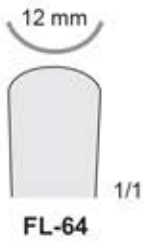
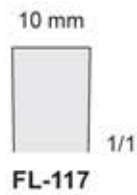

STILLE
FL-63/FL-83
200 mm



STILLE
FL-91/FL-119
200 mm



STILLE
FL-100/FL-110
200 mm

<p>6 mm 1/1 FL-340</p> <p>9 mm 1/1 FL-341</p> <p>13 mm 1/1 FL-342</p> <p>16 mm 1/1 FL-343</p> <p>19 mm 1/1 FL-344</p> <p>25 mm 1/1 FL-345</p> <p>32 mm FL-346</p> <p>SMITH-PETERSEN FL-340/FL-346 200 mm</p>	<p>6 mm 1/1 FL-347</p> <p>9 mm 1/1 FL-348</p> <p>13 mm 1/1 FL-349</p> <p>16 mm 1/1 FL-350</p> <p>19 mm 1/1 FL-351</p> <p>25 mm 1/1 FL-352</p> <p>32 mm FL-353</p> <p>SMITH-PETERSEN FL-347/FL-353 200 mm</p>	<p>9 mm 1/1 FL-354</p> <p>13 mm 1/1 FL-355</p> <p>19 mm 1/1 FL-356</p> <p>25 mm FL-357</p> <p>SMITH-PETERSEN FL-354/FL-357 200 mm</p>	<p>9 mm 1/1 FL-359</p> <p>13 mm 1/1 FL-360</p> <p>19 mm 1/1 FL-361</p> <p>25 mm FL-362</p> <p>SMITH-PETERSEN FL-359/FL-362 200 mm</p>
--	--	--	--



FL-307 10 mm
 FL-308 15 mm
 FL-309 20 mm
 FL-310 30 mm

TESSIER
 FL-307/FL-310
 200 mm



FL-311 10 mm
 FL-312 15 mm

TESSIER
 FL-311/FL-312
 200 mm

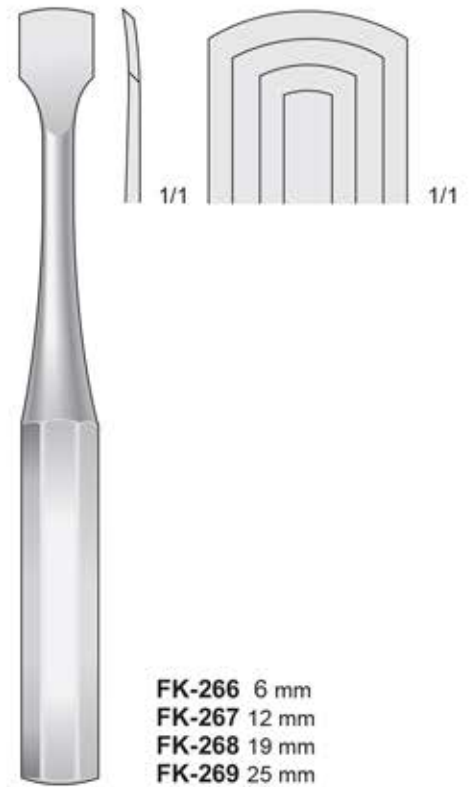

FK-266 6 mm
 FK-267 12 mm
 FK-268 19 mm
 FK-269 25 mm

KEY
 FK-266/FK-269
 190 mm



1/1

- FL-230 4 mm
- FL-231 6 mm
- FL-232 8 mm
- FL-233 10 mm
- FL-234 12 mm

MINI-LEXER
FL-230/FL-234
180 mm



1/1

- FL-240 4 mm
- FL-241 6 mm
- FL-242 8 mm
- FL-243 10 mm
- FL-244 12 mm

MINI-LEXER
FL-240/FL-244
180 mm



1/1

- FL-190 4 mm
- FL-191 6 mm
- FL-192 8 mm
- FL-193 10 mm
- FL-194 12 mm

LEXER
FL-190/FL-194
180 mm



- FL-210 5 mm
- FL-211 7 mm
- FL-212 10 mm
- FL-213 15 mm
- FL-214 20 mm
- FL-215 25 mm
- FL-216 30 mm

LEXER
FL-210/FL-216
220 mm



- FL-220 5 mm
- FL-221 7 mm
- FL-222 10 mm
- FL-223 15 mm
- FL-224 20 mm
- FL-225 25 mm
- FL-226 30 mm

LEXER
FL-220/FL-226
220 mm



FL-272
220 mm

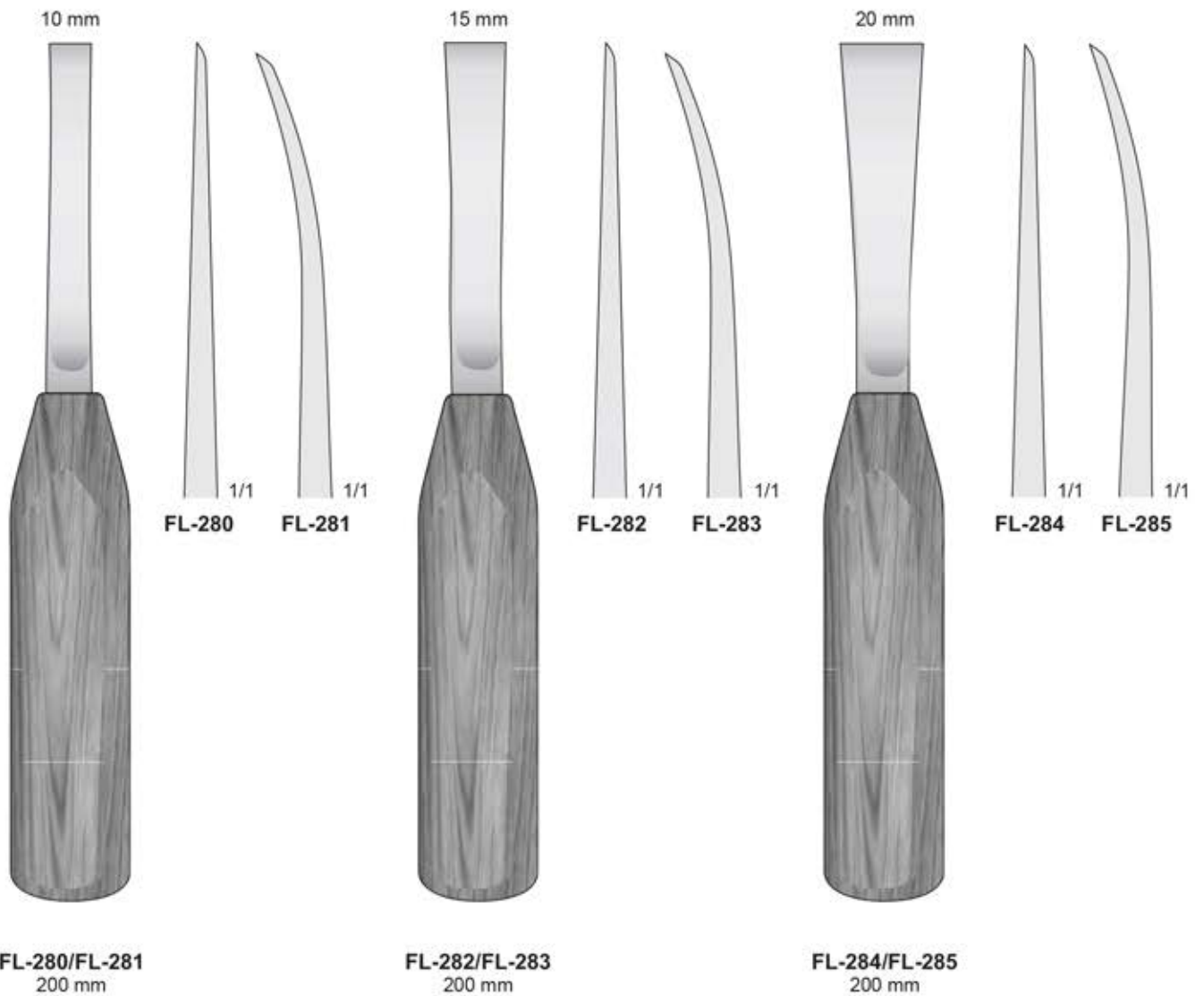

Hohlmeissel - Gouges
Sgorbie - Gubias - Gouges

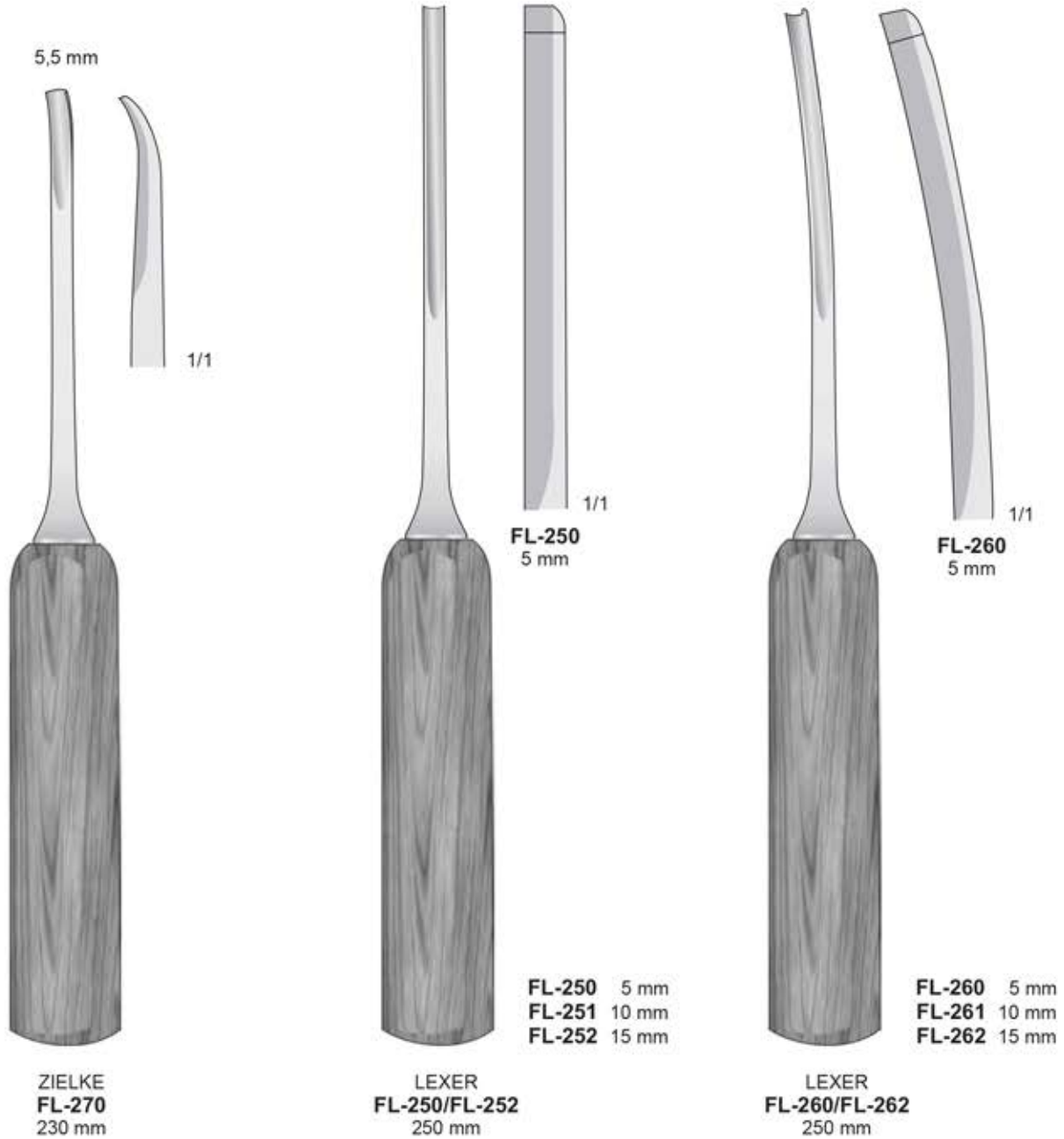

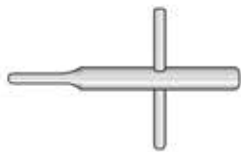

FL-84
90 mm



FL-86
85 mm

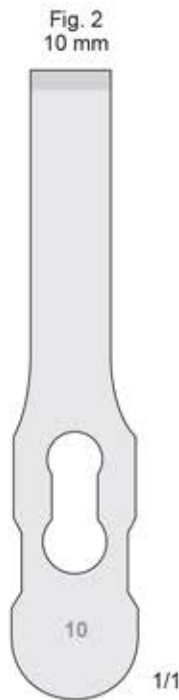

FL-87
85 mm

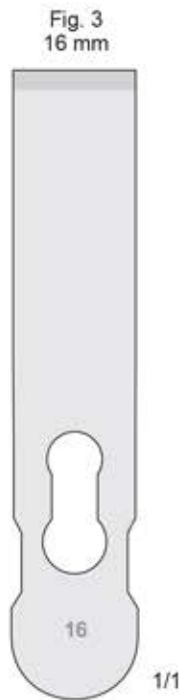

FL-88
85 mm



FL-89
85 mm



Meißel
Chisel
Scalpelli
Cinceles
Ciseaux-burins



FL-85
190 mm



FL-286
85 mm

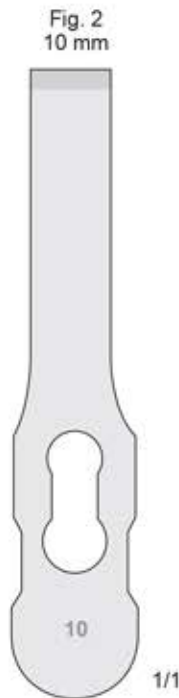

FL-287
85 mm



FL-288
85 mm



FL-289
85 mm



Osteotom
Gouge
Osteotomi
Cubias
Gouges

Bone surgery

Knochenchirurgie

Chirurgie osseuse

Cirugía ósea

Chirurgia ossea

Bone Holding Forceps

Knochenhaltezange

Daviers à os

Pinzas de sujeción para hueso

Pinze per fissare l'osso

Hand Surgery

Handchirurgie

Chirurgie de la main

Cirugía de la mano

Chirurgia della mano

Bone Rongeurs

Hohlmeißelzangen

Pincés gouges

Pinzas gubias

Pinze ossivore

Bone Cutting Scissors

Knochensplitterscheren

Ciseaux à os

Tijeras para huesos

Forbici ossivore

Meniskus und Knorpelfasszangen - Meniscus and cartilage clamp
 Pinze per menisco e cartilagine - Pinces à saisir ménisque et cartilages



DINGMANN
FO-130



DINGMANN MODIF.
FO-131

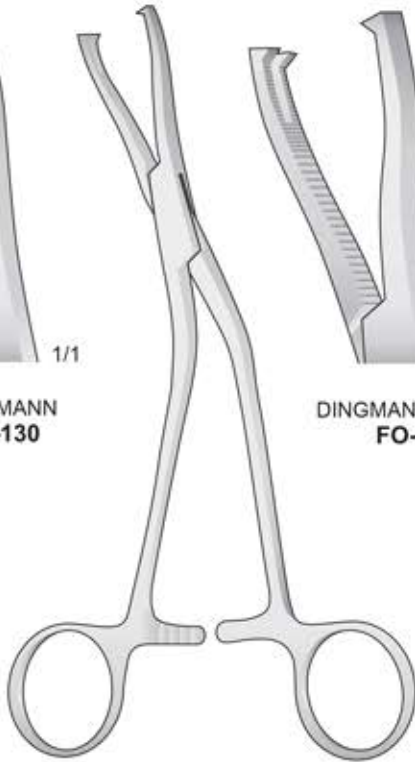

DINGMANN
FO-130/FO-131
190 mm

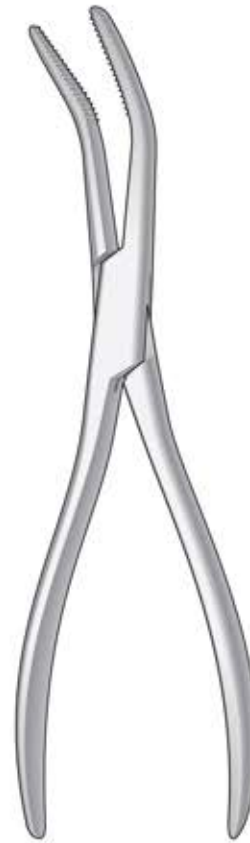

VAN BUREN
FO-217
225 mm

Seitwärts gebogen
Curved to side
Curva su un lato

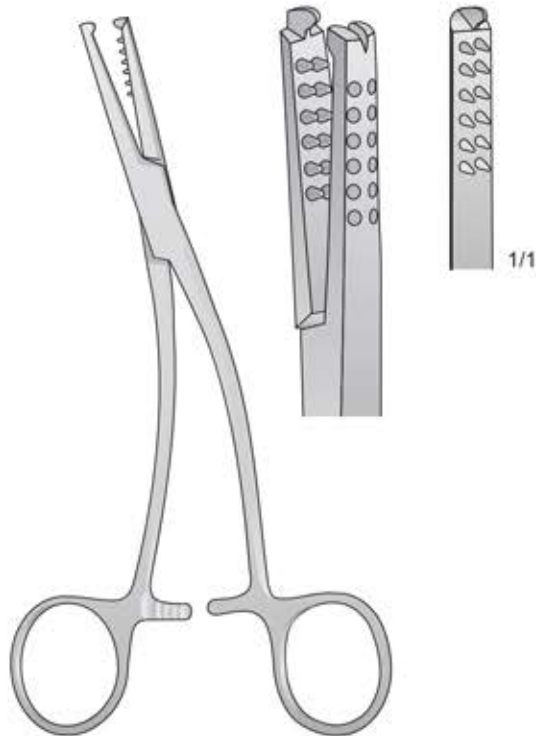

FO-134
185 mm

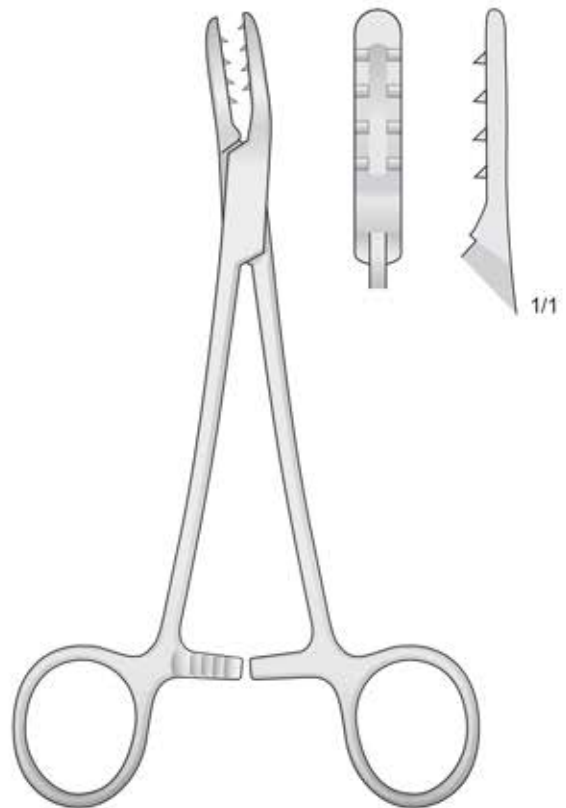

MARTIN
FO-133
200 mm

Repositionszangen - Reposition forceps
Pinze riposizionatrici di osso - Pinzas para la reducción de huesos

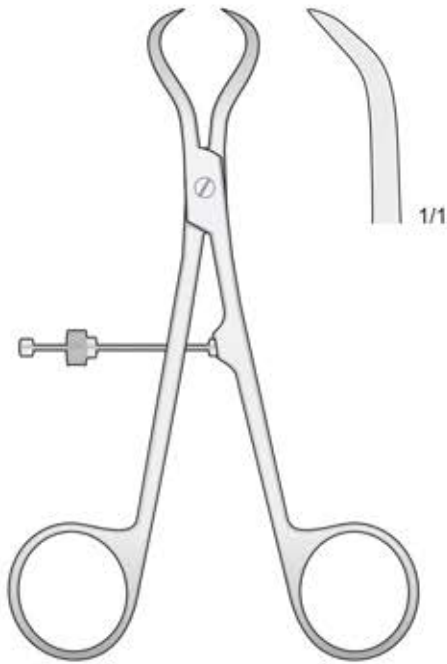

FO-79
140 mm

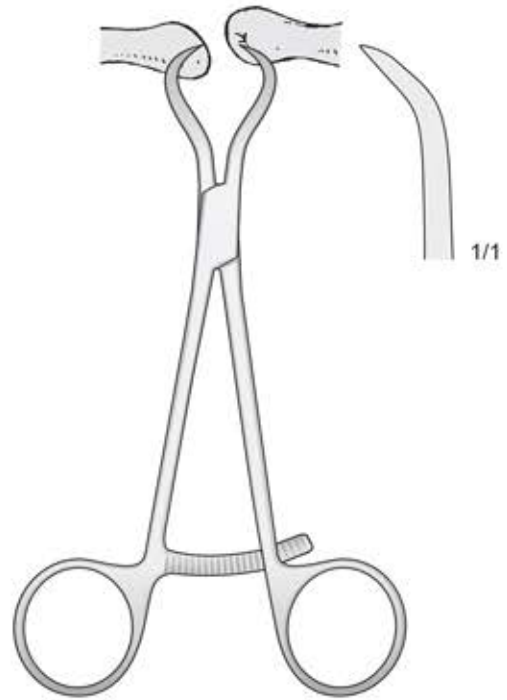

FO-66
135 mm

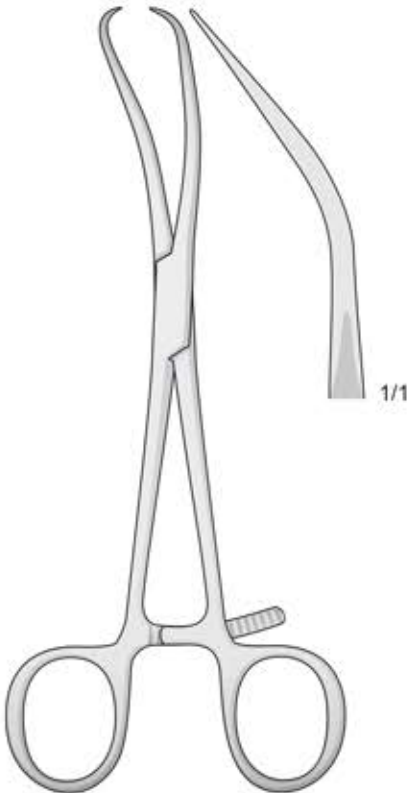

REILL
FO-64
170 mm

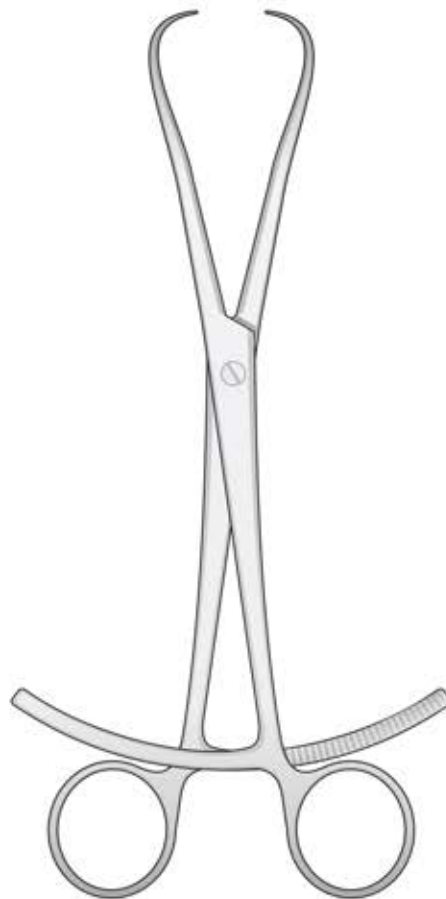

FO-68
200 mm

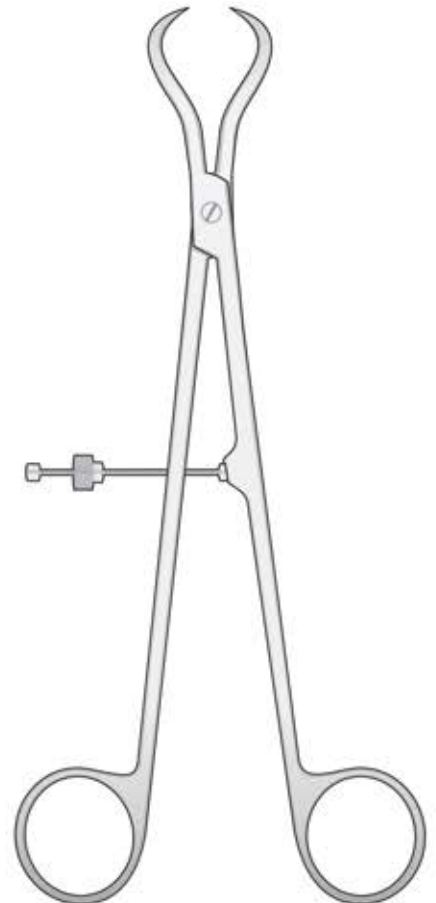

FO-81
210 mm

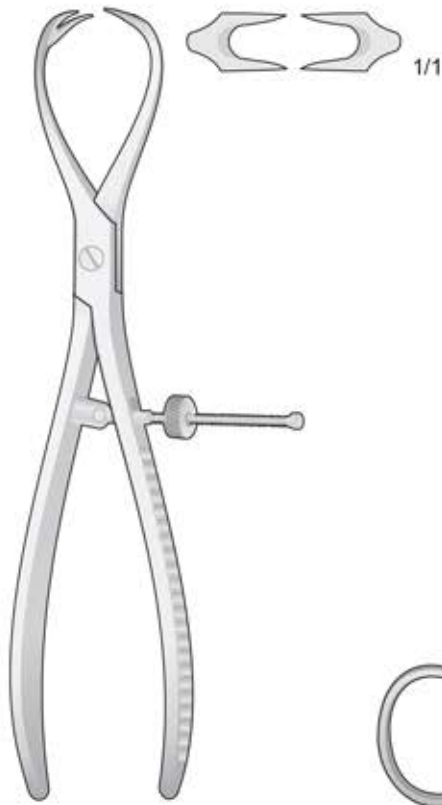

PATELLA
FO-46
185 mm

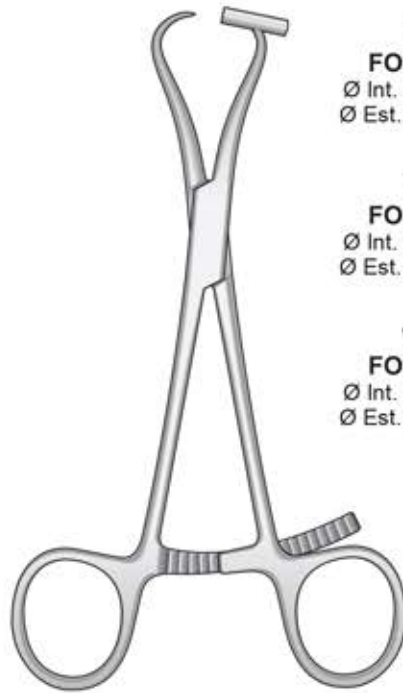

FO-240
Ø Int. 1,0 mm
Ø Est. 2,0 mm

FO-241
Ø Int. 1,3 mm
Ø Est. 2,3 mm

FO-242
Ø Int. 1,6 mm
Ø Est. 2,6 mm

FO-240/FO-242
140 mm

Zange mit Gewindsperre
Forceps with thread fixation
Pinza con regolazione
Davier avec système d'arrêt fileté

Zange mit Zahnsperre
Forceps with ratchet fixation
Pinza con cremagliera
Davier à crémaillère

Zange mit Gewindsperre
Forceps with thread fixation
Pinza con regolazione
Davier avec système d'arrêt fileté



FO-47
140 mm



FO-48
170 mm



FO-49
235 mm

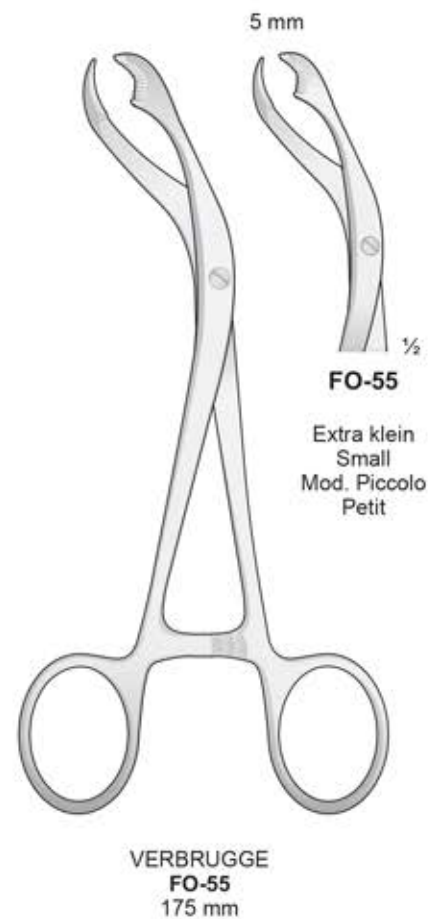
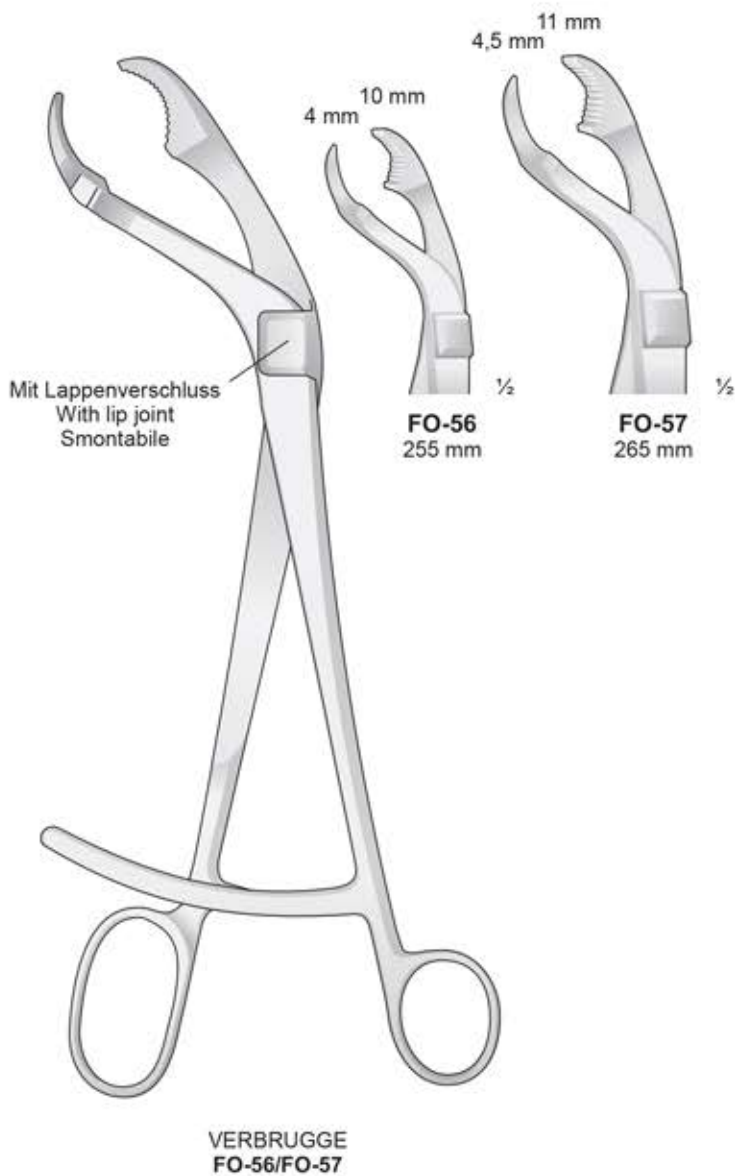

Selbstzentrierend mit Gewindesperre
 Self-centering bone holding forceps with thread lock
 Autocentrante con blocco
 À centrage automatique avec arrêt de filetage

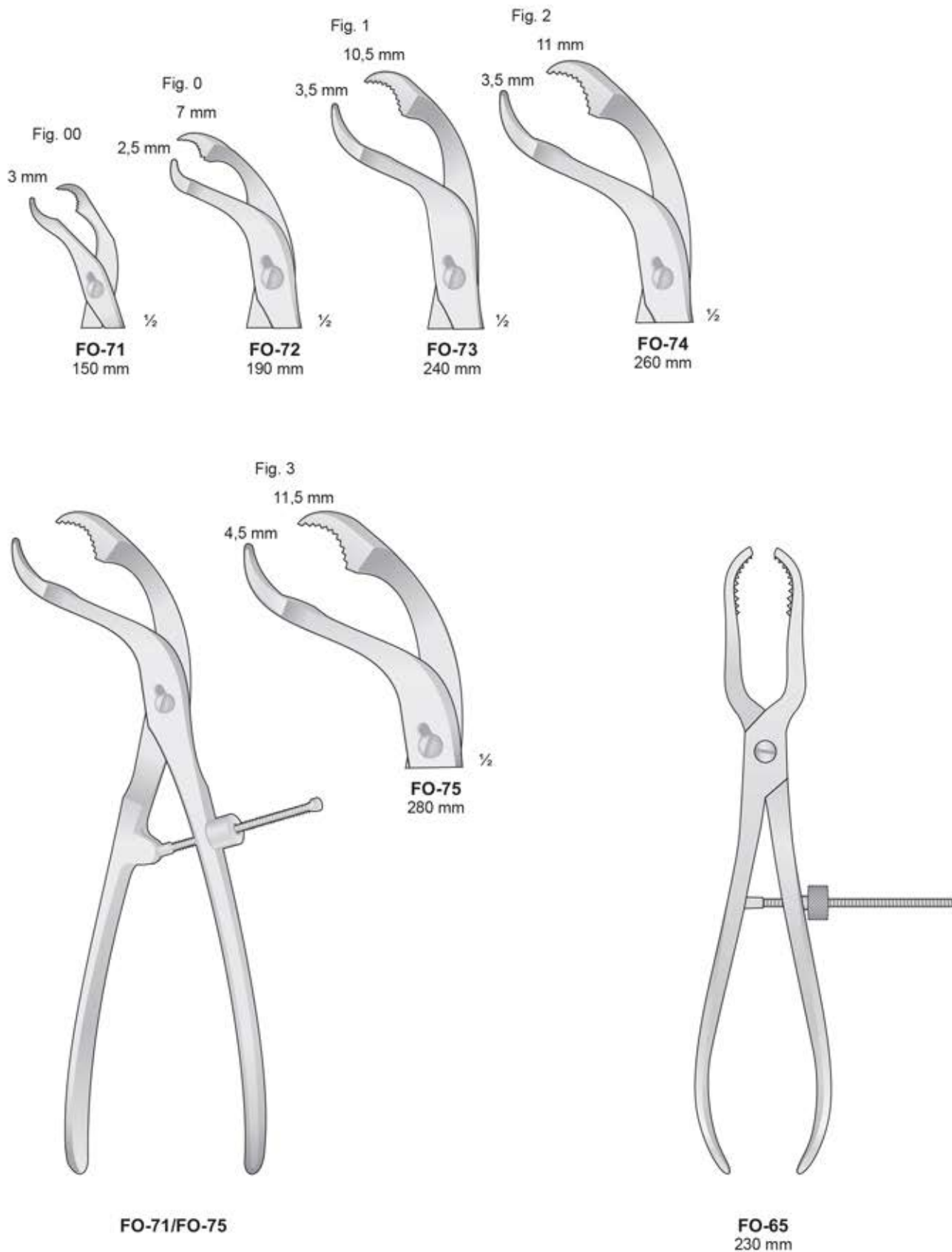



1/1

FO-62
230 mm



1/1

FO-82
250 mm



1/1

FO-105
280 mm

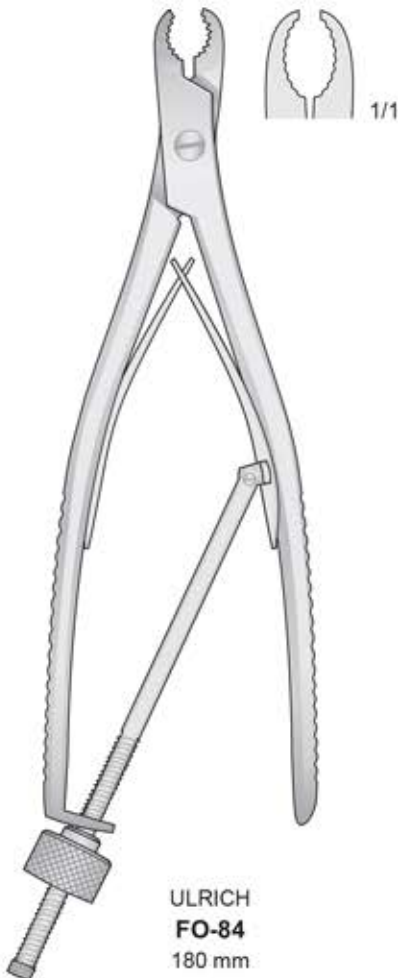

1/1

ULRICH
FO-84
180 mm

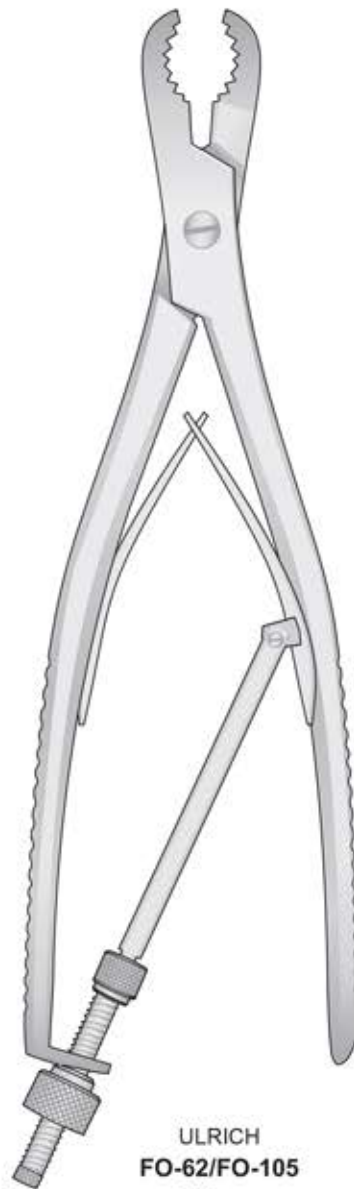

ULRICH
FO-62/FO-105
260 mm



FARABEU-F-LAMBOTTE
FO-52
250 mm

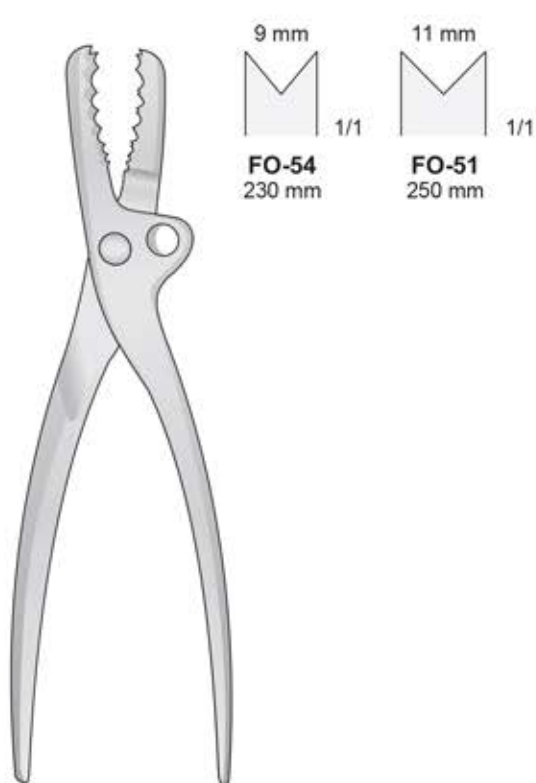

FARABEU
FO-51/FO-54

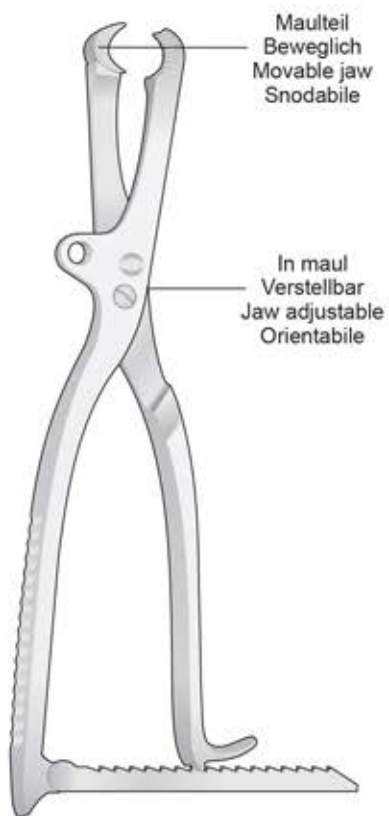

LAMBOTTE
FO-44
265 mm

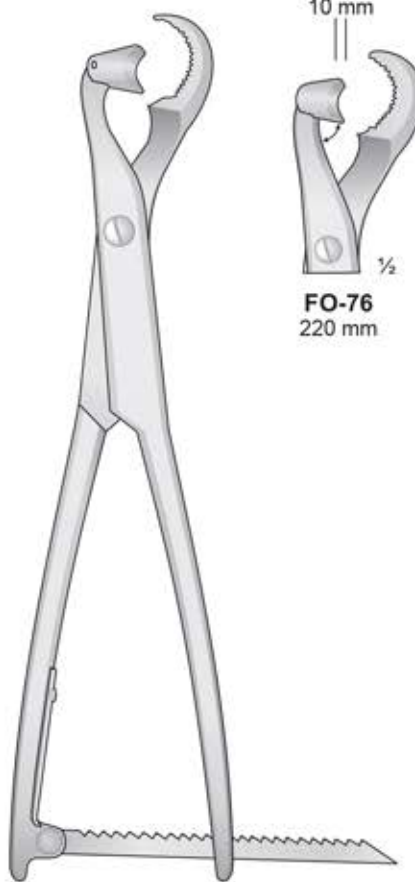

LAMBOTTE
FO-50/FO-76

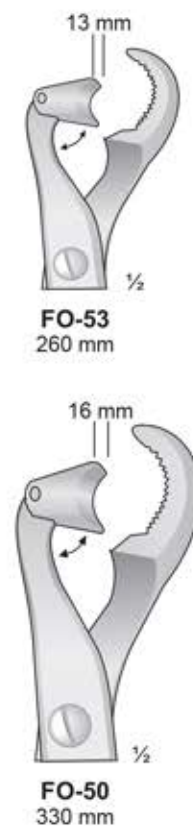

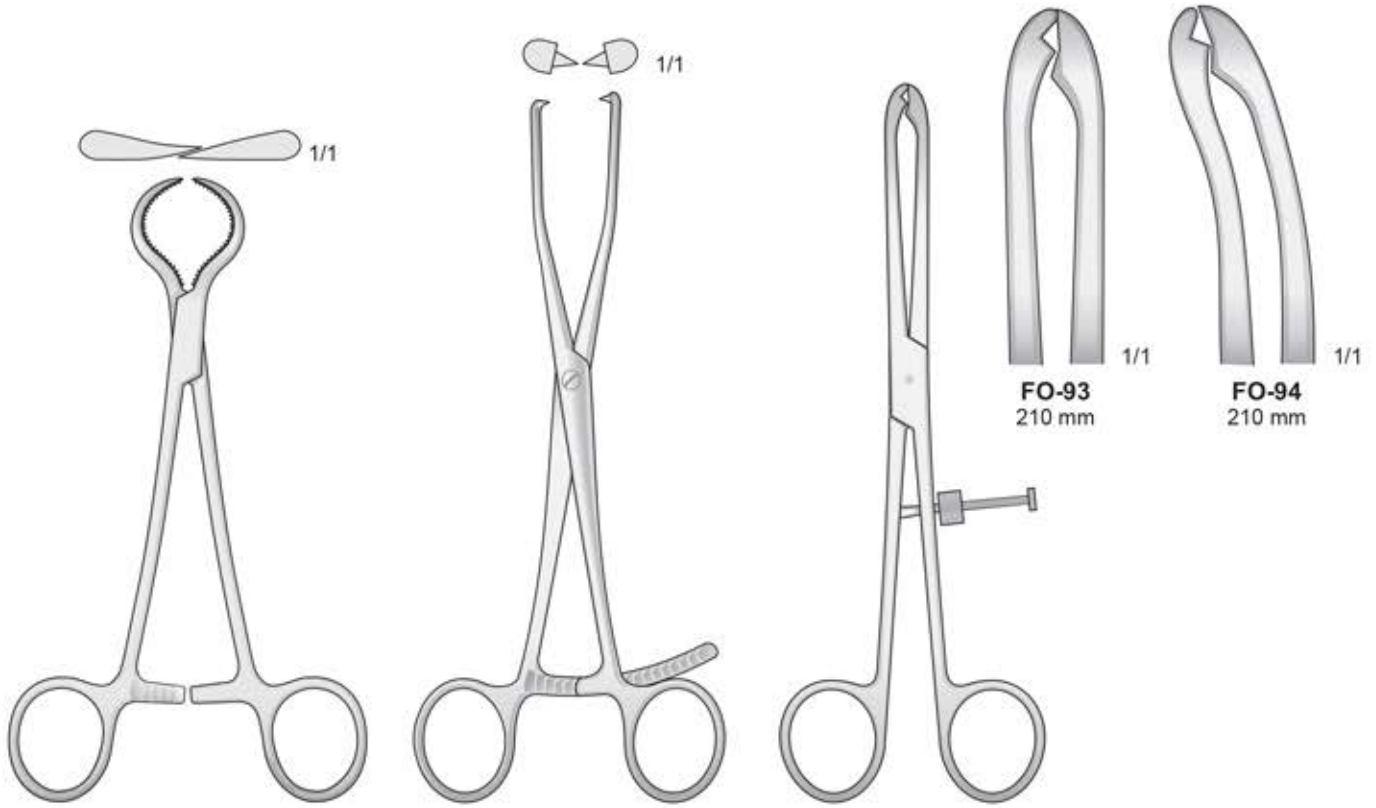

LEWIN
FO-69
180 mm

FO-67
210 mm

FIBULA
FO-93/FO-94
210 mm

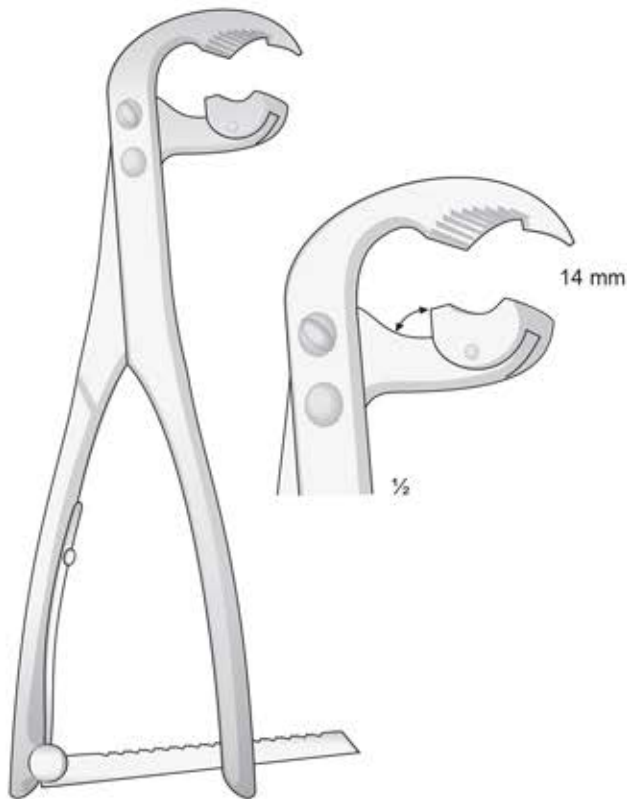

FO-78
215 mm



FO-106
275 mm



1/1

13 mm

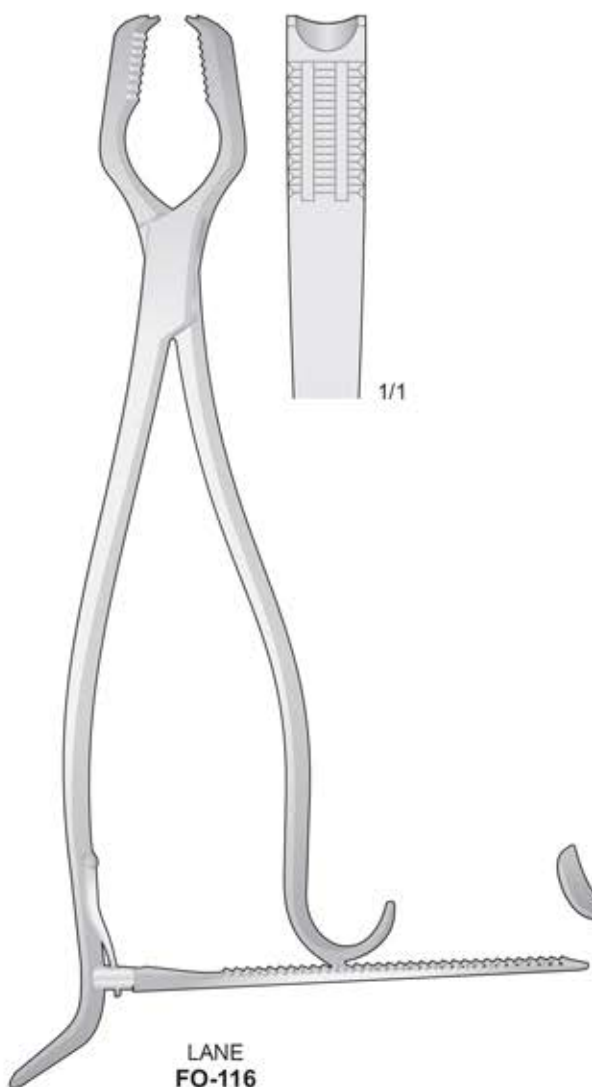

LANE
FO-116
320 mm



SEMB
FO-236
190 mm

8,0 mm



1/1



SEMB
FO-237
190 mm

8,0 mm



1/1

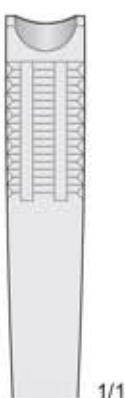

1/1



KERN
FO-114 170 mm
FO-115 220 mm



1/1

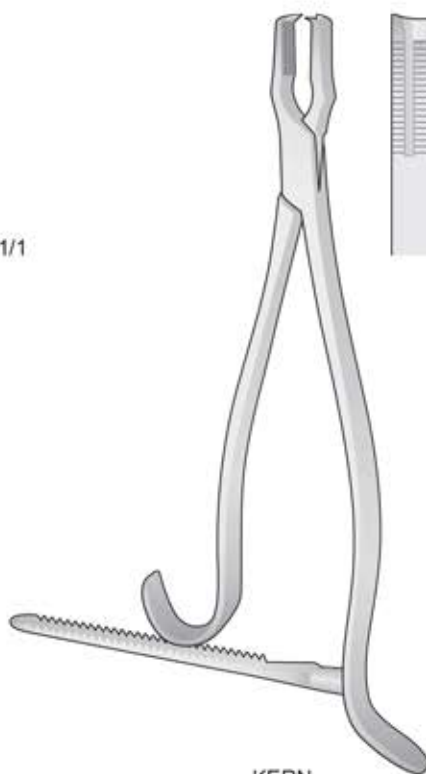

KERN
FO-110 170 mm
FO-112 220 mm



1/1



LANGENBECK
FO-99
200 mm



LANGENBECK
FO-111
205 mm



FERGUSON
FO-113
205 mm

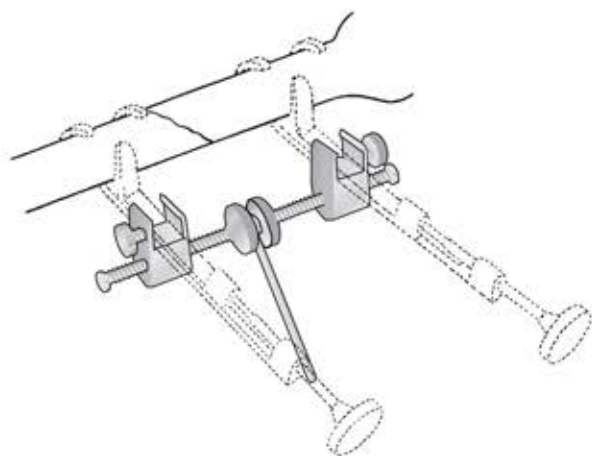

GERSTER
FO-96



PARHAM
FO-98
175 mm

Matrice di ricambio
per FO-98



FO-97
190 mm



GERSTER-LOWMAN
FO-90 120 mm
FO-91 185 mm
FO-92 200 mm

Für kinder
For children
Per bambini
Para niños
Pour enfants



FO-299

Für Erwachsene - For adults - Per adulti
Para adultos - Pour adultes

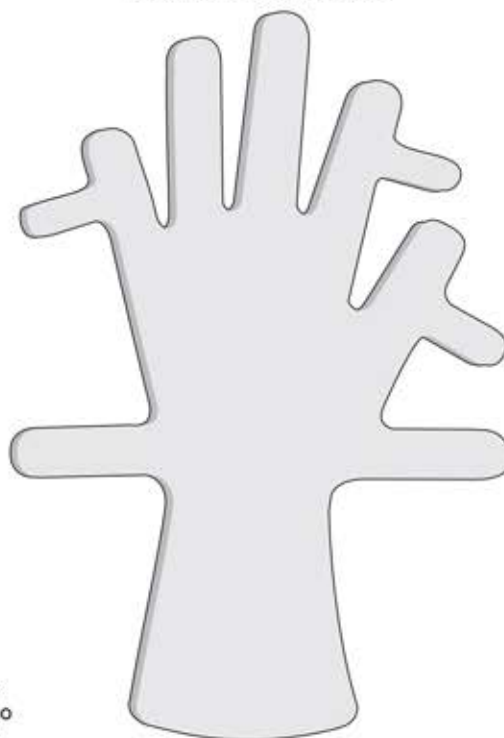

FO-300

Bleihände
Lead hands
Mani di piombo
Manos de plombo
Main de plomb

Fingerringsägen - Forceps for opening rings
Pinza taglia anelli - Sierra para anillos - Scies pour bagues

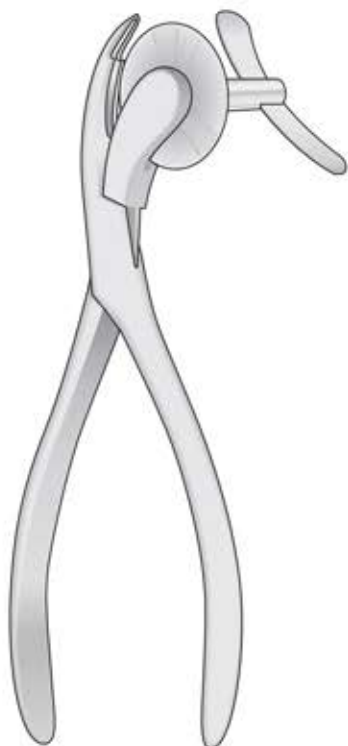

FO-80
170 mm

Nagel -Ausreisszange
Nail extracting forceps
Pinza per estrazione delle unghie
Pinzas para arrancar uñas
Pince pour extraire les ongles

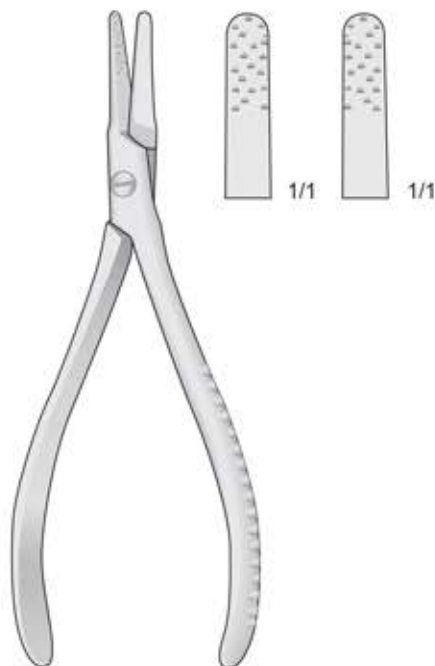

**RADOLF
FO-159**
135 mm

Nagelspaltzange
Nail nipper
Pinza per unghie
Pinzas corta uñas
Pince à ongles

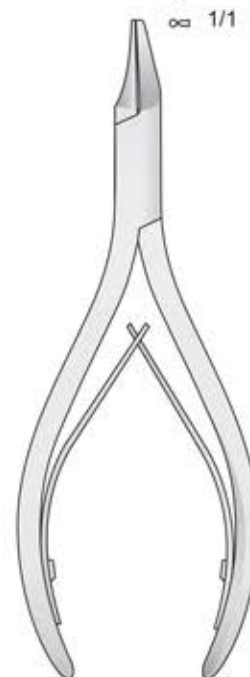

DP-09
135 mm

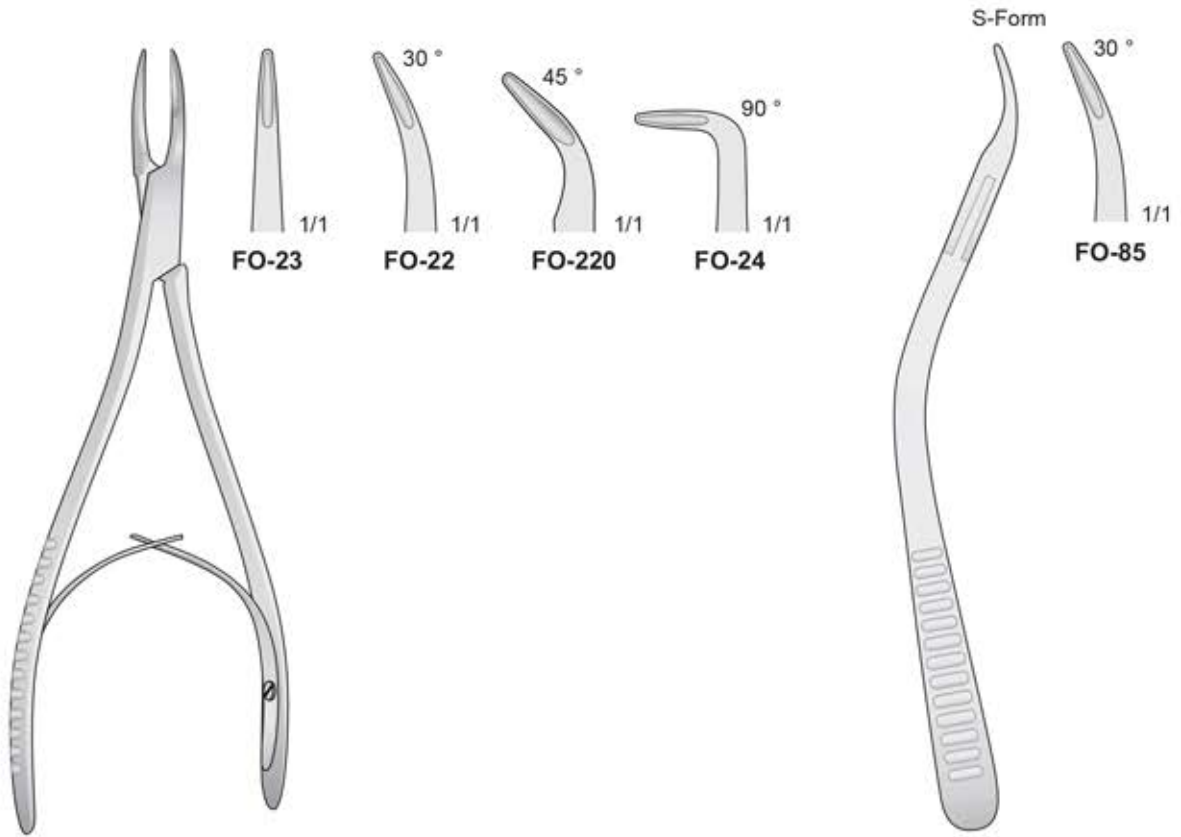

MINI-FRIEDMANN
FO-22/FO-220
150 mm

MINI-FRIEDMANN
FO-85
145 mm

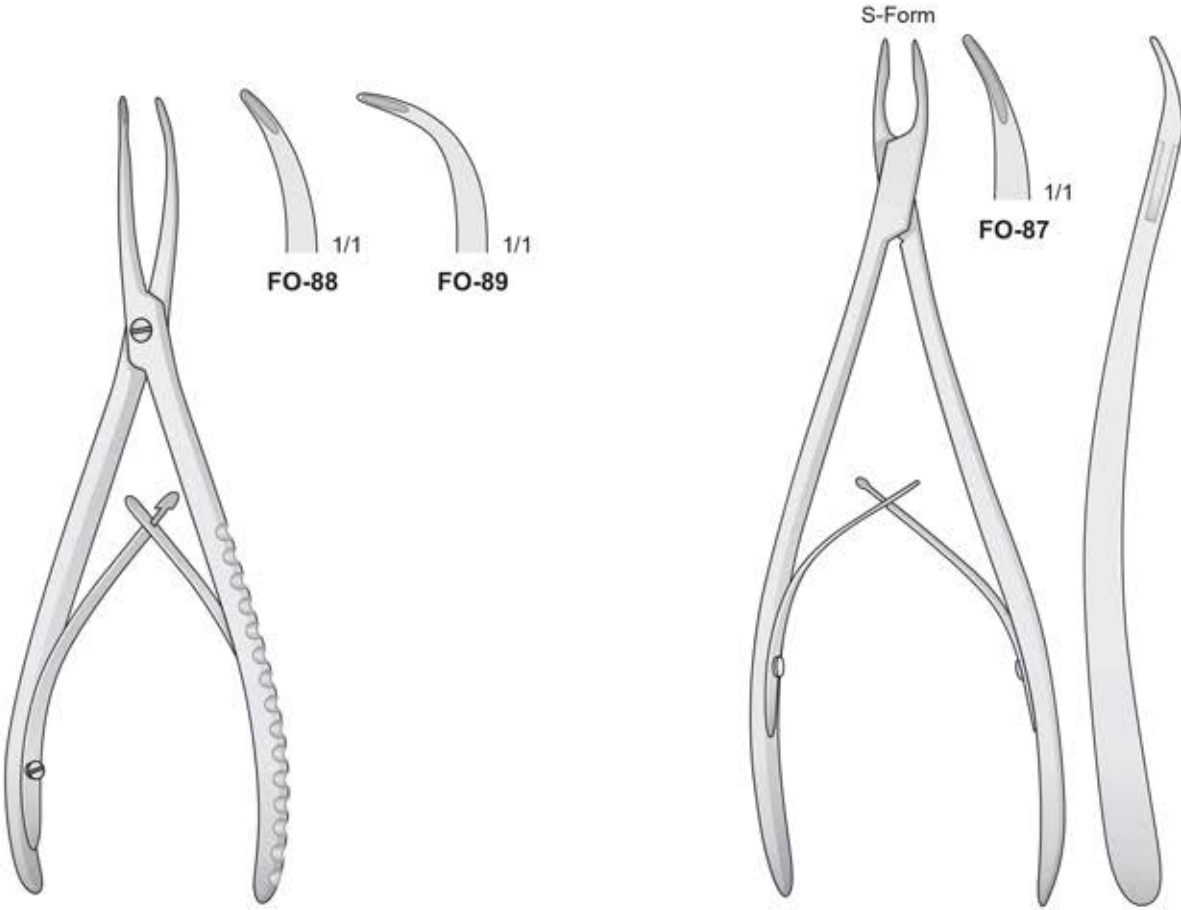

STELLBRINK
FO-88/FO-89
170 mm

STELLBRINK
FO-87
190 mm

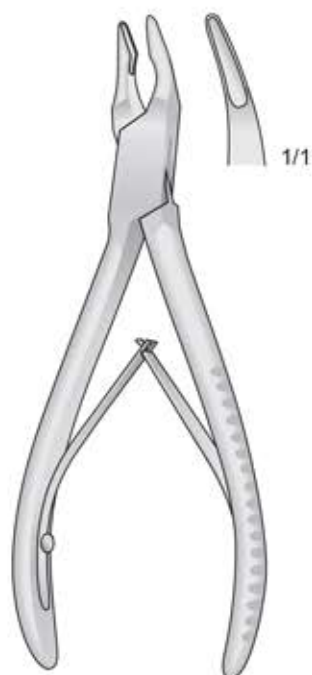

MINI FRIEDMANN
FO-15
120 mm

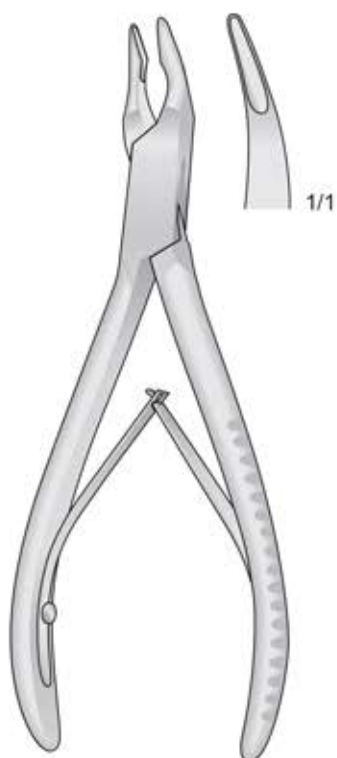

FRIEDMANN
FO-17
140 mm

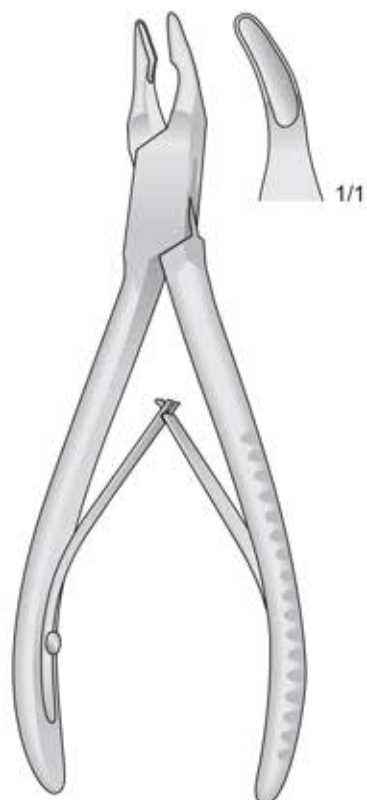

BLUMENTHAL
FO-19
155 mm



MEAD
FO-21
165 mm

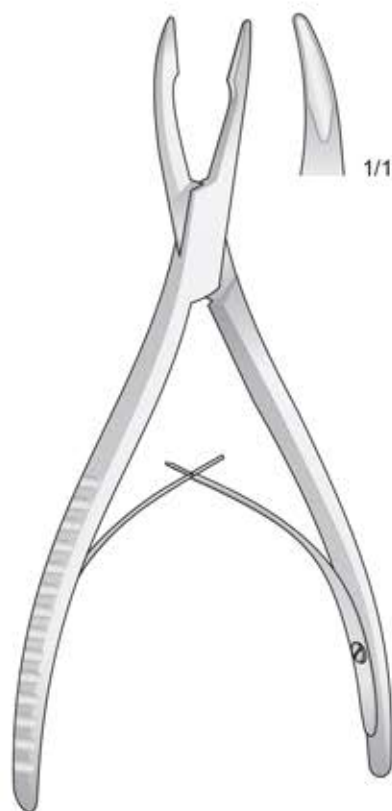

FRIEDMANN
FO-16
160 mm



LUER
FO-18
155 mm

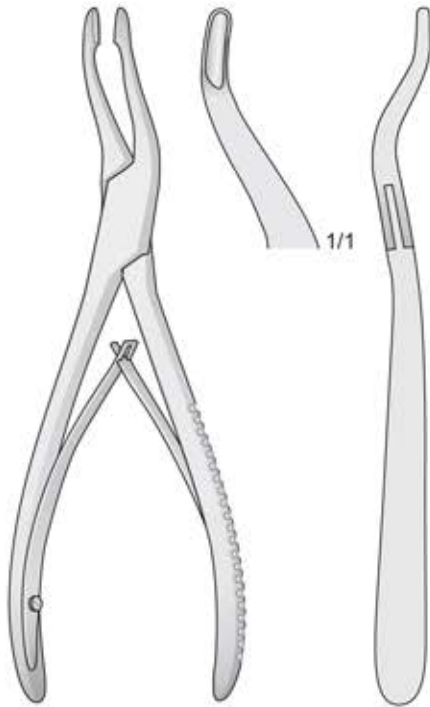

ALEXANDER
FO-27
140 mm

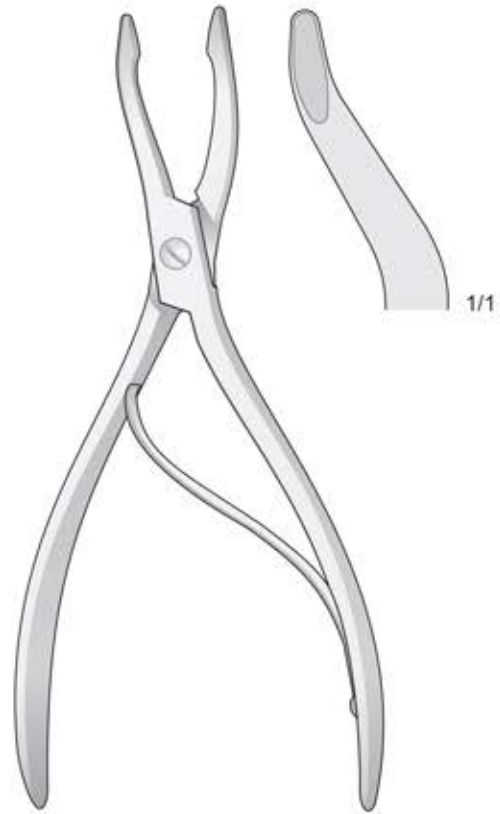

JANSEN-LEUER
FO-10
180 mm

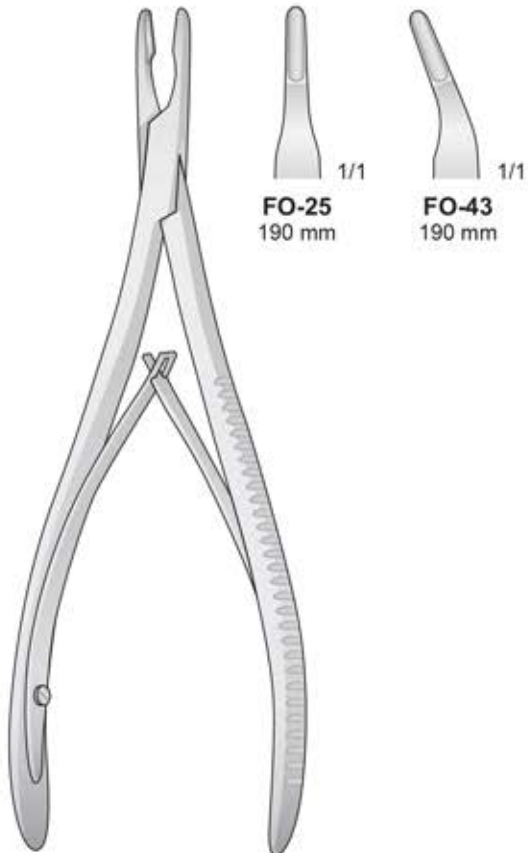

LEMPERT
FO-25/FO-43
190 mm

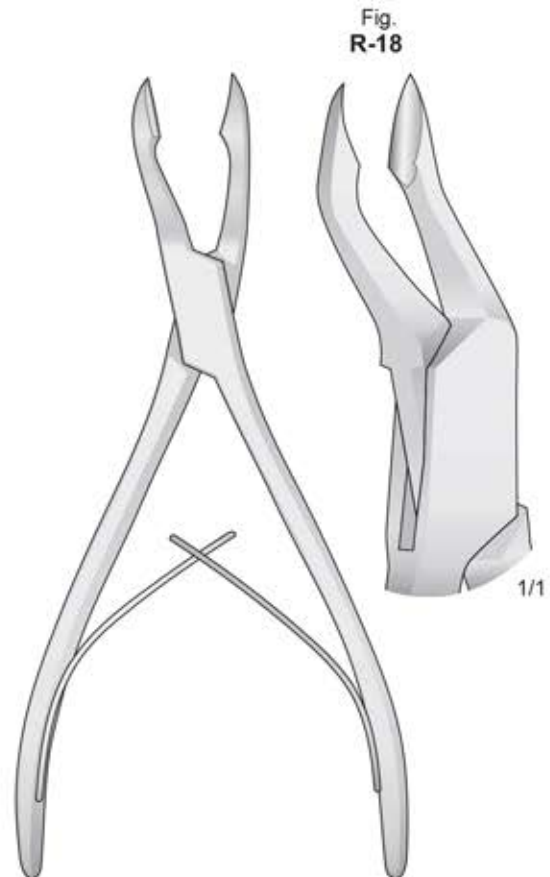

FO-33
175 mm

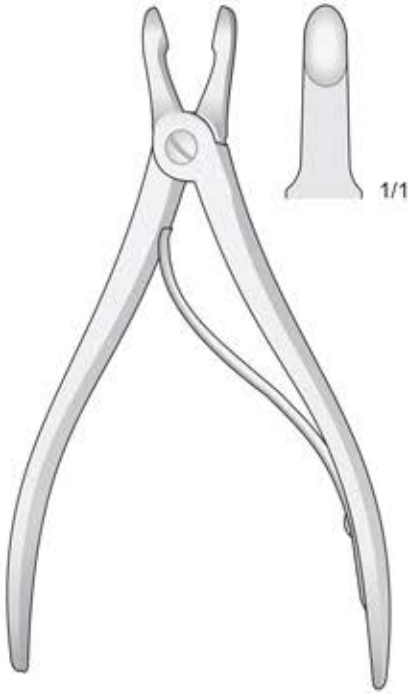

HARTMANN
FO-14
155 mm

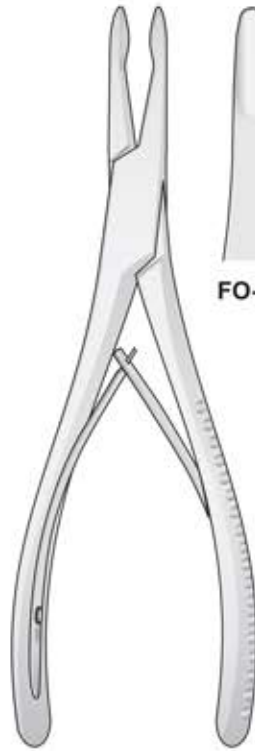

JANSEN
FO-37/FO-39
170 mm

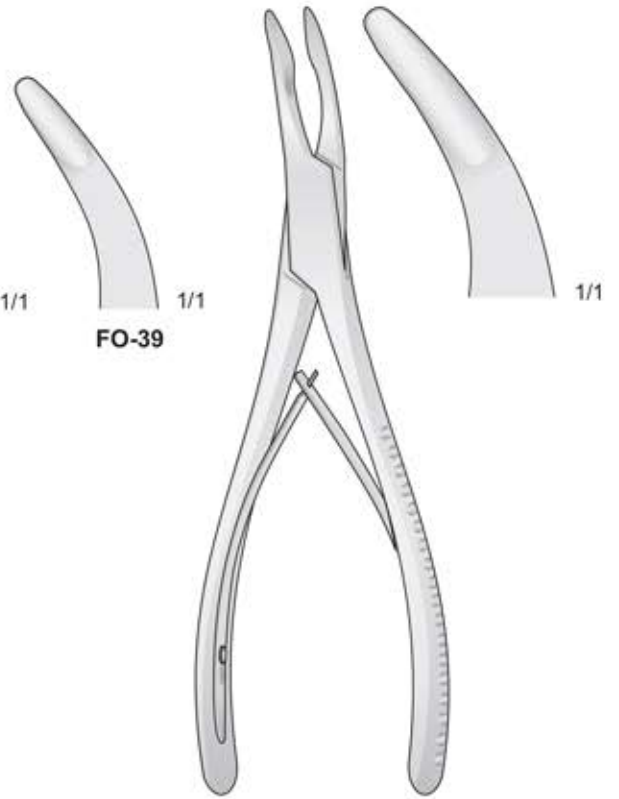

OLIVECRONA
FO-45
190 mm

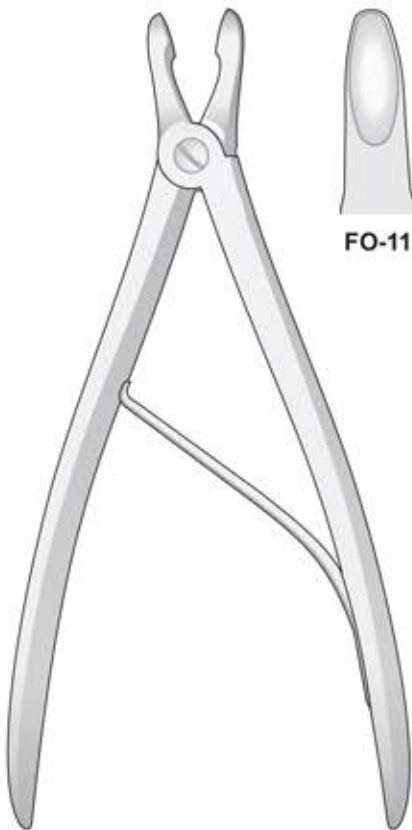

CUSHING
FO-11/FO-12
190 mm



FO-11



FO-12

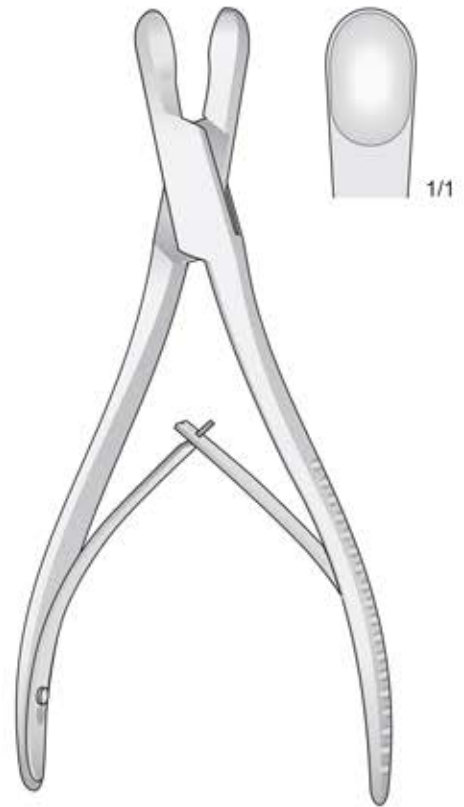

LUER-STILLE
FO-13
185 mm



CLEVELAND
FO-231 140 mm
FO-232 170 mm



CLEVELAND
FO-233 150 mm
FO-234 170 mm

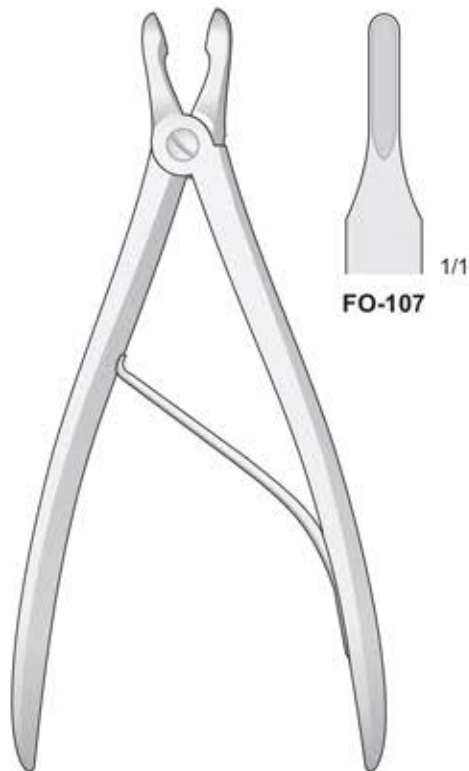

CUSHING
FO-107/FO-109
190 mm

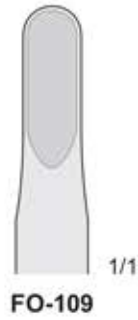

FO-109



FO-147



FO-149

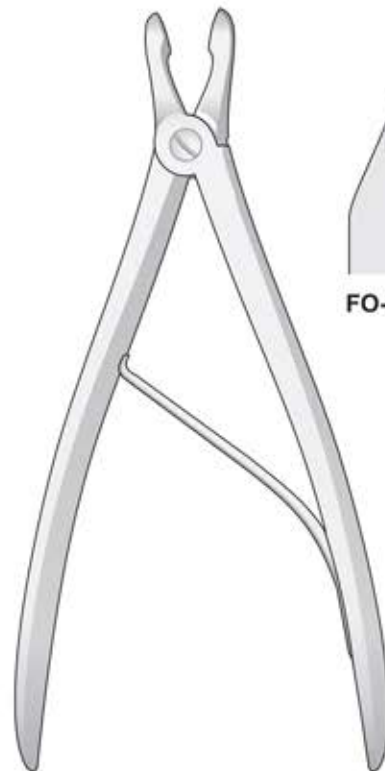

CUSHING
FO-147/FO-149
190 mm

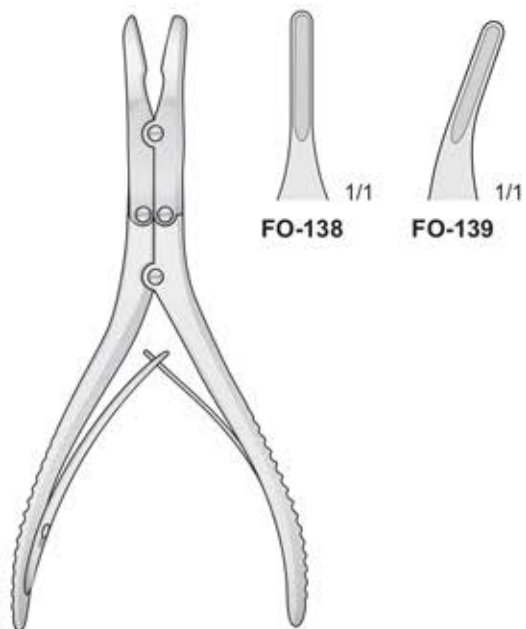

FO-138 1/1
FO-139 1/1

RUSKIN
FO-138/FO-139
150 mm

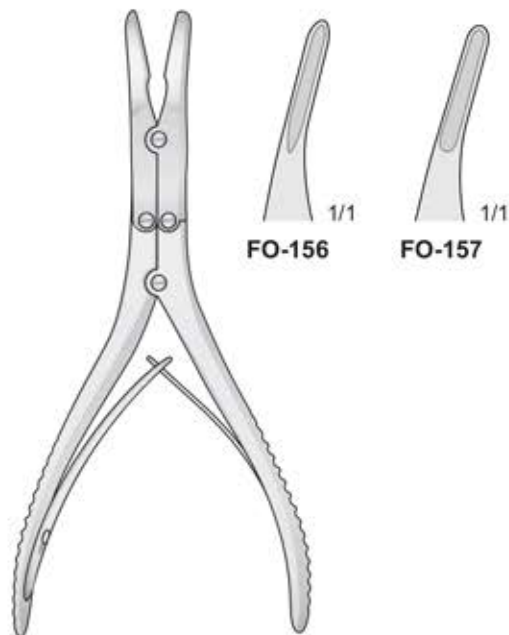

FO-156 1/1
FO-157 1/1

KLEINERT-KUTZ
FO-156/FO-157
155 mm

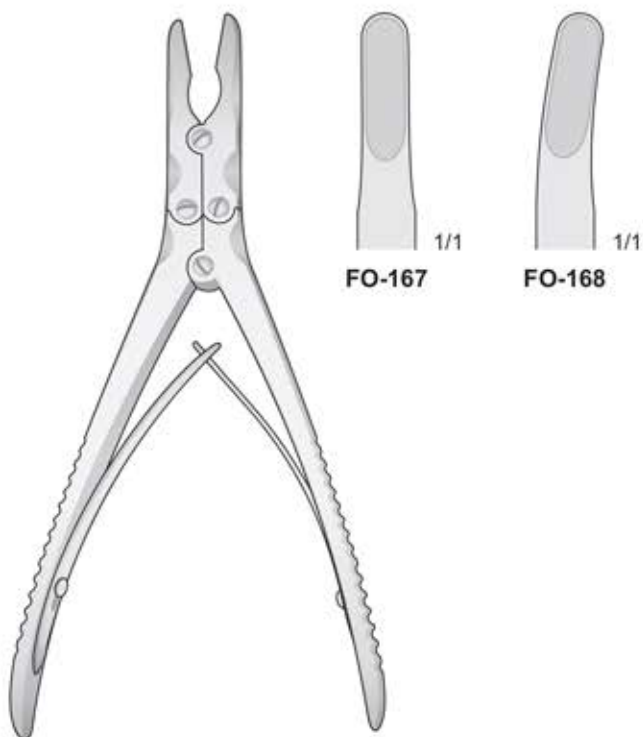

FO-167 1/1
FO-168 1/1

RUSKIN
FO-167/FO-168
185 mm

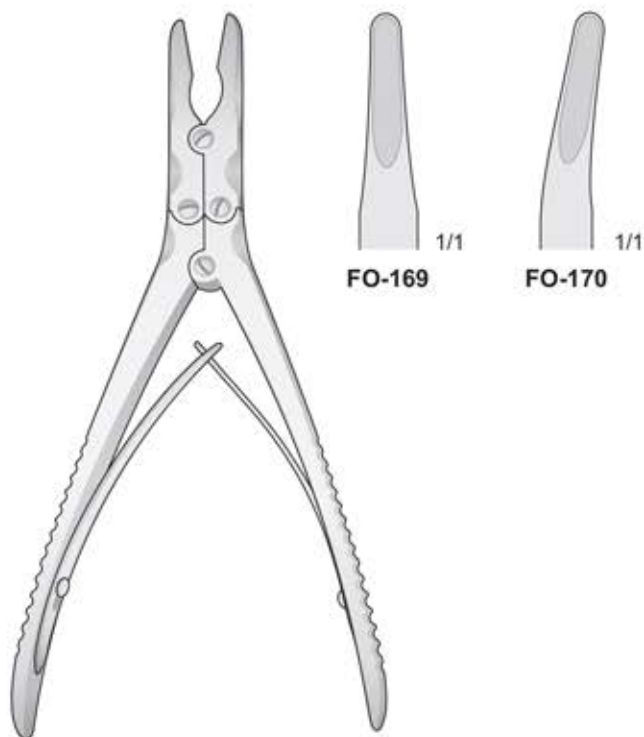

FO-169 1/1
FO-170 1/1

RUSKIN
FO-169/FO-170
185 mm

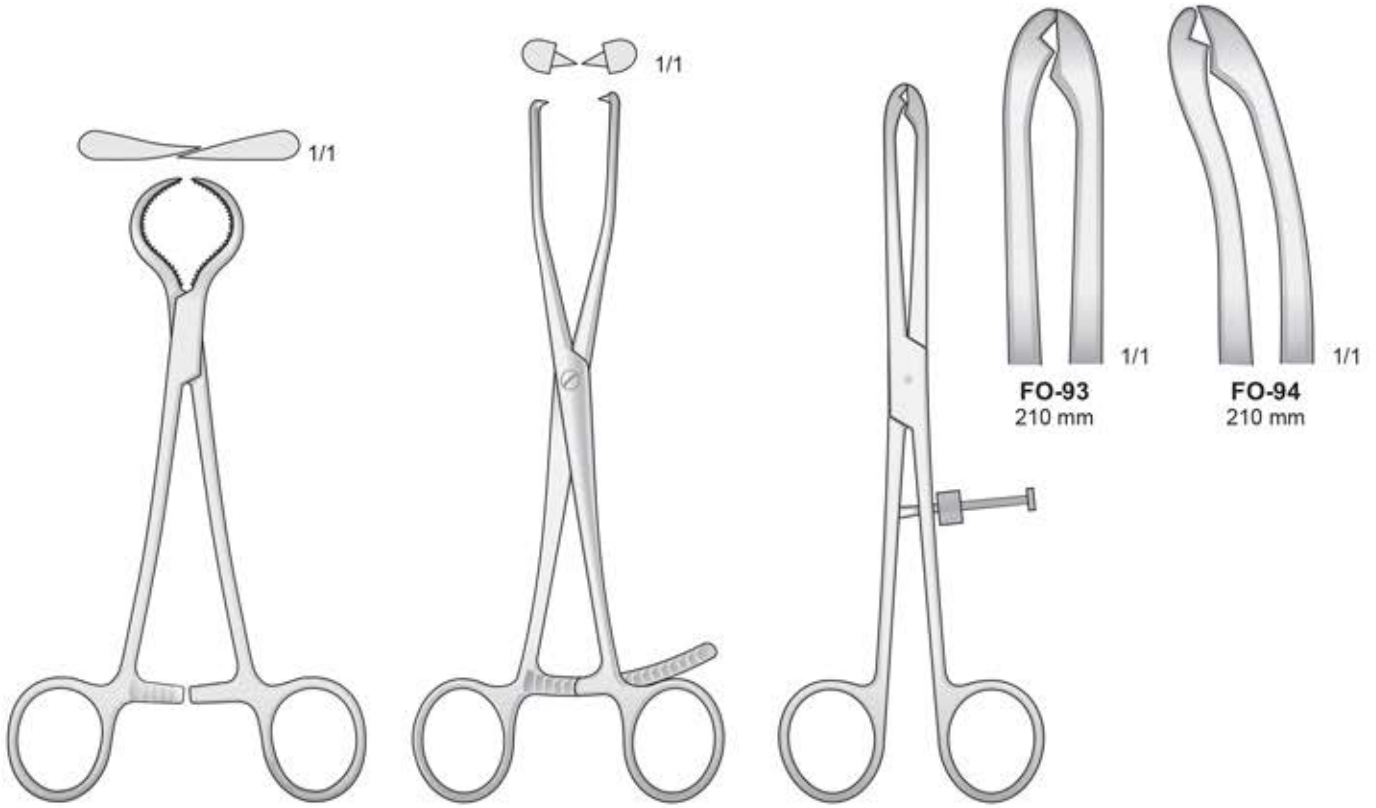

LEWIN
FO-69
180 mm

FO-67
210 mm

FIBULA
FO-93/FO-94
210 mm

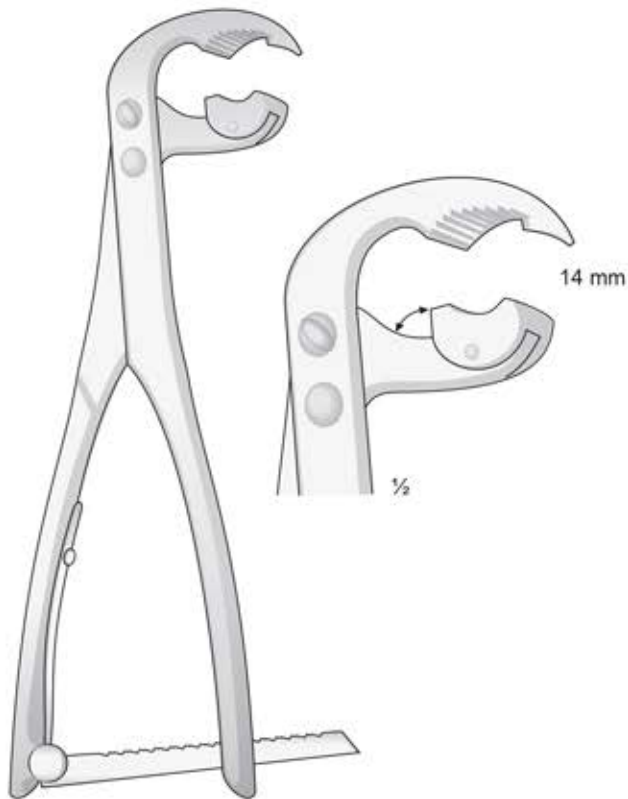

FO-78
215 mm



FO-106
275 mm

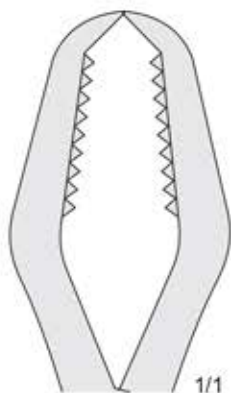

1/1

13 mm

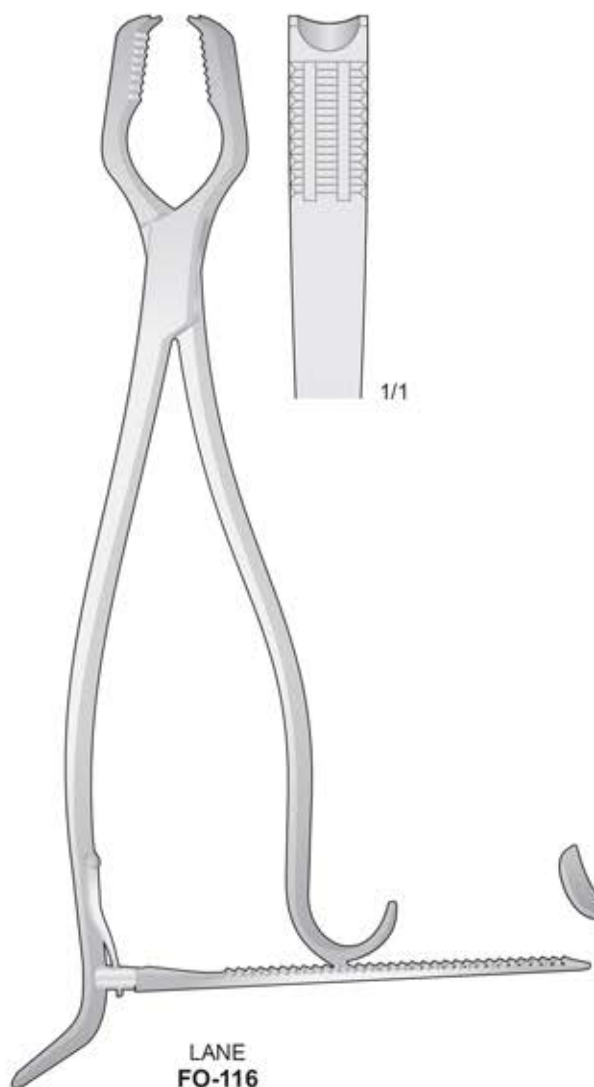

LANE
FO-116
320 mm



SEMB
FO-236
190 mm

8,0 mm



1/1



SEMB
FO-237
190 mm

8,0 mm



1/1



KERN
FO-114 170 mm
FO-115 220 mm



1/1

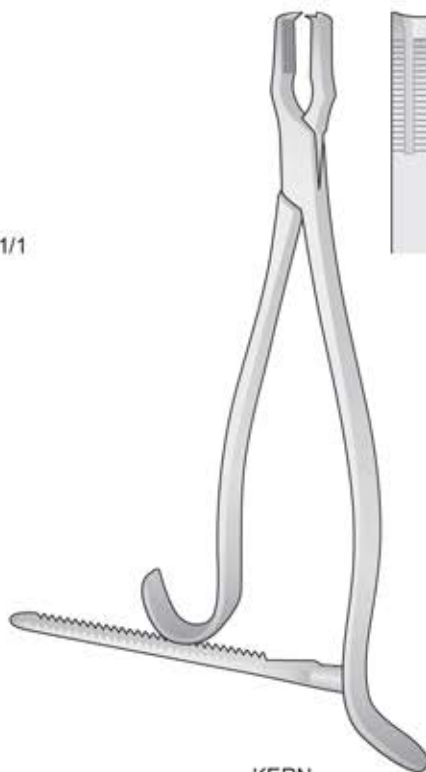

KERN
FO-110 170 mm
FO-112 220 mm



1/1



LANGENBECK
FO-99
200 mm



LANGENBECK
FO-111
205 mm



FERGUSON
FO-113
205 mm

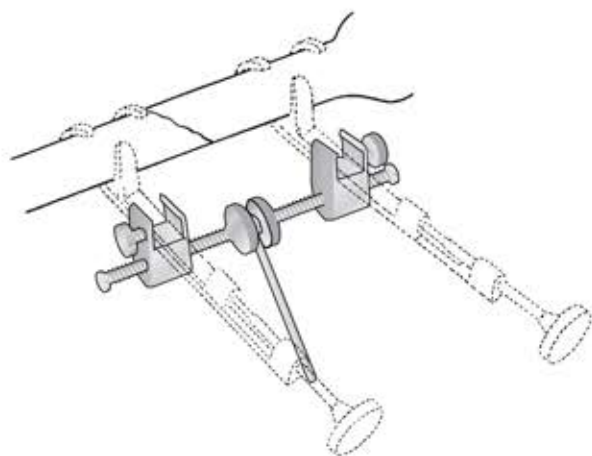

GERSTER
FO-96



PARHAM
FO-98
175 mm

Matrice di ricambio
per FO-98



FO-97
190 mm



GERSTER-LOWMAN
FO-90 120 mm
FO-91 185 mm
FO-92 200 mm

Für kinder
For children
Per bambini
Para niños
Pour enfants



FO-299

Für Erwachsene - For adults - Per adulti
Para adultos - Pour adultes



FO-300

Bleihände
Lead hands
Mani di piombo
Manos de plombo
Main de plomb

Fingerringsägen - Forceps for opening rings
Pinza taglia anelli - Sierra para anillos - Scies pour bagues

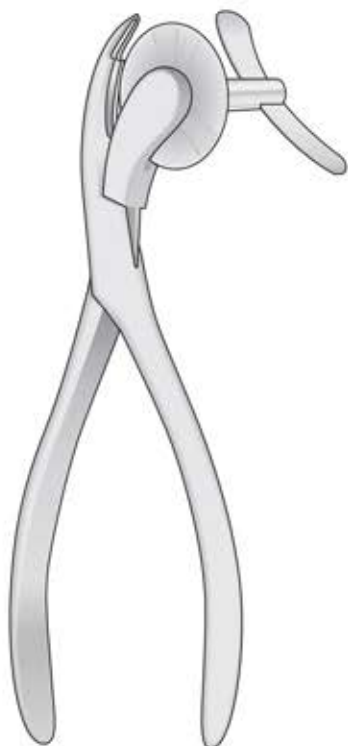

FO-80
170 mm

Nagel -Ausreisszange
Nail extracting forceps
Pinza per estrazione delle unghie
Pinzas para arrancar uñas
Pince pour extraire les ongles

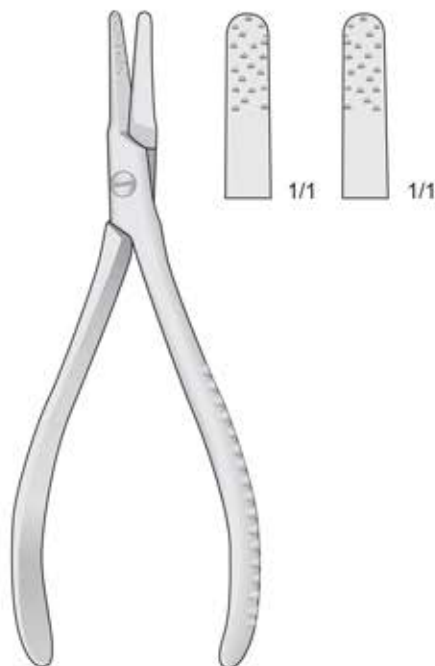

**RADOLF
FO-159**
135 mm

Nagelspaltzange
Nail nipper
Pinza per unghie
Pinzas corta uñas
Pince à ongles

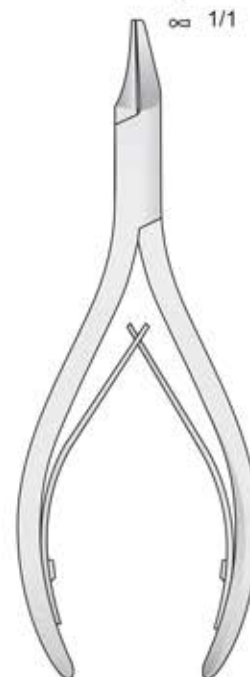

DP-09
135 mm

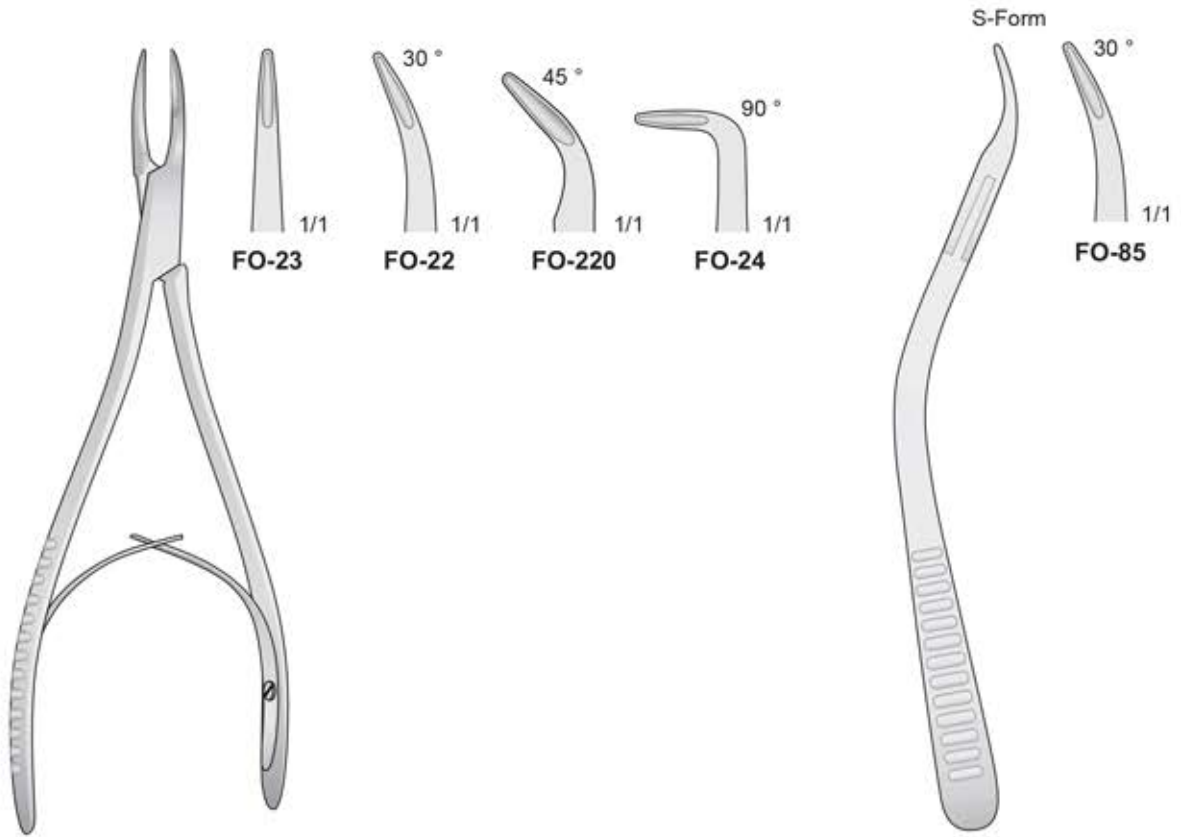

MINI-FRIEDMANN
FO-22/FO-220
150 mm

MINI-FRIEDMANN
FO-85
145 mm

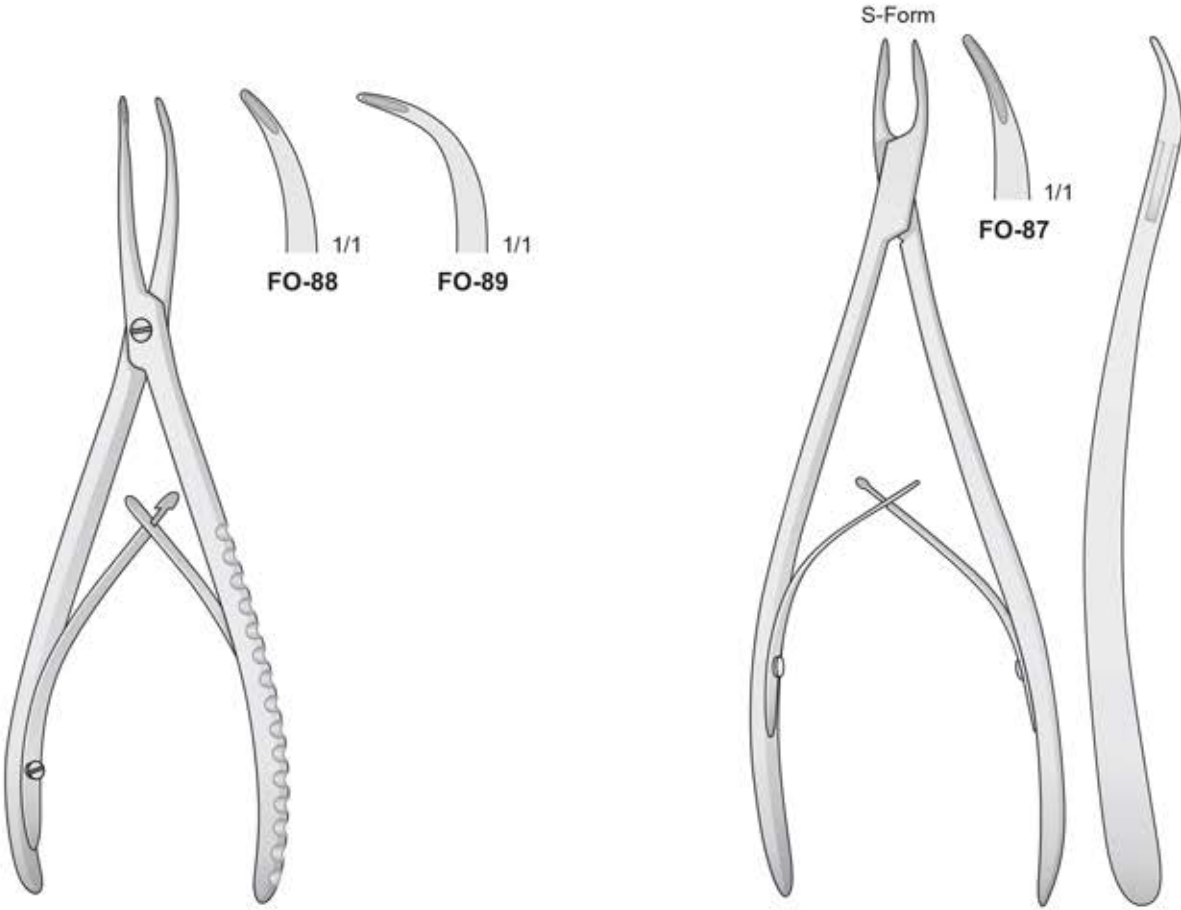

STELLBRINK
FO-88/FO-89
170 mm

STELLBRINK
FO-87
190 mm

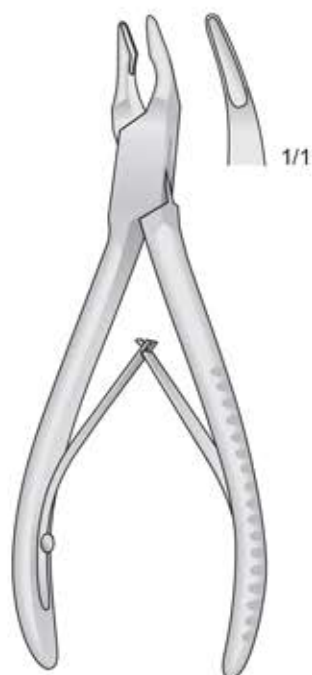

MINI FRIEDMANN
FO-15
120 mm

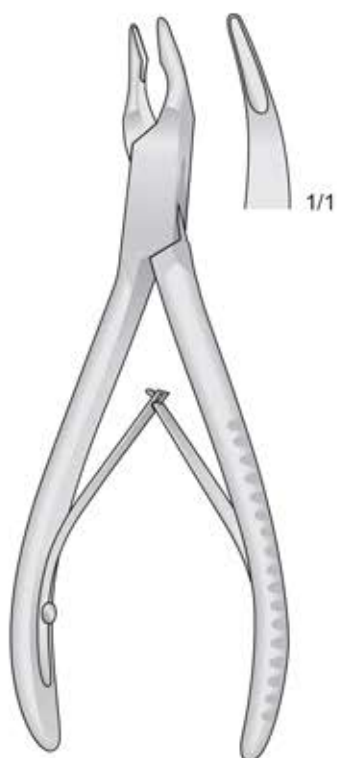

FRIEDMANN
FO-17
140 mm

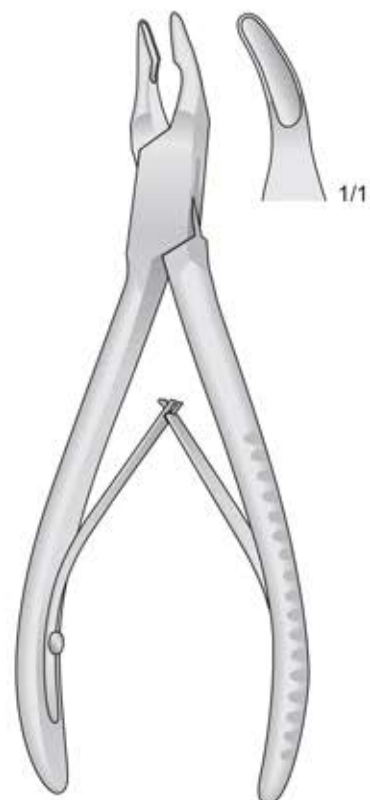

BLUMENTHAL
FO-19
155 mm

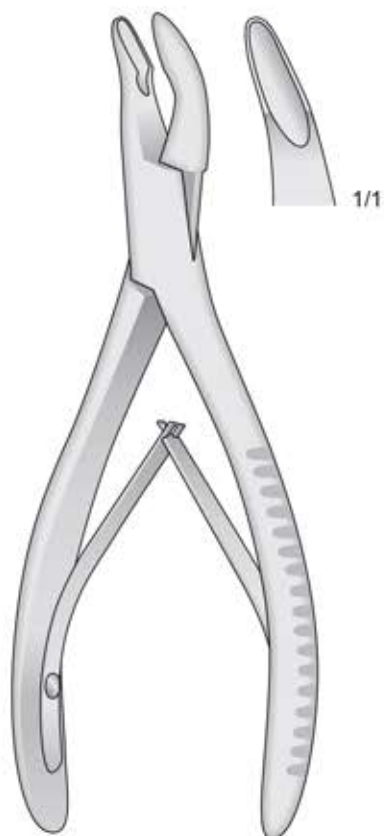

MEAD
FO-21
165 mm

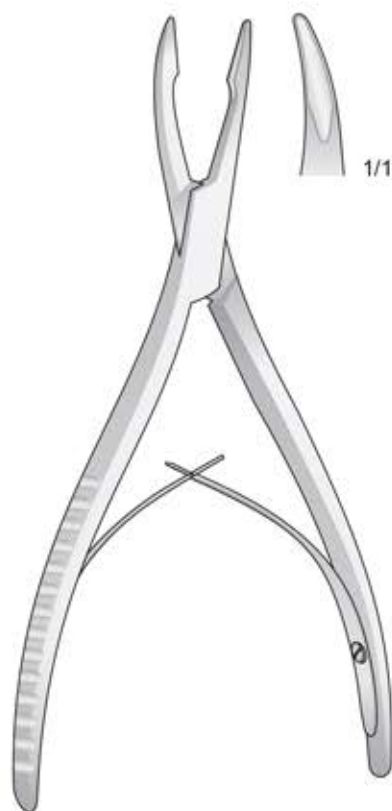

FRIEDMANN
FO-16
160 mm



LUER
FO-18
155 mm

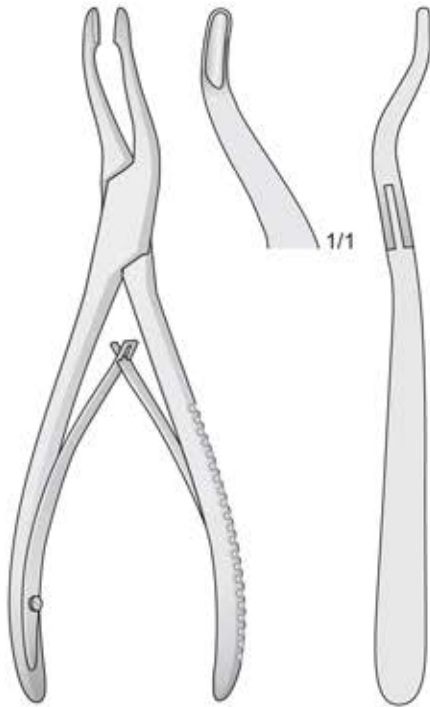

ALEXANDER
FO-27
140 mm

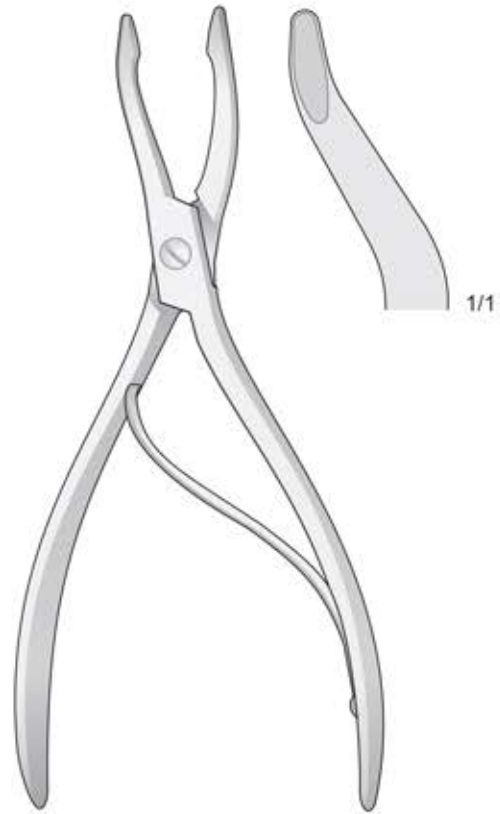

JANSEN-LEUER
FO-10
180 mm

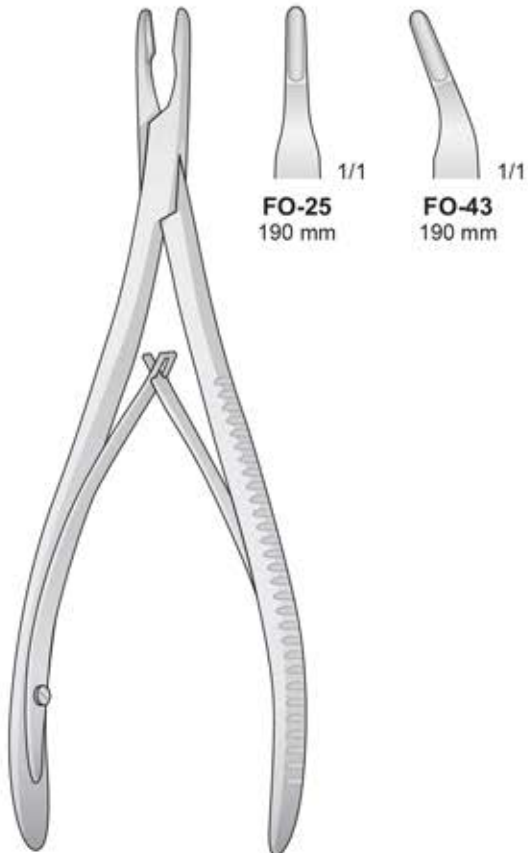

LEMPERT
FO-25/FO-43
190 mm

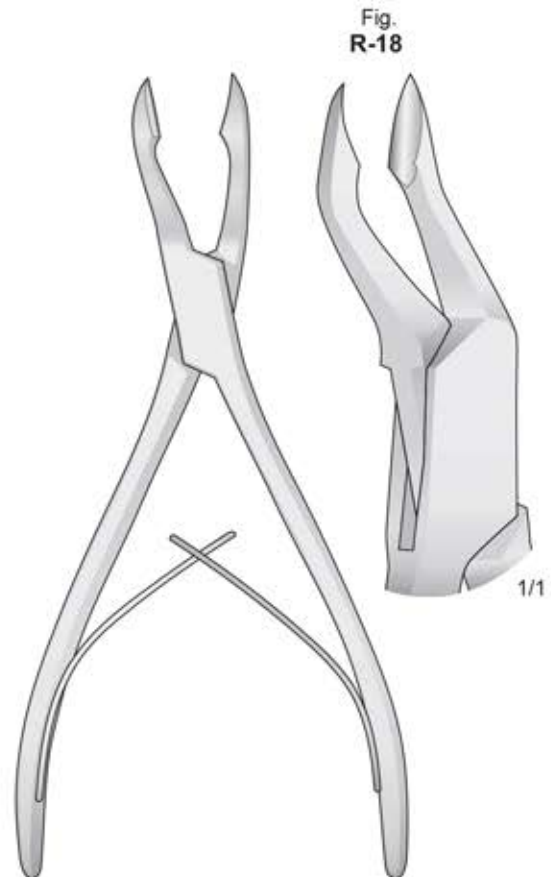

FO-33
175 mm

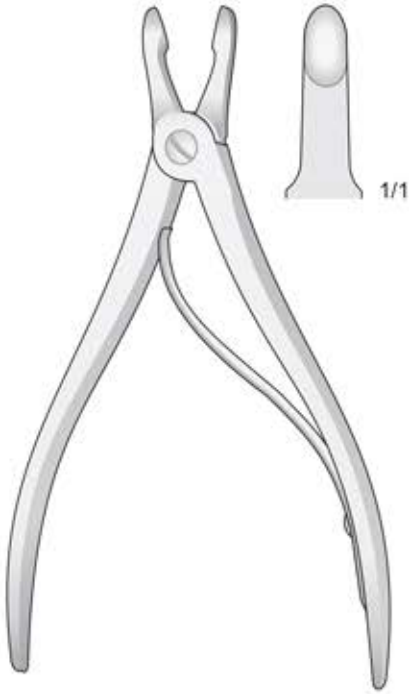

HARTMANN
FO-14
155 mm

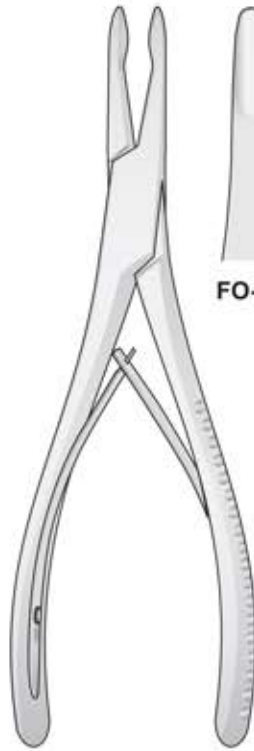

JANSEN
FO-37/FO-39
170 mm

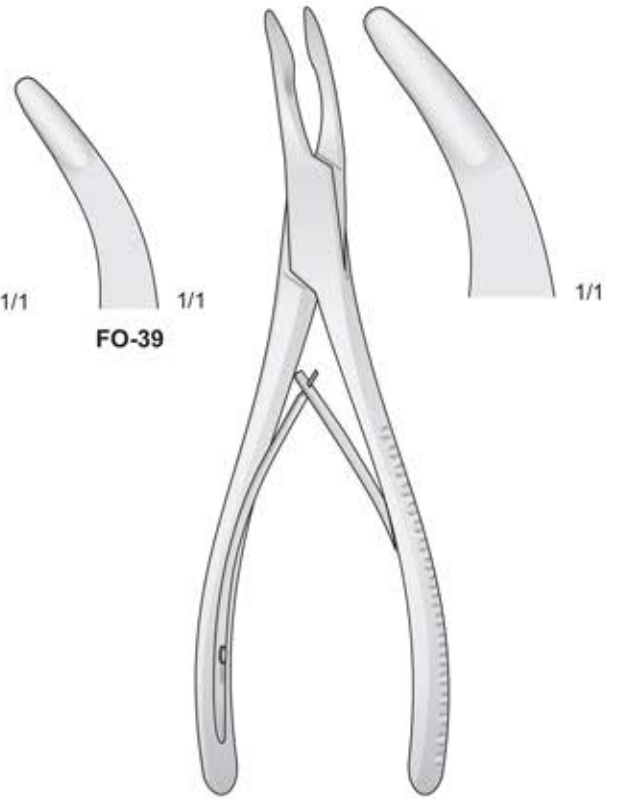

OLIVECRONA
FO-45
190 mm

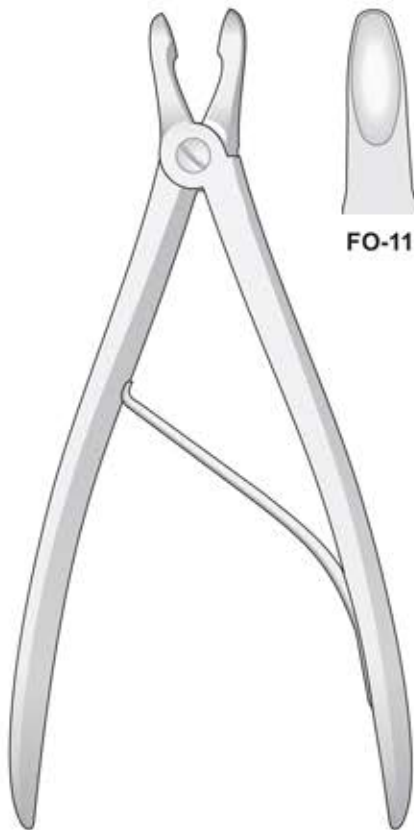

CUSHING
FO-11/FO-12
190 mm

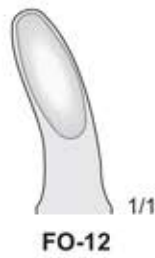

FO-11

FO-12

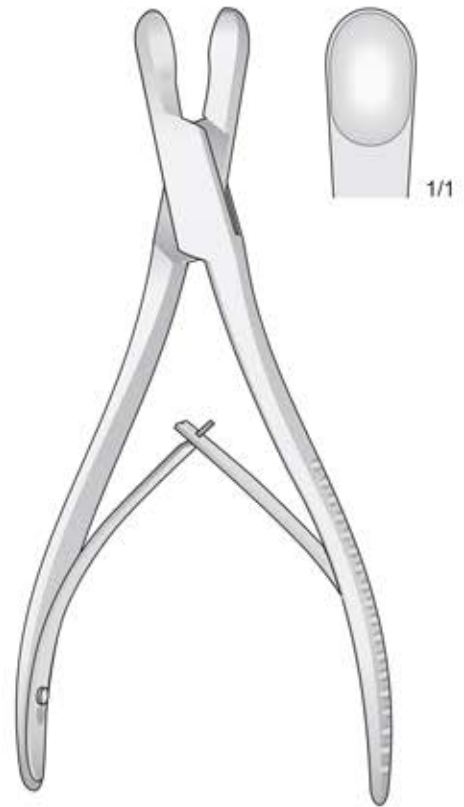

LUER-STILLE
FO-13
185 mm



CLEVELAND
FO-231 140 mm
FO-232 170 mm



CLEVELAND
FO-233 150 mm
FO-234 170 mm

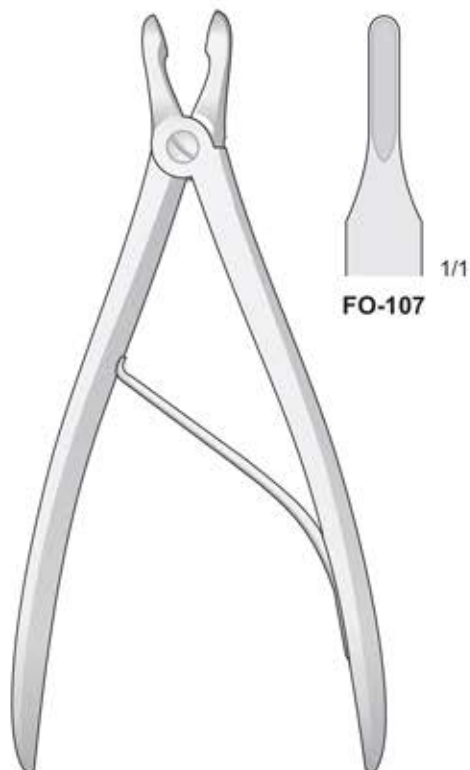

CUSHING
FO-107/FO-109
190 mm

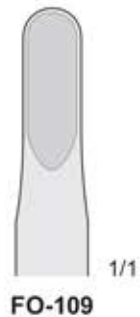

FO-109



FO-147



FO-149

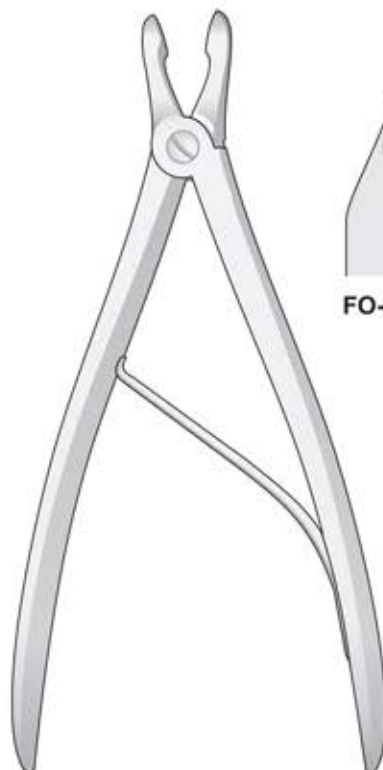

CUSHING
FO-147/FO-149
190 mm

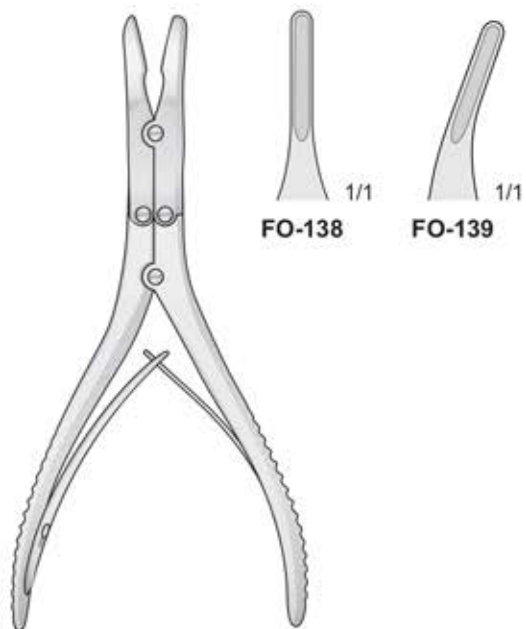

FO-138 1/1
FO-139 1/1

RUSKIN
FO-138/FO-139
150 mm

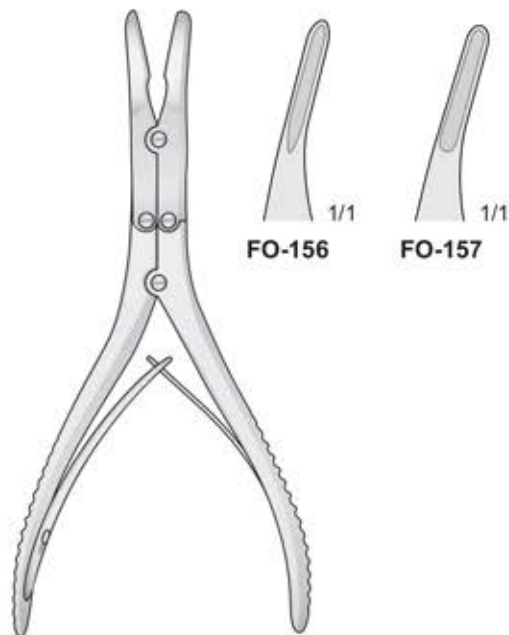

FO-156 1/1
FO-157 1/1

KLEINERT-KUTZ
FO-156/FO-157
155 mm

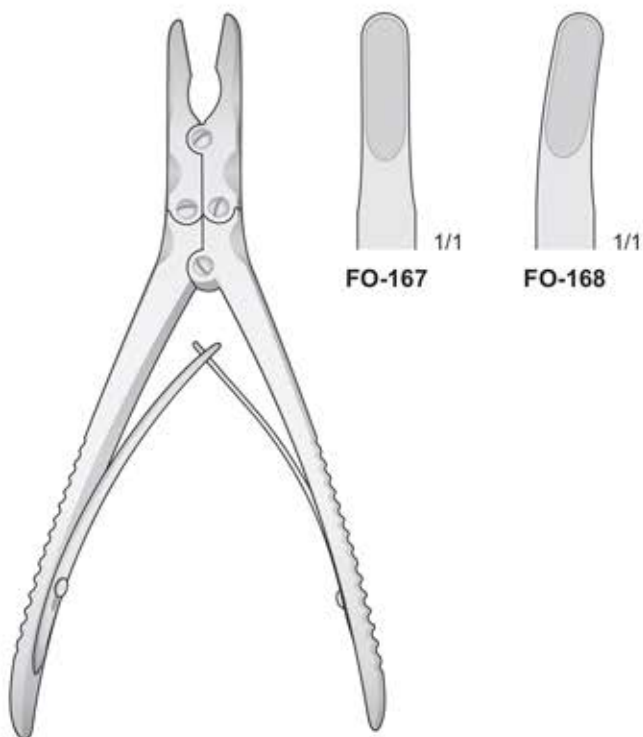

FO-167 1/1
FO-168 1/1

RUSKIN
FO-167/FO-168
185 mm

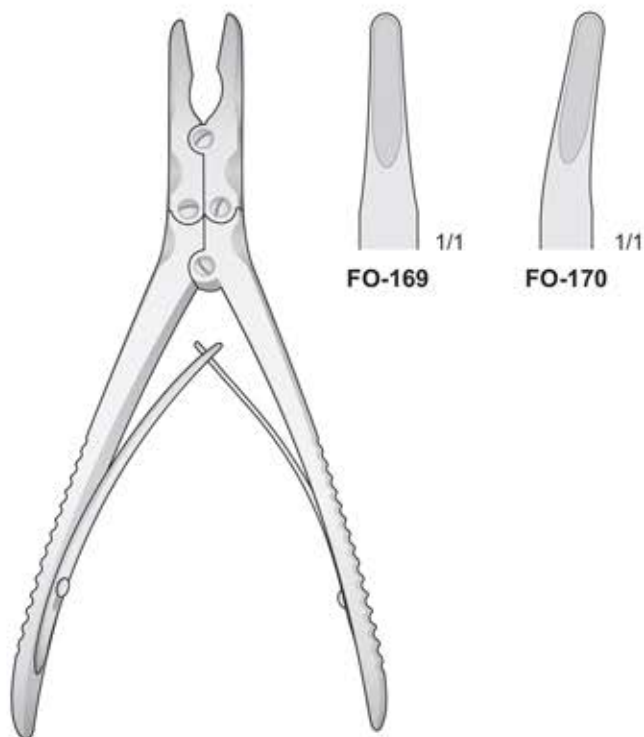

FO-169 1/1
FO-170 1/1

RUSKIN
FO-169/FO-170
185 mm



BEYER
FO-20
180 mm



ZAUHAL-JANSEN
FO-34
180 mm

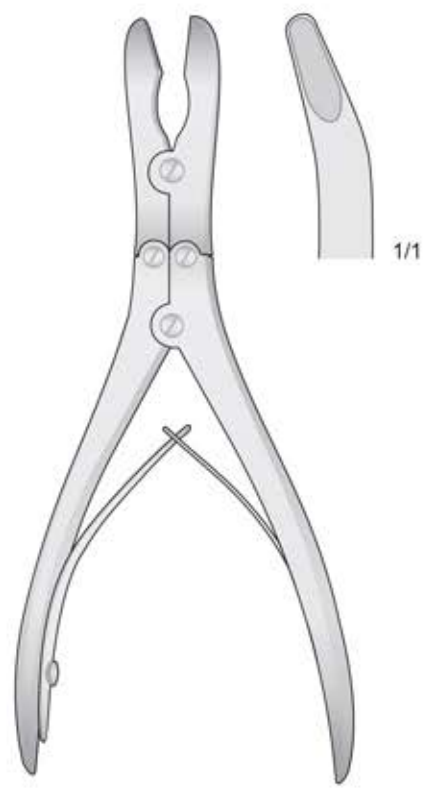

RUSKIN-STILLE
FO-35
180 mm

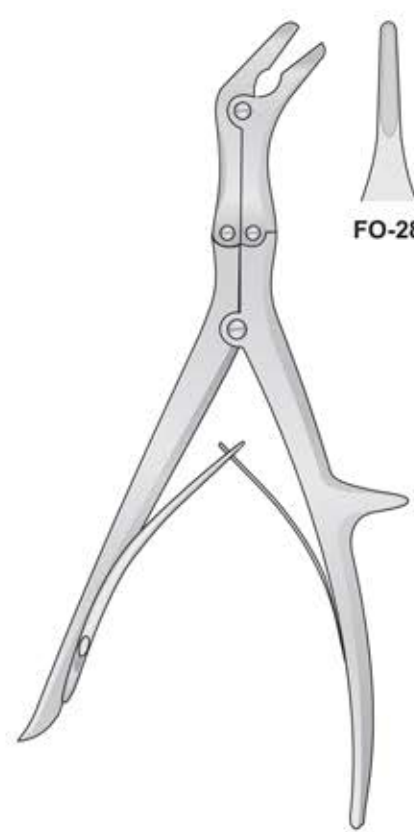

ECHLIN
FO-28/FO-30
230 mm

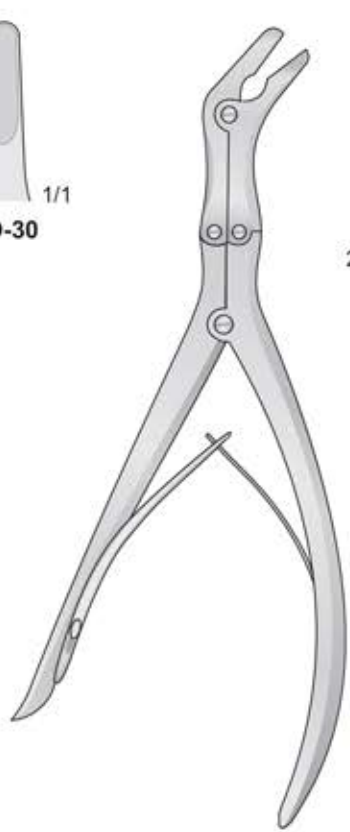

LEKSELL
FO-31/FO-32

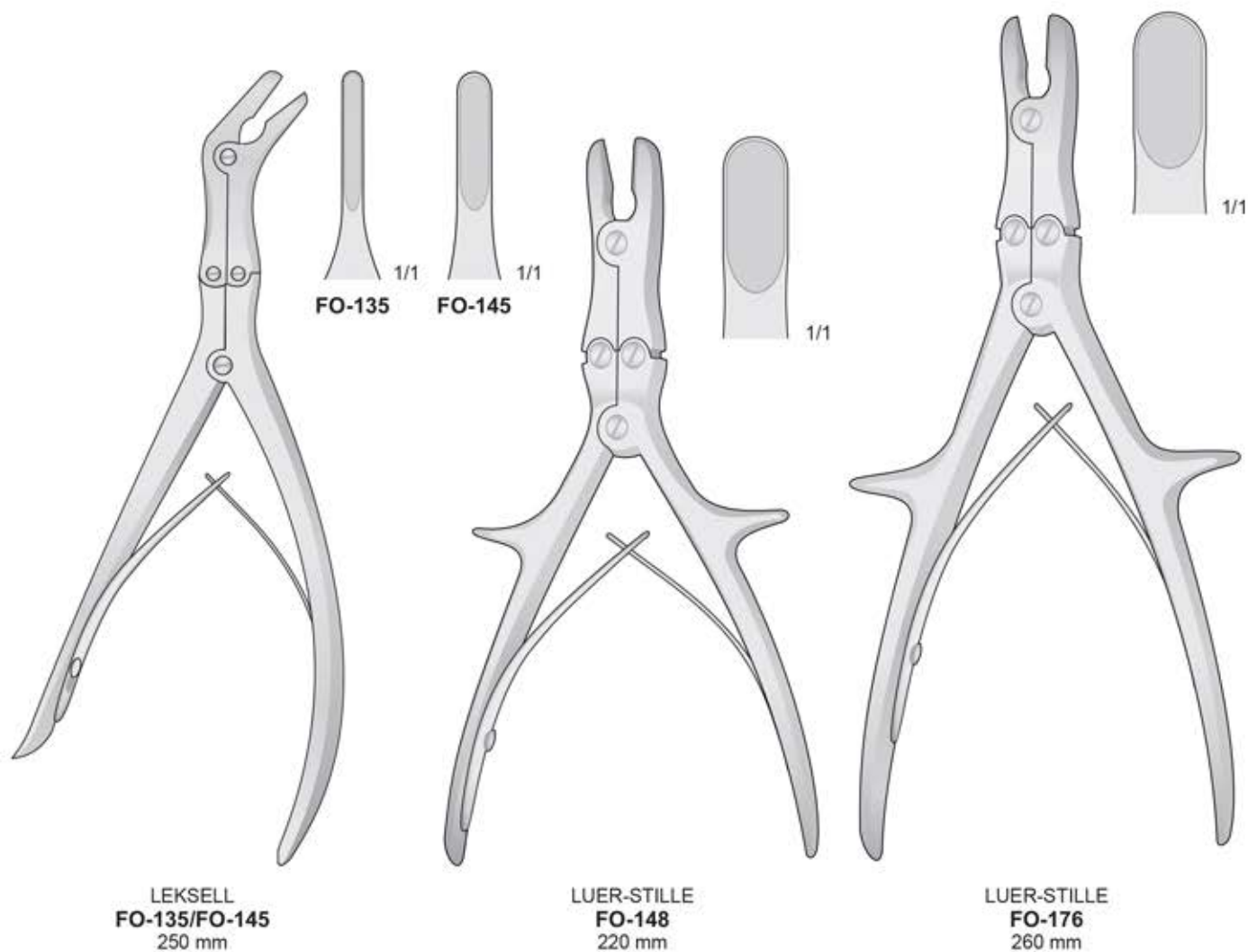

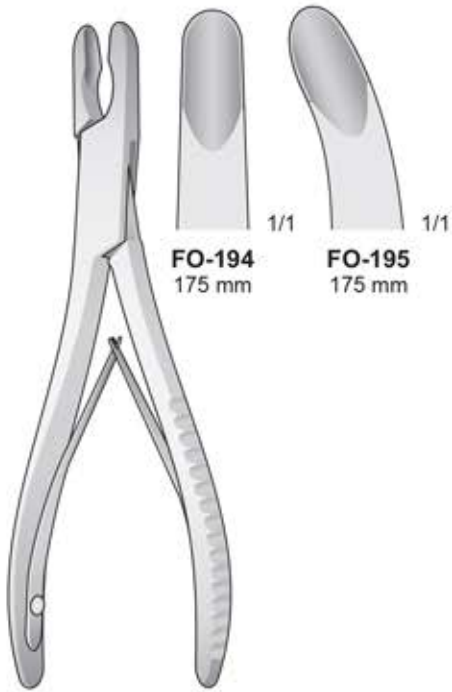

FO-194
175 mm

FO-195
175 mm

LUER
FO-194/FO-195
175 mm

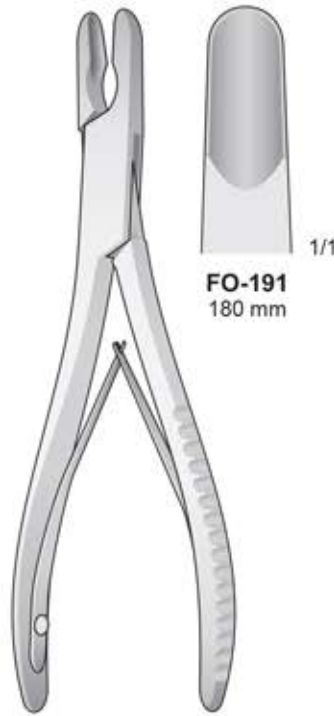

FO-191
180 mm

LUER
FO-191
180 mm

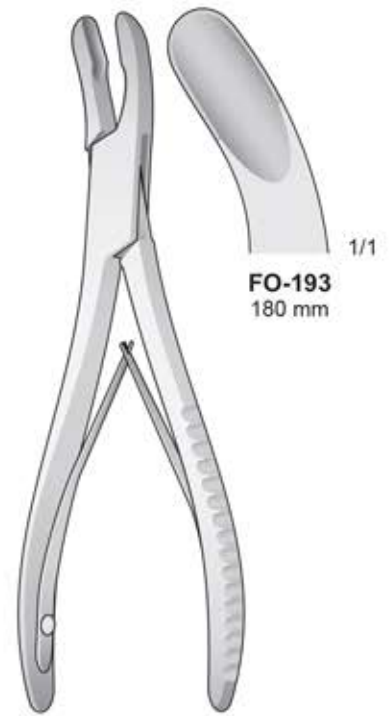

FO-193
180 mm

LUER
FO-193
180 mm

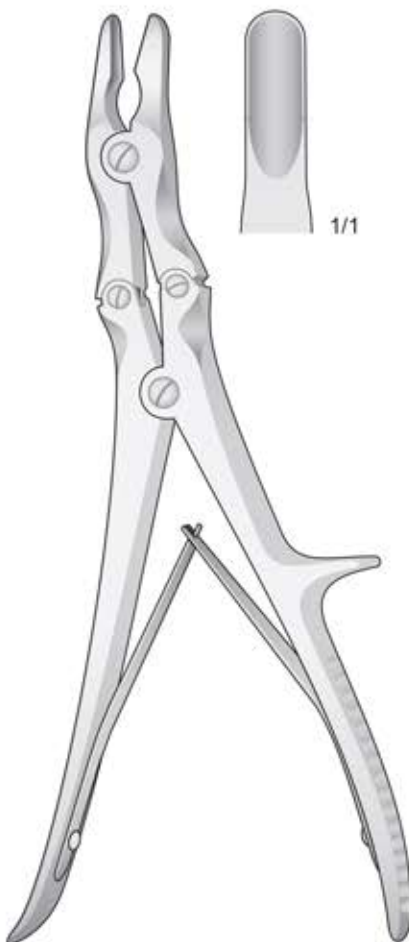

LEKSELL-STILLE
FO-196
240 mm

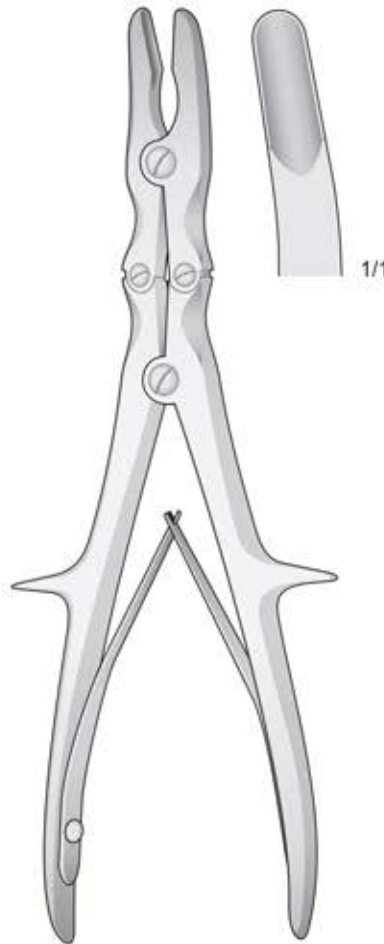

STILLE-RUSKIN
FO-197
240 mm



ADSON
FO-198
210 mm

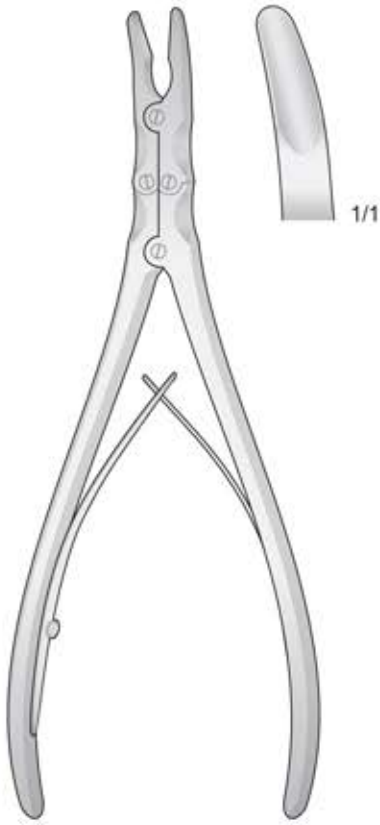

RÖTTGEN-RUSKIN
FO-199
240 mm



FO-140
200 mm

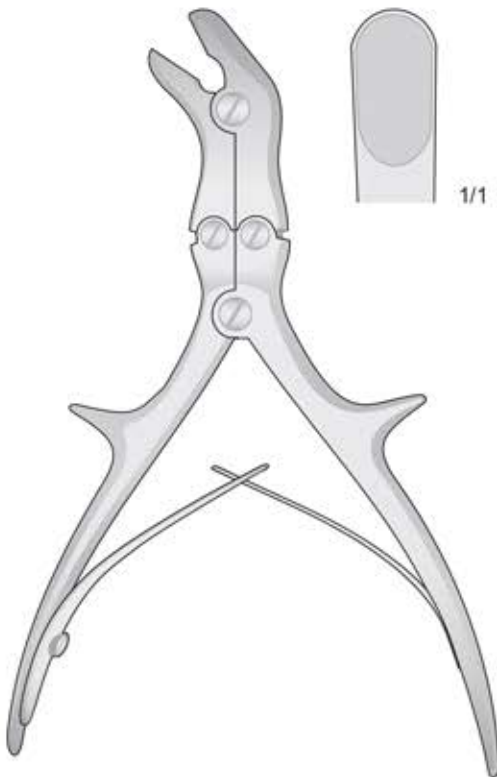

STILLE
FO-36
210 mm

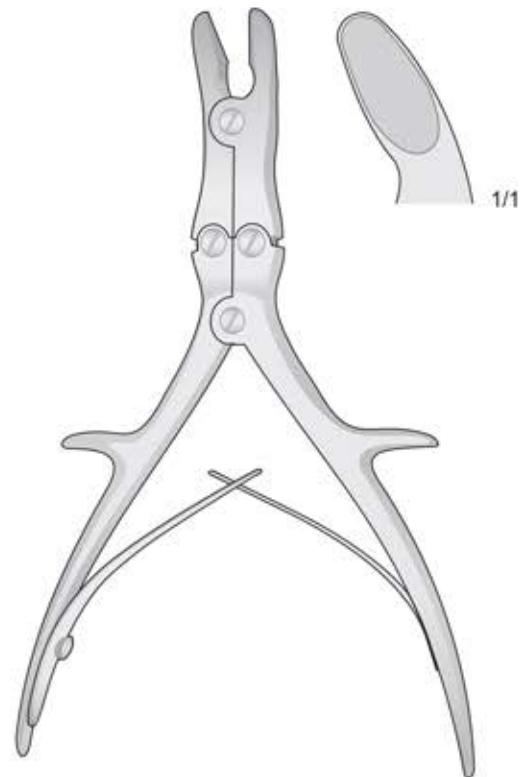

LUER-STILLE
FO-38
210 mm

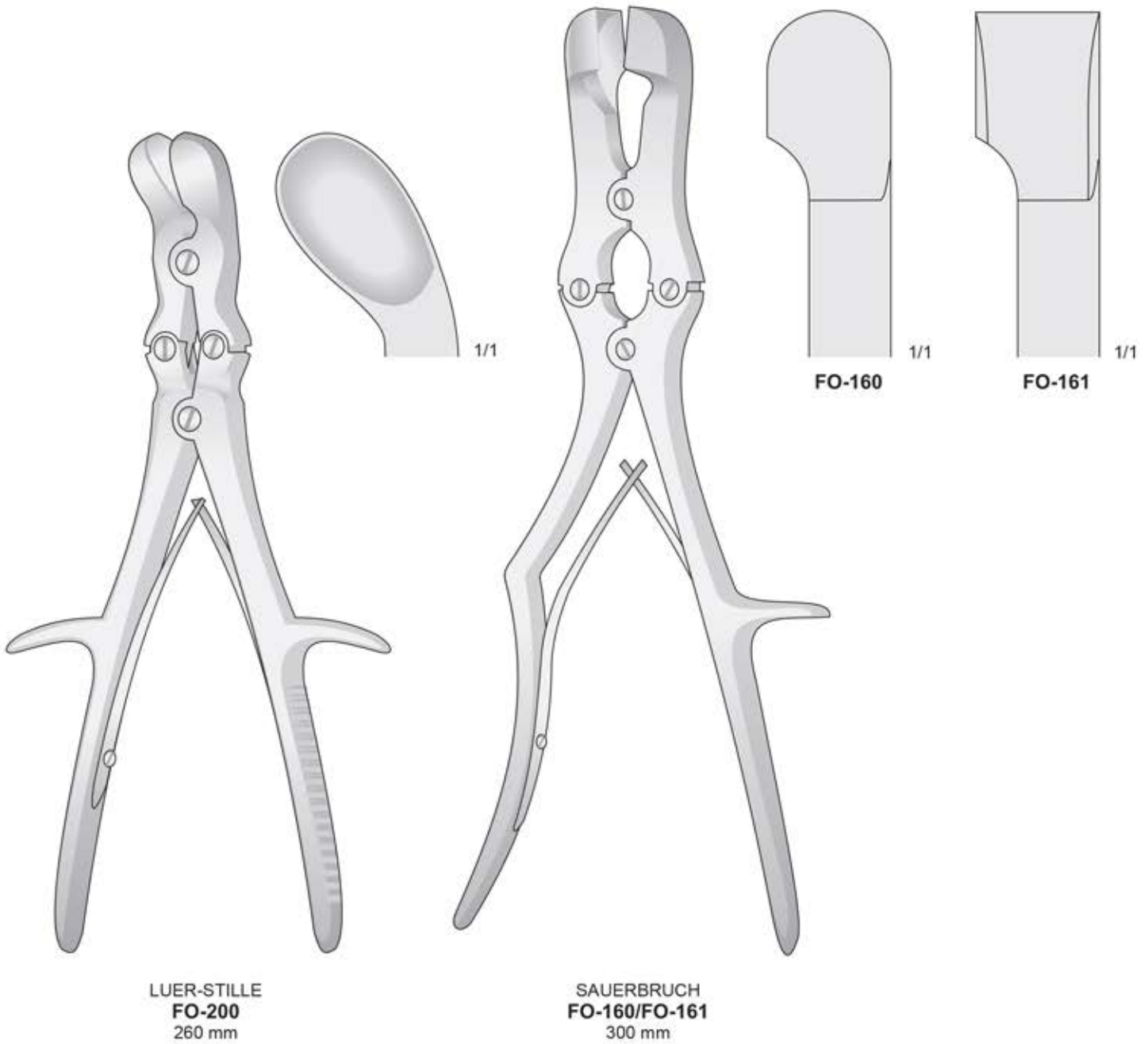

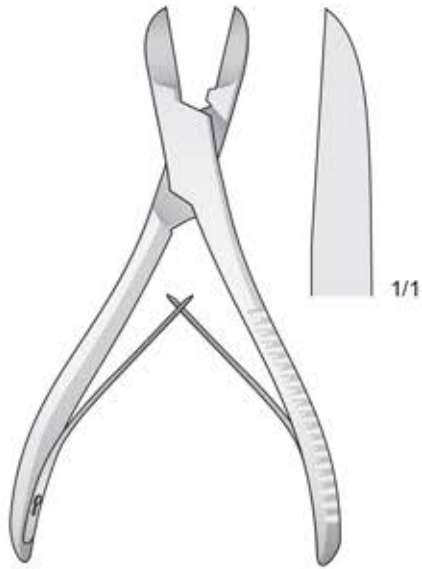

LISTON
LX-111
140 mm

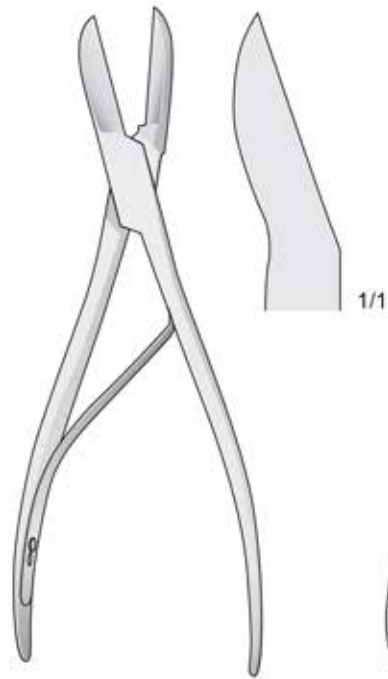

LISTON
LX-109
170 mm

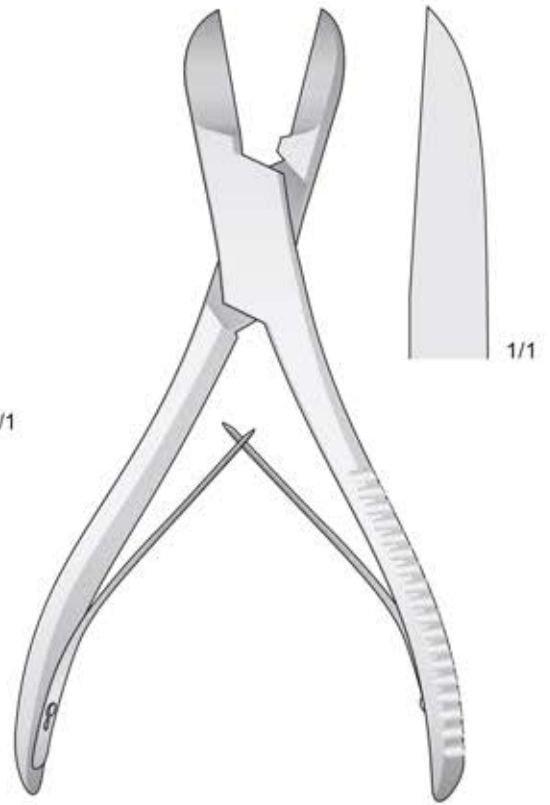

LISTON
LX-116
200 mm

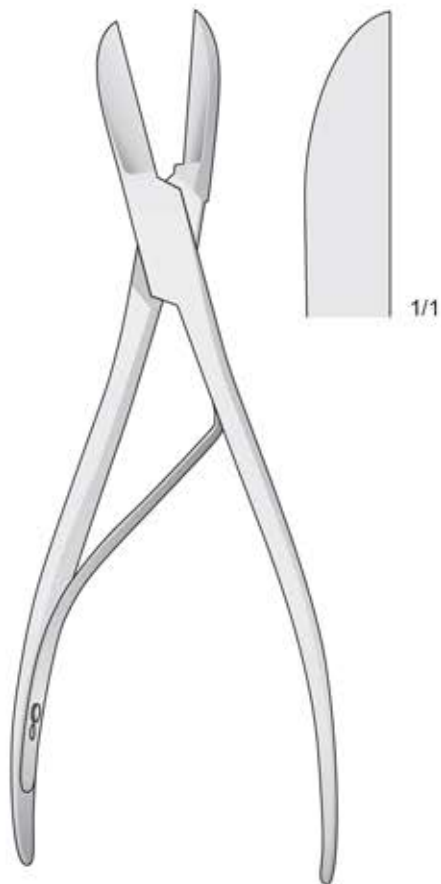

LISTON
LX-108
220 mm

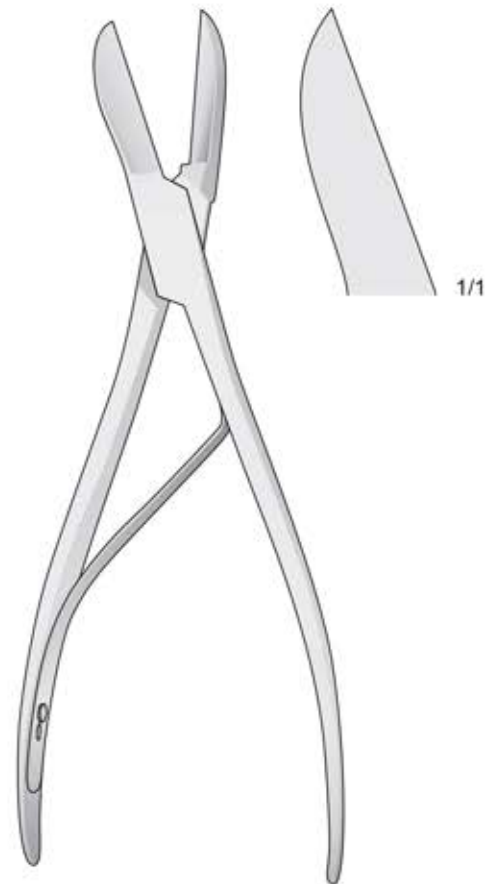

LISTON
LX-110
220 mm

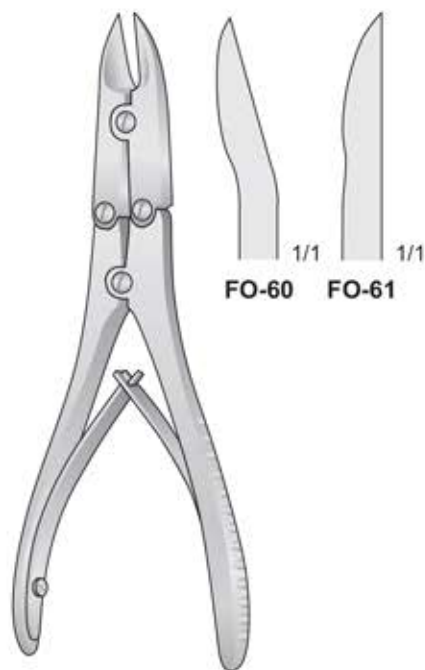

BÖHLER
FO-60/FO-61
150 mm

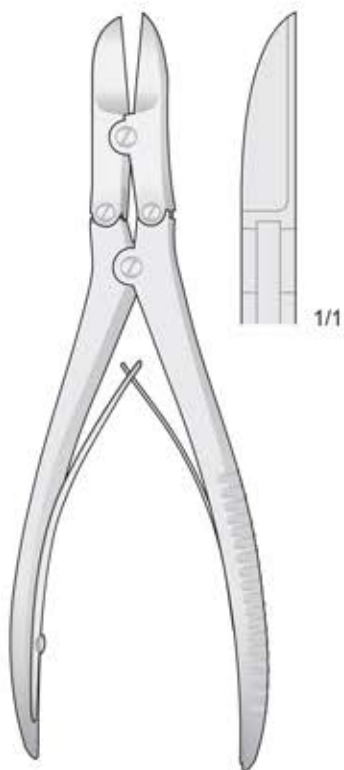

RUSKIN-LISTON
FO-108
190 mm

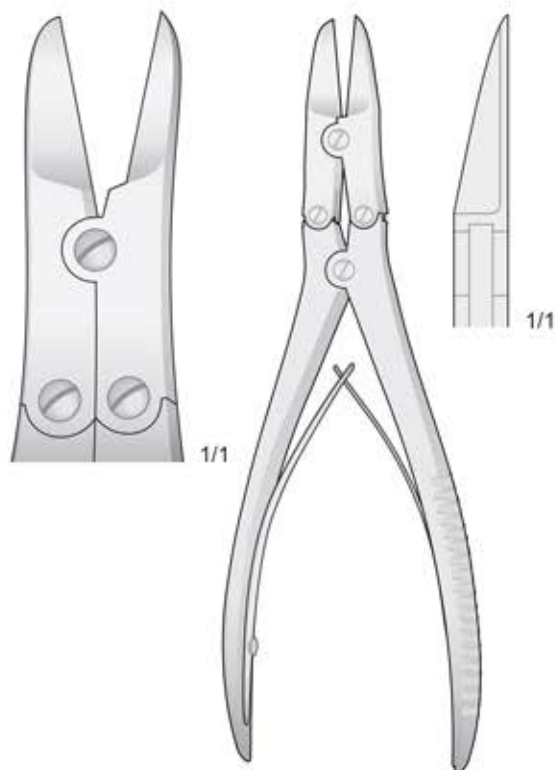

RUSKIN-LISTON
FO-178
190 mm

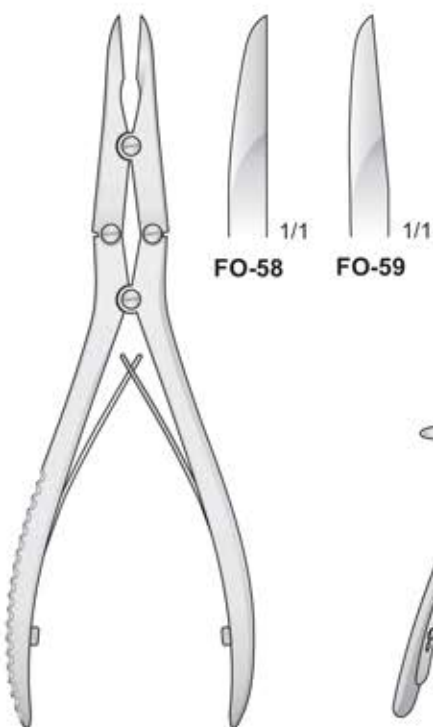

FO-58/FO-59
180 mm

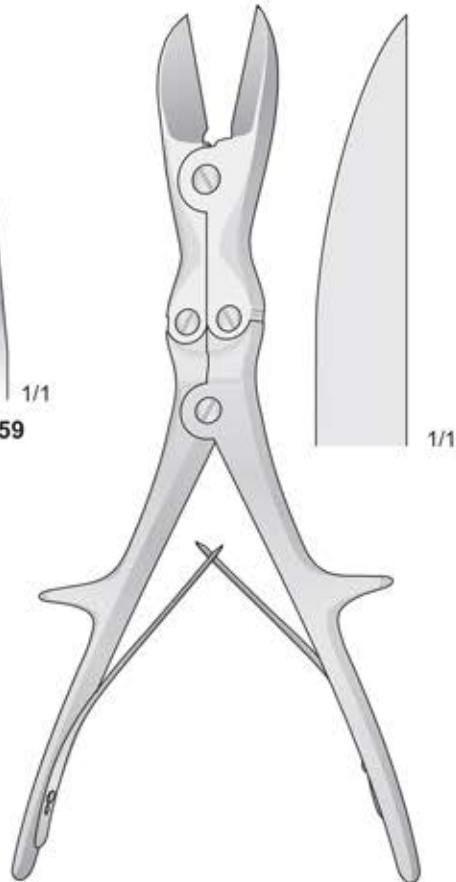

LISTON
FO-41
270 mm

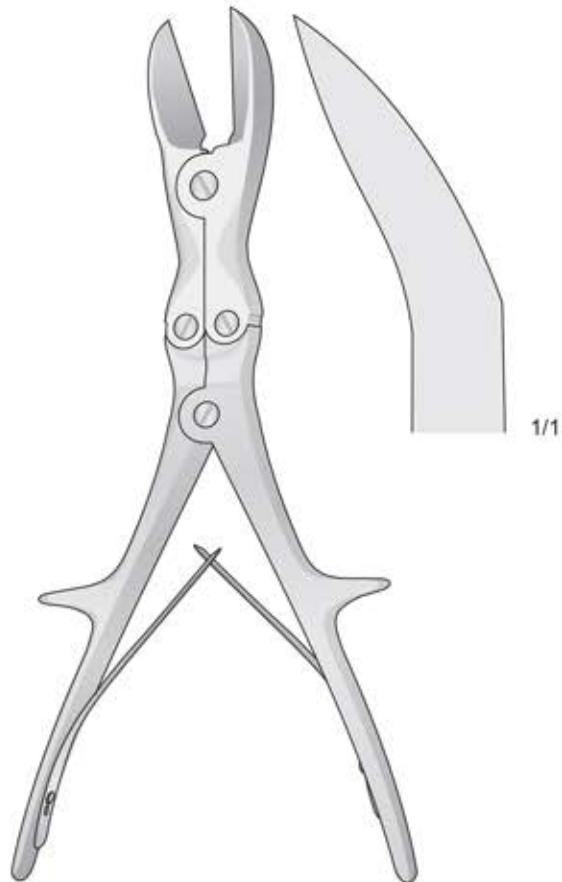

LISTON
FO-42
270 mm

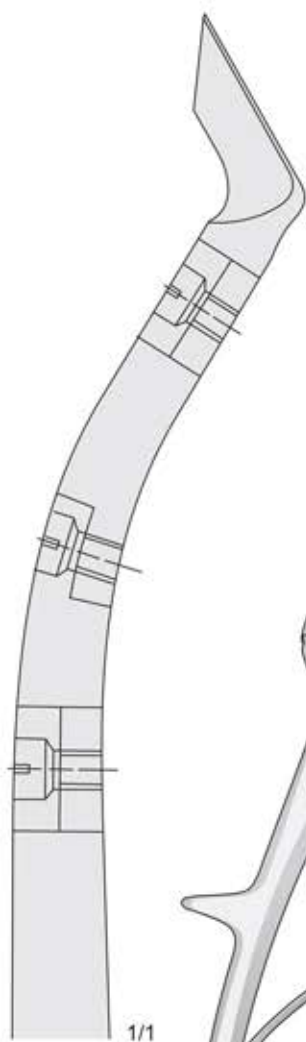

KEY-HORSLEY
FO-40
235 mm

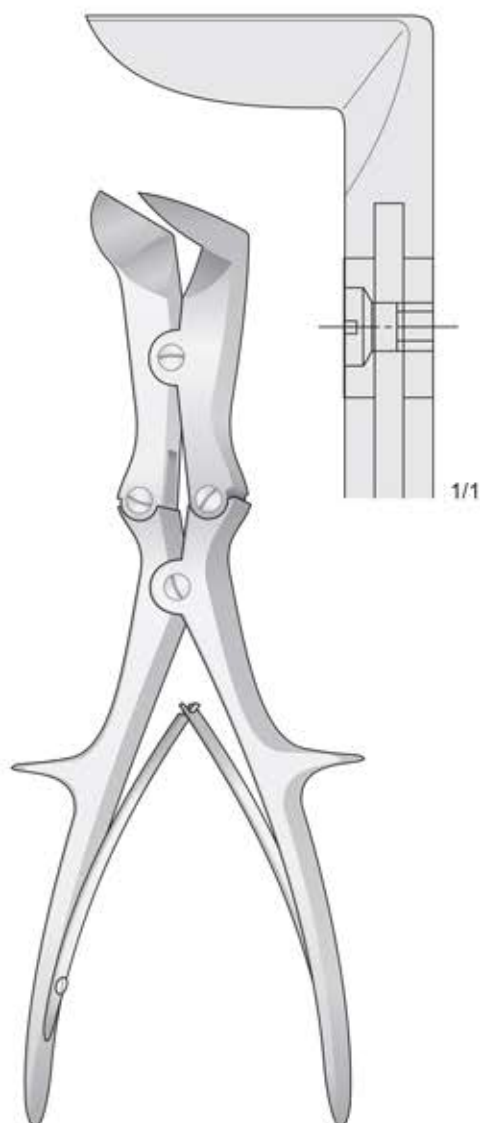

LISTON-STILLE
FO-158
265 mm



FG-40
230 mm

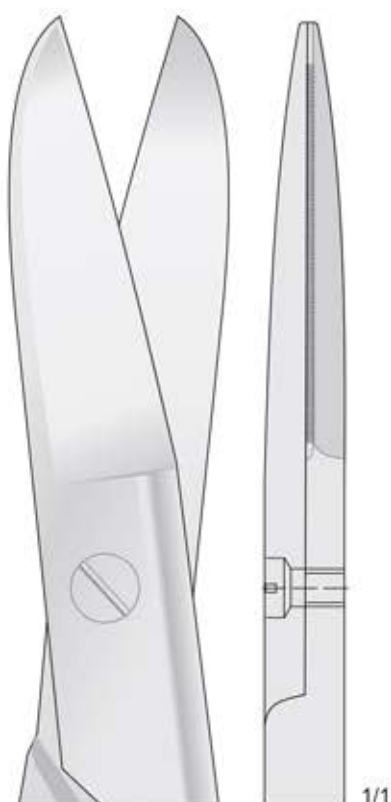

1/1

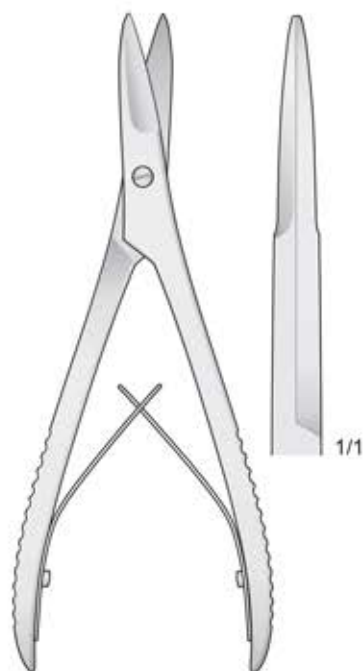

FO-63
160 mm

1/1

Wires and Nails

Bohrdrähte und Knochennägel
Broches et clous
Agujas y clavos
Fili e chiodi

Extension Bows

Extensionsbügel
Étriers d'extension
Arcos de tracción
Archi da trazione

Twist Drills

Spiralbohrer
Forets
Brocas espirales
Maschiatori - Taps

Osteosynthesis

Osteosynthesis
Ostéosynthèse
Osteosintesis
Osteosintesi

Hand Drills

Handbohrapparate
Perceuses à main
Perforadores manuales
Perforatori a mano

Screwdrivers

Schraubendreher
Tournevis
Destornilladores
Cacciaviti

Bone surgery

Knochenchirurgie
Chirurgie osseuse
Cirugía ósea
Chirurgia ossea



KIRSCHNER
 Trokarspitze
 Trocar point
 Punta trequarti
 Punta de trócar
 Pointe de Trocart



KIRSCHNER
 Trokarspitze
 Trocar point
 Punta trequarti
 Punta de trócar
 Pointe de Trocart



KIRSCHNER
 Lanzenspitze
 Lance point
 Punta lanceolate
 Punta lanceolar
 Pointe lancette

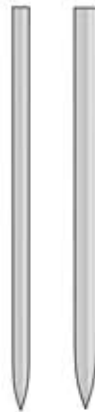

Trokarspitze
 Trocar point
 Punta trequarti
 Punta de trócar
 Pointe de Trocart

310 mm



Rundes ende
 Round shaft
 Punta rotonda
 Punta redonda
 Pointe ronde

310 mm



Lanzenspitze
 Lance point
 Punta lanceolate
 Punta lanceolar
 Pointe lancette

310 mm

Ø/Diam.	Conf. 10 pz.
0,8 mm	KI-99
1,0 mm	KI-100
1,2 mm	KI-102
1,4 mm	KI-114
1,5 mm	KI-115
1,6 mm	KI-116
1,7 mm	KI-117
1,8 mm	KI-118
2,0 mm	KI-120
2,2 mm	KI-122
2,5 mm	KI-125
3,0 mm	KI-130

Ø/Diam.	Conf. 10 pz.
0,8 mm	KI-00
1,0 mm	KI-01
1,2 mm	KI-02
1,4 mm	KI-14
1,5 mm	KI-15
1,6 mm	KI-16
1,7 mm	KI-17
1,8 mm	KI-18
2,0 mm	KI-20
2,2 mm	KI-22
2,5 mm	KI-25
3,0 mm	KI-30

Ø/Diam.	Conf. 10 pz.
0,8 mm	KI-40
1,0 mm	KI-41
1,2 mm	KI-42
1,5 mm	KI-43
1,6 mm	KI-44
1,8 mm	KI-45
2,0 mm	KI-46
2,2 mm	KI-47
2,5 mm	KI-48
3,0 mm	KI-49



KIRSCHNER
 Trokarspitze
 Trocar point
 Punta trequarti
 Punta de trócar
 Pointe de Trocart



KIRSCHNER
 Trokarspitze
 Trocar point
 Punta trequarti
 Punta de trócar
 Pointe de Trocart



KIRSCHNER
 Lanzenspitze
 Lance point
 Punta lanceolate
 Punta lanceolar
 Pointe lancette

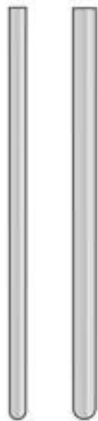

Rundes ende
 Round shaft
 Punta rotonda
 Punta redonda
 Pointe ronde

150 mm

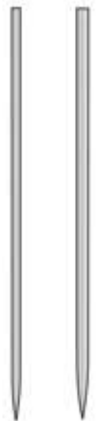

Trokarspitze
 Trocar point
 Punta trequarti
 Punta de trócar
 Pointe de Trocart

150 mm



Lanzenspitze
 Lance point
 Punta lanceolate
 Punta lanceolar
 Pointe lancette

150 mm

Ø/Diam.	Conf. 10 pz.
0,8 mm	KI-69
1,0 mm	KI-70
1,2 mm	KI-72
1,4 mm	KI-74
1,5 mm	KI-75
1,6 mm	KI-76
1,7 mm	KI-77
1,8 mm	KI-78
2,0 mm	KI-80
2,2 mm	KI-82
2,5 mm	KI-85
3,0 mm	KI-90

Ø/Diam.	Conf. 10 pz.
0,8 mm	KI-60
1,0 mm	KI-61
1,2 mm	KI-62
1,4 mm	KI-63
1,6 mm	KI-64
1,8 mm	KI-65
2,0 mm	KI-66
2,2 mm	KI-67
2,5 mm	KI-68
3,0 mm	KI-71

Ø/Diam.	Conf. 10 pz.
0,8 mm	KI-29
1,0 mm	KI-31
1,2 mm	KI-32
1,5 mm	KI-33
1,6 mm	KI-34
1,8 mm	KI-35
2,0 mm	KI-36
2,2 mm	KI-37
2,5 mm	KI-38
3,0 mm	KI-39

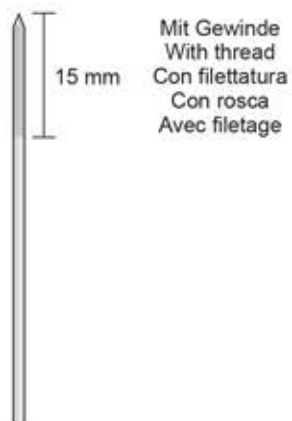

15 mm

Mit Gewinde
With thread
Con filettatura
Con rosca
Avec filetage



Runde
Round
Rotonda
Redonda
Ronde

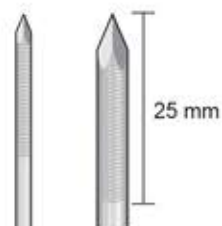

25 mm

Trokarspitze
Trocar point
Punta trequarti
Punta de tròcar
Pointe de Trocart

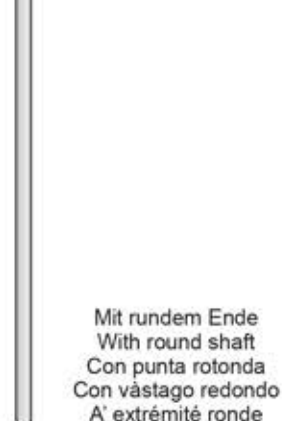

Mit rundem Ende
With round shaft
Con punta rotonda
Con vástago redondo
A' extrémité ronde



KIRSCHNER			
Codice	Ø mm	Lung.	Lung. filo
KI-220	1,5	150	5
KI-221	1,6	150	15
KI-222	2	150	15
KI-223	2	200	15

KIRSCHNER			
Codice	Ø mm	Lung.	Lung. filo
KI-224	2,5	200	25
KI-225	2,5	230	25
KI-226	2,5	300	25
KI-227	3,0	300	25
KI-228	3,5	300	25
KI-229	4,0	260	25
KI-233	4,5	300	25

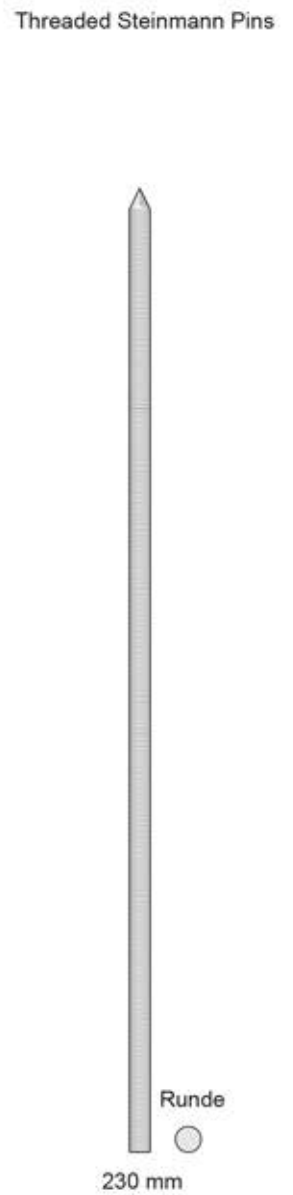
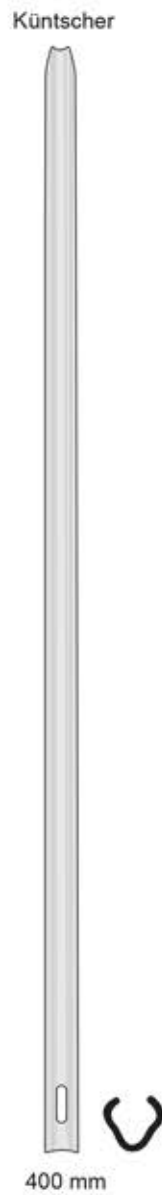
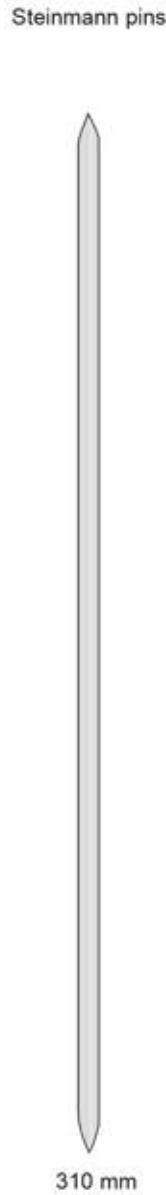
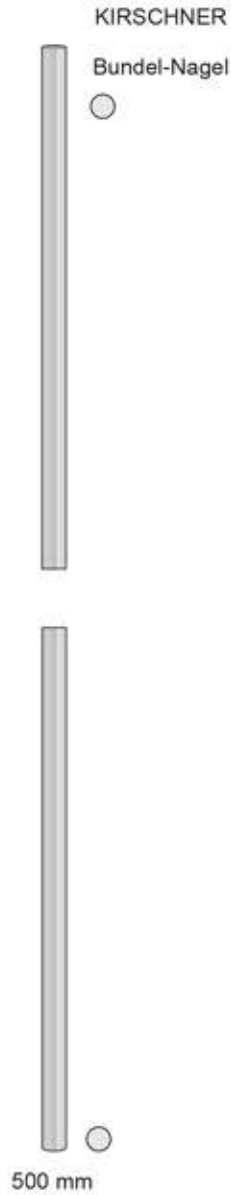

Ø/Diam.	Conf. 10 pz.
2,0 mm	KI-50
2,5 mm	KI-51
3,0 mm	KI-52
3,5 mm	KI-53
4,0 mm	KI-54
4,5 mm	KI-55
5,0 mm	KI-56
5,5 mm	KI-57
6,0 mm	KI-58

Ø/Diam.	Conf. 1 pz.
3,5 mm	KI-280
4,0 mm	KI-282
4,5 mm	KI-284
5,0 mm	KI-286
6,0 mm	KI-288
6,5 mm	KI-290

Ø/Diam.	Conf. 1 pz.
6,0 mm	KI-252
7,0 mm	KI-254
8,0 mm	KI-256
9,0 mm	KI-258
10 mm	KI-260
11 mm	KI-262
12 mm	KI-264

Ø/Diam.	Conf. 1 pz.
2,0 mm	KI-160
2,5 mm	KI-161

Negativo

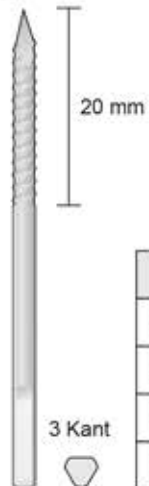

SCHANZ			
Codice	Ø mm	Lung.	Lung. filo
KI-230	3	60	20
KI-231	3	80	20
KI-232	4	60	25

Negativo



SCHANZ			
Codice	Ø mm	Lung.	Lung. filo
KI-293	2	150	50
KI-294	3	150	50
KI-295	3,5	150	50
KI-296	4	150	50
KI-297	4,5	150	50
KI-298	5	150	50

Negativo



SCHANZ			
Codice	Ø mm	Lung.	Lung. filo
KI-238	2	150	50
KI-240	3	150	50
KI-242	3,5	150	50
KI-244	4	150	50
KI-246	4,5	150	50
KI-248	5	150	50

Positivo

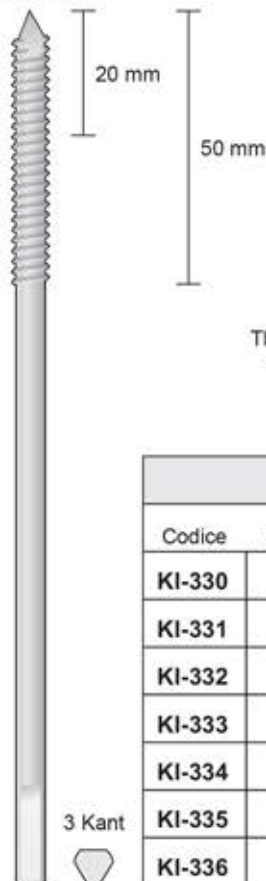

SCHANZ			
Codice	Ø mm	Lung.	Lung. filo
KI-330	2	150	20
KI-331	3	150	20
KI-332	3,5	150	50
KI-333	4	150	25
KI-334	4	150	50
KI-335	4,5	150	50
KI-336	5	150	50

Steinmann Pins with Central Thread with Trocar Point

Bohrdrahtspender
Contentitore per
sterilizzazione Kirschner

Ø 10 mm



STEINMANN PINS		
Codice	Ø mm	Lung.
KI-175	3	150
KI-176	3	180
KI-177	3	200
KI-178	3	230
KI-179	3,5	150
KI-180	3,5	180
KI-181	3,5	200
KI-182	3,5	230
KI-183	4	150
KI-184	4	180
KI-185	4	200
KI-186	4	230
KI-187	4	250
KI-188	4,5	150
KI-189	4,5	180
KI-190	4,5	200
KI-191	4,5	230
KI-192	4,5	250
KI-193	4,5	300
KI-194	5	150
KI-195	5	180
KI-196	5	200
KI-197	5	230
KI-198	5	250
KI-199	5	300

Positivo

Thread - Ø is 0,5 mm
more than pin - Ø

3 Kant



KI-300
320 mm
KI-301
190 mm

Bis Ø 3 mm
Up to Ø 3 mm
Fino a Ø 3 mm



WAGNER
LS-106
300 mm

Extraktionshaken
Extraction hooks
Gancio d'estrazione
Ganchos extractores
Crochets d'extraction

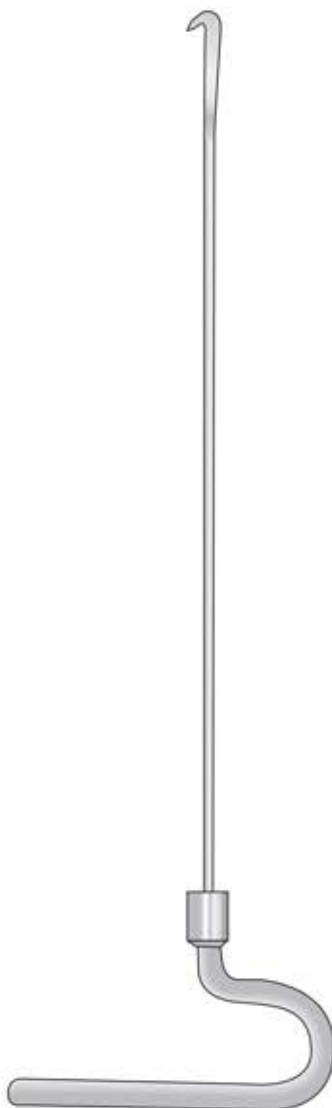

KI-306 - 290 mm
KI-307 - 370 mm
KI-308 - 420 mm

Ø Int. 2,5 mm



Ø Int. 1,2 mm

LS-100
120 mm



KÜNTSCHNER
FK-09
210 mm

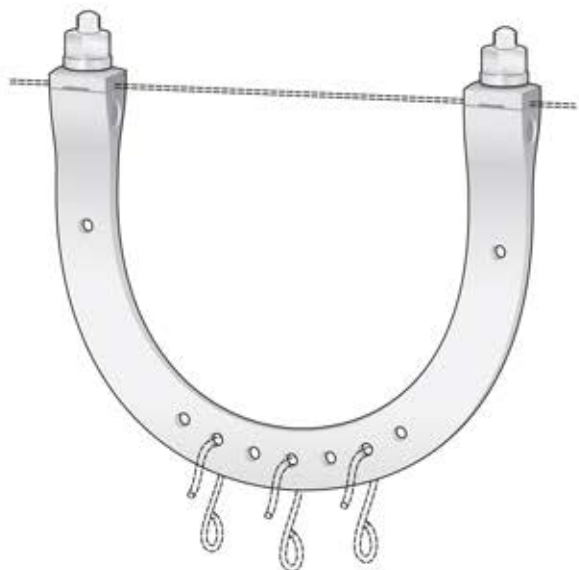

KIRSCHNER
LS-370/LS-378

LS-370	200 x 155 mm
LS-371	155 x 155 mm
LS-372	155 x 100 mm
LS-373	135 x 130 mm
LS-374	120 x 120 mm
LS-375	105 x 100 mm
LS-376	95 x 110 mm
LS-377	105 x 80 mm
LS-378	95 x 70 mm

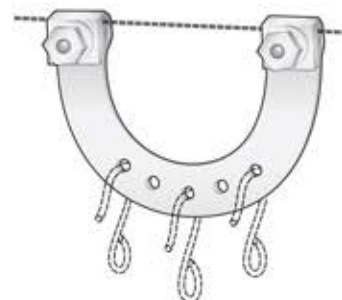

KIRSCHNER
LS-379
60 x 50 mm



LS-380 180 x 100 mm
LS-381 270 x 160 mm



LS-382



LS-383



LS-384

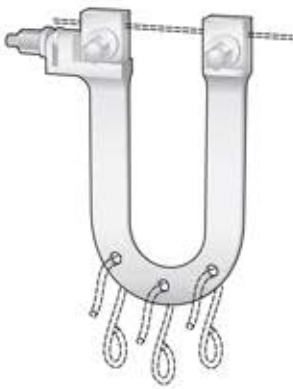

LS-385
30 x 80 mm



LS-386
60 x 70 mm



LS-387
105 x 80 mm



LS-390/LS-394

- LS-390** 95 x 155 mm
- LS-391** 120 x 115 mm
- LS-392** 135 x 125 mm
- LS-393** 155 x 140 mm
- LS-394** 200 x 140 mm



LS-388/LS-389

Dental schaft
Attacco Dentale

Ø 1,5 mm



LS-32
50 mm

Ø 2,0 mm



LS-33
55 mm

Mit AO schaft
Attacco AO

Ø 1,5 mm



LS-10
65 mm

Ø 2 mm



LS-11
70 mm

Ø 2,7 mm



LS-12
100 mm

Passo della vite
a 1,25 mm

Ø 3,5 mm



LS-13
110 mm

Passo della vite
a 1,75 mm

Ø 3,5 mm



LS-14
110 mm

Ø 4,5 mm



LS-15
130 mm

Ø 4,5 mm



LS-16
130 mm

Ø 6,5 mm



LS-17
170 mm

Mit AO schaft
Drill bits
Attacco AO

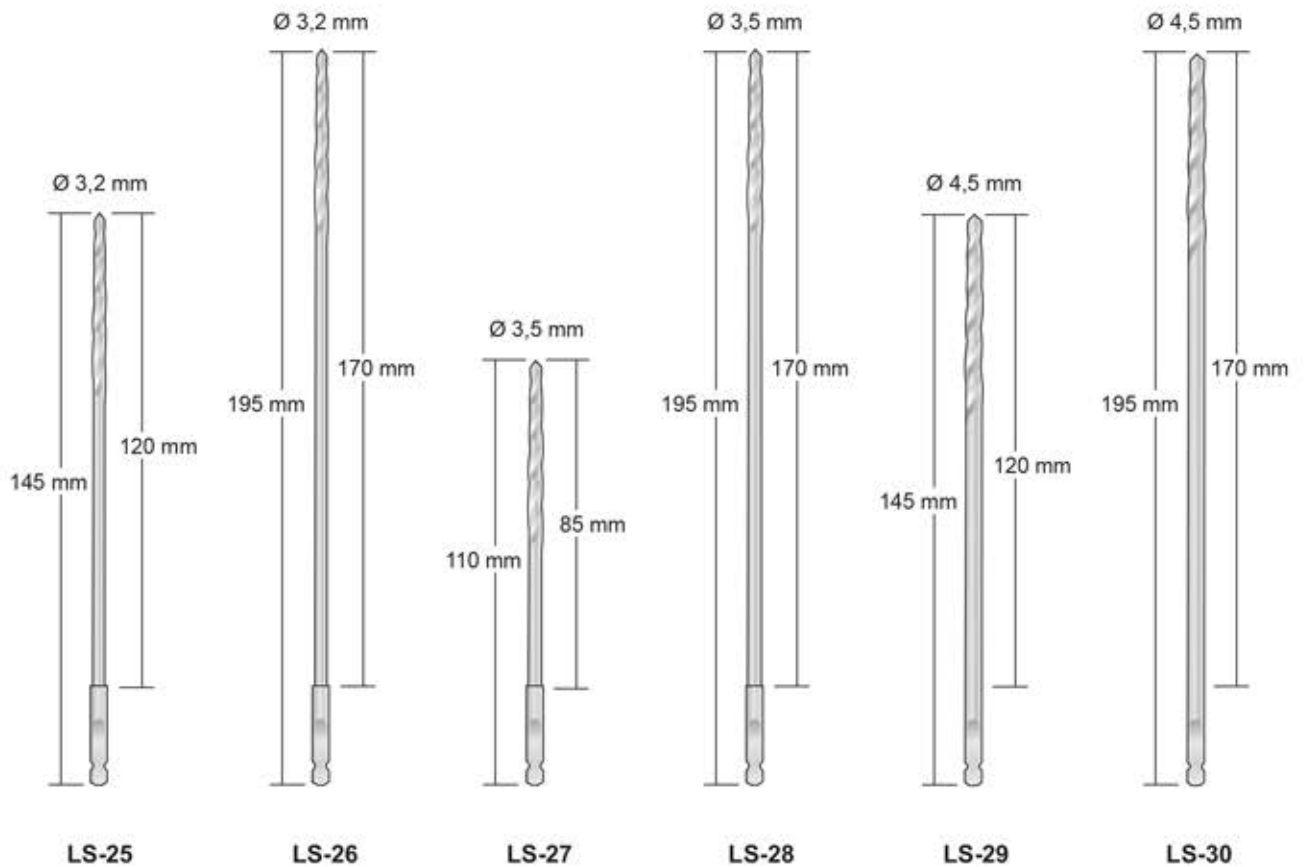
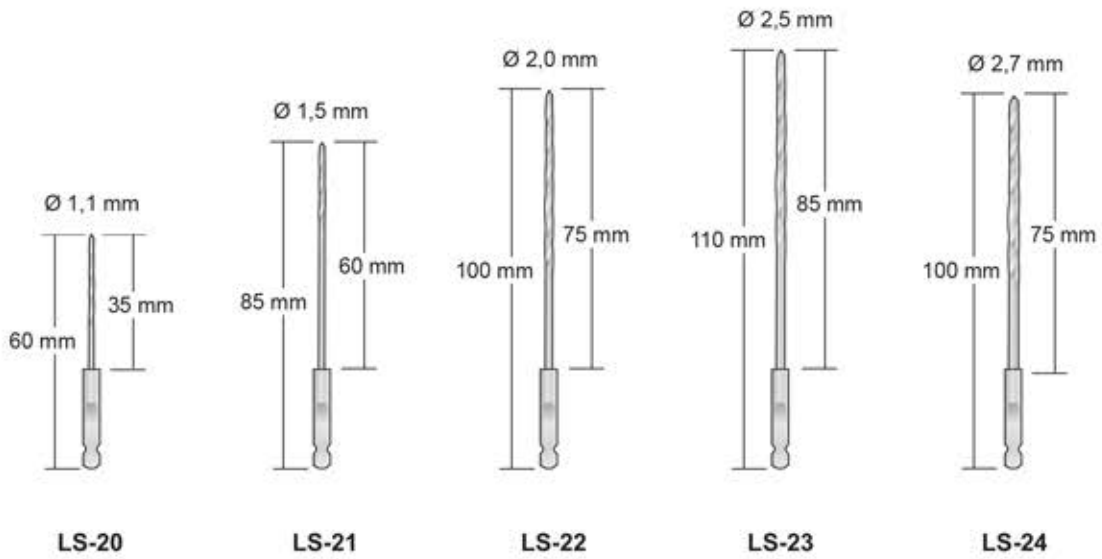

Mit rundschaft
Drill bits
Con attacco rotondo

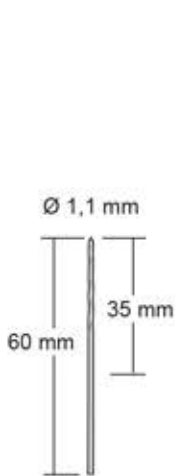

LS-40

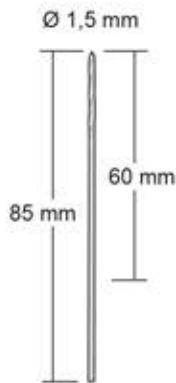

LS-41

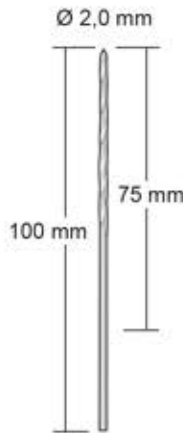

LS-42

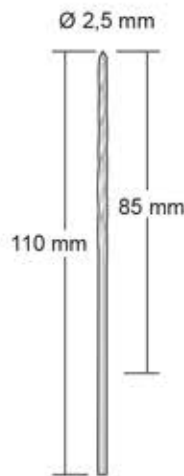

LS-43

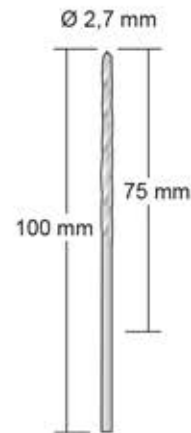

LS-44

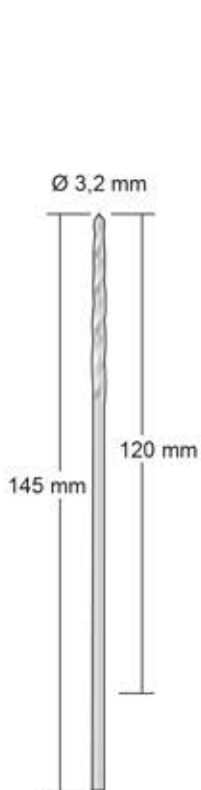

LS-45

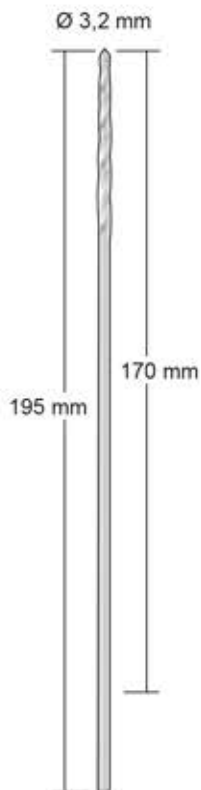

LS-46

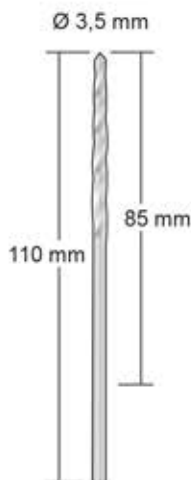

LS-47

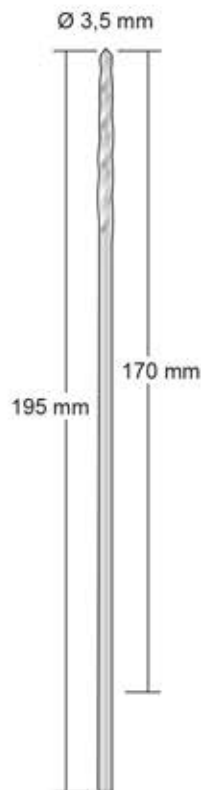

LS-48

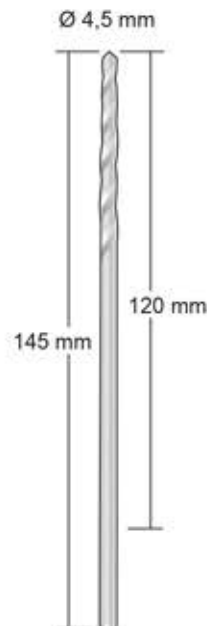

LS-49

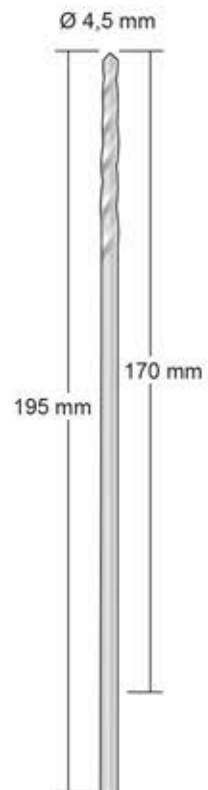

LS-50

Mit rundschaft
Drill bits
Con attacco rotondo

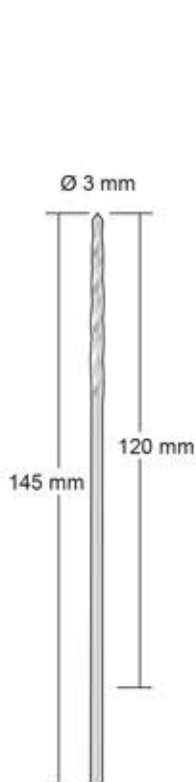

LS-51

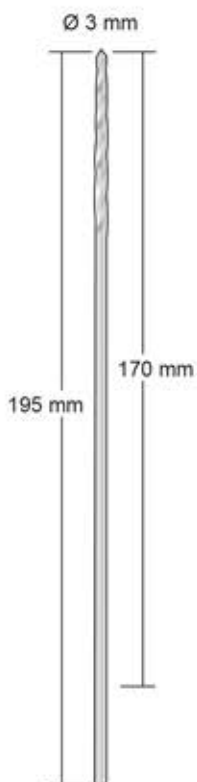

LS-52

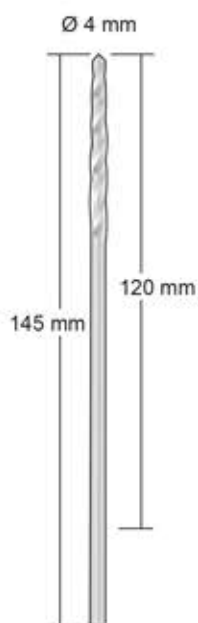

LS-53

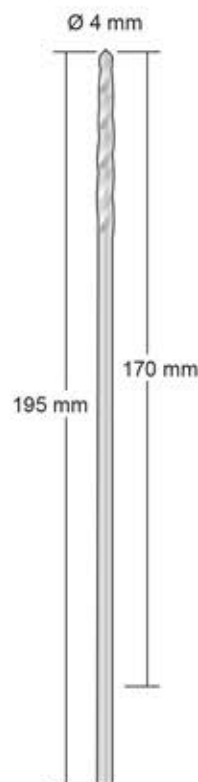

LS-54

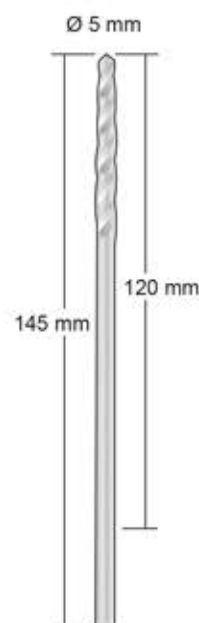

LS-55

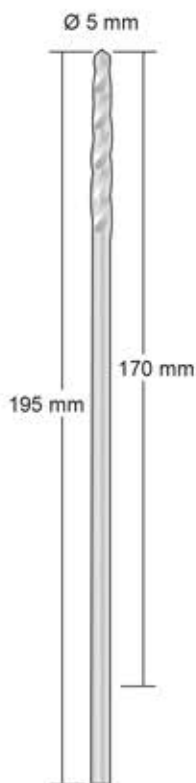

LS-56

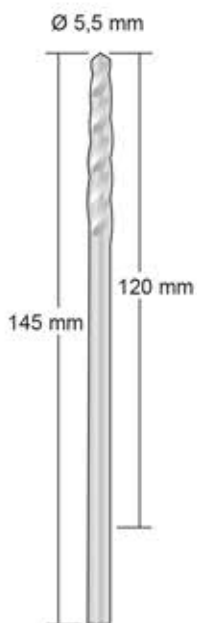

LS-57

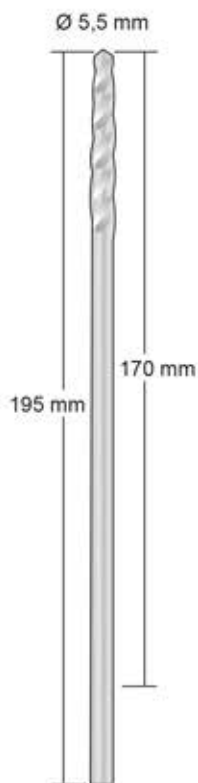

LS-58

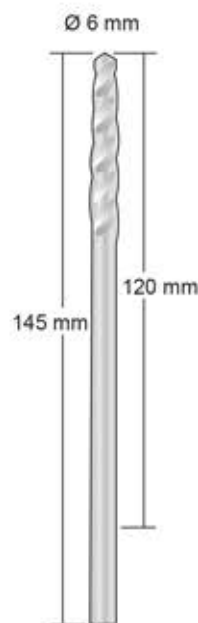

LS-59

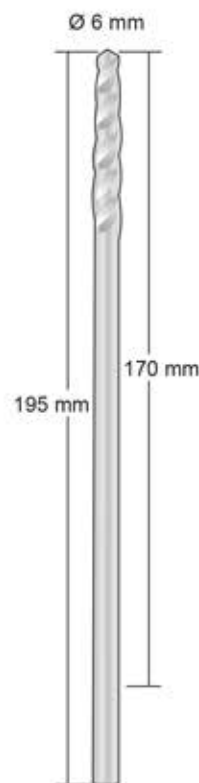

LS-60



LS-127
35 mm



LS-135
55 mm



LS-136
55 mm

Für kleine Schrauben
For small screws
Per piccole viti
Pour petite vis



LS-137
70 mm

Für Malleolarschrauben
For malleolar screws
Per viti malleolari
Pour vis à malléole

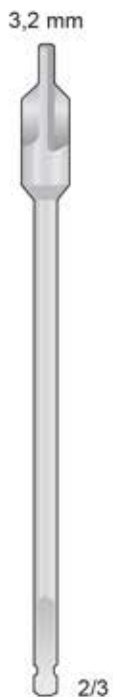

LS-138
120 mm



LS-125
100 mm



LS-126
90 mm

Zapfenfräser mit Schnellkupplung
Reamer with end for quick coupling
Fraise avec raccord rapide



LS-139
90 mm

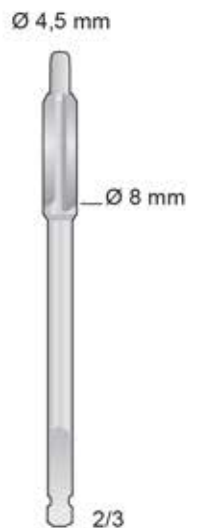

LS-140
90 mm

Handgriffe mit schnellspann futter
 Handles with quick-action chuck
 Manico con mandrino rapido
 Poignées avec mandrins rapides

AO-Schaft



Dental-Schaft



4kant-Schaft



Ø 4 mm

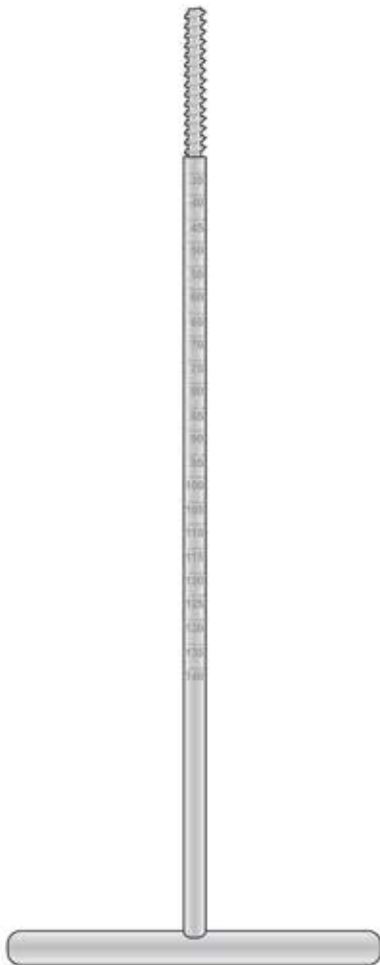

LS-120
260 mm



MANICO FERROZELL
LS-242
125 mm



LS-244
110 mm

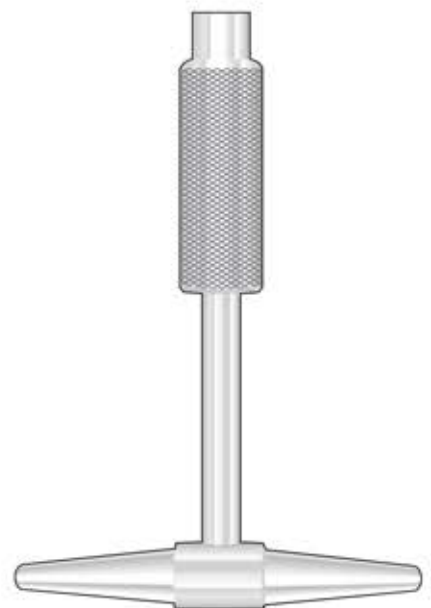

LS-240
80 mm

LS-233
 Komplet mit - Complete with
 Completo con - Completos con
 Completes avec:
 1 **LS-236**
 1 **LS-229**
 1 **LS-241**

Attacco AO

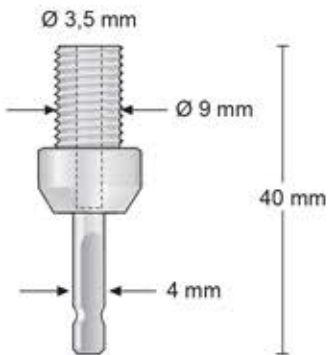

LS-227
40 mm

Inox
 ORIGINAL JACOBS

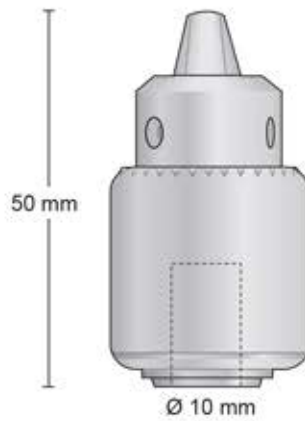

LS-236
50 mm



LS-241
52 mm

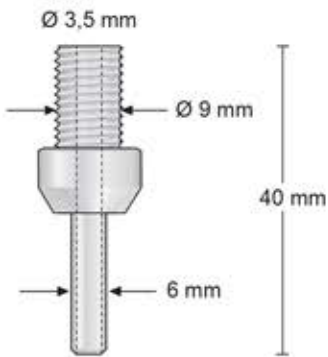

LS-228
40 mm

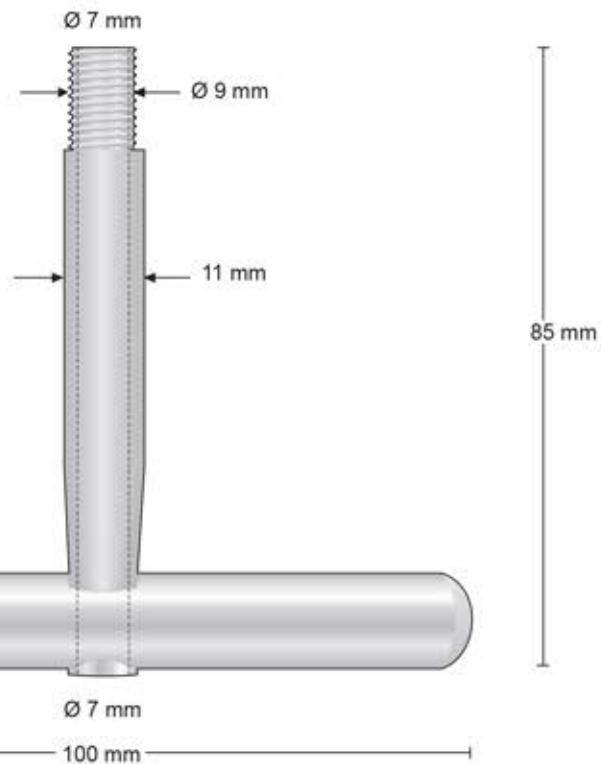

LS-229
85 mm

LS-239
 Komplet mit - Complete with
 Completo con - Completos con
 Completes avec:
 1 LS-236
 1 LS-237
 1 LS-238
 1 LS-241

Inox
 ORIGINAL JACOBS

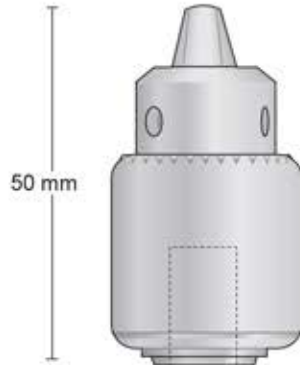

Ø 10 mm
LS-236
 50 mm

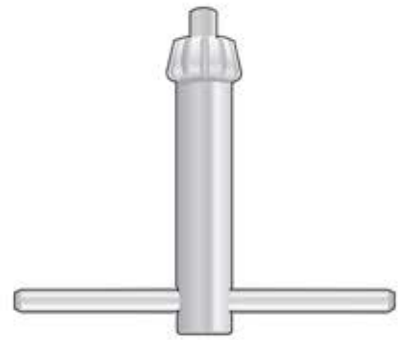

LS-241
 52 mm

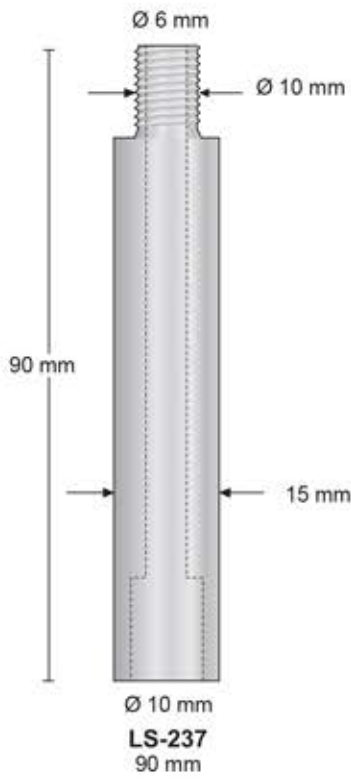

Ø 10 mm
LS-237
 90 mm

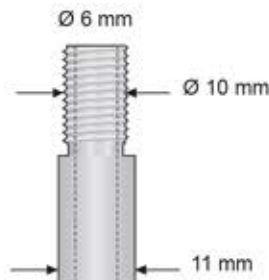

LS-238
 130 mm

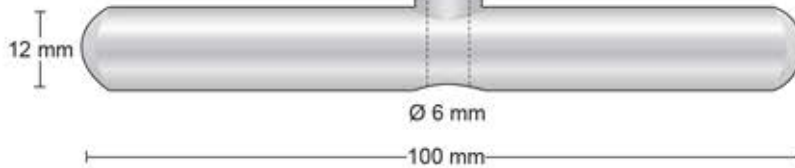

Inox
Ap. 7 mm



LS-232
130 mm

Von Handt zu spannen
Tightened by hand
Con chiusura a mano



LS-231
32 mm

Inox
Spannbereich
0 - 3 mm



LS-222

Inox
Spannbereich
0,8 - 6 mm



LS-224

Inox
Ap. 6,3 mm

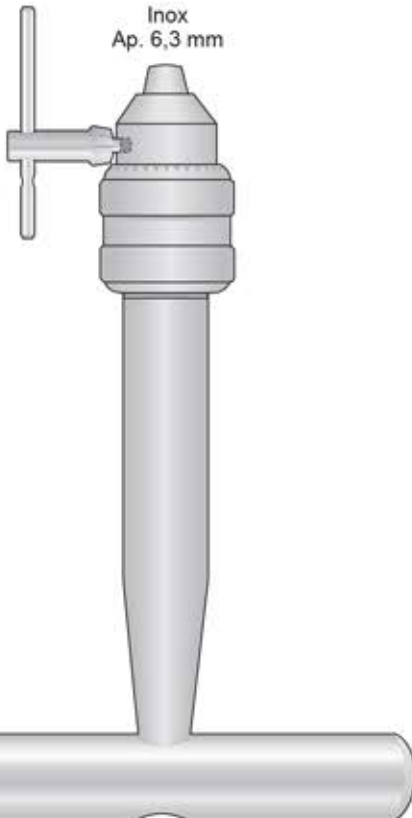

LS-230
130 mm

Inox
Ap. 7 mm

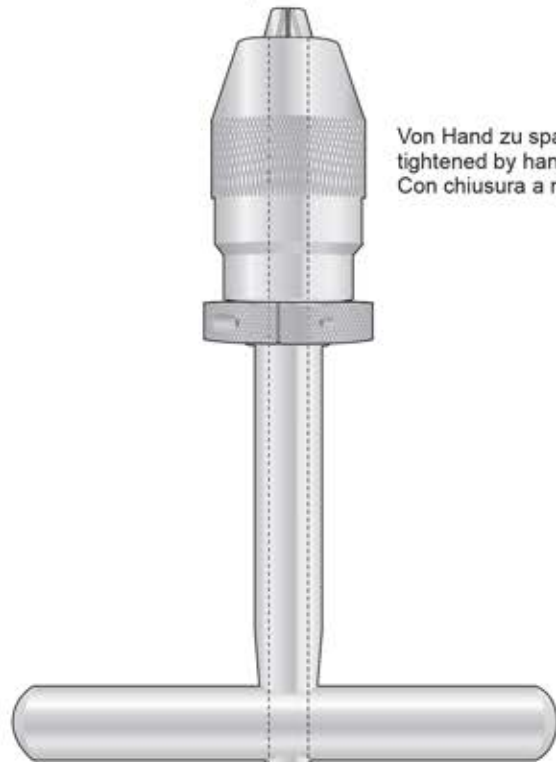

Von Handt zu spannen
tightened by hand
Con chiusura a mano

LS-234
135 mm

FR-20

FR-21 FR-22 + FR-23 FR-24 FR-25 FR-26
 Komplet, mit Fräsern Fig. 1-4 und Verlängerungsstück
 Complete, with burrs no. 1-4 and extension piece
 Completo, con fresa Fig. 1-4 e giunto di prolungamento
 Completo, con fresas no. 1-4 y pieza de prolongación
 Complet, avec fraises no. 1-4 et pièce de rallonge



Verlängerungsstück
 Extension Piece
 Giunto di prolungamento
 Pieza de prolongación
 Pièce de rallonge

**HUDSON
 FR-22**



Fig. 1

**HUDSON
 FR-23**
 Ø 9 mm

Kegelfräser
 Conical Burr
 Fresa cuneiforme
 Fresa cónica
 Fraise conique



Fig. 2

**HUDSON
 FR-24**
 Ø 14 mm

Kegelfräser
 Conical Burr
 Fresa cuneiforme
 Fresa cónica
 Fraise conique



Fig. 3

**HUDSON
 FR-25**
 Ø 16 mm

Kugelfräser
 Spherical Burr
 Fresa sferica
 Fresa esférica
 Fraise spherique



Fig. 4

**HUDSON
 FR-26**
 Ø 22 mm

Kugelfräser
 Spherical Burr
 Fresa sferica
 Fresa esférica
 Fraise spherique

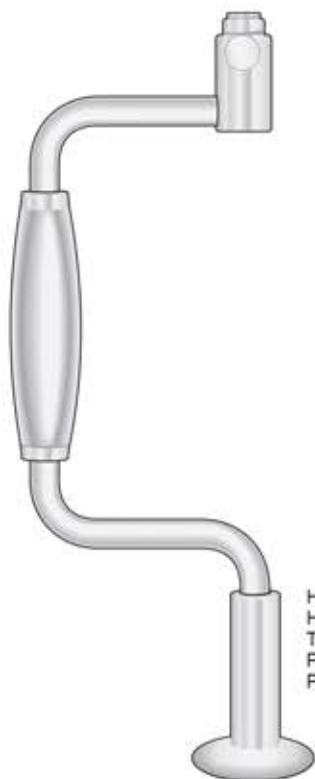

Handbohr allein
 Hand drill only
 Trapano solo
 Perforador suelto
 Perforateur seul

**HUDSON
 FR-21**
 280 mm



Fig. 5

**ADSON
 FR-27**
 Ø 15 mm

Bohrer
 Burr
 Punta
 Fresa
 Fraise



Fig. 6

**Mc KENZIE
 FR-28**
 Ø 13 mm

Bohrer
 Burr
 Punta
 Fresa
 Fraise



Fig. 7

**CUSHING
 FR-29**
 Ø 14 mm

Flachbohrer
 Flat Trephine
 Trapano piatto
 Taladro plano
 Fraise plate



Fig. 8

FR-30
 Ø 2 mm

Spiralbohrer
 Twist Drill
 Punta a spirale
 Broca espiral
 Méche hélicoïdale



LS-321
140 mm

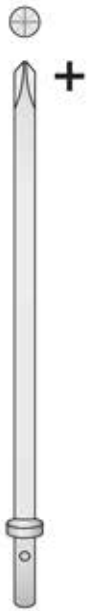

LS-322
140 mm



LS-323
140 mm



LS-324
140 mm



LS-325
140 mm

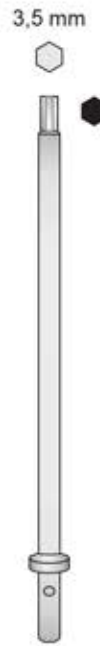

LS-326
140 mm

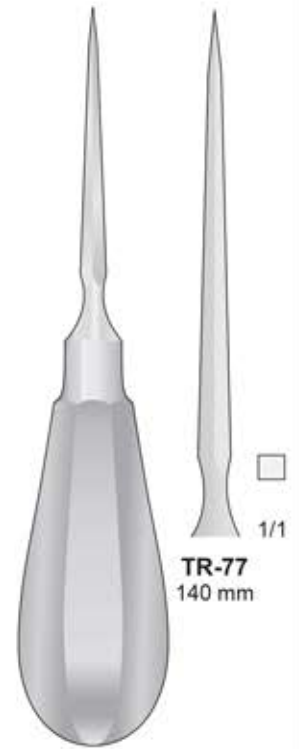

TR-77
140 mm

LS-330
(LS-321 + LS-322 + LS-323 + LS-324 + LS-325 + LS-326 + LS-329)
Schraubenzieher, Set mit Etui / Box with screws driver / Scatola con set giraviti
Set de destornilladores / Boîte de jeu de tournevis



LS-329
200x100x40 mm
Etui allein / Box only / Solo scatola
Seul boîte / Caja sola



LS-320
145 mm



UNIVERSAL
LS-235
75 mm



LS-231
32 mm

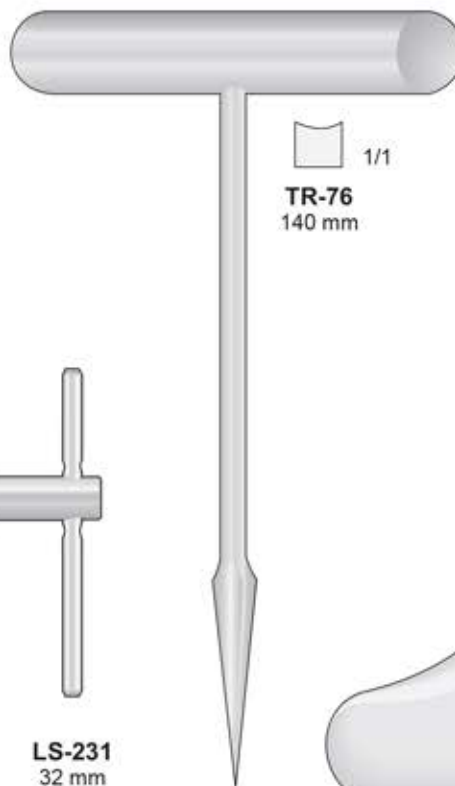

TR-76
140 mm

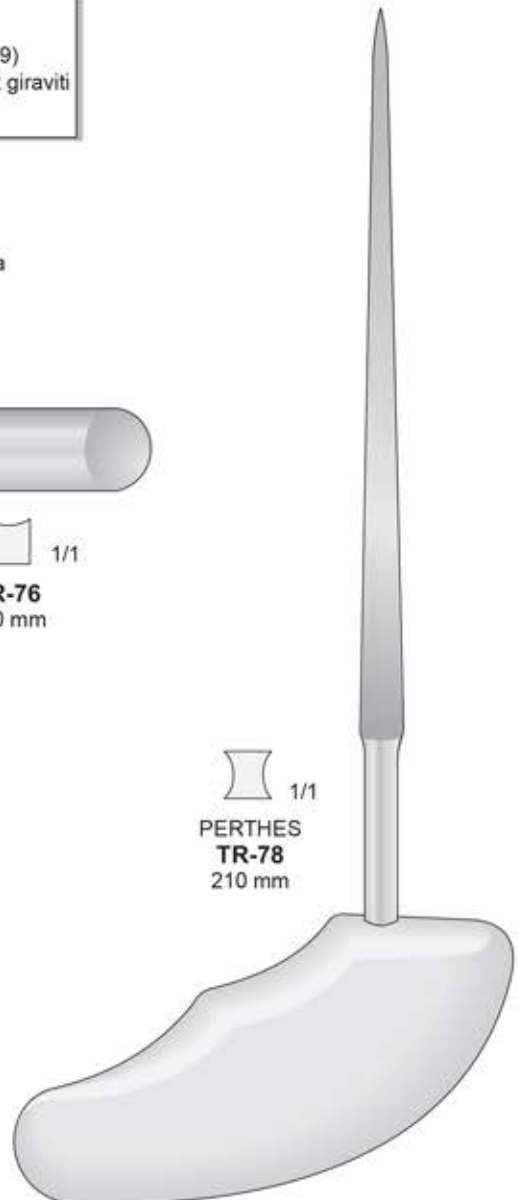

PERTHES
TR-78
210 mm

Schraubenzieher mit Ferrozellgriff
Screws driver with Ferrozell handle
Giraviti con manico di Ferrozell
Destornilladores con mango de Ferrozell
Jeu de tournevis avec poignée en Ferrozell

Schraubenzieher mit Ferrozellgriff
Screws driver with Ferrozell handle
Giraviti con manico di Ferrozell
Destornilladores con mango de Ferrozell
Jeu de tournevis avec poignée en Ferrozell

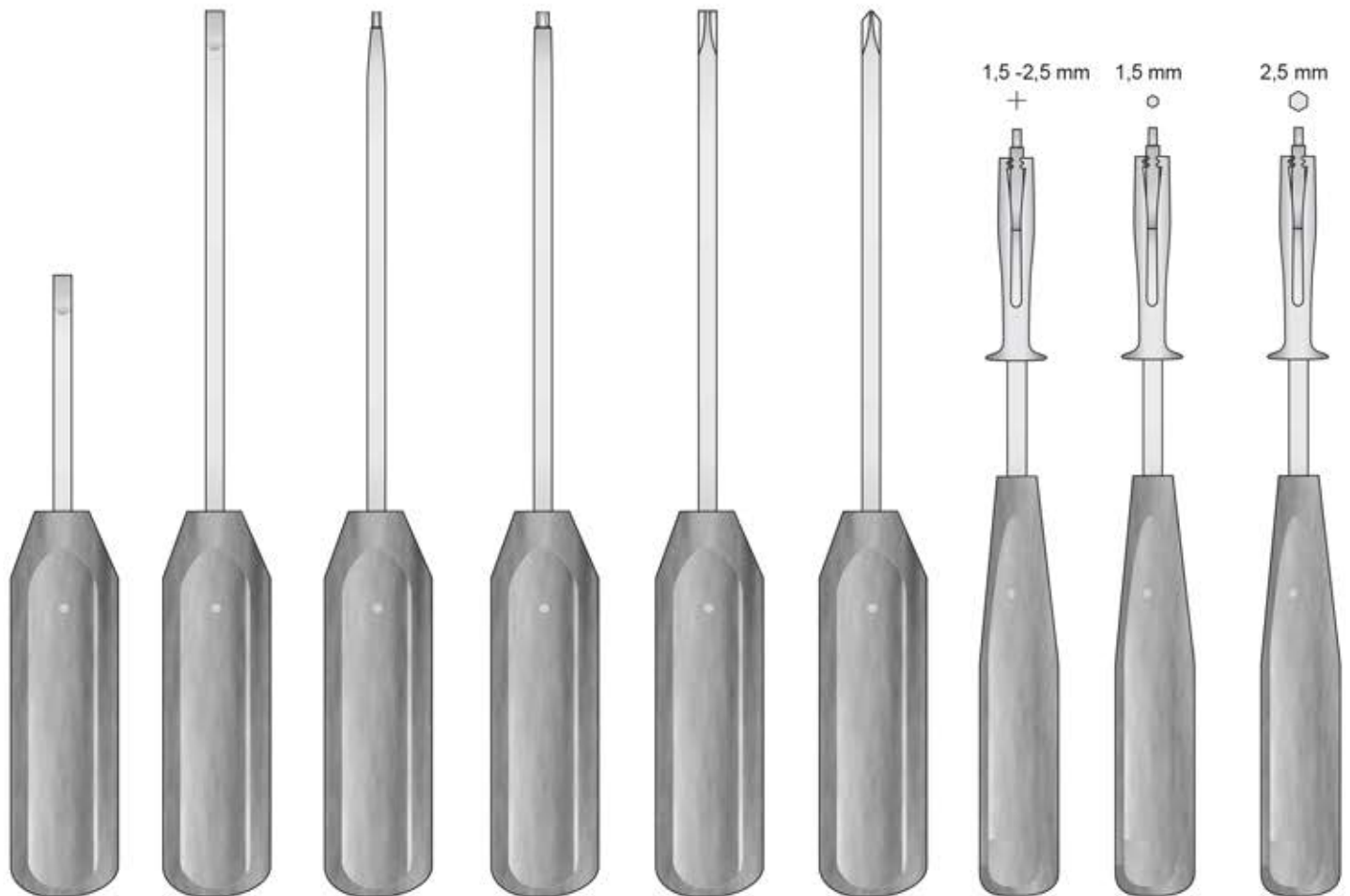
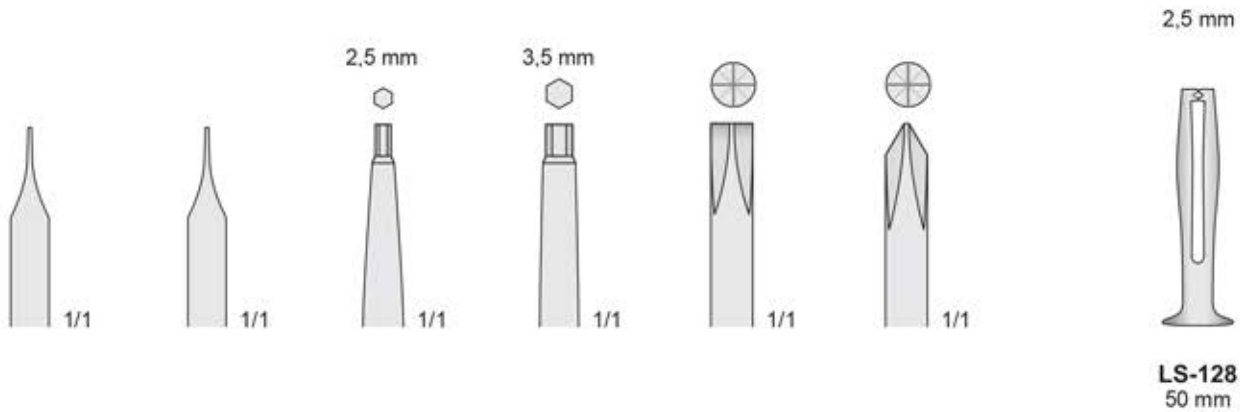

LS-310
170 mm

**LANE
LS-311**
250 mm

LS-312
250 mm

LS-313
250 mm

LS-314
250 mm

**PHILIPS
LS-315**
250 mm

LS-316
195 mm

LS-317
195 mm

LS-318
195 mm

Drahtinstrumentarium
Wire instrument set
Strumenti per filo di cerchiaggio
Instrumental para cerclaje
Instruments à fil

Draht weich
Wire soft
Filo malleabile
per compattare l'osso
Alambre ligadura
Fil à os



10 mt.

Ø/Diam.	Codice
0,2 mm	KI-202
0,3 mm	KI-203
0,4 mm	KI-204
0,5 mm	KI-205
0,6 mm	KI-206
0,7 mm	KI-207
0,8 mm	KI-208
0,9 mm	KI-209
1,0 mm	KI-210
1,2 mm	KI-211
1,5 mm	KI-212



LOUTE
KI-322
220 mm

Drahtspanninstrument
Bone wire tighteners
Strumenti tendifili
Tensor cierra-hilos
Tendeur serre fils



LS-110
130 mm

Bohrbüchsen zu Knochenplatten - Drill guides - Centrori guida punte - Guide méche

Codificazione del colore
 verde = centrico
 oro = eccentrico

Per trapano \varnothing 2,0 mm
 Per viti da corticale \varnothing 2,7 mm

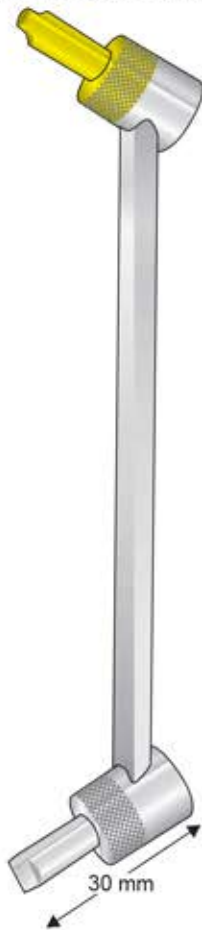

LS-91
140 mm

Per trapano \varnothing 2,5 mm
 Per viti da corticale \varnothing 3,5 mm



LS-90
140 mm

Per trapano \varnothing 3,2 mm
 Per viti da corticale \varnothing 4,5 mm

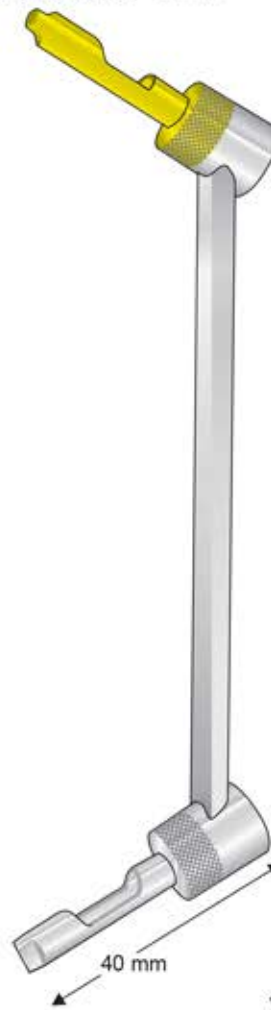

LS-92
165 mm

Per trapano \varnothing 3,2 mm
 Per viti da corticale \varnothing 4,5 mm

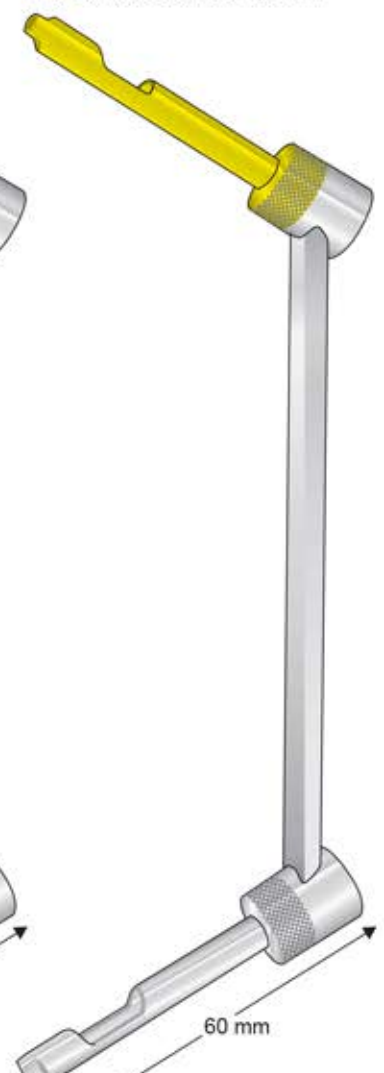

LS-93
170 mm

Bohrbüchsen zu Knochenplatten - Drill guides - Centratori guida punte - Guide méche

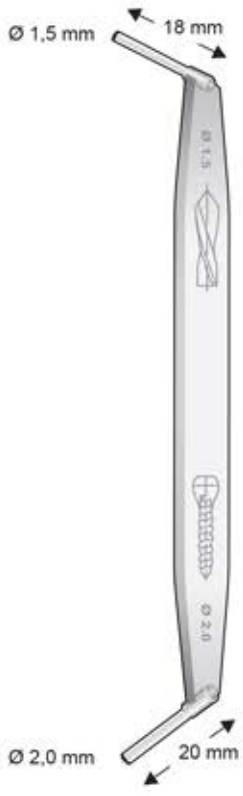

LS-73
120 mm



LS-74
120 mm



LS-75
120 mm



LS-80
110 mm



LS-81



LS-82



LS-83
105 mm



LS-84
160 mm



LS-85

Bohrbüchsen zu Knochenplatten - Drill guides - Centratori guida punte - Guide méche

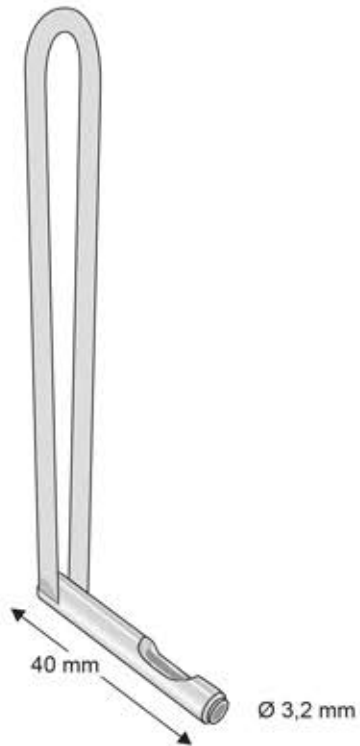

LS-117
125 mm

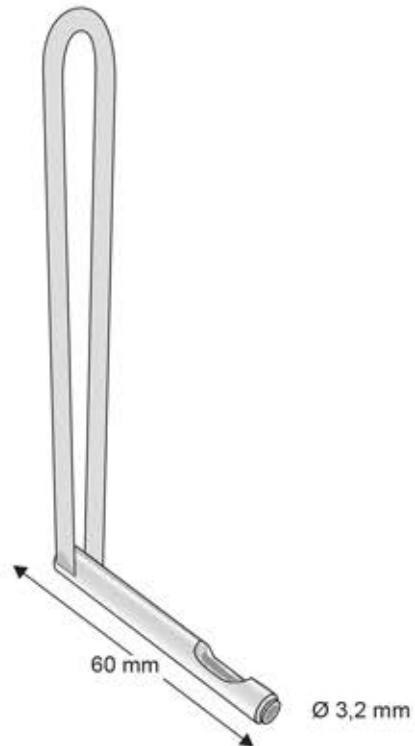

LS-124
125 mm

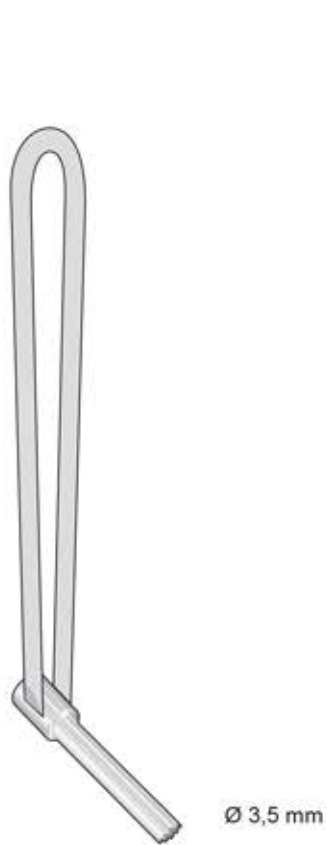

LS-116
125 mm

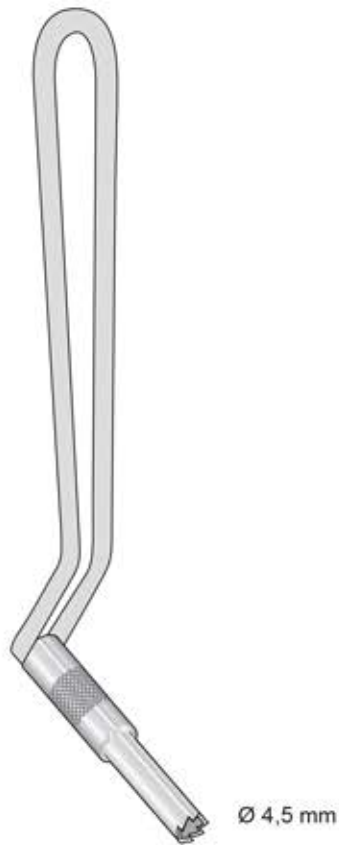

LS-119
150 mm

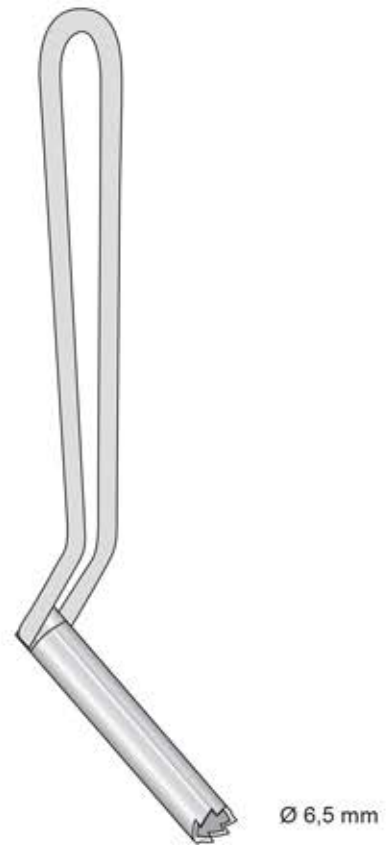

LS-121
150 mm



LS-96



LS-97

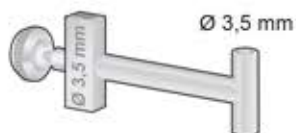

LS-98

LS-95
Complete with 3 guide
Completo di 3 guide
LS-94+LS-96+LS-97+LS-98

LS-94
Drill guide only
Centratore solo

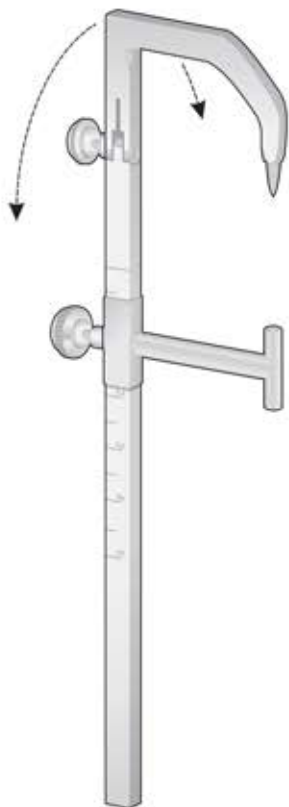

LS-95
145 mm

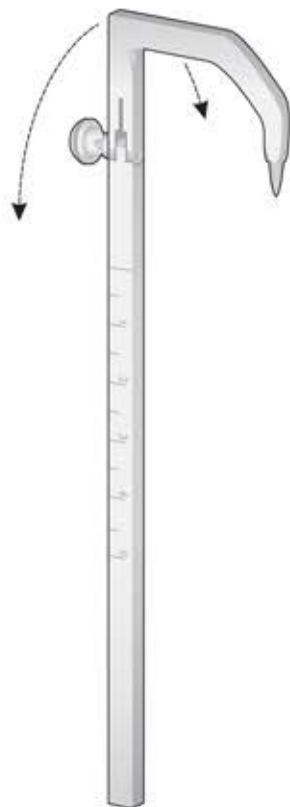

LS-94
145 mm

Steckbohrbüchsen
Manicotto dentato
Centrapunte
Insert-drill



Ø Außen	Ø Für Bohrer
Ø Outside	Ø For drills
Ø Esterno	Ø Per punte
Ø Exterior	Ø Para agujas
Ø Extérieur	Ø Pour Mèches

Cod. Art.	Ø Außen	Ø Für Bohrer
LS-113	4,5 mm	3,2 mm
LS-114	3,5 mm	2 mm
LS-115	3,5 mm	2,7 mm

Gewebeschutzhülsen
Guida per punte elicoidali

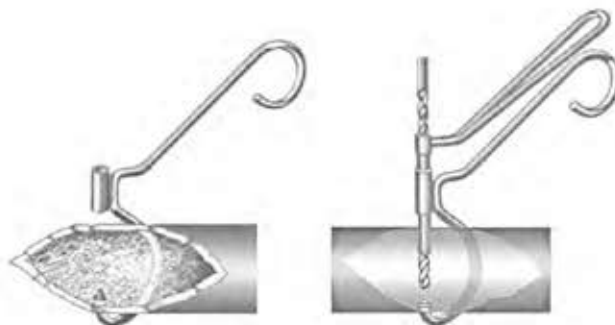

Innen Ø 6,5 mm
Inside Ø 6,5 mm
Interno Ø 6,5 mm
Interior Ø 6,5 mm
Intérieur Ø 6,5 mm

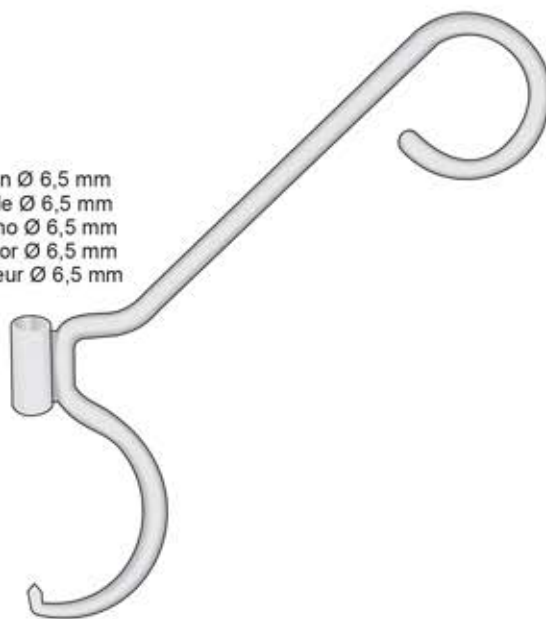

LS-112



Measuring Instruments
Messinstrumente
Instruments à mesurer
Instrumentos de medición
Strumenti per misura

Screw depth gauges, to select proper length of screw
 Misuratore di lunghezza per viti
 Instruments à mesurer de longueur de vis
 Instrumento para medir el largo del tornillo

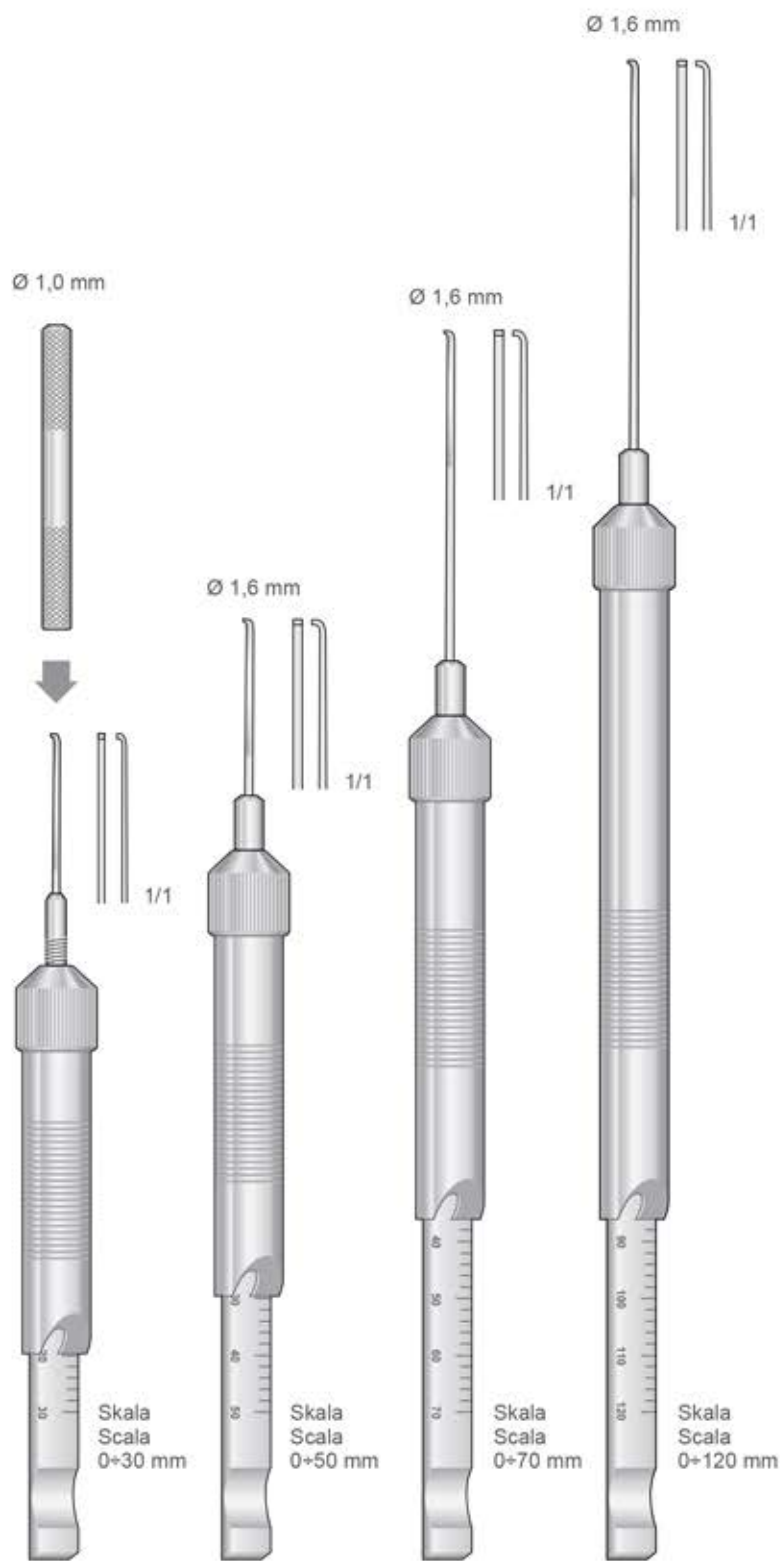

KI-10
 Meßlehre für Kirschnerdrähte
 Measuring Gauge for K-wire
 Misuratore per chiodi Kirschner
 Medidor para agujas Kirschner

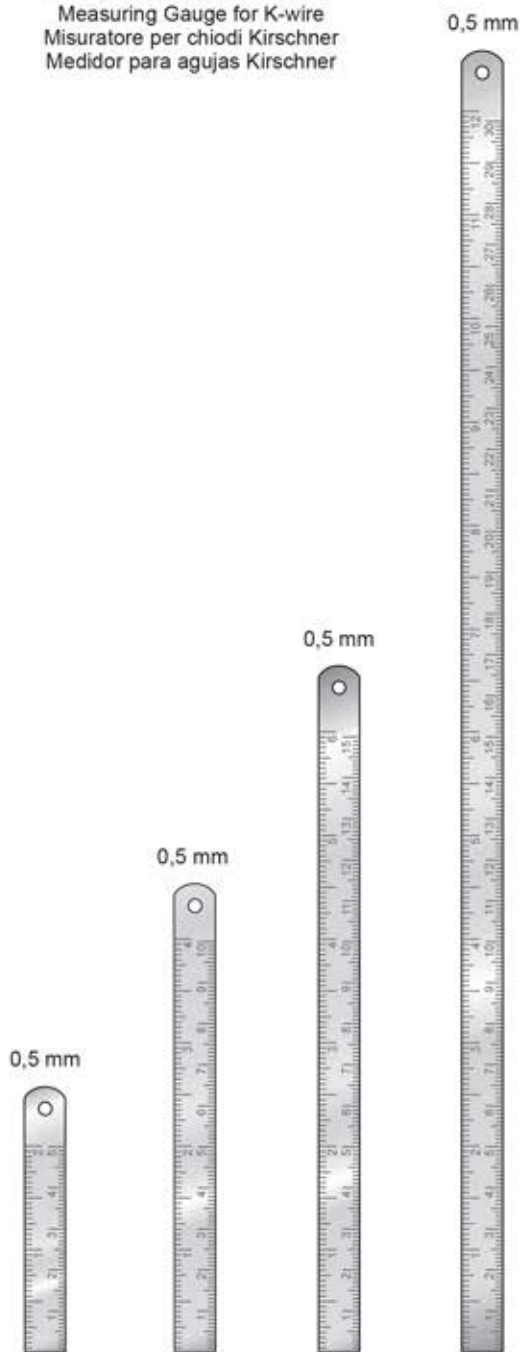

LS-199
138 mm

LS-200
156 mm

LS-201
190 mm

LS-202
285 mm

LS-07
50 mm

LS-08
100 mm

LS-09
150 mm

LS-06
300 mm

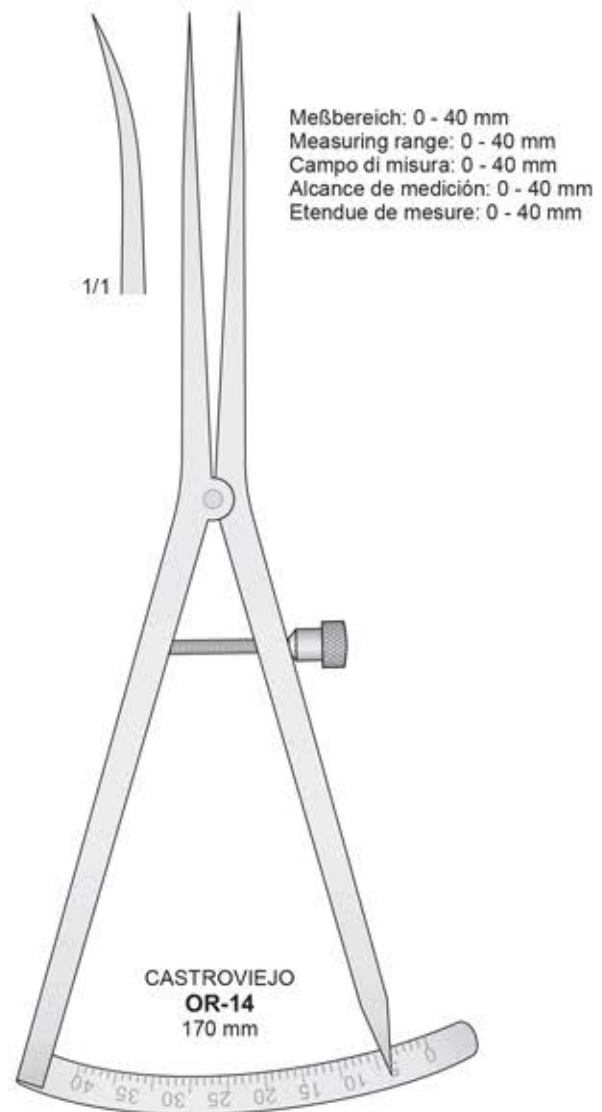
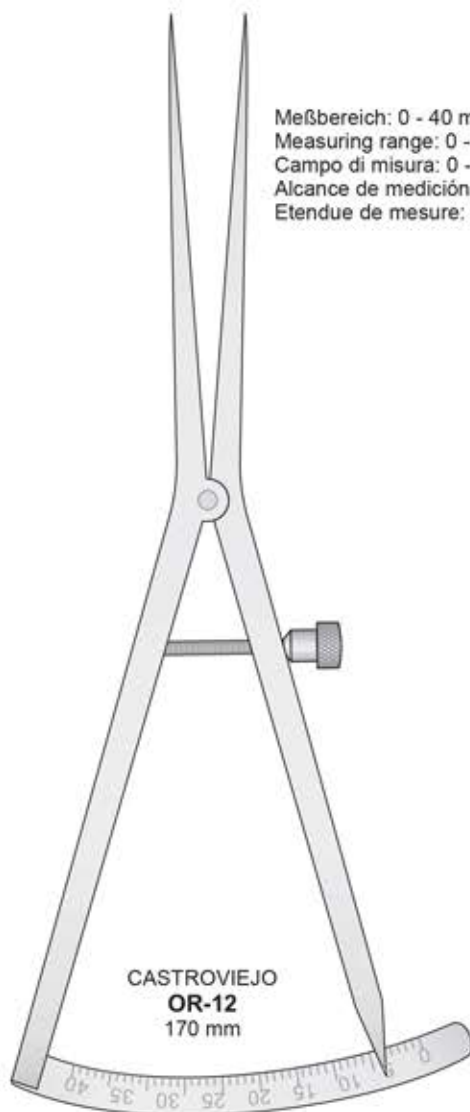

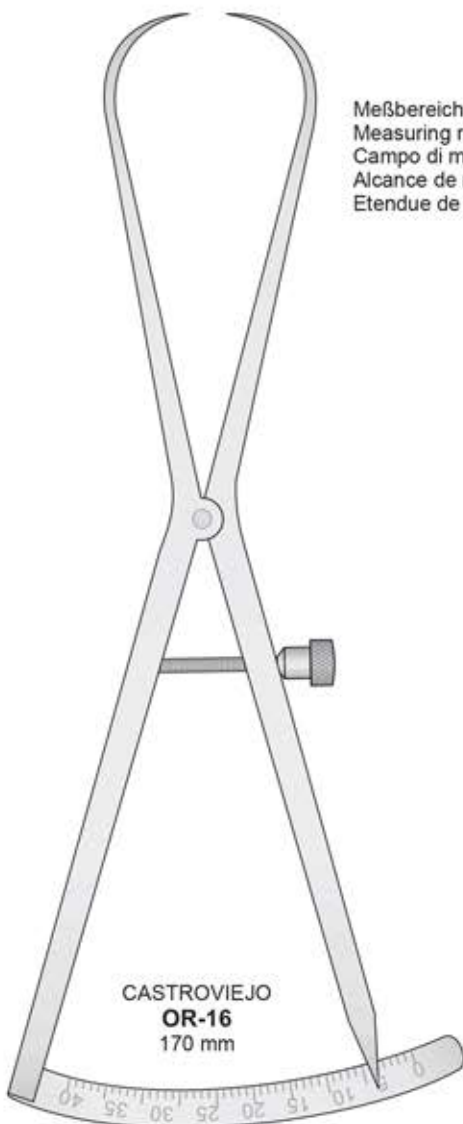

Meßbereich: 0 - 40 mm
 Measuring range: 0 - 40 mm
 Campo di misura: 0 - 40 mm
 Alcance de medición: 0 - 40 mm
 Etendue de mesure: 0 - 40 mm

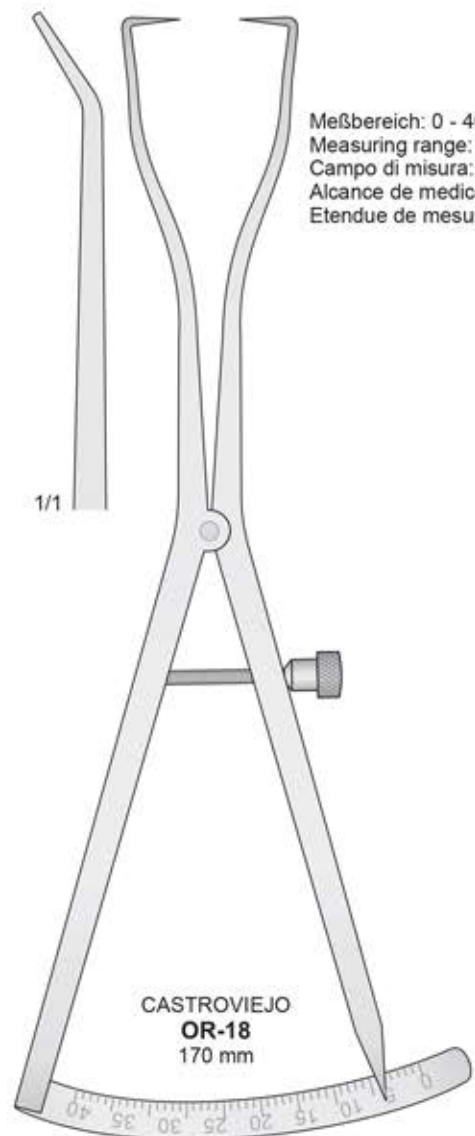

Meßbereich: 0 - 40 mm
 Measuring range: 0 - 40 mm
 Campo di misura: 0 - 40 mm
 Alcance de medición: 0 - 40 mm
 Etendue de mesure: 0 - 40 mm

Meßbereich: 0 - 40 mm
 Measuring range: 0 - 40 mm
 Campo di misura: 0 - 40 mm
 Alcance de medición: 0 - 40 mm
 Etendue de mesure: 0 - 40 mm

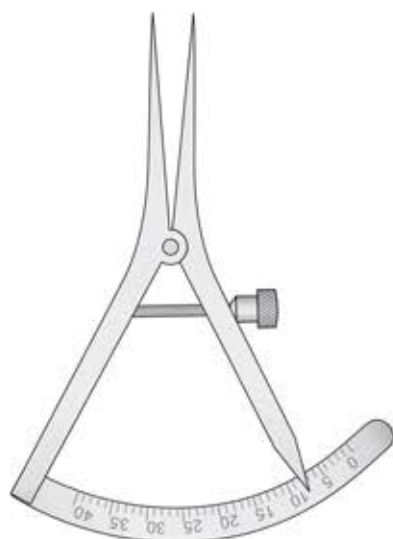

CASTROVIEJO
OR-11
 90 mm

Meßbereich: 0 - 40 mm
 Measuring range: 0 - 40 mm
 Campo di misura: 0 - 40 mm
 Alcance de medición: 0 - 40 mm
 Etendue de mesure: 0 - 40 mm

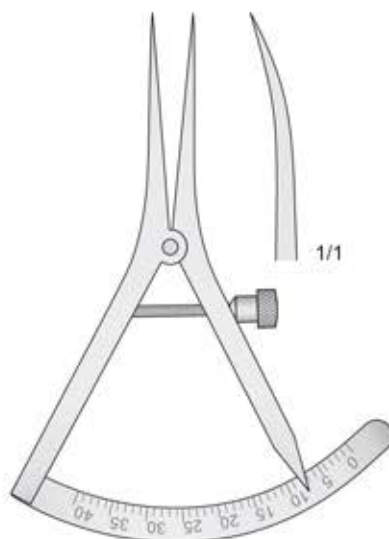

CASTROVIEJO
OR-13
 90 mm

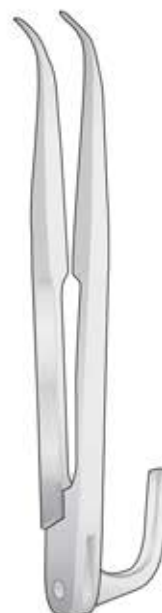

ZIELINSKY
DP-725
 110 mm

Meßbereich: 0 - 15 mm
 Measuring range: 0 - 15 mm
 Campo di misura: 0 - 15 mm
 Alcance de medición: 0 - 15 mm
 Etendue de mesure: 0 - 15 mm

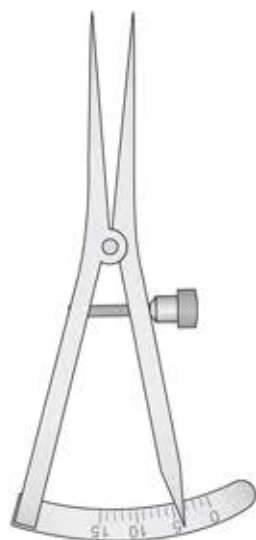

CASTROVIEJO
OR-15
 90 mm

Meßbereich: 0 - 20 mm
 Measuring range: 0 - 20 mm
 Campo di misura: 0 - 20 mm
 Alcance de medición: 0 - 20 mm
 Etendue de mesure: 0 - 20 mm

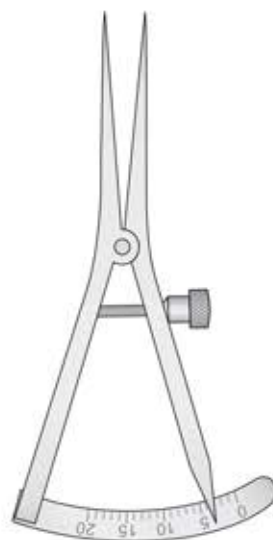

CASTROVIEJO
OR-17
 90 mm

Meßbereich: 0 - 20 mm
 Measuring range: 0 - 20 mm
 Campo di misura: 0 - 20 mm
 Alcance de medición: 0 - 20 mm
 Etendue de mesure: 0 - 20 mm

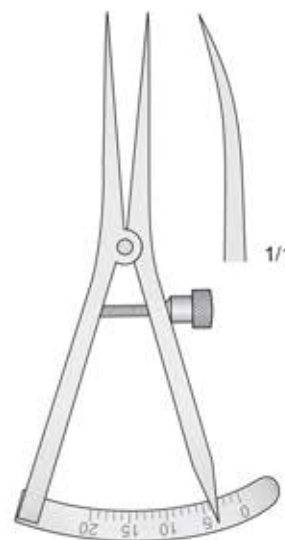

CASTROVIEJO
OR-19
 90 mm

Forceps for plattes

Biege und schränkhebel
Pinces à courber pour plaques
Pinzas para placas
Pinze e chiavi per placche

Wire Guides

Drahtumführungsnadel
Aiguilles passe-fils
Agujas pasa hilos
Passafili

Needle Holders

Nadelhalter
Porte-aiguilles
Porta-agujas
Port'aghi

Cutting Pliers

Schneidezangen
Pinces coupante
Alicates de corte
Tronchesi di taglio

Biegezange - Bending pliers - Pinze piegaplacche - Pinces à plier



LS-405
200 mm



LS-406
240 mm



LS-400

Biegepresse - Bending press - Pressa piegaplacche - Presse pour plier

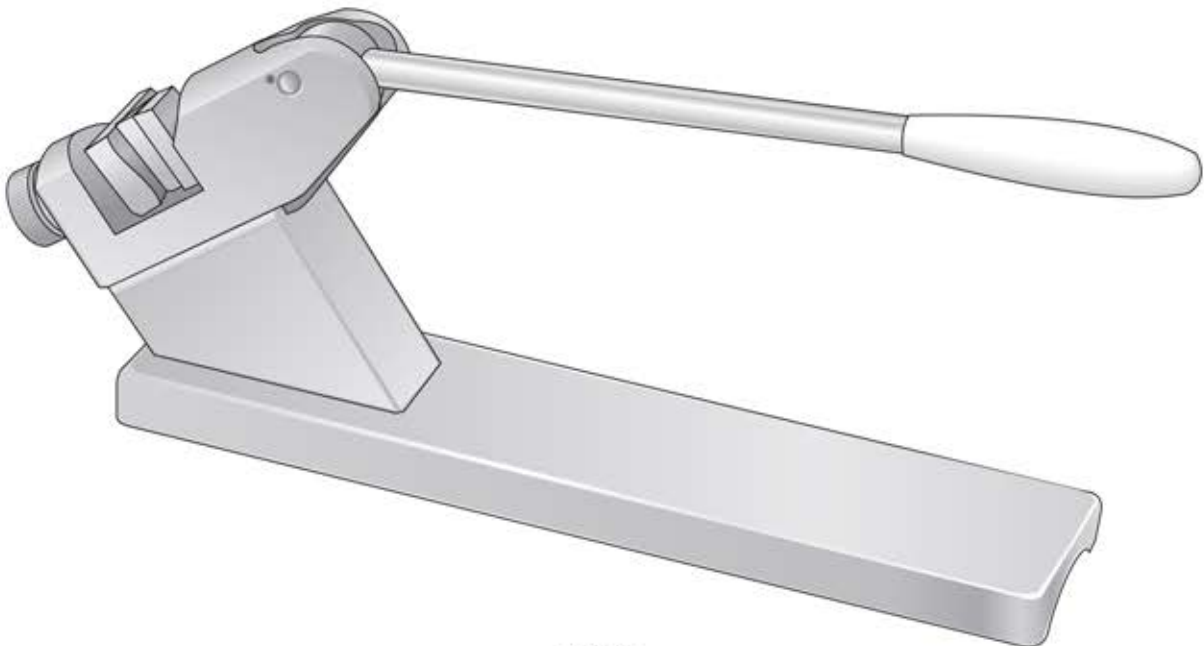

LS-410

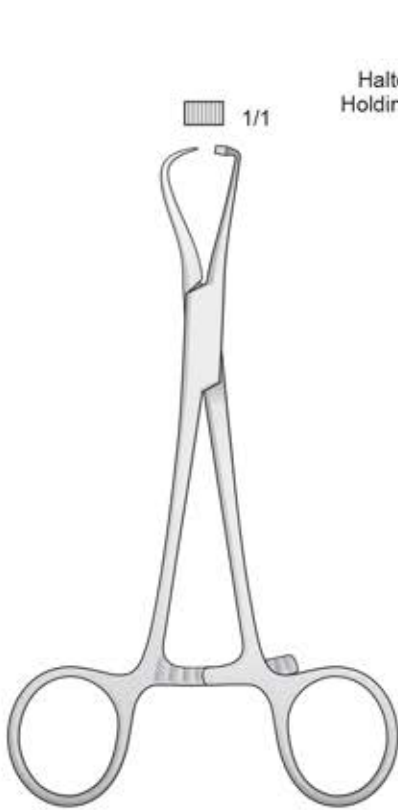

LS-76
120 mm

Haltezange für platten
Holding forceps for plates

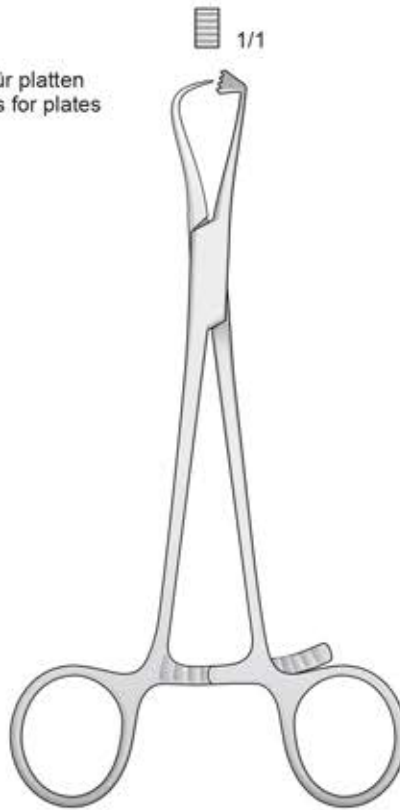

LS-78
125 mm

For standard plates
Für Standard-Platten

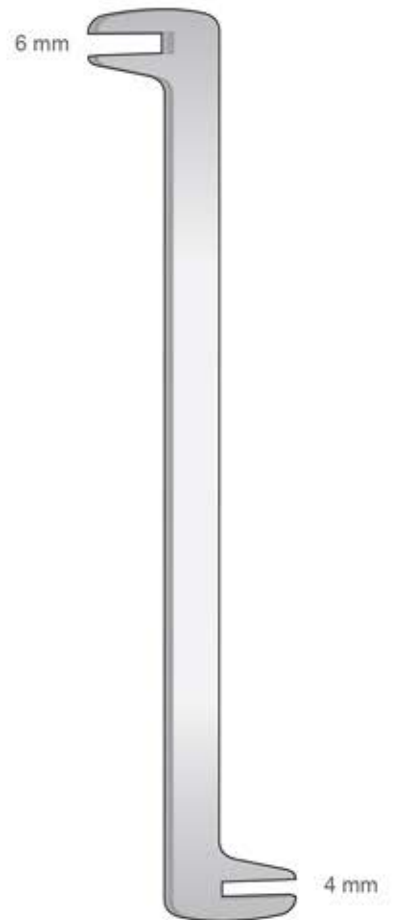

LS-105
250 mm

Für Standard-Platten
For standard plates

Biege und Schränkhebel für kleine platten
Bending irons, for small plates

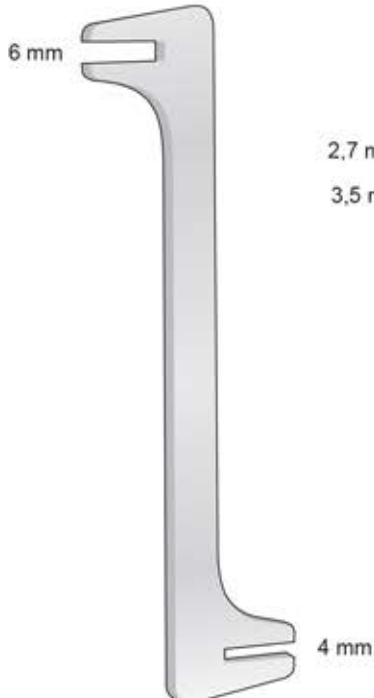

LS-101
180 mm



LS-103 100 mm
LS-102 140 mm

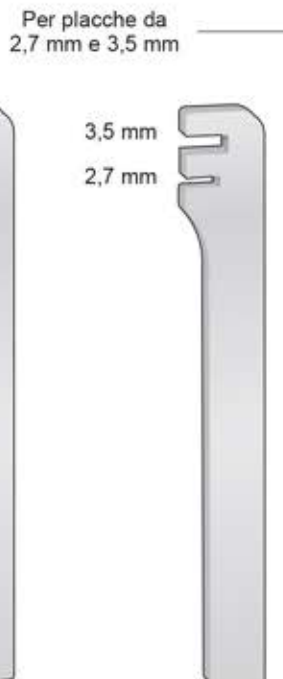

LS-123 100 mm
LS-122 140 mm



LS-104
100 mm



DEMEL
BM-12/BM-14

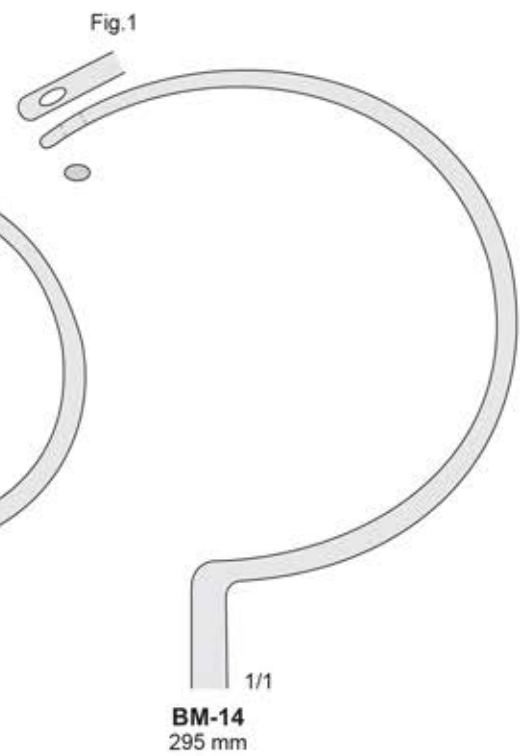
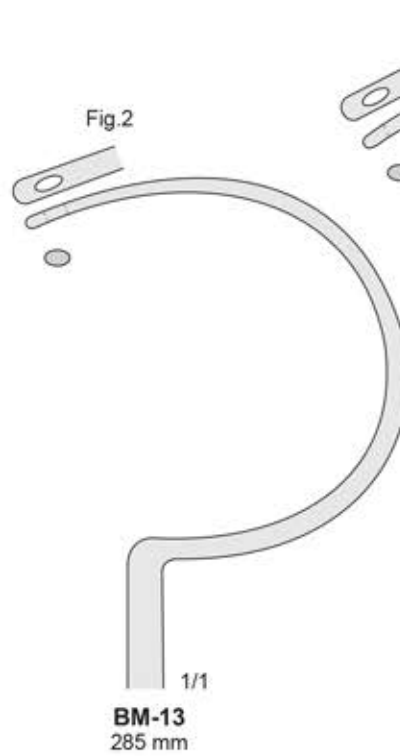
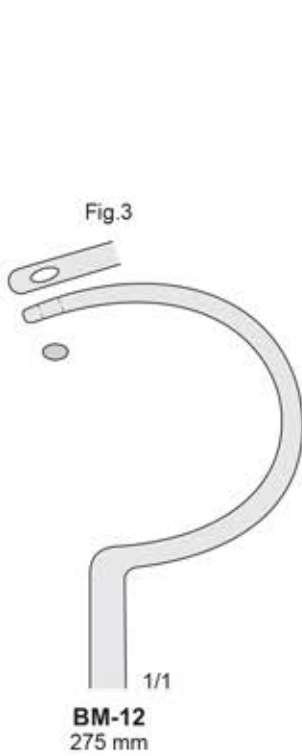

BM-10
225 mm

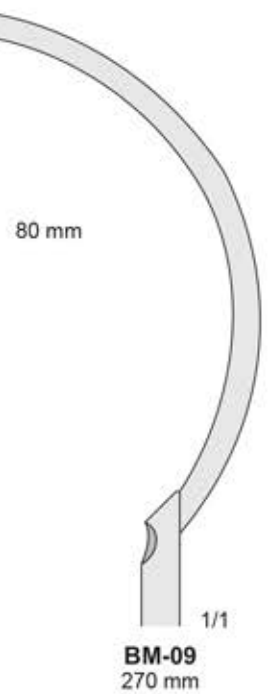
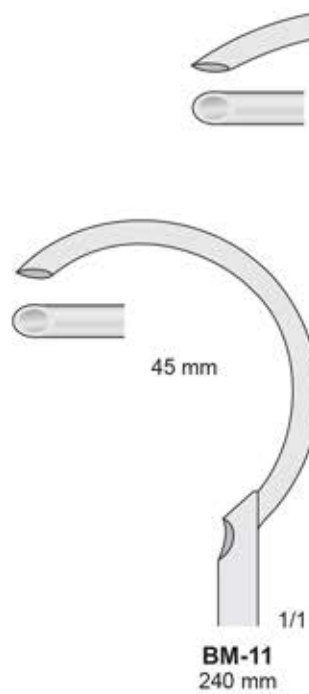
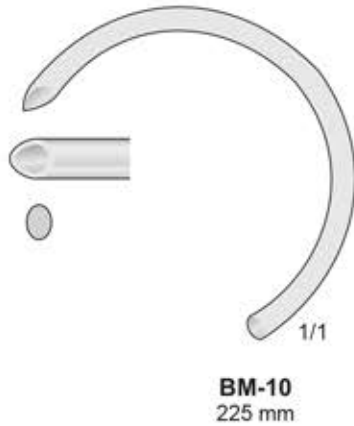

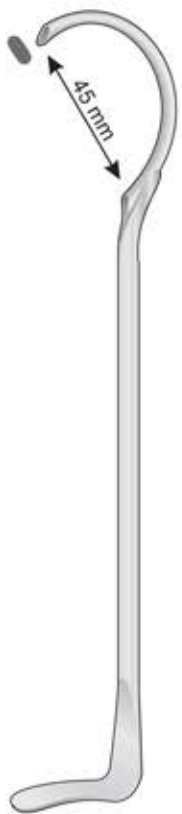

BM-50
185 mm

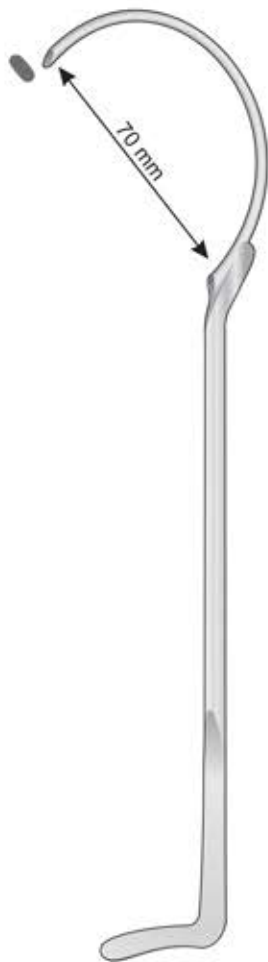

BM-51
235 mm

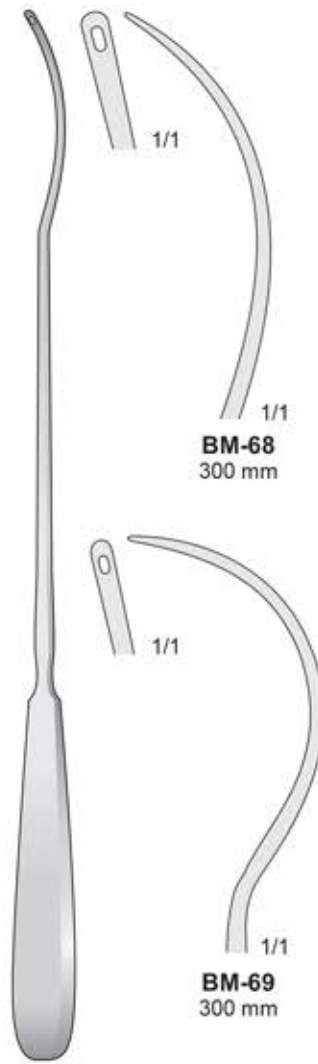

BRUNNER
BM-68/BM-69
300 mm

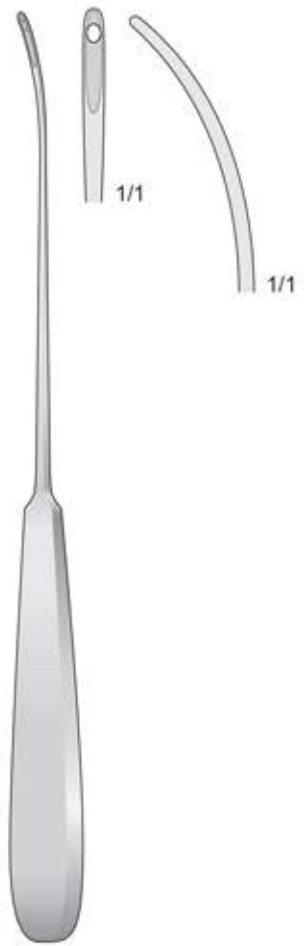

BM-74
230 mm

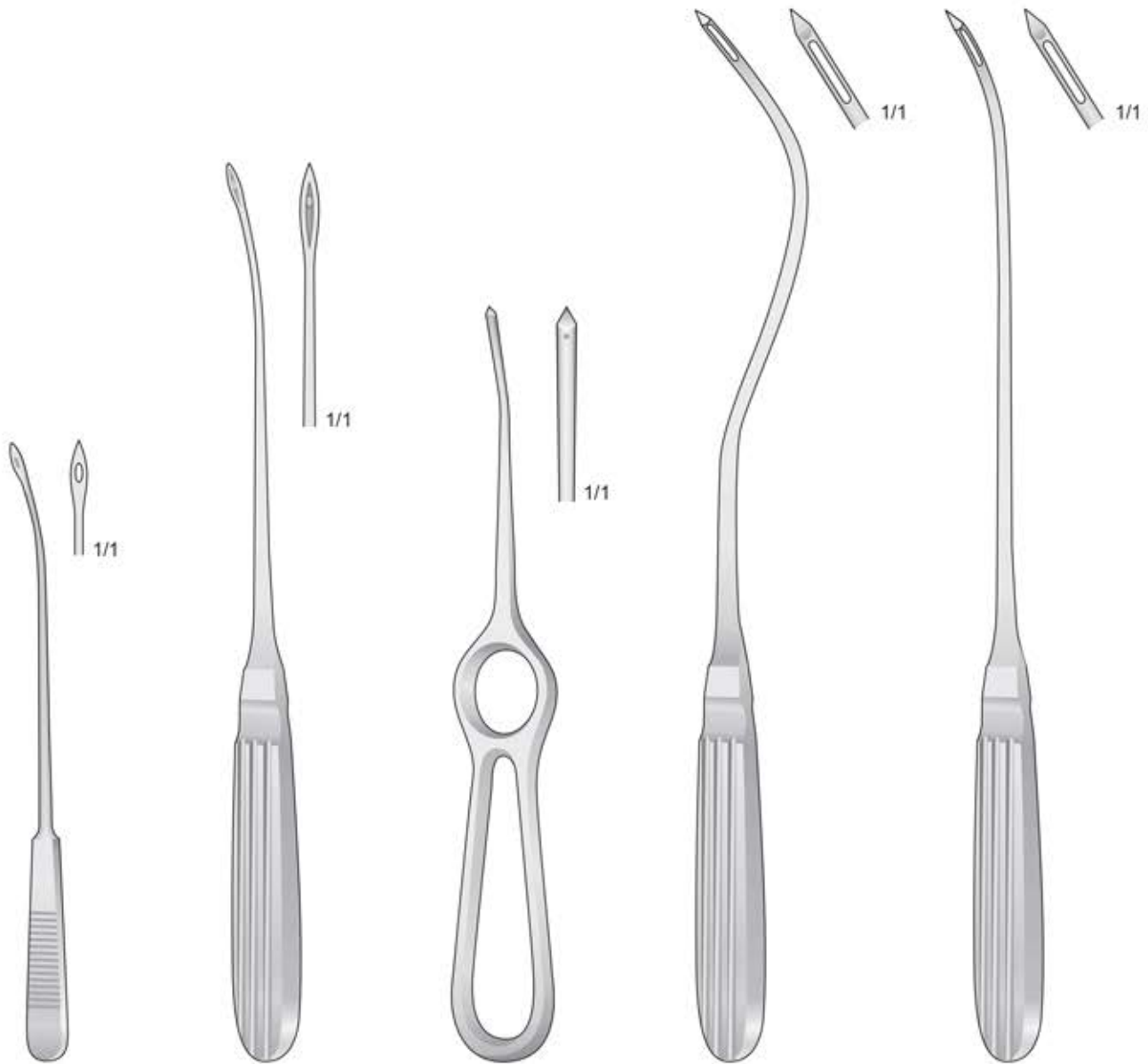

OBWEGESER
DO-30
140 mm

OBWEGESER
DO-31
230 mm

DO-32
180 mm

SANDERS-BROWN
DO-44
290 mm

SANDERS-BROWN
DO-49
300 mm

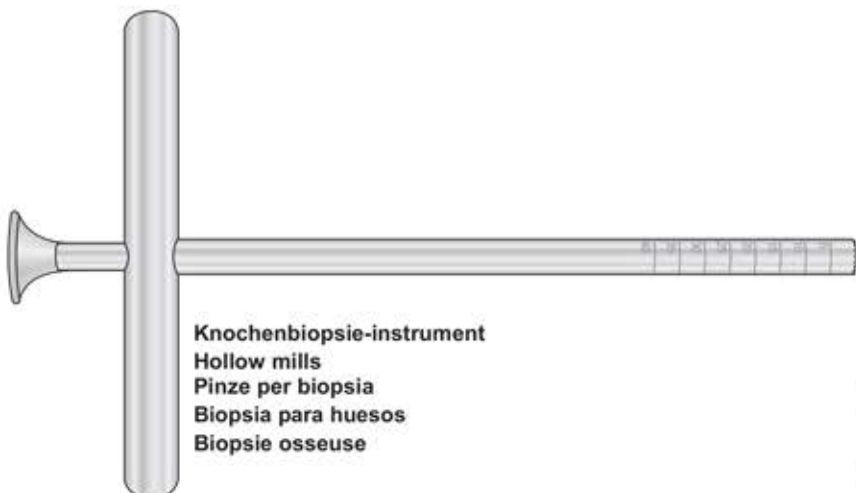

Knochenbiopsie-instrument
Hollow mills
Pinze per biopsia
Biopsia para huesos
Biopsie osseuse



FK-92
170 mm

Innen	Außen
Inside	Outside
Interno	Esterno
Intérieur	Extérieur
Intérieur	Extérieur
Ø 3 mm	Ø 4 mm



FK-90
170 mm

Innen	Außen
Inside	Outside
Interno	Esterno
Intérieur	Extérieur
Intérieur	Extérieur
Ø 3,9 mm	Ø 5 mm



FK-91
170 mm

Innen	Außen
Inside	Outside
Interno	Esterno
Intérieur	Extérieur
Intérieur	Extérieur
Ø 6,4 mm	Ø 8 mm

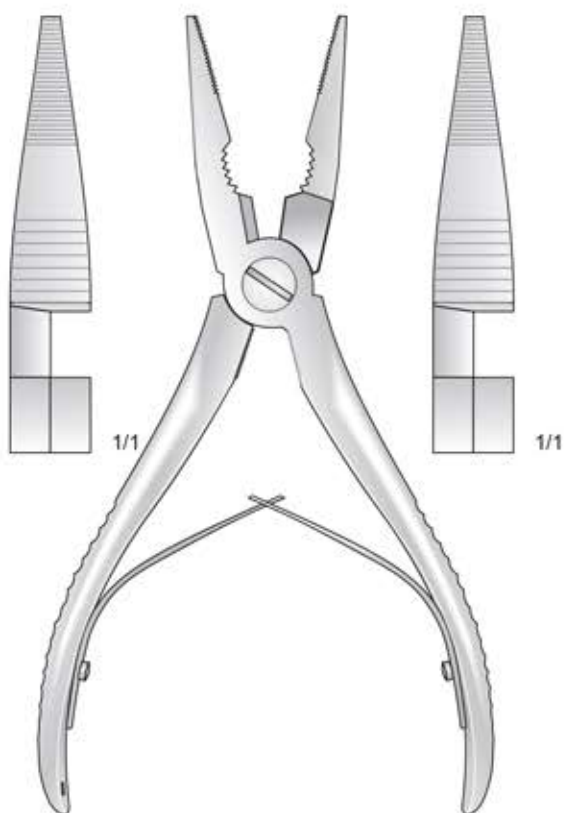

LX-135
175 mm

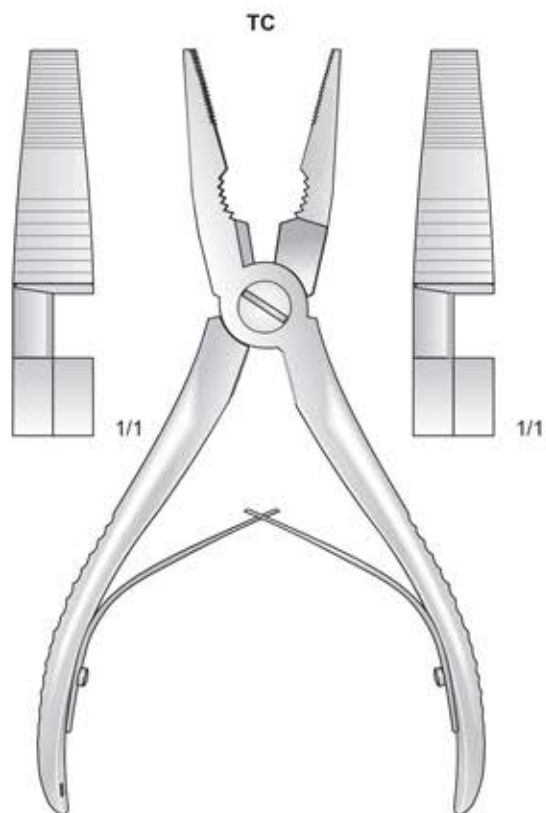

LX-136
165 mm

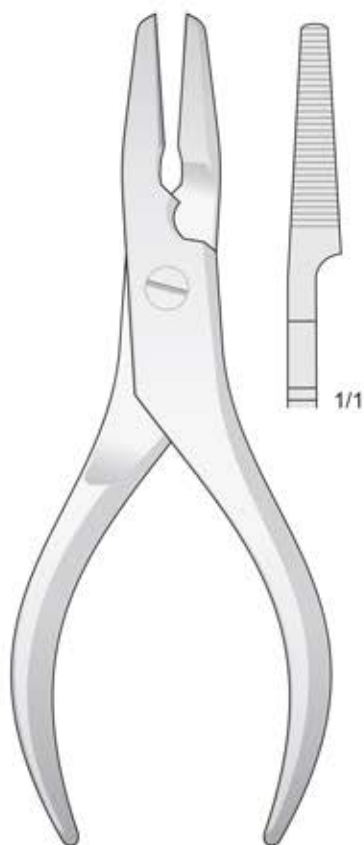

LX-134
160 mm



LX-137
200 mm

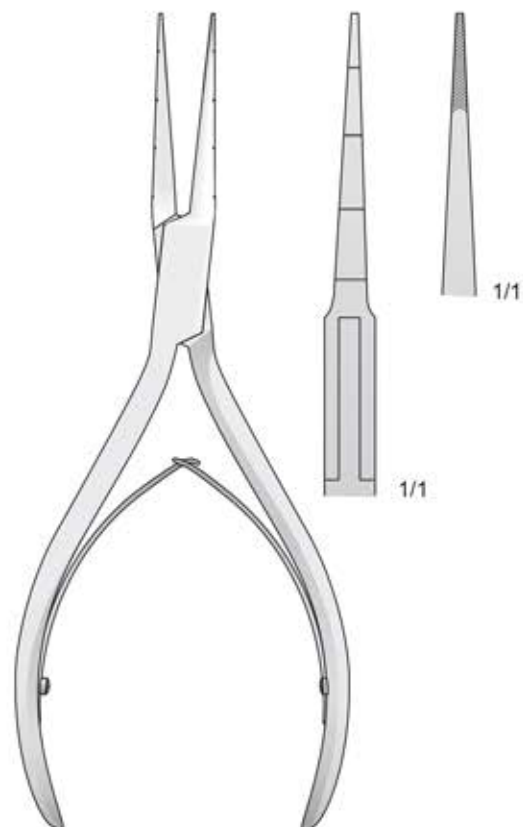

DP-96
150 mm

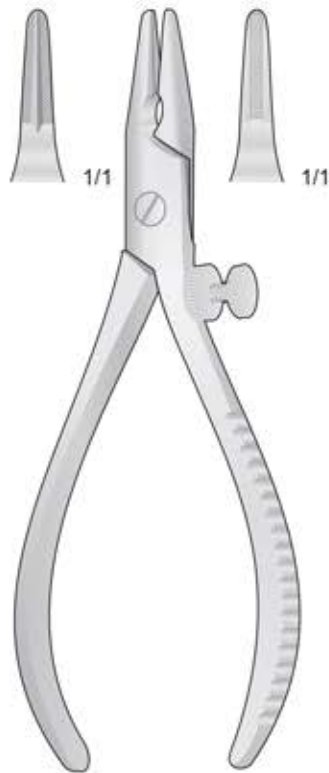

LX-130
140 mm

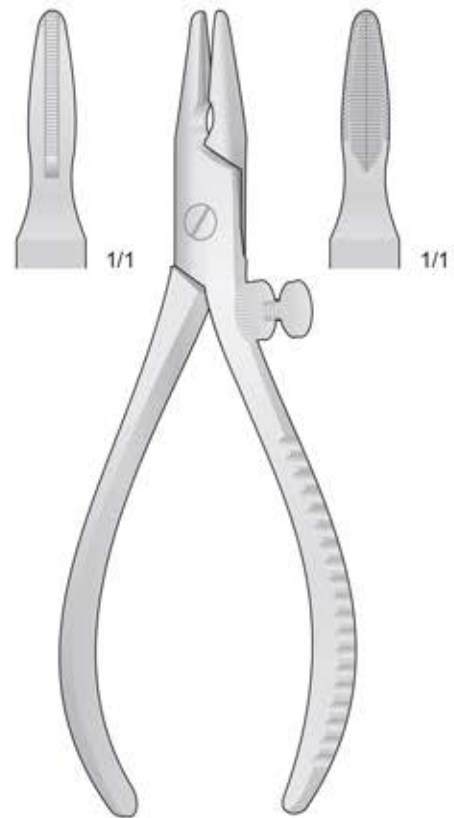

LX-131
180 mm

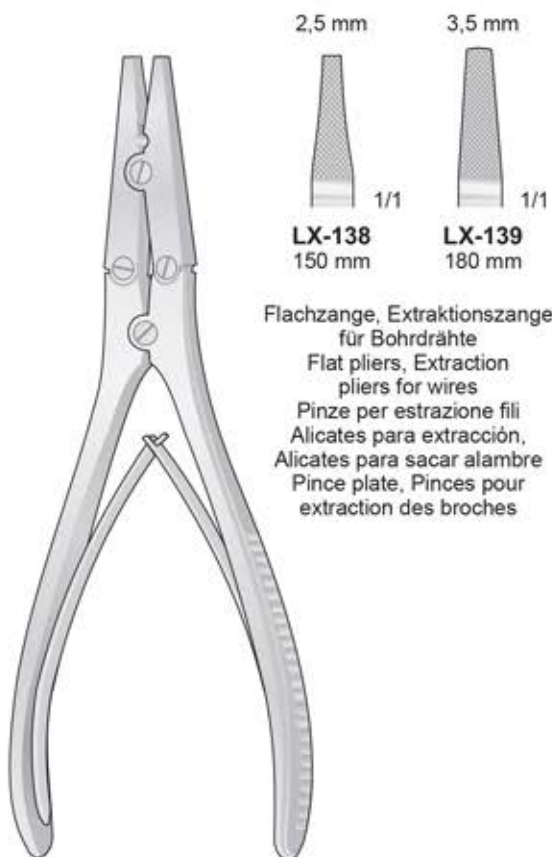

LX-138
150 mm

LX-139
180 mm

Flachzange, Extraktionszange
für Bohrdrähte
Flat pliers, Extraction
pliers for wires
Pinze per estrazione fili
Alicates para extracción,
Alicates para sacar alambre
Pince plate, Pinces pour
extraction des broches

LX-138/LX-139

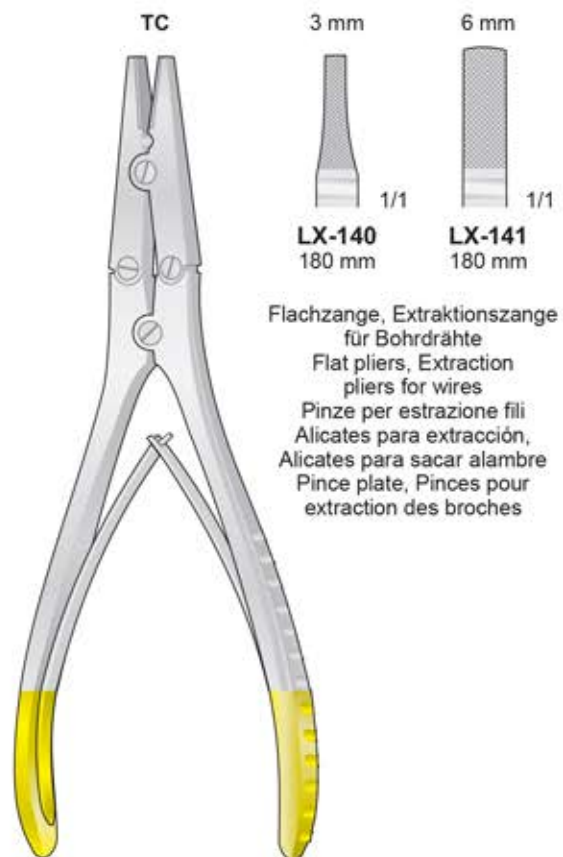

LX-140
180 mm

LX-141
180 mm

Flachzange, Extraktionszange
für Bohrdrähte
Flat pliers, Extraction
pliers for wires
Pinze per estrazione fili
Alicates para extracción,
Alicates para sacar alambre
Pince plate, Pinces pour
extraction des broches

LX-140/LX-141

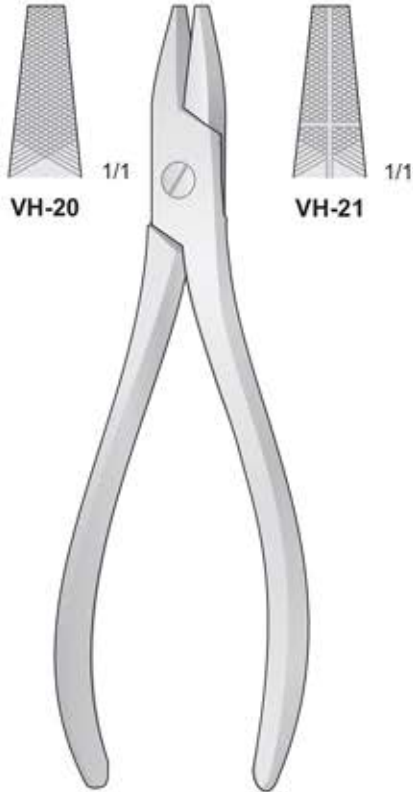

VH-20/VH-21
175 mm

Parallel-Flachzange - Flat-nosed pliers, parallel
Pinza a branche parallele - Alicates planos - Pinces plates

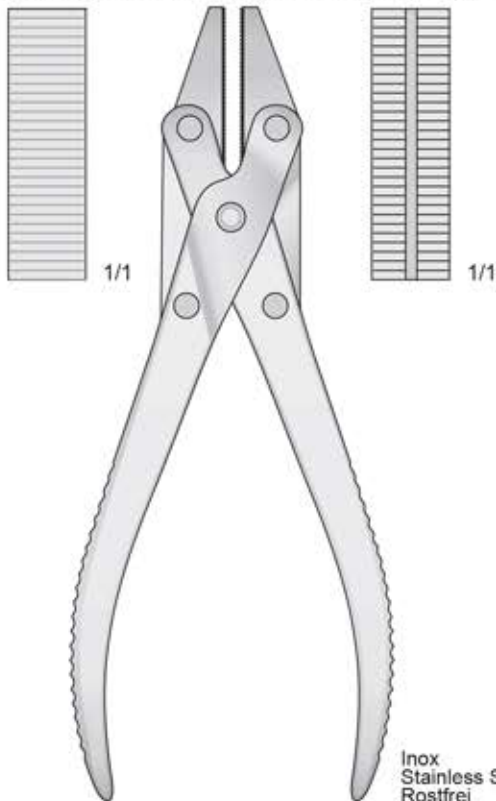

VH-25
185 mm



VH-23
190 mm

Parallel-Flachzange mit Seitenschneider
Flat-nose pliers parallel with lateral wire cutter
Pinza a branche parallele con tronchese

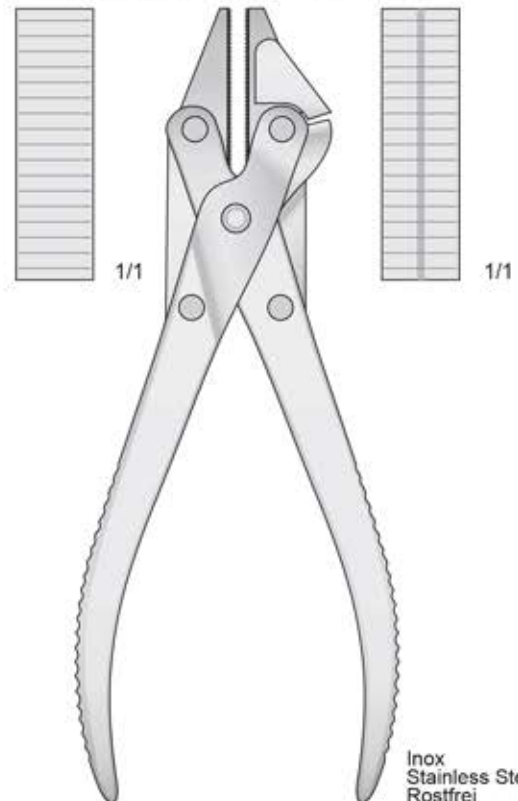

LX-80
185 mm

Draht-und bleischere gezahnt - Wire cutting scissor serrated
Forbice universale dentellata - Tijeras para cortar hilo de acero dentadas

TC

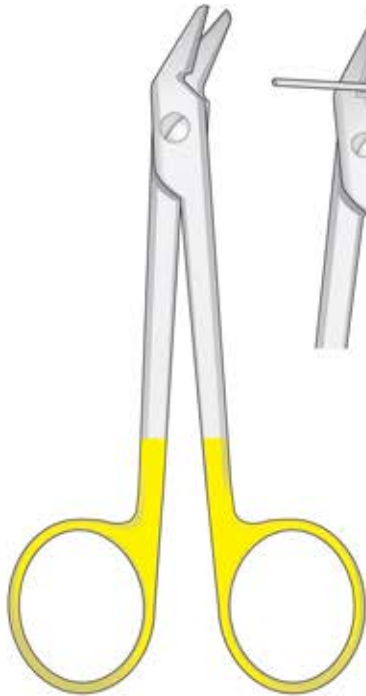

DP-120
120 mm

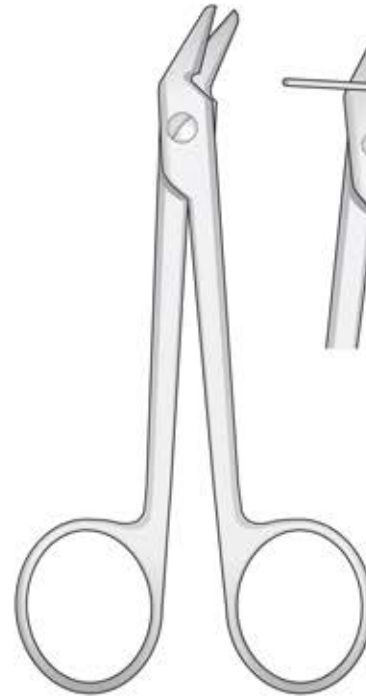
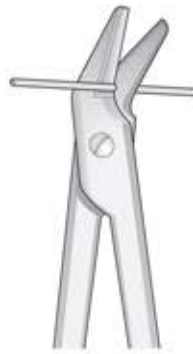

DP-90
120 mm



TC

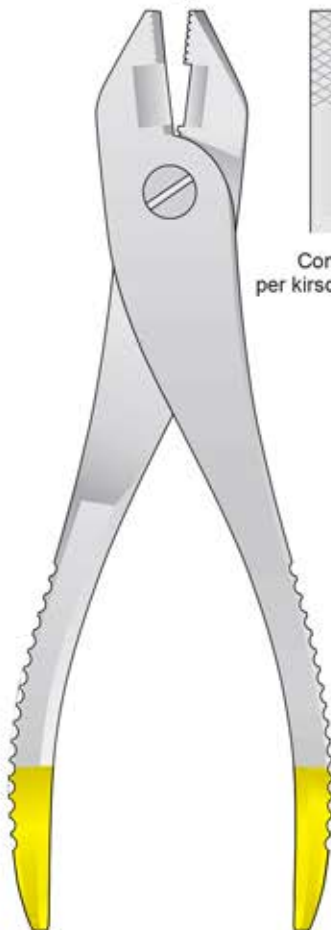

LX-125
220 mm

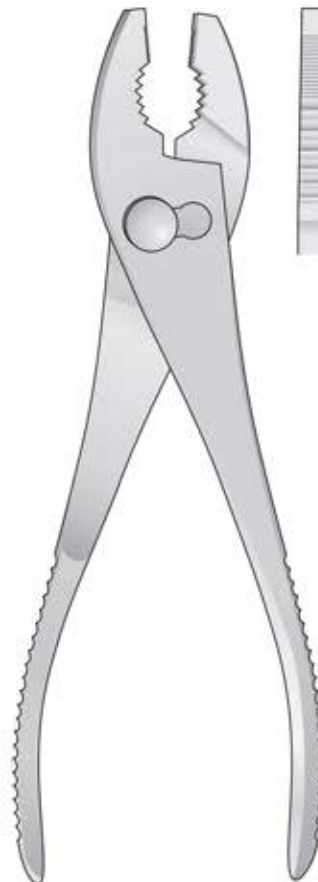
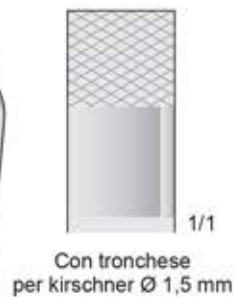

VH-40
200 mm



Komplett aus rostfreiem Stahl gefertigte und gehärtete Backen sorgen für einen guten Halt. Spannen und lösen erfolgt mit einer Hand



LS-407
180 mm



LS-408
200 mm



LS-409
240 mm

Needle Holder | Wire Forceps
Nadelhalter | Draht-Zangen
Porte-aiguilles | Pincés pour fil
Porta-agujas | Pinzas para alambre
Port'aghi | Pinze per fili

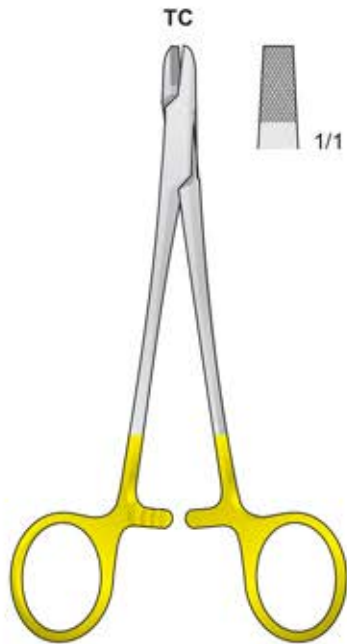

PH-58
150 mm

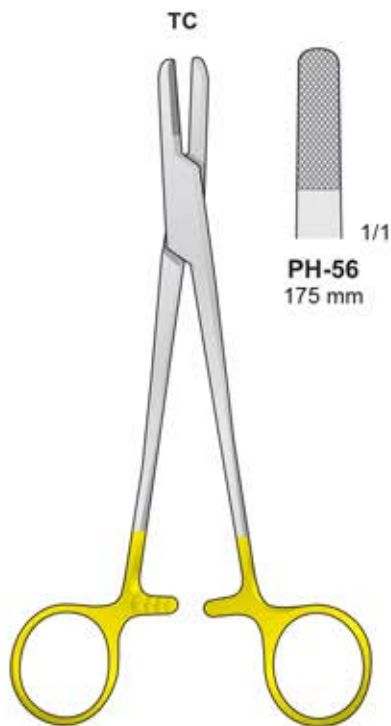

PH-55/PH-56

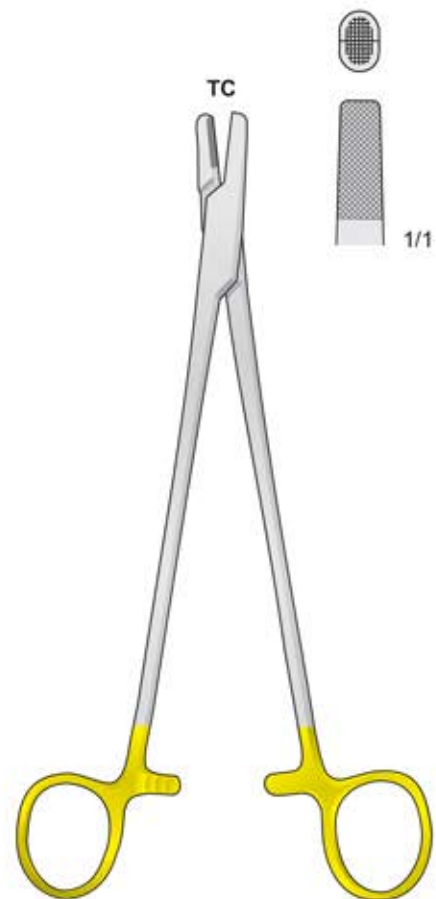
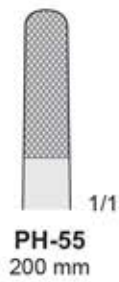

BAUMGARTNER
PH-57
200 mm

Für harten Draht bis \varnothing 0,4 mm - For hard wire with \varnothing 0,4 mm
 Per fili duri di \varnothing 0,4 mm - Para alambres duros de \varnothing 0,4 mm
 Pour fils durs avec \varnothing 0,4 mm

Für harten Draht bis \varnothing 1 mm - For hard wire with \varnothing 1 mm
 Per filo duro \varnothing 1 mm - Para alambres duro \varnothing 1 mm
 Pour fil dur avec \varnothing 1 mm

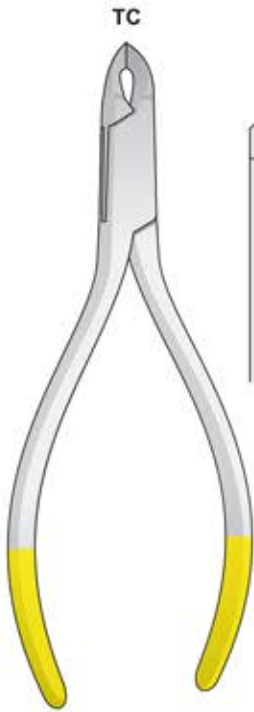

ANGLE
LX-95TC
 130 mm

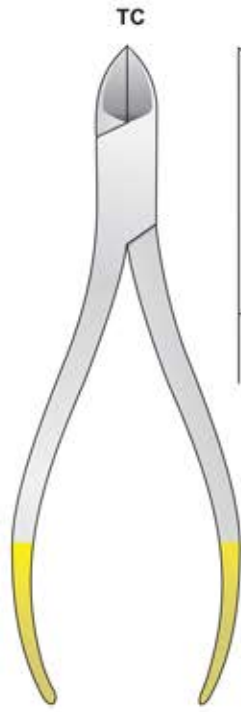

LX-99
 130 mm

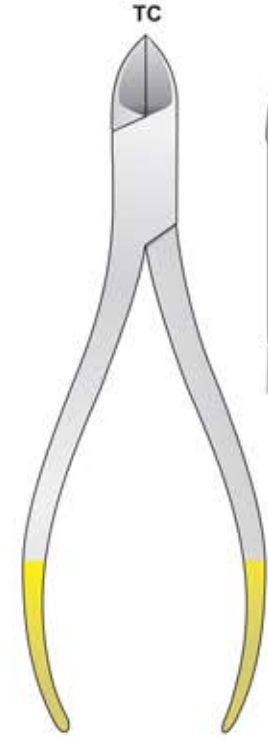

LX-96TC
 150 mm

Für harten Draht bis \varnothing 1 mm - For hard wire with \varnothing 1 mm
 Per filo duro \varnothing 1 mm - Para alambres duro \varnothing 1 mm
 Pour fil dur avec \varnothing 1 mm



LX-92TC
 145 mm



LX-82
 185 mm

Für harten Draht bis \varnothing 1,7 mm
 For hard wire with \varnothing 1,7 mm
 Per filo duro \varnothing 1,7 mm
 Para alambres duro \varnothing 1,7 mm
 Pour fil dur avec \varnothing 1,7 mm

Für weichen draht Ø 2 mm
 Für harten draht Ø 1,5 mm
 For soft wire Ø 2 mm
 For hard wire Ø 1,5 mm
 Per filo leggero Ø 2 mm
 Per filo duro Ø 1,5 mm
 Para alambres ligero Ø 2 mm
 Para alambres duro 1,5 mm
 Pour fil léger Ø 2 mm
 Pour fil dur Ø 1,5 mm

Für weichen draht Ø 2 mm
 Für harten draht Ø 1,6 mm
 For soft wire Ø 2 mm
 For hard wire Ø 1,6 mm
 Per filo leggero Ø 2 mm
 Per filo duro Ø 1,6 mm
 Para alambres ligero Ø 2 mm
 Para alambres duro Ø 1,6 mm
 Pour fil léger Ø 2 mm
 Pour fil dur Ø 1,6 mm

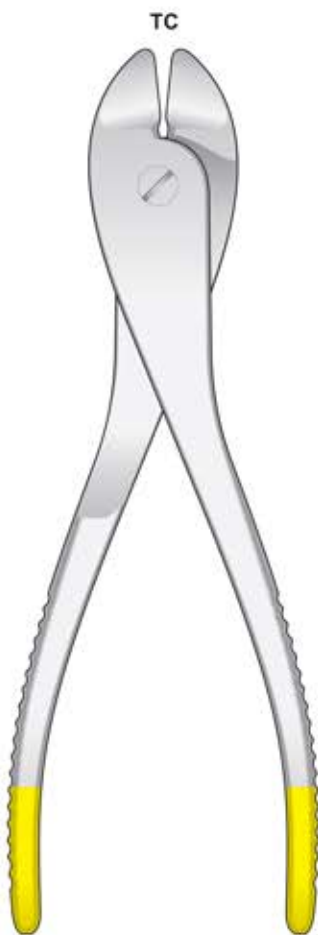

LX-101
185 mm

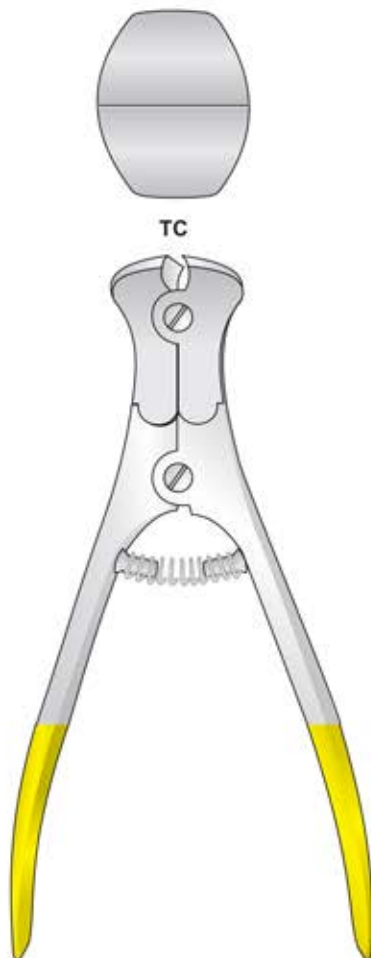

LX-102
145 mm

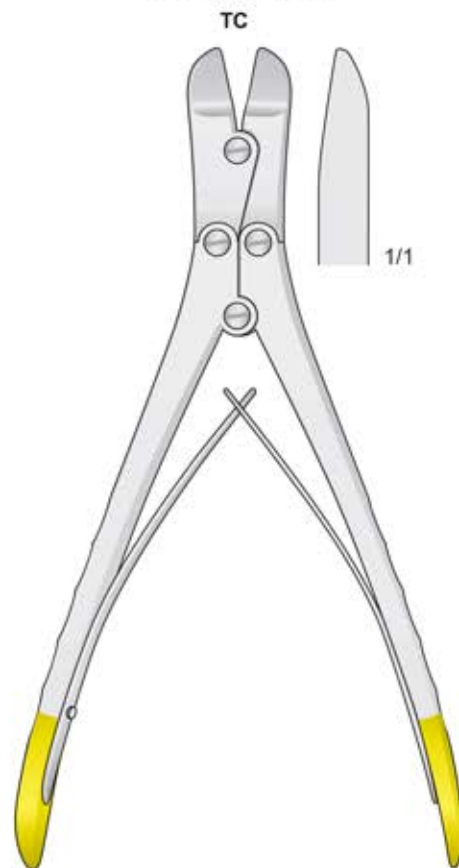

LX-103
170 mm

Für weichen draht Ø 3,5 mm
 Für harten draht Ø 2,5 mm
 For soft wire Ø 3,5 mm
 For hard wire Ø 2,5 mm
 Per filo leggero Ø 3,5 mm
 Per filo duro Ø 2,5 mm
 Para alambres ligero Ø 3,5 mm
 Para alambres duro Ø 2,5 mm
 Pour fil léger Ø 3,5 mm
 Pour fil dur Ø 2,5 mm

Für weichen draht Ø 3 mm
 Für harten draht Ø 2,2 mm
 For soft wire Ø 3 mm
 For hard wire Ø 2,2 mm
 Per filo leggero Ø 3 mm
 Per filo duro Ø 2,2 mm
 Para alambres ligero Ø 3 mm
 Para alambres duro Ø 2,2 mm
 Pour fil léger Ø 3 mm
 Pour fil dur Ø 2,2 mm

Für weichen draht Ø 2,5 mm
 Für harten draht Ø 2 mm
 For soft wire Ø 2,5 mm
 For hard wire Ø 2 mm
 Per filo leggero Ø 2,5 mm
 Per filo duro Ø 2 mm
 Para alambres ligero Ø 2,5 mm
 Para alambres duro Ø 2 mm
 Pour fil léger Ø 2,5 mm
 Pour fil dur Ø 2 mm



LX-104
215 mm

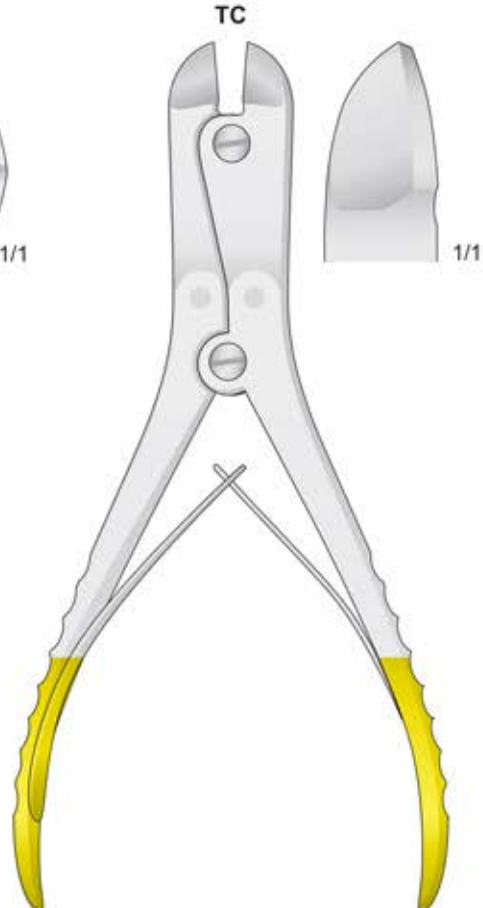

LX-106
230 mm

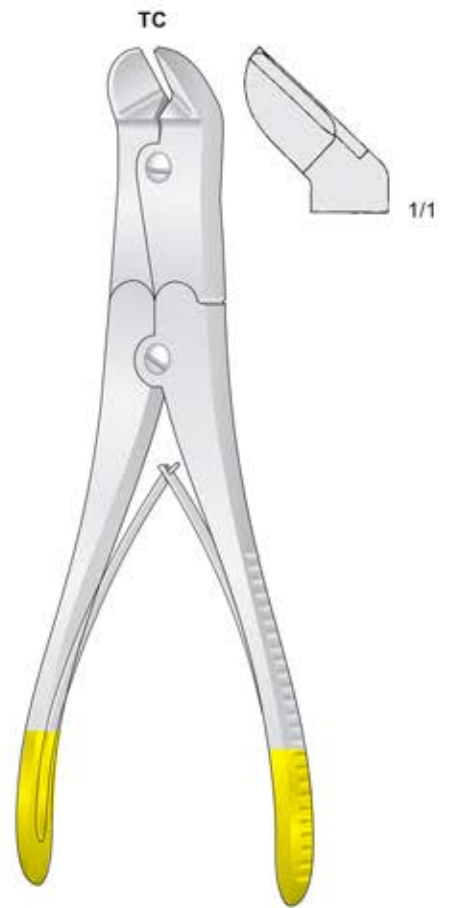

LX-105
230 mm

Für weichen Draht Ø 7 mm
 Für harten Draht Ø 6 mm
 For soft wire Ø 7 mm
 For hard wire Ø 6 mm
 Per filo leggero Ø 7 mm
 Per filo duro Ø 6 mm
 Para alambres ligero Ø 7 mm
 Para alambres duro Ø 6 mm
 Pour fil léger Ø 7 mm
 Pour fil dur Ø 6 mm



VF-98
480 mm

Für weichen Draht Ø 7 mm
 Für harten Draht Ø 6 mm
 For soft wire Ø 7 mm
 For hard wire Ø 6 mm
 Per filo leggero Ø 7 mm
 Per filo duro Ø 6 mm
 Para alambres ligero Ø 7 mm
 Para alambres duro Ø 6 mm
 Pour fil léger Ø 7 mm
 Pour fil dur Ø 6 mm

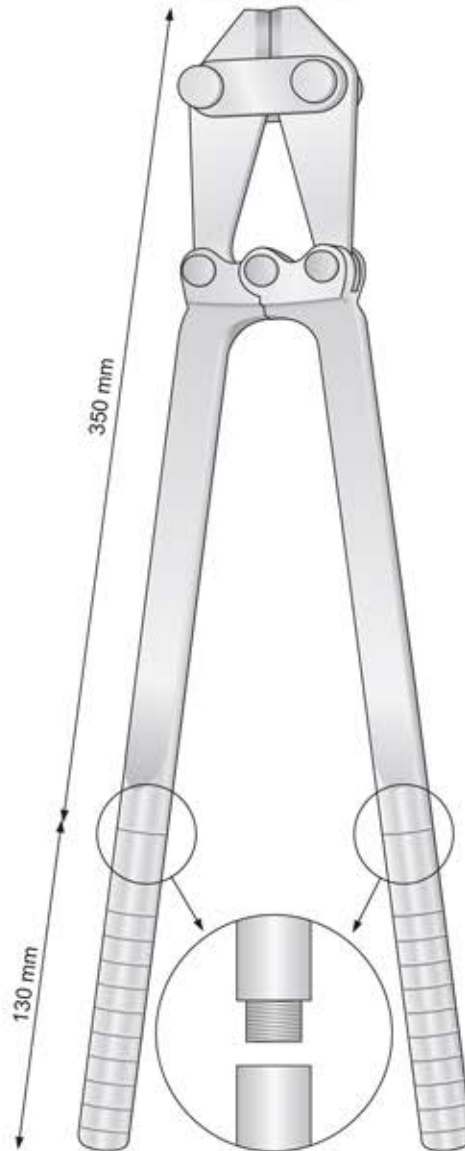

VF-98M
480 mm

Für weichen Draht Ø 5 mm
 Für harten Draht Ø 4,5 mm
 For soft wire Ø 5 mm
 For hard wire Ø 4,5 mm
 Per filo leggero Ø 5 mm
 Per filo duro Ø 4,5 mm
 Para alambres ligero Ø 5 mm
 Para alambres duro Ø 4,5 mm
 Pour fil léger Ø 5 mm
 Pour fil dur Ø 4,5 mm



LX-107
375 mm



Für weiche Drähte bis Ø 2 mm
Per fili morbidi fino a Ø 2 mm
Pour fils mous jusqu'à Ø 2 mm



Für harte Drähte bis Ø 1,5 mm
Per fili duri fino a Ø 1,5 mm
Pour fils durs jusqu'à Ø 1,5 mm

TC



LX-126
180 mm

Von Kirschner-Drähten Ø 6 mm
For Kirschner wires Ø 6 mm
Per chiodi Kirschner Ø 6 mm



LX-150
450 mm

Von Kirschner-Drähten Ø 6 mm
For Kirschner wires Ø 6 mm
Per chiodi Kirschner Ø 6 mm



LX-151
560 mm

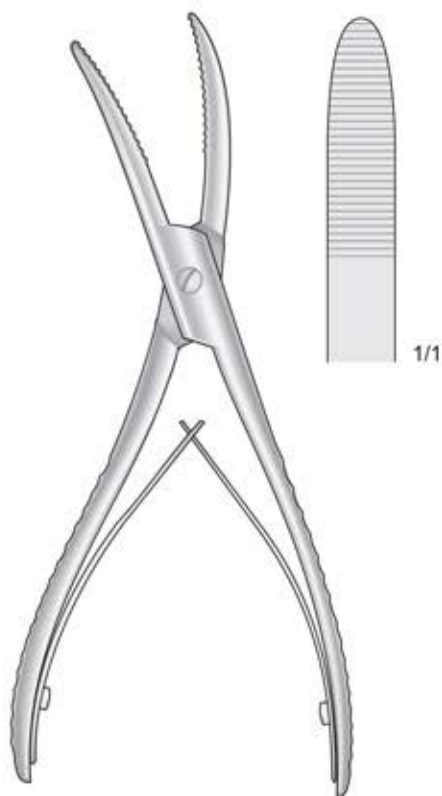

WOLFF
LX-113
180 mm

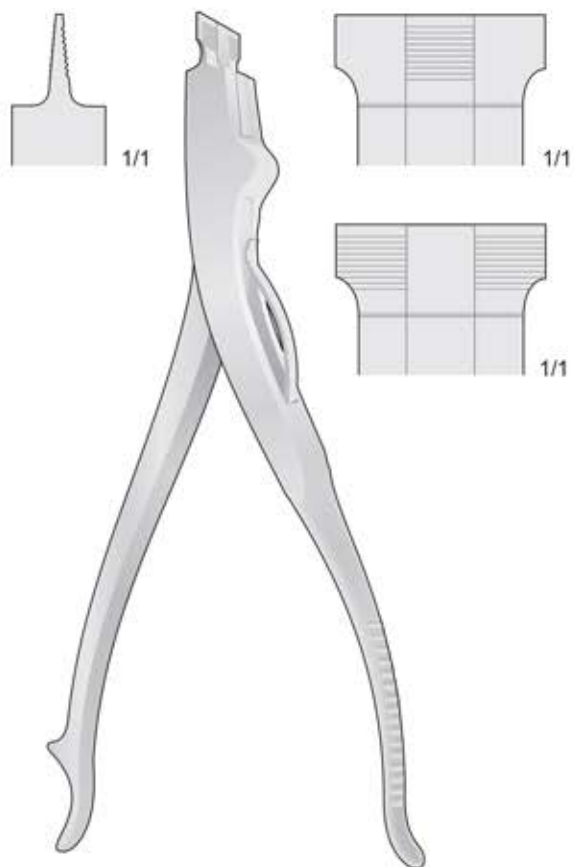

LX-115
220 mm

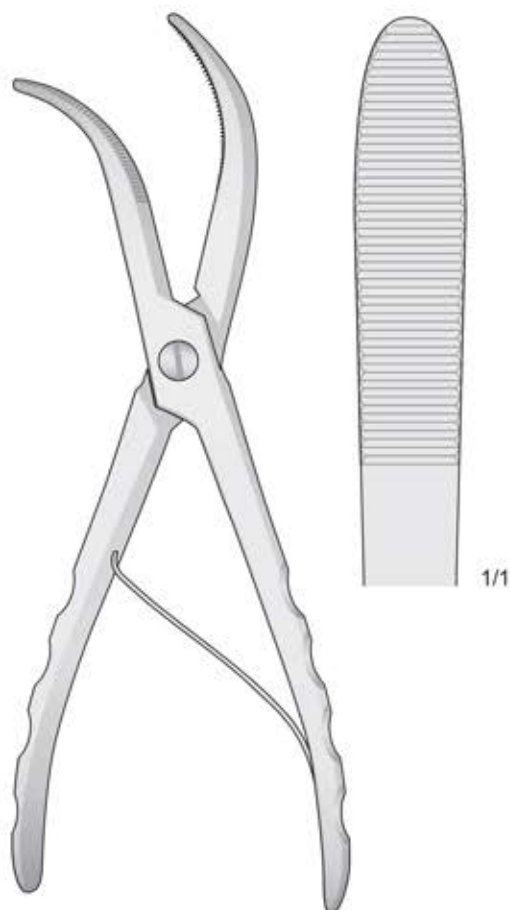

WOLFF
LX-114
250 mm

Gips - Schneidezangen
Cesioie per gesso

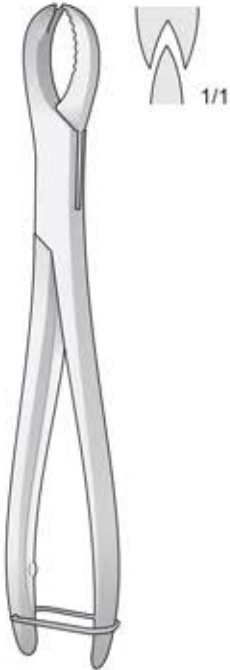

BK-30
210 mm



**HENNIG
LX-123**
270 mm



1/1



**STILLE
LX-120**
230 mm



**HAGLUND
LX-121**
280 mm



**STILLE
LX-122**
370 mm

Retractors

Retraktoren

Écarteurs

Separadores

Divaricatori

Nervhaken

Nerve Hooks

Crochets à nerfs

Ganchos para nervios

Uncini per nervi

Micro Dissectors

Mikro-Dissektoren

Micro Dissecteurs

Micro Disecadores

Micro Dissettori

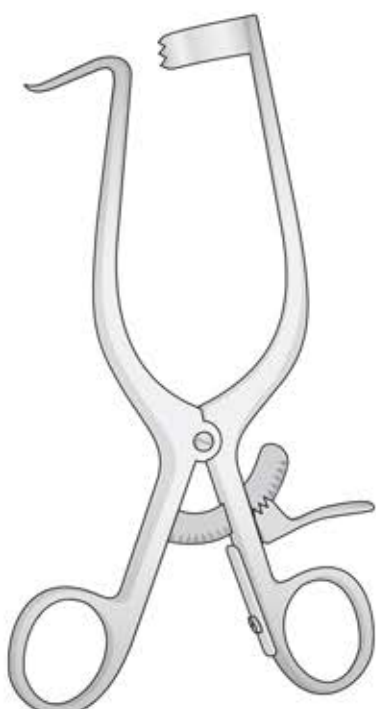

WILLIAMS
BV-401/BV-403
170 mm

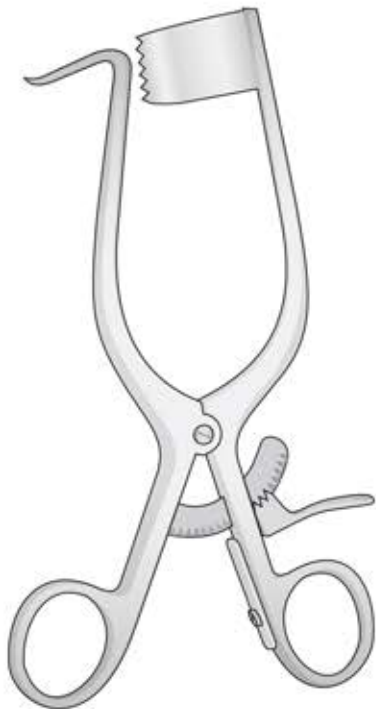

WILLIAMS
BV-404/BV-406
170 mm

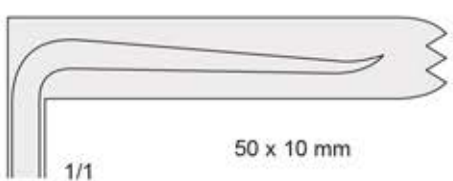

BV-401

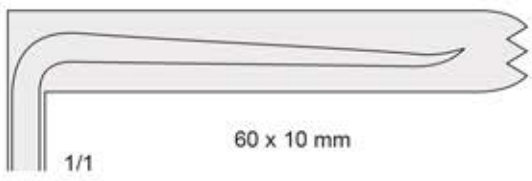

BV-402

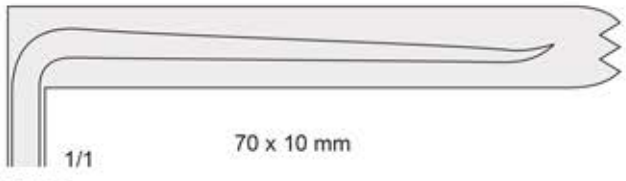

BV-403

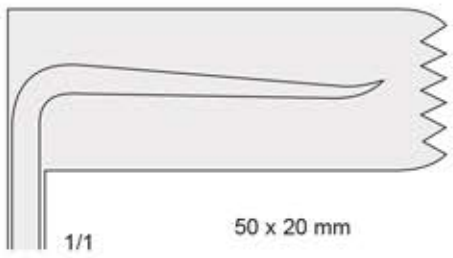

BV-404

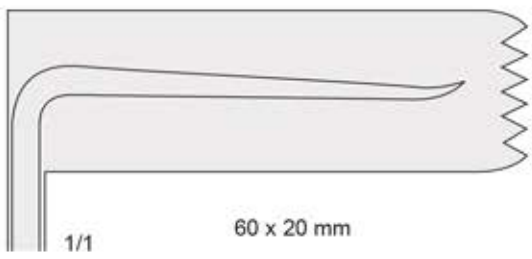

BV-405

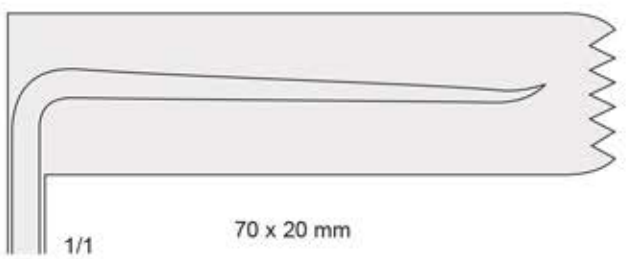

BV-406

Spitz - Sharp
Acuto - Agudas
Pointu

4 x 4 Zähne
4 x 4 Teeth
4 x 4 Denti
4 x 4 Dientes
4 x 4 Dents

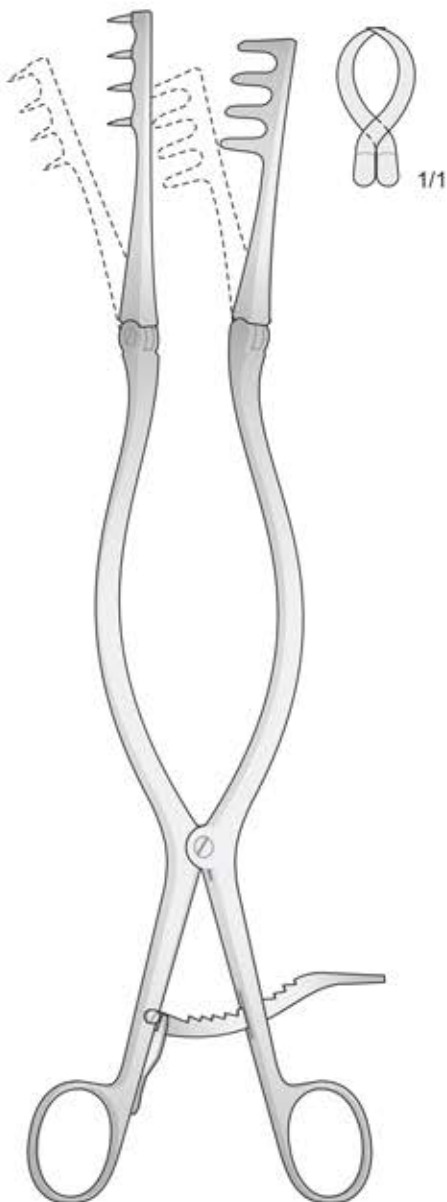

BECKMANN
BV-121
310 mm

Halbscharf - Sharp
Semi acuto - Agudas
Semi pointu

4 x 4 Zähne
4 x 4 Teeth
4 x 4 Denti
4 x 4 Dientes
4 x 4 Dents

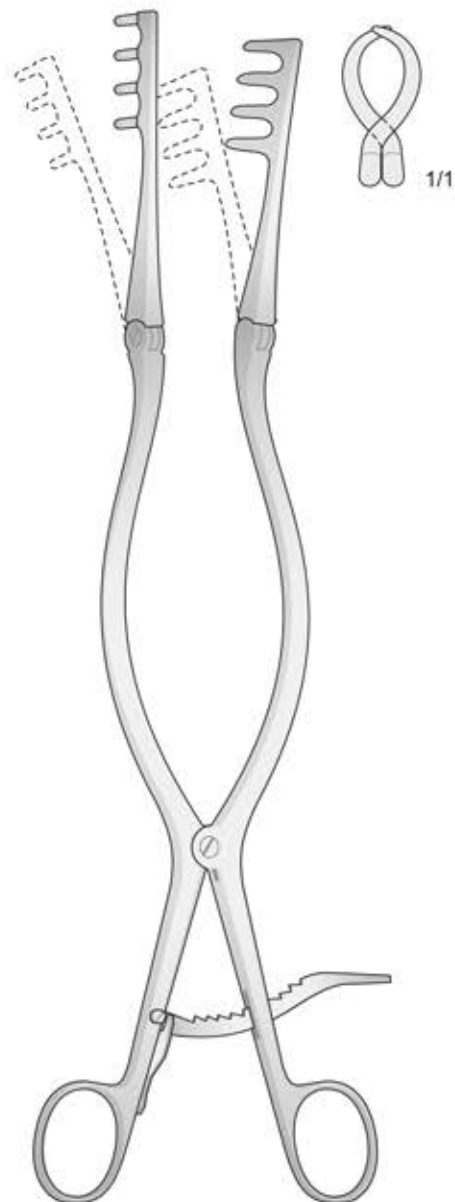

BECKMANN
BV-122
310 mm

Stumpf - Blunt - Smusso
Romas - Mousse

5 x 4 Zähne
5 x 4 Teeth
5 x 4 Denti
5 x 4 Dientes
5 x 4 Dents

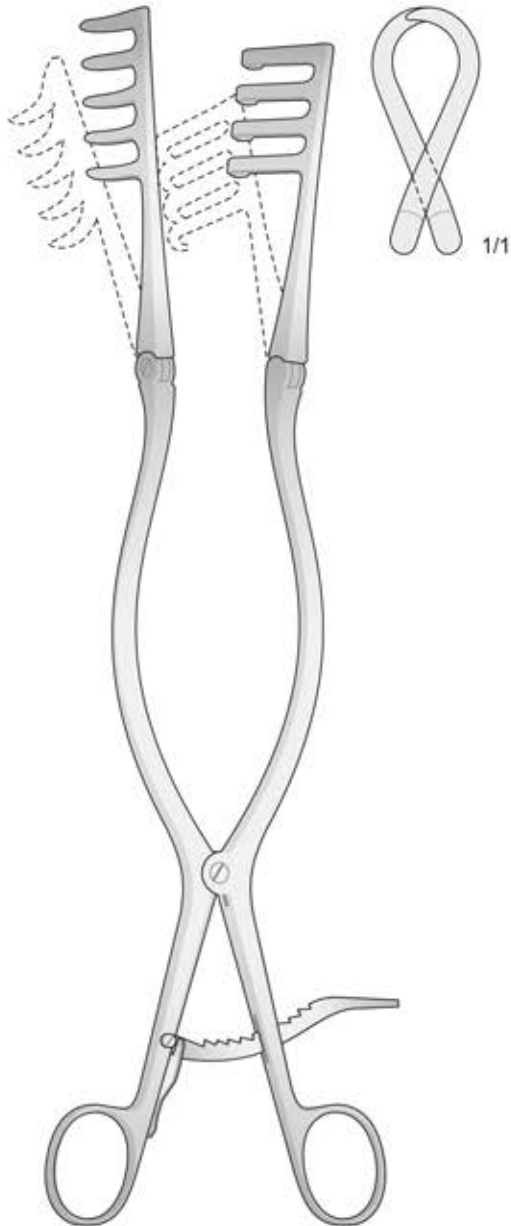

ADSON
BV-123
320 mm

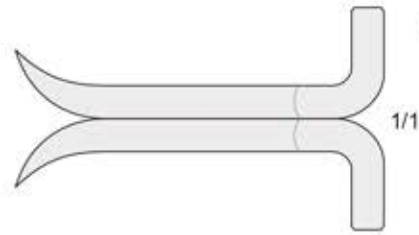

Spitz - Sharp - Acuto
Agudas - Pointu

7 x 7 Zähne
7 x 7 Teeth
7 x 7 Denti
7 x 7 Dientes
7 x 7 Dents

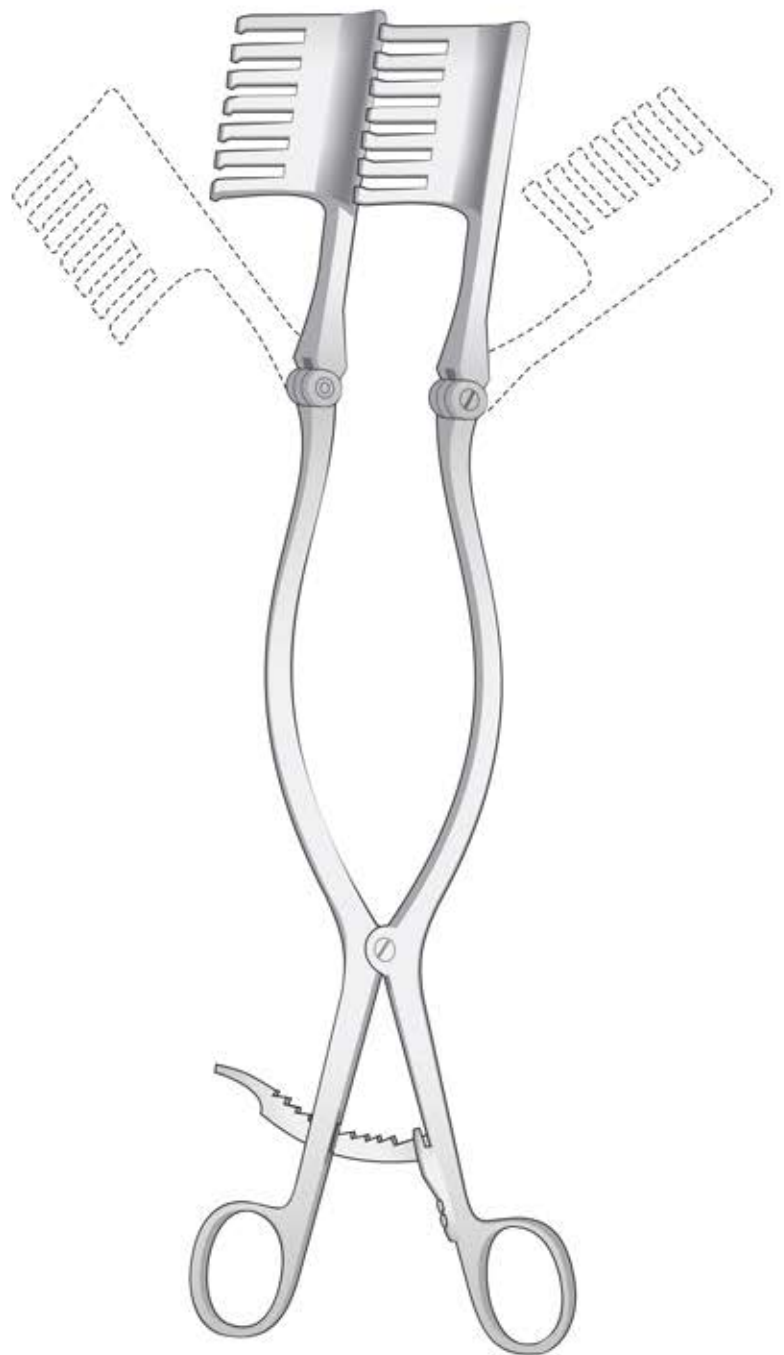

BECKMANN-EATON
BV-124
330 mm

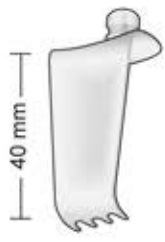

40 mm
16 mm

BV-321

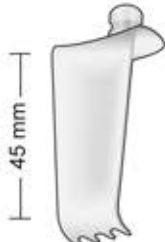

45 mm
16 mm

BV-322

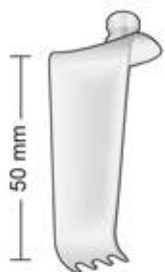

50 mm
16 mm

BV-323

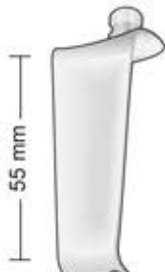

55 mm
16 mm

BV-324

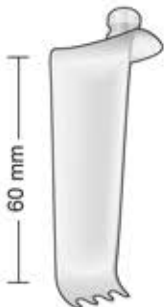

60 mm
16 mm

BV-325

CLOWARD Modif.
BV-319
Sperrer, allein
Retractor, only
Divaricatore, solo
Separador, suelto
Ecarteur, seul

CLOWARD modif.
BV-320
Komplett mit 5 Valven
Complete with 5 blades
Completo di 5 valve
Completo con 5 valvas
Complet avec 5 valves



CLOWARD modif.
BV-320
250 mm

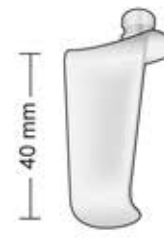

40 mm
16 mm

BV-326



45 mm
16 mm

BV-327

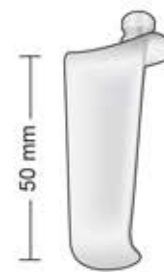

50 mm
16 mm

BV-328



55 mm
16 mm

BV-329



60 mm
16 mm

BV-330

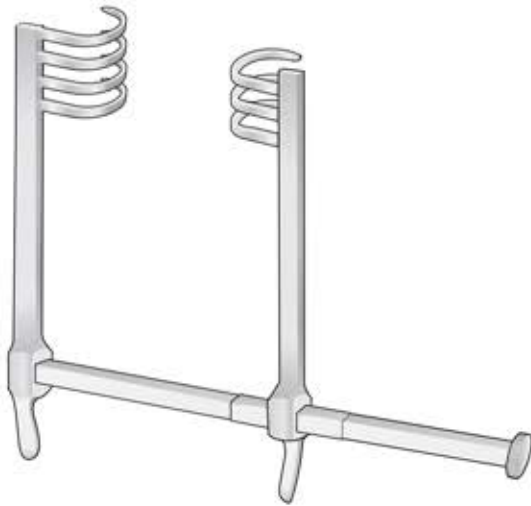

FRAZIER
BV-35

Instrumente allein, ohne Blätter
Frame only - Strumento solo, senza valve
Cuadro solo - Cadre seul

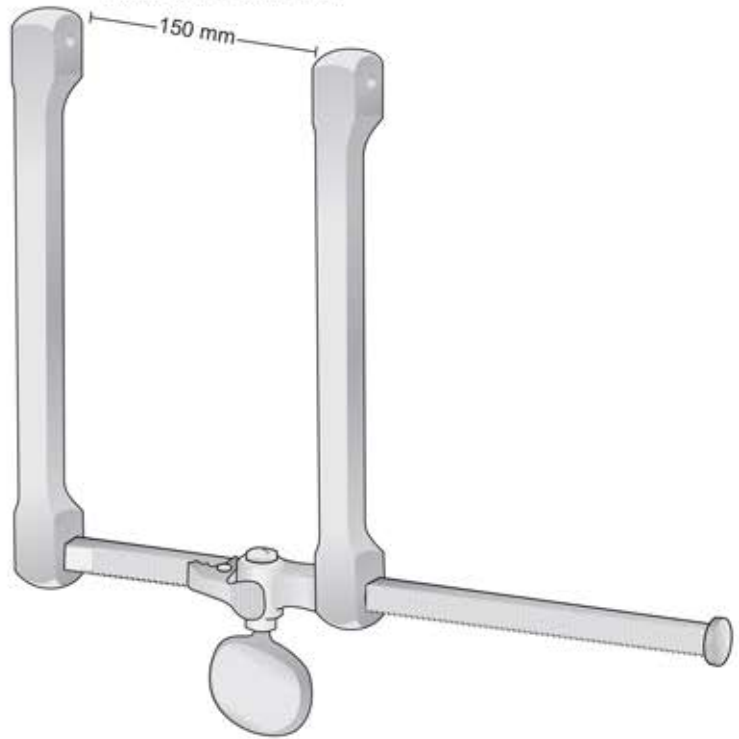

SCOVILLE
BV-161

Instrumente allein, ohne Blätter
Frame only
Strumento solo, senza valve
Cuadro solo
Cadre seul

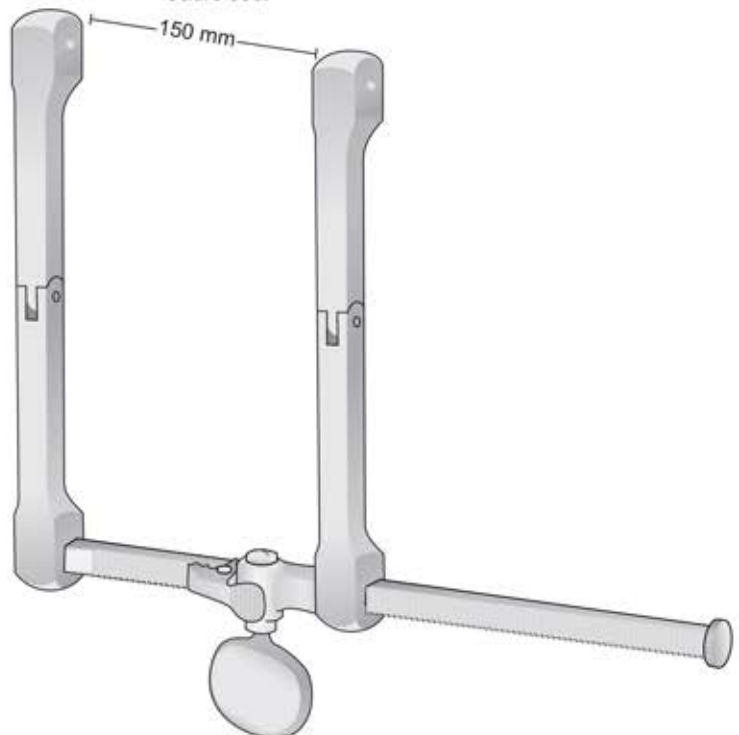

SCOVILLE-HAVERFIELD
BV-160

Spitz
Scharp
Acuto
Agudo
Pointù



SCOVILLE
BV-163
50 mm

Spitz
Scharp
Acuto
Agudo
Pointù



SCOVILLE
BV-164
70 mm

Stumpf
Blunt
Smusso
Romo
Mousse



SCOVILLE
BV-165
50 mm

Stumpf
Blunt
Smusso
Romo
Mousse



SCOVILLE
BV-166
70 mm



SCOVILLE
BV-167 50x25 mm
BV-168 50x50 mm
BV-169 57x38 mm
BV-170 64x25 mm
BV-171 64x50 mm
BV-172 67x30 mm
BV-173 75x25 mm
BV-174 75x50 mm
BV-175 88x25 mm
BV-176 100x50 mm



TAYLOR
BV-177 48x50 mm
BV-178 64x50 mm
BV-179 64x64 mm
BV-180 80x57 mm



SCOVILLE
BV-181 41x38 mm
BV-182 67x44 mm

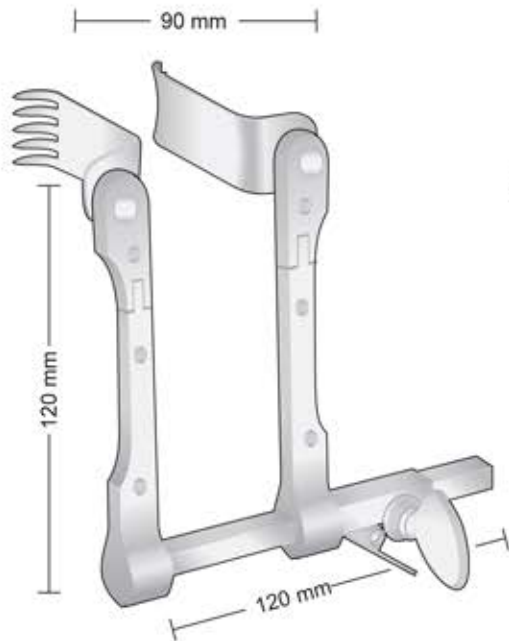

**CASPAR
BV-250**

Komplett mit 5 + 5 Blätter
Complete with 5 + 5 blade
Completo con 5 + 5 valve
Completo con 5 + 5 valvas
Complet avec 5 + 5 valves

BV-249

Sperrer allein
Retractor only
Divaricatore solo
Separador suelto
Ecarteur seul

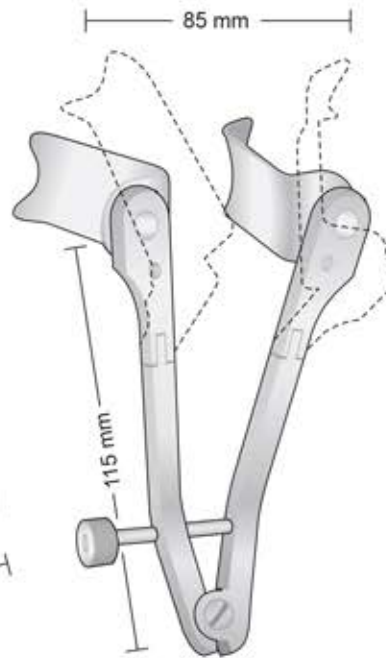

**CASPAR
BV-270**

Komplett mit 5 Blätter
Complete with 5 blade
Completo con 5 valve
Completo con 5 valvas
Complet avec 5 valves

BV-269

Sperrer allein
Retractor only
Divaricatore solo
Separador suelto
Ecarteur seul

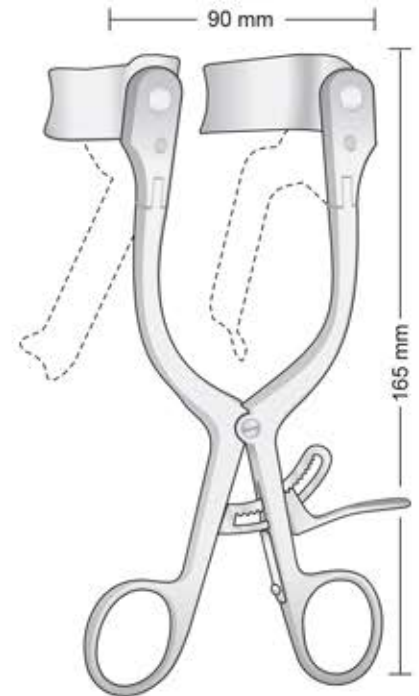

**CASPAR
BV-280**

Komplett mit 5 Blätter
Complete with 5 blade
Completo con 5 valve
Completo con 5 valvas
Complet avec 5 valves

BV-279

Sperrer allein
Retractor only
Divaricatore solo
Separador suelto
Ecarteur seul



BV-251
40 x 23 mm
BV-252
45 x 23 mm
BV-253
50 x 23 mm
BV-254
55 x 23 mm
BV-255
60 x 23 mm

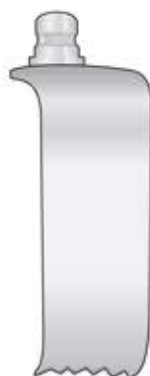

BV-256
40 x 23 mm
BV-257
45 x 23 mm
BV-258
50 x 23 mm
BV-259
55 x 23 mm
BV-260
60 x 23 mm



BV-271
45 x 23 mm
BV-272
50 x 23 mm
BV-273
55 x 23 mm
BV-274
60 x 23 mm
BV-275
65 x 23 mm



BV-276
50 x 25 mm
BV-277
60 x 25 mm

Titan-valven
Titanium blades
Valve in titanio
Valvas in titanio
Valves en titane



BV-281 T	25 x 24 mm
BV-282 T	30 x 24 mm
BV-283 T	35 x 24 mm
BV-284 T	40 x 24 mm
BV-285 T	45 x 24 mm
BV-286 T	25 x 24 mm
BV-287 T	30 x 24 mm
BV-288 T	35 x 24 mm
BV-289 T	40 x 24 mm
BV-290 T	45 x 24 mm



BV-291 T	25 x 24 mm
BV-292 T	30 x 24 mm
BV-293 T	35 x 24 mm
BV-294 T	40 x 24 mm
BV-295 T	45 x 24 mm
BV-296 T	50 x 24 mm
BV-297 T	55 x 24 mm
BV-298 T	60 x 24 mm
BV-299 T	65 x 24 mm
BV-300 T	70 x 24 mm



BV-301 T	30 x 24 mm
BV-302 T	35 x 24 mm
BV-303 T	40 x 24 mm
BV-304 T	45 x 24 mm
BV-305 T	50 x 24 mm
BV-306 T	55 x 24 mm
BV-307 T	60 x 24 mm
BV-308 T	65 x 24 mm
BV-309 T	70 x 24 mm
BV-310 T	75 x 24 mm

Pinzette zum wechseln der valven
mit kugelschnellverschluss
Blade ejector for changing the blades
with ball snap closure
Pinzetta per la sostituzione delle valve
con i bloccaggi rapidi a sfera
Pincès pour changer les valves munies
du système de verrouillage rapide à billes



BV-229
115 mm

Oberfläche schwarz beschichtet
Surface black-coated

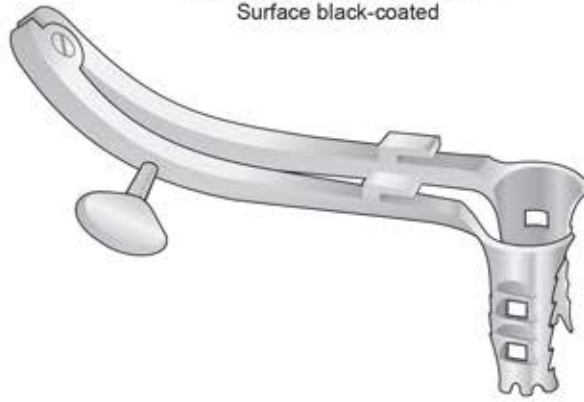

CASPAR
BV-201/BV-208

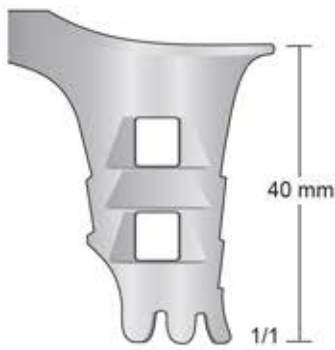

BV-201



BV-202



BV-203

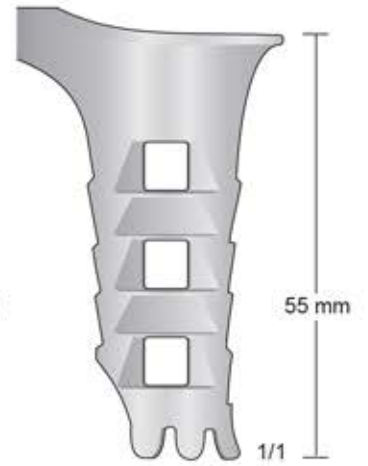

BV-204

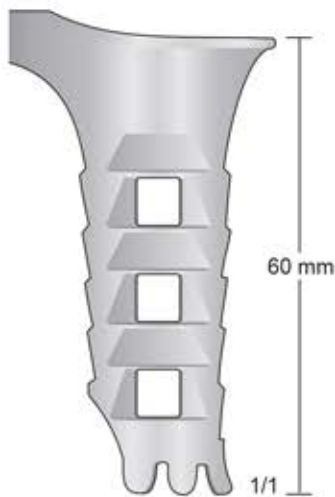

BV-205

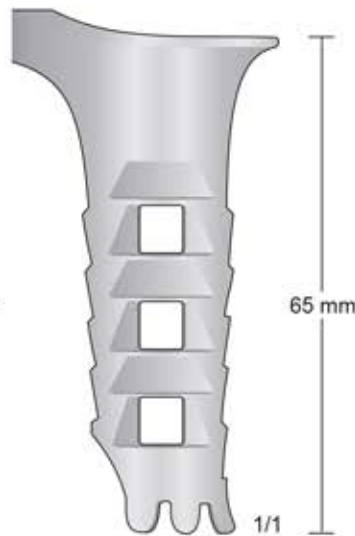

BV-206

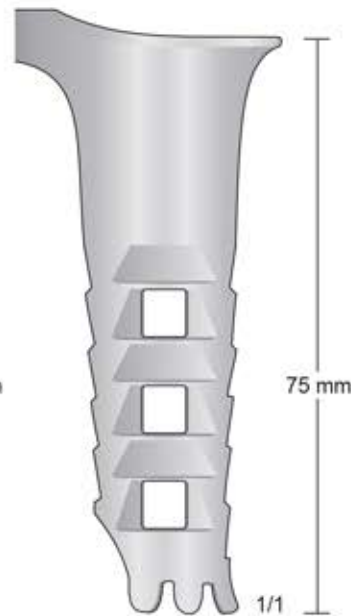

BV-207

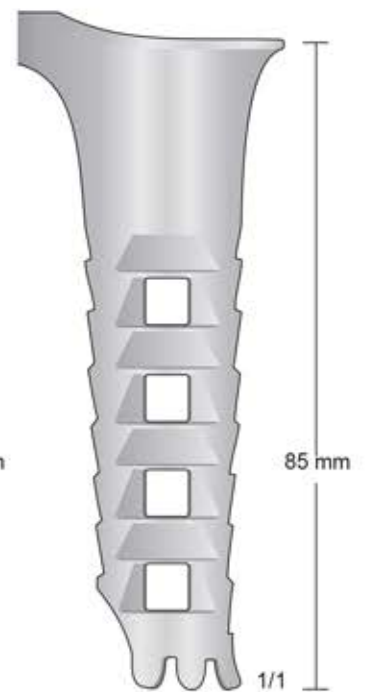

BV-208

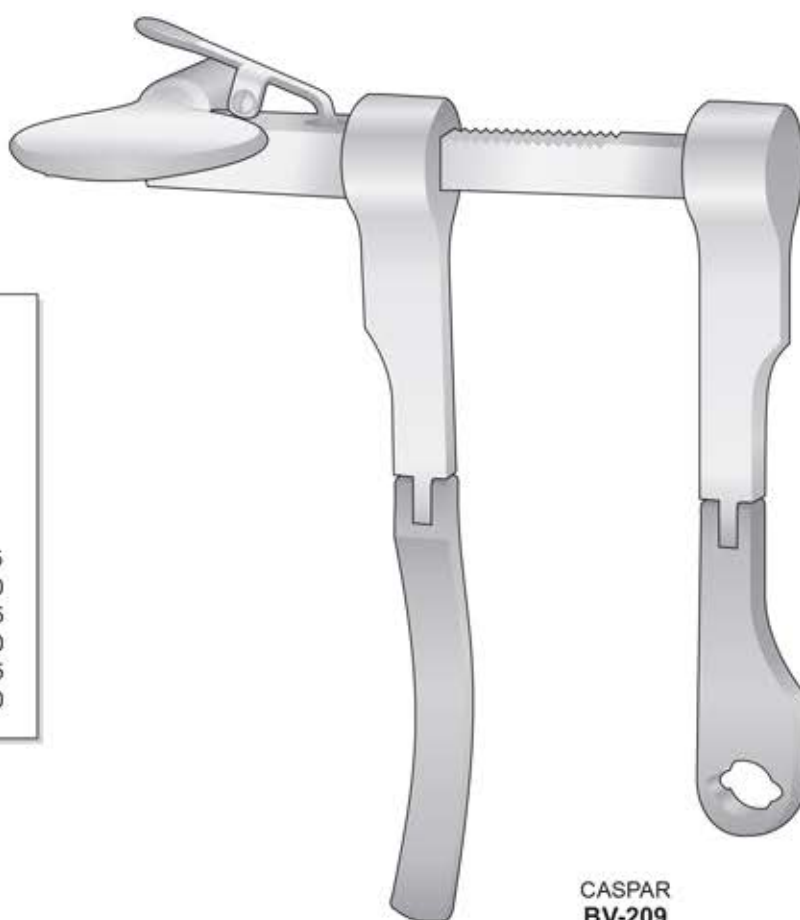

**CASPAR
BV-210**

Sperrer komplett mit
Retractor complete with
Divaricatore completo di
Separador completo con
Écarteur complet avec

- BV-211** Valva anti-riflesso mm. 35
- BV-212** Valva anti-riflesso mm. 40
- BV-213** Valva anti-riflesso mm. 45
- BV-214** Valva anti-riflesso mm. 50
- BV-215** Valva anti-riflesso mm. 55
- BV-216** Valva anti-riflesso mm. 60

BV-209

Sperrer allein
Retractor only
Divaricatore solo
Separador suelto
Écarteur seul

CASPAR
BV-209

Oberfläche schwarz Beschichtet
Surface Black-coated
Valve anti-riflesso
Surface noircie

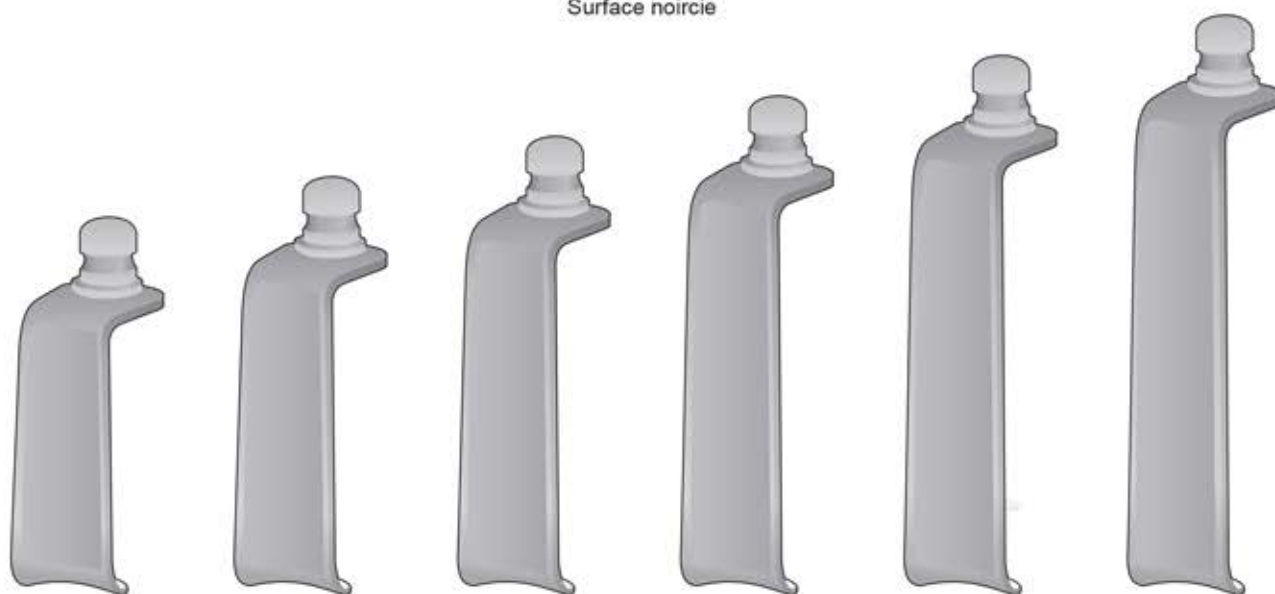

BV-211
35 mm

BV-212
40 mm

BV-213
45 mm

BV-214
50 mm

BV-215
55 mm

BV-216
60 mm

- CASPAR
FF-190
 Distraktor komplett rechts
 Distractor complete right
 Distrattore completo destro
FF-191 1 Distraktor allein - 1 Distractor only
FF-192 1 Bohrbüchse - 1 Drilling Guide
FF-203 1 Spezialbohrer - 1 Special Drill
FF-205 2 Distractionsschrauben - 2 Distraction Screws
FF-206 1 Schraubendreher - 1 Screw Driver

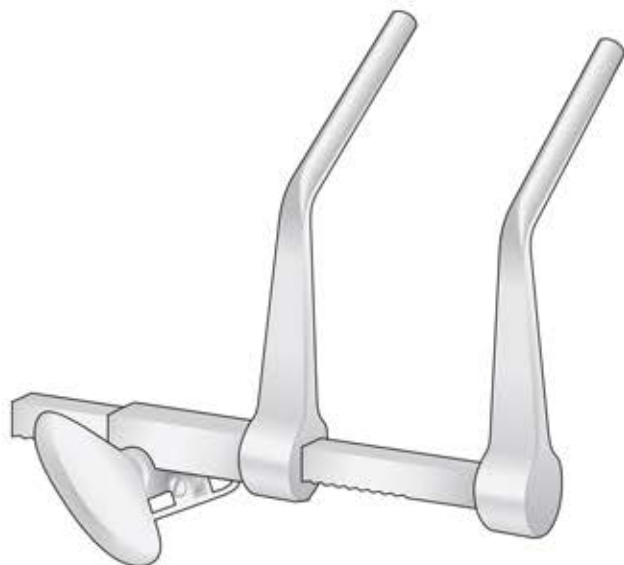

CASPAR
FF-191
 Distrattore destro, solo



FF-192
 Guida punte destro, solo

- CASPAR
FF-200
 Distraktor komplett links
 Distractor complete left
 Distrattore completo sinistro
FF-201 1 Distraktor allein - 1 Distractor only
FF-202 1 Bohrbüchse - 1 Drilling Guide
FF-203 1 Spezialbohrer - 1 Special Drill
FF-205 2 Distractionsschrauben - 2 Distraction Screws
FF-206 1 Schraubendreher - 1 Screw Driver

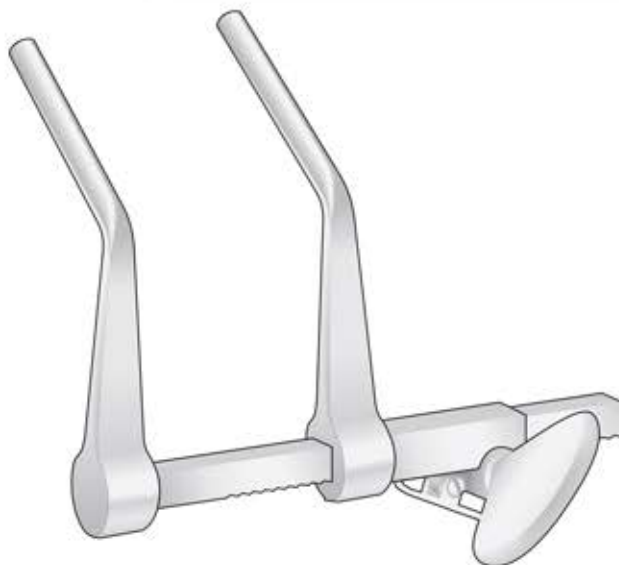

CASPAR
FF-201
 Distrattore sinistro, solo



FF-202
 Guida punte sinistro, solo

Spezialbohrer
Special Drill
Ø 1,7 mm



CASPAR
FF-203
145 mm

Distraktionsschrauben
Distraction Screw

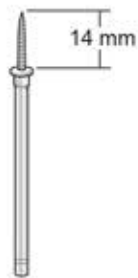

CASPAR
FF-204
70 mm

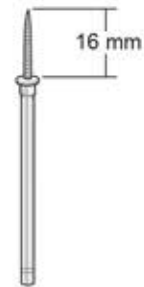

CASPAR
FF-205
70 mm

Schraubendreher
Screw Driver



CASPAR
FF-206
200 mm

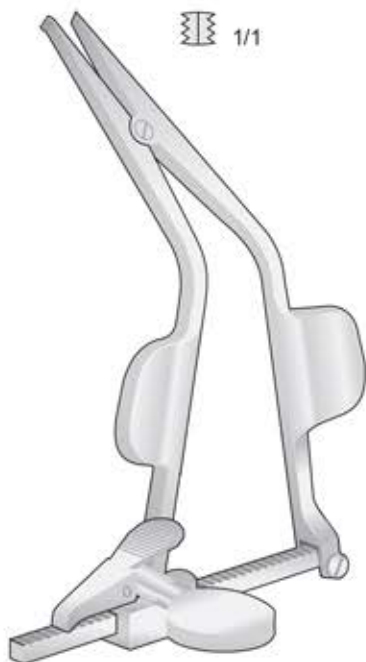

CLOWARD
BV-86
150 mm

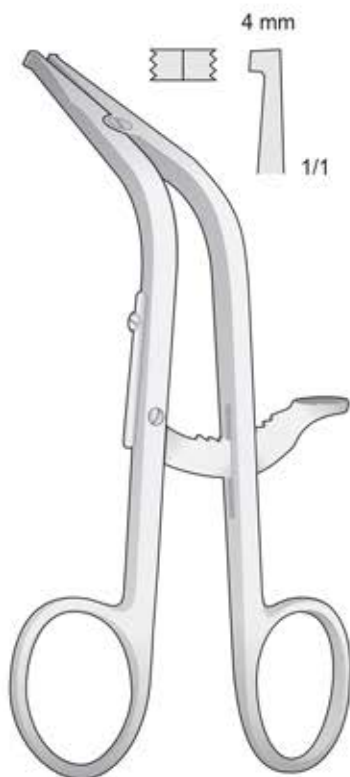

CLOWARD
BV-84
160 mm



CLOWARD
BV-85
160 mm

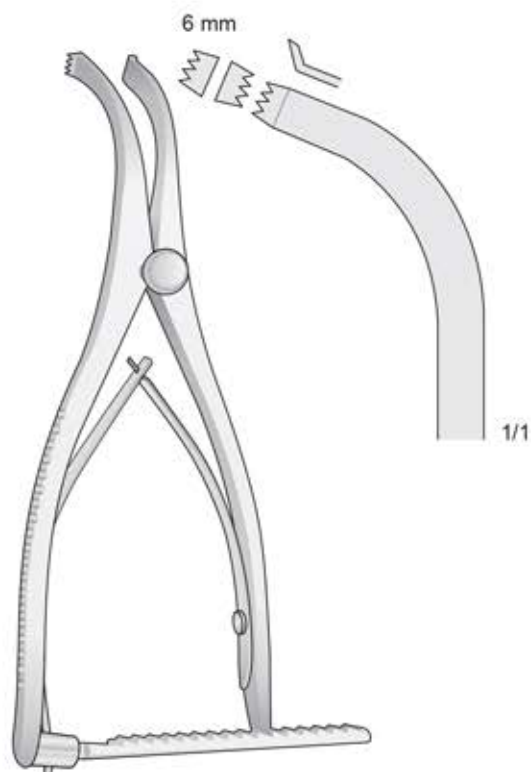

INGE
BV-80
160 mm

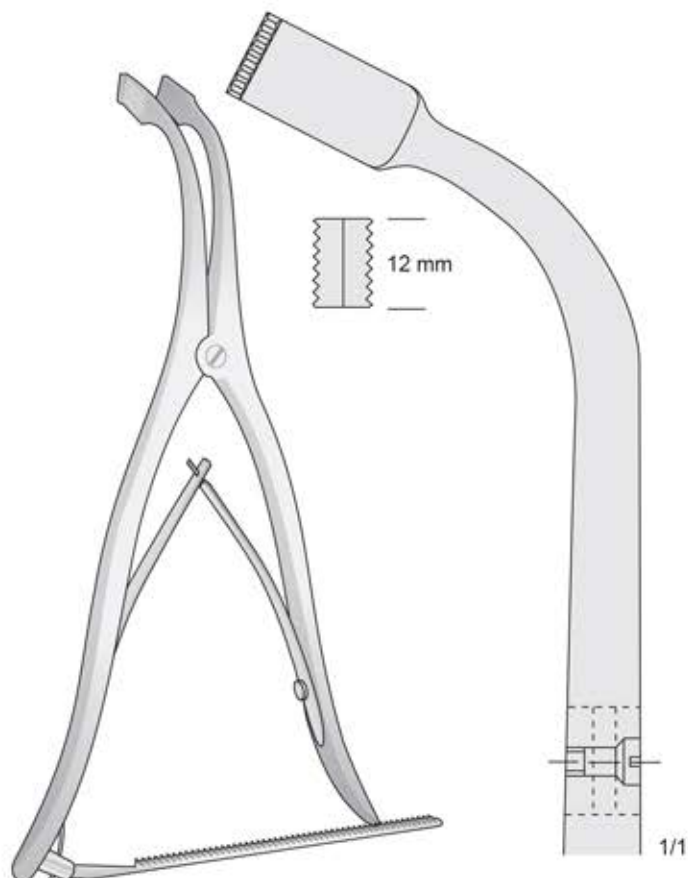

INGE
BV-82
275 mm

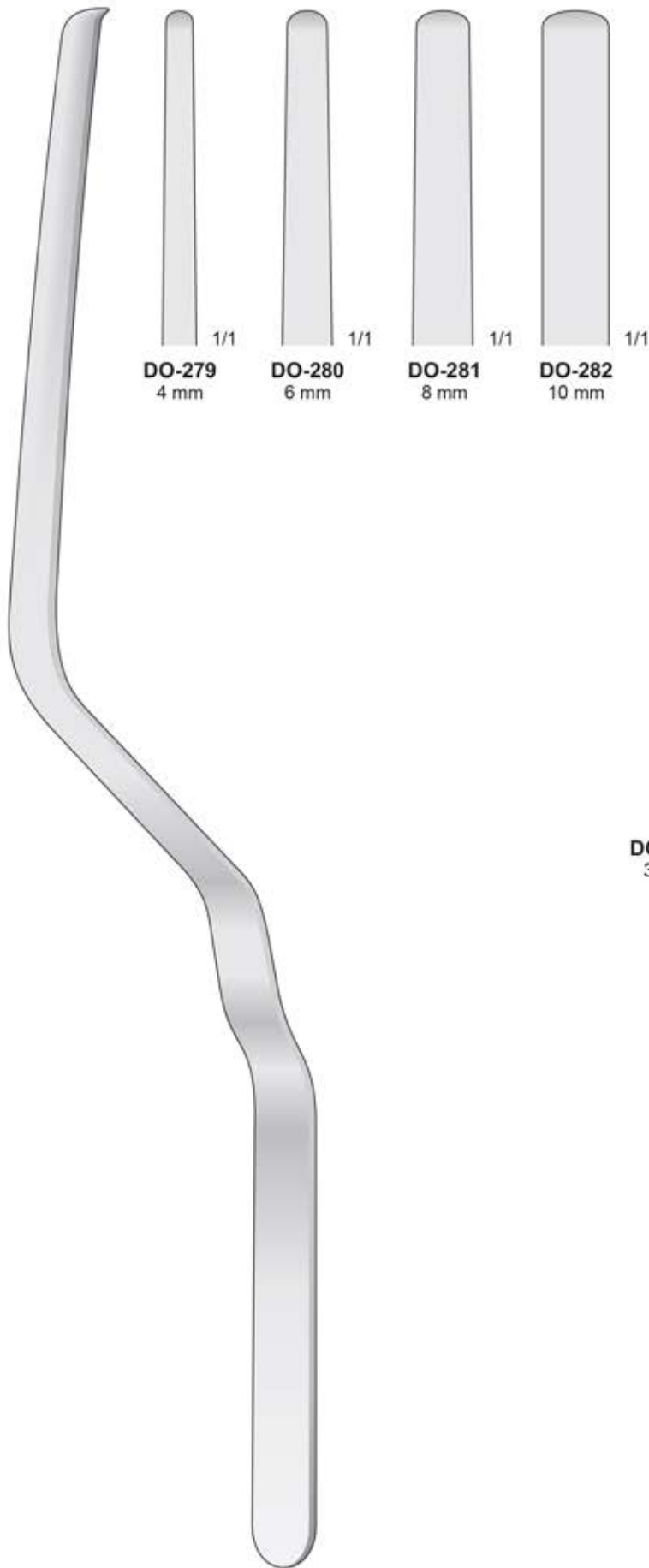

DO-279
4 mm

1/1

DO-280
6 mm

1/1

DO-281
8 mm

1/1

DO-282
10 mm

1/1

DO-279/DO-282
240 mm

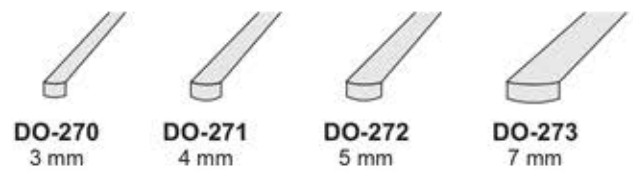

DO-270
3 mm

DO-271
4 mm

DO-272
5 mm

DO-273
7 mm

90 mm



HES
DO-270/DO-273
175 mm

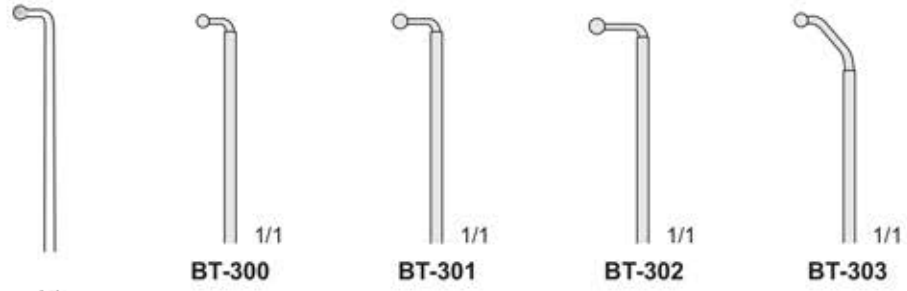

CASPAR
BT-300/BT-303
245 mm



FF-301/FD-308

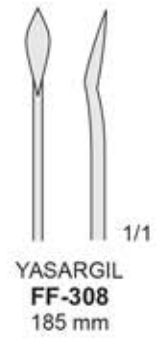
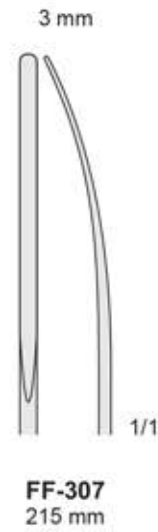
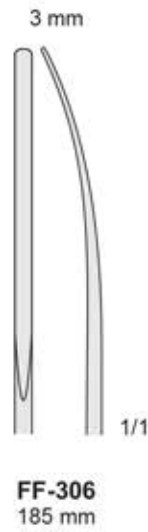
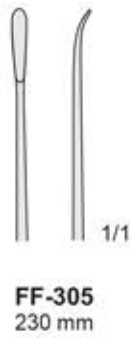
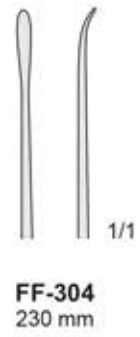
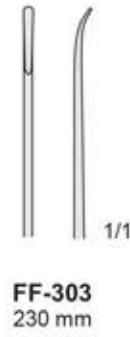
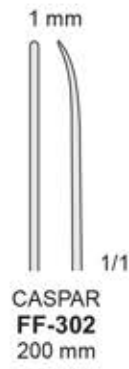
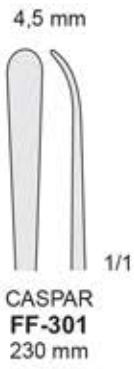



FD-309/FD-314

4,5 mm

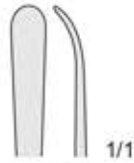
CASPAR
FF-309
230 mm

2 mm

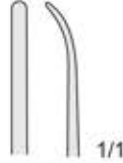
CASPAR
FF-310
230 mm

1 mm

CASPAR
FF-311
210 mm

1 mm

CASPAR
FF-312
210 mm**FF-313**
230 mm**FF-314**
230 mm

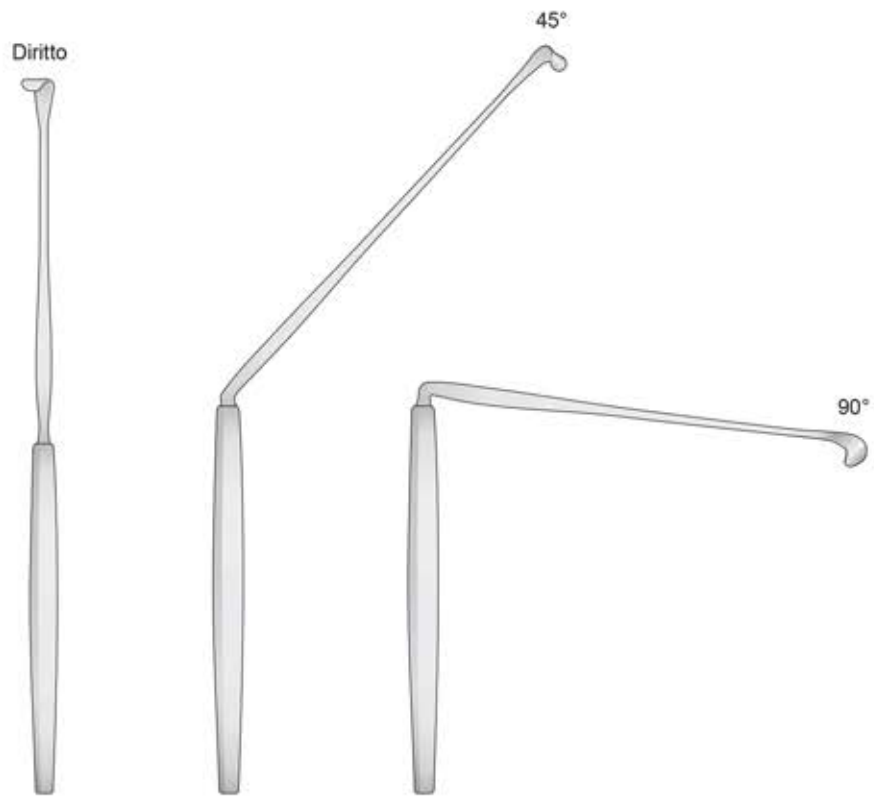

LOVE
DO-56
210 mm

LOVE
DO-57

LOVE
DO-58

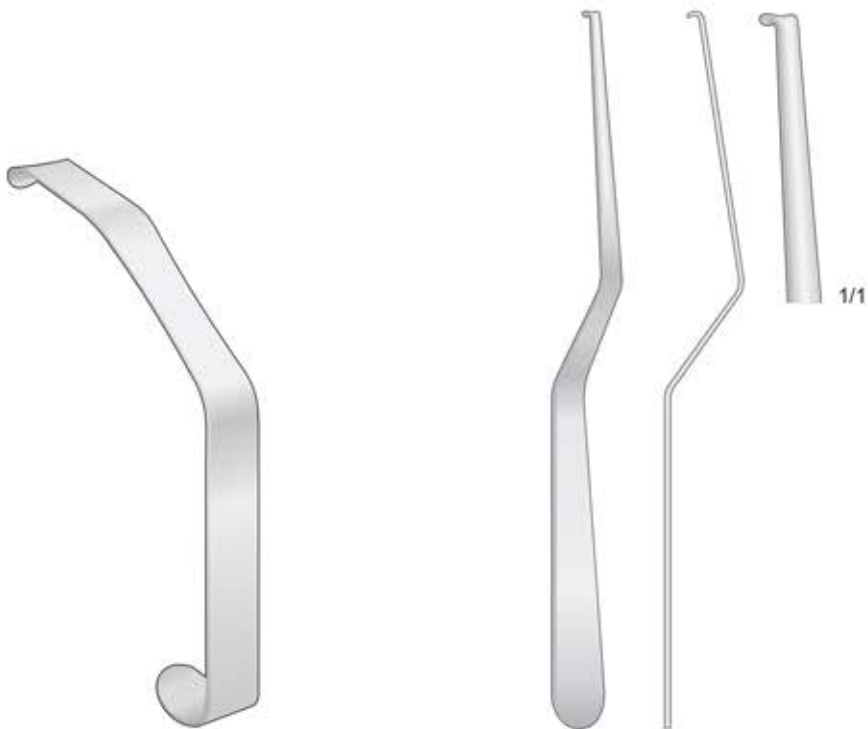

LOVE
DO-213 - 18 mm
DO-214 - 20 mm
DO-215 - 22 mm
150 mm

LOVE
DO-174
210 mm

Suction Tubes

Saugkanülen
Canules d'aspiration
Cánulas de aspiración
Cannule per aspirazione

Laminectomy

Laminektomie
Laminectomia
Laminectomía
Laminectomia

Extension Bows

Extensionsbügel
Étriers d'extension
Arcos de tracción
Archi da trazione

Knives

Messer
Couteaux
Cuchillos
Coltelli

Bone files

Knochenfeilen
Limes à os
Limas para hueso
Lime per osso

Scalpel Blades and Handles

Skalpellklingen und Skalpellgriffe
Lames et manches de bistouris
Hojas y mangos de bisturi
Lame e manici per bisturi

Char. 6	= 2 mm
Char. 7	= 2,5 mm
Char. 8	= 2,7 mm
Char. 9	= 3 mm
Char. 10	= 3,3 mm
Char. 12	= 4 mm
Char. 15	= 5 mm

Isoliert



FERGUSSON

GF-140	Ch. 6	2,0 mm
GF-141	Ch. 7	2,5 mm
GF-142	Ch. 9	3,0 mm
GF-142B	Ch. 10	3,3 mm
GF-143	Ch. 12	4,0 mm
GF-144	Ch. 15	5,0 mm

180 mm

FRAZIER

GF-240	Ch. 6	2,0 mm
GF-241	Ch. 7	2,5 mm
GF-241B	Ch. 8	2,7 mm
GF-242	Ch. 9	3,0 mm
GF-242B	Ch. 10	3,3 mm
GF-243	Ch. 12	4,0 mm
GF-244	Ch. 15	5,0 mm

180 mm

FRAZIER

GF-252	Ch. 12	180 mm
---------------	--------	--------

PLESTER

GF-150	Ch. 6	2,0 mm
GF-151	Ch. 7	2,5 mm
GF-151B	Ch. 8	2,7 mm
GF-152	Ch. 9	3,0 mm
GF-152B	Ch. 10	3,3 mm
GF-153	Ch. 12	4,0 mm
GF-154	Ch. 15	5,0 mm

200 mm

*These products are not available for sale or distribution in the USA.
For further information on product availability, please contact your local representative.*

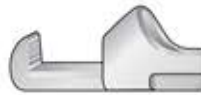

- | | | | |
|----------------------------------|----------------------------------|----------------------------------|----------------------------------|
| 1,5 mm
□ 1/1
DB-177 | 2,0 mm
□ 1/1
DB-178 | 2,2 mm
□ 1/1
DB-179 | 2,5 mm
□ 1/1
DB-180 |
| 3,0 mm
□ 1/1
DB-181 | 3,5 mm
□ 1/1
DB-182 | 4,0 mm
□ 1/1
DB-183 | |

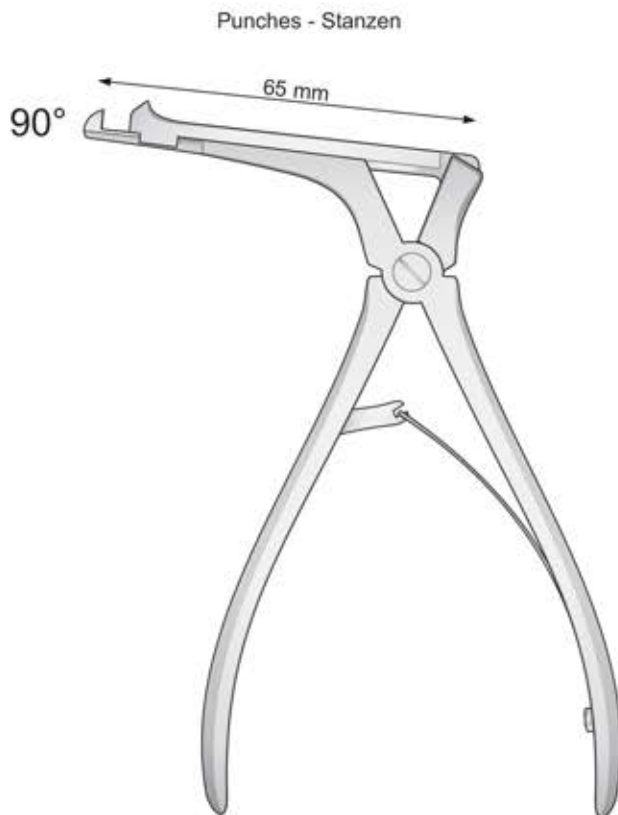

- DB-177** 1,5 mm
- DB-178** 2,0 mm
- DB-179** 2,2 mm
- DB-180** 2,5 mm
- DB-181** 3,0 mm
- DB-182** 3,5 mm
- DB-183** 4,0 mm

CITELLI
DB-177/DB-183

*These products are not available for sale or distribution in the USA.
For further information on product availability, please contact your local representative.*

Punches - Stanzen

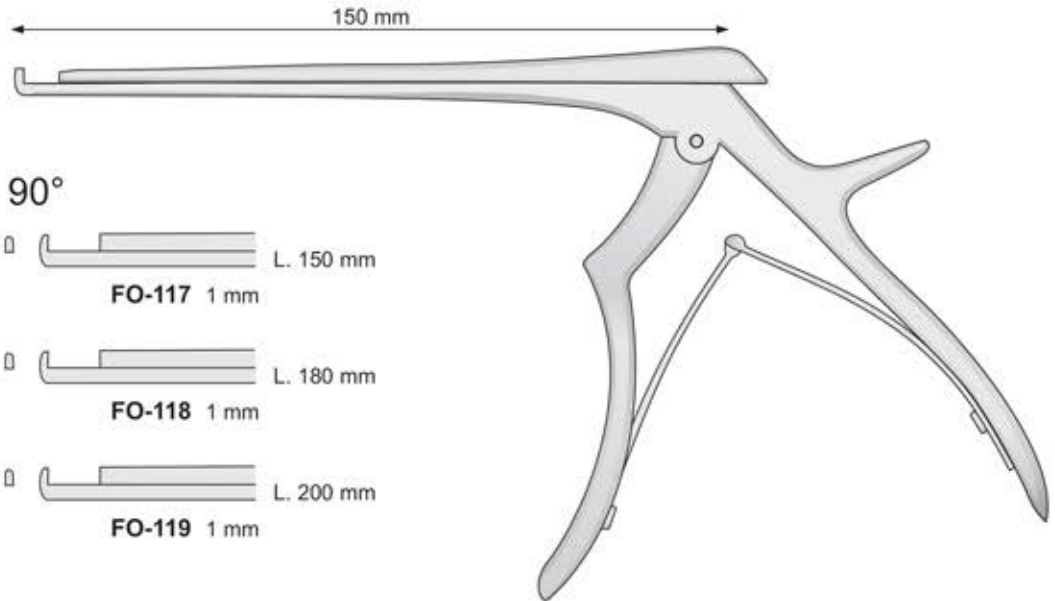

FERRIS-SMITH-KERRISON
FO-117/FO-119

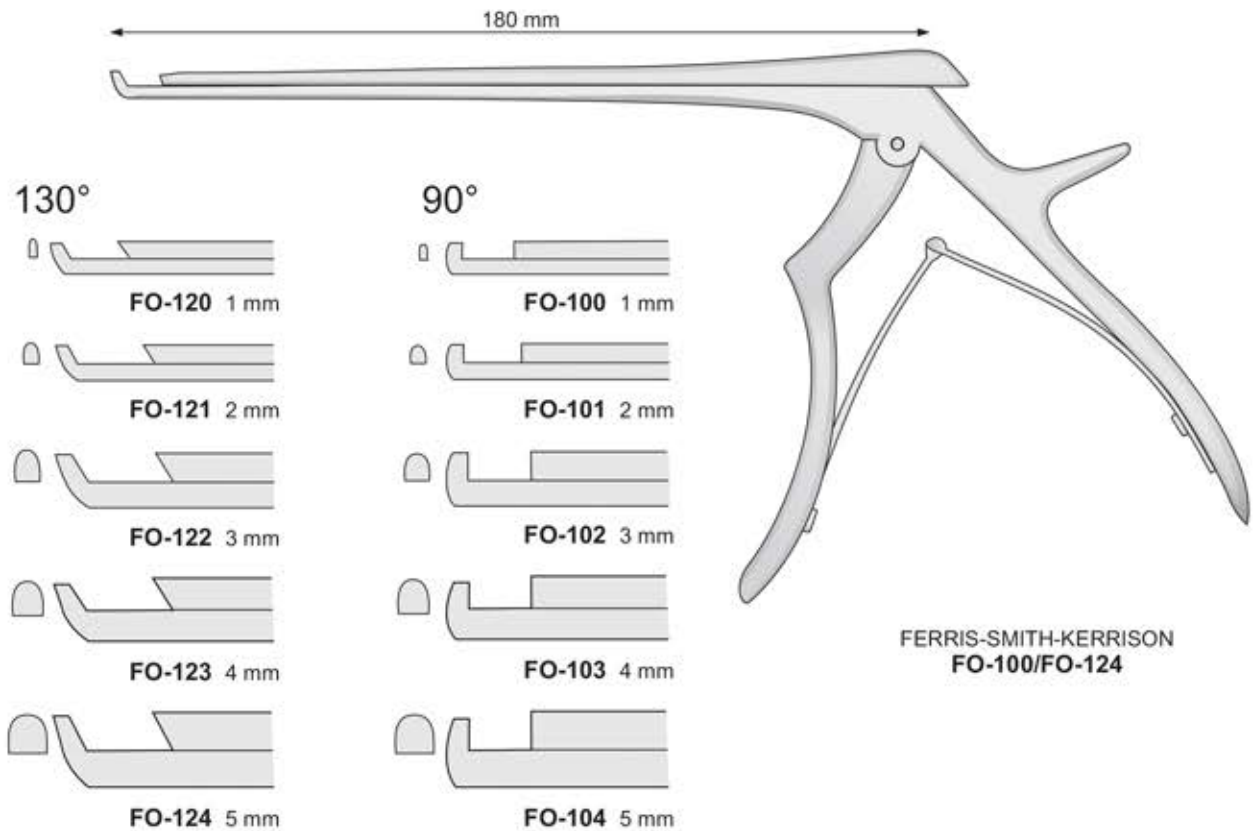

FERRIS-SMITH-KERRISON
FO-100/FO-124

*These products are not available for sale or distribution in the USA.
For further information on product availability, please contact your local representative.*

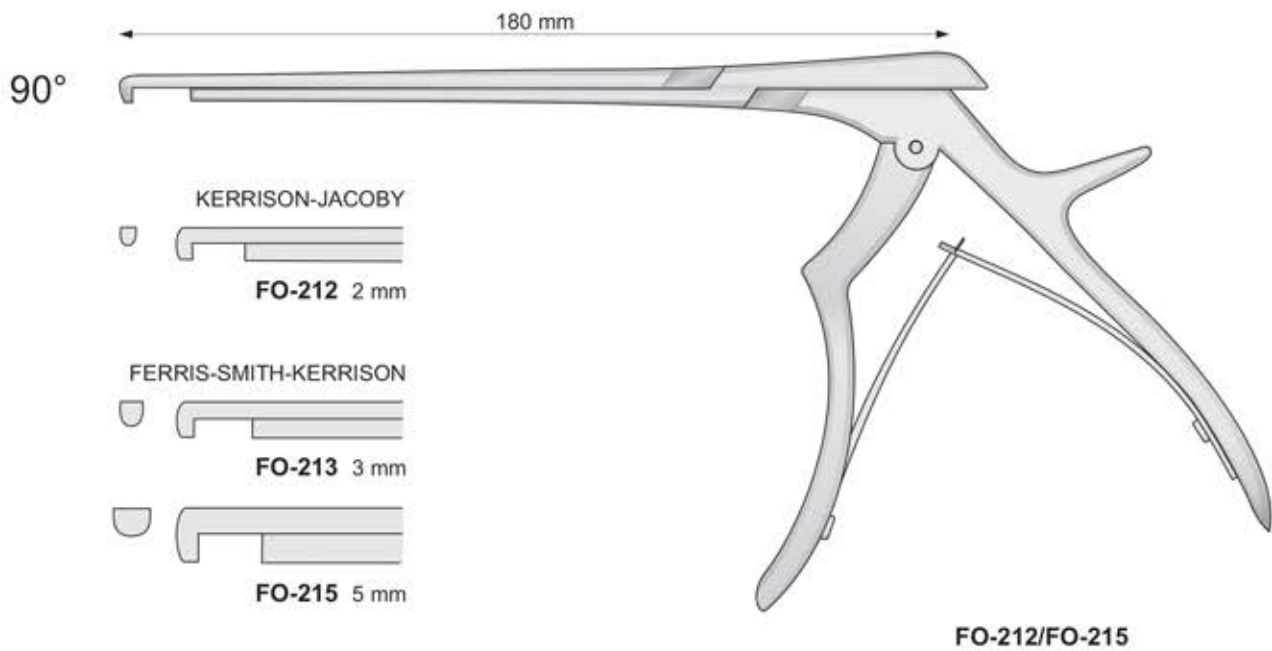
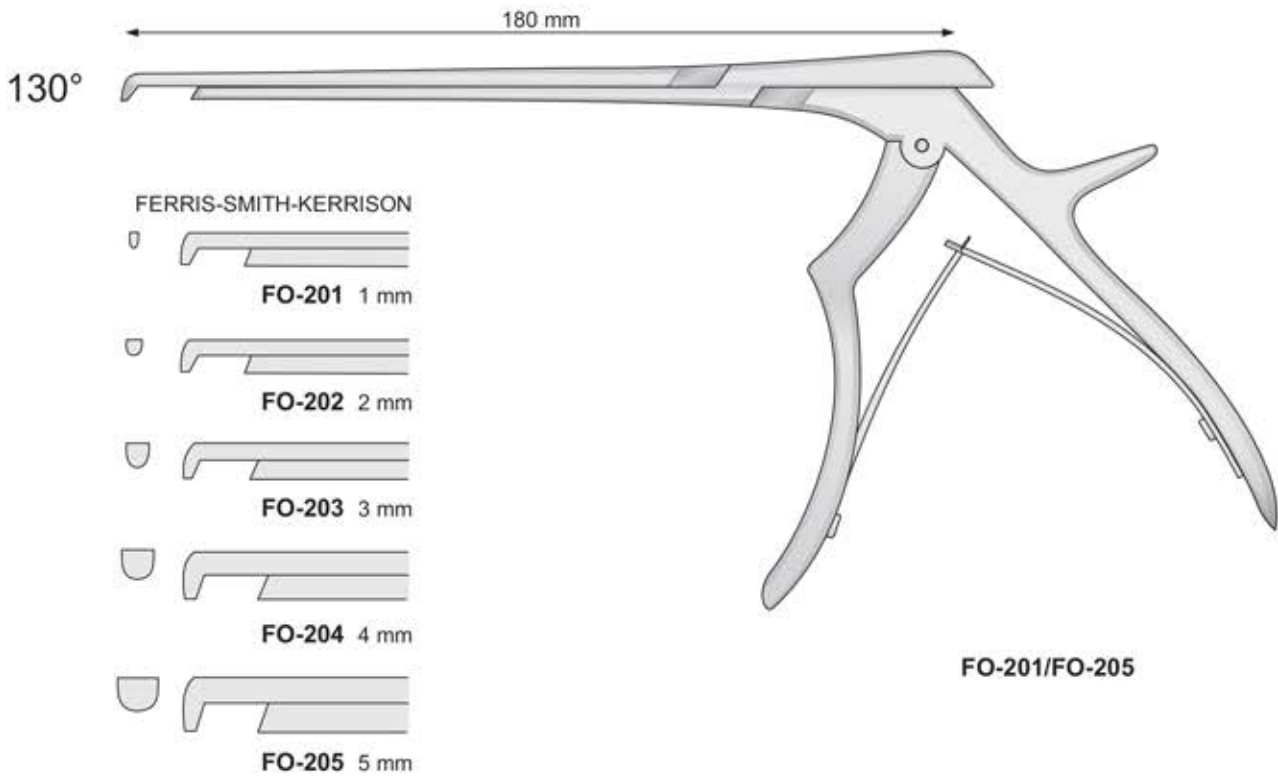

*These products are not available for sale or distribution in the USA.
For further information on product availability, please contact your local representative.*

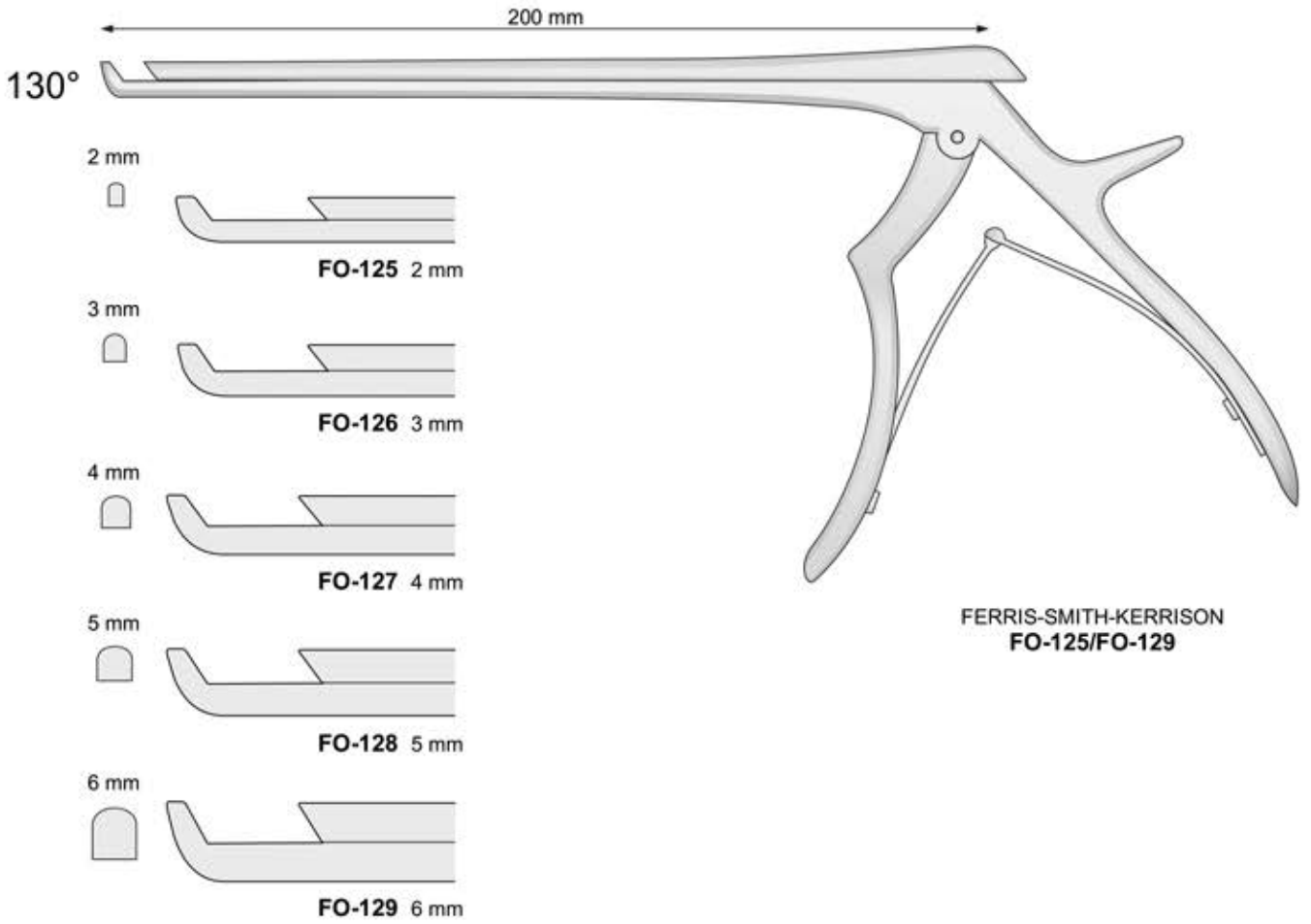

Laminotomo cervicale - Cervical Laminectomy

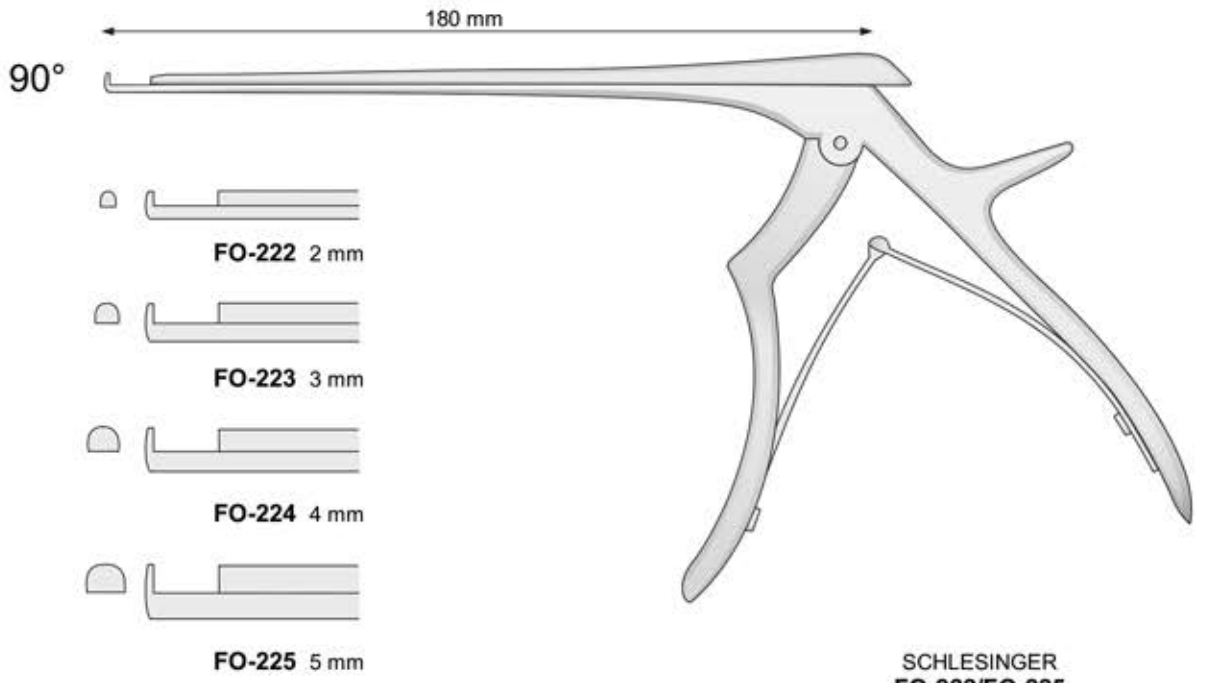

*These products are not available for sale or distribution in the USA.
For further information on product availability, please contact your local representative.*

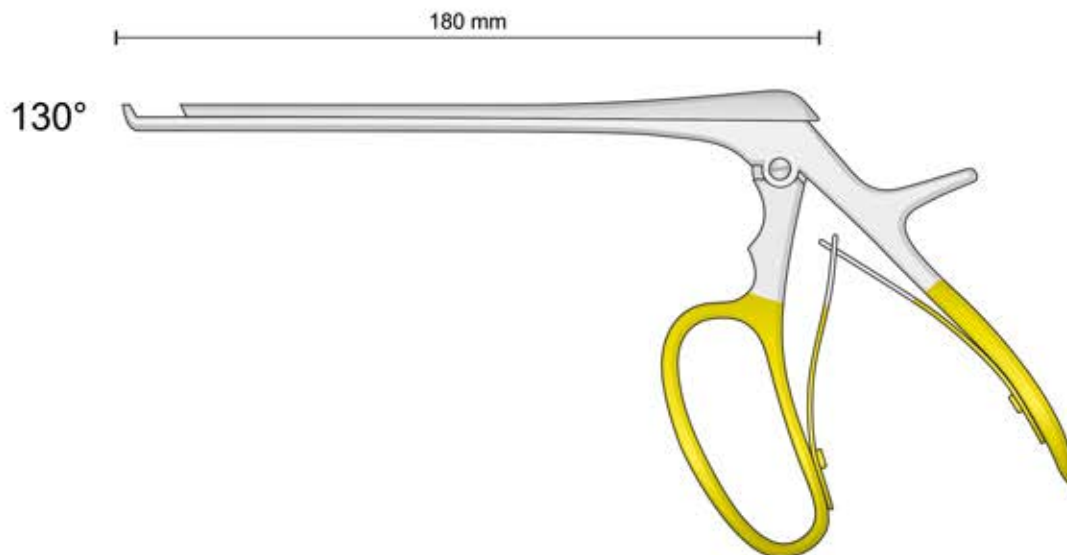
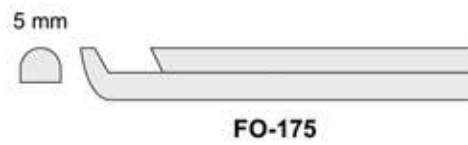
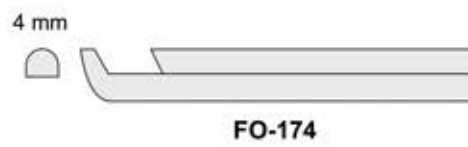
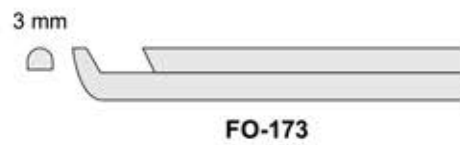

FERRIS - SMITH - KERRISON
FO-171/FO-175

*These products are not available for sale or distribution in the USA.
For further information on product availability, please contact your local representative.*

Gerade
Straight
Diritta
Rectas
Droites

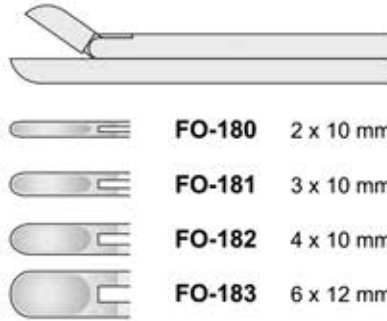

Aufwärtsgebogen
Top curved
Curva verso l'alto
Curvos
Courbe vers le haut

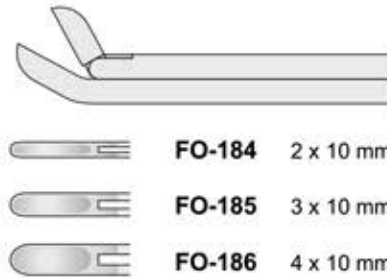

Abwärts gebogen
Bottom curved
Curva verso il basso
Curvos
Courbe vers le bas

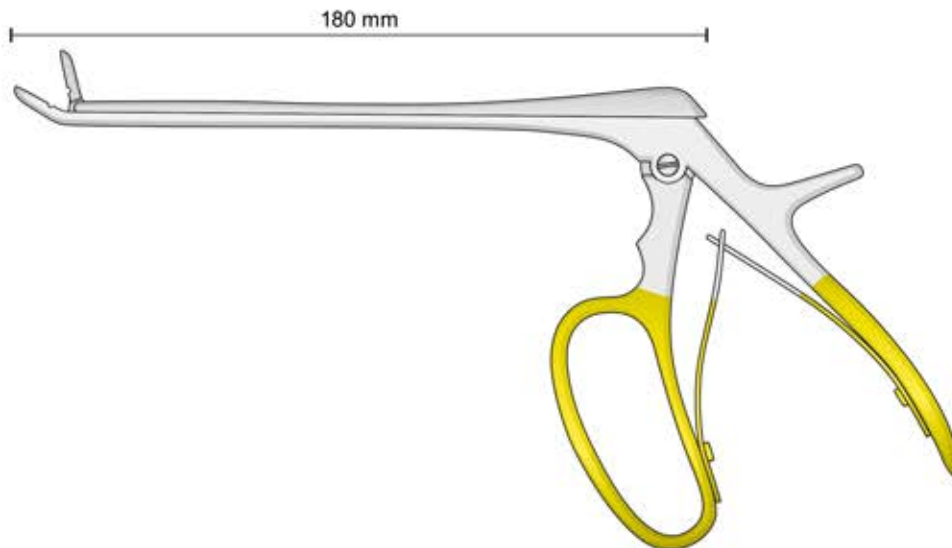
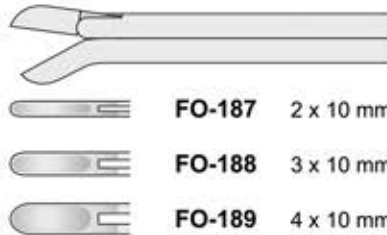

FERRIS - SMITH - CUSHING
FO-180/FO-189

*These products are not available for sale or distribution in the USA.
For further information on product availability, please contact your local representative.*

Gerade
Straight
Diritta
Rectas
Droites

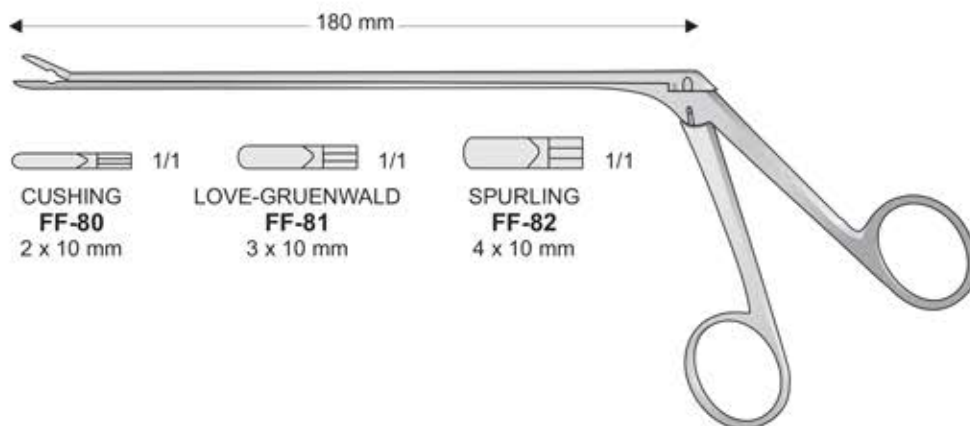

FF-80/FF-82

Aufwärtsgebogen
Top curved
Curva verso l'alto
Curvos
Courbe vers le haut

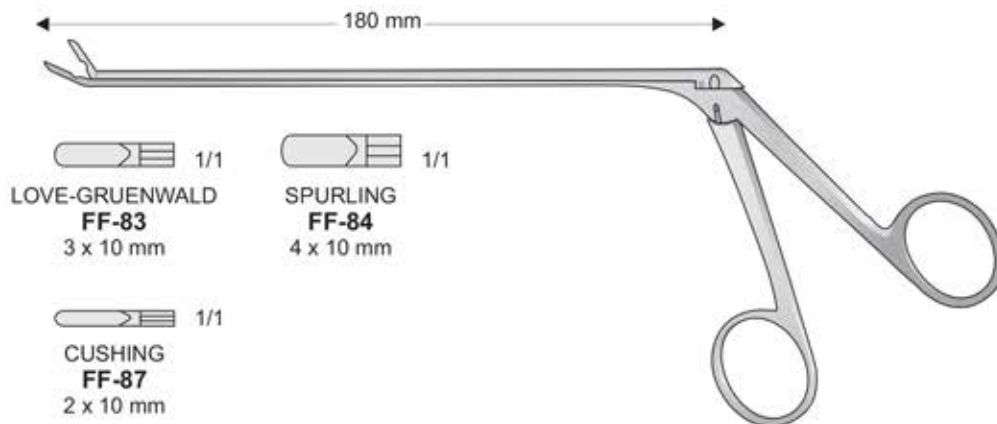

FF-83/FF-87

Abwärts gebogen
Bottom curved
Curva verso il basso
Curvos
Courbe vers le bas

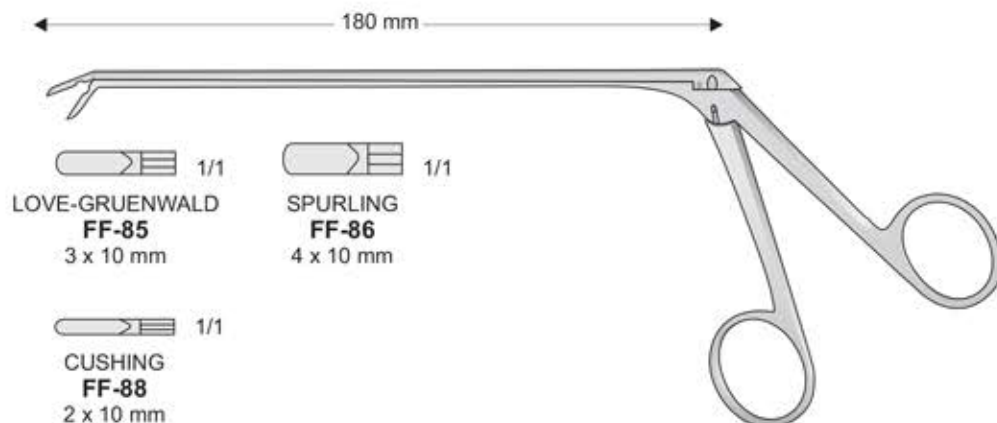

FF-85/FF-88

*These products are not available for sale or distribution in the USA.
For further information on product availability, please contact your local representative.*

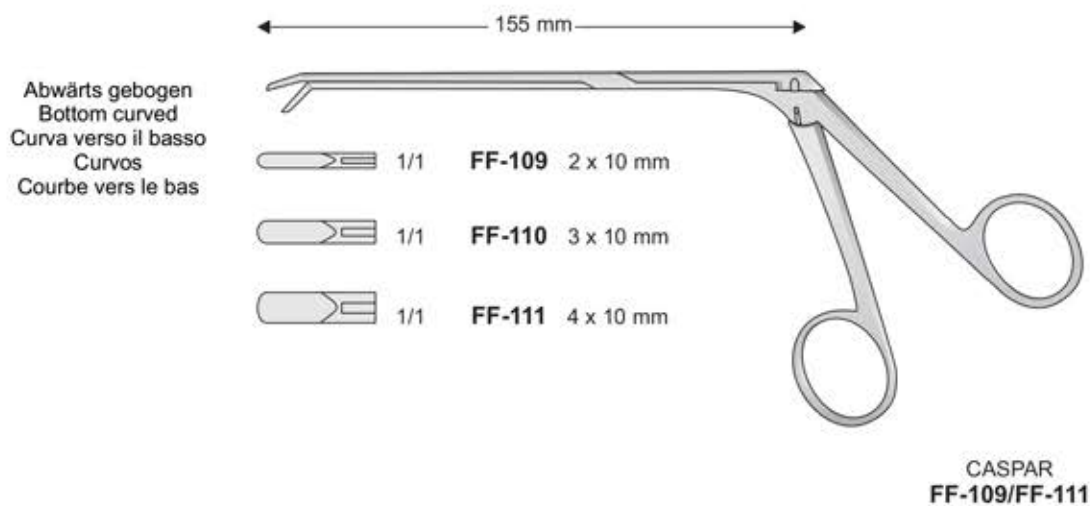
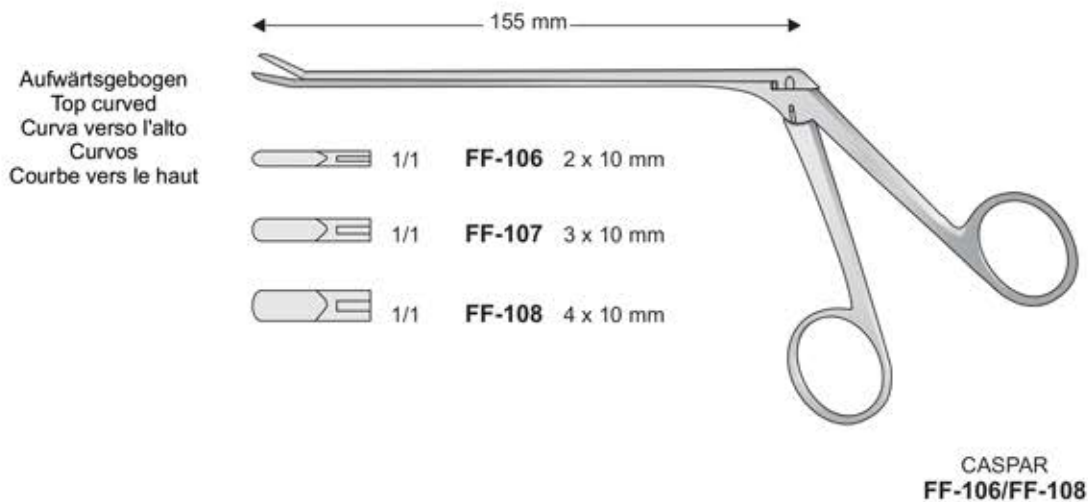
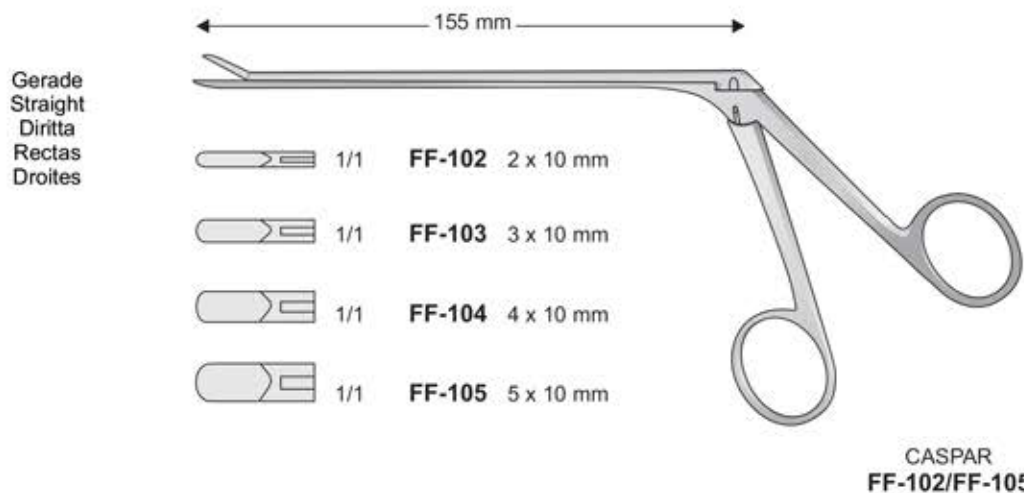

*These products are not available for sale or distribution in the USA.
For further information on product availability, please contact your local representative.*

Gerade
Straight
Diritta
Rectas
Droites

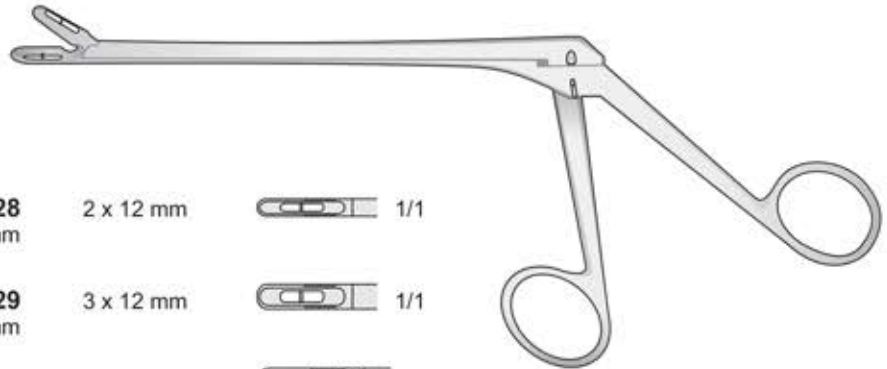

CASPAR

FF-120 140 mm	FF-123 160 mm	FF-128 185 mm	2 x 12 mm	 1/1
FF-121 140 mm	FF-124 160 mm	FF-129 185 mm	3 x 12 mm	 1/1
FF-122 140 mm	FF-125 160 mm	FF-130 185 mm	4 x 14 mm	 1/1
	FF-126 160 mm	FF-131 185 mm	5 x 14 mm	 1/1
	FF-127 160 mm	FF-132 185 mm	6 x 16 mm	 1/1

CASPAR
FF-120/FF-132

Aufwärtsgebogen
Top curved
Curva verso l'alto
Curvos
Courbe vers le haut

150°

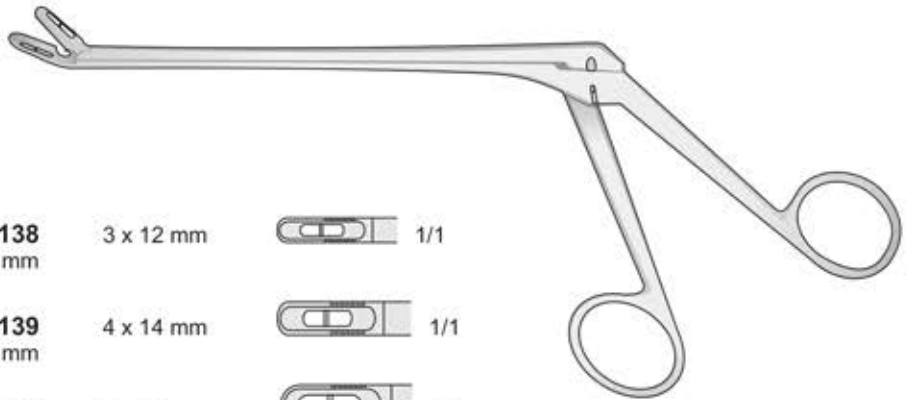

CASPAR

FF-133 140 mm	FF-135 160 mm	FF-138 185 mm	3 x 12 mm	 1/1
FF-134 140 mm	FF-136 160 mm	FF-139 185 mm	4 x 14 mm	 1/1
	FF-137 160 mm	FF-140 185 mm	5 x 14 mm	 1/1

CASPAR
FF-133/FF-140

Abwärts gebogen
Bottom curved
Curva verso il basso
Curvos
Courbe vers le bas

150°

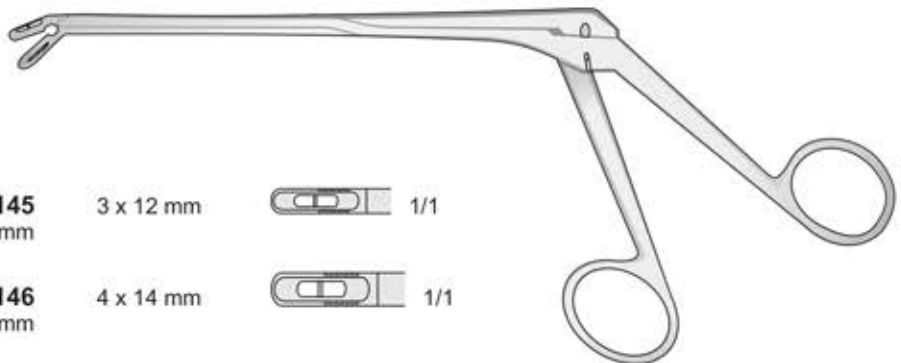

CASPAR

FF-141 140 mm	FF-143 160 mm	FF-145 185 mm	3 x 12 mm	 1/1
FF-142 140 mm	FF-144 160 mm	FF-146 185 mm	4 x 14 mm	 1/1

CASPAR
FF-141/FF-146

*These products are not available for sale or distribution in the USA.
For further information on product availability, please contact your local representative.*

Gerade
Straight
Diritta
Rectas
Droites

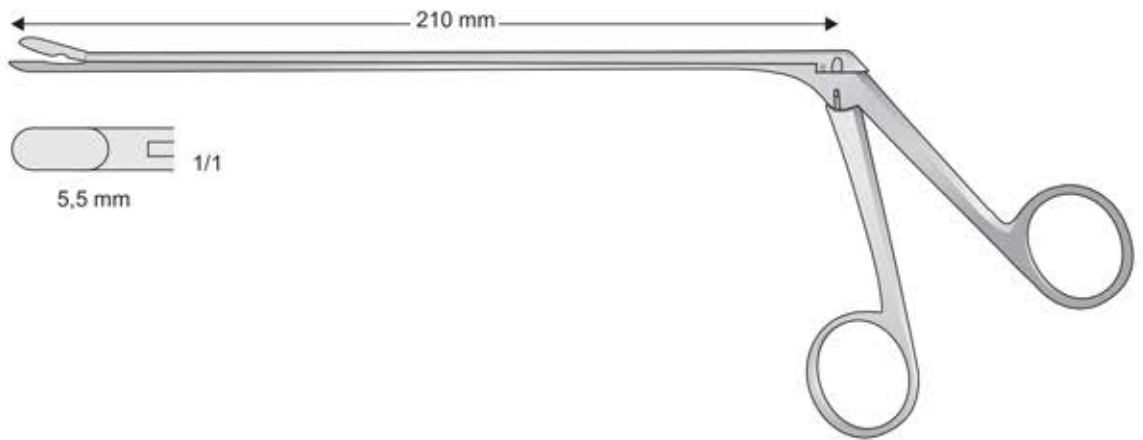

**WAGNER
FF-90**

Gerade
Straight
Diritta
Rectas
Droites

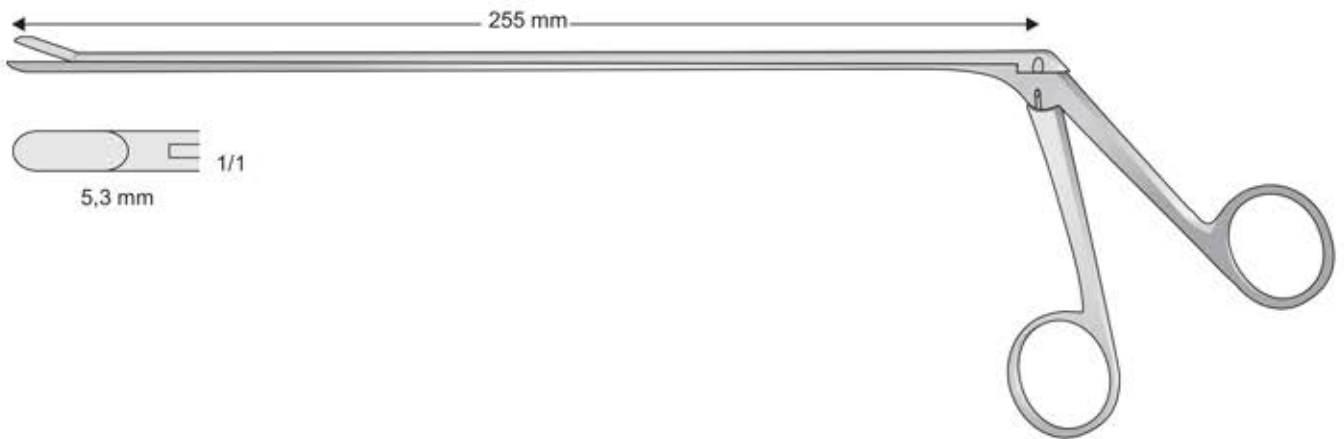

FF-91

Aufwärtsgebogen
Top curved
Curva verso l'alto
Curvos
Courbe vers le haut

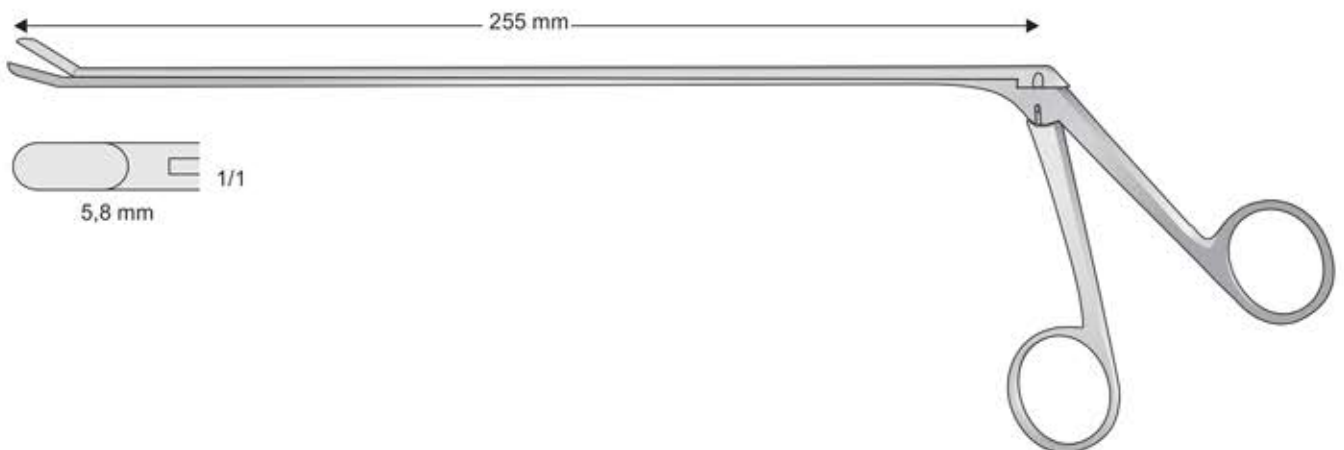

**SYPERT
FF-92**

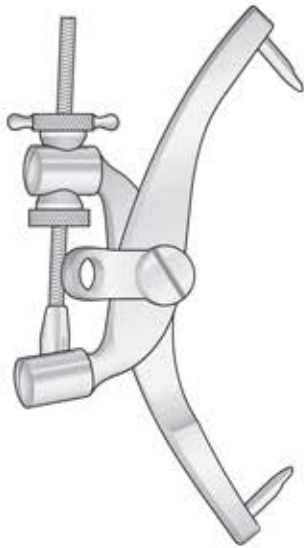

CRUTCHFIELD
FF-394

Drill points only
Vorböhrer dazu

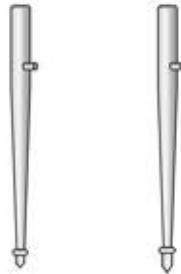

FF-395

FF-396

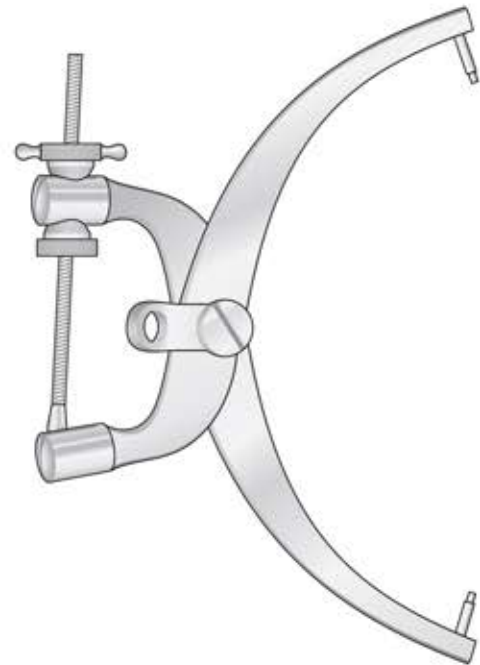

CRUTCHFIELD
FF-397



FF-398

Doppelschlüssel zu FF-398



FF-399

Amputation
Amputazione

NK-31/NK-57



1/1

NK-50
150 mm

1/1

NK-51
155 mm

1/1

NK-31
158 mm

1/1

NK-52
160 mm

1/1

NK-53
170 mm

1/1

NK-35
175 mm

1/1

NK-54
150 mm

1/1

NK-55
155 mm

1/1

NK-33
158 mm

1/1

NK-56
160 mm

1/1

NK-57
170 mm

1/1

NK-37
175 mm

mm: Schnittlänge
 Length of blades
 Lunghezza della lama
 Largo de hojas
 Longueur de la lame

Metallheft
 Metal handle
 Manico in metallo
 Mango metálico
 Manche métal

Holzheft
 Wooden handle
 Manico in legno
 Mango de madera
 Manche bois

Metallheft
 Metal handle
 Manico in metallo
 Mango metálico
 Manche métal

Metallheft
 Metal handle
 Manico in metallo
 Mango metálico
 Manche métal

Resektionsmesser
 Resection knives
 Coltello per resezione
 Cuchillos para resección
 Couteaux à résection

Organmesser
 Post mortem knives
 Coltello per autopsia
 Cuchillos para órganos
 Couteaux à autopsie

Organmesser
 Post mortem knives
 Coltello per autopsia
 Cuchillos para órganos
 Couteaux à autopsie

Hirnmesser
 Brain knives
 Coltello per cervello
 Cuchillos para cerebro
 Couteaux à cerveau



AN-10
55 mm

1/1



AN-11
55 mm

1/1



AN-12
110 mm



AN-13
170 mm



AN-14
195 mm



1/1



VIRCHOW
AN-15
160 mm



VIRCHOW
AN-16
200 mm



VIRCHOW
AN-17
240 mm

LANGENBECK
AN-10/AN-11
55 mm

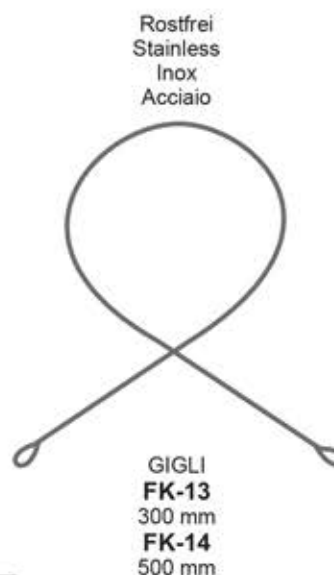

LS-300
Komplett mit 3 Sägen
Complete with 3 saws
Completa con 3 seghe
Completo con 3 sierras
Complet avec 3 scies



COLLIN
LS-300
390 mm

Fig.1 Fig.2 Fig.3

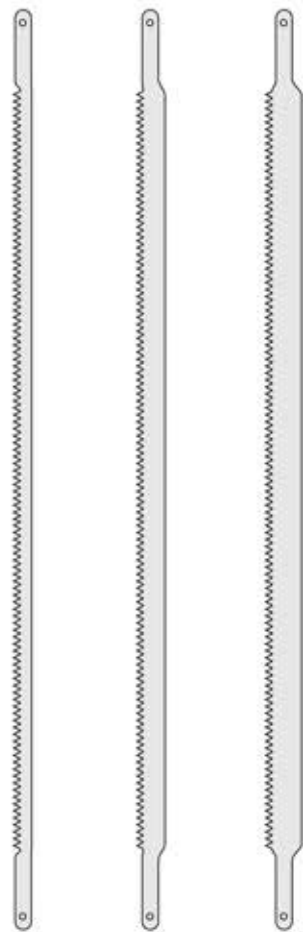

LS-301 LS-302 LS-303
280 mm 280 mm 280 mm



LINDEMANN
FK-243
200 mm



LANGENBECK
FK-244
235 mm



LB-361
Conf. 10 pz.



LB-362
Conf. 10 pz.



LB-363
Conf. 1 pz.



LB-364
Conf. 10 pz.



LB-365
Conf. 10 pz.



LB-366
Conf. 1 pz.



LB-367
Conf. 10 pz.



LB-368
Conf. 10 pz.



LB-369
Conf. 1 pz.



NK-1
100 mm



NK-2
150 mm



BB-46
135 mm



BB-48 - 155 mm
BB-50 - 180 mm
BB-52 - 200 mm



CASPAR
BB-50



BB-52



LANDOLT
BB-38
250 mm



LANDOLT
BB-40
210 mm

Towel Clamps

Tuchklemmen
Pince fixe-compresses
Pinzas de campo
Fissateli

Scissors

Scheren
Ciseaux
Tijeras
Forbici

Tissue Forceps

Chirurgische Pinzetten
Pinces à tissu
Pinzas quirúrgicas
Pinzette chirurgiche

Needle Holders

Nadelhalter
Porte-aiguilles
Porta-agujas
Port'aghi

Hemostatic Forceps

Arterienklemmen
Pinces hémostatiques
Pinzas hemostáticas
Pinzette emostatiche



SCHAEDEL
BF-38
85 mm



FAURE
BF-40
85 mm

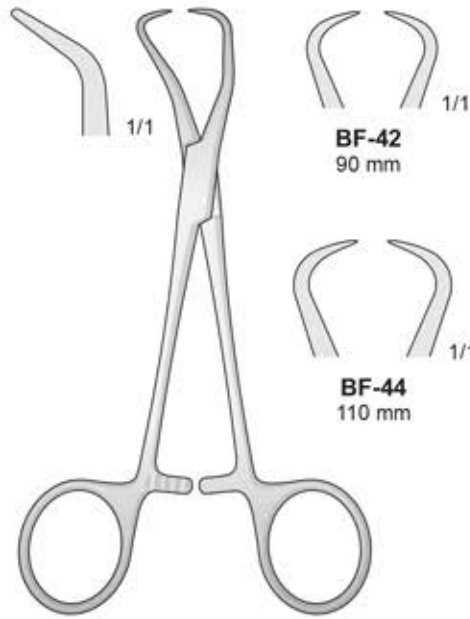

BACKHAUS
BF-41/BF-46

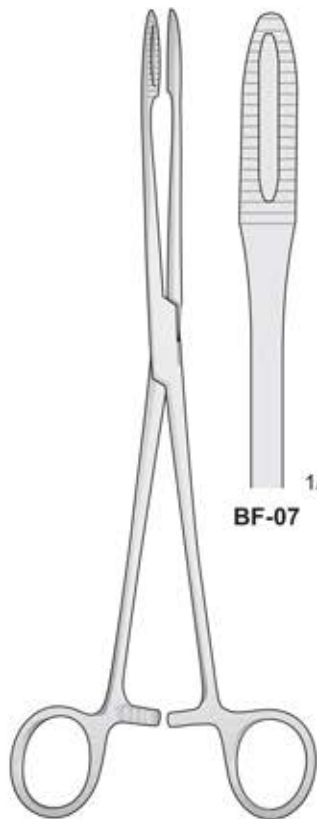

MAIER
BF-07/BF-08
265 mm

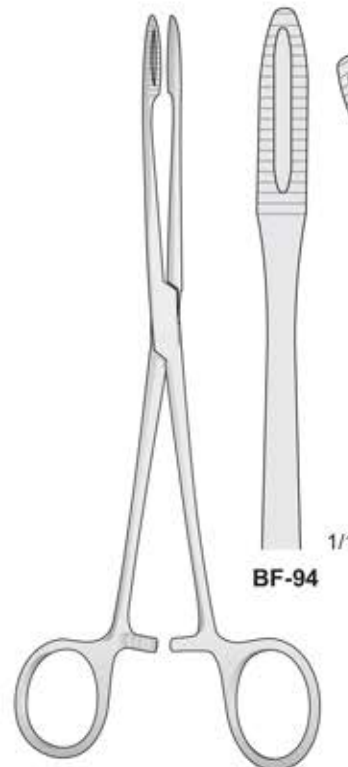
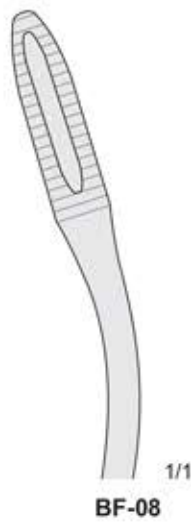
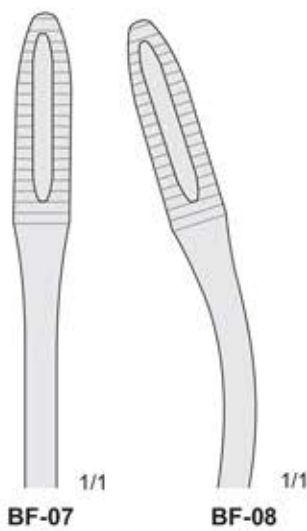

GROSS
BF-94/BF-95
200 mm

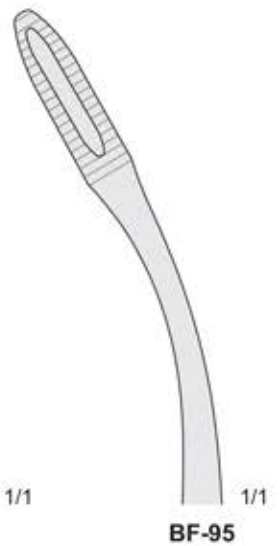

"Ribbon type"

Mit großen Ringen
With large rings
Forbici ad anelli grandi
Con anillos especialmente grandes
avec larges anneaux

Irisscheren - Iris scissors
Forbici per iridectomia - Tijeras para iridectomia
Ciseaux à iridectomie

Blepharoplasty
Blefaroplastica

Spitz - Sharp
Acuta - Aguda
Pointu

Spitz - Sharp
Acuta - Aguda
Pointu

Stumpf - Blunt
Smussa - Romas
Mousse

Spitz - Sharp
Acuta - Aguda
Pointu

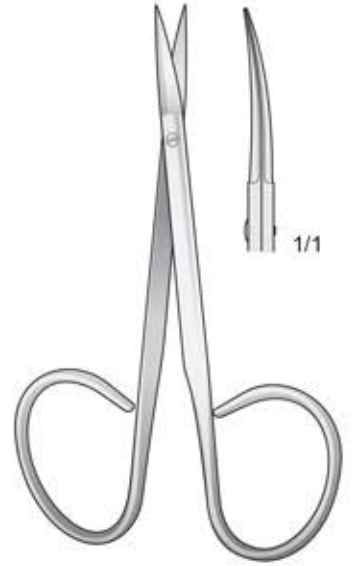
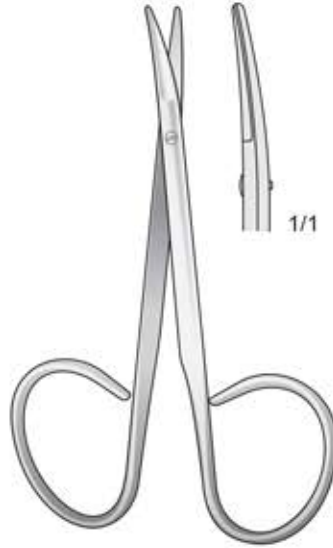
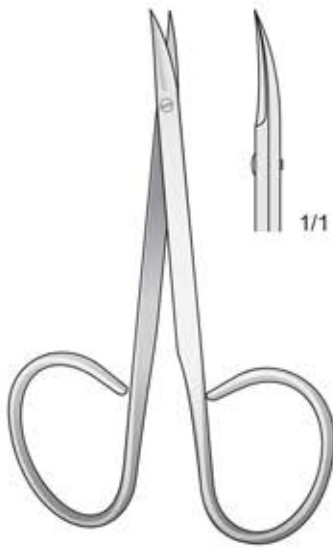
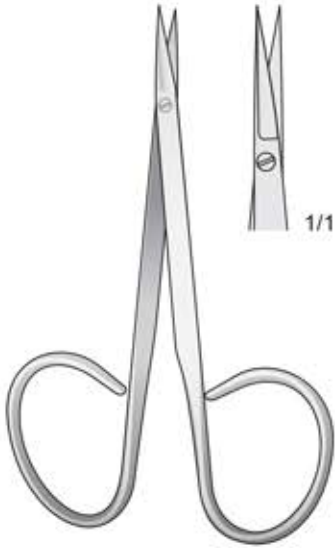

FG-200
95 mm

FG-201
95 mm

FG-202
95 mm

FG-203
105 mm

Strabismusscheren - Strabismus Scissors
Forbici da strabismo - Tijeras para estrabismo
Ciseaux à strabisme

Irisscheren - Iris scissors
Forbici per iridectomia - Tijeras para iridectomia
Ciseaux à iridectomie

Stumpf - Blunt
Smussa - Romas
Mousse

Stumpf - Blunt
Smussa - Romas
Mousse

Spitz - Sharp
Acuta - Aguda
Pointu

Spitz - Sharp
Acuta - Aguda
Pointu

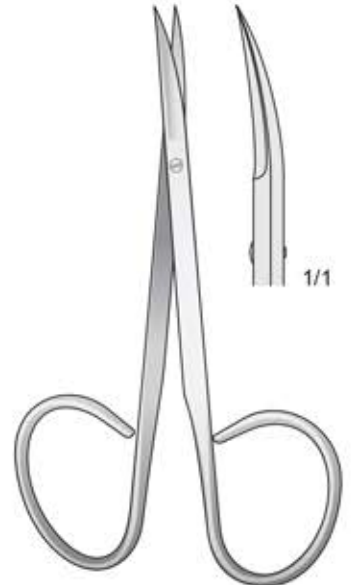
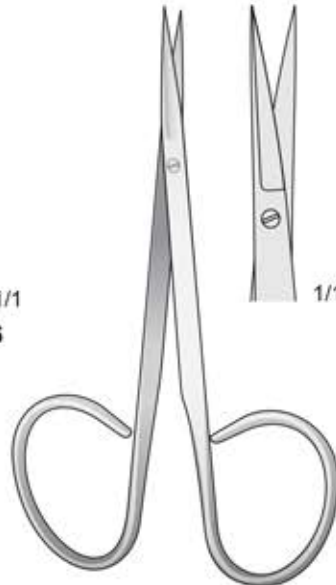
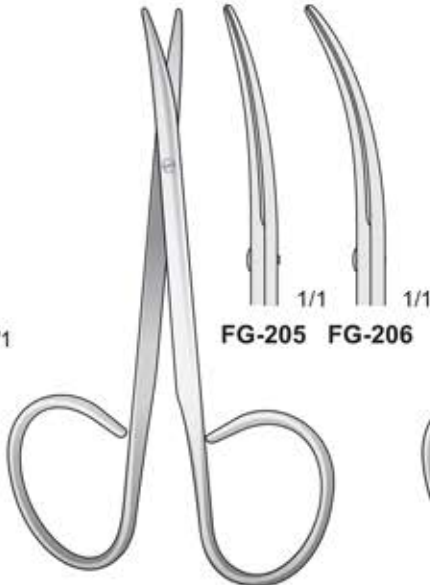
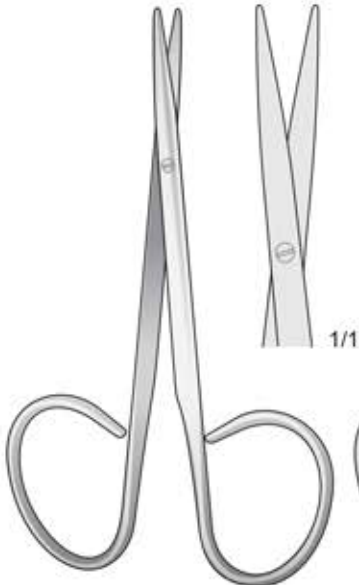

FG-204
100 mm

FG-205/FG-206
100 mm

FG-207
105 mm

FG-208
105 mm

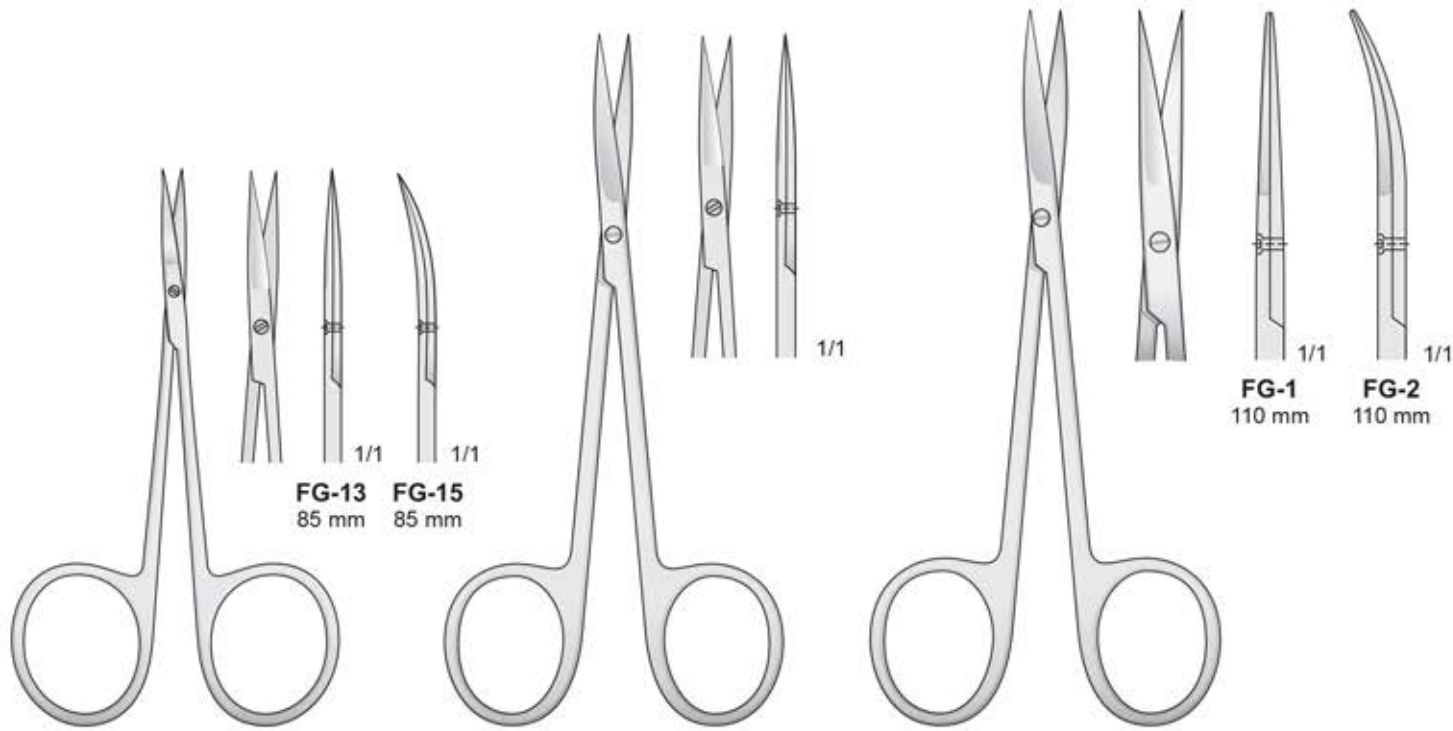

MICRO-IRIS
FG-13/FG-15
85 mm

FG-4
105 mm

IRIS
FG-1/FG-2
110 mm

Spitz - Sharp
Acuta - Aguda
Pointu



FG-3
115 mm

BABY - METZENBAUM
FM-48
115 mm

METZENBAUM
FG-14/FG-28
145 mm

Stumpf - Blunt - Smusse
Romas - Mousses

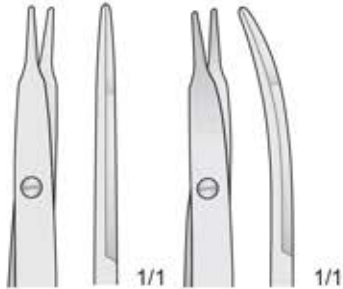

FG-50

FG-51

Spitz - Sharp - Acuta
Aguda - Pointu

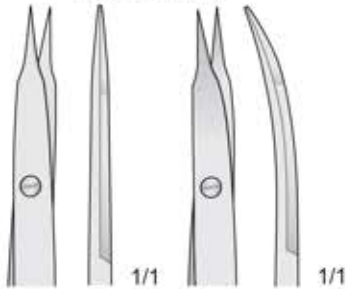

FG-52

FG-53

FG-19R
135 mm

FG-19C
135 mm

FG-6C
150 mm



STEVENS
FG-50/FG-53
110 mm

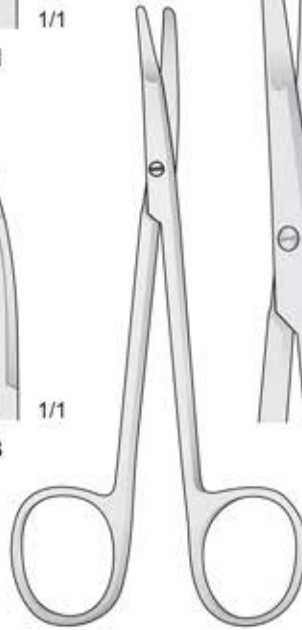

KILNER
FG-6C/FG-19R

Stumpf - Blunt - Smusse
Romas - Mousses

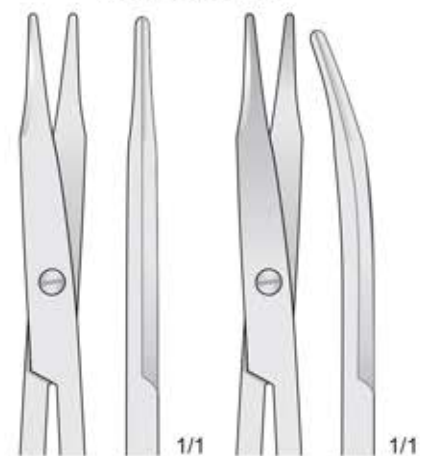

FG-54
150 mm

FG-55
150 mm

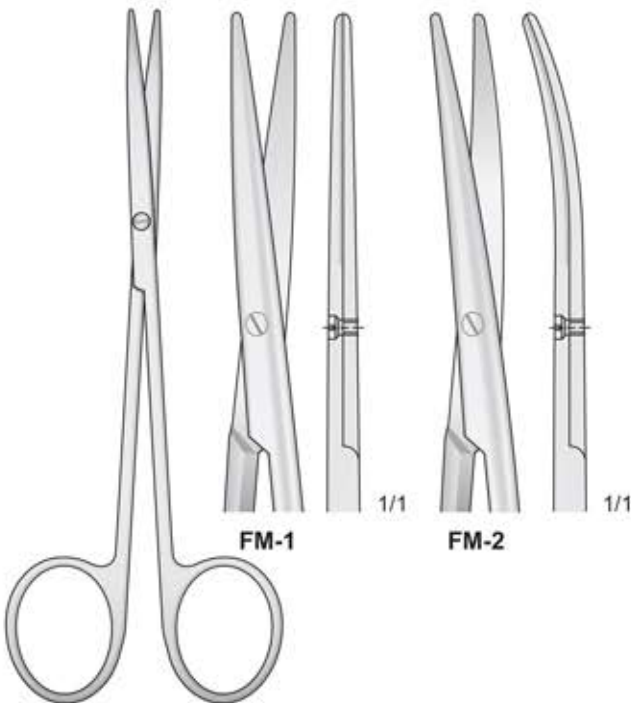

FM-1

FM-2



METZENBAUM
FM-1/FM-2
145 mm

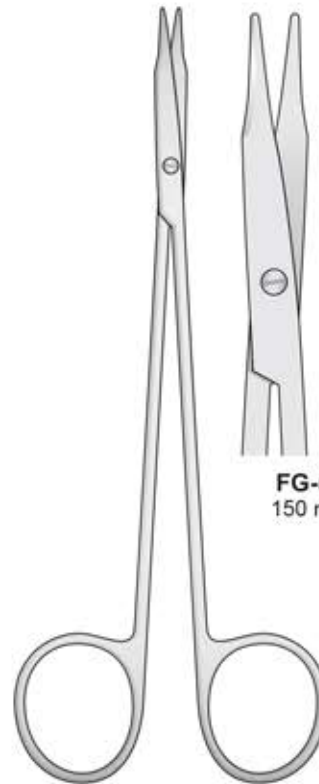

REYNOLDS
FG-54/FG-55

Mit Hartmetalleinsätzen - Tungsten-carbide scissors
 Con punta al carburo di tungsteno - Tijeras de tungsteno
 Avec plaquettes en carbure de tungstène

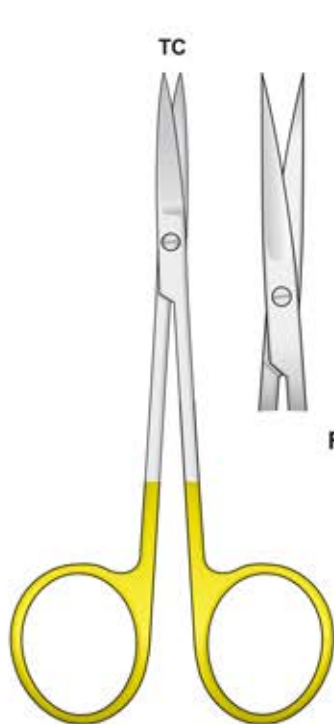

IRIS
FG1-TC/FG2-TC
 115 mm

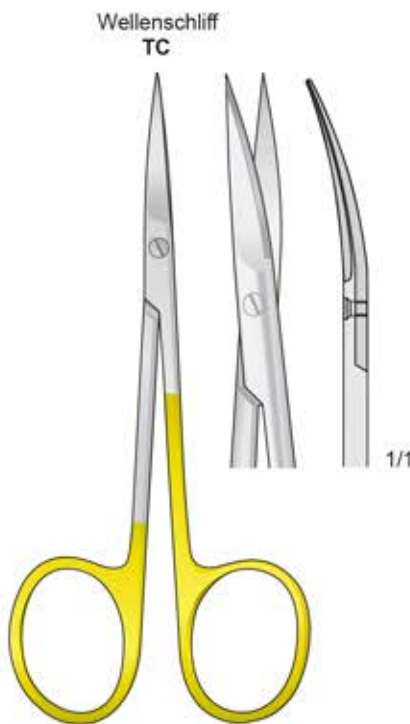

IRIS
FM-100
 110 mm

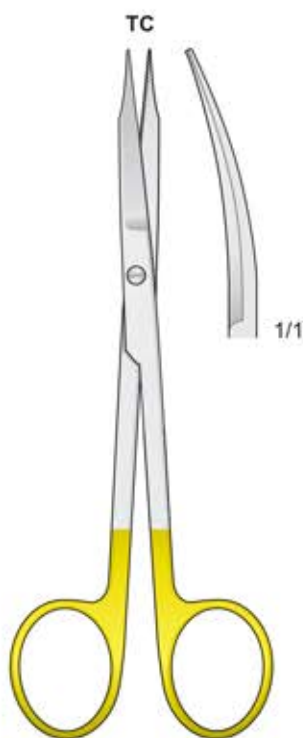

GOLDMAN-FOX
GFC-TC
 135 mm



JOSEPH
FG-153/FG-154
 150 mm

Mit Hartmetalleinsätzen - Tungsten-carbide scissors
 Con punta al carburo di tungsteno - Tijeras de tungsteno
 Avec plaquettes en carbure de tungstène



FM-96
140 mm

METZENBAUM-FINO
FM-96/FM-98



FM-98
140 mm

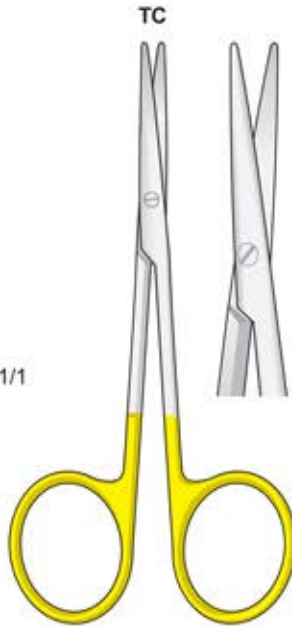

FM-118
115 mm



FM-119
115 mm

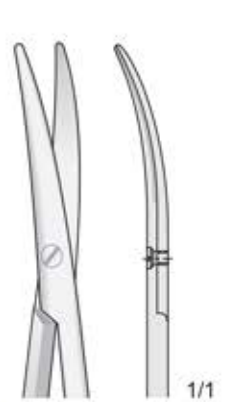

METZENBAUM
FM-66/FM-67
145 mm

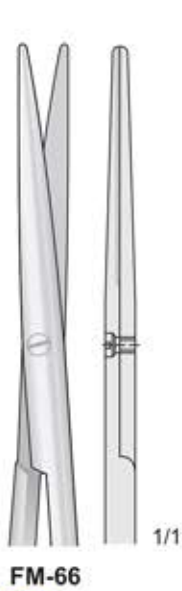

FM-66



FM-67

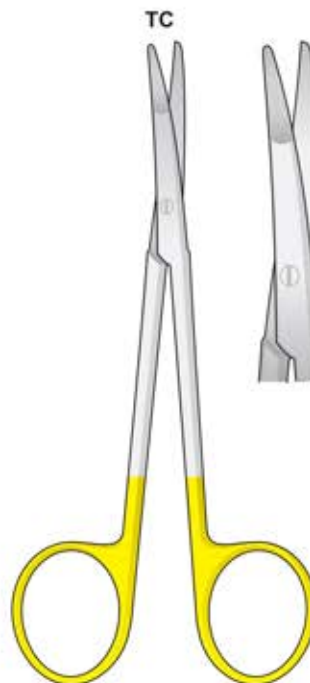

KILNER (RAGNELL)
FM-350
125 mm

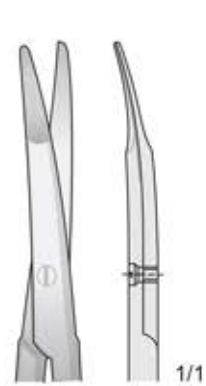

1/1

Spitz - Sharp
Acuta - Agudo - Aigu



FM-46
185 mm

Standard
TC

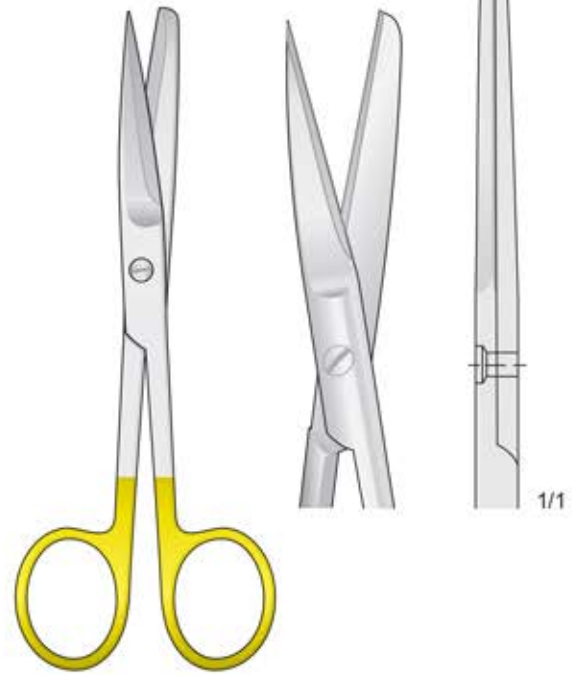

FM-51
145 mm

Standard
TC

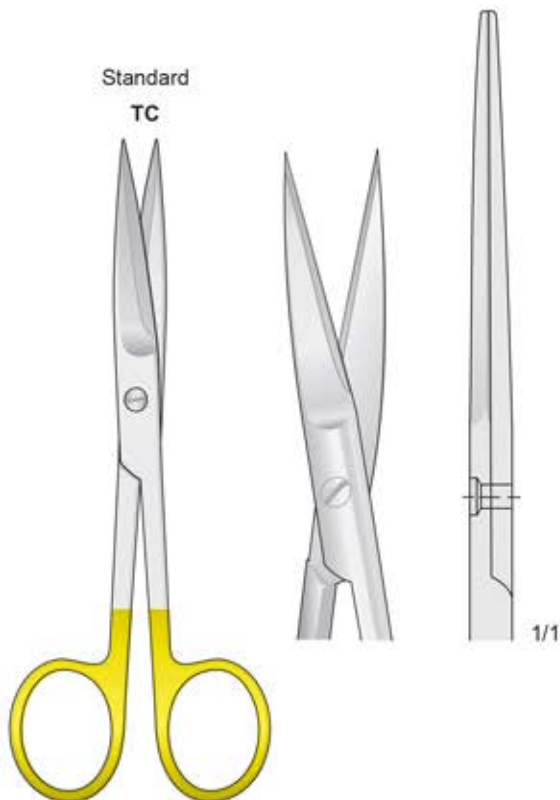

FM-59
145 mm

TC

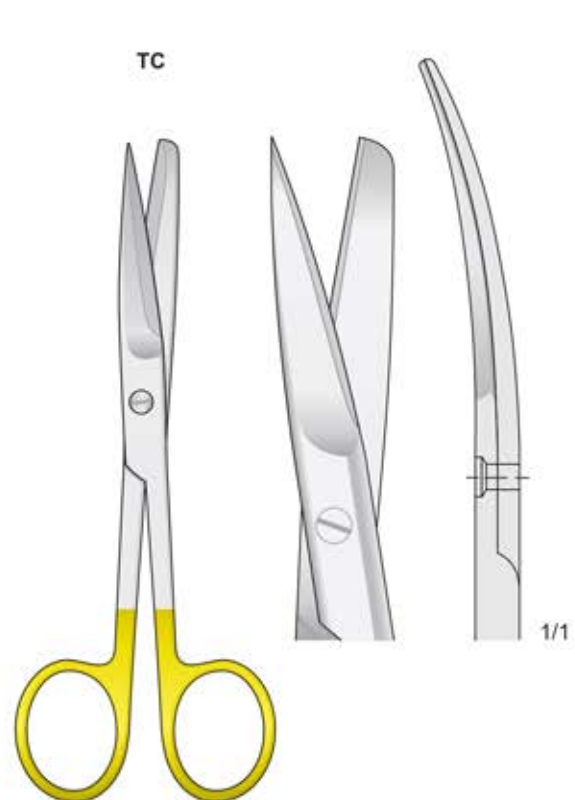

FM-149
145 mm

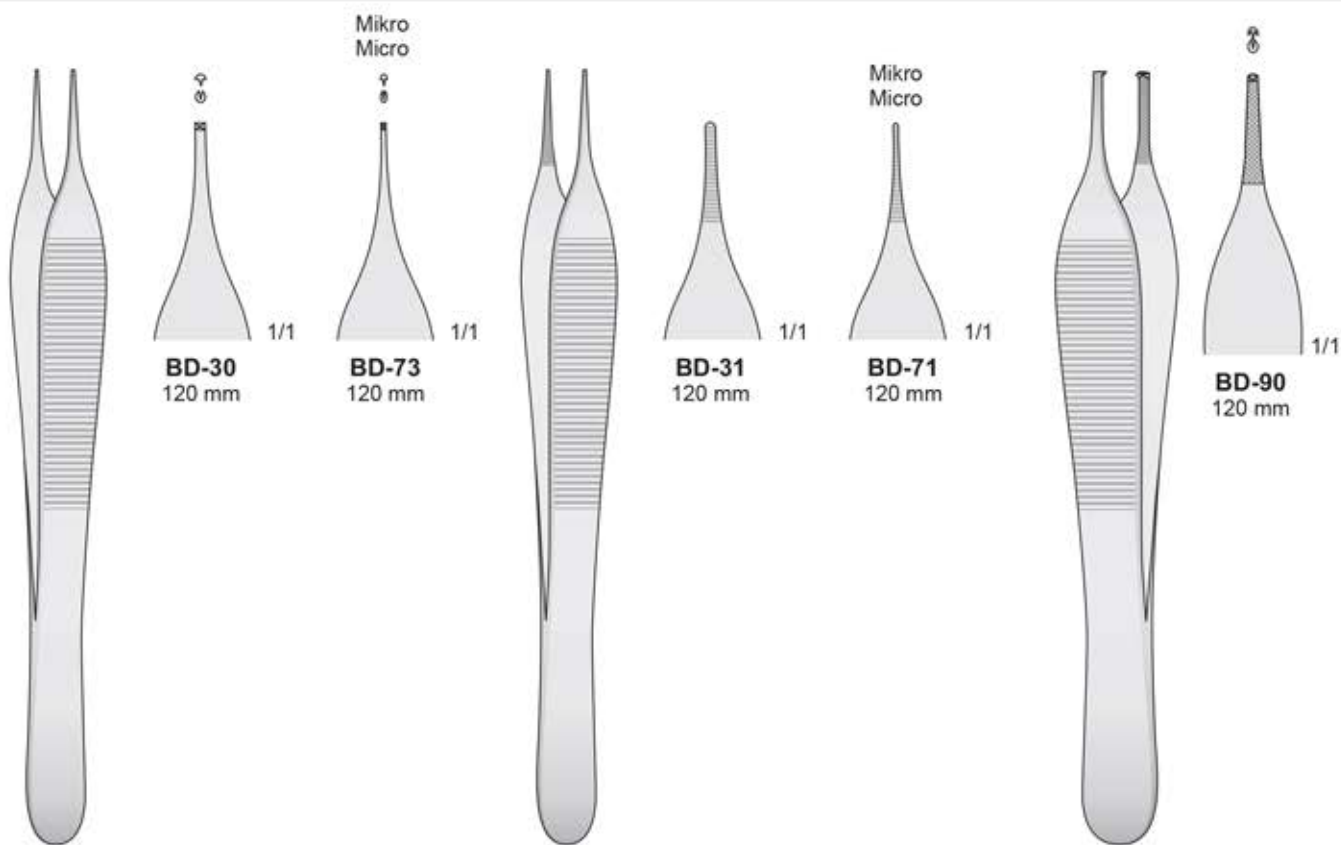

ADSON
BD-30/BD-73

ADSON
BD-31/BD-71

ADSON
BD-90
120 mm

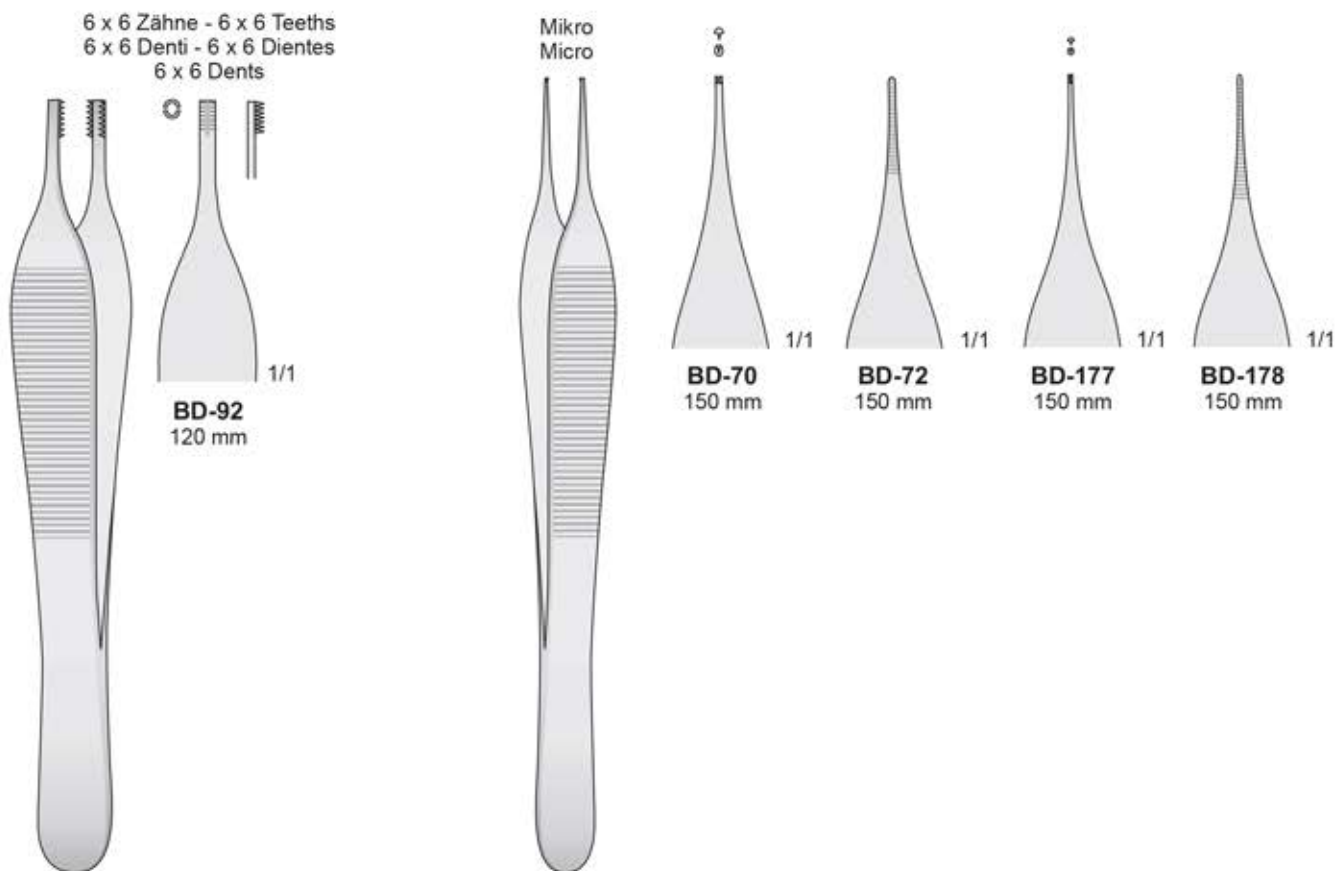

ADSON-BROWN
BD-92
120 mm

ADSON
BD-70/BD-178
150 mm



BD-60/BD-62
110 mm

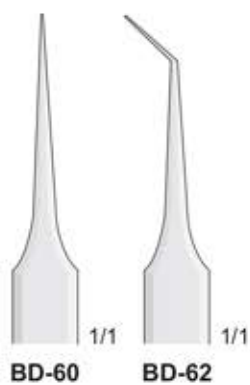

BD-60

BD-62



BD-64/BD-66
110 mm



BD-64

BD-66



BD-68
90 mm



BD-68



BD-200/BD-203

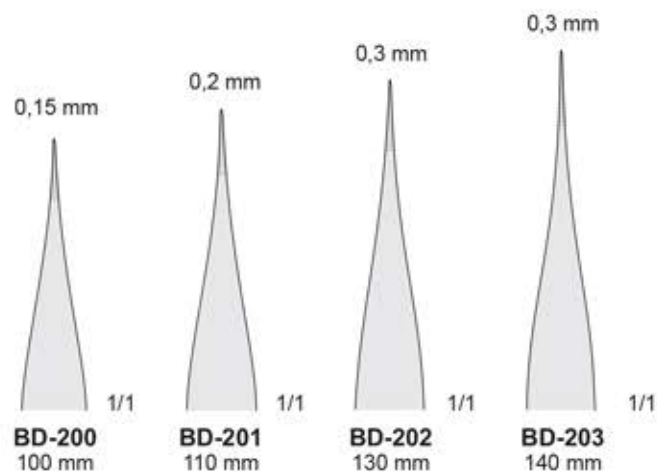

BD-200
100 mm

BD-201
110 mm

BD-202
130 mm

BD-203
140 mm



BD-205
115 mm



BD-206
115 mm

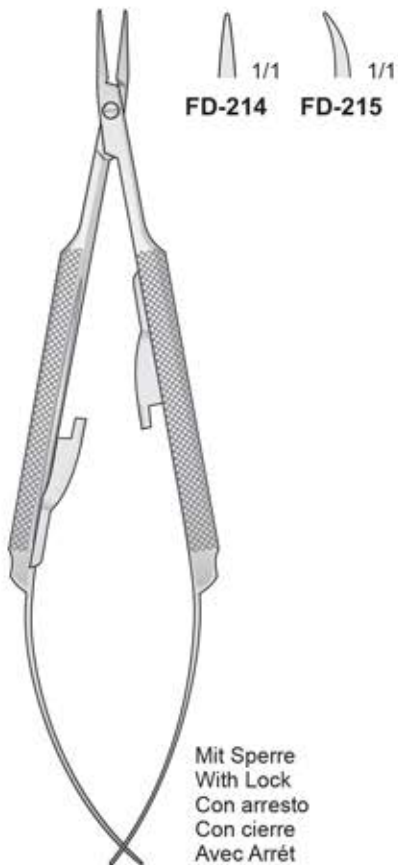

BARRAQUER
FD-214/FD-215
125 mm

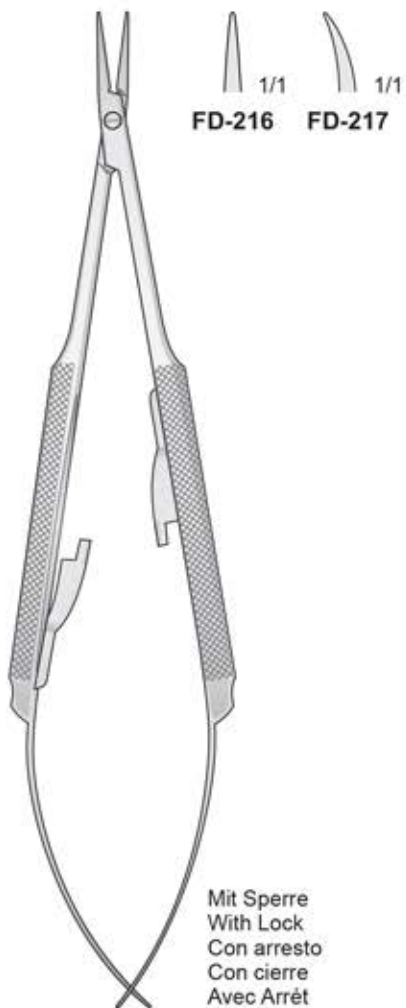

BARRAQUER
FD-216/FD-217
150 mm

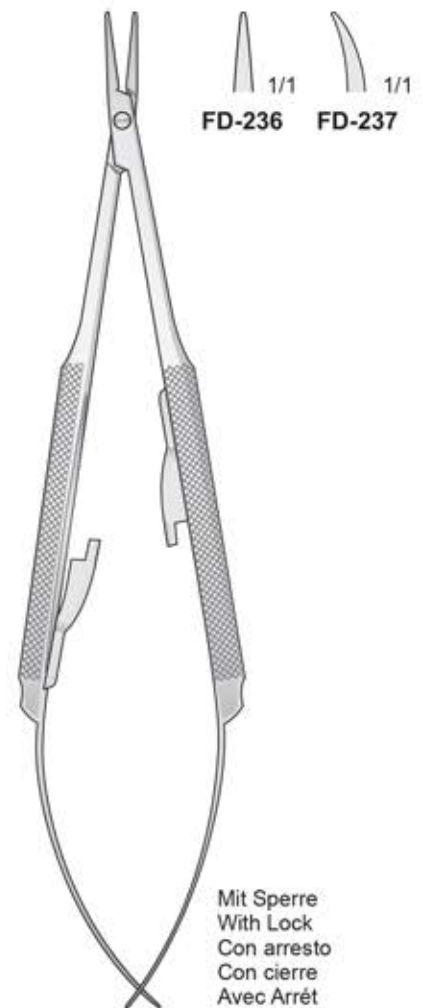

BARRAQUER
FD-236/FD-237
150 mm

Glattes Maul
Smooth jaws
Con morso liscio
Mandibula lisa
À mors lisses

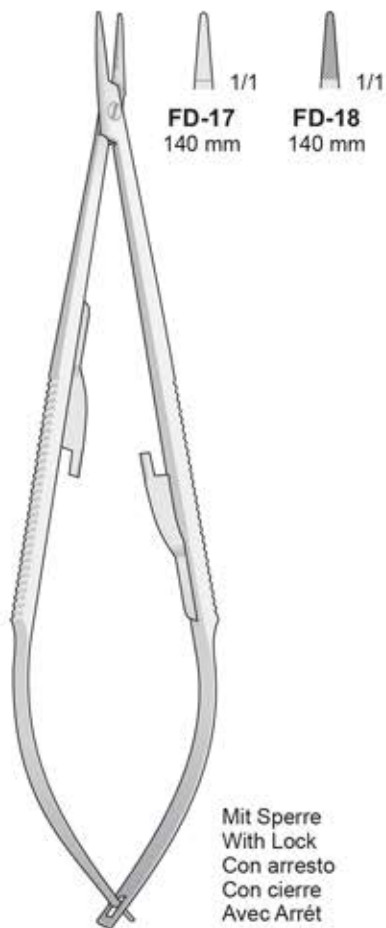

CASTROVIEJO
FD-17/FD-18
140 mm

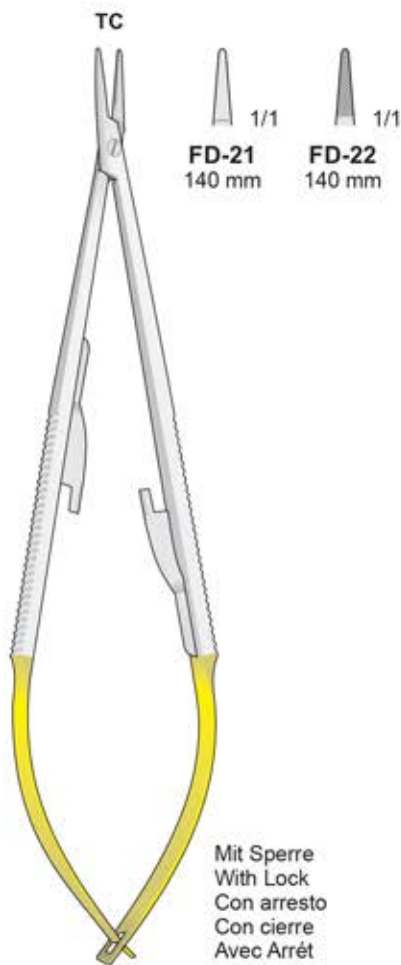

CASTROVIEJO
FD-21/FD-22
140 mm

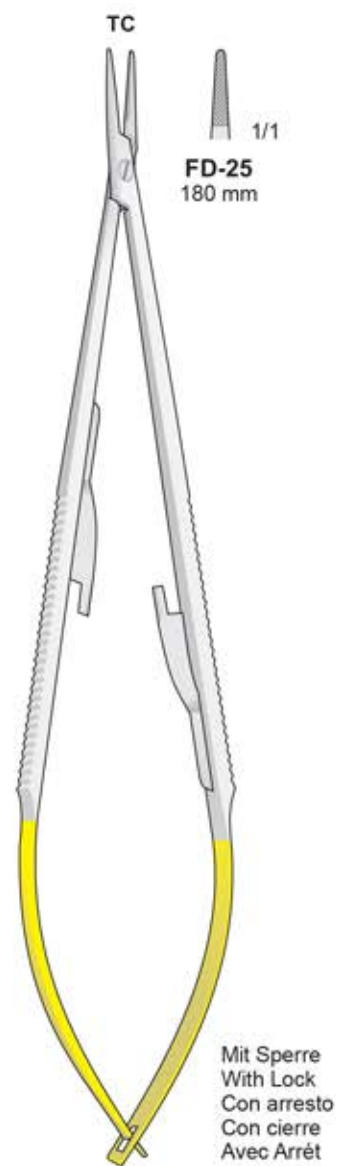

CASTROVIEJO
FD-25
180 mm

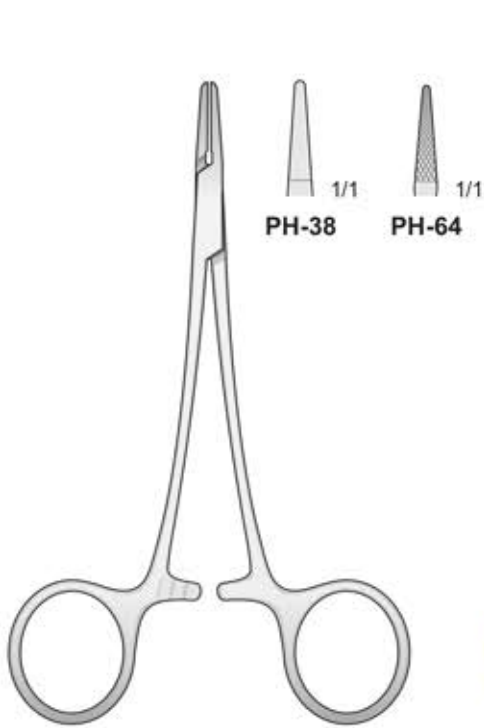

PH-38/PH-64
120 mm

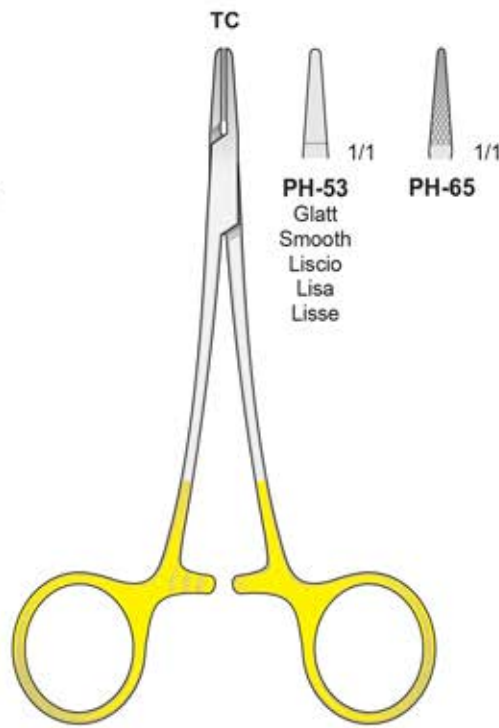

PH-53/PH-65
120 mm

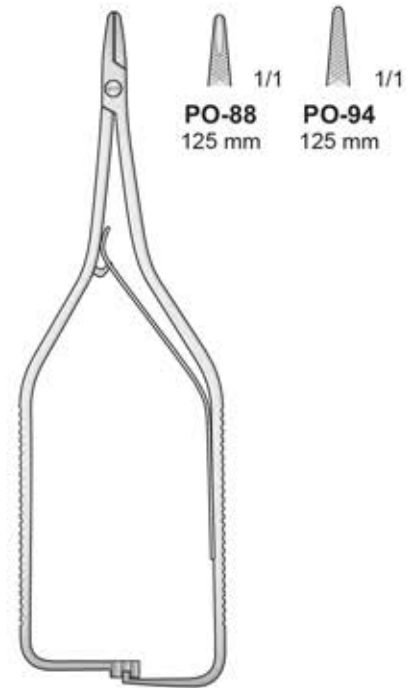

BOYNTON
PO-88/PO-94
125 mm

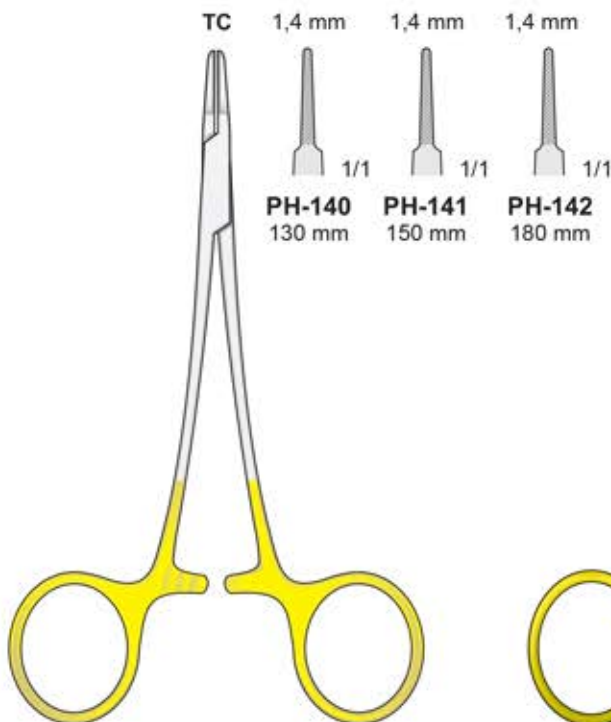

MICRO-RYDER
PH-140/PH-142

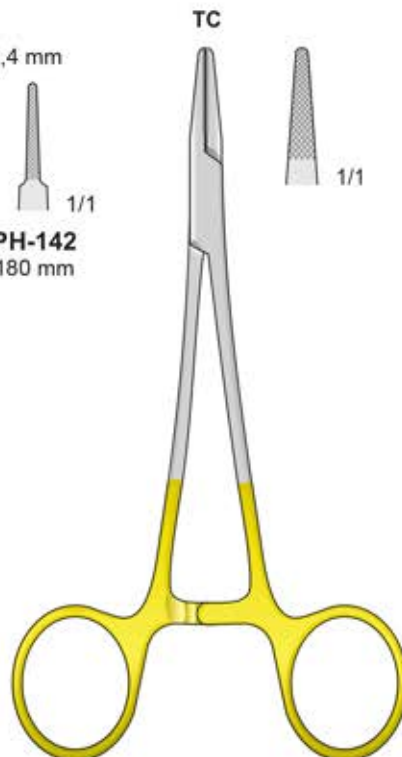

HALSEY
PH-73
130 mm

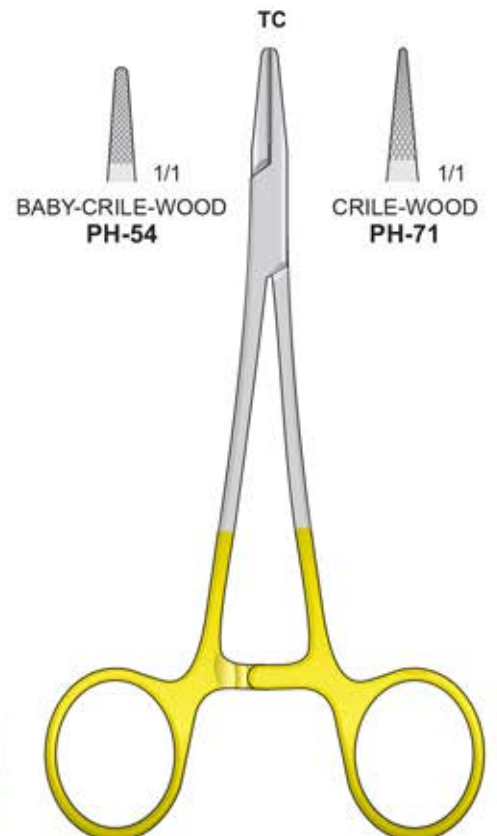

CRILE-WOOD
PH-54/PH-71
150 mm

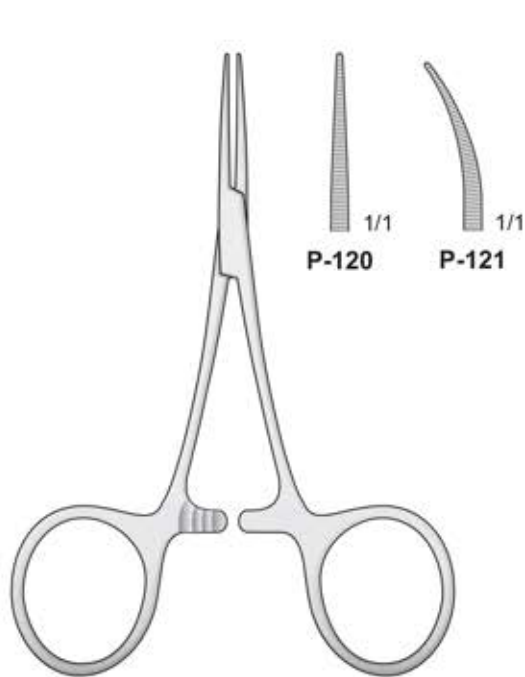

HARTMANN-BABY-MOSQUITO
P-120/P-121
95 mm

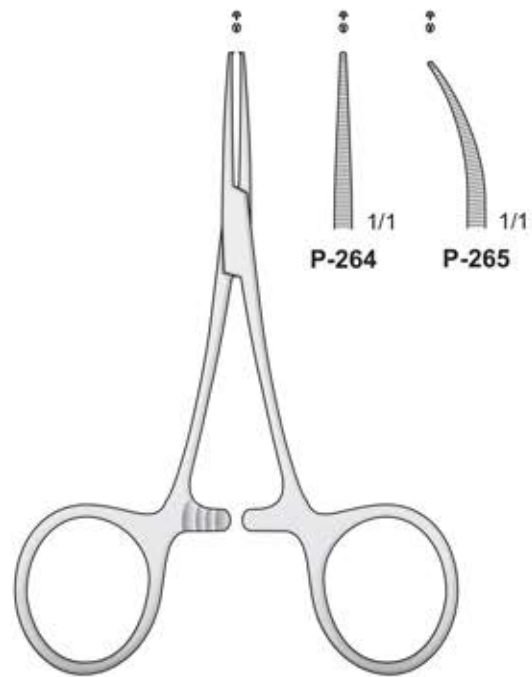

HARTMANN-BABY-MOSQUITO
P-264/P-265
95 mm

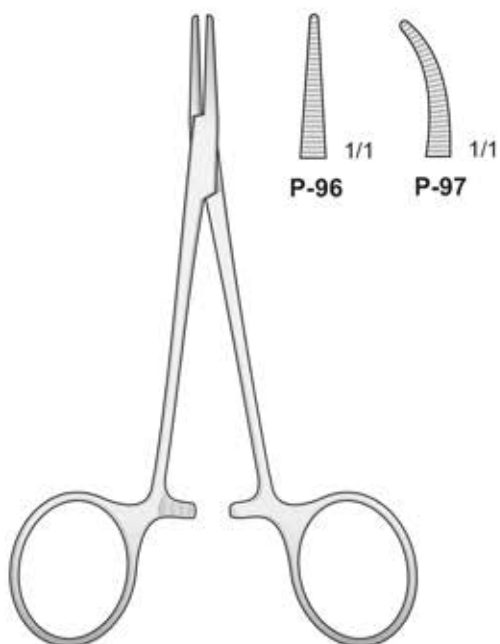

HALSTED-MOSQUITO
P-96/P-97
120 mm

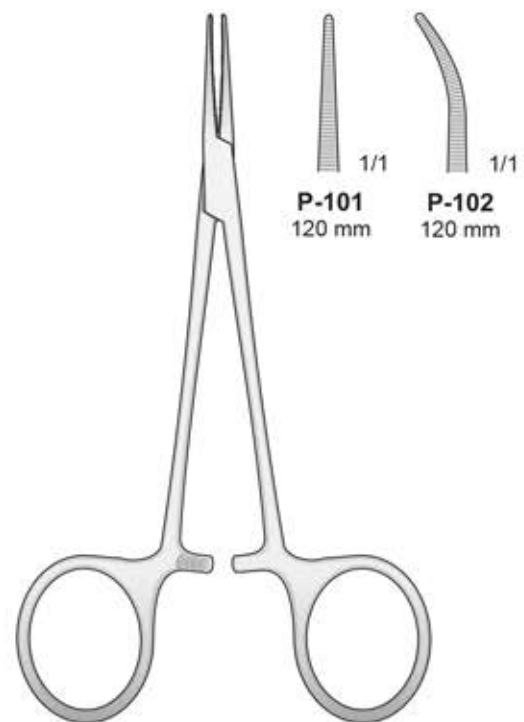

MICRO-HALSTED
P-101/P-102
120 mm

4 x 5 Zähne
 4 x 5 Teeth
 4 x 5 Denti
 4 x 5 Dientes
 4 x 5 Dents

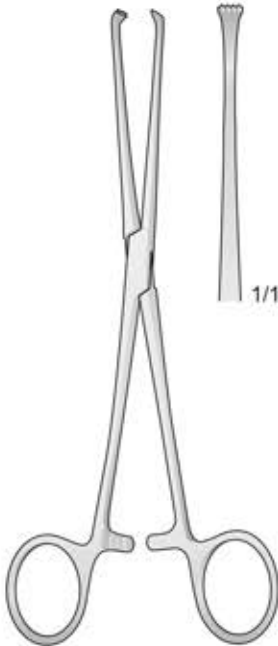

BABY-ALLIS
P-100
 130 mm

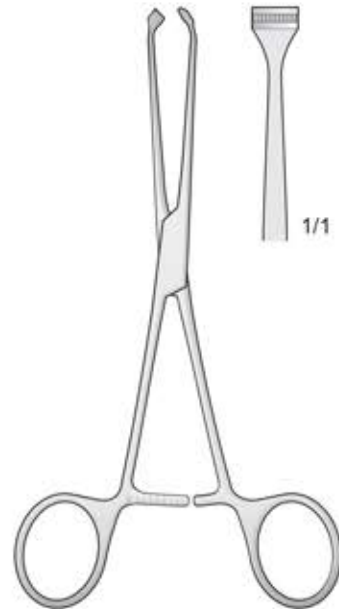

ALLIS
P-52
 150 mm

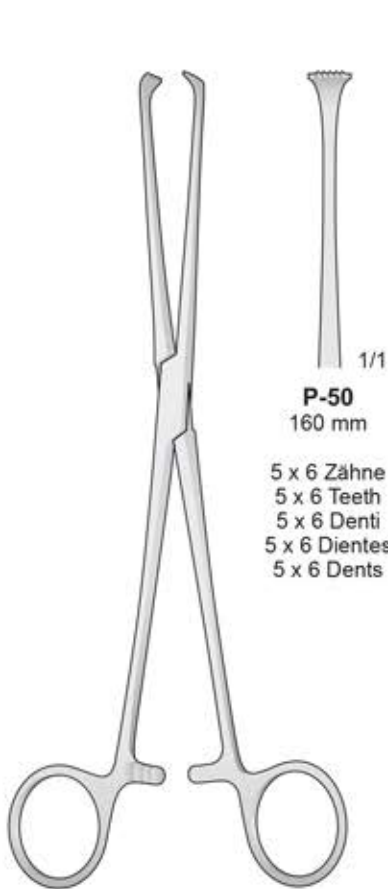

ALLIS
P-50/P-133

5 x 6 Zähne
 5 x 6 Teeth
 5 x 6 Denti
 5 x 6 Dientes
 5 x 6 Dents

P-50
 160 mm



P-132
 150 mm



P-133
 150 mm

2 x 3 Zähne
 2 x 3 Teeth
 2 x 3 Denti
 2 x 3 Dientes
 2 x 3 Dents

3 x 4 Zähne
 3 x 4 Teeth
 3 x 4 Denti
 3 x 4 Dientes
 3 x 4 Dents

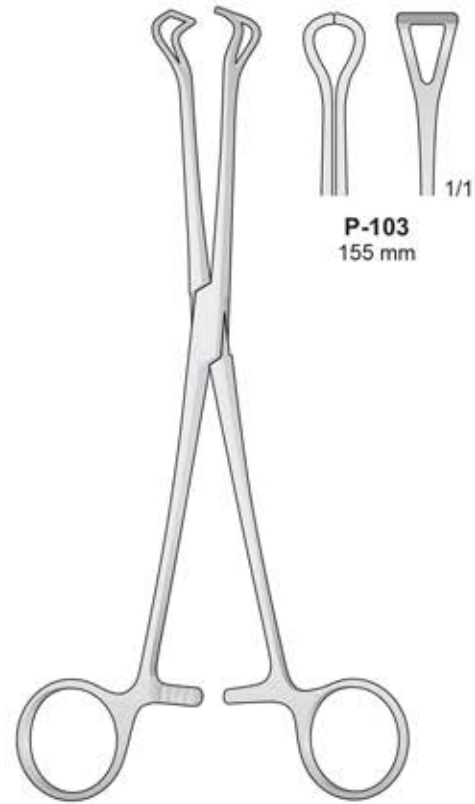

BABCOCK
P-103

P-103
 155 mm

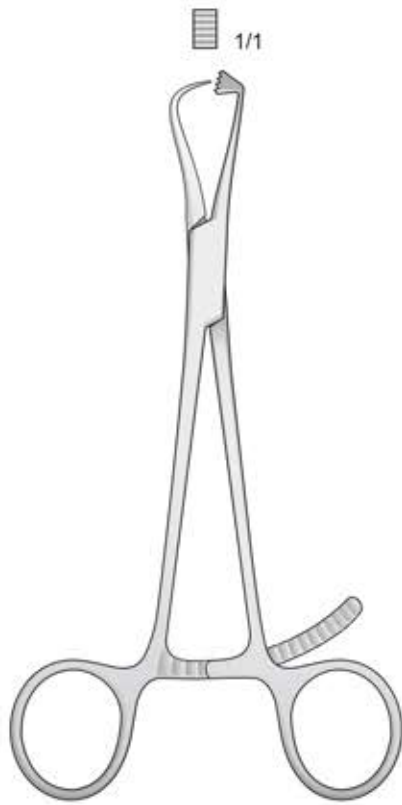

LS-78L
125 mm

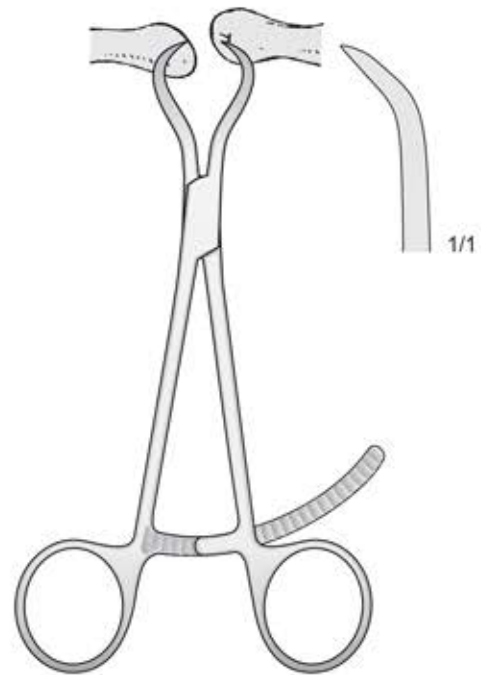

FO-66L
135 mm

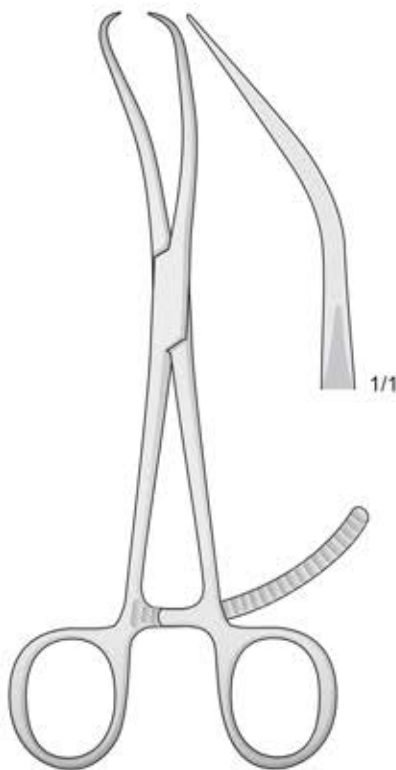

REILL
FO-64L
170 mm

Pinza con cremagliera
Forceps with ratchet fixation
Zange mit Zahnsperre
Davier à crémaillère



FO-47L
140 mm

Alphanumerical Index
Alphanumerischen Index
Index alphanumérique
Índice alfanumérico
Indice alfanumerico



Alphanumerischen Index

Alphanumerical Index

Indice alfanumerico

Indice alfanumérico

Index alphanumérique

AN-10	204	BT-103	4	BV-24	21	BV-206	179	BV-327	174	FF-84	198
AN-11	204	BT-104	4	BV-25	21	BV-207	179	BV-328	174	FF-85	198
AN-12	204	BT-105	4	BV-26	19	BV-208	179	BV-329	174	FF-86	198
AN-13	204	BT-106	4	BV-27	24	BV-209	180	BV-330	174	FF-87	198
AN-14	204	BT-107	4	BV-28	24	BV-210	180	BV-401	171	FF-88	198
AN-15	204	BT-108	4	BV-35	175	BV-211	180	BV-402	171	FF-90	201
AN-16	204	BT-110	10	BV-55	20	BV-212	180	BV-403	171	FF-91	201
AN-17	204	BT-111	10	BV-56	20	BV-213	180	BV-404	171	FF-92	201
BB-38	206	BT-112	10	BV-68	26	BV-214	180	BV-405	171	FF-102	199
BB-40	206	BT-120	7	BV-69	26	BV-215	180	BV-406	171	FF-103	199
BB-46	206	BT-121	7	BV-70	26	BV-216	180	DB-177	192	FF-104	199
BB-48	206	BT-122	7	BV-71	26	BV-229	178	DB-178	192	FF-105	199
BB-50	206	BT-123	7	BV-72	26	BV-249	177	DB-179	192	FF-106	199
BB-52	206	BT-124	6	BV-73	26	BV-250	177	DB-180	192	FF-107	199
BD-30	216	BT-125	6	BV-74	26	BV-251	177	DB-181	192	FF-108	199
BD-31	216	BT-126	3	BV-75	26	BV-252	177	DB-182	192	FF-109	199
BD-60	217	BT-127	3	BV-76	23	BV-253	177	DB-183	192	FF-110	199
BD-62	217	BT-128	3	BV-77	23	BV-254	177	DO-1	45	FF-111	199
BD-64	217	BT-131	13	BV-78	23	BV-255	177	DO-2	45	FF-120	200
BD-66	217	BT-134	11	BV-79	23	BV-256	177	DO-3	45	FF-121	200
BD-68	217	BT-135	11	BV-80	183	BV-257	177	DO-30	155	FF-122	200
BD-70	216	BT-136	13	BV-82	183	BV-258	177	DO-31	155	FF-123	200
BD-71	216	BT-137	11	BV-84	183	BV-259	177	DO-32	155	FF-124	200
BD-72	216	BT-139	3	BV-85	183	BV-260	177	DO-44	155	FF-125	200
BD-73	216	BT-140	3	BV-86	183	BV-269	177	DO-49	155	FF-126	200
BD-90	216	BT-141	5	BV-90	22	BV-270	177	DO-56	188	FF-127	200
BD-92	216	BT-142	5	BV-91	22	BV-271	177	DO-57	188	FF-128	200
BD-177	216	BT-143	5	BV-92	22	BV-272	177	DO-58	188	FF-129	200
BD-178	216	BT-144	5	BV-93	22	BV-273	177	DO-79	46	FF-130	200
BD-200	217	BT-145	5	BV-100	17	BV-274	177	DO-80	46	FF-131	200
BD-201	217	BT-146	5	BV-103	17	BV-275	177	DO-81	46	FF-132	200
BD-202	217	BT-147	5	BV-108	18	BV-276	177	DO-82	46	FF-133	200
BD-203	217	BT-148	5	BV-109	18	BV-277	177	DO-83	46	FF-134	200
BD-205	217	BT-180	14	BV-110	23	BV-279	177	DO-168	47	FF-135	200
BD-206	217	BT-181	14	BV-111	19	BV-280	177	DO-169	47	FF-136	200
BF-07	209	BT-182	14	BV-112	19	BV-281T	178	DO-174	188	FF-137	200
BF-08	209	BT-246	15	BV-117	23	BV-282T	178	DO-190	77	FF-138	200
BF-38	209	BT-247	15	BV-118	23	BV-283T	178	DO-191	77	FF-139	200
BF-40	209	BT-248	15	BV-119	24	BV-284T	178	DO-192	77	FF-140	200
BF-41	209	BT-249	15	BV-120	24	BV-285T	178	DO-193	77	FF-141	200
BF-42	209	BT-250	10	BV-121	172	BV-286T	178	DO-194	77	FF-142	200
BF-44	209	BT-251	10	BV-122	172	BV-287T	178	DO-195	77	FF-143	200
BF-46	209	BT-252	10	BV-123	173	BV-288T	178	DO-196	77	FF-144	200
BF-94	209	BT-253	10	BV-124	173	BV-289T	178	DO-197	77	FF-145	200
BF-95	209	BT-254	10	BV-160	175	BV-290T	178	DO-213	188	FF-146	200
BK-30	168	BT-260	9	BV-161	175	BV-291T	178	DO-214	188	FF-147	69
BM-09	153	BT-261	9	BV-163	176	BV-292T	178	DO-215	188	FF-148	69
BM-10	153	BT-262	9	BV-164	176	BV-293T	178	DO-270	184	FF-149	69
BM-11	153	BT-263	9	BV-165	176	BV-294T	178	DO-271	184	FF-190	181
BM-12	153	BT-270	12, 15	BV-166	176	BV-295T	178	DO-272	184	FF-191	181
BM-13	153	BT-271	12, 15	BV-167	176	BV-296T	178	DO-273	184	FF-192	181
BM-14	153	BT-272	12, 15	BV-168	176	BV-297T	178	DO-279	184	FF-200	181
BM-50	154	BT-300	185	BV-169	176	BV-298T	178	DO-280	184	FF-201	181
BM-51	154	BT-301	185	BV-170	176	BV-299T	178	DO-281	184	FF-202	181
BM-68	154	BT-302	185	BV-171	176	BV-300T	178	DO-282	184	FF-203	181, 182
BM-69	154	BT-303	185	BV-172	176	BV-301T	178	DP-09	99	FF-204	182
BM-74	154	BT-375	12	BV-173	176	BV-302T	178	DP-90	159	FF-205	181, 182
BT-23	6	BT-376	12	BV-174	176	BV-303T	178	DP-96	156	FF-206	181, 182
BT-24	6	BT-377	12	BV-175	176	BV-304T	178	DP-120	159	FF-301	186
BT-33	8	BT-378	12	BV-176	176	BV-305T	178	DP-725	148	FF-302	186
BT-34	8	BT-379	12	BV-177	176	BV-306T	178	FD-17	219	FF-303	186
BT-35	8	BV-07	19	BV-178	176	BV-307T	178	FD-18	219	FF-304	186
BT-36	8	BV-09	19	BV-179	176	BV-308T	178	FD-21	219	FF-305	186
BT-43	8	BV-11	18	BV-180	176	BV-309T	178	FD-22	219	FF-306	186
BT-60	9	BV-13	18	BV-181	176	BV-310T	178	FD-25	219	FF-307	186
BT-62	9	BV-14	16	BV-182	176	BV-315	17	FD-214	218	FF-308	186
BT-64	9	BV-15	16	BV-190	25	BV-316	17	FD-215	218	FF-309	187
BT-65	9	BV-16	16	BV-191	25	BV-319	174	FD-216	218	FF-310	187
BT-66	9	BV-17	16	BV-192	25	BV-320	174	FD-217	218	FF-311	187
BT-69	8	BV-18	20	BV-193	25	BV-321	174	FD-236	218	FF-312	187
BT-80	14	BV-19	21	BV-201	179	BV-322	174	FD-237	218	FF-313	187
BT-81	14	BV-20	20	BV-202	179	BV-323	174	FF-80	198	FF-314	187
BT-82	14	BV-21	21	BV-203	179	BV-324	174	FF-81	198	FF-394	202
BT-101	4	BV-22	20	BV-204	179	BV-325	174	FF-82	198	FF-395	202
BT-102	4	BV-23	21	BV-205	179	BV-326	174	FF-83	198	FF-396	202

FF-397	202	FK-67	53	FK-161	55	FK-281	57	FL-36	75	FL-176	76
FF-398	202	FK-68	53	FK-162	55	FK-282	57	FL-40	71	FL-177	72
FF-399	202	FK-69	53	FK-163	55	FK-283	57	FL-41	75	FL-178	76
FG-1	211	FK-70	49	FK-164	36	FK-284	57	FL-42	75	FL-179	72
FG-1TC	213	FK-71	49	FK-168	36	FK-285	57	FL-43	75	FL-180	76
FG-2	211	FK-72	50	FK-169	36	FK-286	57	FL-44	75	FL-181	72
FG-2TC	213	FK-73	50	FK-170	55	FK-287	57	FL-45	75	FL-182	76
FG-3	211	FK-74	50	FK-171	55	FK-288	57	FL-46	75	FL-183	72
FG-4	211	FK-75	49	FK-172	55	FK-289	57	FL-47	75	FL-184	72
FG-6C	212	FK-76	49	FK-173	55	FK-290	57	FL-48	75	FL-185	72
FG-13	211	FK-77	49	FK-176	35	FK-291	58	FL-49	75	FL-186	72
FG-14	211	FK-78	49	FK-177	50	FK-292	58	FL-53	74	FL-187	72
FG-15	211	FK-79	50	FK-178	50	FK-293	58	FL-54	74	FL-188	72
FG-19C	212	FK-80	39	FK-179	35	FK-294	58	FL-58	74	FL-189	72
FG-19R	212	FK-81	34	FK-180	55	FK-295	58	FL-59	77	FL-190	81
FG-28	211	FK-82	39	FK-181	55	FK-296	58	FL-60	77	FL-191	81
FG-40	114	FK-83	49	FK-182	55	FK-297	58	FL-61	77	FL-192	81
FG-50	212	FK-84	49	FK-183	55	FK-298	58	FL-62	77	FL-193	81
FG-51	212	FK-85	48	FK-188	51	FK-299	58	FL-63	78	FL-194	81
FG-52	212	FK-86	48	FK-189	51	FK-300	58	FL-64	78	FL-198	61
FG-53	212	FK-90	155	FK-190	55	FK-301	58	FL-81	78	FL-206	73
FG-54	212	FK-91	155	FK-191	55	FK-302	58	FL-82	78	FL-207	73
FG-55	212	FK-92	155	FK-192	55	FK-303	58	FL-83	78	FL-208	73
FG-153	213	FK-93	35	FK-193	45	FK-304	58	FL-84	85	FL-209	73
FG-154	213	FK-94	47	FK-194	45	FK-305	58	FL-85	85	FL-210	82
FG-200	210	FK-95	47	FK-195	45	FK-306	58	FL-86	85	FL-211	82
FG-201	210	FK-110	52	FK-196	45	FK-307	58	FL-87	85	FL-212	82
FG-202	210	FK-111	52	FK-197	54	FK-308	58	FL-88	85	FL-213	82
FG-203	210	FK-112	52	FK-198	54	FK-310	59	FL-89	85	FL-214	82
FG-204	210	FK-113	52	FK-200	62	FK-311	59	FL-91	78	FL-215	82
FG-205	210	FK-114	52	FK-201	61	FK-312	59	FL-92	78	FL-216	82
FG-206	210	FK-115	52	FK-202	61	FK-313	59	FL-93	78	FL-220	82
FG-207	210	FK-116	52	FK-203	61	FK-314	59	FL-94	75	FL-221	82
FG-208	210	FK-117	31	FK-204	61	FK-315	59	FL-95	75	FL-222	82
FK-01	53	FK-118	31	FK-205	62	FK-316	59	FL-96	75	FL-223	82
FK-02	53	FK-119	48	FK-206	62	FK-317	59	FL-97	75	FL-224	82
FK-03	53	FK-120	52	FK-207	62	FK-318	60	FL-98	75	FL-225	82
FK-04	53	FK-121	52	FK-208	62	FK-319	60	FL-99	75	FL-226	82
FK-05	53	FK-122	52	FK-211	61	FK-320	60	FL-100	78	FL-230	81
FK-06	53	FK-123	52	FK-212	61	FK-321	60	FL-101	78	FL-231	81
FK-07	53	FK-124	52	FK-213	61	FK-322	60	FL-102	78	FL-232	81
FK-08	53	FK-125	52	FK-221	61	FK-323	60	FL-103	78	FL-233	81
FK-09	123	FK-126	52	FK-222	61	FK-324	60	FL-104	66	FL-234	81
FK-11	205	FK-127	31	FK-223	61	FK-325	60	FL-105	66	FL-240	81
FK-12	29	FK-128	31	FK-230	42	FL-01	65	FL-106	66	FL-241	81
FK-13	205	FK-130	54	FK-232	42	FL-02	65	FL-107	67	FL-242	81
FK-14	205	FK-131	54	FK-234	42	FL-03	71	FL-108	67	FL-243	81
FK-15	41	FK-132	54	FK-236	43	FL-04	71	FL-109	67	FL-244	81
FK-16	41	FK-133	37	FK-238	43	FL-05	71	FL-110	78	FL-250	84
FK-17	41	FK-134	38	FK-240	43	FL-06	68	FL-111	68	FL-251	84
FK-20	30	FK-135	37	FK-243	205	FL-09	65	FL-112	67	FL-252	84
FK-27	30	FK-136	51	FK-244	205	FL-09R	65	FL-113	68	FL-253	69
FK-28	30	FK-137	51	FK-247	40	FL-10M	65	FL-114	71	FL-254	69
FK-30	30	FK-138	51	FK-248	40	FL-11	65	FL-115	71	FL-255	69
FK-45	30	FK-139	51	FK-249	40	FL-11R	65	FL-116	71	FL-256	69
FK-46	30	FK-140	56	FK-250	40	FL-12	65	FL-117	78	FL-257	69
FK-47	36	FK-141	56	FK-251	40	FL-12R	65	FL-118	71	FL-258	69
FK-48	30	FK-142	56	FK-252	39	FL-13	71	FL-119	78	FL-259	69
FK-49	30	FK-143	56	FK-254	40	FL-14	71	FL-126	71	FL-260	84
FK-51	32	FK-144	56	FK-255	40	FL-15	71	FL-127	71	FL-261	84
FK-52	32	FK-145	56	FK-256	40	FL-16	74	FL-132	71	FL-262	84
FK-53	32	FK-147	56	FK-257	40	FL-17	74	FL-135	71	FL-263	74
FK-54	33	FK-148	56	FK-258	40	FL-18	74	FL-136	71	FL-264	74
FK-55	33	FK-149	56	FK-259	41	FL-20	70	FL-138	71	FL-265	74
FK-56	35	FK-150	56	FK-260	39	FL-21	70	FL-147	41	FL-266	74
FK-57	36	FK-151	56	FK-261	39	FL-22	70	FL-148	41	FL-267	74
FK-58	34	FK-152	56	FK-262	39	FL-23	71	FL-149	41	FL-268	74
FK-59	34	FK-153	56	FK-263	39	FL-24	71	FL-160	76	FL-269	74
FK-60	53	FK-154	56	FK-264	39	FL-29	75	FL-162	76	FL-270	84
FK-61	53	FK-155	56	FK-265	39	FL-30	70	FL-164	76	FL-272	82
FK-62	53	FK-156	44	FK-266	80	FL-31	70	FL-166	76	FL-280	83
FK-63	53	FK-157	44	FK-267	80	FL-32	74	FL-168	76	FL-281	83
FK-64	53	FK-158	44	FK-268	80	FL-33	70	FL-170	76	FL-282	83
FK-65	53	FK-159	44	FK-269	80	FL-34	75	FL-172	76	FL-283	83
FK-66	53	FK-160	55	FK-280	57	FL-35	70	FL-174	76	FL-284	83

FL-285	83	FO-37	103	FO-114	97	FO-223	195	KI-47	117	KI-204	138
FL-286	85	FO-38	109	FO-115	97	FO-224	195	KI-48	117	KI-205	138
FL-287	85	FO-39	103	FO-116	97	FO-225	195	KI-49	117	KI-206	138
FL-288	85	FO-40	113	FO-117	193	FO-231	104	KI-50	120	KI-207	138
FL-289	85	FO-41	112	FO-118	193	FO-232	104	KI-51	120	KI-208	138
FL-307	80	FO-42	112	FO-119	193	FO-233	104	KI-52	120	KI-209	138
FL-308	80	FO-43	102	FO-120	193	FO-234	104	KI-53	120	KI-210	138
FL-309	80	FO-44	95	FO-121	193	FO-236	97	KI-54	120	KI-211	138
FL-310	80	FO-45	103	FO-122	193	FO-237	97	KI-55	120	KI-212	138
FL-311	80	FO-46	91	FO-123	193	FO-240	91	KI-56	120	KI-220	119
FL-312	80	FO-47	91	FO-124	193	FO-241	91	KI-57	120	KI-221	119
FL-340	79	FO-47L	223	FO-125	195	FO-242	91	KI-58	120	KI-222	119
FL-341	79	FO-48	91	FO-126	195	FO-299	99	KI-60	118	KI-223	119
FL-342	79	FO-49	91	FO-127	195	FO-300	99	KI-61	118	KI-224	119
FL-343	79	FO-50	95	FO-128	195	FR-20	135	KI-62	118	KI-225	119
FL-344	79	FO-51	95	FO-129	195	FR-23	135	KI-63	118	KI-226	119
FL-345	79	FO-52	95	FO-130	89	FR-24	135	KI-64	118	KI-227	119
FL-346	79	FO-53	95	FO-131	89	FR-25	135	KI-65	118	KI-228	119
FL-347	79	FO-54	95	FO-133	89	FR-26	135	KI-66	118	KI-229	119
FL-348	79	FO-55	92	FO-134	89	FR-27	135	KI-67	118	KI-230	121
FL-349	79	FO-56	92	FO-135	107	FR-28	135	KI-68	118	KI-231	121
FL-350	79	FO-57	92	FO-138	105	FR-29	135	KI-69	118	KI-232	121
FL-351	79	FO-58	112	FO-139	105	FR-30	135	KI-70	118	KI-233	119
FL-352	79	FO-59	112	FO-140	109	GF-140	191	KI-71	118	KI-238	121
FL-353	79	FO-60	112	FO-145	107	GF-141	191	KI-72	118	KI-240	121
FL-354	79	FO-61	112	FO-147	104	GF-141B	191	KI-74	118	KI-242	121
FL-355	79	FO-62	94	FO-148	107	GF-142	191	KI-75	118	KI-244	121
FL-356	79	FO-63	114	FO-149	104	GF-142B	191	KI-76	118	KI-246	121
FL-357	79	FO-64	90	FO-156	105	GF-143	191	KI-77	118	KI-248	121
FL-359	79	FO-64L	223	FO-157	105	GF-144	191	KI-78	118	KI-252	120
FL-360	79	FO-65	93	FO-158	113	GF-150	191	KI-80	118	KI-254	120
FL-361	79	FO-66	90	FO-159	99	GF-151	191	KI-82	118	KI-256	120
FL-362	79	FO-66L	223	FO-160	110	GF-151B	191	KI-85	118	KI-258	120
FL-368	73	FO-67	96	FO-161	110	GF-152	191	KI-90	118	KI-260	120
FM-1	212	FO-68	90	FO-167	105	GF-152B	191	KI-99	117	KI-262	120
FM-2	212	FO-69	96	FO-168	105	GF-153	191	KI-100	117	KI-264	120
FM-46	215	FO-71	93	FO-169	105	GF-154	191	KI-102	117	KI-280	120
FM-48	211	FO-72	93	FO-170	105	GF-240	191	KI-114	117	KI-282	120
FM-51	215	FO-73	93	FO-171	196	GF-241	191	KI-115	117	KI-284	120
FM-59	215	FO-74	93	FO-172	196	GF-242	191	KI-116	117	KI-286	120
FM-66	214	FO-75	93	FO-173	196	GF-242B	191	KI-117	117	KI-288	120
FM-67	214	FO-76	95	FO-174	196	GF-243	191	KI-118	117	KI-290	120
FM-96	214	FO-78	96	FO-175	196	GF-244	191	KI-120	117	KI-293	121
FM-98	214	FO-79	90	FO-176	107	GF-252	191	KI-122	117	KI-294	121
FM-100	213	FO-80	99	FO-178	112	GFC-TC	213	KI-125	117	KI-295	121
FM-118	214	FO-81	90	FO-180	197	KI-00	117	KI-130	117	KI-296	121
FM-119	214	FO-82	94	FO-181	197	KI-01	117	KI-160	120	KI-297	121
FM-149	215	FO-84	94	FO-182	197	KI-02	117	KI-161	120	KI-298	121
FM-350	214	FO-85	100	FO-183	197	KI-10	145	KI-175	122	KI-300	122
FO-10	102	FO-87	100	FO-184	197	KI-14	117	KI-176	122	KI-301	122
FO-11	103	FO-88	100	FO-185	197	KI-15	117	KI-177	122	KI-306	123
FO-12	103	FO-89	100	FO-186	197	KI-16	117	KI-178	122	KI-307	123
FO-13	103	FO-90	98	FO-187	197	KI-17	117	KI-179	122	KI-308	123
FO-14	103	FO-91	98	FO-188	197	KI-18	117	KI-180	122	KI-322	138
FO-15	101	FO-92	98	FO-189	197	KI-20	117	KI-181	122	KI-330	121
FO-16	101	FO-93	96	FO-191	108	KI-22	117	KI-182	122	KI-331	121
FO-17	101	FO-94	96	FO-193	108	KI-25	117	KI-183	122	KI-332	121
FO-18	101	FO-96	98	FO-194	108	KI-29	118	KI-184	122	KI-333	121
FO-19	101	FO-97	98	FO-195	108	KI-30	117	KI-185	122	KI-334	121
FO-20	106	FO-98	98	FO-196	108	KI-31	118	KI-186	122	KI-335	121
FO-21	101	FO-99	98	FO-197	108	KI-32	118	KI-187	122	KI-336	121
FO-22	100	FO-100	193	FO-198	108	KI-33	118	KI-188	122	KO-1	29
FO-23	100	FO-101	193	FO-199	109	KI-34	118	KI-189	122	KO-2	29
FO-24	100	FO-102	193	FO-200	110	KI-35	118	KI-190	122	LB-361	206
FO-25	102	FO-103	193	FO-201	194	KI-36	118	KI-191	122	LB-362	206
FO-27	102	FO-104	193	FO-202	194	KI-37	118	KI-192	122	LB-363	206
FO-28	106	FO-105	94	FO-203	194	KI-38	118	KI-193	122	LB-364	206
FO-29	106	FO-106	96	FO-204	194	KI-39	118	KI-194	122	LB-365	206
FO-30	106	FO-107	104	FO-205	194	KI-40	117	KI-195	122	LB-366	206
FO-31	106	FO-108	112	FO-212	194	KI-41	117	KI-196	122	LB-367	206
FO-32	106	FO-109	104	FO-213	194	KI-42	117	KI-197	122	LB-368	206
FO-33	102	FO-110	97	FO-215	194	KI-43	117	KI-198	122	LB-369	206
FO-34	106	FO-111	98	FO-217	89	KI-44	117	KI-199	122	LS-06	145
FO-35	106	FO-112	97	FO-220	100	KI-45	117	KI-202	138	LS-07	145
FO-36	109	FO-113	98	FO-222	195	KI-46	117	KI-203	138	LS-08	145



Alphanumerischen Index

Alphanumerical Index

Indice alfanumerico

Índice alfanumérico

Index alphanumérique

LS-09	145	LS-115	142	LS-381	124	OR-12	146
LS-10	126	LS-116	141	LS-382	124	OR-13	148
LS-11	126	LS-117	141	LS-383	124	OR-14	146
LS-12	126	LS-119	141	LS-384	124	OR-15	148
LS-13	126	LS-120	131	LS-385	125	OR-16	147
LS-14	126	LS-121	141	LS-386	125	OR-17	148
LS-15	126	LS-122	152	LS-387	125	OR-18	147
LS-16	126	LS-123	152	LS-388	125	OR-19	148
LS-17	126	LS-124	141	LS-389	125	P-50	222
LS-20	127	LS-125	130	LS-390	125	P-52	222
LS-21	127	LS-126	130	LS-391	125	P-96	221
LS-22	127	LS-127	130	LS-392	125	P-97	221
LS-23	127	LS-128	138	LS-393	125	P-100	222
LS-24	127	LS-135	130	LS-394	125	P-101	221
LS-25	127	LS-136	130	LS-400	151	P-102	221
LS-26	127	LS-137	130	LS-405	151	P-103	222
LS-27	127	LS-138	130	LS-406	151	P-120	221
LS-28	127	LS-139	130	LS-407	160	P-121	221
LS-29	127	LS-140	130	LS-408	160	P-132	222
LS-30	127	LS-199	145	LS-409	160	P-133	222
LS-32	126	LS-200	145	LS-410	151	P-264	221
LS-33	126	LS-201	145	LX-80	158	P-265	221
LS-40	128	LS-202	145	LX-82	162	PH-38	220
LS-41	128	LS-222	134	LX-92TC	162	PH-53	220
LS-42	128	LS-224	134	LX-95TC	162	PH-54	220
LS-43	128	LS-227	132	LX-96TC	162	PH-55	161
LS-44	128	LS-228	132	LX-99	162	PH-56	161
LS-45	128	LS-229	132	LX-101	163	PH-57	161
LS-46	128	LS-230	134	LX-102	163	PH-58	161
LS-47	128	LS-231	134, 136	LX-103	163	PH-64	220
LS-48	128	LS-232	134	LX-104	164	PH-65	220
LS-49	128	LS-233	132	LX-105	164	PH-71	220
LS-50	128	LS-234	134	LX-106	164	PH-73	220
LS-51	129	LS-235	136	LX-107	165	PH-140	220
LS-52	129	LS-236	132, 133	LX-108	111	PH-141	220
LS-53	129	LS-237	133	LX-109	111	PH-142	220
LS-54	129	LS-238	133	LX-110	111	PO-88	220
LS-55	129	LS-239	133	LX-111	111	PO-94	220
LS-56	129	LS-240	131	LX-113	167	TG-40	70
LS-57	129	LS-241	132, 133	LX-114	167	TG-41	70
LS-58	129	LS-242	131	LX-115	167	TR-76	136
LS-59	129	LS-244	131	LX-116	111	TR-77	136
LS-60	129	LS-300	205	LX-120	168	TR-78	136
LS-73	140	LS-301	205	LX-121	168	VF-98	165
LS-74	140	LS-302	205	LX-122	168	VF-98M	165
LS-75	140	LS-303	205	LX-123	168	VH-20	158
LS-76	152	LS-310	137	LX-125	159	VH-21	158
LS-78	152	LS-311	137	LX-126	166	VH-23	158
LS-78L	223	LS-312	137	LX-130	157	VH-25	158
LS-80	140	LS-313	137	LX-131	157	VH-40	159
LS-81	140	LS-314	137	LX-134	156	WG-10	29
LS-82	140	LS-315	137	LX-135	156	WG-12	29
LS-83	140	LS-316	137	LX-136	156	WG-14	29
LS-84	140	LS-317	137	LX-137	156		
LS-85	140	LS-318	137	LX-138	157		
LS-90	139	LS-320	136	LX-139	157		
LS-91	139	LS-321	136	LX-140	157		
LS-92	139	LS-322	136	LX-141	157		
LS-93	139	LS-323	136	LX-150	166		
LS-94	142	LS-324	136	LX-151	166		
LS-95	142	LS-325	136	NK-1	206		
LS-96	142	LS-326	136	NK-2	206		
LS-97	142	LS-329	136	NK-31	203		
LS-98	142	LS-330	136	NK-33	203		
LS-100	123	LS-370	124	NK-35	203		
LS-101	152	LS-371	124	NK-37	203		
LS-102	152	LS-372	124	NK-50	203		
LS-103	152	LS-373	124	NK-51	203		
LS-104	152	LS-374	124	NK-52	203		
LS-105	152	LS-375	124	NK-53	203		
LS-106	123	LS-376	124	NK-54	203		
LS-110	138	LS-377	124	NK-55	203		
LS-112	142	LS-378	124	NK-56	203		
LS-113	142	LS-379	124	NK-57	203		
LS-114	142	LS-380	124	OR-11	148		





BROMED
INSTRUMENTS