



BROMED
INSTRUMENTS

Das Instrument.

Chirurgische Instrumente Katalog
Ophthalmologie

Catalogue des instruments chirurgicaux
Ophthalmologie

Catálogo de instrumentos quirúrgicos
Oftalmología

Catalogo di strumenti chirurgici
Oftalmologia

Catalogue of Surgical Instruments

Ophthalmology





Specialties

Ophthalmology



BROMMED
INSTRUMENTS

Ophthalmology
Ophthalmologie
Ophtalmologie
Oftalmología
Oftalmologia



BROMED
INSTRUMENTS



BROMMED
INSTRUMENTS

Knives
Messer
Couteaux
Cuchillos
Coltelli

Scalpels
Skalpelle
Bistouris
Bisturías
Bisturi

Curettes
Küretten
Curettes
Curetas
Curettes



BROMED
INSTRUMENTS

Fremdkörpernadel - Foreign Body needle - Lancette per corpi estranei
Cuchillos para cuerpos extraños - Couteaux à corps étrangers

Golf Club

Spatel
Spatulas
Spatole
Espátulas
Spatules

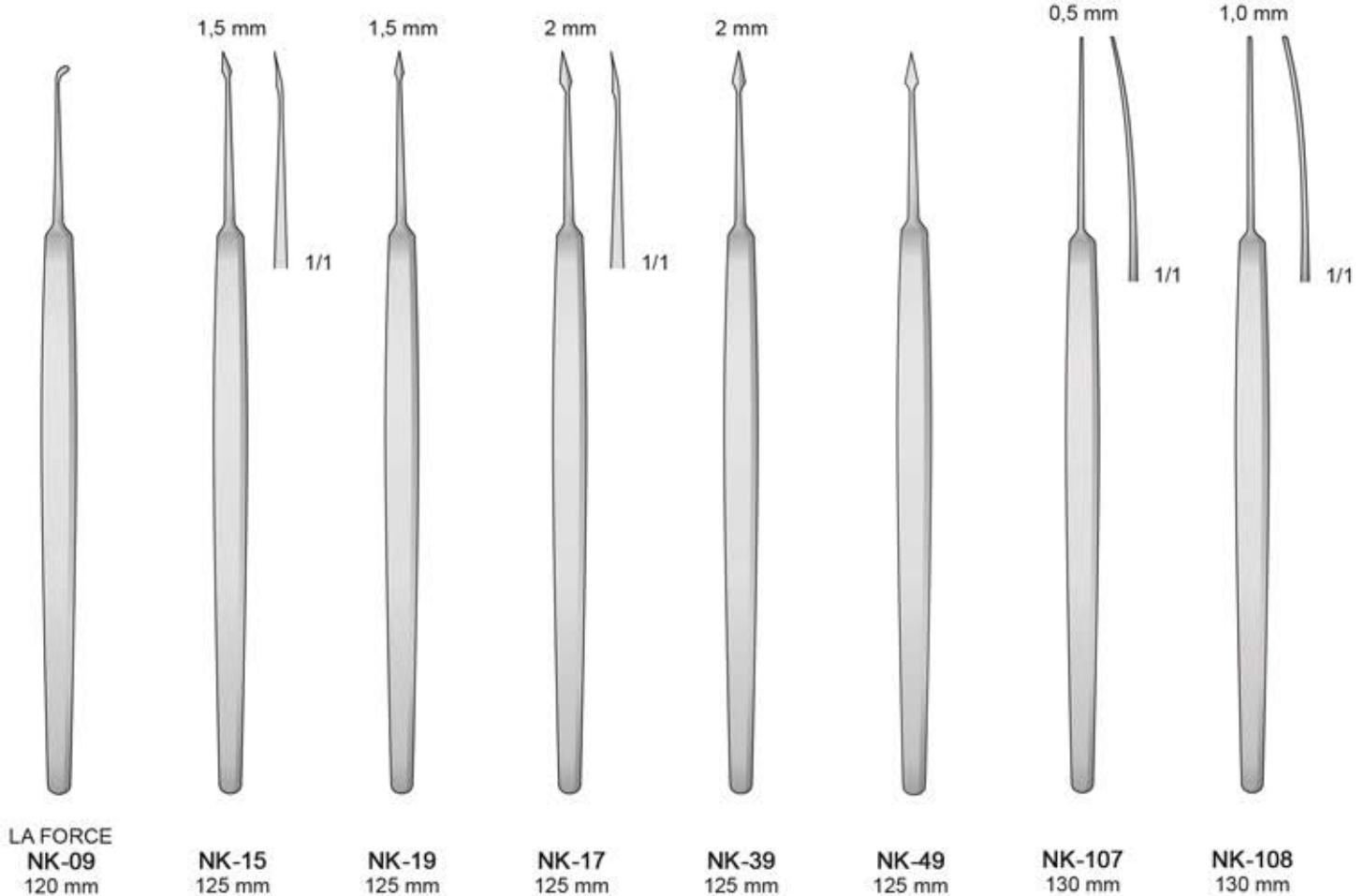

Starmesser
 Cataract Knives
 Coltellini per cataratta
 Cuchillos para cataratas
 Couteaux à cataracte



Gr. 0
 GRAEFE
 NK-147
 35 mm



Gr. 1
 GRAEFE
 NK-148
 35 mm



Gr. 2
 GRAEFE
 NK-149
 35 mm



Gr. 3
 GRAEFE
 NK-150
 35 mm



Gr. 4
 GRAEFE
 NK-18
 35 mm

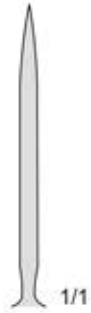

Gr. 5
 GRAEFE
 NK-20
 35 mm



Gr. 1
 ARRUGA
 NK-151



Gr. 2
 ARRUGA
 NK-152



Gr. 3
 ARRUGA
 NK-153

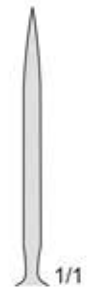

Gr. 4
 ARRUGA
 NK-154



DEUTSCHMANN
 NK-155

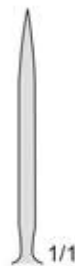

SMITH-GREEN
 NK-156



SMITH-GREEN
 NK-157



WHEELER
 NK-158



NK-18/NK-158
 140 mm



NK-30/NK-40

Fig. 2



1/1

NK-30
120 mm

Fig. 3



1/1

NK-32
125 mm

Fig. 4



1/1

NK-34
130 mm

Fig. 7



1/1

NK-36
120 mm

Fig. 8



1/1

NK-36B
120 mm

Fig. 9



1/1

NK-38
125 mm

Fig. 10



1/1

NK-40
130 mm

Keratome-Lanze
Keratomes
Coltelli lanceolari
Cuchillos lanceolares
Couteaux lancéolaires

Gerade
Straight



NK-159

Gerade
Straight



NK-160

Gerade
Straight



NK-161



Leicht Gebogen



NK-162

Leicht Gebogen



NK-163

Leicht Gebogen



NK-164

Leicht Gebogen

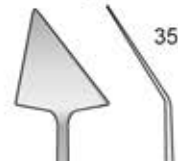

NK-165

Stark Gebogen



NK-166

Stark Gebogen



NK-167

Stark Gebogen



NK-168

Stark Gebogen



NK-169

JAEGER
NK-159/NK-169

Mit Facettenschliff
 With facets along the cutting edge
 Con filo tagliente
 Con filos facetados
 Avec tranchant à facette

Gerade
Straight



NK-170

Gerade
Straight



NK-171

Gerade
Straight



NK-172



Leicht Gebogen



NK-173

Leicht Gebogen



NK-174

Leicht Gebogen



NK-175

Leicht Gebogen

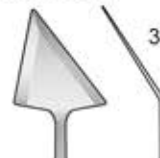

35°

NK-176

Stark Gebogen



JAEGER-GRIESHABER
NK-177
1,4 mm

Stark Gebogen



JAEGER-GRIESHABER
NK-178
2,5 mm

Stark Gebogen



JAEGER-GRIESHABER
NK-179
3,6 mm

Stark Gebogen



45°

JAEGER-GRIESHABER
NK-180
4,7 mm



JAEGER-GRIESHABER
NK-170/NK-180



NK-14/NK-185

Lanzenmesser

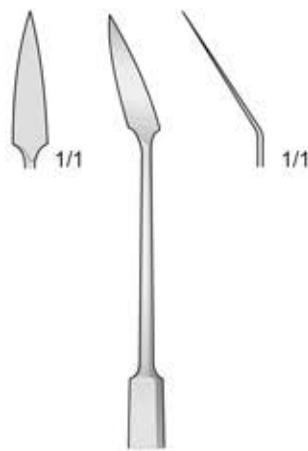
BERENS
NK-181

Rundlanze

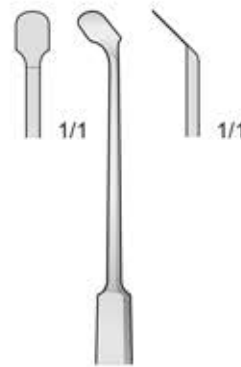
PAPST
NK-182
130 mm4x13 mm
LanzenmesserCASTROVIEJO
NK-183
135 mm

Lanze

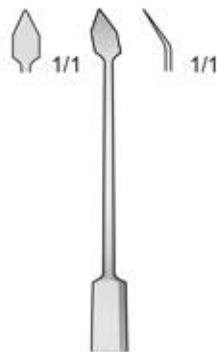
PHACO
NK-184 3,2 mm
NK-185 3,5 mm
130 mm

Luftlanze

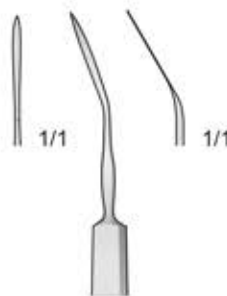
HAMBURG
NK-186

Skarifikateur

GRAEFE
NK-14
125 mm

Skarifikateur

GRAEFE
NK-16
135 mm

Tränenfistelmesser

WEBER
NK-187

Tränenfistelmesser

WEBER
NK-188

Tränenfistelmesser

WEBER
NK-189

Irismesser

KNAPP
NK-190

Irismesser

KNAPP
NK-191

Irismesser

KNAPP
NK-192

Irismesser

ZIEGLER
NK-193
3 mm

Irismesser

ZIEGLER
NK-06
5 mm

Irismesser

ZIEGLER
NK-08
6 mm

Irismesser

ZIEGLER
NK-10
7 mm

NK-06/NK-193

Nachstarmesser

KUHNT
NK-194

Nachstarmesser

KUHNT
NK-195Irismesser
3,5 mmZIEGLER
NK-196
110 mm

Hornhautmesser

SATO
NK-197
120 mm

Irismesser

WECKER
NK-198

Irismesser

SICHEL
NK-199
130 mm

Irismesser

HAAB
NK-200

Irismesser

GRAEFE
NK-201
130 mm

NK-194/NK-201

Hornhautschaber - Corneal Scarifier
 Scarificatore corneale - Legra para la córnea - Rugine pour la cornée



KUHNT
NK-202
 120 mm
 Fig. 1



KUHNT
NK-203
 120 mm
 Fig. 2



KUHNT
NK-204
 120 mm
 Fig. 3



KUHNT
NK-205
 120 mm
 Fig. 4

Hornhautdissektor
 Corneal Dissector
 Dissetto corneale
 Disecador para la córnea
 Dissecteur cornéal

Hornhautmesser
 Corneal Knife
 Coltello corneale
 Cuchillo para la córnea
 Couteau cornéal



PATON
NK-206
 120 mm



TOOK
NK-207
 120 mm

Hornhautmesser
 Corneal Knife
 Coltello corneale
 Cuchillo para la córnea
 Couteau cornéal

Hornhautmesser
 Corneal Knife
 Coltello corneale
 Cuchillo para la córnea
 Couteau cornéal

Hornhautmesser
 Corneal Knife
 Coltello corneale
 Cuchillo para la córnea
 Couteau cornéal



DESMARRES
NK-95
 135 mm



DESMARRES
NK-96
 135 mm



DESMARRES
NK-210
 135 mm



NK-202/NK-210



NK-211/NK-216

Hornhautmesser
Corneal Knife
Coltello corneale
Cuchillo para la córnea
Couteau corneal

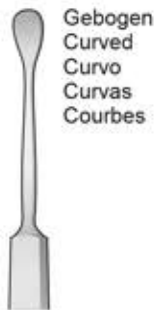

GILL
NK-211
120 mm

Messer



ANDERSON-CRITCHETT
NK-214
130 mm

Synechiotom
Links
Left
Sinistro
A la izquierda
À Gauche



AXENFELD
NK-212

Sklerotom



GUYTON-LUNDSGAARD
NK-215

Synechiotom
Rechts
Right
Destra
A la derecha
À Droite



AXENFELD
NK-213

Sklerarmesser
Scleral Knife



BONN
NK-216

Irismesser



**BARKAN
NK-217**
120 mm

Irismesser



**SCHEIE
NK-218**
130 mm

Fixierspieß
Fixation Fork



**BURCH
NK-219**
125 mm

Cataract needle



Gerade, Klein
Straight, Small

**STARNADEL
NK-220**

Cataract needle



Gebogen, Klein
Curved, Small

**STARNADEL
NK-221**

Diszisionsnadel
Discission needle
Ago da discissione
Aguja para discisión
Aiguille à discision



Gerade
Straight
Diritto
Recta
Droit

**BOWMANN
NK-222**

Diszisionsnadel
Discission needle
Ago da discissione
Aguja para discisión
Aiguille à discision



Gebogen
Curved
Curvo
Curvas
Courbes

**BOWMANN
NK-223**



NK-217/NK-223

Fremdkörperinstrumente - Foreign Body instruments
 Strumenti per corpi estranei - Instrumentos para cuerpos extraños
 Instruments à corps étrangers

Fremdkörpernadel
 Foreign Body needle
 Ago per corpi estranei



SCHWEIZER
 NK-224
 120 mm

Fremdkörpernadel
 Foreign Body needle
 Ago per corpi estranei

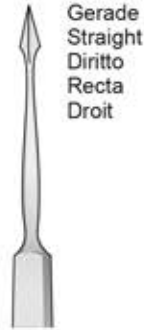

NK-225
 130 mm

Fremdkörpernadel
 Foreign Body needle
 Ago per corpi estranei

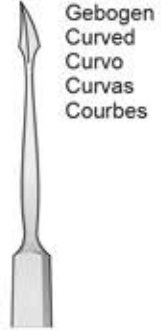

NK-226
 130 mm

Fremdkörpernadel
 Foreign Body needle
 Ago per corpi estranei

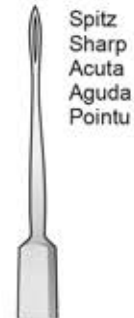

LEVINSON
 NK-227
 130 mm

Fremdkörpernadel
 Foreign Body needle
 Ago per corpi estranei



ALVIS
 NK-228
 120 mm

Fremdkörperhaken
 Foreign Body Hook
 Uncino per corpi estranei



FRANCIS
 NK-229
 120 mm

Fremdkörpernadel
 Foreign Body needle
 Ago per corpi estranei



ELLIS
 NK-07
 120 mm

Fremdkörpernadel
 Foreign Body needle
 Ago per corpi estranei



PLANGE
 NK-230
 120 mm

Flachmeißel
 Foreign Body Chisel
 Scalpello per corpi estranei



NICATI
 NK-231
 120 mm

NK-07/NK-231



Hohlmeißel
Gouge
Sgorbia
Gubias
Gouge

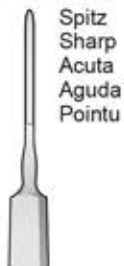

Spitz
Sharp
Acuta
Aguda
Pointu

WALTON
NK-232

Hohlmeißel
Gouge
Sgorbia
Gubias
Gouge



Rund
Round
Rotonda
Redonda
Rond

WALTON
NK-233

Hohlmeißel
Gouge
Sgorbia
Gubias
Gouge



Rund
Round
Rotonda
Redonda
Rond

WALTON
NK-234

Meißel
Spud
Scalpello
Cinceles
Ciseaux-burin

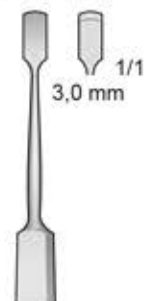

3,0 mm
1/1

ROLLET
NK-235

Cystotom
Cystotome
Cistotomo
Quistótomo
Kistitome



Gerade
Straight
Diritto
Recta
Droit

GRAEFE
BT-10

Cystotom, Links
Cystotome, Left
Cistotomo, Sinistro
Quistótomo, A la izquierda
Kistitome, A gauche



Gebogen
Curved
Curvo
Curvas
Courbes

GRAEFE
BT-12

Cystotom
Cystotome
Cistotomo
Quistótomo
Kistitome

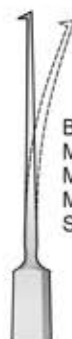

Biegsam
Malleable
Malleabile
Maleable
Souple

BECKER
BT-13

Cystotom, Rechts
Cystotome, Right
Cistotomo, Destro
Quistótomo, A la derecha
Kistitome, A droite

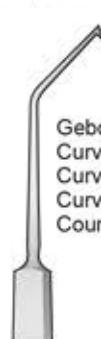

Gebogen
Curved
Curvo
Curvas
Courbes

GRAEFE
BT-14

NK-232/NK-235
120 mm

BT-10/BT-14
130 mm

Instrumentarium für die Staroperation
 Instruments for cataract operations
 Strumenti per cataratta
 Instrumental para operación de cataratas
 Instrumentation pour opérations de cataracte

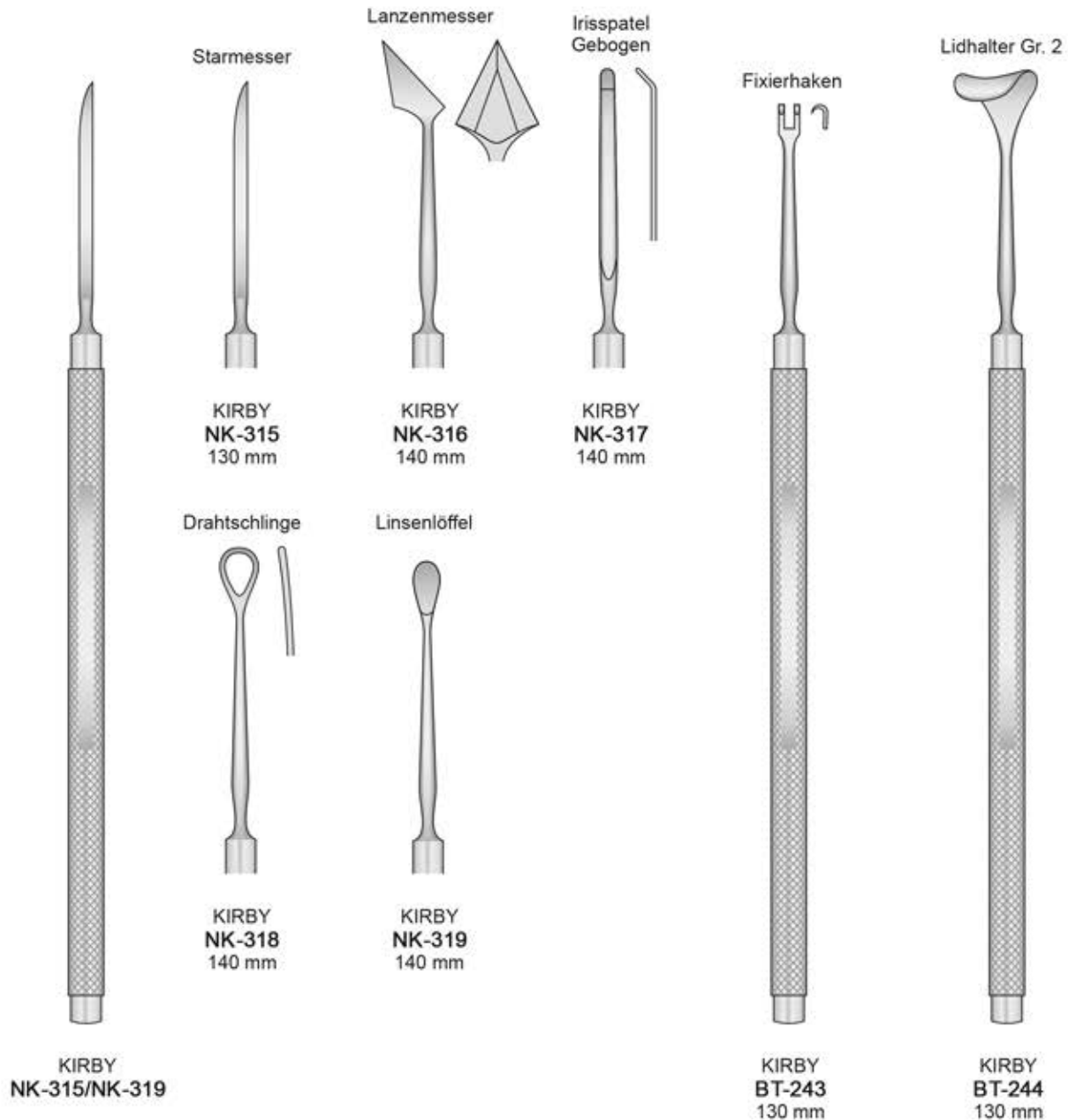

Keratoplastikmesser
Keratoplasty Knives
Bisturi per cheratoplastica
Cuchillo para queratoplástica
Couteau kératoplastique

Keratoplastikmesser
Keratoplasty Knives



PAUFIQUE
NK-323
105 mm

Keratoplastikmesser
Rund
Keratoplasty Knives



1/1

1/1



BARRAQUER
NK-324
130 mm

Keratoplastikmesser
Keratoplasty Knives
7 x 1 mm



BARRAQUER
NK-325
130 mm

Plastikmesser
Plastic-Surgery Knife
Bisturi per chirurgia plastica
Cuchillo para cirugía plástica
Couteau pour plastiques



BLASCOVICS
NK-329

Plastikmesser
Plastic-Surgery Knife
Bisturi per chirurgia plastica
Cuchillo para cirugía plástica
Couteau pour plastiques



ELSCHNIG
NK-330

Fadenlösemesser
Knife for removal of sutures
Bisturi per rimozione di suture



NK-331

Fremdkörper - Doppelinstrument
 Foreign Body Instruments
 Strumenti per corpi estranei
 Instrumentos para cuerpos extraños
 Instruments à corps étrangers

Runder Schiebegriff
 Round sliding handle
 Manico rotondo
 terminali scorrevoli
 Mango redondo corredizo
 Manche rond à glissière

Nadel / Flachmeißel
 Needle / Spud
 Ago / scalpello
 Agujas / Cinceles
 Aiguilles / Ciseaux-burin



DIX
 NK-388
 95 mm

Runder Schiebegriff
 Round sliding handle
 Manico rotondo
 terminali scorrevoli
 Mango redondo corredizo
 Manche rond à glissière

Nadel / Plangespatel
 Needle / Spatula
 Ago / spatola
 Agujas / Espátula
 Aiguilles / Spatule



DIX
 NK-389
 95 mm

Runder Schiebegriff
 Round sliding handle
 Manico rotondo
 terminali scorrevoli
 Mango redondo corredizo
 Manche rond à glissière

Nadel / Hohlmeißel
 Needle / Gouge
 Ago / sgorbia
 Agujas / Gubias
 Aiguilles / Gouge



DIX
 NK-390
 95 mm

Fremdkörper - Doppelinstrument
 Foreign Body Instruments
 Strumenti per corpi estranei
 Instrumentos para cuerpos extraños
 Instruments à corps étrangers

Nadel und Flachmeißel, umschraubbar
 Needle and Spud, in reversible screw-handle
 Ago e scalpello con manico reversibile
 Aguja y Cincel, reversible, con rosca
 Aiguille et Ciseaux-burin, rentrant dans le manche



DIX
NK-393

Nadel und Hohlmeißel, umschraubbar
 Needle and Gouge, in reversible screw-handle
 Ago e Sgorbia con manico reversibile
 Aguja y Gubia, reversible, con rosca
 Aiguille et Gouge, rentrant dans le manche



DIX
NK-394

Nadel, allein
 Needle only
 Ago, solo
 Aguja suelta
 Gouge seule



DIX
NK-395

Flachmeißel, allein
 Spud only
 Scalpello, solo
 Cincel suelta
 Ciseaux-burin seuls



DIX
NK-396

Hohlmeißel, allein
 Gouge only
 Sgorbia, sola
 Gubia suelta
 Gouge seule



DIX
NK-397

0,5 mm

NK-286
130 mm

1,0 mm

NK-287
130 mm

1,5 mm

NK-288
130 mm

Löffel

MEYHOEFER
NK-286/NK-295
130 mm

1,8 mm

NK-289
130 mm

2,0 mm

NK-290
130 mm

2,5 mm

NK-291
130 mm

3,0 mm

NK-292
130 mm

3,5 mm

NK-293
130 mm

4,0 mm

NK-294
130 mm

4,5 mm

NK-295
130 mm

Löffel
1,0 mmHEBRA
NK-296
130 mmLöffel
2,0 mmHEBRA
NK-297
130 mmLöffel
2,5 mmHEBRA
NK-298
130 mmLöffel
3,0 mmHEBRA
NK-299
130 mmLöffel
3,5 mmHEBRA
NK-300
130 mmLöffel
1,5 mmSKEELE
NK-301
130 mmLöffel
2,0 mmSKEELE
NK-302
130 mmLöffel
2,5 mmSKEELE
NK-303
130 mmLöffel
3,0 mmSKEELE
NK-304
130 mmNK-296/NK-304
130 mm

Exenterations Löffel
 Enucleation Spoon
 Cucchiai da enucleazione
 Cucharillas para exenteración
 Curettes pour l'exentération

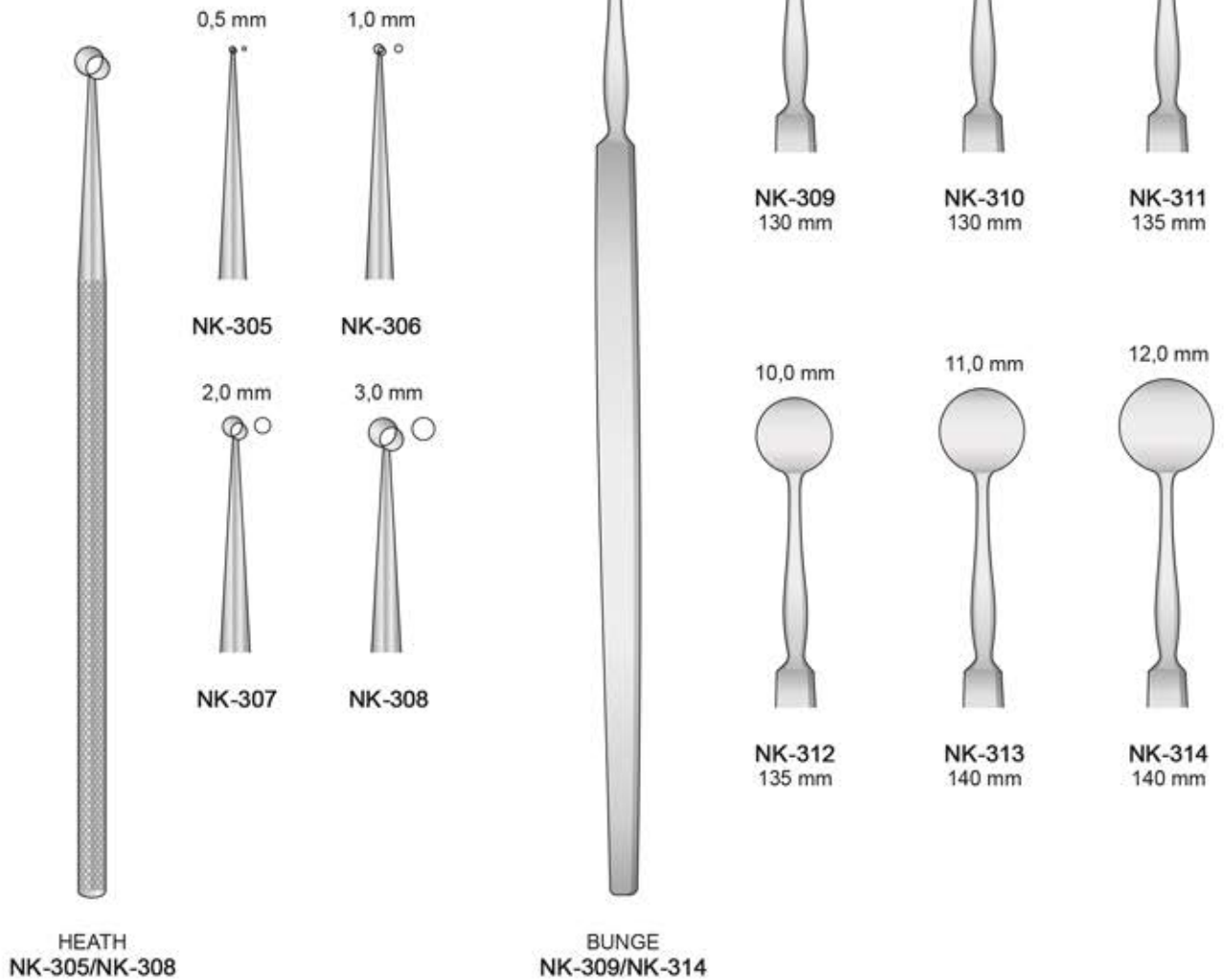



LB-40
 Packung 10 Klinge
 Package 10 blades
 Scatola da 10 lame
 Cajita de 10 hojas
 Boite de 10 lames

Mini-Klingen, Steril
 Mini Blades, Sterile
 Micro lame, sterili



LB-364
 Pack. 10 St.
 Conf. 10 pz.



LB-365
 Pack. 10 St.
 Conf. 10 pz.



LB-367
 Pack. 10 St.
 Conf. 10 pz.

Steril
 Sterile

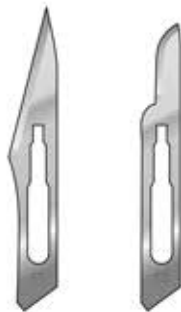

LB-11 Fig. 11
LB-15 Fig. 15

Packung 100 Klinge
 Package 100 blades
 Scatola da 100 lame
 Cajita de 100 hojas
 Boite de 100 lames



MA-B3
 Fig. 3



MA-B7K
 Fig. 7k



NK-1
 100 mm



NK-2
 150 mm



BB-46
 135 mm



NK-12
 120 mm



Bone Rongeurs

Hohlmeißelzangen

Pinces gouges

Pinzas gubias

Pinze ossivore

Retractors

Retraktoren

Écarteurs

Separadores

Divaricatori

Vitrectomy

Vitrectomie

Vitrectomie

Vitrectomía

Vitrectomía

Nasenspeculum
Nasal speculum
Speculum nasali
Espéculos nasales
Spéculums nasaux

Hohlmeißelzange
Rongeur
Pinza per dacrio-rinostomia

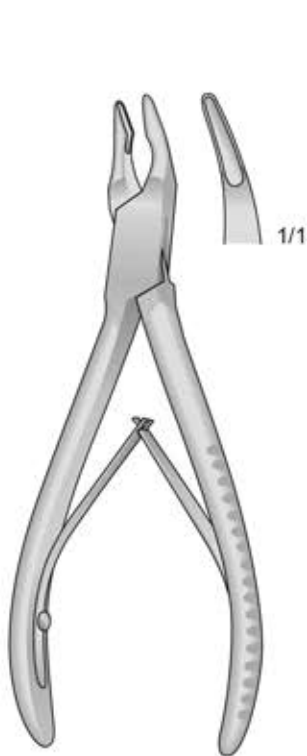

MINI FRIEDMANN
FO-15
120 mm

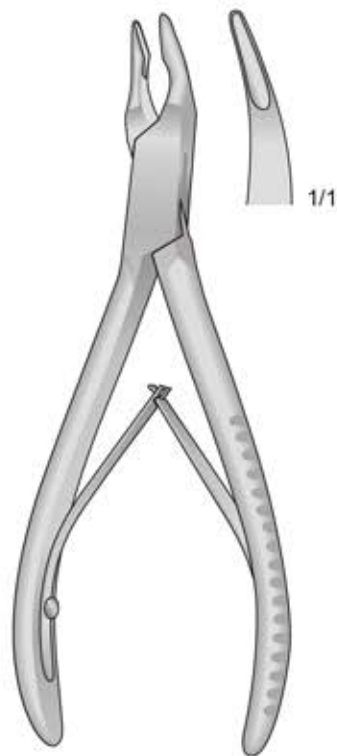

FRIEDMANN
FO-17
140 mm

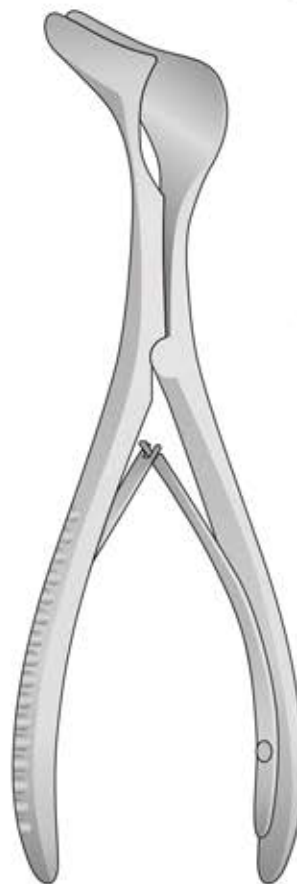

HARTMANN
OM-20/OM-23

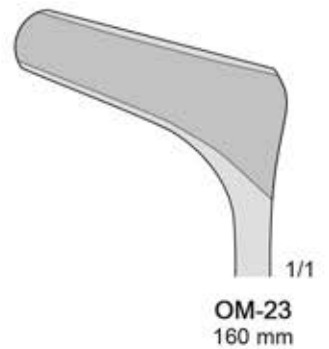

Pinze per dacrio-cisto-rinostomia

Punches - Stanzen

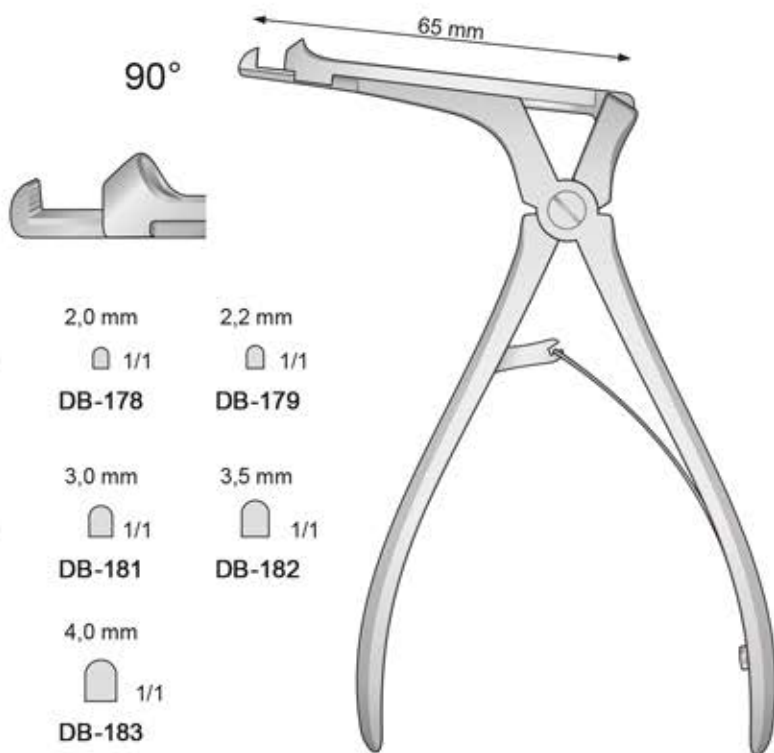

- | | | |
|--------|--------|--------|
| 1,5 mm | 2,0 mm | 2,2 mm |
| 1/1 | 1/1 | 1/1 |
| DB-177 | DB-178 | DB-179 |
| 2,5 mm | 3,0 mm | 3,5 mm |
| 1/1 | 1/1 | 1/1 |
| DB-180 | DB-181 | DB-182 |
| | 4,0 mm | |
| | 1/1 | |
| | DB-183 | |

- DB-177 1,5 mm
- DB-178 2,0 mm
- DB-179 2,2 mm
- DB-180 2,5 mm
- DB-181 3,0 mm
- DB-182 3,5 mm
- DB-183 4,0 mm

CITELLI
DB-177/DB-183

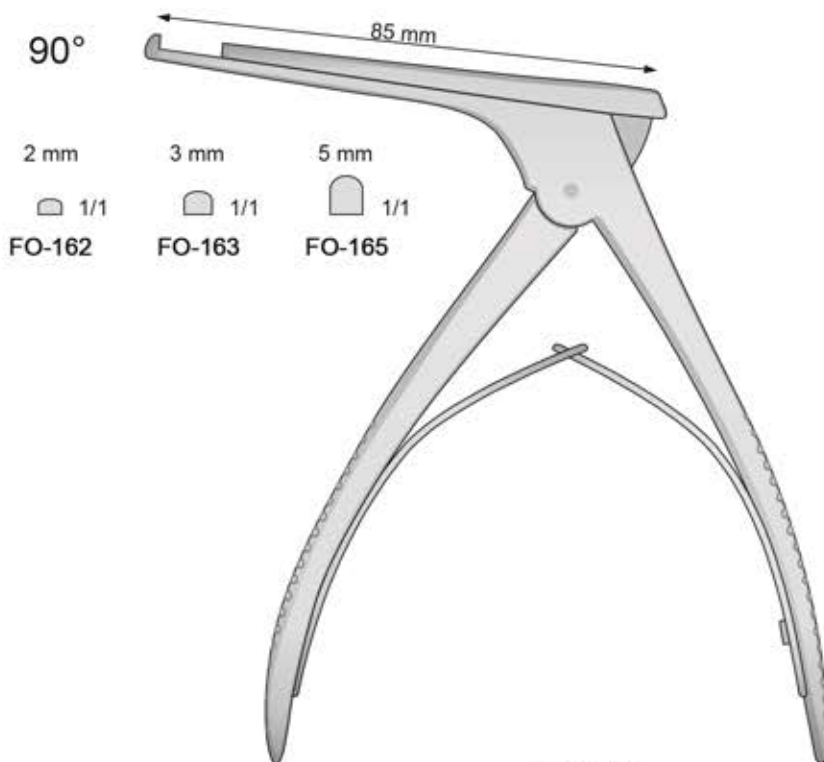

- | | | |
|--------|--------|--------|
| 2 mm | 3 mm | 5 mm |
| 1/1 | 1/1 | 1/1 |
| FO-162 | FO-163 | FO-165 |

KERRISON
FO-162 2 mm
FO-163 3 mm
FO-165 5 mm

Hämmer
Hammer

Ø 26 mm - 320 g



FL-12R

Coppia di teste
di ricambio
Pair of spare faces
Paar Ersatzbacken
Paire de faces
de rechange
Pareja de tapas
intercambiables

MEAD
FL-12
190 mm

Haken
Hooks
Uncini doppi da calazio
Ganchos
Crochets

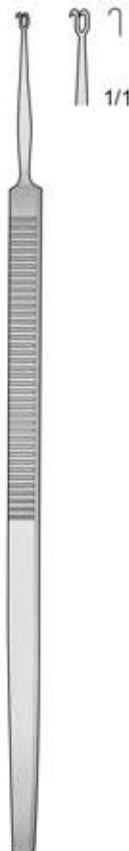

GUTHRIE
BT-203
160 mm



GUTHRIE
BT-204
160 mm

Löffel - Spoon
Cucchiaio - Cucharillas
Curettes



GRAEFE
NK-278
130 mm

Löffel - Spoon
Cucchiaio - Cucharillas
Curettes



GRAEFE
NK-279
130 mm

Löffel - Spoon
Cucchiaio - Cucharillas
Curettes



HESS
NK-282

Löffel - Spoon
Cucchiaio - Cucharillas
Curettes



DAVIEL
NK-280
125 mm

Löffel - Spoon
Cucchiaio - Cucharillas
Curettes



DAVIEL
NK-281
125 mm

Enukleationslöffel
Enucleation Spoon
Cucchiaio da enucleazione
Espátula para enucleación
Spatule échancrée pour l'enucléation



WELLS
NK-285
150 mm

Löffel - Spoon
Cucchiaio - Cucharillas
Curettes



ELSCHNIG
NK-283

Links
Left
Sinistro
A la izquierda
À gauche

Löffel - Spoon
Cucchiaio - Cucharillas
Curettes

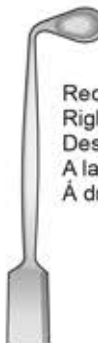

ELSCHNIG
NK-284

Rechts
Right
Destro
A la derecha
À droite

NK-278/NK-285

Kystotom und Löffel
Cystotome and Spoon
Cistotomo e cucchiaio
Quistótomo y cucharilla
kystitome et curette



MOORFIELD
NK-372
130 mm

Doppellöffel
Double Spoon
Cucchiaio doppio
Cucharilla doble
Curette couble

3,0 mm / 4,0 mm



MEYHOEFER
NK-373
130 mm

Löffel & Gerader Spatel
Spoon and Straight Spatula
Cucchiaio e spatola retta
Cucharilla y espátula recta
Curette avec spatule droite



LÖFFEL
NK-374
140 mm

Löffel & Gebogener Spatel
Spoon and Curved Spatula
Cucchiaio e spatola curva
Cucharilla y espátula curva
Curette avec spatule courbe



LÖFFEL
NK-375
140 mm

Löffel vorwärts
Cucchiaio da calazio
tagliente, verso l'alto



AXENFELD
FK-165
120 mm

Löffel rückwärts
Cucchiaio da calazio
tagliente, verso il basso



AXENFELD
FK-166
120 mm

Chalazion-Doppellöffel
Chalazion Curette
Cucchiaio da calazio
doppio, tagliente



AXENFELD
FK-167
130 mm

Irisretraktor
Iris Retractor
Retrattori per iride
Separador para iris
Rétracteur à iris

Rechts - Right - Destro
A la derecha - À droite



GROSS
NK-333
135 mm

Irisretraktor
Iris Retractor
Retrattori per iride
Separador para iris
Rétracteur à iris

Links - Left - Sinistro
A la izquierda - À gauche



GROSS
NK-334
135 mm

Irishäkchen - Iris Hook - Uncini da iride
Ganchos para iris - Crochets à iris

Irisretractor
Iris Retractor
Retrattori per iride
Separador para iris
Rétracteur à iris

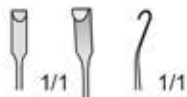

BRAND
NK-335



MOD.TÜBINGEN
NK-336
140 mm



MOD.BONN
NK-337
140 mm



Scharf
Sharp
Acuto
Agudo
Pointu

GRÄFE
NK-338
120 mm



Stumpf
Blunt
Smusso
Romo
Mousse

GRÄFE
NK-339
120 mm



JAEGER
BT-232/BT-233
130 mm

Schielhaken
Strabismus Hooks
Uncini da strabismo
Ganchos para estrabismo
Crochets à strabisme

Fig. 1



BT-232

Fig. 2



BT-233

Tränensackhäkchen
 Hooks for lachrymal sac
 Uncini divaricatori per il sacco lacrimale
 Ganchos para saco lacrimal
 Crochets pour le sac lacrymal

Scharf
 Sharp
 Acuto
 Agudo
 Pointu

Irishäkchen
 Iris Hook
 Uncini da iride
 Ganchos para iris
 Crochets à iris



O'CONNOR
 BT-230
 120 mm

Scharf
 Sharp
 Acuto
 Agudo
 Pointu

Irishäkchen
 Iris Hook
 Uncini da iride
 Ganchos para iris
 Crochets à iris



WIENER
 BT-231
 130 mm

Scharf
 Sharp
 Acuto
 Agudo
 Pointu

Häkchen
 Hook
 Uncino
 Ganchos
 Crochets



GUTHRIE
 BT-234
 120 mm

Scharf
 Sharp
 Acuto
 Agudo
 Pointu

Häkchen
 Hook
 Uncino
 Ganchos
 Crochets



GUTHRIE
 BT-235
 130 mm

4 Zähne
 4 Teeth
 4 Denti
 4 Dientes
 4 Dents

Stumpf
 Blunt
 Smusso
 Romo
 Mousse



KNAPP
 BT-236
 135 mm

4 Zähne
 4 Teeth
 4 Denti
 4 Dientes
 4 Dents

Scharf
 Sharp
 Acuto
 Agudo
 Pointu



ROLLET
 BT-237
 135 mm

BT-230/BT-237

Lokalisator



MEYER-SCHWICKERATH
NK-236

Linsenhäkchen



GRAEFE
NK-276
130 mm

Irisretraktor



Mc GANNEN
NK-277
130 mm

NK-236/NK-277

Fixazionhaken
Fixation Claw
Uncino doppio
da fissazione
Garra Fijadora
Griffe à fixation



FIXIERKRALLE
NK-237/NK-238
105 mm

2 Zähne
2 Teeth
2 Denti
2 Dientes
2 Dents



AXENFELD
BT-238 BT-239
Scharf Stumpf
Sharp Blunt
Acuto Smusso
Agudo Romo
Pointu Mousse

3 Zähne
3 Teeth
3 Denti
3 Dientes
3 Dents



AXENFELD
BT-240 BT-241
Scharf Stumpf
Sharp Blunt
Acuto Smusso
Agudo Romo
Pointu Mousse

Häkchen
Hooks
Uncini
Ganchos
Crochets



PAUL
BT-242
125 mm

Wundlöffel
Protector
Protettore
Protector
Protecteur



ARRUGA
NK-239

NK-237 Rechts - Right - Destro
A la derecha - À droite
NK-238 Links - Left - Sinistro
A la izquierda - À gauche

Schielhaken
Strabismus Hook
Uncino da strabismo
Ganchos para estrabismo
Crochets à strabisme



NK-41/NK-245



STEVENS
NK-240
140 mm



CULLER
NK-209
120 mm



STEVENS
NK-241
120 mm



JAMESON
NK-242
130 mm

Muskelhaken
Oblique Muscle Hook



Curved shaft with
flat 4,5 mm Hook



SCOBEE
NK-391
135 mm

Schielhaken



MALBRAN
NK-244
140 mm

Schielhaken



GREEN
NK-243
130 mm

Schielhaken, kurz



GRAEFE
NK-245
130 mm

Schielhaken



GRAEFE
NK-41
130 mm

Schielhaken



GRAEFE
NK-42
140 mm

Schielhaken



GRAEFE
NK-43
150 mm



NK-435
130 mm

Crochet à strabisme
Strabismus Hooks



WORST
NK-434
135 mm



NK-436
140 mm

Starhaken
Lens Hook
Uncino intracapsulare
Ganchos intracapsular
Crochets intracapsulaires

Links
Left
Sinistro
Izquierda
Gauche

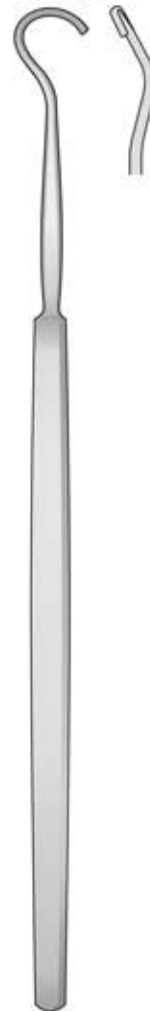

ARRUGA
NK-59L
140 mm

Rechts
Right
Destro
Derecha
Droite

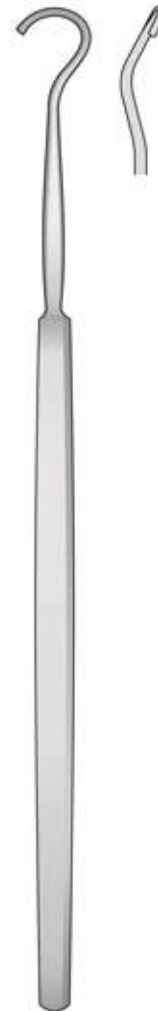

ARRUGA
NK-59
140 mm

Expressionshaken
Expression Hook
Anello per il cristallino
Expresor para cristalino
Expresseur pour la
lentille cristalline



HESS
NK-275

U-Bindungsnadel
Links
Left
Sinistro
A la izquierda
À gauche



WOODRUFF
BM-54
130 mm

U-Bindungsnadel
Rechts
Right
Destro
A la derecha
À droite

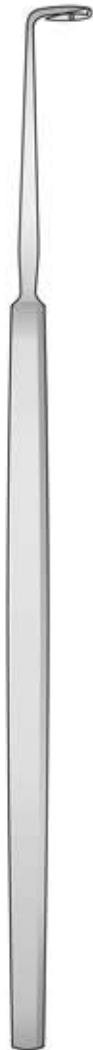

WOODRUFF
BM-55
130 mm

U-Bindungsnadel
Links
Left
Sinistro
A la izquierda
À gauche



DE LA ROZA
BM-56
120 mm

U-Bindungsnadel
Rechts
Right
Destro
A la derecha
À droite

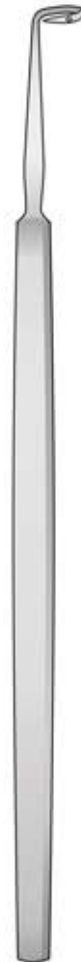

DE LA ROZA
BM-57
120 mm

Augennadel



HESSBERG
BM-58
150 mm

Augennadel



JACOBI
BM-59
140 mm

Pigtail-Sonden
Pigtail Probes

Mit Haken
With Hook
Con Uncino
Con Ganchos
Avec Crochets



NK-370

Mit Öhr
With eye
Con occhiello
Con ojo
Avec oeil

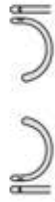

NK-371



NK-370/NK-371
150 mm



SEIFFERT
PF-16
180 mm

Haltende Instrumente
Holding Instruments
Porta tamponi



HEILDEBERG
PF-60
180 mm



HEILDEBERG
PF-61
170 mm



Flachmeißel
Bone chisel Flat
Scalpello
Cinzel
Ciseaux-burins

5,0 mm



WEST
FL-133
160 mm

Hohlmeißel
Bone chisel Hollow
Scalpello
Cinzel
Ciseaux-burins

5,0 mm



WEST
FL-134
160 mm

Elevatorien
Elevator
Elevatore
Elevadores
Elévateurs

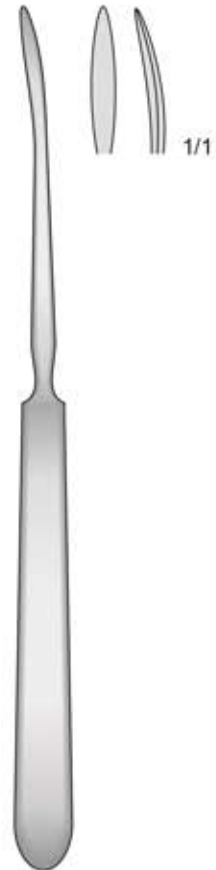

LUENEBURG
FR-10
115 mm

Vitrektomie Instrumente
Vitreotomy Instruments

0,9 mm
Schaft und Arbeitsende
mit nicht-reflektierender
schwarzer Beschichtung
20 gauge
Shaft and working tip
with non-reflective black finish



MF-401
Faßzange, glatt
Grasping Forceps, smooth

MF-402
Faßzange, glatt, 45°
Grasping Forceps, smooth, 45°

MF-403
Faßzange, gerieft
Grasping Forceps, serrated

MF-404
Faßzange, gerieft, 30°
Grasping Forceps, serrated, 30°

MF-405
Faßzange, gerieft
Grasping Forceps, serrated

MF-406
Faßzange, gerieft
Grasping Forceps, serrated

MF-407
Faßzange, 1x2 Zähne
Grasping Forceps, 1x2 Teeth

MF-408
Faßzange, innen diamantbeschichtet
Grasping Forceps, diamond coated inside

MF-409
Faßzange, Punkt 0,3 mm
Grasping Forceps, 0,3 mm, end-gripping

MF-410
Faßzange, Punkt 0,44 mm
Grasping Forceps, 0,44 mm, end-gripping

MF-411
Faßzange
Grasping Forceps

MF-412
Faßzange, 45°
Grasping Forceps, 45°

MF-413
Faßzange, glatt, 45°
Grasping Forceps, smooth, 45°

MF-414
Faßzange, glatt, 45°
Grasping Forceps, smooth, 45°

MF-415
Faßzange, glatt, 60°
Grasping Forceps, smooth, 60°

MF-416
Faßzange, glatt, 90°
Grasping Forceps, smooth, 90°

MF-417
Faßzange, gerieft, 60°
Grasping Forceps, serrated, 60°

MF-418
Faßzange, gerieft, 90°
Grasping Forceps, serrated, 90°

MF-419
Löffelzange
Spoon Forceps

MF-420
Schere, gerade
Scissors, straight

MF-421
Schere, abgewinkelt, 30°
Scissors, angled, 30°

MF-422
Schere, abgewinkelt, 60°
Scissors, angled, 60°

MF-423
Schere mit Schippe, gewinkelt, 60°
Scissors with scoop tip, angled, 60°

MF-424
Schere, abgewinkelt, 90°
Scissors, angled, 90°

MF-401/MF-424

Linsenmanipulatoren
Lens manipulators
Manipolatori del IOL
Manipuladores de lentes
Micro-Manipulateurs d'implant

Faco Chopper
Uncini di Nagahara per Faco-Chop

Phaco Splitter
60° angled
wedge shaped
inferior edge
with blunt tip

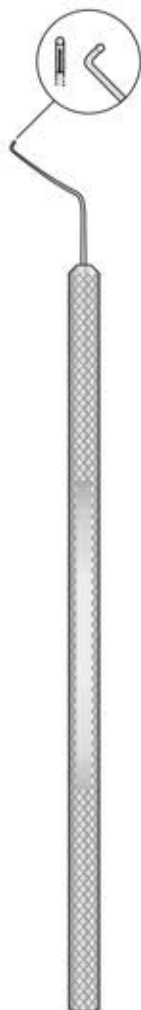

NK-417
116 mm

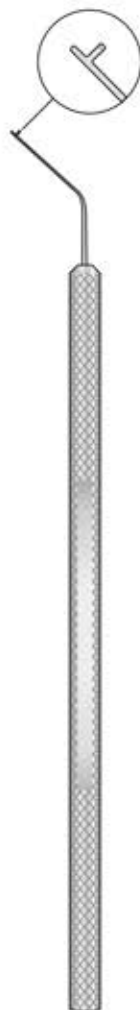

NK-427
116 mm

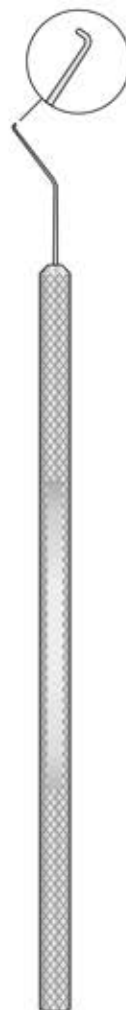

NK-349
120 mm

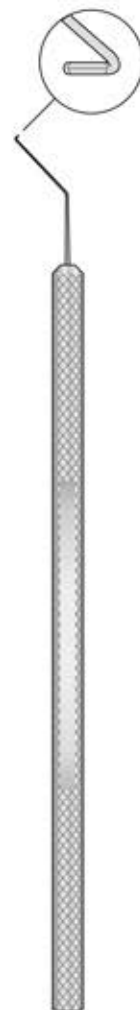

ROSEN
NK-399
115 mm

Linsenmanipulatoren
Lens manipulators
Manipolatori del IOL
Manipuladores de lentes
Micro-Manipulateurs d'implant

Irishaken 0,5 mm
Stumpf, Gebogen



JAFFE-KNOLLE
NK-340
120 mm

Linsenspatel 0,5 mm
Glatt, Flach, Gebogen



JAFFE
NK-341
120 mm

Kragen-Kopf
Polierer, Gerade



GRAEATHER
NK-342
120 mm

Kragen-Kopf
Polierer, Gebogen



GRAEATHER
NK-343
120 mm

Linsenrotierer
Stumpf, Gebogen



BECHERT
NK-344
120 mm

Irishaken 0,5 mm
Stumpf, Gerade



JAFFE-KNOLLE
NK-345
120 mm

Linsenspatel 0,5 mm
Breit, Flach, Gebogen



HIRSCHMANN
NK-346
115 mm

Linsenhaken
Gebogen



HIRSCHMANN
NK-347
120 mm

Linsenhaken 0,2 mm
Stumpf, Gerade



SINSKEY
NK-348
120 mm

Linsenhaken 0,2 mm
Stumpf, Gebogen



SINSKEY
NK-349
120 mm

Linsenhaken 0,25 mm
Stumpf, Gerade



LESTER
NK-350
115 mm



Tränenkanaldilatatoren - Lacrymal dilators - Dilatatori lacrimali - Dilatadores lacrimales - Dilatateurs lacrymal

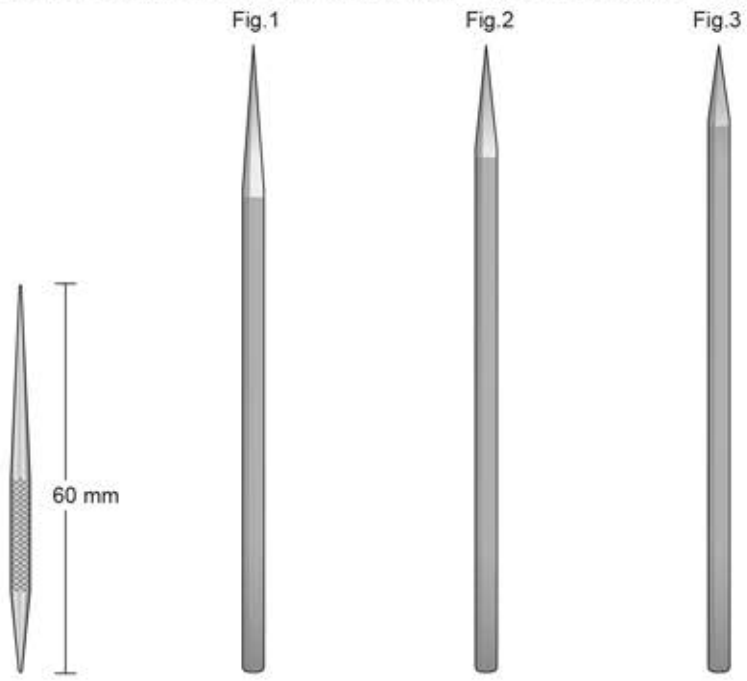

WILDER
NK-97A
60 mm

WILDER
NK-97
110 mm

WILDER
NK-98
110 mm

WILDER
NK-99
110 mm

Doppelsonde
Lacrymal Dilator

Trabekularsonde
Trabecular Probes
Trabeculotomo
Estiletes Trabeculares
Sondes trabeculaires

Retrogradsonde
Retrograde Probe
Retrattore

Dilatator

Links
Left
Sinistro
A la izquierda
À gauche

Rechts
Right
Destro
A la derecha
À droite

Rechts
Right
Destro
A la derecha
À droite

Links
Left
Sinistro
A la izquierda
À gauche

Trabekularsonde
Trabecular Probes
Trabeculotomo
Estiletes Trabeculares
Sondes trabeculaires

Links
Left
Sinistro
A la izquierda
À gauche

Rechts
Right
Destro
A la derecha
À droite

CASTROVIEJO
NK-332
135 mm

MULDOON
NK-360
95 mm

MACKENSEN
NK-361
95 mm

MACKENSEN
NK-362
95 mm

HARMS
NK-363

HARMS
NK-364

KELLNAR
NK-365

KELLNAR
NK-366

Scala comparativa delle sonde per canale lacrimale

Fig.	0000	000	00	0	1	2
Ø in mm.	0.5	0.6	0.7	0.8	0.9	1.1

Fig.	3	4	5	6	7	8
Ø in mm.	1.3	1.4	1.5	1.6	1.8	1.9

Silber
Silver
Argento
Plata
Argent



Silber
Silver
Argento
Plata
Argent



BOWMAN

PF-30 00/0 PF-34 5/6
PF-31 1/2 PF-35 7/8
PF-33 3/4 PF-37 6/7

BOWMAN

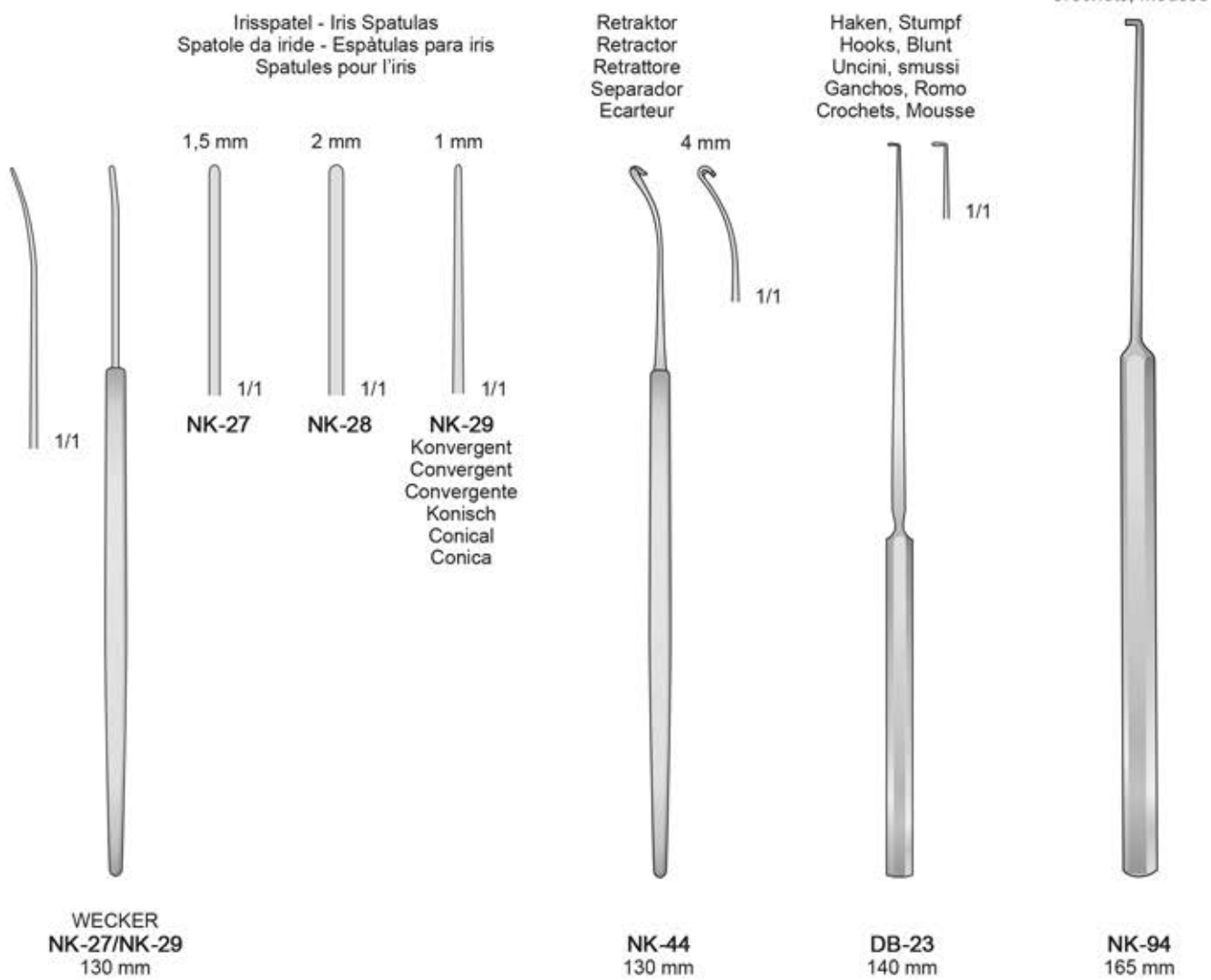



NK-03
Links
Left
Sinistro
Izquierda
Gauche

NK-04
Rechts
Right
Destro
Derecha
Droite



NK-03/NK-04
140 mm



B
NK-74 0,2 mm
NK-76 0,3 mm
125 mm

Schaber
Scarifiers
Scarificatori
Legras
Rugines



NK-11
125 mm



NK-13
120 mm



NK-93
120 mm



NK-75
130 mm



CASTROVIEJO
NK-21/NK-26
130 mm

Zyklodialyse Spatel
Cyclodialysis Spatula
Spatola per ciclodialisi, piatta
Espátula para ciclodialisis
Spatule pour cyclodialyse



NK-21
130 mm



NK-22
130 mm



NK-23
130 mm



NK-24
130 mm



NK-25
130 mm



NK-26
130 mm

Augenklappe - Aluminium
 Eye shield - Aluminium
 Occlusori - Alluminio
 Protector de ojos - Aluminio
 Protecteur des yeux - Aluminium

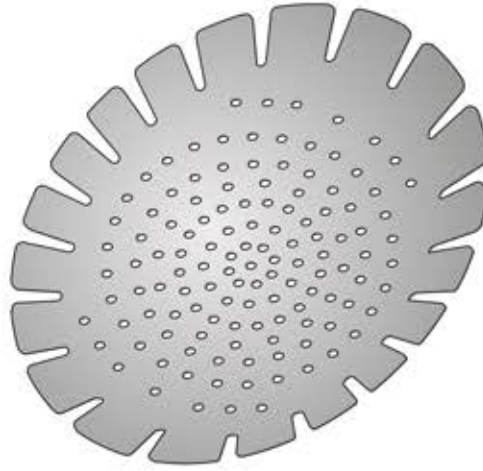

OL-20
75 mm

Spatole per vitreo

Platinum
Spatula



KIMURA
NK-48
150 mm

1,5 mm

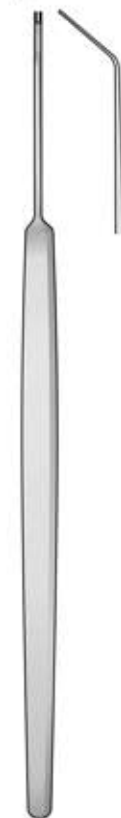

NK-109
130 mm

1/1

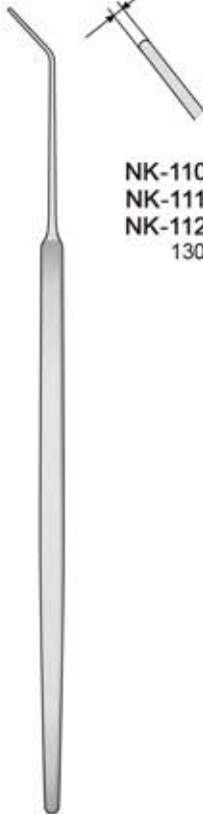

CASTROVIEJO
NK-110/NK-112
130 mm

A
 NK-110 0,6 mm
 NK-111 1,0 mm
 NK-112 1,5 mm
 130 mm

Bolla bilaterale



BARRAQUER
NK-423
120 mm

Bolla destra



BARRAQUER
NK-424
120 Mm

Bolla sinistra

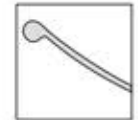

BARRAQUER
NK-425
120 Mm

Zyklodialyse Spatel - Cyclodialysis Spatula
 Spatola per ciclodialisi, piatta - Espátula para ciclodialisis
 Spatule pour cyclodialyse

Spatel
 Spatula
 Spatola
 Espátulas
 Spatules



ELSCHNIG
 NK-263
 130 mm

Spatel
 Spatula
 Spatola
 Espátulas
 Spatules
 10 mm



CASTROVIEJO
 NK-267
 130 mm

Spatel
 Spatula
 Spatola
 Espátulas
 Spatules
 15 mm

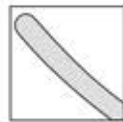

CASTROVIEJO
 NK-268
 140 mm

Irisspatel
 Iris Spatulas
 Micro Spatole da iride
 Espátulas para iris
 Spatules pour l'iris

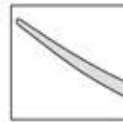

BARRAQUER
 NK-264
 120 mm

Irisspatel
 Iris Spatulas
 Micro Spatole da iride
 Espátulas para iris
 Spatules pour l'iris



TROUTMAN-BARRAQUER
 NK-265 0.25 mm x 15 mm
 NK-266 0.5 mm x 15 mm
 90 mm

Zyklodialyse Spatel - Cyclodialysis Spatula
 Spatola per ciclodialisi, piatta - Espátula para ciclodiálisis
 Spatule pour cyclodialyse

Spatel
10 mm

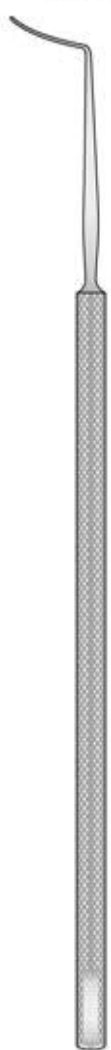

CASTROVIEJO
NK-258
130 mm

Spatel
15 mm



CASTROVIEJO
NK-259
130 mm



BANGERTER
NK-260/NK-262

- NK-260 1,0 mm
- NK-261 1,5 mm
- NK-262 2,0 mm

11 mm

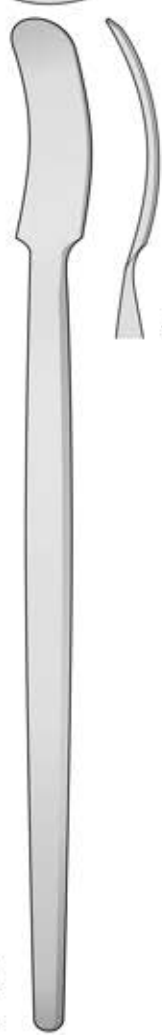

NK-105
125 mm

Irisspatel



BANGERTER
NK-103/NK-208

- NK-103 6 mm
- NK-104 10 mm
- NK-208 12 mm

1/1

Gerieft
Serrated
Zigrinato
Estriada
Striée



ELSCHNIG
NK-269
130 mm

Gerieft
Serrated
Zigrinato
Estriada
Striée



ELSCHNIG
NK-270
130 mm

Gerieft - Serrated
Zigrinato - Estriada
Striée



LEWIS
NK-271
135 mm



LEWIS
NK-272
135 mm



WEBER
NK-46
130 mm



WEBER
NK-47
140 mm



WEBER
NK-46
130 mm



NEW ORLEANS
NK-273
130 mm



SNELLEN
NK-45
135 mm

Gerieft - Serrated
Zigrinato - Estriada
Striée



ARLT
NK-274
135 mm

Linsenschieber, Doppelt
Lens Expressor double-ended
Uncino per il cristallino, doppio
Expresor para el cristallino, doble
Expresseur pour la lentille cristalline, double

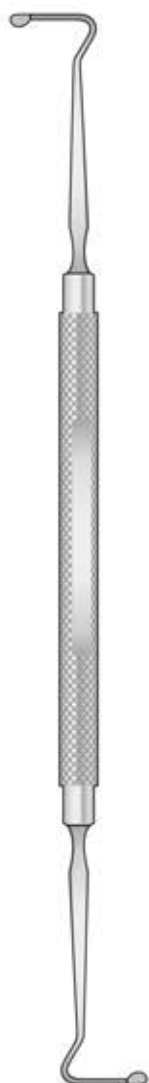

KIRBY
NK-320
140 mm

Iris Retractor
and Lens Expressor



RIZZUTI
NK-321
145 mm

Lens Loop
and Muscle Hook



KIRBY
NK-322
140 mm

Zyklodialyse Spatel - Cyclodialysis Spatula
 Spatola per ciclodialisi, piatta - Espátula para ciclodialisis
 Spatule pour cyclodialyse

Doppelspatel
 Double Spatula
 Spatola doppia
 Espátula doble
 Spatule double

Doppelinstrument



NK-376 0,25 mm
 NK-377 0,50 mm
 NK-378 0,75 mm
 NK-379 1,00 mm

CASTROVIEJO
 NK-376/NK-379
 140 mm

Doppelspatel
 Double Spatula
 Spatola doppia
 Espátula doble
 Spatule double

Doppelinstrument



CASTROVIEJO
 NK-380
 120 mm

Irisspatel und Schielhaken
 Iris Spatula and Squint Hook
 Spatola e uncino da strabismo
 Espátula para iris y gancho
 para estrabismo
 Spatule pour l'iris et
 crochet à strabisme

Doppelinstrument



KNAPP
 NK-381
 120 mm

Doppelspatel
 Double Spatula
 Spatola doppia
 Espátula doble
 Spatule double

Doppelinstrument



WHEELER
 NK-382
 120 mm

Graduiert
 Graduated
 Graduata
 Graduada
 Graduée

Doppelinstrument



LINDNER
 NK-383
 130 mm

Irisspatel
Iris Spatula
Spatola da iride
Espátula para iris
Spatule pour l'iris

Doppelinstrument



SMITH-FISCHER
NK-384

Spatel und Schielhaken
Spatula and Squint Hook
Spatola e uncino da strabismo
Espátula y gancho para estrabismo
Spatule et crochet à strabisme

Doppelinstrument



McREYNOLDS
NK-385
120 mm

Doppelspatel
Double Spatula
Spatola doppia
Espátula doble
Spatule double

Doppelinstrument



GREEN
NK-386
120 mm

Nadel und Spatel
Needle and Spatula
Ago e spatola
Aguja y Espátula
Aiguille et spatule

Doppelinstrument



FISCHER
NK-387
130 mm

Kauter - Cautery
Cauterio - Cauterio
Cautère



WILLS-HOSPITAL
NK-252

Kauter - Cautery
Cauterio - Cauterio
Cautère



WADSWORTH-TODD
NK-253

Kauter - Cautery
Cauterio - Cauterio
Cautère



PRINCE
NK-254



NK-27/NK-257

Spatel - Spatula
Spatola - Espátulas
Spatules

Linsenexpressor



BERENS
NK-255
120 mm

Gebogen
Curved
Curva
Curvas
Courbes



WECKER
NK-27
130 mm

Gerade
Straight
Diritta
Rectas
Droites

Spatel - Spatula
Spatola - Espátulas
Spatules



WECKER
NK-28
130 mm

Irisspatel
Iris Spatula
Spatola per iride
Espátula para iris
Spatule pour l'iris



MODELL FRANKFURT
NK-256
130 mm

Irisspatel
Iris Spatula
Spatola per iride
Espátula para iris
Spatule pour l'iris

Konisch
Conico



WECKER
NK-29
130 mm

Irisspatel
Iris Spatula
Spatola per iride
Espátula para iris
Spatule pour l'iris



CULLER
NK-257
130 mm

Orbitspatel - Orbit Spatula - Spatola da orbita - Espátula para órbita - Spatule orbitale

Fig.1 12 mm

SAUTTER
NK-247
145 mm

Fig.2 15 mm

SAUTTER
NK-248
145 mm

Fig.3 17 mm

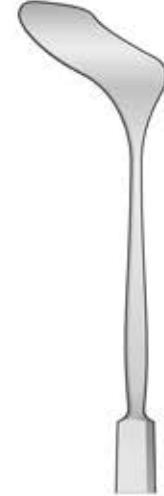
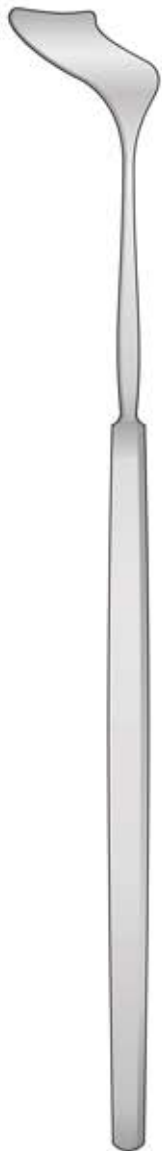
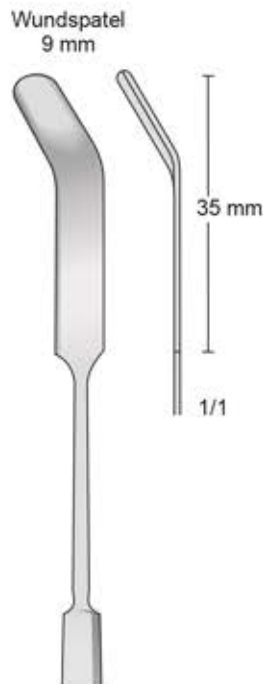
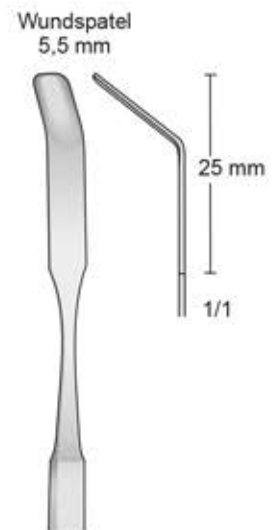
SAUTTER
NK-249
145 mmMODELL ESSEN
NK-250
140 mmMODELL GIESSEN
NK-251
160 mmNK-392
140 mm

Meßinstrument
Measuring Instrument
Strumenti per misurazione
Instrumentos para medir
Instruments à mesurer



PATON
NK-327
140 mm



CASTROVIEJO
NK-328
140 mm



NK-452
6,0 mm / 7,0 mm
118 mm



NK-451
4,0 mm / 5,0 mm
118 mm

Lidpresser
Lid Expressor
Strumento per palpebra
Expressor de párpados
Expresseur de paupières



1/1

DS-08
90 mm

Lidplatte
Lid Plate
Placca per palpebre
Placa para párpados
Plaque à paupières



JAEGER
OM-09
110 mm

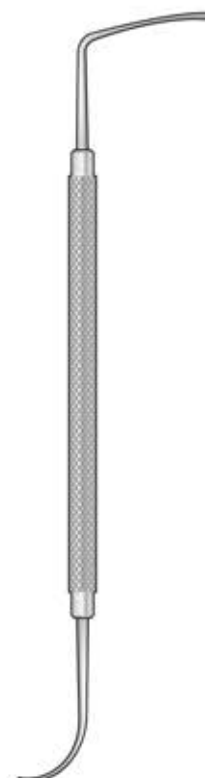

AMENABAR
NK-146

Markierungsgabel
Bi-Prong Marker
Forcelle per strabismo
Marcador bifurcado
Marquer Fourchette



NK-450
100 mm



FINK
NK-142
90 mm

Lidhalter - Lid Retractor
Retrattore palpebrale - Retractor de párpados
Releveur de paupières



KLAR EVATEUR
BT-09
160 mm



1/1

SCHEPENS
NK-143
155 mm



CONWAY
NK-144
140 mm



DESMARRES
NK-145
140 mm

Für Säuglinge
For infants
Per bambini
Pour enfants
Para niños

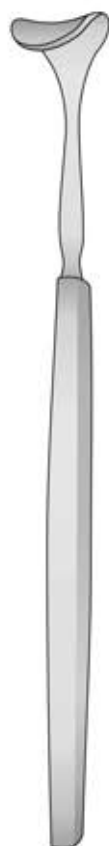

DESMARRES
BT-70/BT-79
140 mm



BT-70
140 mm



BT-72
140 mm



BT-74
140 mm



BT-77
160 mm



BT-71
140 mm



BT-73
140 mm



BT-75
140 mm



BT-79
140 mm

Strabismus Schlingen
Strabismus Loops
Anse da strabismo
Asas para estrabismo
Anses à strabisme

1,3 mm

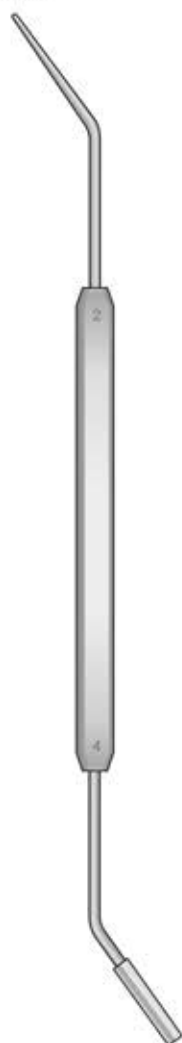

2,6 mm

NK-456 Fig. 2/4
150 mm

2,0 mm

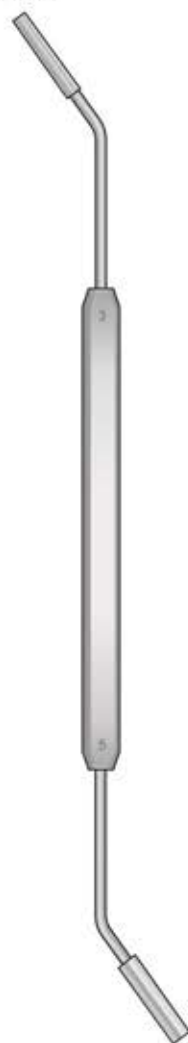

3,3 mm

NK-457 Fig. 3/5
150 mm

4,0 mm

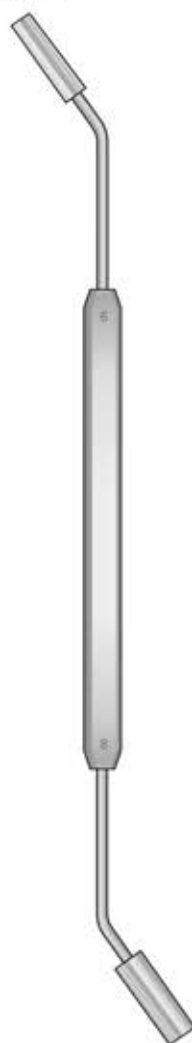

5,2 mm

NK-458 Fig. 6/8
150 mm

4,6 mm

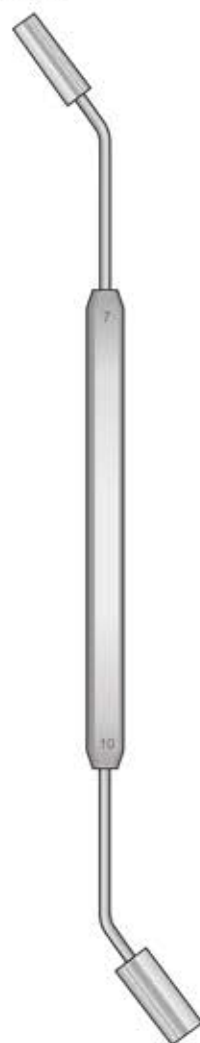

6,6 mm

NK-459 Fig. 7/10
150 mm

Scissors

Scheren

Ciseaux

Tijeras

Forbici

Tissue and Dressing Forceps

Chirurgische und Anatomische Pinzetten

Pinces à tissus et pansement

Pinzas quirúrgicas y anatómicas

Pinzette chirurgiche e anatomiche

Federschere - Capsulotomy Scissors
 Forbici per cataratta - Tijeras de catarata
 Ciseaux pour la cataracte



VANNAS
 FD-79/FD-81
 85 mm

Irispinzette - Iris Forceps
 Pinzetta da iride - Pinzas para iris
 Pincés pour l'iris



FD-119
 90 mm

Muskelpinzette - Muscle Forceps
 Pinze muscolari - Pinza muscular
 Pince musculaire

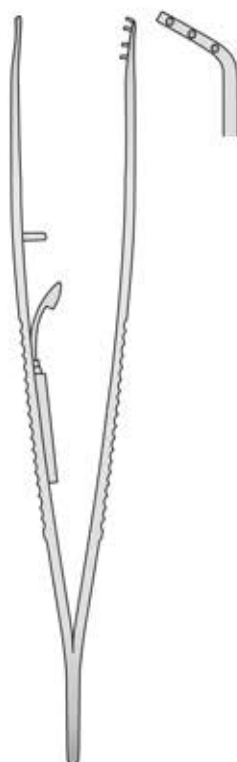

FD-120
 95 mm

Fadenpinzette - Suture Forceps
 Pinze per sutura - Pinzas para sutura
 Pincés à sutures



Mc PHERSON
 FD-123
 95 mm

Iridektomiescheren
 Iridectomy Scissors
 Forbici per iridectomia
 Tijeras para iridectomia
 Ciseaux à iridectomie

Stumpf - Spitz
 Blunt - Sharp
 Smussa - Acuta
 Romas - Agudas
 Musses - Pointus

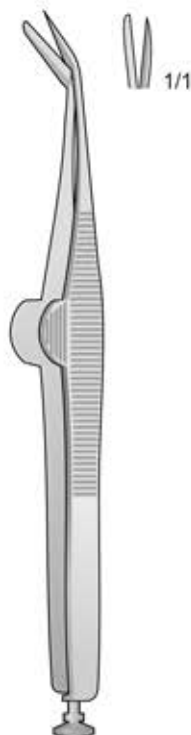

WECKER
 FD-231
 110 mm

Spitz - Stumpf
 Sharp - Blunt
 Acuta - Smussa
 Agudas - Romas
 Pointus - Musses

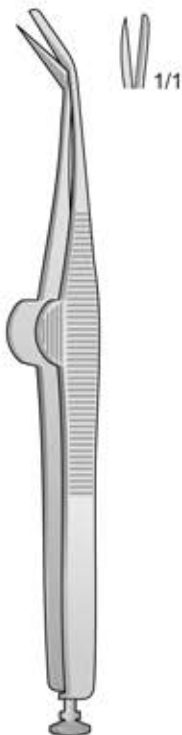

WECKER
 FD-232
 110 mm

Stumpf - Stumpf
 Blunt - Blunt
 Smussa - Smussa
 Romas - Romas
 Musses - Musses

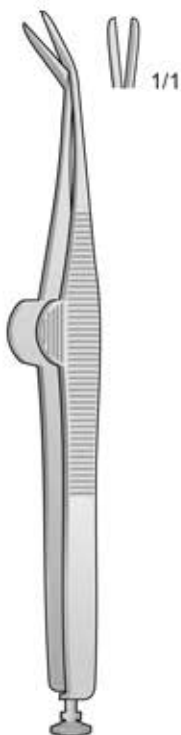

WECKER
 FD-233
 110 mm

Spitz - Spitz
 Sharp - Sharp
 Acuta - Acuta
 Agudas - Agudas
 Pointus - Pointus

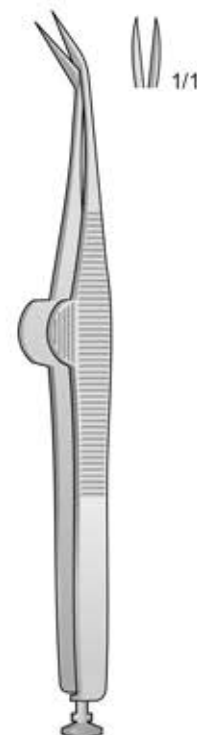

WECKER
 FD-234
 110 mm

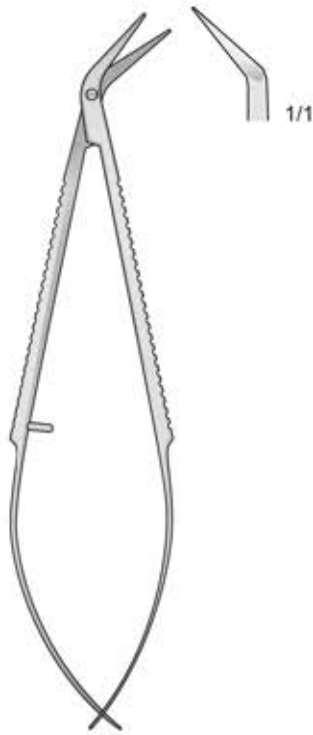

FD-03
110 mm



FD-04/FD-05
110 mm

Spitz - Sharp
Acuta - Agudas - Pointu



FD-04
110 mm



FD-05
110 mm



FD-55/FD-56
110 mm

Spitz - Sharp
Acuta - Agudas - Pointu

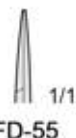

FD-55
110 mm



FD-56
110 mm



FD-49/FD-50
110 mm

Stumpf - Blunt
Smussa - Romas - Mousse



FD-49
110 mm



FD-50
110 mm



FD-41/FD-42
120 mm

Stumpf - Blunt
Smussa - Romas - Mousse



FD-41
120 mm



FD-42
120 mm

Hornhautscheren - Corneal Scissors
 Forbici corneali - Tijeras para córnea
 Ciseaux pour la cornée



TROUTMAN
 FD-69
 110 mm



TROUTMAN
 FD-70
 110 mm



CASTROVIEJO
 FD-66
 110 mm



CASTROVIEJO
 FD-67
 110 mm



CASTROVIEJO
 FD-68
 110 mm



FD-71/FD-72
 110 mm



FD-73/FD-74
 110 mm



FD-126/FD-127
110 mm



FD-124/FD-125
110 mm

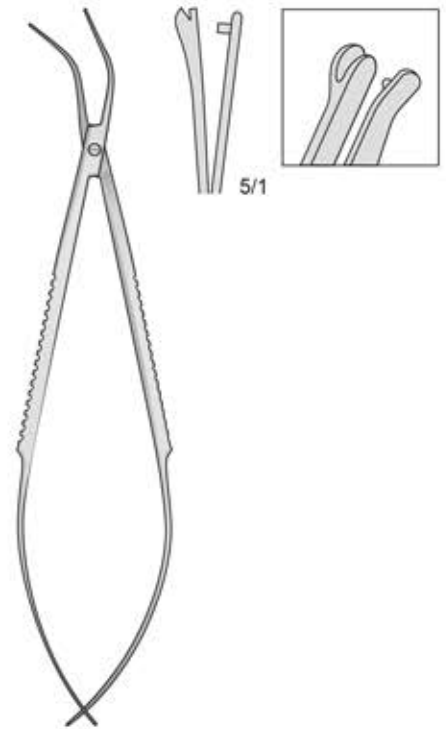

FD-130
110 mm

Linsenimplantation - Lens implantation - Pinze per impianto lenti
Implatación del cristalino - Pincés pour l'implantation

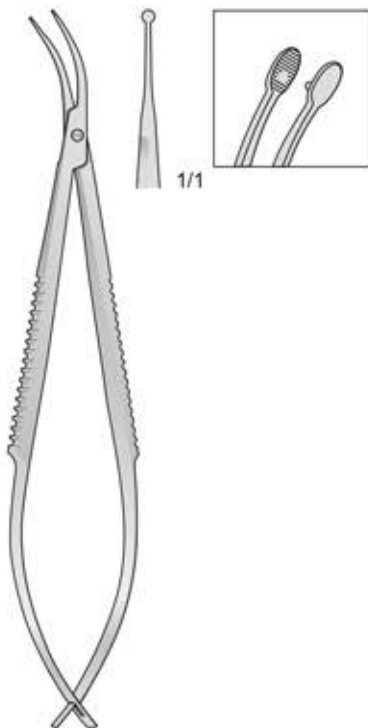

FD-132
110 mm

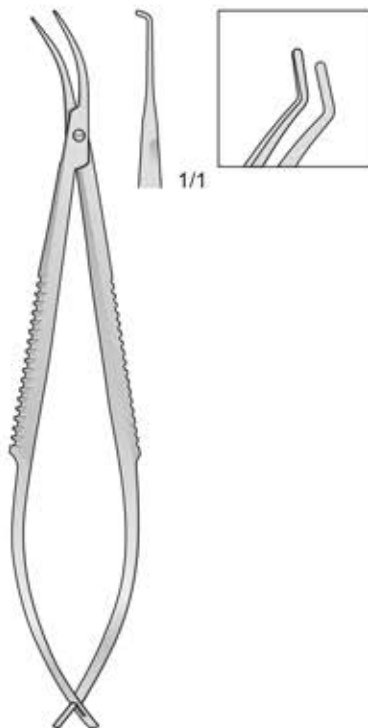

FD-134
110 mm

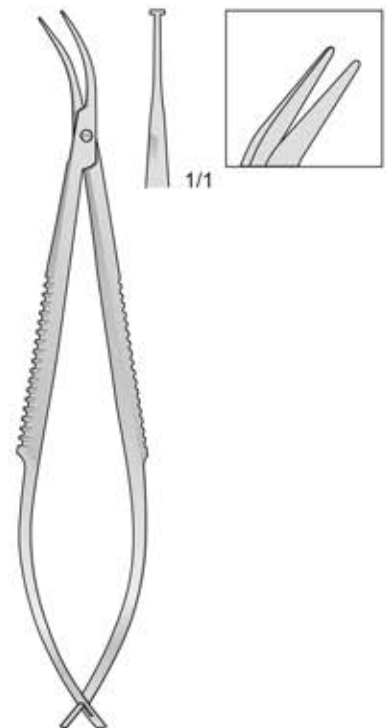

FD-136
110 mm

FD-146
110 mmFD-147
115 mm

FD-146/FD-147

FD-62
110 mmFD-11
110 mmFD-61
110 mmFD-40
150 mm

Spitz - Sharp - Acuta
Agudas - Pointu



NOYES
FD-10
120 mm

Spitz - Sharp - Acuta
Agudas - Pointu



NOYES
FD-12
120 mm

Spitz - Sharp - Acuta
Agudas - Pointu



WESTCOTT
FD-13
120 mm

Spitz - Sharp - Acuta
Agudas - Pointu



WESTCOTT
FD-15
120 mm

Stumpf - Blunt - Smussa
Romas - Mousse



WESTCOTT
FD-64
120 mm

Stumpf - Blunt - Smussa
Romas - Mousse



WESTCOTT
FD-65
120 mm

Spitz - Sharp - Acuta - Agudas - Pointu

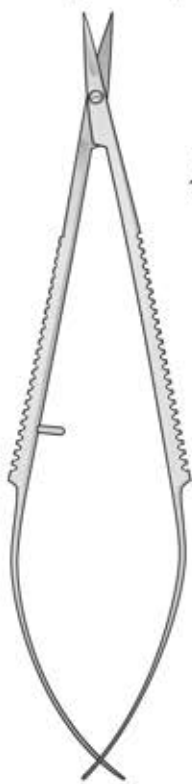

FD-01/FD-02
130 mm

Spitz - Sharp - Acuta - Agudas - Pointu

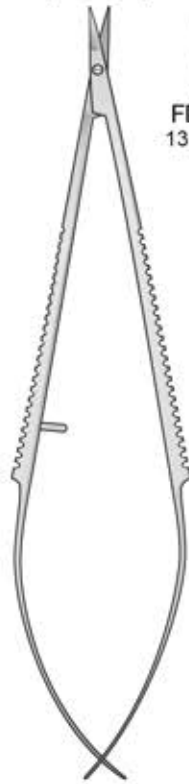

FD-57/FD-58
130 mm

Stumpf - Blunt - Smussa - Romas - Mousse

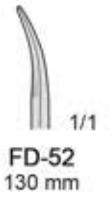

FD-51/FD-52
130 mm

Spitz - Sharp - Acuta - Agudas - Pointu

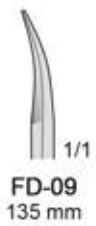
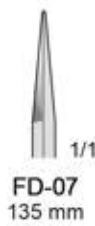

FD-07/FD-09
135 mm

Stumpf - Blunt - Smussa - Romas - Mousse



FD-43/FD-44
135 mm

Spitz - Sharp
Acuta - Agudas - Pointu



1/1

FD-59
160 mm



1/1

FD-60
160 mm

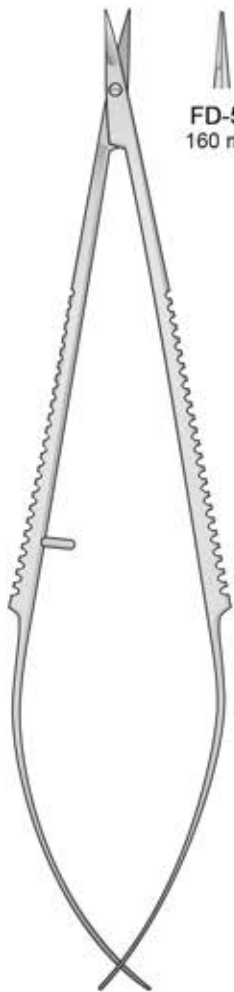

FD-59/FD-60
160 mm

Stumpf - Blunt
Smussa - Romas - Mousse



1/1

FD-53
160 mm



1/1

FD-54
160 mm

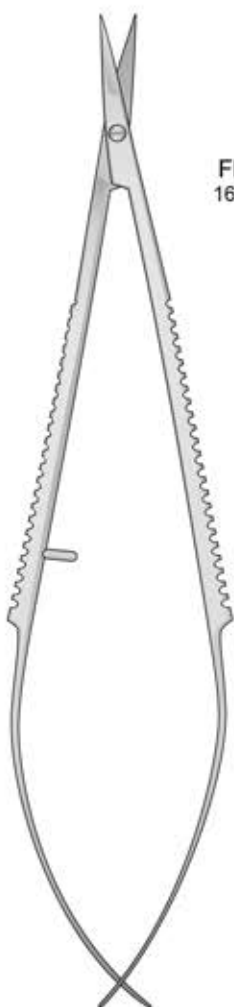

FD-53/FD-54
160 mm

Spitz - Sharp
Acuta - Agudas - Pointu



1/1

FD-47
160 mm



1/1

FD-48
160 mm



FD-47/FD-48
160 mm



 1/1
FD-137
150 mm

 1/1
FD-138
150 mm

FD-137/FD-138
150 mm

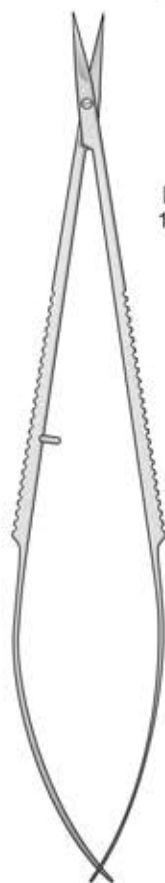

Spitz - Sharp
Acuta - Agudas - Pointu

 1/1
FD-06
160 mm

 1/1
FD-08
160 mm

FD-06/FD-08
160 mm



Stumpf - Blunt
Smussa - Romas - Mousse

 1/1
FD-45
160 mm

 1/1
FD-46
160 mm

FD-45/FD-46
160 mm

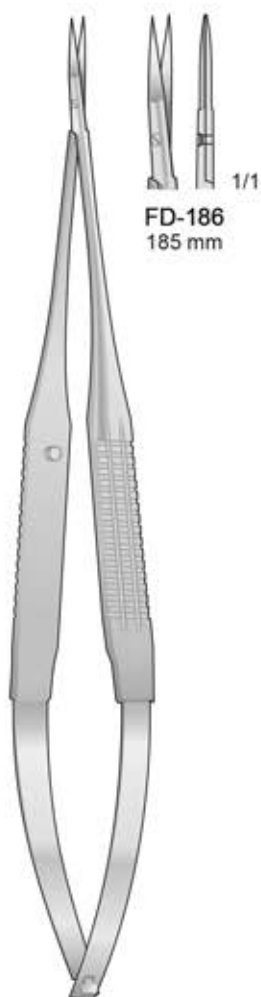

FD-186
185 mm

YASARGIL
FD-186
185 mm

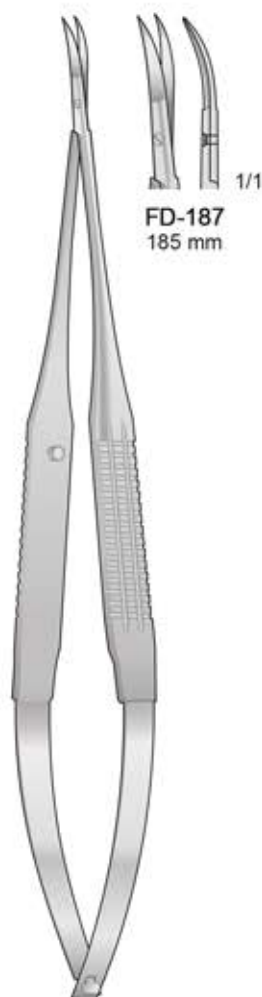

FD-187
185 mm

JACOBSON
FD-187
185 mm

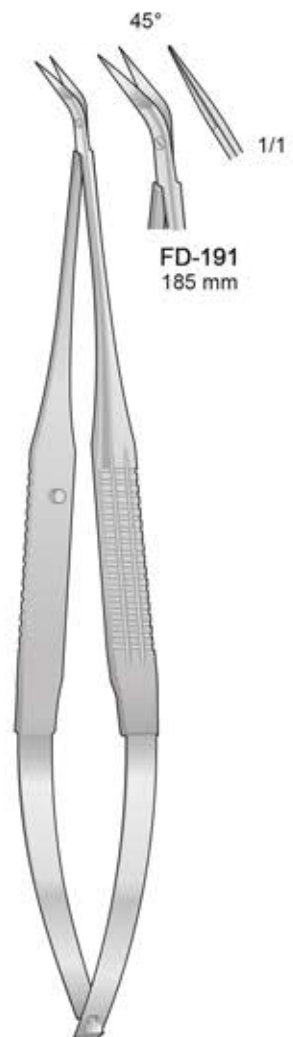

FD-191
185 mm

POTTS-YASARGIL
FD-191
185 mm

*** Ribbon type**

Mit großen Ringen
 With large rings
 Forbici ad anelli grandi
 Con anillos especialmente grandes
 avec larges anneaux

Irisscheren - Iris scissors
 Forbici per iridectomia - Tijeras para iridectomia
 Ciseaux à iridectomie

Blepharoplasty
 Blefaroplastica

Spitz - Sharp
 Acuta - Aguda
 Pointu

Spitz - Sharp
 Acuta - Aguda
 Pointu

Stumpf - Blunt
 Smussa - Romas
 Mousse

Spitz - Sharp
 Acuta - Aguda
 Pointu

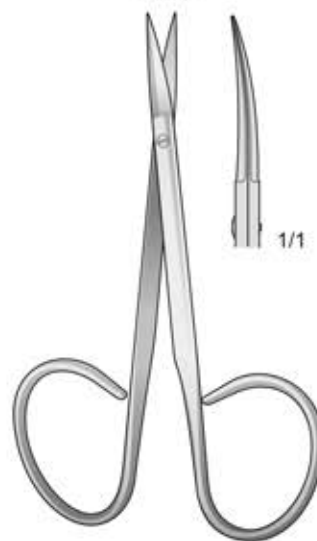
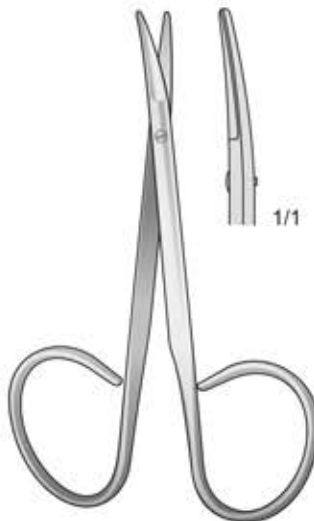
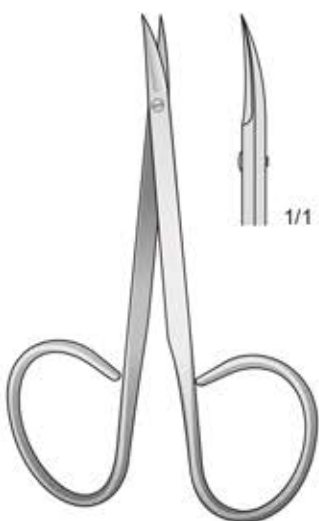
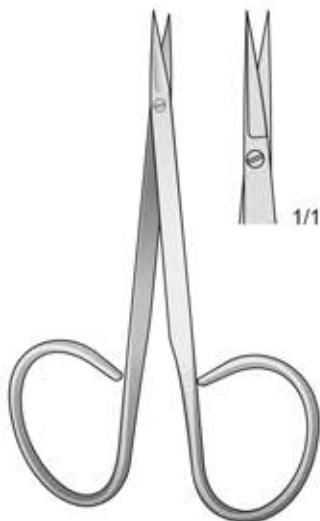

FG-200
95 mm

FG-201
95 mm

FG-202
95 mm

FG-203
105 mm

Strabismusscheren - Strabismus Scissors
 Forbici da strabismo - Tijeras para estrabismo
 Ciseaux à strabisme

Irisscheren - Iris scissors
 Forbici per iridectomia - Tijeras para iridectomia
 Ciseaux à iridectomie

Stumpf - Blunt
 Smussa - Romas
 Mousse

Stumpf - Blunt
 Smussa - Romas
 Mousse

Spitz - Sharp
 Acuta - Aguda
 Pointu

Spitz - Sharp
 Acuta - Aguda
 Pointu

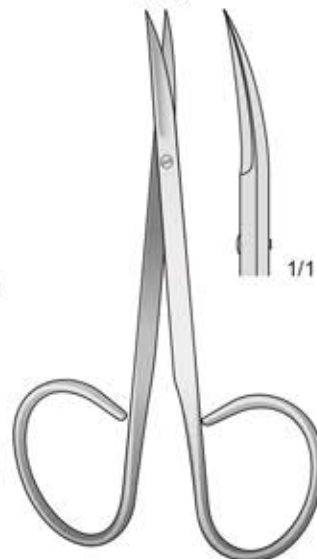
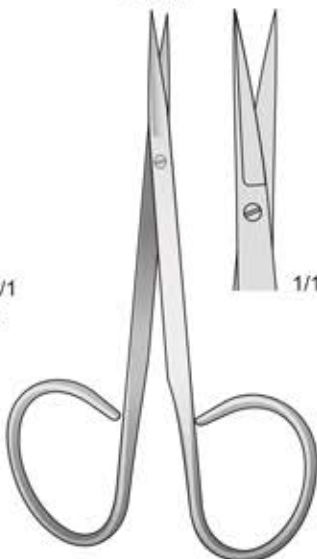
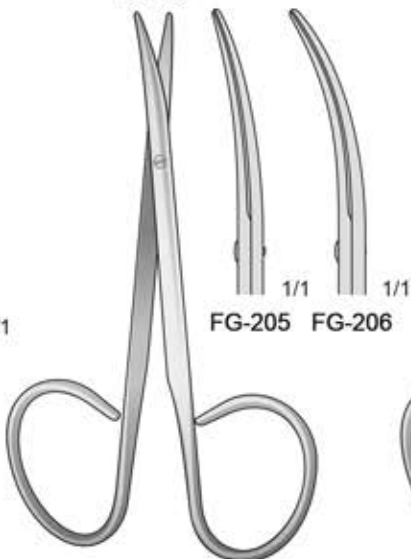
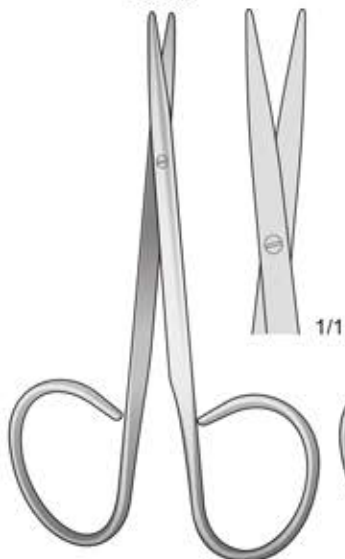

FG-204
100 mm

FG-205/FG-206
100 mm

FG-207
105 mm

FG-208
105 mm

"Ribbon type"

Mit großen Ringen
With large rings
Forbici ad anelli grandi
Con anillos especialmente grandes
avec larges anneaux

Spitz - Sharp
Acuta - Aguda
Pointu

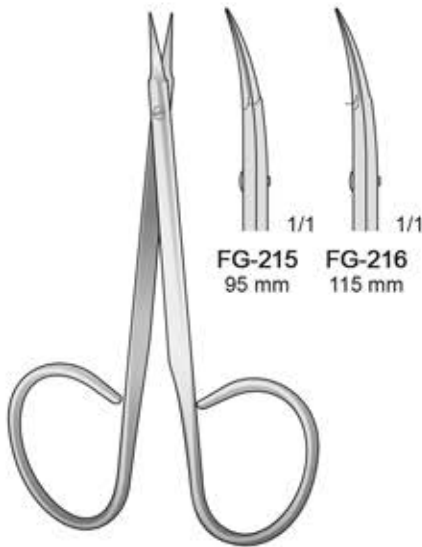

STITCH
FG-215/FG-216

Stumpf - Blunt
Smussa - Romas
Mousse

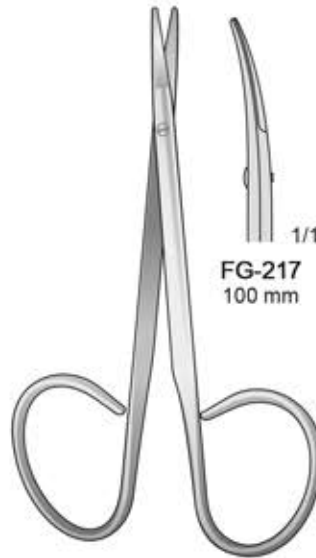

FG-217
100 mm

Gezahnt - Serrated
Dentellata - Dentadas
Dentelés

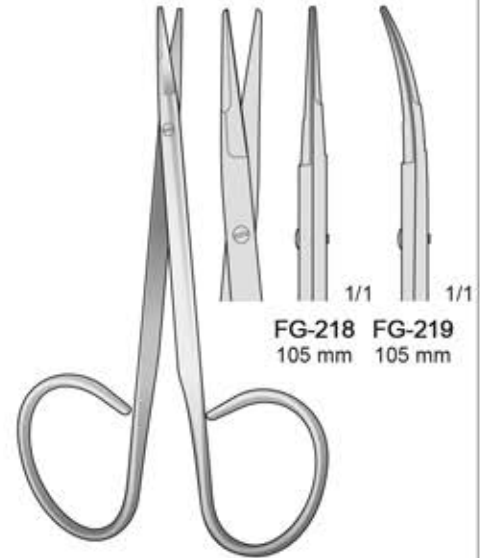

KAYE
FG-218/FG-219
105 mm

Sehnenscheren - Tenotomy Scissors
Forbici per tenotomia - Tijeras para tenotomia
Ciseaux à ténatomie

Stumpf - Blunt
Smussa - Romas
Mousse

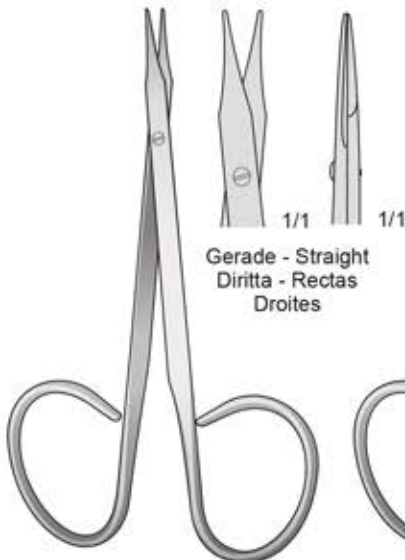

STEVENS
FG-209
100 mm

Stumpf - Blunt
Smussa - Romas
Mousse

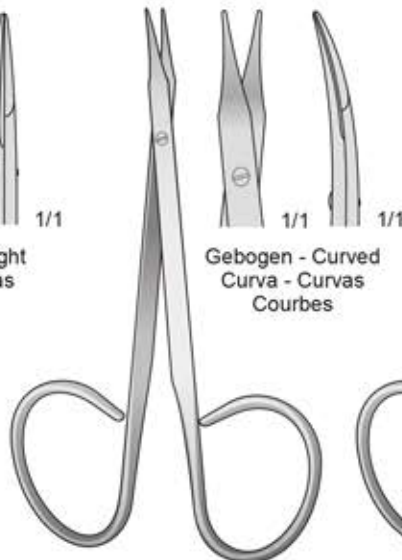

STEVENS
FG-210
100 mm

Spitz - Sharp
Acuta - Aguda
Pointu

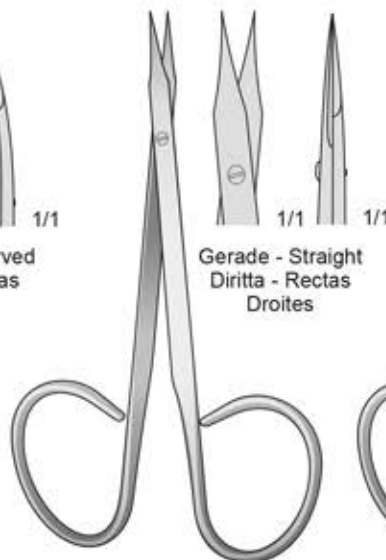

WALTON
FG-211
100 mm

Spitz - Sharp
Acuta - Aguda
Pointu

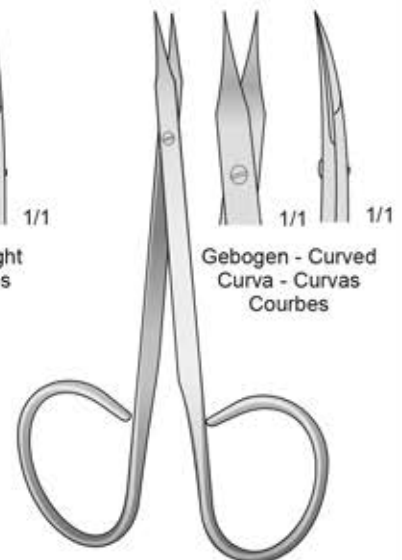

WALTON
FG-212
100 mm

Spitz - Pointed
Acuta - Agudas - Pointus

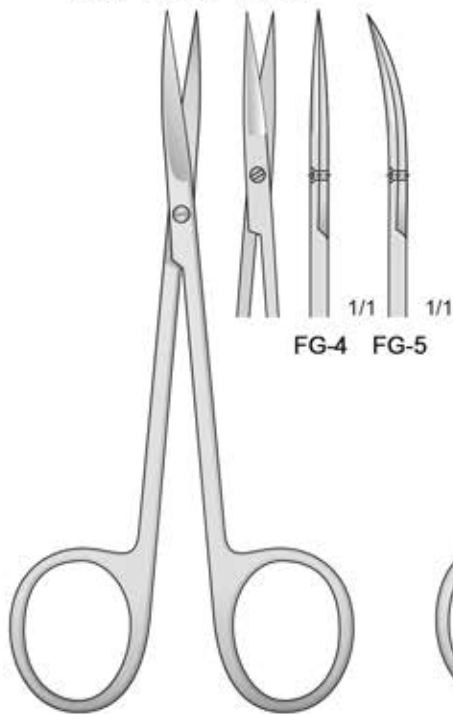

FG-4/FG-5
105 mm

Spitz
Pointed
Acuta
Agudas
Pointus

Gerade
Straight
Diritta
Rectas
Droits

Gebogen
Curved
Curve
Curvas
Courbes

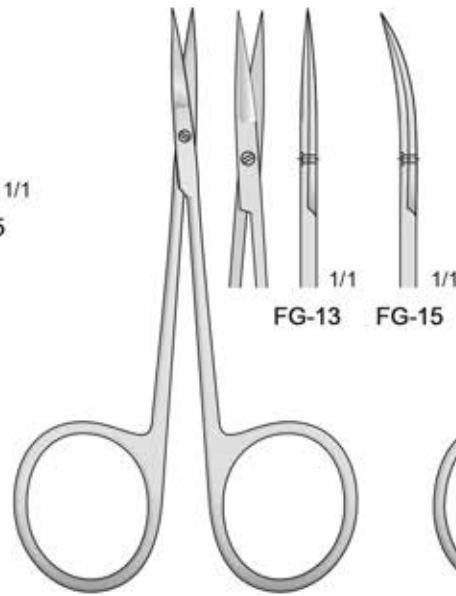

MICRO-IRIS
FG-13/FG-15
85 mm

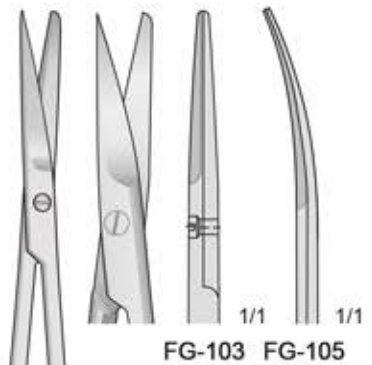

FG-103/FG-105
110 mm

Spitz - Pointed
Acuta - Agudas - Pointus

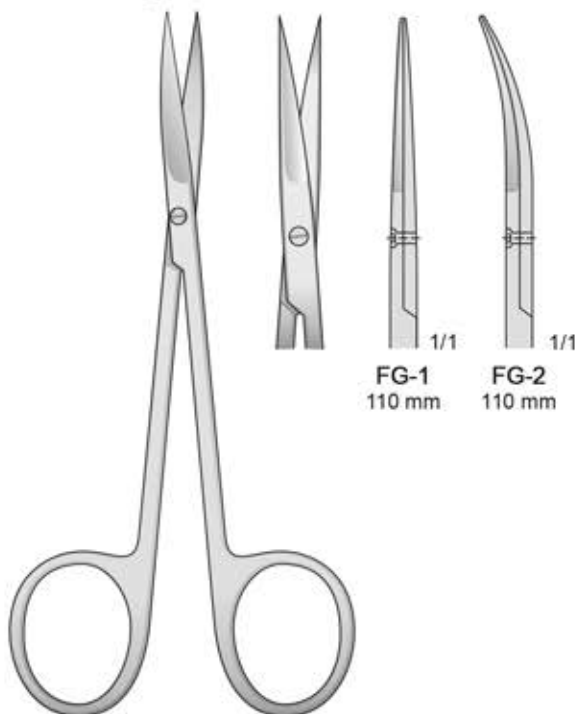

IRIS
FG-1/FG-2
110 mm

Stumpf - Blunt
Smussa - Romas - Mousse

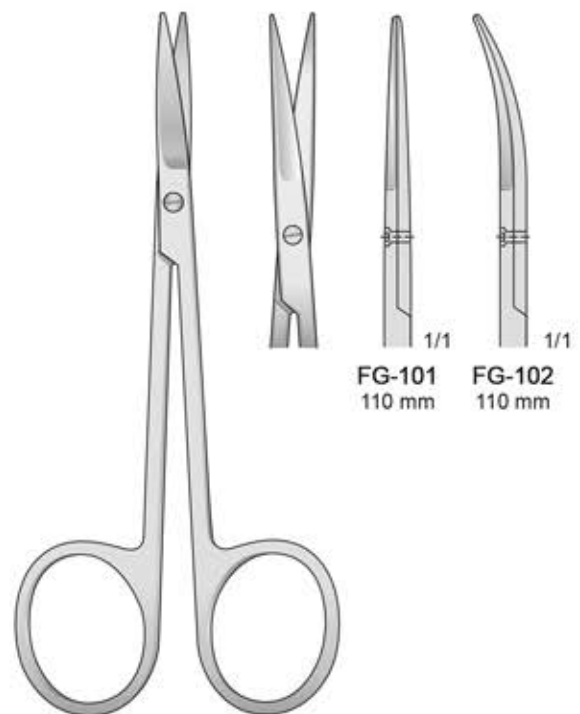

FG-101/FG-102
110 mm

Sehnenscheren - Tenotomy Scissors
 Forbici per tenotomia - Tijeras para tenotomia
 Ciseaux à ténonomie

Stumpf - Blunt
 Smussa - Romas - Mousse

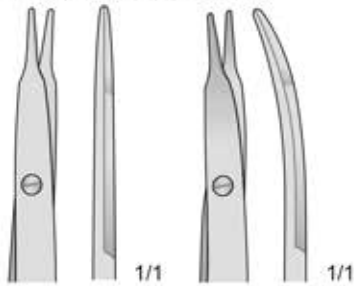

FG-50

FG-51

Spitz - Pointed
 Acuta - Agudas - Pointus

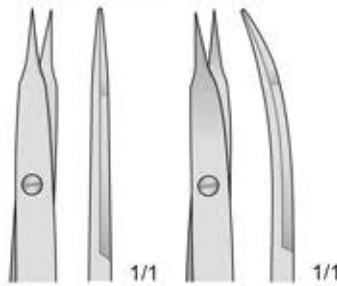

FG-52

FG-53

Forbici per sclerectomia



Gezahnt
 Serrated
 Dentellata
 Dentadas
 Dentelés

1/1

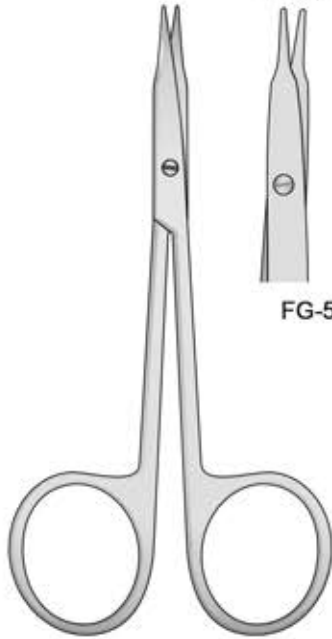

STEVENS
 FG-50/FG-53
 110 mm

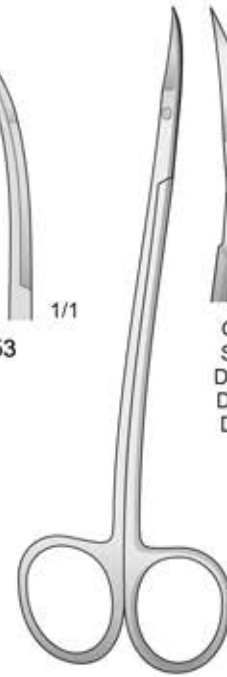

LA GRANGE
 LG-1
 115 mm

Stumpf - Blunt
 Smussa - Romas - Mousse

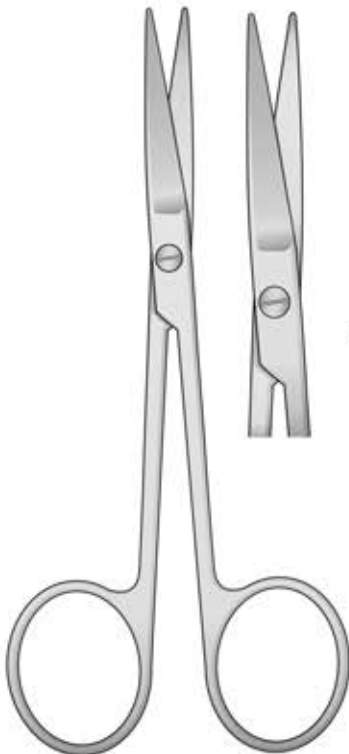

FG-21

FG-22

Spitz - Pointed
 Acuta - Agudas - Pointus

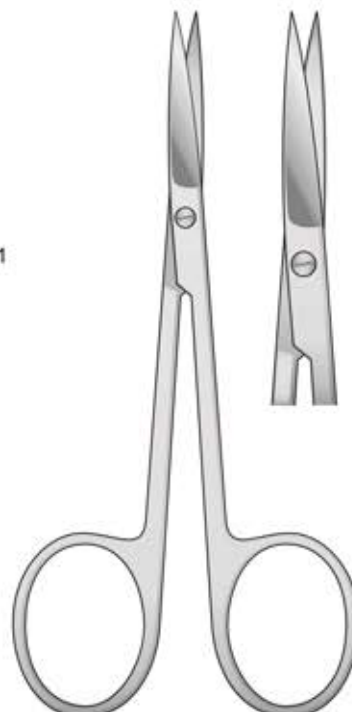

FG-23

FG-24

FG-21/FG-22
 115 mm

FG-23/FG-24
 110 mm

Conjunctival and utility Scissors

Stumpf
Blunt
Smussa
Romas
Mousse

Spitz
Sharp
Acuda
Aguda
Pointu

Enucleationsscheren - Enucleation Scissors
Forbice da enucleazione - Tijeras para enucleación
Ciseaux à énucléation

Leicht Gebogen
Medium Curved

Stark Gebogen
Strong Curved

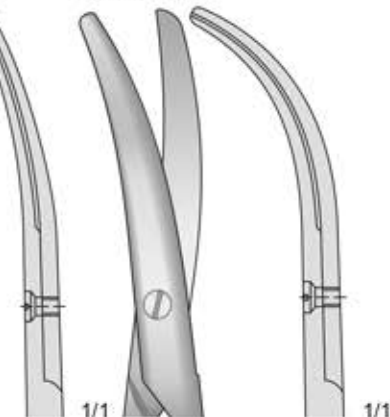
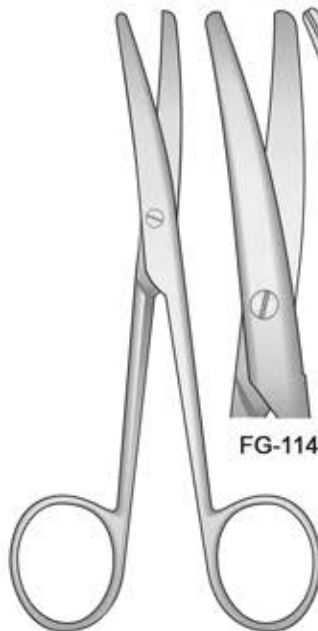
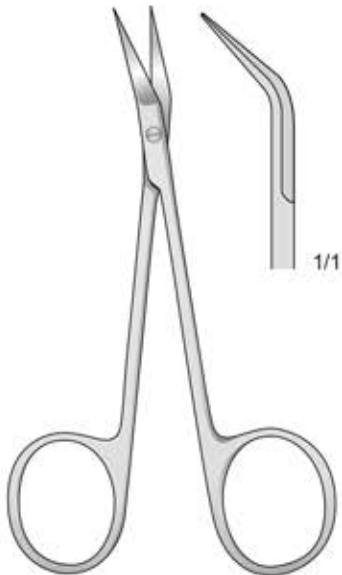
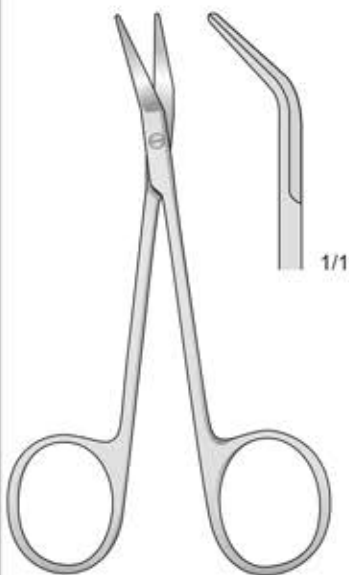

GRAEFE
FG-30
100 mm

WILMER
FG-122
105 mm

LANDOLT
FG-114/FG-115
120 mm

Ligaturescheren - Ligature Scissors
Forbici per legature - Tijeras para ligaduras
Ciseaux à ligatures

Stitch Scissors

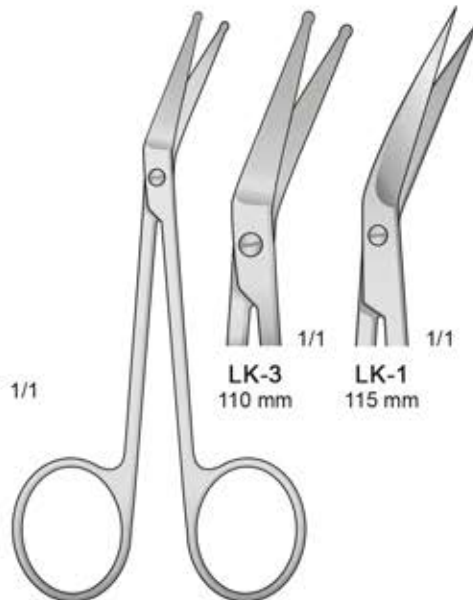
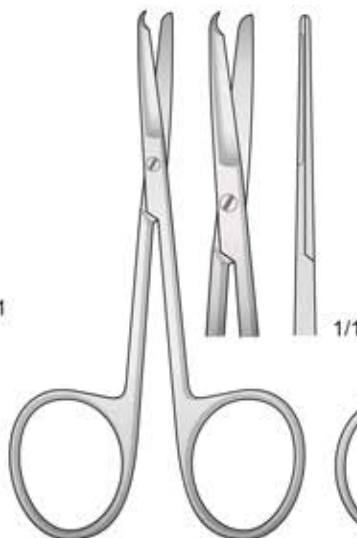
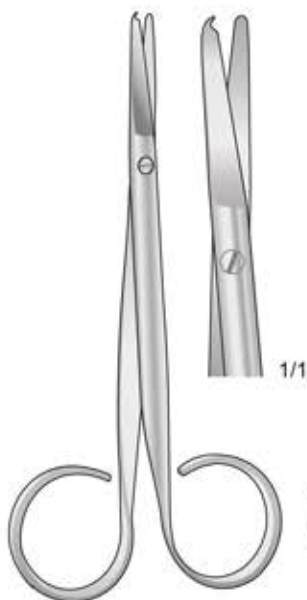

O'BRIEN
FG-151
95 mm

SPENCER
SC-1
110 mm

SPENCER
SC-9
90 mm

LOCKLIN MOD.
LK-1/LK-3

Strabismusscheren - Strabismus Scissors
 Forbici da strabismo - Tijeras para Estrabismo - Ciseaux à strabisme

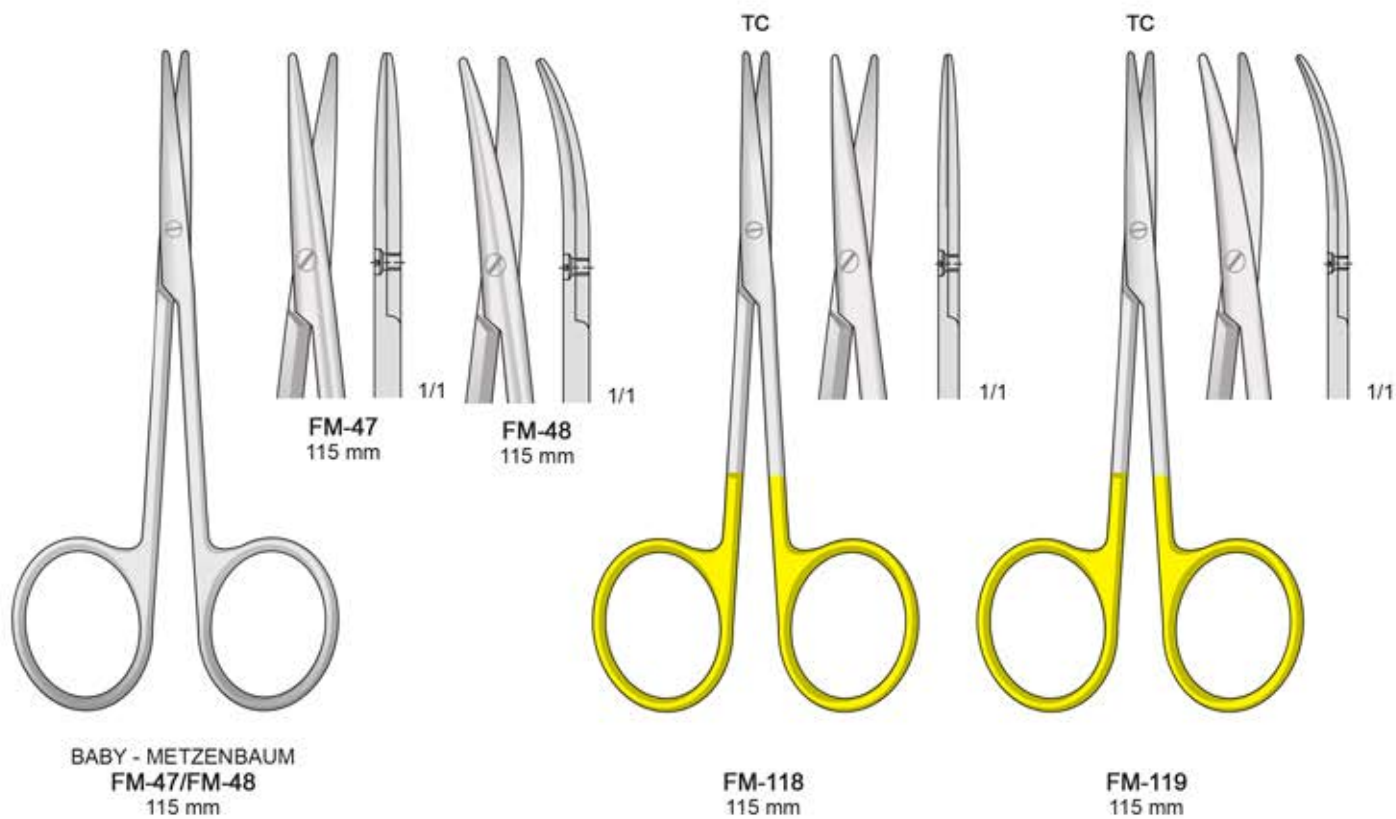

Chirurgische Scheren - Operating Scissors
 Forbici chirurgiche - Tijeras para cirugia - Ciseaux chirurgicaux

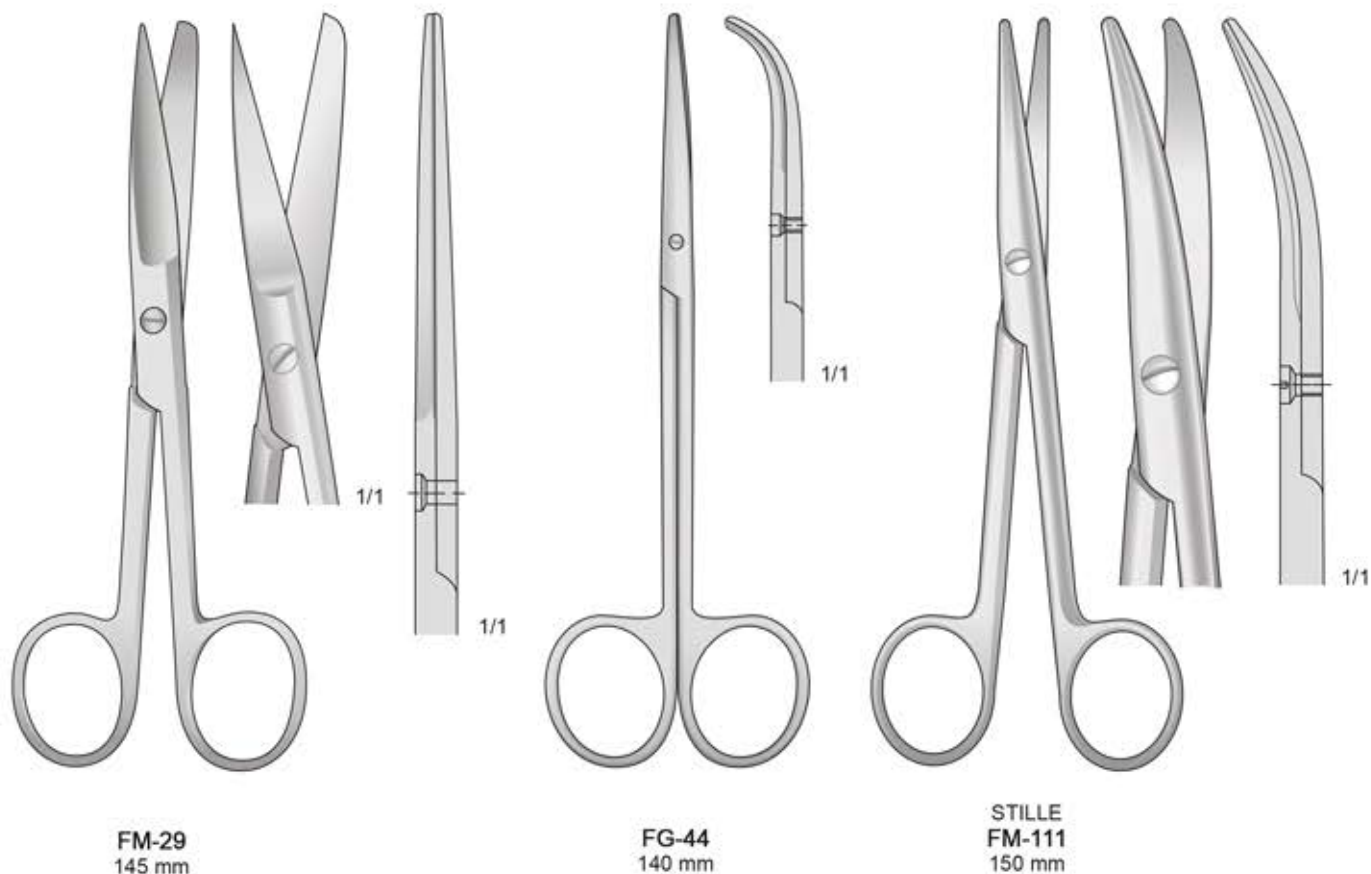

Scleral Fixation Forceps
1x2 curved teeth

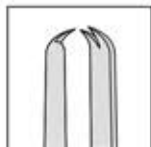

KUHNT
BD-255
110 mm

Scleral Fixation Forceps
1x2 angular teeth

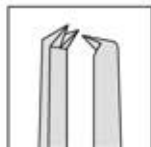

ELSCHNIG
BD-256 0,6 mm
BD-257 0,9 mm
105 mm

Scleral Fixation Forceps
1x2 curved teeth

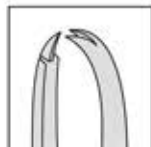

BRACKEN
BD-258 0,6 mm
105 mm

Corneal Fixation Forceps
1x2 curved teeth

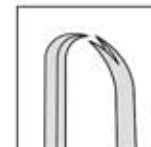

BRACKEN-FARKAS
BD-259 0,12 mm
105 mm

Fixation Forceps
Multiple Teeth

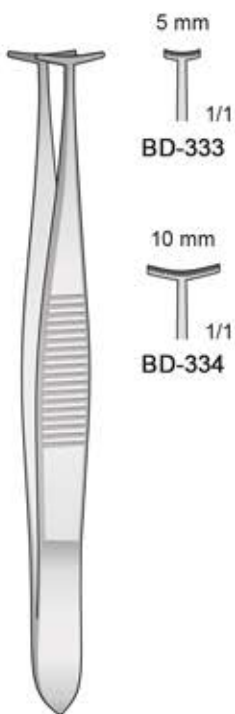

GREEN
BD-333/BD-334
100 mm

Fixierpinzetten
Fixation forceps
Pinze da Fissazione
Pinzas de fijación
Pinces à fixer



GRAEFE
BD-135
110 mm

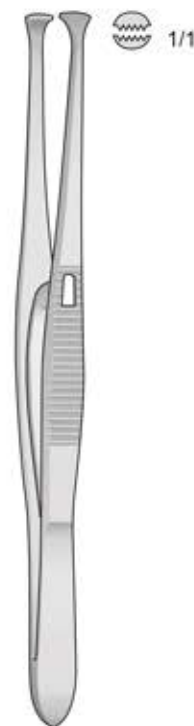

GRAEFE
BD-136
110 mm

Superior Rectus Forceps
with 1x2 heavy teeth

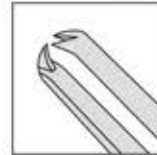

TROUTMAN
FD-118
95 mm

Superior Rectus Forceps
with 1x2 heavy teeth

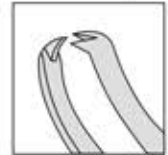

TENNANT-TROUTMAN
BD-189
107 mm

1,2 mm

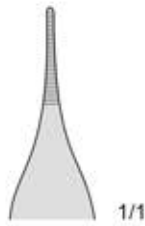

1/1

ADSON
BD-207
120 mm

1,2 mm

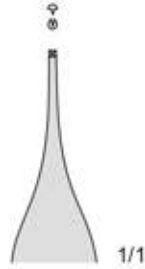
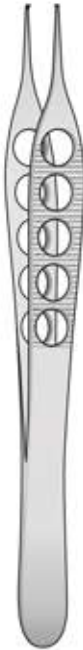

1/1

ADSON
BD-208
120 mm

7x7 denti



1/1

ADSON-BROWN
BD-209
120 mm

Tissue Forceps
1x2 Teeth



Tissue Forceps
1x2 Teeth of 0,5 mm

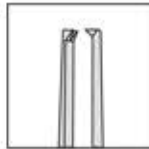

Tissue Forceps
1x2 Teeth of 1,0 mm

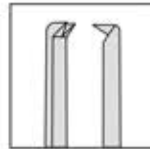

Tissue & Utility Forceps
1x2 Teeth of 1,5 mm

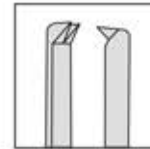

BISHOP-HARMON
MF-176 0,3 mm
MF-177 0,6 mm
85 mm



BD-35 Straight
BD-36 Curved
100 mm

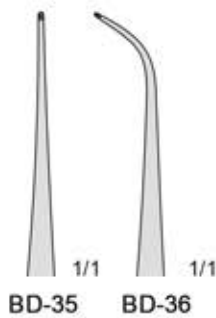

1/1

1/1

BD-35

BD-36



BD-42 Straight
BD-43 Curved
110 mm

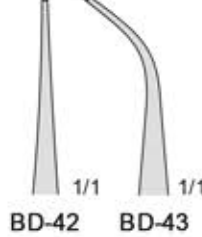

1/1

1/1

BD-42

BD-43



PERRY
BD-06
125 mm

Titan - Titanium - Titanio - Titane

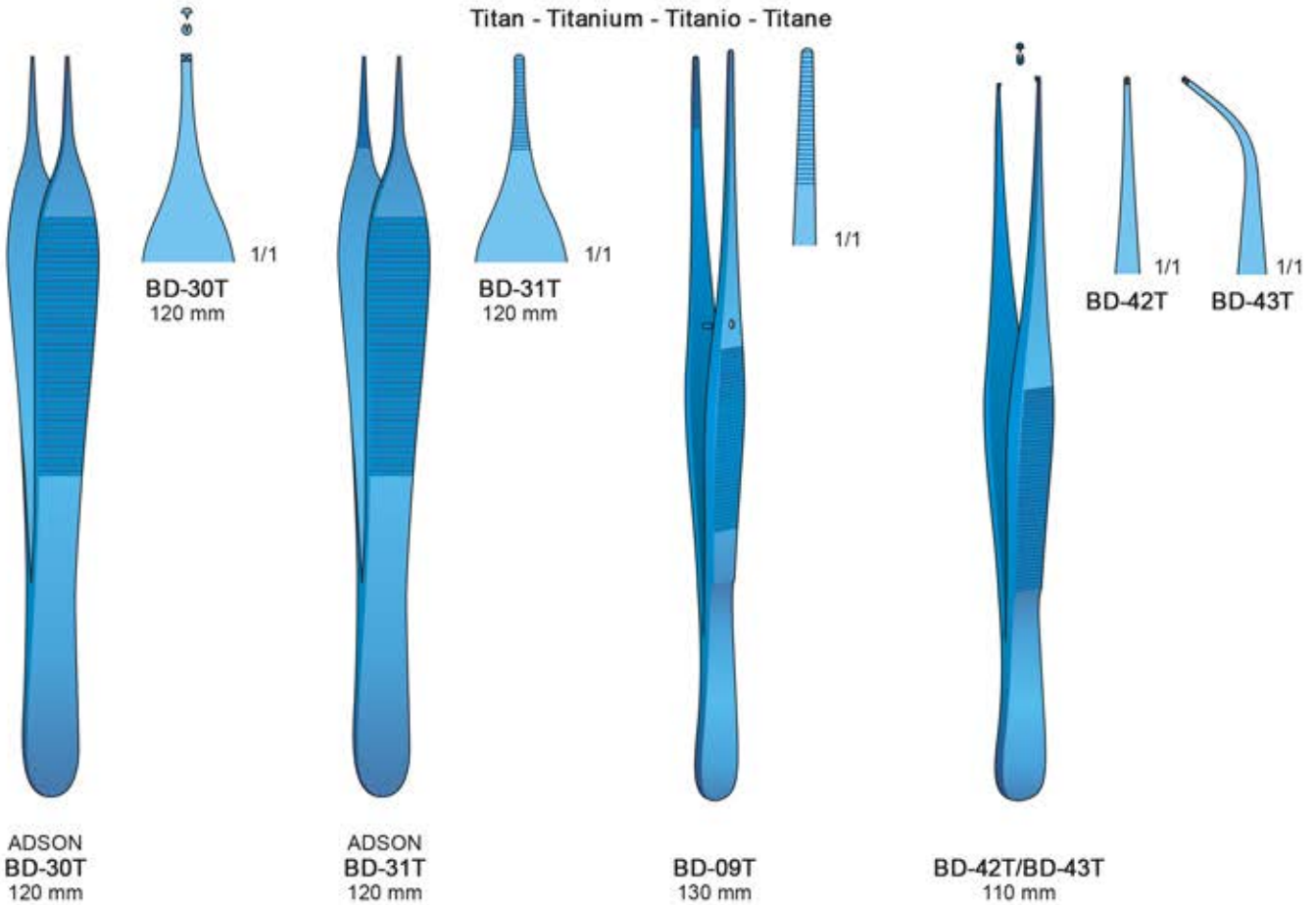

Iris Pinzetten - Iris Forceps - Pinze da iride - Pinza para iris - Pince à iris

Dressing Forceps
criss-cross serrated tips

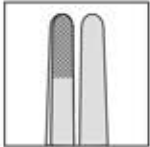

Dressing Forceps
serrated, 0,5 mm tips

Dressing Forceps
serrated, 1,0 mm tips

Dressing & Utility Forceps
serrated, 1,5 mm tips

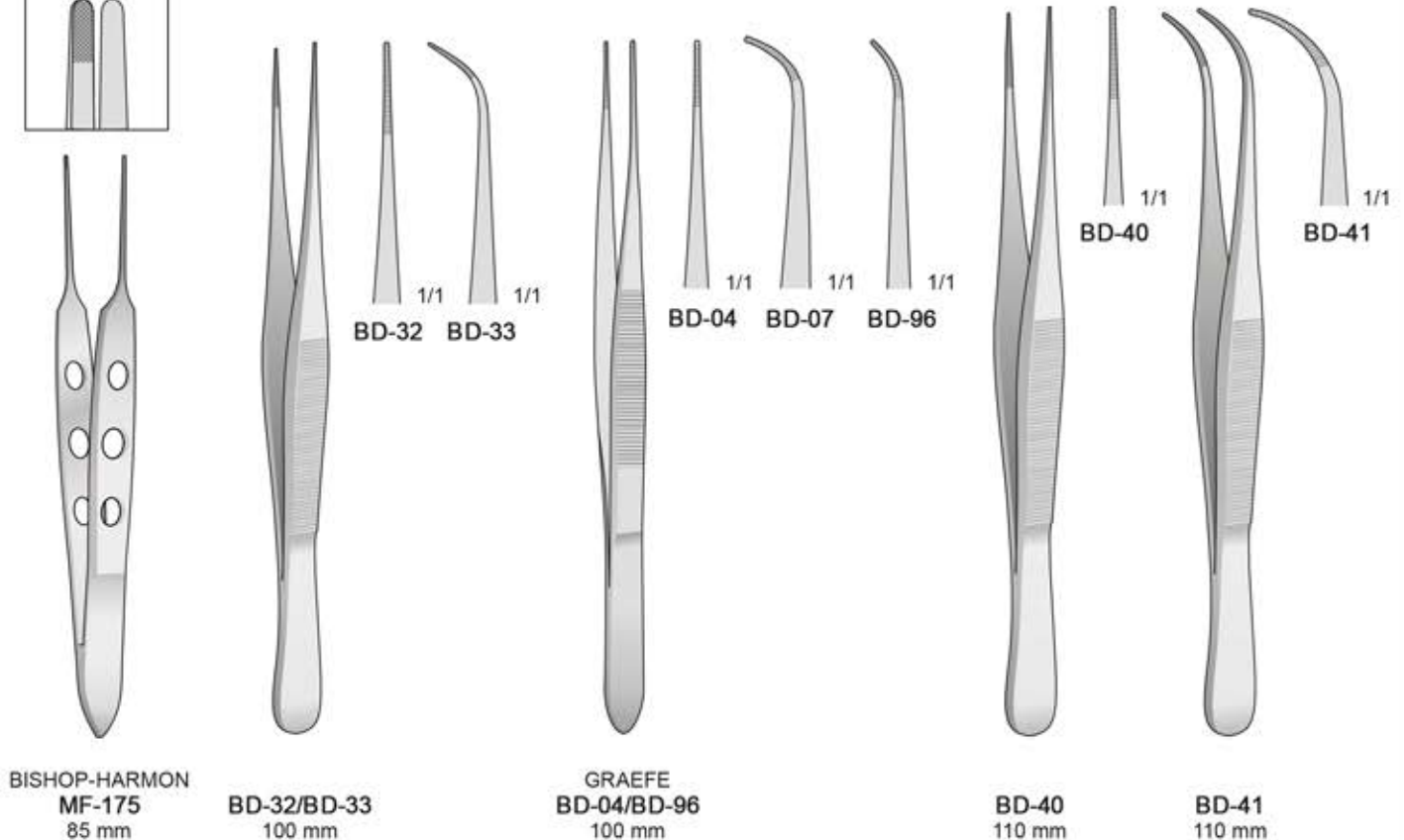



MF-150
Corneoscleral
Forceps
ultra fine 5 mm

Gerade
Straight
Diritta
Rectas
Droites



MF-151
Corneoscleral
Forceps
ultra fine 5 mm

Gebogen
Curved
Curva
Curvas
Courbes

MF-150/MF-151
100 mm

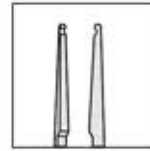

MF-152
Corneoscleral
Forceps
Pierce teeth of 0,1 mm

Gerade
Straight
Diritta
Rectas
Droites



MF-153
Corneoscleral
Forceps
Pierce teeth of 0,1 mm

Gebogen
Curved
Curva
Curvas
Courbes

MF-152/MF-153
100 mm



MF-154
Corneoscleral
Forceps
1x2 Teeth of 0,12 mm

Gerade, 45°
Straight, 45°
Diritta, 45°
Rectas, 45°
Droites, 45°



MF-155
Corneoscleral
Forceps
1x2 Teeth of 0,12 mm

Gebogen, 45°
Curved, 45°
Curva, 45°
Curvas, 45°
Courbes, 45°

MF-154/MF-155
100 mm

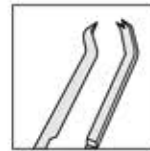

MF-156
Corneoscleral
Forceps
5 mm Long Platform
0,12 mm Teeth, 45°

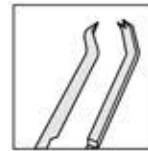

MF-157
Corneoscleral
Forceps
5 mm Long Platform
1x1 Pierce teeth, 0,1 mm

MF-156/MF-157
100 mm

Faden Pinzette, Nahtpinzetten, Fixierpinzetten
 Tying Forceps, Suturing Forceps, Fixation Forceps
 Pinzette da sutura, Pinzette serrafili, Pinzette da fissazione
 Pinzas para sutura, Pinzas da fijación
 Pinces à sutures, Pinces à monofilament, Pinces à fixer

Gerade
 Straight
 Diritta
 Rectas
 Droites



MF-158
 Corneal Tying
 Forceps
 extra fine 5 mm



MF-158
 85 mm

Gerade
 Straight
 Diritta
 Rectas
 Droites



MF-159
 Corneal Fixation
 Forceps
 1x1 Pierce teeth of 0,1 mm



MF-159
 85 mm

Gerade, 45°
 Straight, 45°
 Diritta, 45°
 Rectas, 45°
 Droites, 45°

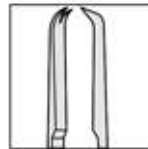

MF-160
 Corneal Suturing
 Forceps
 1x2 Teeth of 0,12 mm



MF-160
 85 mm

Gerade, 90°
 Straight, 90°
 Diritta, 90°
 Rectas, 90°
 Droites, 90°

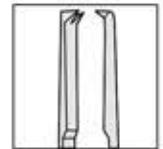

MF-161
 Corneal Utility
 Forceps
 1x2 Teeth of 0,12 mm



MF-161
 85 mm

Faden Pinzette, Nahtpinzetten, Fixierpinzetten
 Tying Forceps, Suturing Forceps, Fixation Forceps
 Pinzette da sutura, Pinzette serrafili, Pinzette da fissazione
 Pinzas para sutura, Pinzas da fijación
 Pinces à sutures, Pinces à monofilament, Pinces à fixer

Gebogen
 Curved
 Curva
 Curvas
 Courbes



MF-162
 Corneal Tying
 Forceps
 extra fine 5 mm



MF-162
 85 mm

Gebogen
 Curved
 Curva
 Curvas
 Courbes



MF-163
 Corneal Fixation
 Forceps
 1x1 Pierce teeth of 0,1 mm

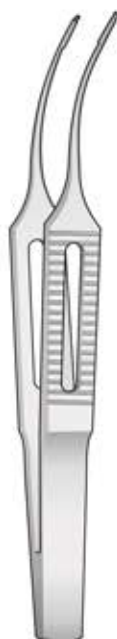

MF-163
 85 mm

Gebogen, 45°
 Curved, 45°
 Curva, 45°
 Curvas, 45°
 Courbes, 45°

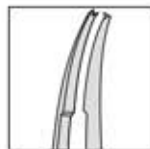

MF-164
 Corneal Suturing
 Forceps
 1x2 Teeth of 0,12 mm



MF-164
 85 mm

Gebogen, 90°
 Curved, 90°
 Curva, 90°
 Curvas, 90°
 Courbes, 90°

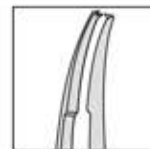

MF-165
 Corneal Utility
 Forceps
 1x2 Teeth of 0,12 mm

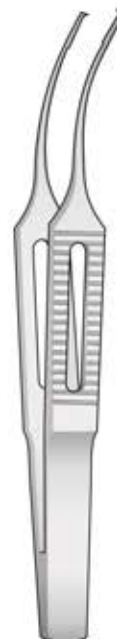

MF-165
 85 mm

Faden Pinzette, Nahtpinzetten, Fixierpinzetten
 Tying Forceps, Suturing Forceps, Fixation Forceps
 Pinzette da sutura, Pinzette serrafili, Pinzette da fissazione
 Pinzas para sutura, Pinzas da fijación
 Pinces à sutures, Pinces à monofilament, Pinces à fixer

Angled



MF-166
 Corneal Tying
 Forceps
 extra fine 7 mm



MF-166
 85 mm

Angled



MF-167
 Corneal Fixation
 Forceps
 1x1 Pierse teeth of 0,1 mm

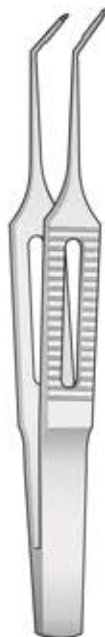

MF-167
 85 mm

Angled, 45°

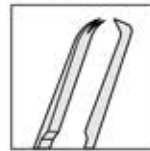

MF-168
 Corneal Suturing
 Forceps
 1x2 Teeth of 0,12 mm

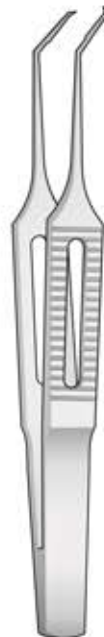

MF-168
 85 mm

Angled, 90°



MF-169
 Corneal Utility
 Forceps
 1x2 Teeth of 0,12 mm



MF-169
 85 mm

Corneal Forceps
extra fine 5 mm long jaws

Mit Fadenplatte
With tying platform
Con piano prendifilo
Con piattaforma
Avec plateaux pour monofil

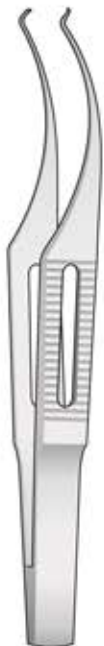

COLIBRI
MF-170 smooth tips, for tying
MF-171 pointed tips, for suture removal
83 mm

Corneal Fixation Forceps
1x1 Pierce teeth of 0.1 mm

Mit Fadenplatte
With tying platform
Con piano prendifilo
Con piattaforma
Avec plateaux pour monofil

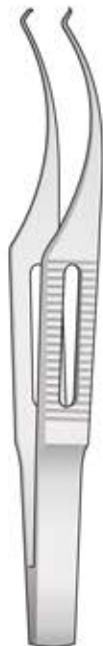

COLIBRI
MF-172
83 mm

Corneal Suturing Forceps
1x2 Teeth of 0.12 mm, 45°

Mit Fadenplatte
With tying platform
Con piano prendifilo
Con piattaforma
Avec plateaux pour monofil



COLIBRI
MF-173
83 mm

Corneal Utility Forceps
1x2 Teeth of 0.12 mm, 90°

Mit Fadenplatte
With tying platform
Con piano prendifilo
Con piattaforma
Avec plateaux pour monofil

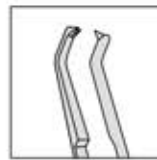

COLIBRI
MF-174
83 mm

Corneal Utility Forceps
1x2 teeth set at 90°, smooth

Ohne Fadenplatte
Jaws without platform
Senza piano prendifilo
Sin plataforma
Sans plateaux



BARRAQUER
NK-401
75 mm

Corneal Suturing Forceps
1x2 teeth set at 90°, smooth

Mit Fadenplatte
With tying platform
Con piano prendifilo
Con plataforma
Avec plateaux pour monofil



BARRAQUER
NK-403
75 mm

Corneal Fixation Forceps
1x2 teeth set at 45°, smooth

Ohne Fadenplatte
Jaws without platform
Senza piano prendifilo
Sin plataforma
Sans plateaux

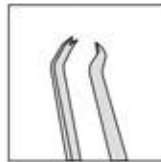

TROUTMAN
NK-405
75 mm

Corneal Suturing Forceps
1x2 teeth set at 45°, smooth

Mit Fadenplatte
With tying platform
Con piano prendifilo
Con plataforma
Avec plateaux pour monofil



TROUTMAN
NK-407
75 mm

Fixier Pinzetten
Fixation Forceps
Pinza da fissazione
Pinzas de fijación
Pince à fixer



B
NK-61 0,2 mm
NK-62 0,3 mm
NK-63 0,4 mm

PIERSE
NK-61/NK-63
80 mm



COLIBRI
NK-64
80 mm



COLIBRI
NK-65/NK-68
75 mm

A
NK-65 0,25 mm
NK-66 0,4 mm
NK-67 0,6 mm
NK-68 0,8 mm



COLIBRI
NK-69/NK-72
80 mm

A
NK-69 0,25 mm
NK-70 0,4 mm
NK-71 0,6 mm
NK-72 0,8 mm



COLIBRI
NK-60
80 mm

Hornhautpinzette
Corneal Forceps
Pinzette corneali
Pinzas para corneal
Pince à cornée

5/1

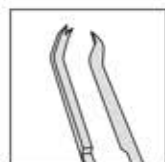

NK-73
70 mm



Polack double
Colibri style



POLACK
NK-410
70 mm



NK-87/NK-89
70 mm

L
NK-87 8 mm
NK-88 10 mm
NK-89 12 mm



NK-77/NK-78
70 mm

L
NK-77 8 mm
NK-78 10 mm

Irispinzetten
Iris Forceps
Pinzette da iride
Pinzas para iris
Pincas pour l'iris

Gezahnt
Serrated
Zigrinata
Dentadas
Dentelés

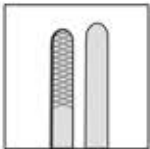

GRAEFE
MF-178 Straight
MF-179 Curved
65 mm

Irispinzetten
Iris Forceps
Pinzette da iride
Pinzas para iris
Pincas pour l'iris

1x2 Zähne
1x2 Teeth
1x2 Denti
1x2 Dientes
1x2 Dents

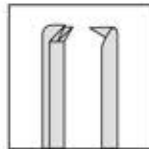

GRAEFE
MF-180 Straight
MF-181 Curved
65 mm

Irispinzetten
Iris Forceps
Pinzette da iride
Pinzas para iris
Pincas pour l'iris

Gebogen
Curved
Curva
Curvas
Courbes

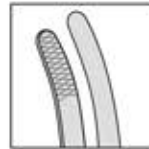

GILL
NK-412 Serrated
NK-413 1x2 Teeth
75 mm

Irispinzetten
Iris Forceps
Pinzette da iride
Pinzas para iris
Pincas pour l'iris

Doppelgebogen
Double Curved
Curva doppia
Curvas double
Double Courbes



BOTVIN
NK-414 Serrated
NK-415 1x2 Teeth
70 mm

Micro Iris Forceps
straight, ultra fine shanks
with 1x2 teeth, 0,12 mm

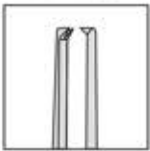

BONN
MF-182 75 mm
MF-183 95 mm

Micro Iris Forceps
angled 6 mm, ultra fine shanks
with 1x2 teeth, 0,12 mm



BONN
MF-184
72 mm

Micro Iris Forceps
straight, ultra fine shanks
with micro serrations

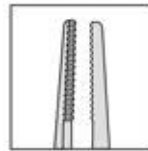

BONN
MF-185
73 mm

Micro Iris Forceps
angled 6 mm, ultra fine shanks
with micro serrations

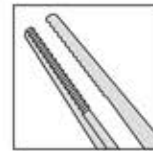

BONN
MF-186
72 mm

Conjunctival Fixation Forceps
straight, 0,6 mm teeth

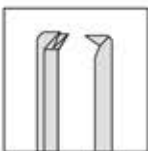

LESTER
MF-187 1x2 Teeth
MF-188 2x3 Teeth
95 mm

Conjunctival Fixation Forceps
2x3 teeth of 0,6 mm set at 90°
with tying platform

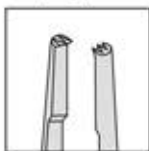

THORPE
MF-189
95 mm

Conjunctival Fixation Forceps
with 5 mm long tying platform,
cross serrated tips

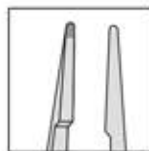

McGREGOR
MF-190
110 mm

Conjunctival Fixation Forceps
with longitudinally serrated jaws
and cross serrated tips

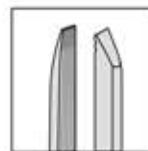

BONACCOLTO
BD-254
110 mm

Fixierpinzetten für Radiale Keratotomie
Radial Keratotomy Fixation Forceps
Pinze per cheratotomia radiale
Pinzas para queratomia radial
Pinces à fixer pour k eratotomie radiaire

Corneal Fixation Forceps
U-shaped,
3 mm spread,
0,12 mm Teeth at each tip



BORES
MF-191 Straight
MF-192 Angled
107 mm

Corneal Fixation Forceps
with lock, U-shaped,
8 mm spread,
0,12 mm Teeth at each tip

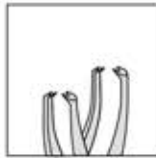

ARROWSMITH
MF-193 Straight
MF-194 Angled
107 mm

Corneal Fixation Forceps
with lock, U-shaped,
13 mm spread
0,12 mm Teeth at each tip

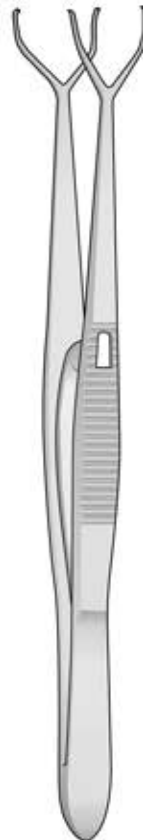
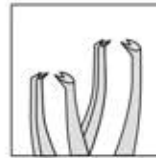

KREMER
MF-195 Straight
MF-196 Angled
107 mm

Incision Spreading Forceps,
with controlled jaw opening,
0,5 mm square tips
w/micro serrations

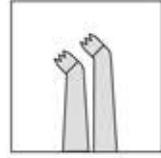

BORES
MF-197
110 mm

Micro pinzette con solo
piano prendifilo

Pinzetta serrafili con solo
piano prendifilo fine

Tying Forceps (short model)
ultra fine 5 mm long platform
for 9-0 to 11-0 sutures



BONN
MF-198
73 mm

Tying Forceps (Type M-2)
extra fine 6 mm long platform
for 8-0 to 11-0 sutures

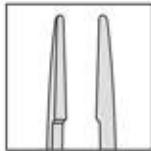

MICRO
MF-199
85 mm

Tying Forceps
delicate 5 mm long platform
for 7-0 to 9-0 sutures

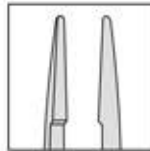

St.MARTIN
MF-200
85 mm

Tying & Utility Forceps
standard 7 mm long platform
for sutures below 7-0

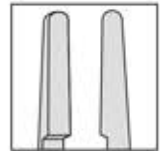

PAUFIQUE
MF-201
88 mm

Mit Fadenplatte ohne Zähne
 With platform without teeth
 Con piano prendifilo, senza denti
 Con mini placas sin dientes
 Avec plateaux pour fils, sans dents

Straight Tying Forceps
 with ultra fine 6 mm long platform
 for 9-0 to 11-0 sutures
 with guide pin

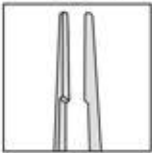

TENNANT
 MF-239
 110 mm

Curved Tying Forceps
 with ultra fine 6 mm long platform
 for 9-0 to 11-0 sutures
 with guide pin



TENNANT
 MF-240
 110 mm

Angled Tying Forceps
 with ultra fine 8 mm long platform
 for 9-0 to 11-0 sutures
 with guide pin

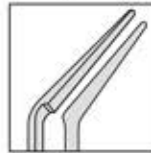

KELMANN-McPHERSON
 MF-241
 110 mm

Fragment Forceps
 ultra thin, angled 11 mm
 smooth jaws
 with guide pin

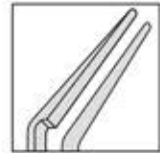

GASKIN
 MF-242
 110 mm

Hornhautpinzette
 Corneal Forceps
 Pinze corneali
 Pinzas para córnea
 Pinces à cornée

Mit Fadenplatte, mit 1x2 Zähnen
 With tying platform, with 1x2 teeth
 Con piano prendifilo, con 1x2 denti
 Con mini placas, con 1x2 dientes
 Avec plateaux pour fils, avec 1x2 dents

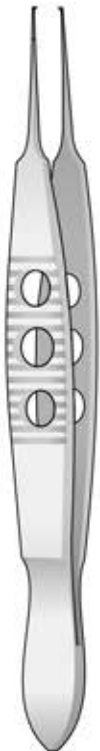

MC PHERSON
 MF-235
 105 mm

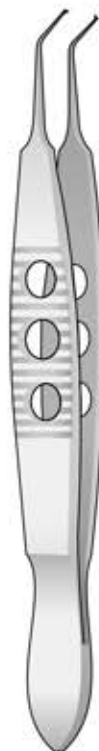
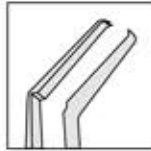

MC PHERSON
 MF-236
 105 mm

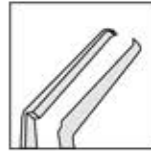

KELMANN - MC PHERSON
 MF-237
 105 mm

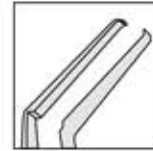

HOFFER - MC PHERSON
 MF-238
 105 mm

Mit Fadenplatte ohne Zähne
With platform without teeth
Con piano prendifilo, senza denti
Con mini placas sin dientes
Avec plateaux pour fils, sans dents

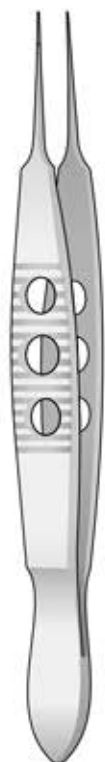

MC PHERSON
MF-231
105 mm

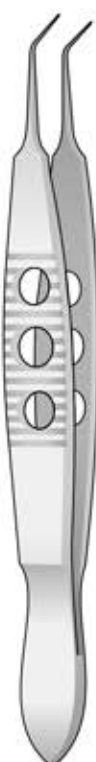
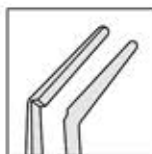

MC PHERSON
MF-232
105 mm

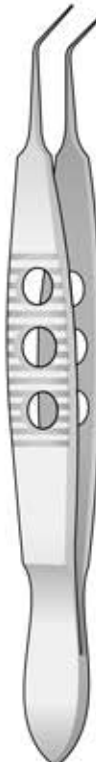

KELMANN - MC PHERSON
MF-233
105 mm

Nahtpinzetten mit Fadenplatte, 1x2 Zähne
 Suturing Forceps with Tying Platform, 1x2 Teeth
 Pinzette da sutura con piano prendifilo, 1x2 Denti
 Pinzas para sutura con mini placas, 1x2 Dientes
 Pinces à sutures avec plateaux pour fils, 1x2 Dents

MF-225 0,12 mm
 MF-226 0,30 mm
 MF-227 0,50 mm

Suturing Forceps (on wide handle)
 1x2 teeth set at 45°, with straight tying platform

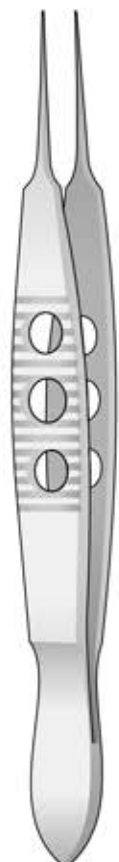
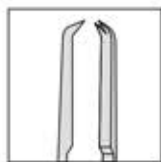

CASTROVIEJO
 MF-225/MF-227
 110 mm

Suturing Forceps
 1x2 teeth of 0,12 mm set at 45°, with tying platform and guide pin

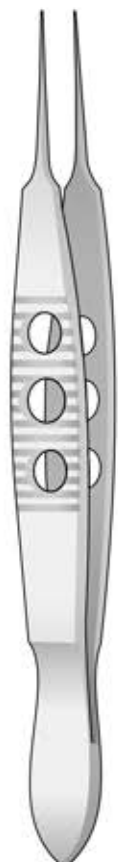
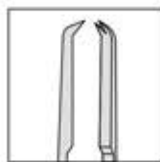

SNIDER-CASTROVIEJO
 MF-228
 110 mm

Suturing Forceps
 1x2 teeth of 0,12 mm set at 90°, very delicate platform

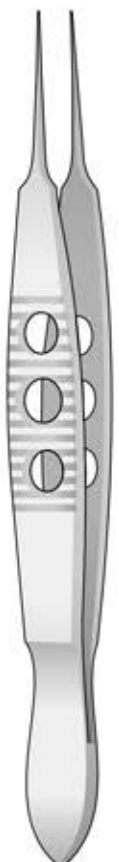
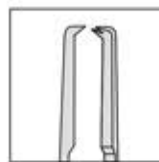

JAFFE
 MF-229
 110 mm

Suturing Forceps
 1x2 teeth of 0,12 mm set at 90°, extra delicate platform

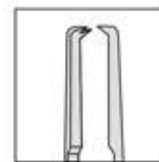

TENNANT
 MF-230
 100 mm

Fadenpinzette ohne Zähne
Tying Forceps without Teeth
Pinzetta da sutura senza denti
Pinza para sutura sin dientes
Pince à sutures sans dents

extra delicate 7 mm long platform
for 8-0 to 11-0 sutures

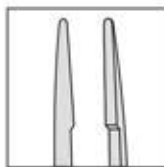

Nahtpinzette mit Fadenplatte
Suturing Forceps with Tying platform
Pinza da sutura con piatto prendifilo
Pinza para sutura con mini-placas
Pince à sutures avec plateaux pour fils

extra delicate 6 mm long platform
for 9-0 to 11-0 sutures

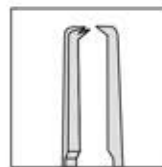

1x2 Zähne
1x2 Teeth
1x2 Denti
1x2 Dientes
1x2 Dents

Strabismuspinzette
Strabismus Forceps
Pinza da strabismo
Pinza para estrabismo
Pince à strabisme



MF-100
110 mm

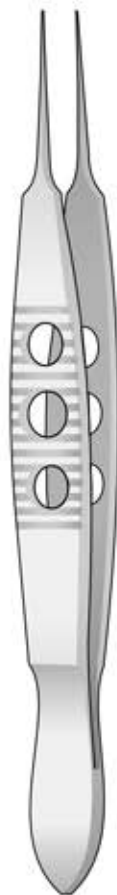

JAFFE
MF-221 Straight
MF-222 Curved
110 mm



TENNANT
MF-223 Straight
MF-224 Curved
100 mm

1x2 Zähnen mit Fadenplatte
 1x2 Teeth with platform
 1x2 Denti con piano prendifilo
 1x2 Dientes con mini-placas
 1x2 Dents avec plateaux pour fils

MF-214 0,12 mm
 MF-215 0,30 mm
 MF-216 0,50 mm
 MF-217 0,90 mm

Suturing Forceps (long model)
 1x2 teeth of 0,12 mm set at 90°,
 with ultra fine platform

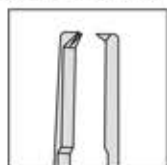

BONN
MF-213
 95 mm

Suturing Forceps (standard handle)
 1x2 teeth set at 45°,
 with straight tying platform

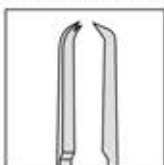

CASTROVIEJO
MF-214/MF-217
 100 mm

Suturing Forceps (standard handle)
 1x2 teeth set at 45°,
 with angled tying platform

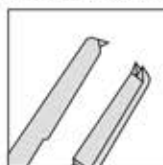

CASTROVIEJO
MF-218 0.30 mm
MF-219 0.50 mm
 100 mm

Suturing Forceps
 1x2 teeth of 0,12 mm set at 90°,
 with extra fine platform

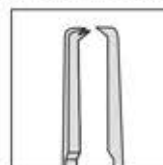

TROUTMAN
MF-220
 100 mm

Tying Forceps (long model)
ultra fine 5 mm long platform
for 9-0 to 11-0 sutures



BONN
MF-207
95 mm

Tying Forceps
delicate 6 mm long platform
for 7-0 to 9-0 sutures

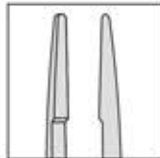

HARMS
MF-208 Straight
MF-209 Curved
100 mm

Tying Forceps
delicate 7 mm angled platform
for 7-0 to 9-0 sutures



HARMS
MF-210
100 mm

Tying Forceps
extra fine 6 mm long platform,
for 8-0 to 11-0 sutures

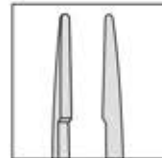

TROUTMAN
MF-211 Straight
MF-212 Curved
100 mm

Nahtpinzetten mit Fadenplatte 1x2 Zähnen
 Suturing Forceps with Tying platform 1x2 Teeth
 Pinzette da sutura con piano prendifilo 1x2 Denti
 Pinzas para sutura con mini-placas 1x2 Dientes
 Pinces à sutures avec plateaux pour fils 1x2 Dents

Suturing Forceps (short model)
 1x2 teeth of 0,12 mm set at 90°
 with ultra fine platform

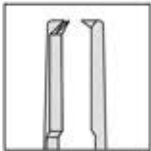

BONN
MF-202
 73 mm

Suturing Forceps (M-types)
 1x2 teeth set at 45°
 with extra fine platform

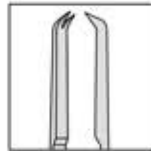

MICRO
MF-203 0,12 mm
MF-204 0,30 mm
 85 mm

Suturing Forceps
 1x2 teeth of 0,3 mm set at 45°
 with delicate platform

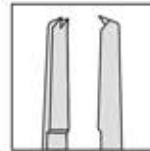

St. MARTIN
MF-205
 85 mm

Allzweck Pinzette
 mit Fadenplatte
 Universal Suturing Forceps
 1x2 teeth of 0,7 mm set at 45°
 with heavy platform

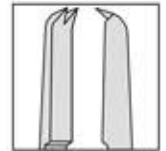

PAUFIQUE
MF-206
 88 mm

1x2 Zähne
1x2 Teeth
1x2 Denti
1x2 Dientes
1x2 Dents

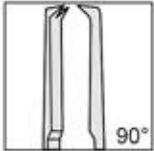

BONN
MF-243 85 mm
MF-244 110 mm

1x2 Zähne
1x2 Teeth
1x2 Denti
1x2 Dientes
1x2 Dents

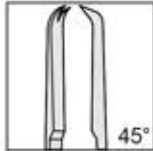

CASTROVIEJO
MF-245
110 mm

1x2 Zähne
1x2 Teeth
1x2 Denti
1x2 Dientes
1x2 Dents

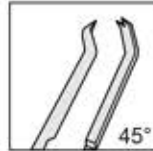

TROUTMAN
MF-246
110 mm

1x2 Zähne
1x2 Teeth
1x2 Denti
1x2 Dientes
1x2 Dents



KELMANN
MF-247
angled 8 mm
110 mm

HOFFER
MF-248
angled 11 mm
110 mm



Nucleus Fracture Forceps
extremely thin paddle shaped jaws
with cross serrated outer surfaces

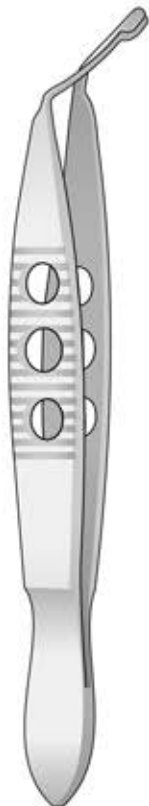

KRAFF
MF-253
105 mm



Nucleus Cracking Forceps
extremely thin paddle shaped jaws
with longitudinally serrated outer surfaces

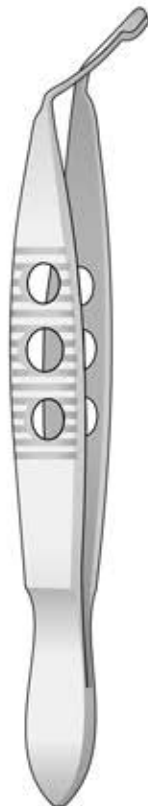

ERNEST-CALF
MF-254
105 mm

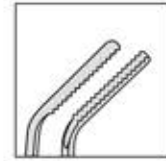

Nucleus Removal Forceps
angled 10 mm long delicate jaws
with multiple parallel teeth

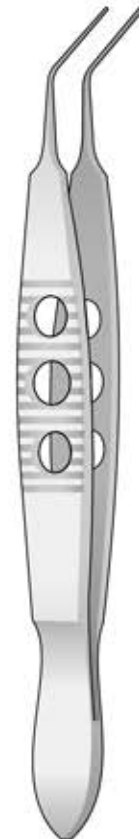

KANSAS
MF-255
105 mm

Capsule, Capsulorhexis

Kapsulorhexispinzette
 Capsulorhexis Forceps
 Pinzette per capsuloressi
 Pinzas para capsuloressi
 Pincas capsulorhexis



Foreign Body Forceps
 angled 60°, very slim
 10 mm long shanks
 with 3 mm long platform



Fragment Forceps
 angled 45°, very slim
 11 mm long shanks
 with smooth platform



Capsule Tag Forceps
 angled, very slim
 11 mm long shanks
 with 1,5 mm long platform



Capsule Flap Forceps
 angled, very slim 11 mm long shanks
 with 5 mm platform and very delicate
 1x2 teeth of 0,1 mm - 45°

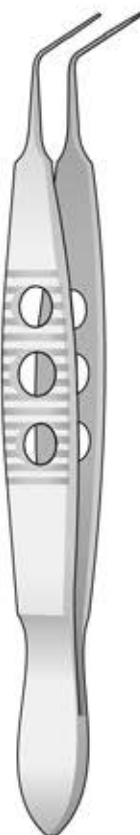

OSHER
 MF-257
 105 mm

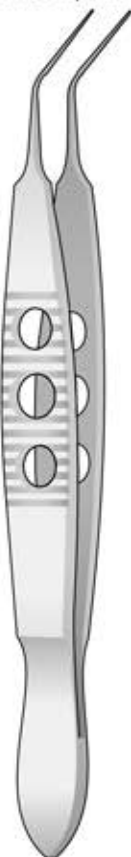

GASKIN
 MF-258
 105 mm

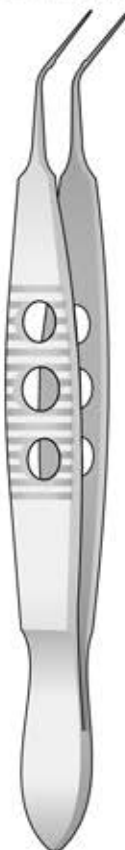

KRAFF
 MF-259
 105 mm

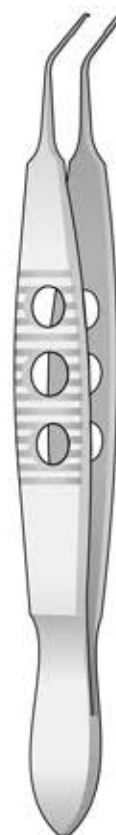

WITSCHEL
 MF-260
 105 mm

Lens Holding Forceps
angled 7,5 mm long smooth jaws

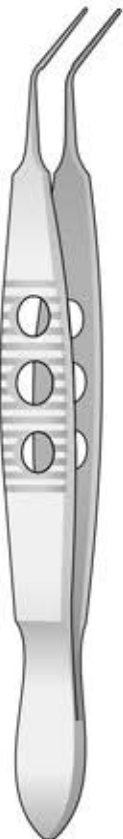

KELMAN-McPHERSON
MF-266
105 mm

Lens Holding Forceps
angled 7.5 mm long smooth jaws
with diagonal groove inside tips

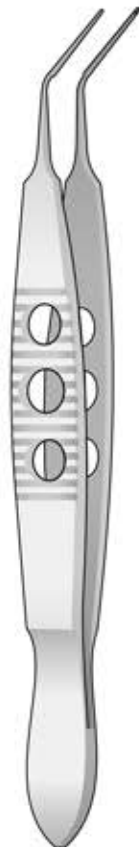
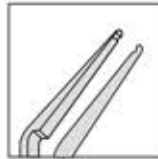

HABERLE-McPHERSON
MF-267
105 mm

Lens Holding Forceps
angled 10 mm long smooth jaws

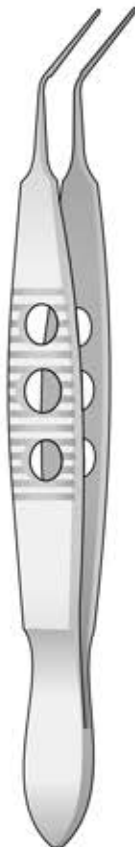
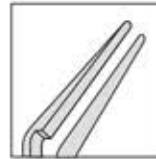

BECHERT-McPHERSON
MF-268
105 mm

Lens Holding Forceps
"diamond dusted" tips with one
flat and one convex surface to
securely hold biconvex IOL's

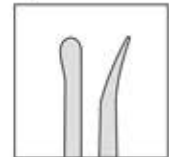

YOSHITOMI-NEUHANN
MF-269 75 mm
MF-270 95 mm

Capsule, Capsulorhexis

Kapsulorhexispinzette
 Capsulorhexis Forceps
 Pinzette per capsuloressi
 Pinzas para capsuloressi
 Pinces capsulorhexis

Capsulorhexis Forceps
 angled, extra thin
 11 mm long schanks
 with ultra fine grasping tips

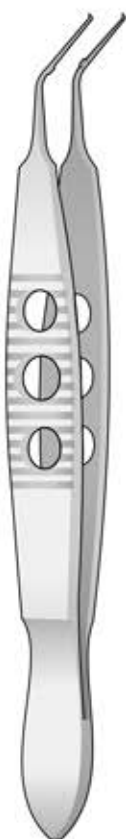

UTRATA
MF-261 On flat serrated handle
MF-262 On round knurled handle
 105 mm

Capsulorhexis Forceps
 angled, extra thin
 11 mm long schanks
 with cystotome shaped tips

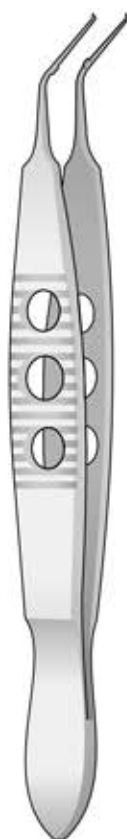

NEVYAS
MF-263
 105 mm

Capsulorhexis Forceps
 angled, very slim
 11 mm long schanks
 with ultra fine rounded tips

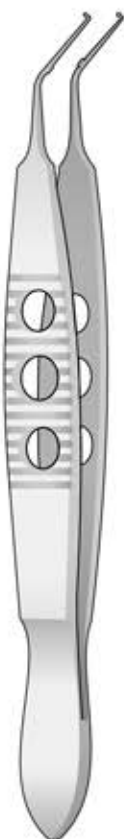

JAFFE
MF-264
 105 mm

Capsulorhexis Forceps
 valuted, very slim
 11 mm long schanks
 with ultra fine grasping tips

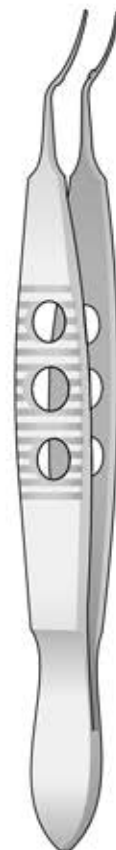
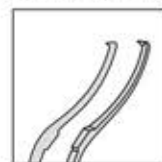

LEHNER
MF-265
 105 mm

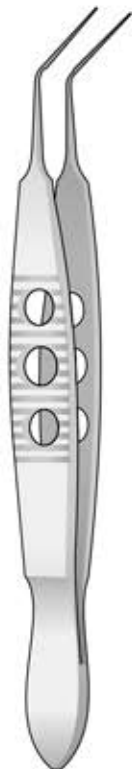

SHEETS-McPHERSON
MF-271
105 mm

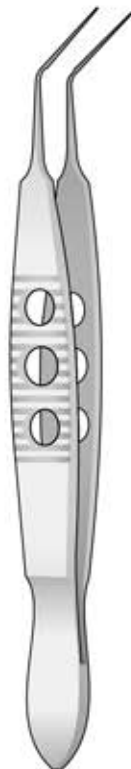

GASKIN
MF-272
105 mm

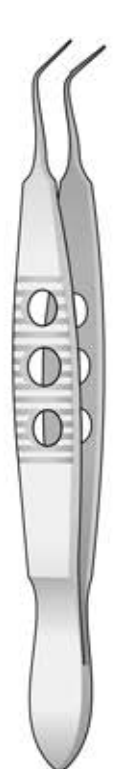
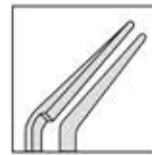

DODICK
MF-273
105 mm

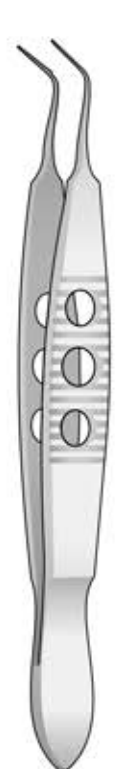
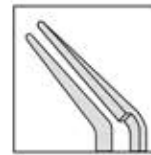

DODICK
MF-274
105 mm

IOL - LIO
 Implantationspinzette
 Implantation Forceps
 Pinze da impianto
 Pinzas para implantación
 Pincés pour implantation

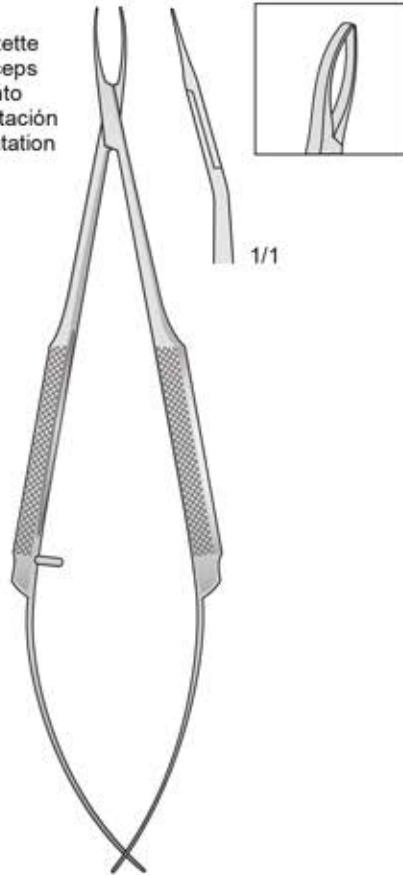

FD-100
 125 mm

LIO Implantationspinzette
 Lens folding Forceps,
 clamp form - LIO
 Pinze per piegare e inserire LIO
 Pinzas para implantación de lentes LIO
 Pincés à plier forme sabot LIO



MF-296
 110 mm

IOL Implantationspinzette
 IOL Implantation Forceps
 Pinzette per impianti IOL
 Pinzas para implantación de lentes IOL
 Pincés à implantation
 des cristallino

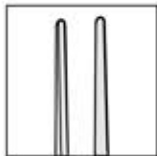
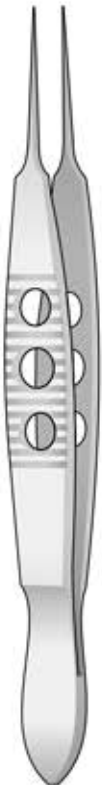

LIVERNOIS
 MF-275 Straight
 MF-276 Angled
 105 mm

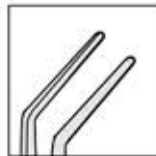
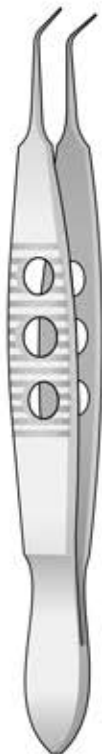

STEINERT
 MF-277
 105 mm

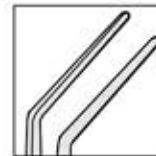
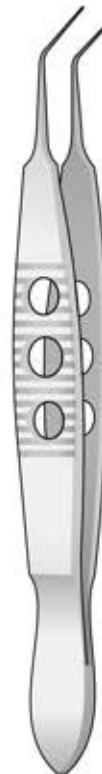

FAULKNER
 MF-278
 105 mm

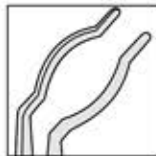
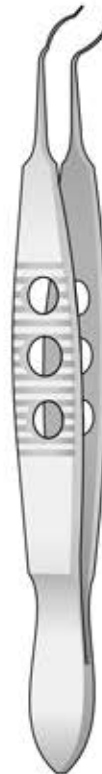

OSHIKA-FAULKNER
 MF-279 Without guide pin
 MF-280 With guide pin
 105 mm

IOL Implantationspinzette
 IOL Implantation Forceps
 Pinzette per impianti IOL
 Pinzas para implantación de lentes IOL
 Pince à implantation
 des cristallino

Pickup and
 Folding Forceps
 angled shanks,
 L-shaped jaws
 with concave
 inside surfaces



Soft IOL
 Insering Forceps
 cross-action,
 angled shanks,
 low profile jaws
 with straight
 inside surfaces



Soft IOL
 Insering Forceps
 cross-action,
 angled shanks,
 low profile jaws
 with concave
 inside surfaces



Soft IOL
 Insering Forceps
 cross-action,
 angled shanks,
 short low profile jaws
 with concave
 inside surfaces

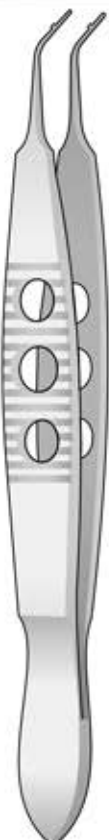
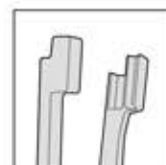
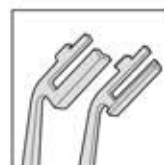

LIVERNOIS
 MF-281
 105 mm

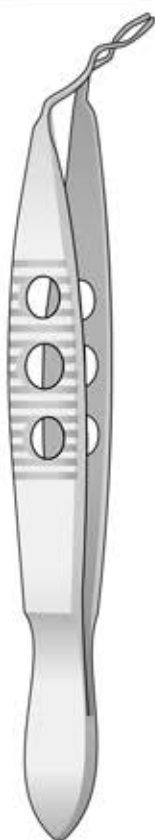

CALF II
 MF-282
 105 mm

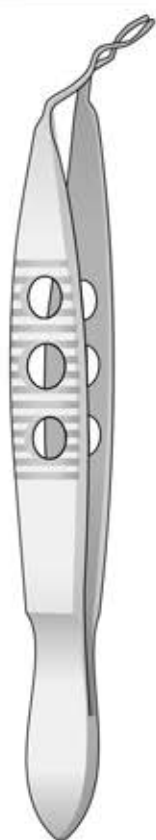

CALF III
 MF-283
 105 mm

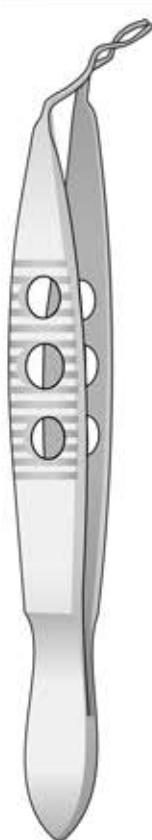

CALF IV
 MF-284
 105 mm

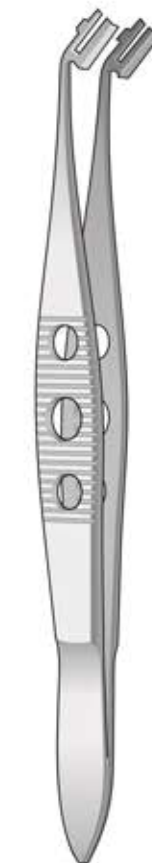

MF-293
 110 mm



MF-295
 115 mm

6 Zähne
6 Teeth
6 Denti
6 Dents
6 Dientes

Für Erwachsene
For adults
Per adulti
Para adultos
Pour adultes

6 Zähne
6 Teeth
6 Denti
6 Dents
6 Dientes

4 Zähne
4 Teeth
4 Denti
4 Dents
4 Dientes

Für Kinder
For children
Per bambini
Para niños
Pour enfants

4 Zähne
4 Teeth
4 Denti
4 Dents
4 Dientes



Rechts
Right
Destra
Derecha
À droite



Links
Left
Sinistra
Izquierda
À gauche



Rechts
Right
Destra
Derecha
À droite



Links
Left
Sinistra
Izquierda
À gauche

Strabismuspinzette
Strabismus Forceps
Pinze da strabismo
Pinzas para estrabismo
Pinces à strabisme

Muskelpinzetten
Muscle Forceps
Pinzette muscolari
Pinzas musculares
Pinces musculaire

JAMESON
MF-331
100 mm

JAMESON
MF-332
100 mm

JAMESON
MF-333
100 mm

JAMESON
MF-334
100 mm

Chalazionpinzetten
Chalazion Forceps
Pinzette da calazio
Pinzas para chalazion
Pinces à chalazion

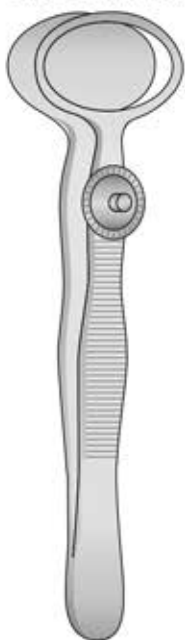

DESMARRES
BD-130/BD-132
90 mm



BD-130
20 mm



BD-131
26 mm



BD-132
31 mm

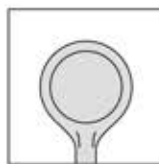

LAMBERT
BD-260
90 mm

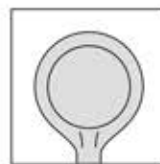

HUNT
BD-261
95 mm

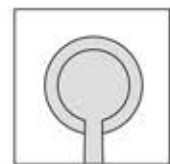

AYERS
BD-263
90 mm



Rechts
Right
Destra
Derecha
À droite

SNELLEN
BD-296
95 mm



Links
Left
Sinistra
Izquierda
À gauche

SNELLEN
BD-297
95 mm



Rechts
Right
Destra
Derecha
À droite

SNELLEN
BD-298
95 mm



Links
Left
Sinistra
Izquierda
À gauche

SNELLEN
BD-299
95 mm

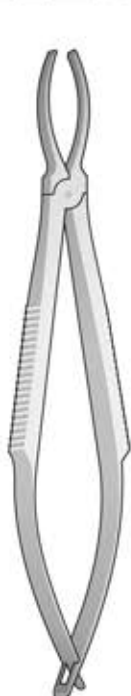
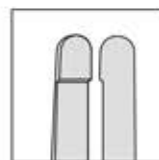
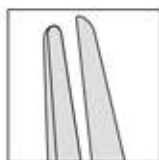
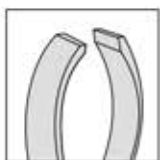

GRADLE
FD-131
95 mm



BEAUPRE
FD-117
110 mm

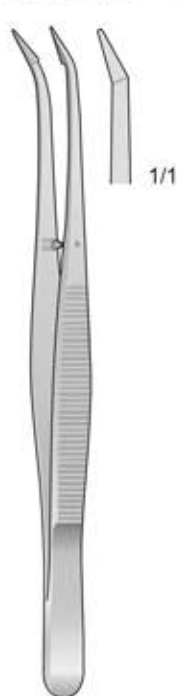

BARRAQUER
ES-65
105 mm

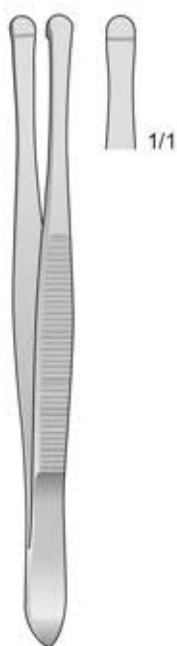

BEER
ES-48
90 mm

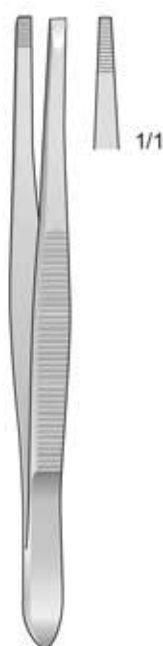

ES-45
90 mm

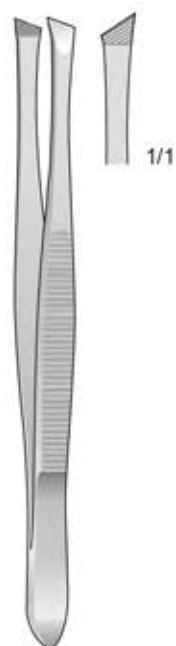

ES-46
90 mm

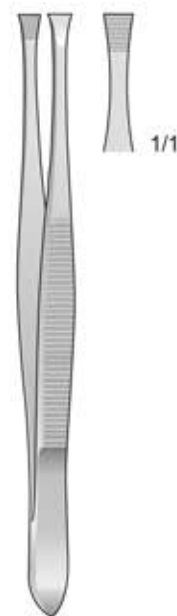

LITTAUER
ES-64
85 mm

Fadenpinzetten
Suturing Forceps
Pinzette da sutura
Pinzas para sutura
Pinces à sutures

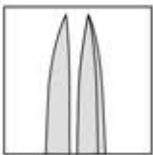

MF-285
Foreign Body Forceps
with sharp pointed tips

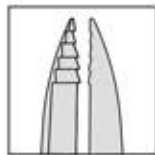

MF-286
Corneal and Splinter Forceps
with sharp points and
reverse cut teeth

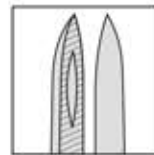

MF-287
Suture and Conjunctiva Forceps
serrated jaws with
longitudinally groove

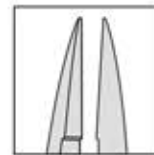

MF-288
Tying and Stitch Removal Forceps
with delicate platform and sharp
points for removing 10-0 sutures



VOLKER
MF-285
90 mm



VOLKER-THORPE
MF-286
90 mm



VOLKER-MOORFIELD
MF-287
90 mm



VOLKER-PATON
MF-288
90 mm

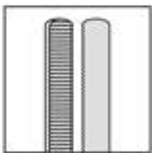

MF-289
Dressing Forceps
serrated, 1,0 mm tips

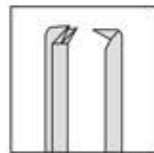

MF-290
Tissue Forceps
1x2 teeth of 1,0 mm

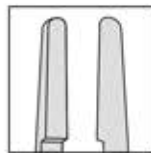

MF-291
Tying Forceps
6 mm smooth platform

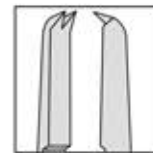

MF-292
Suturing Forceps
1x2 teeth of 1,0 mm set at 45°
with 6 mm long platform



MF-294
Cilien- und
Fremdkörperpinzette
Cilia and foreign
body forceps



VOLKER-ADSON
MF-289
90 mm



VOLKER-ADSON
MF-290
90 mm



VOLKER-HARMS
MF-291
90 mm



VOLKER-CASTROVIEJO
MF-292
90 mm



SHAAF
MF-294
95 mm

Mikro Pinzetten
 Micro forceps
 Micro pinzette
 Pinzas finos
 Micro pincas

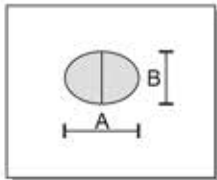

Mikro Pinzetten
 Micro forceps
 Micro pinzette
 Pinzas finos
 Micro pincas

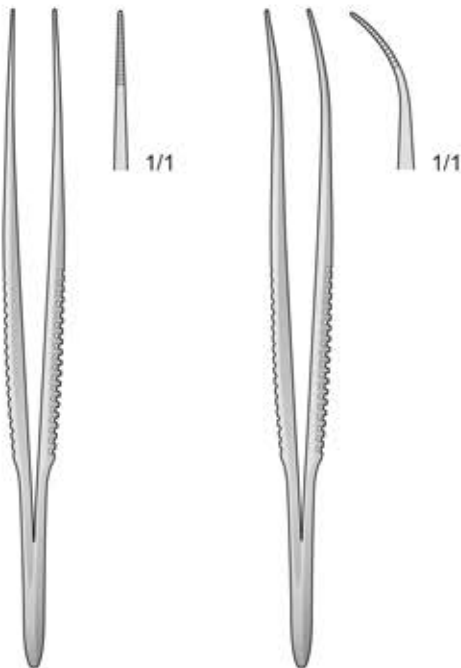
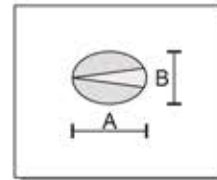

1x2 Zähne
 1x2 Teeth
 1x2 Denti
 1x2 Dientes
 1x2 Dents

1x2 Zähne
 1x2 Teeth
 1x2 Denti
 1x2 Dientes
 1x2 Dents

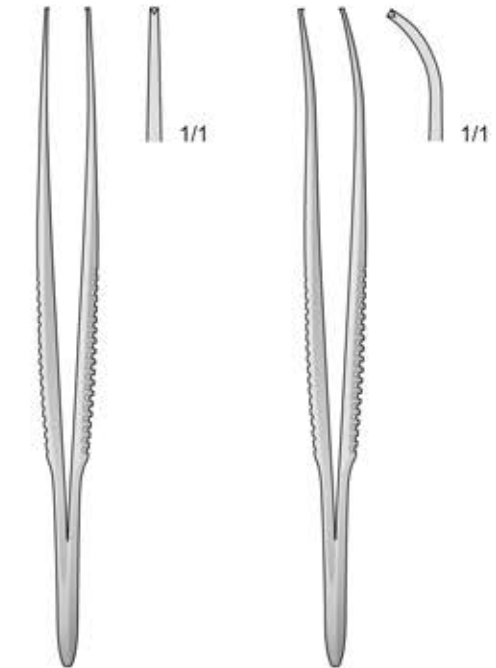

A	B			A	B		
0.5	0.4	MF-24	MF-29	0.4	0.25	MF-34	MF-40
0.6	0.5	MF-25	MF-30	0.5	0.35	MF-35	MF-41
0.9	0.7	MF-26	MF-31	0.7	0.55	MF-36	MF-42
1.3	1	MF-27	MF-32	1	0.8	MF-37	MF-43
1.6	1.3	MF-28	MF-33	1.2	0.9	MF-38	MF-44
		95 mm	95 mm			95 mm	95 mm

Spitz - Sharp - Acuta
Agudas - Pointu

0,3 mm 0,3 mm



MF-73 MF-74

Stumpf - Blunt - Smussa
Romas - Mousse

0,4 mm 0,4 mm



MF-75 MF-76

Spitz - Sharp - Acuta
Agudas - Pointu

0,3 mm 0,3 mm

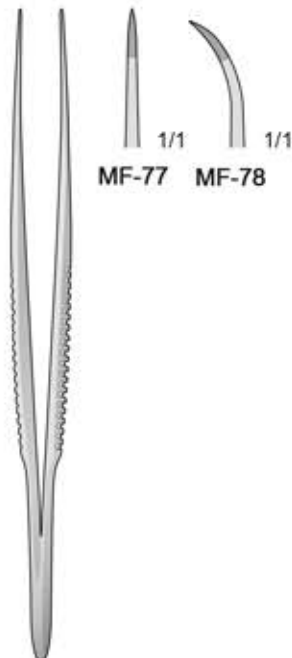

MF-77 MF-78

Stumpf - Blunt - Smussa
Romas - Mousse

0,4 mm 0,4 mm

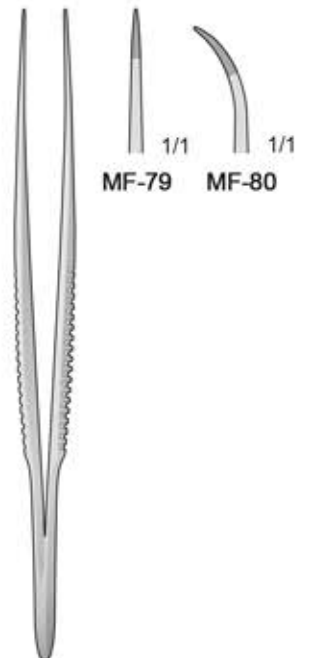

MF-79 MF-80

MF-73/MF-74
95 mm

MF-75/MF-76
95 mm

MF-77/MF-78
95 mm

MF-79/MF-80
95 mm

Mikro Pinzetten
 Micro forceps
 Micro pinzette
 Pinzas finos
 Micro pincers

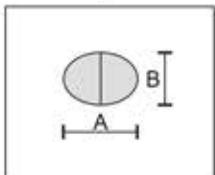

Mikro Pinzetten
 Micro forceps
 Micro pinzette
 Pinzas finos
 Micro pincers

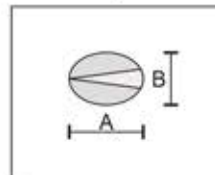

1x2 Zähne
 1x2 Teeth
 1x2 Denti
 1x2 Dientes
 1x2 Dents

1x2 Zähne
 1x2 Teeth
 1x2 Denti
 1x2 Dientes
 1x2 Dents



A B

0,5 0,4

MF-19

0,6 0,5

MF-20

0,9 0,7

MF-21

1,3 1

MF-22

1,6 1,3

MF-23

125 mm

A B

0,4 0,25

MF-13

0,5 0,35

MF-14

0,7 0,55

MF-15

1 0,8

MF-16

1,2 0,9

MF-17

125 mm

MF-46

MF-47

MF-48

MF-49

MF-50

125 mm

MF-52

MF-53

MF-54

MF-55

MF-56

125 mm

Spitz - Sharp - Acuta
Agudas - Pointu

0,4 mm 0,4 mm

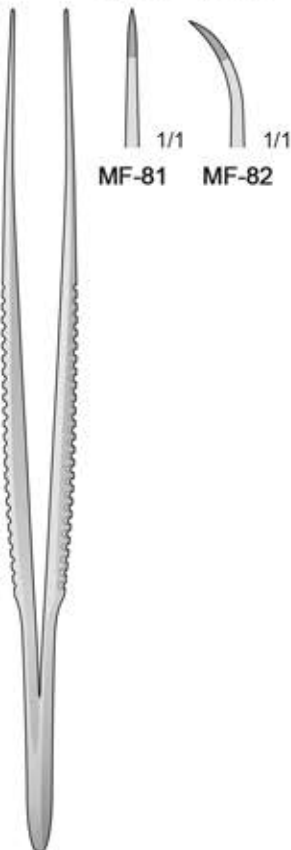

MF-81 MF-82

Stumpf - Blunt - Smussa
Romas - Mousse

0,5 mm 0,5 mm



MF-83 MF-84

Spitz - Sharp - Acuta
Agudas - Pointu

0,3 mm 0,3 mm

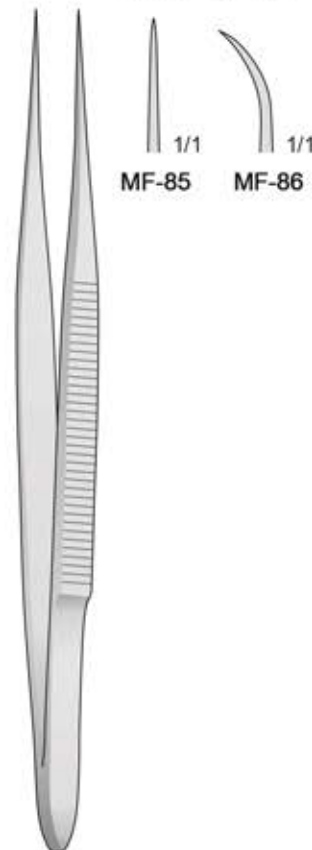

MF-85 MF-86

Stumpf - Blunt - Smussa
Romas - Mousse

0,4 mm 0,4 mm

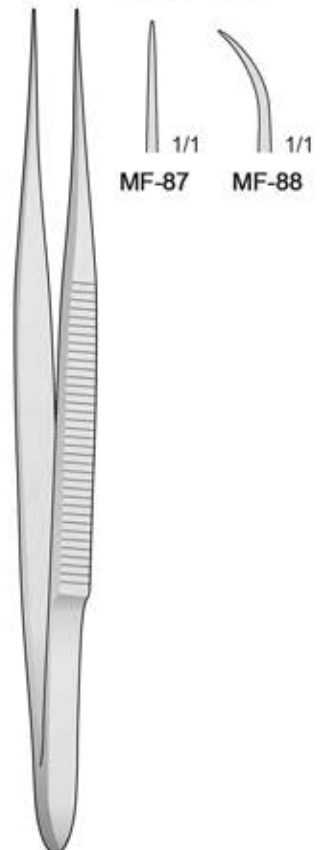

MF-87 MF-88

MF-81/MF-82
125 mm

MF-83/MF-84
125 mm

MF-85/MF-86
125 mm

MF-87/MF-88
125 mm

Mikro Pinzetten
Micro forceps
Micro pinzette
Pinzas finos
Micro pincas

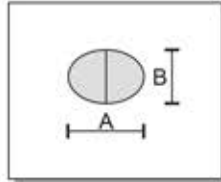

Mikro Pinzetten
Micro forceps
Micro pinzette
Pinzas finos
Micro pincas

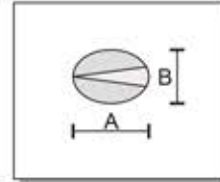

1x2 Zähne
1x2 Teeth
1x2 Denti
1x2 Dientes
1x2 Dents



1x2 Zähne
1x2 Teeth
1x2 Denti
1x2 Dientes
1x2 Dents



A	B
0,5	0,4
0,6	0,5
0,9	0,7
1,3	1
1,6	1,2
1,8	1,4

150 mm

MF-01
MF-02
MF-03
MF-07
MF-08
MF-09

150 mm

A	B
0,4	0,25
0,5	0,35
0,7	0,55
1	0,8
1,2	0,9

MF-04
MF-05
MF-06
MF-10
MF-11
MF-12

150 mm

MF-58
MF-59
MF-60
MF-61
MF-62

150 mm

MF-64
MF-65
MF-66
MF-67
MF-68

150 mm

Spitz - Sharp - Acuta
Agudas - Pointu

0,3 mm 0,3 mm

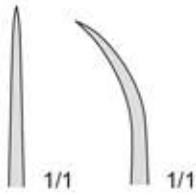

MF-89 MF-90

Stumpf - Blunt - Smussa
Romas - Mousse

0,3 mm 0,3 mm

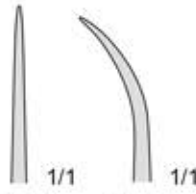

MF-91 MF-92

Spitz - Sharp - Acuta
Agudas - Pointu

0,3 mm 0,3 mm

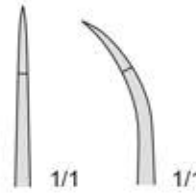

MF-93 MF-94

Stumpf - Blunt - Smussa
Romas - Mousse

0,3 mm 0,3 mm

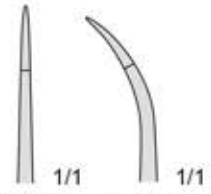

MF-95 MF-96

MF-89/MF-90
150 mm

MF-90/MF-92
150 mm

MF-93/MF-94
150 mm

MF-95/MF-96
150 mm



BD-200/BD-204

0,15 mm

BD-200
100 mm

0,2 mm

BD-201
110 mm

0,3 mm

BD-204
120 mm

0,3 mm

BD-205
115 mm

0,3 mm

BD-60/BD-62
110 mm

0,3 mm

BD-60
1/1BD-62
1/1

0,3 mm

BD-64
110 mm

0,5 mm

BD-206
115 mm

Needle Holders

Nadelhalter
Porte-aiguilles
Portaagujas
Port'aghi

Hemostatic Forceps

Arterienklemmen
Pincés hémostatiques
Pinzas hemostáticas
Pinzette emostatiche

Glattes Maul - Smooth jaws - Morso liscio - Bocas lisas - Mors lisses



CASTROVIEJO
FD-82/FD-83
110 mm



CASTROVIEJO
FD-84/FD-85
110 mm



CASTROVIEJO
FD-240/FD-241
110 mm



CASTROVIEJO
FD-86/FD-87
125 mm

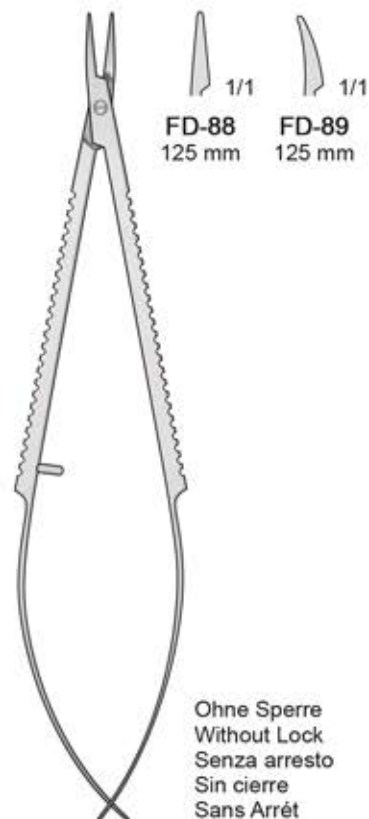

CASTROVIEJO
FD-88/FD-89
125 mm

Glattes Maul - Smooth jaws - Morso liscio - Bocas lisas - Mors lisses

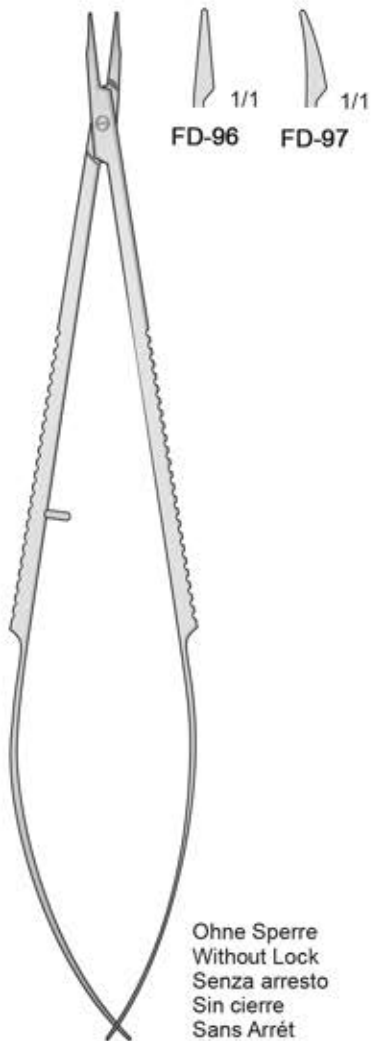

CASTROVIEJO
FD-96/FD-97
160 mm

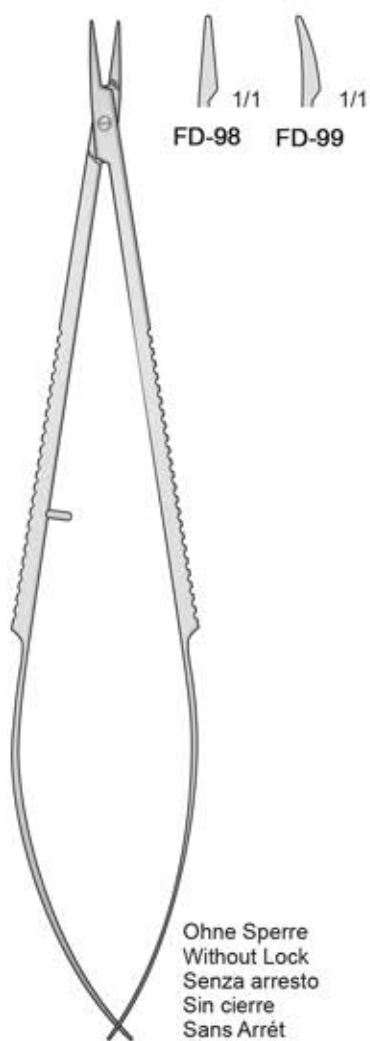

CASTROVIEJO
FD-98/FD-99
160 mm

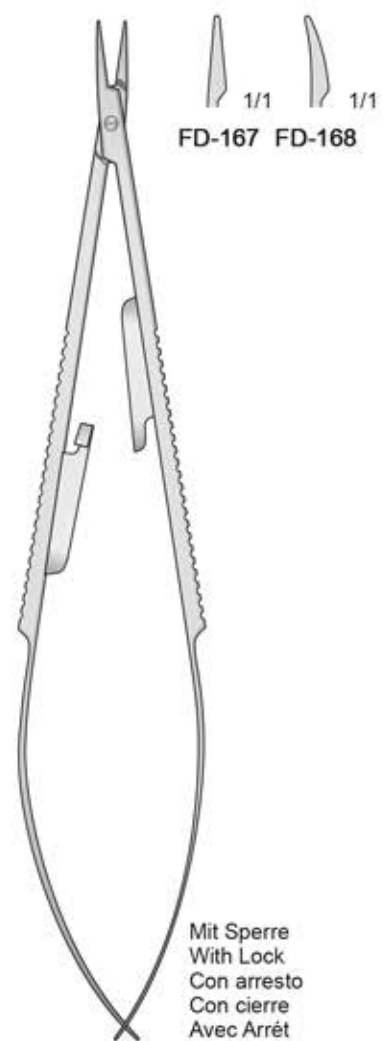

CASTROVIEJO
FD-167/FD-168
160 mm

Glattes Maul - Smooth jaws - Morso liscio - Bocas lisas - Mors lisses

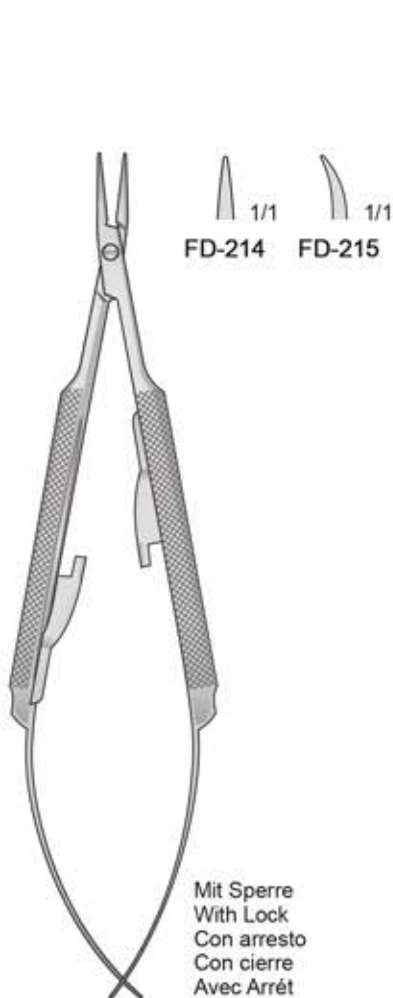

BARRAQUER
FD-214/FD-215
125 mm

Mit Sperre
With Lock
Con arresto
Con cierre
Avec Arrêt

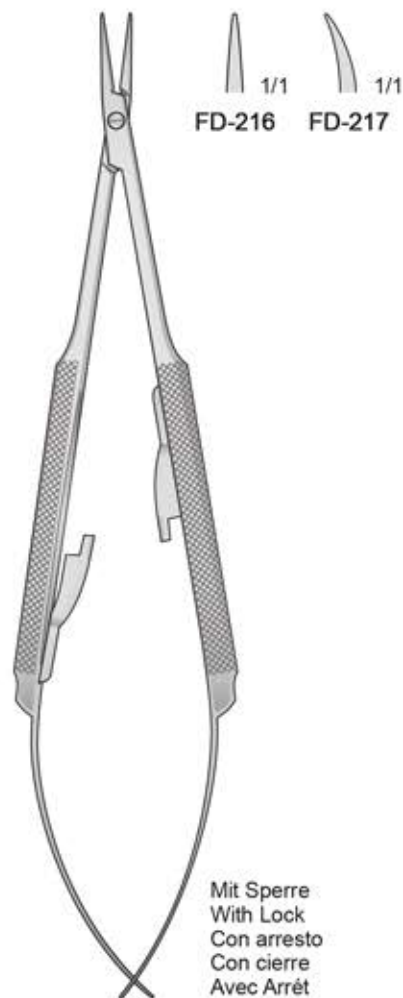

BARRAQUER
FD-216/FD-217
150 mm

Mit Sperre
With Lock
Con arresto
Con cierre
Avec Arrêt

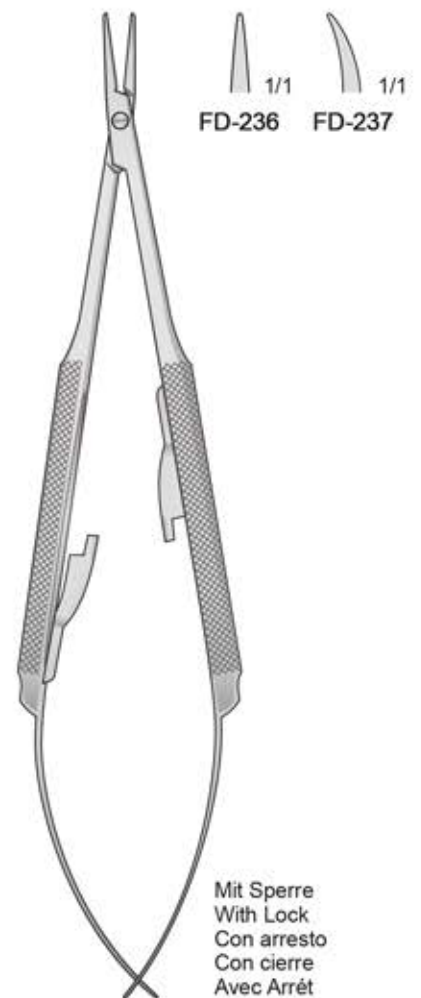

BARRAQUER
FD-236/FD-237
150 mm

Mit Sperre
With Lock
Con arresto
Con cierre
Avec Arrêt

Glattes Maul - Smooth jaws - Morso liscio - Bocas lisas - Mors lisses

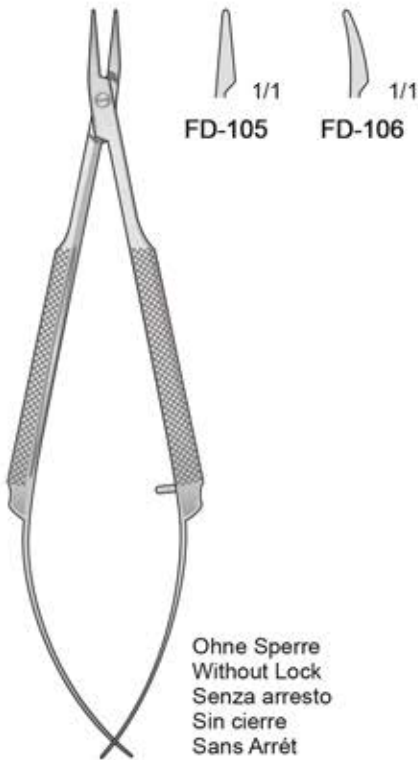

CASTROVIEJO
FD-105/FD-106
110 mm

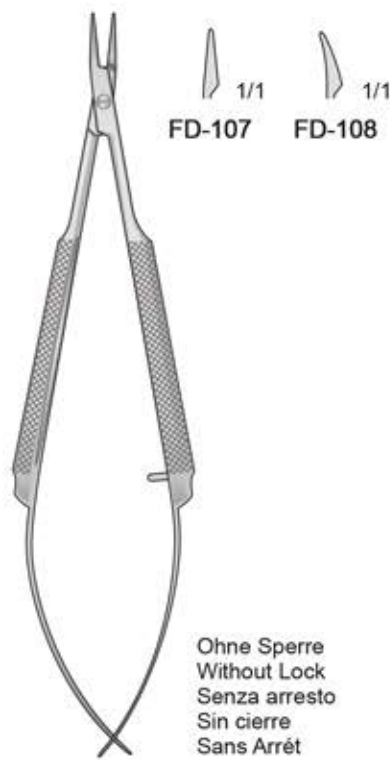

CASTROVIEJO
FD-107/FD-108
110 mm

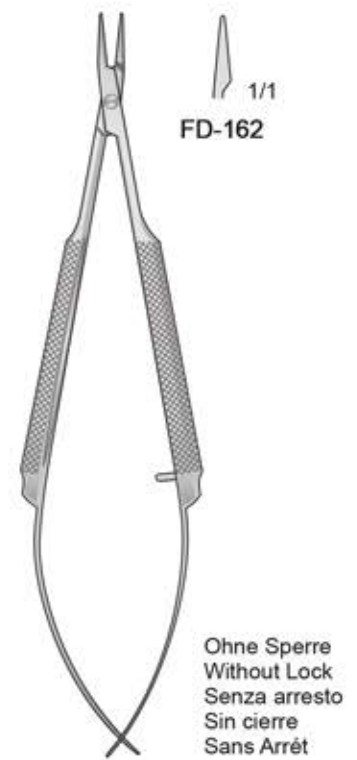

CASTROVIEJO
FD-162
110 mm

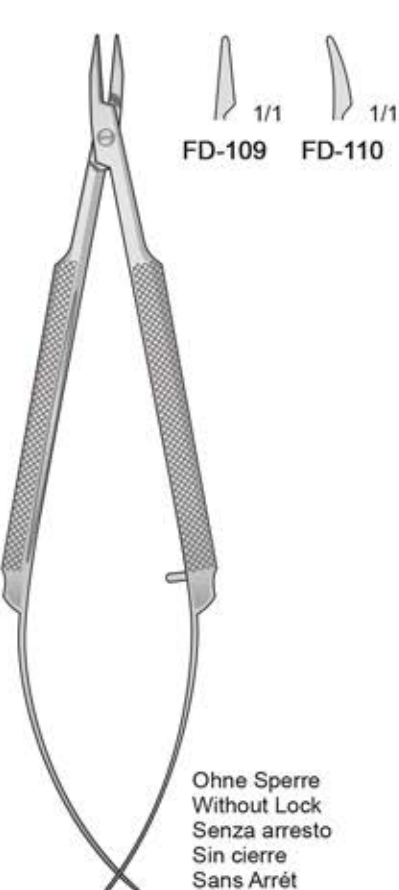

CASTROVIEJO
FD-109/FD-110
125 mm

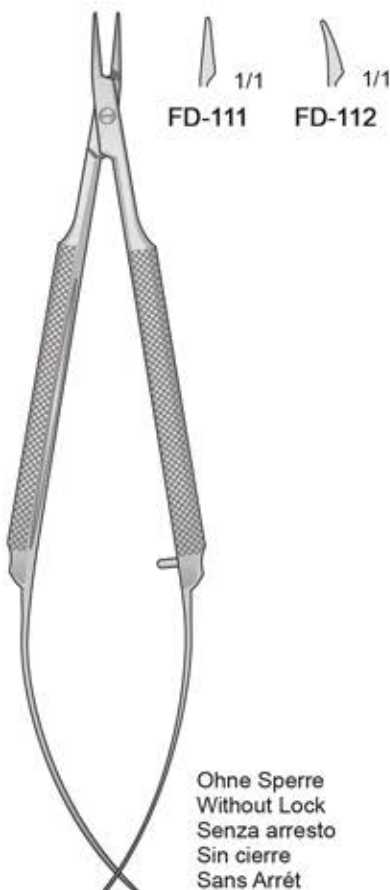

CASTROVIEJO
FD-111/FD-112
125 mm

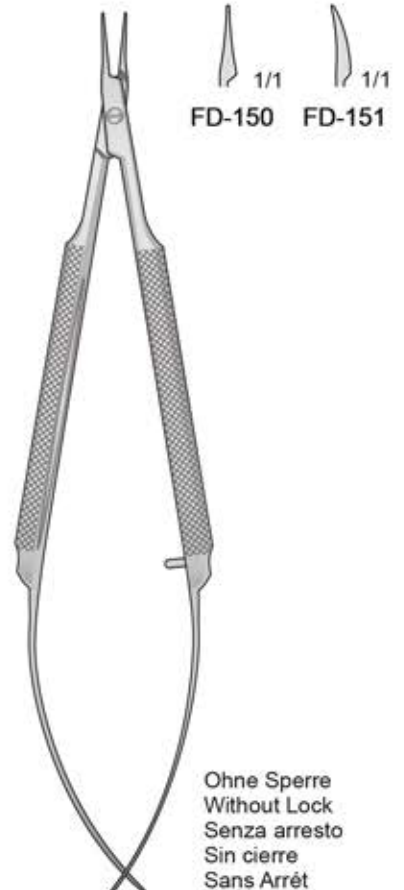

BARRAQUER
FD-150/FD-151
125 mm

Glattes Maul - Smooth jaws - Morso liscio - Bocas lisas - Mors lisses

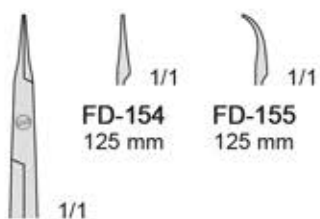

FD-154
125 mm

FD-155
125 mm

Ohne Sperre
Without Lock
Senza arresto
Sin cierre
Sans Arrêt

BARRAQUER
FD-154/FD-155
125 mm

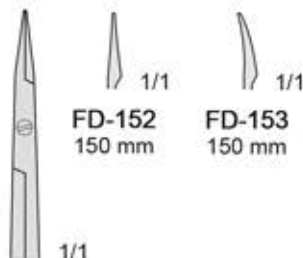

FD-152
150 mm

FD-153
150 mm

Ohne Sperre
Without Lock
Senza arresto
Sin cierre
Sans Arrêt

BARRAQUER
FD-152/FD-153
150 mm

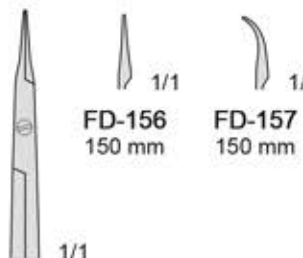

FD-156
150 mm

FD-157
150 mm

Ohne Sperre
Without Lock
Senza arresto
Sin cierre
Sans Arrêt

REILL
FD-156/FD-157
150 mm

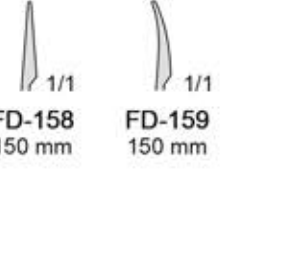

FD-158
150 mm

FD-159
150 mm

Ohne Sperre
Without Lock
Senza arresto
Sin cierre
Sans Arrêt

CASTROVIEJO
FD-158/FD-159
150 mm

Glattes Maul - Smooth jaws - Morso liscio - Bocas lisas - Mors lisses

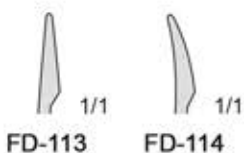
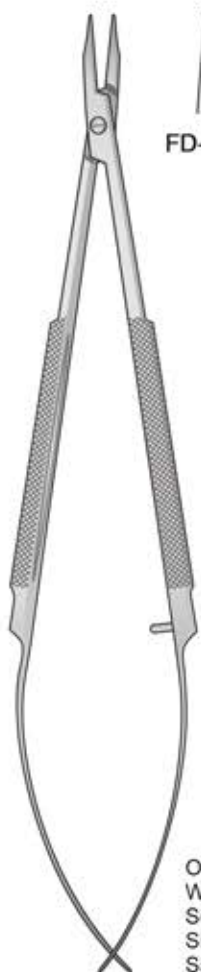

CASTROVIEJO
FD-113/FD-114
150 mm

Ohne Sperre
Without Lock
Senza arresto
Sin cierre
Sans Arrêt

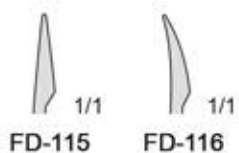
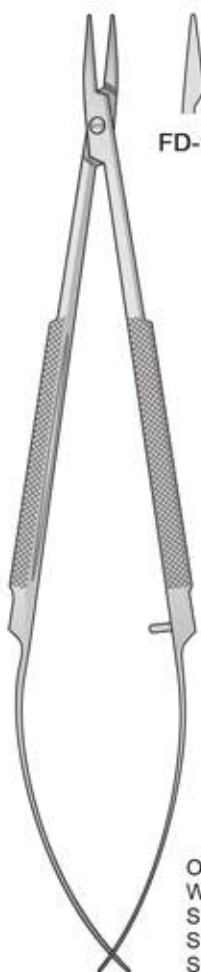

CASTROVIEJO
FD-115/FD-116
150 mm

Ohne Sperre
Without Lock
Senza arresto
Sin cierre
Sans Arrêt

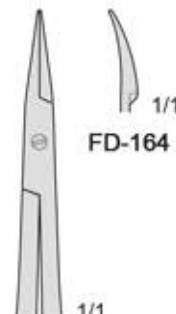
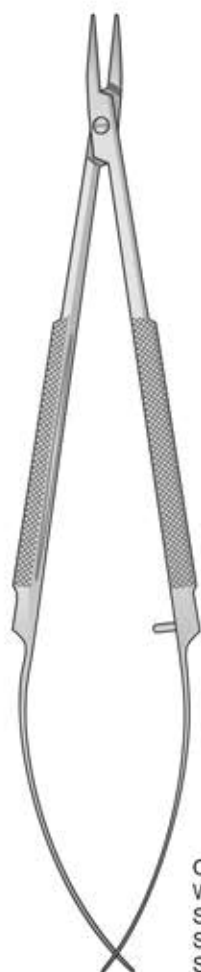

CASTROVIEJO
FD-164
150 mm

Ohne Sperre
Without Lock
Senza arresto
Sin cierre
Sans Arrêt

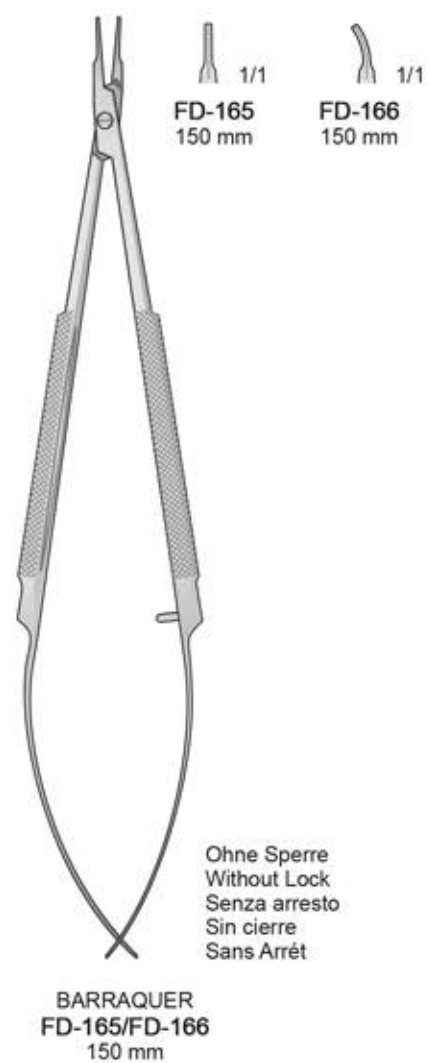
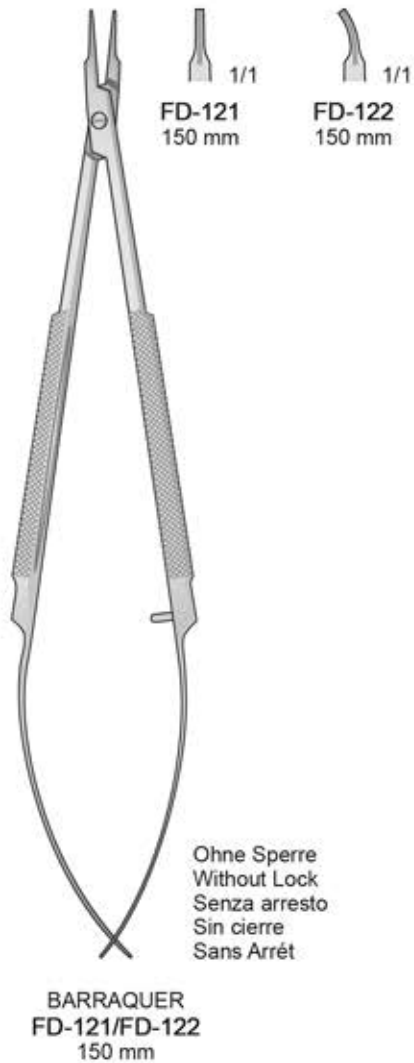

*These products are not available for sale or distribution in the USA.
For further information on product availability, please contact your local representative.*

Gefäßklemme - Serrefine
Pinze serrafile - Serra-fina
Serre fils

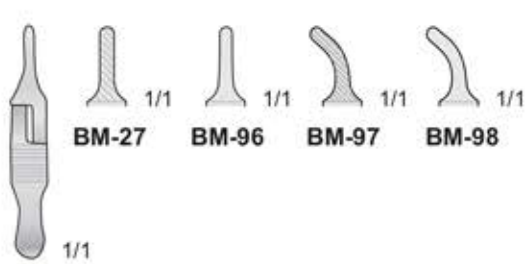

DIEFFENBACH
BM-27/BM-98
30 mm

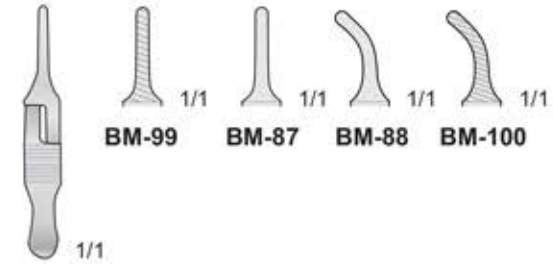

DIEFFENBACH
BM-87/BM-100
30 mm

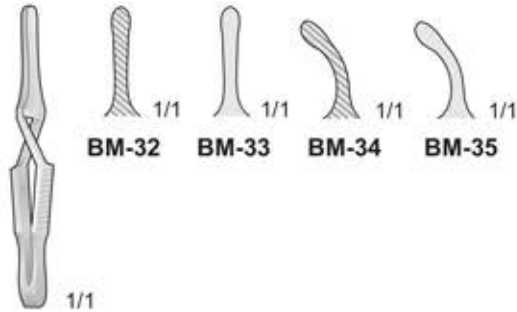

DIEFFENBACH
BM-32/BM-35
40 mm

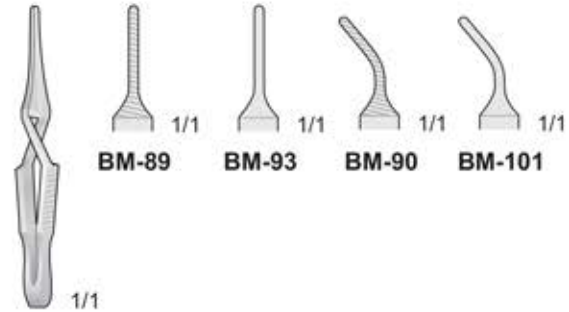

BM-89/BM-101
40 mm

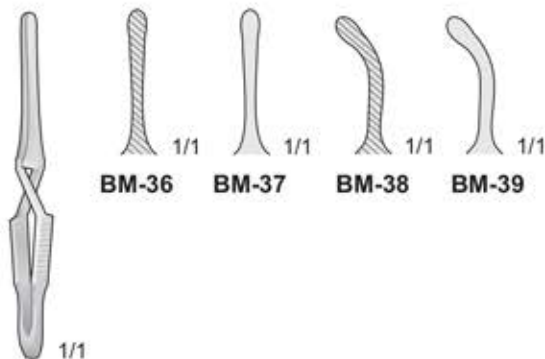

DIEFFENBACH
BM-36/BM-39
45 mm

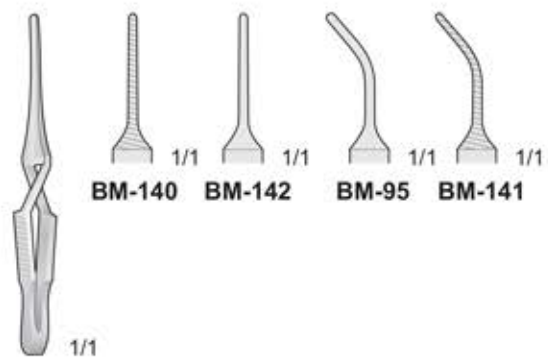

BM-95/BM-142
45 mm

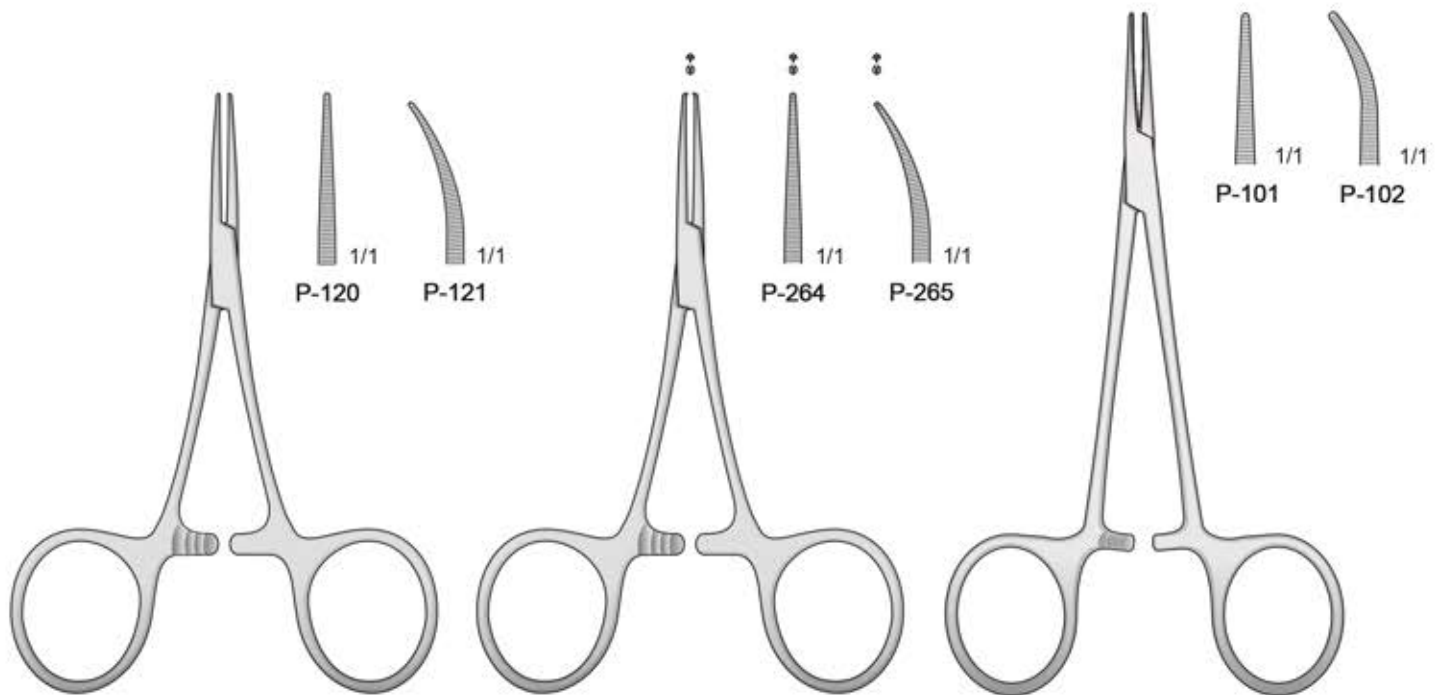

HARTMANN-BABY-MOSQUITO
P-120/P-121
95 mm

HARTMANN-BABY-MOSQUITO
P-264/P-265
95 mm

MICRO-HALSTED
P-101/P-102
120 mm

1x2 Zähne
1x2 Teeth
1x2 Denti
1x2 Dientes
1x2 Dents

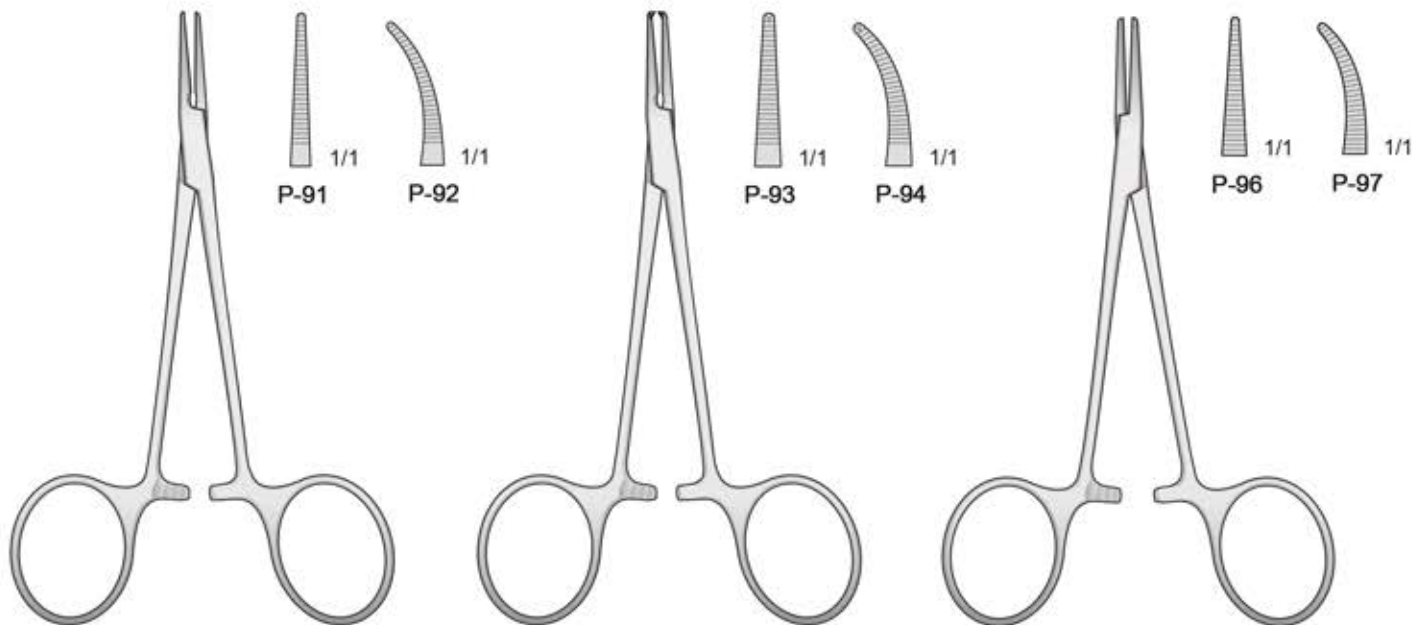

HALSTED
P-91/P-92
125 mm

HALSTED
P-93/P-94
125 mm

HALSTED-MOSQUITO
P-96/P-97
120 mm

5x6 Zähne
5x6 Teeth
5x6 Denti
5x6 Dientes
5x6 Dents

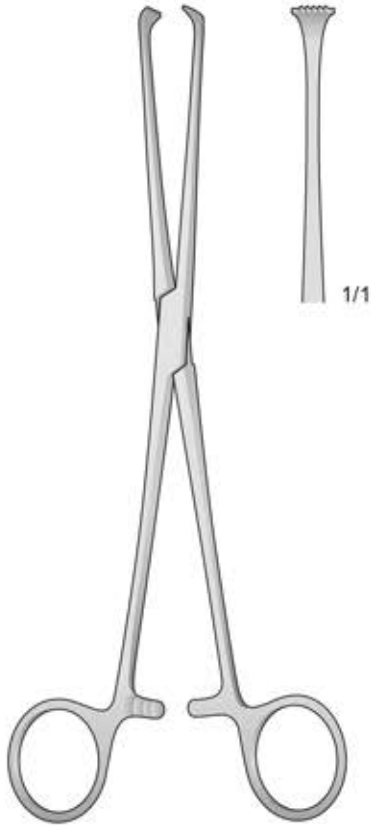

ALLIS
P-50
160 mm

4x5 Zähne
4x5 Teeth
4x5 Denti
4x5 Dientes
4x5 Dents

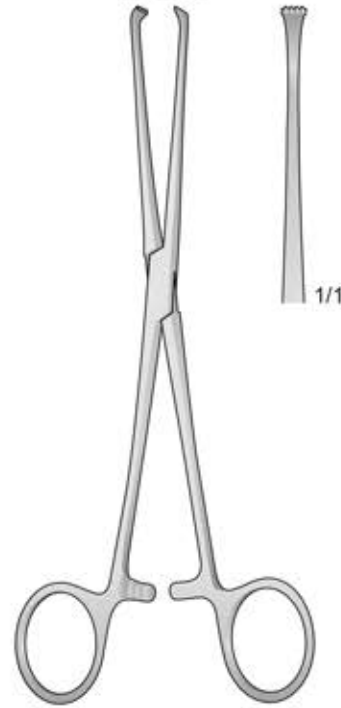

BABY-ALLIS
P-100
130 mm

Tuchklemmen - Towel Forceps
Pinze fissateli - Pinzas de campo
Pinces à champs



SCHAEDEL
BF-38
85 mm

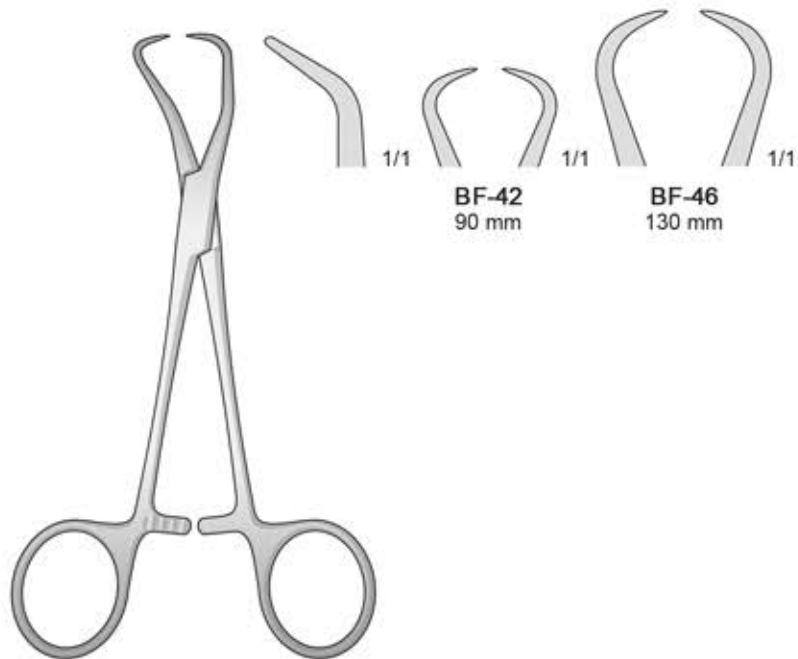

BACKHAUS
BF-42/BF-46

Zirkel - Calipers
Compassi - Compases
Compases

Maßstab, millimeter - Ruler, graduated - Decimetro
Regla - Reglette graduée

Meßbereich: 0 - 80 mm - Measuring range: 0 - 80 mm
Campo di misura: 0 - 80 mm - Alcance de medición: 0 - 80 mm
Etendue de mesure: 0 - 80 mm



OR-40
125 mm

OR-42
120 mm

OR-45
95 mm



LS-04
80 mm

LS-07
50 mm

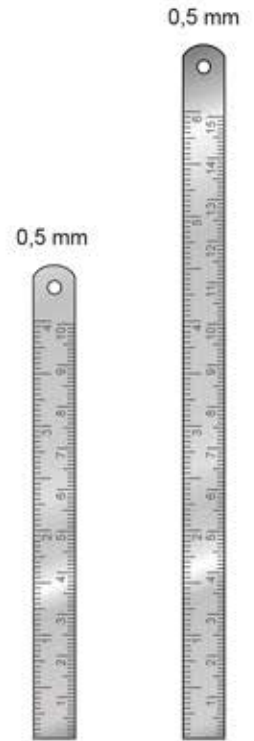

LS-08
100 mm

LS-09
150 mm

Meßbereich: 0 - 15 mm
Measuring range: 0 - 15 mm
Campo di misura: 0 - 15 mm
Alcance de medición: 0 - 15 mm
Etendue de mesure: 0 - 15 mm

Meßbereich: 0 - 20 mm
Measuring range: 0 - 20 mm
Campo di misura: 0 - 20 mm
Alcance de medición: 0 - 20 mm
Etendue de mesure: 0 - 20 mm

Meßbereich: 0 - 20 mm
Measuring range: 0 - 20 mm
Campo di misura: 0 - 20 mm
Alcance de medición: 0 - 20 mm
Etendue de mesure: 0 - 20 mm

Meßbereich: 0 - 20 mm
Measuring range: 0 - 20 mm
Campo di misura: 0 - 20 mm
Alcance de medición: 0 - 20 mm
Etendue de mesure: 0 - 20 mm

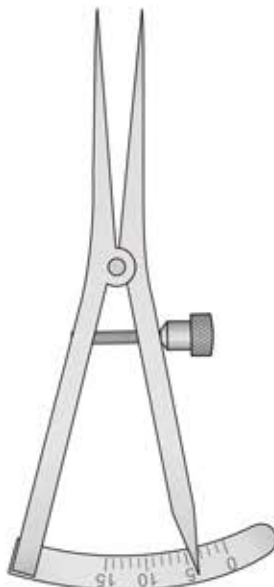

CASTROVIEJO
OR-15
90 mm

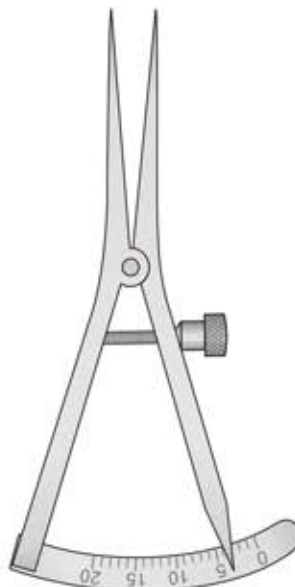

CASTROVIEJO
OR-17
90 mm

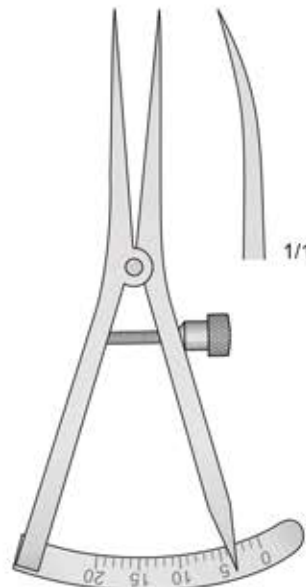

CASTROVIEJO
OR-19
90 mm

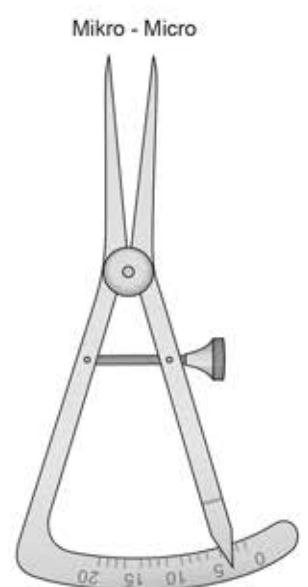

Mikro - Micro

CALIPER
OR-20
80 mm

Markers

Marker
Marqueurs
Marcadores
Marcatori

Eye Speculums

Lidsperrer
Blépharostats
Blefarostatos,
Blefarostati

Eye Cannulas

Augenkanülen
Canules oculaires
Cánulas oculares
Aghi cannule

Flieringa-Fixierring - Flieringa-Fixation Rings
Anelli da fissazione - Anillos fijadoras
Anneaux de fixation flieringa

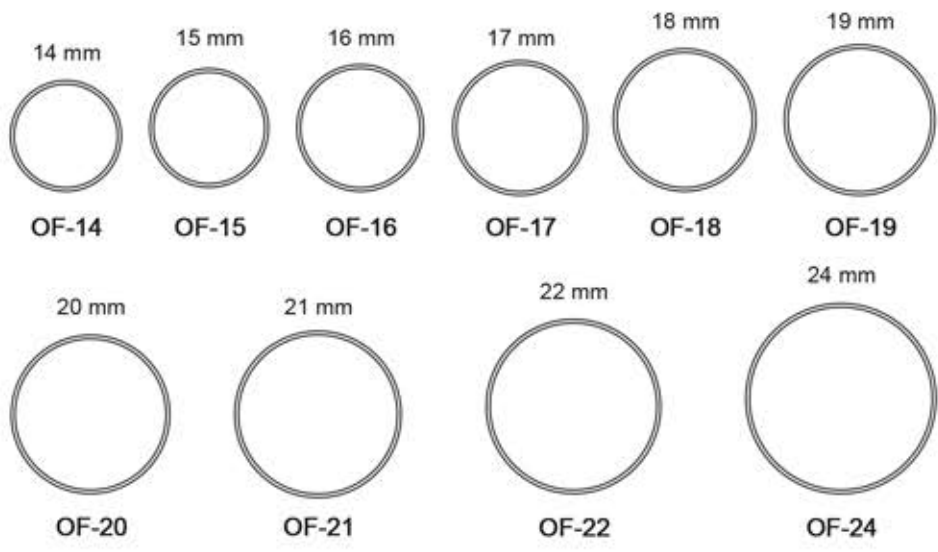

OF-25
 Komplettsset mit 8 Stück
 Set complete with 8 pieces
 Set completo di 8 pezzi
 Set completo con 8 piezas
 Set complet avec 8 pièces
 Ø 15 mm - Ø 22 mm

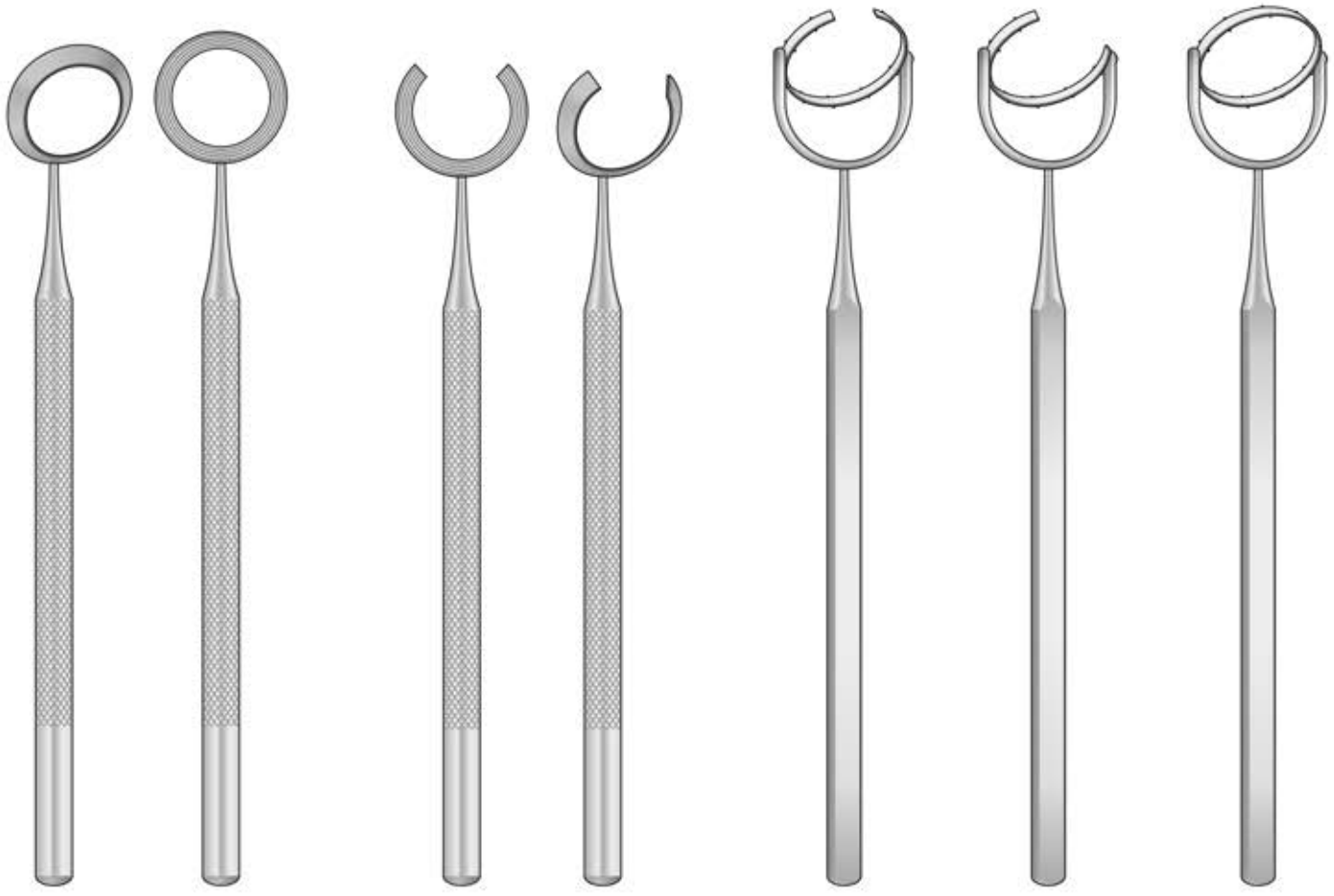

OE-40

OE-41

FINE-THORNTON
 OE-42 Ø 13 mm
 OE-43 Ø 16 mm

GIMBEL
 OE-54

HOFMANN-THORNTON
 OE-57 Ø 16 mm

Fixierring - Rings for astigmatism
 Anelli da astigmatismo - Anillos para astigmatismo
 Anneaux pour astigmatisme



Atraumatische
 Non traumatic
 Atraumatiche
 Atraumaticas
 Atraumatique

Fixationsringe
 Fixation Rings
 Anelli da fissazione
 Anillos fijadoras
 Anneaux de fixation



Meßring
 Measuring ring
 Anello per misurazione
 Anillos para medir
 Anneaux à mesurer



Axis Marker
 used with Mendez
 Marcatore assiale
 da usare con
 anello Mendez

Hornhaut Markierer
 Corneal Markers
 Marcatori corneali
 Marcadores corneales
 Marqueurs cornéens

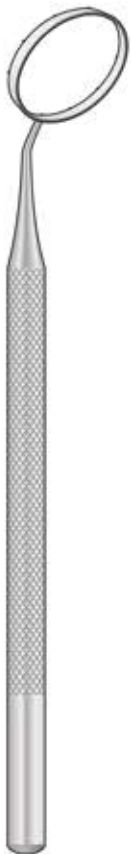

THORNTON
 OE-56 Ø 16 mm

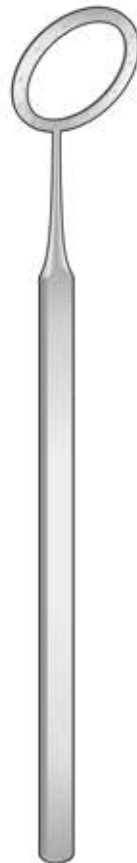

VILLASEÑOR-NAVARRO
 OE-58 Ø 13,5 mm



MENDEZ
 OE-59 Ø 12 mm



BORES
 OE-60

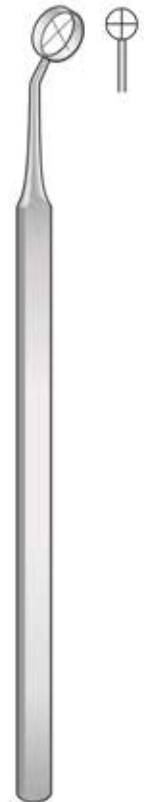

HOFFER
 OE-55 9 mm

Hornhaut Markierer
Corneal Markers
Marcatori corneali
Marcadores corneales
Marqueurs cornéens

Astigmatic Keratotomy
Cheratotomo da astigmatismo

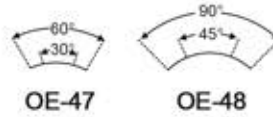

Radial Marker
Marcatore radiale



MENDEZ
OE-44



CHAYET
OE-45



LU
OE-46



NANO
OE-47
OE-48



THORNTON
OE-49 With Target
OE-50 Without Target



THORNTON
OE-51 6 Blades
OE-52 8 Blades

Korrektur des astigmatismus
Incision marker for correction astigmatism
Marcatore per correzione astigmatismo



OE-61 2,5 mm wide
OE-62 3,0 mm wide
OE-63 4,0 mm wide
OE-64 5,0 mm wide

NORDAN-RUIZ
OE-61/OE-64



LINDSTROM
OE-65 6 mm optic zone
OE-66 7 mm optic zone

Double Corneal Ruler
Marcatore corneale doppio

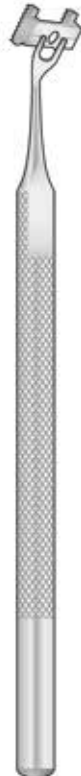

THORNTON
OE-67 for 6-8 mm optic zone
OE-68 for 5-7 mm optic zone

T-Incision Marker
Marcatore per astigmatismo doppio T



OE-69 5 mm spread
OE-70 6 mm spread
OE-71 7 mm spread
OE-72 8 mm spread

HOFMANN
OE-69/OE-72

Für Optisches Zentrum - Optic Zone Marker - Marcatori della zona ottica

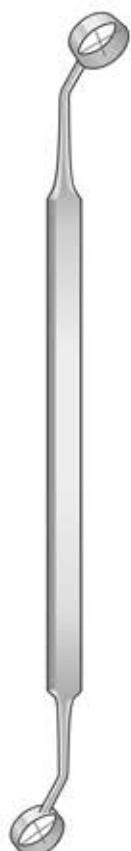

McDONALD
OE-73
6,5 mm / 7,0 mm



BORES
OE-74/OE-86

- OE-74 2,75 mm
- OE-75 3,0 mm
- OE-76 3,25 mm
- OE-77 3,5 mm
- OE-78 3,75 mm
- OE-79 4,0 mm
- OE-80 4,25 mm
- OE-81 4,5 mm
- OE-82 4,75 mm
- OE-83 5,0 mm
- OE-84 6,0 mm
- OE-85 7,0 mm
- OE-86 8,0 mm



BERKELEY
OE-87/OE-90

- OE-87
3,0 mm / 3,25 mm
- OE-88
3,5 mm / 3,75 mm
- OE-89
4,0 mm / 4,25 mm
- OE-90
4,5 mm / 5,0 mm

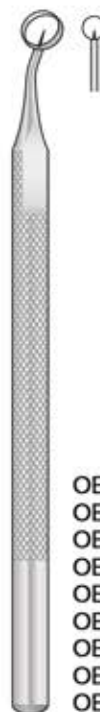

THORNTON
OE-91/OE-99

- OE-91 3,0 mm
- OE-92 3,25 mm
- OE-93 3,5 mm
- OE-94 3,75 mm
- OE-95 4,0 mm
- OE-96 4,25 mm
- OE-97 4,5 mm
- OE-98 4,75 mm
- OE-99 5,0 mm



HOFFER
OE-100/OE-112

- OE-100 3,0 mm
- OE-101 3,25 mm
- OE-102 3,5 mm
- OE-103 3,75 mm
- OE-104 4,0 mm
- OE-105 4,25 mm
- OE-106 4,5 mm
- OE-107 4,75 mm
- OE-108 5,0 mm
- OE-109 5,5 mm
- OE-110 6,0 mm
- OE-111 7,0 mm
- OE-112 8,0 mm

Radial Marker
Marcatori radiali

6 Klengen
6 Blades
6 Lame
6 Hojas
6 Lames



BORES
OE-119
6 Blades

8 Klengen
8 Blades
8 Lame
8 Hojas
8 Lames



BORES
OE-120
8 Blades

Marker
with Ø Rings
3-6-9 mm

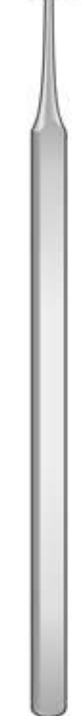

THURMOND
OE-121

Hornhaut Markierer
Corneal Marker
Marcatori corneali
Marcadores corneales
Marquers cornéens

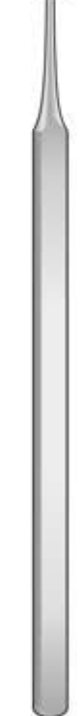

ARROWSMITH
OE-122
3-5 mm Rings



ARROWSMITH
OE-123
3-6 mm Rings

Astigmatism Marker
 Marcatori da astigmatismo

2 Concentric
 Rings
 6,5 / 7,5 mm
 7,0 mm

3 Concentric
 Rings
 5,5 / 6,5 / 7,5 mm

Triple Marker
 with 3 Rings
 Marcatore
 con 3 anelli

OE-113
 3-5-7 mm

OE-114
 3-6-8 mm

ELLIS
 OE-115

ELLIS
 OE-116

Radial Marker
 Marcatore radiale

- OE-124 3 Blades
- OE-125 4 Blades
- OE-126 6 Blades
- OE-127 8 Blades
- OE-128 10 Blades
- OE-129 12 Blades
- OE-130 16 Blades

ANIS
 OE-124/OE-130

Marker for corneal
 8 Radial Blades

ANIS
 OE-131

Incision Ruler

THORNTON LINDSTROM
 OE-132 OE-133

Small incision
 Marker

OE-113 3-5-7 mm
 OE-114 3-6-8 mm

Wire Speculums

Wire Speculums
with solid blades

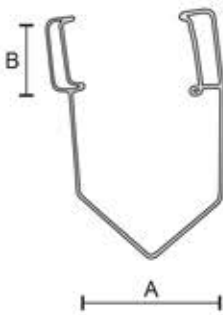

BARRAQUER
A B
NK-79 27 mm 11 mm
42 mm

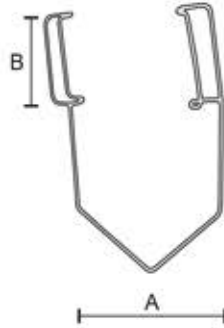

BARRAQUER
A B
NK-80 27 mm 5 mm
NK-82 34 mm 9 mm
NK-84 42 mm 12 mm
NK-86 42 mm 14 mm
52 mm



BARRAQUER
NK-81



BARRAQUER
NK-83

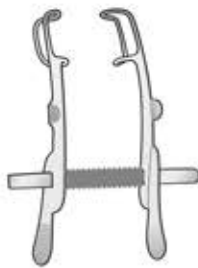

MELLINGER
BV-01 70 mm
BV-02 70 mm

BV-01
Kinder
Children
Bambini
Niños
Enfants

BV-02
Erwachsene
Adults
Adulti
Adultos
Adultes

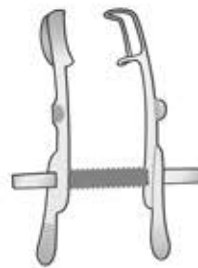

MELLINGER-AXENFELD
NK-132 70 mm

Offen
Aperto

Rechts
Right
Destra
Derecha
Droite

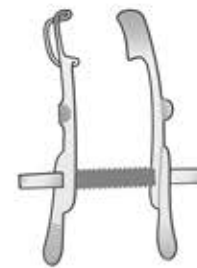

MELLINGER-AXENFELD
NK-133 70 mm

Offen
Aperto

Links
Left
Sinistra
Izquierda
Gauche

Klein
Small
Piccolo



CASTROVIEJO
BV-03
80 mm

Mittel
Medium
Medio



CASTROVIEJO
BV-05
80 mm

Gross
Large
Grande



CASTROVIEJO
BV-53
80 mm



BOWMANN
NK-106
70 mm

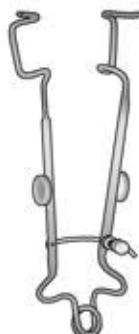

GRAEFE
NK-113 70 mm
NK-114 90 mm

NK-113
Kinder
Children
Bambini
Niños
Enfants

NK-114
Erwachsene
Adults
Adulti
Adultos
Adultes



KNAPP-CLARK
NK-115
80 mm



LANCASTER
NK-116
70 mm



WEISS
NK-117 Offen 70 mm
NK-118 Offen 90 mm

NK-117
Kinder
Children
Bambini
Niños
Enfants

NK-118
Erwachsene
Adults
Adulti
Adultos
Adultes



WEISS
NK-119 Geschl. 70 mm
NK-120 Geschl. 90 mm

NK-119
Kinder
Children
Bambini
Niños
Enfants

NK-120
Erwachsene
Adults
Adulti
Adultos
Adultes



KNAPP-CLARK
NK-121
80 mm



LISTER-BURCH
BV-04
80 mm



WILLIAMS
BV-06
80 mm



PARK
NK-122



PARK-GUYTON
NK-123
80 mm



PARK-MAUMENEE
NK-124
80 mm

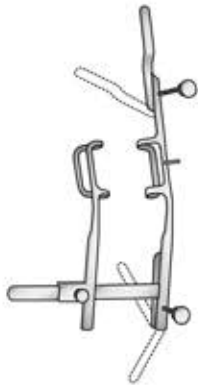

ARRUGA
NK-125
70 mm

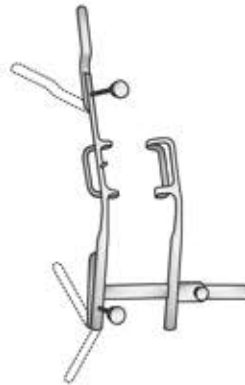

ARRUGA
NK-126
70 mm



MURDOK
NK-127
50 mm



COOK
NK-128
40 mm

Kinder
Children
Bambini
Niños
Enfants



COOK
NK-129
40 mm

Klein
Small
Piccolo



COOK
NK-130
40 mm

Mittel
Medium
Medio



COOK
NK-131
40 mm

Gross
Large
Grande

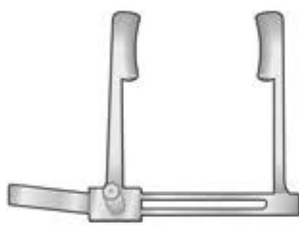

PROST
NK-92
35 mm

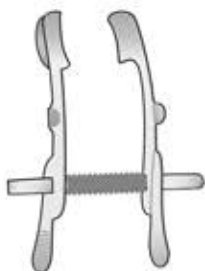

MELLINGER-BEARD
NK-134/NK-135

NK-134
Kinder
Children
Bambini
Niños
Enfants

NK-135
Erwachsene
Adults
Adulti
Adultos
Adultes



SAUER
NK-136
30 mm

Tränensack-Wundspreizer - Lacrimal Sac Retractor - Divaricatore per sacco lacrimale
Separador para saco lacrimal - Écarteurs pour le sac lacrymal



3x3 Zähne
3x3 Dents
3x3 Denti
3x3 Dientes
3x3 Dents

Stumpf
Blunt
Smusso
Romas
Mousse

STEVENSON
NK-137



3x3 Zähne
3x3 Dents
3x3 Denti
3x3 Dientes
3x3 Dents

Spitz
Sharp
Acuta
Aguda
Pointu

MÜLLER
NK-138
70 mm



3x3 Zähne
3x3 Dents
3x3 Denti
3x3 Dientes
3x3 Dents

Spitz
Sharp
Acuta
Aguda
Pointu

AGRICOLA
NK-139

Wundspreizer
Retractors
Divaricatori
Separadores
Écarteurs

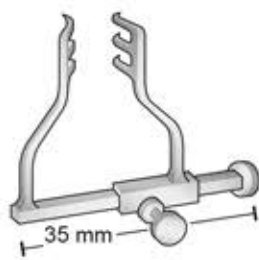

GOLDSTEIN
NK-140
30 mm

Spitz
Sharp
Acuta
Aguda
Pointu

Wundspreizer
Retractors
Divaricatori
Separadores
Écarteurs



AXENFELD
NK-141
80 mm

Spitz
Sharp
Acuta
Aguda
Pointu

4x4 Zähne
4x4 Dents
4x4 Denti
4x4 Dientes
4x4 Dents



BV-08
100 mm

Stumpf
Blunt
Smusso
Romas
Mousse

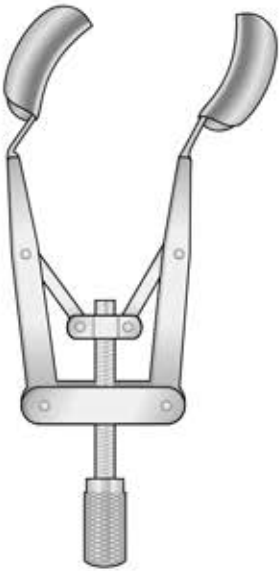

**KERSHNER
NK-420**
80 mm

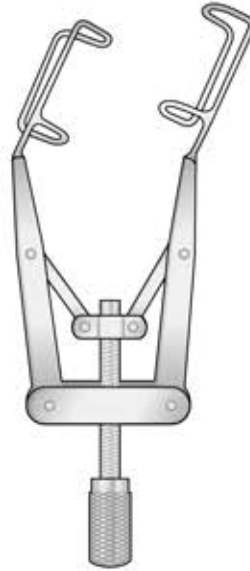

**KERSHNER
NK-421**
80 mm

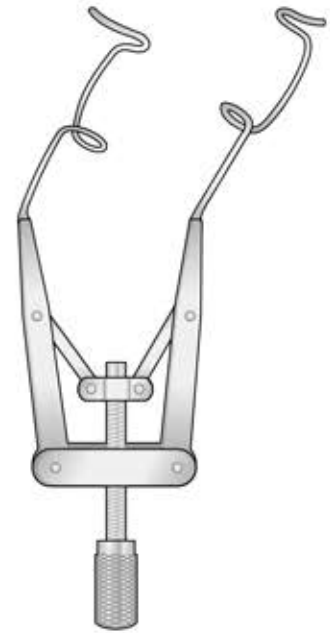

**LIEBERMANN-TENNANT
NK-422**
80 mm

Spülkanüle - Irrigating Cannula



OL-51
45 mm



OL-52
45 mm



OL-50
30 mm



OL-53
35 mm

Zystotom-Kanüle
Cystotome - cannula
Cistotomo - cannula
Cánulas - cistótomos
Canules à cystotome



OL-54
50 mm



**ANEL
OL-55**
30 mm



**ANEL
OL-56**
30 mm

Acciaio Inox malleabile

Ø int. 0,45 mm
Ø est. 0,65 mm



OL-84
73 mm

Acciaio Inox malleabile

Ø int. 0,6 mm
Ø est. 0,8 mm

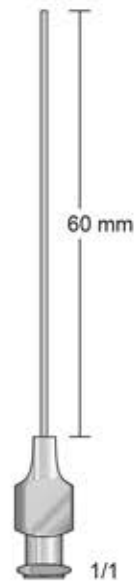

OL-85
73 mm

Irrigating Cannula - Lacrimal Cannula

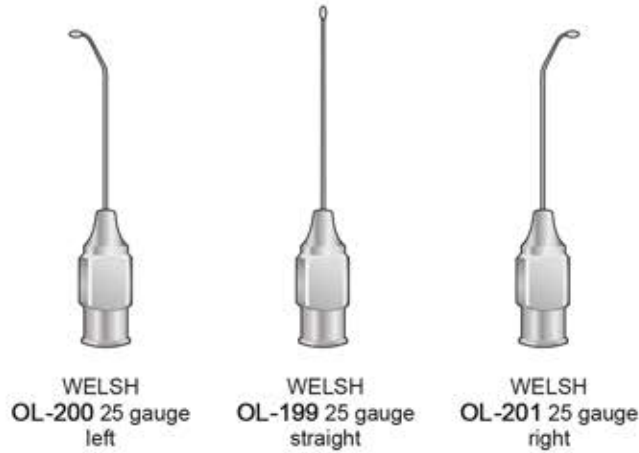

WELSH
OL-200 25 gauge
left

WELSH
OL-199 25 gauge
straight

WELSH
OL-201 25 gauge
right

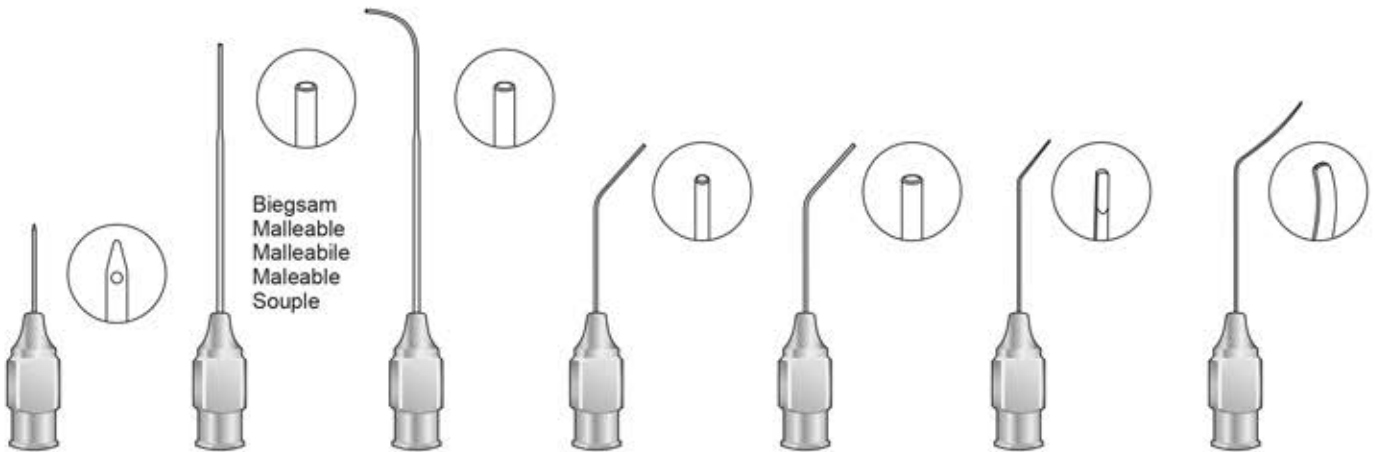

SHAHINIAN
OL-180
23 gauge

OL-181
23 gauge

OL-182
23 gauge

OL-187 30 gauge
OL-188 27 gauge

OL-189 22 gauge
OL-190 19 gauge

RAININ
OL-191 30 gauge
OL-192 27 gauge

RANDOLPH
OL-193 21 gauge
OL-194 19 gauge

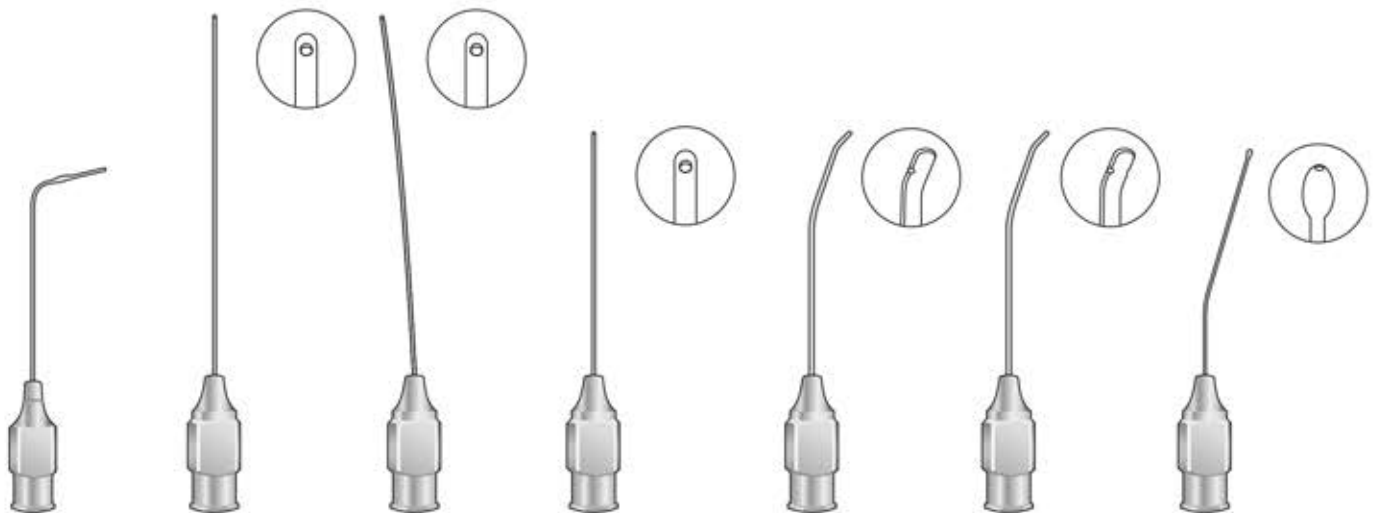

TULEVECH
OL-183
23 gauge

McINTYRE
OL-184
23 gauge

McINTYRE
OL-185
23 gauge

WEST
OL-186
23 gauge

KELMAN
OL-195 right
OL-196 left
19 gauge

SHEETS
OL-197
19 gauge

TROUTMAN
OL-198
25 gauge

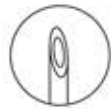

ATKINSON
OL-202 23 gauge
35 mm



McINTYRE
OL-203 19 gauge



Komplett
Complete
Completo
Completo
Complets

McINTYRE
OL-204



McINTYRE
OL-205 0,20 mm
OL-206 0,25 mm
OL-207 0,30 mm

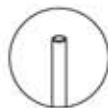

McINTYRE
OL-208
23 gauge



McINTYRE
OL-209
19 gauge

Rechts
Right
Dextra
Derecha
Droite



CESS
OL-210

Links
Left
Sinistra
Izquierda
Gauche



CESS
OL-211



OL-286
 Rechts
 Right
 Destro
 Derecha
 Droite



NISHI
OL-286/OL-287



THURMOND
OL-288
 19 gauge

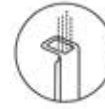

Irrigating Capsule Retractor



NISHI
OL-289

Irrigating Iris Hook



McINTYRE
OL-294
 23 gauge

Lens manipulating Cannula



YOUENS
OL-295
 30 gauge

Infusion Cannula with silicone tubing and adaptor

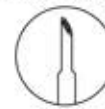

HESLIN
OL-296 25 gauge
OL-297 23 gauge

Irrigating - Aspirating Cannula

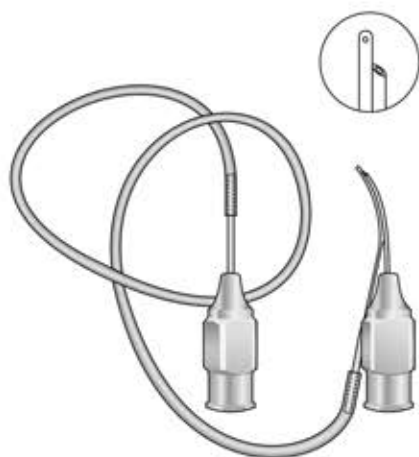

SIMCOE
OL-212

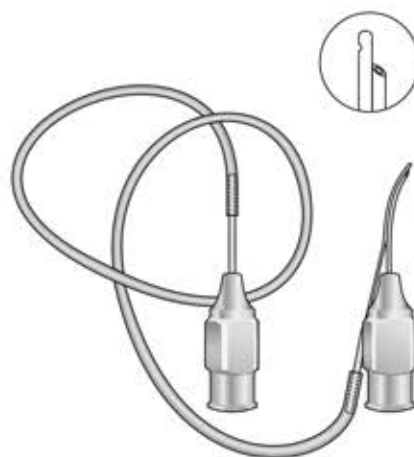

SWISS
OL-213

Reversed

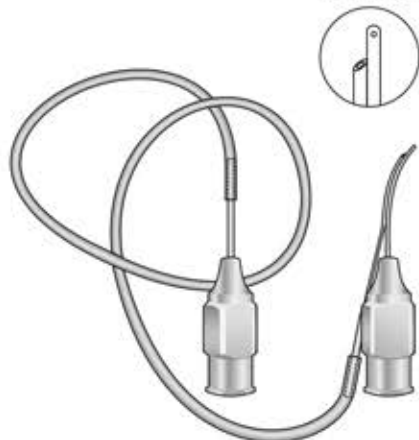

SIMCOE
OL-214

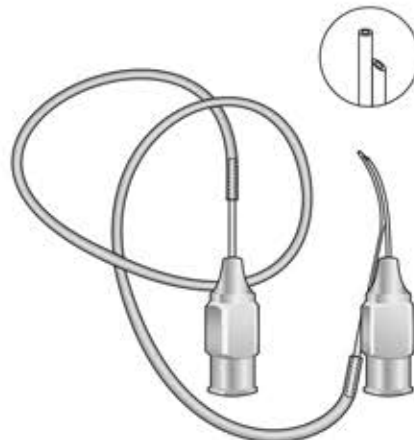

AMBROSIO
OL-215 smooth
OL-216 rough

Irrigating - Aspirating Cannula

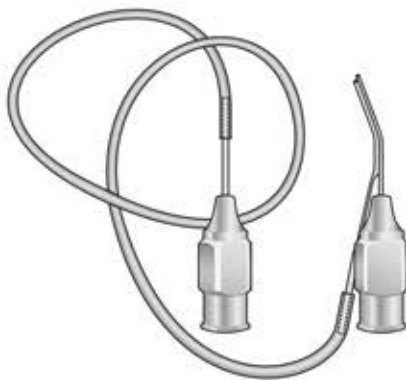

GILLS
OL-217
23 gauge



MORRISON
OL-218
23 gauge Aspirating Tube
25 gauge Irrigating Tube



GRANDON
OL-219



GRANDON
OL-220



GRANDON
OL-221

Silicone Tubing
for I/A Cannulas



OL-222 Tubing and adaptor
OL-223 Tubing only



JENSEN-THOMAS
OL-224

Zystotom-Kanüle
 Cystotome - cannula
 Cistotomo - cannula
 Cánulas - cistótomos
 Canules à cystotome



KELMAN
 OL-225
 22 gauge

KRATZ
 OL-226
 22 gauge

KELMAN
 OL-227
 22 gauge

KELMAN
 OL-228
 22 gauge

OL-229 small size
 OL-230 micro size
 22 gauge

KNOLLE-KELMAN
 OL-231
 22 gauge

McINTYRE
 OL-232
 23 gauge



LIEPPMAN
 OL-233
 22 gauge

GRAETHER
 OL-234 straight
 OL-235 angled

SHAMMAS
 OL-236
 22 gauge

DREWS
 OL-237
 25 gauge

KRAFF
 OL-238
 25 gauge

KRATZ
 OL-239
 22 gauge

RUBMAN-KATZIN
 OL-240
 22 gauge



SHAPIRO
OL-241
23 gauge



JENSEN
OL-242 25 gauge
OL-243 23 gauge



JENSEN
OL-244 25 gauge
OL-245 23 gauge



KNOLLE
OL-246 30 gauge
OL-247 23 gauge



SIMCOE
OL-248 13 mm
OL-249 21 mm



OL-250
25 gauge



GIMBEL
OL-260
30 gauge



SIMCOE
OL-261 13 mm
OL-262 21 mm
23 gauge



KNOLLE
OL-251 30 gauge
OL-252 23 gauge



BRACKEN
OL-253
19 gauge



SALZ
OL-254



McINTYRE
OL-255/OL-259



OL-255 23 gauge, straight
OL-256 23 gauge, angled
OL-257 26 gauge, straight
OL-258 26 gauge, angled
OL-259 30 gauge, angled

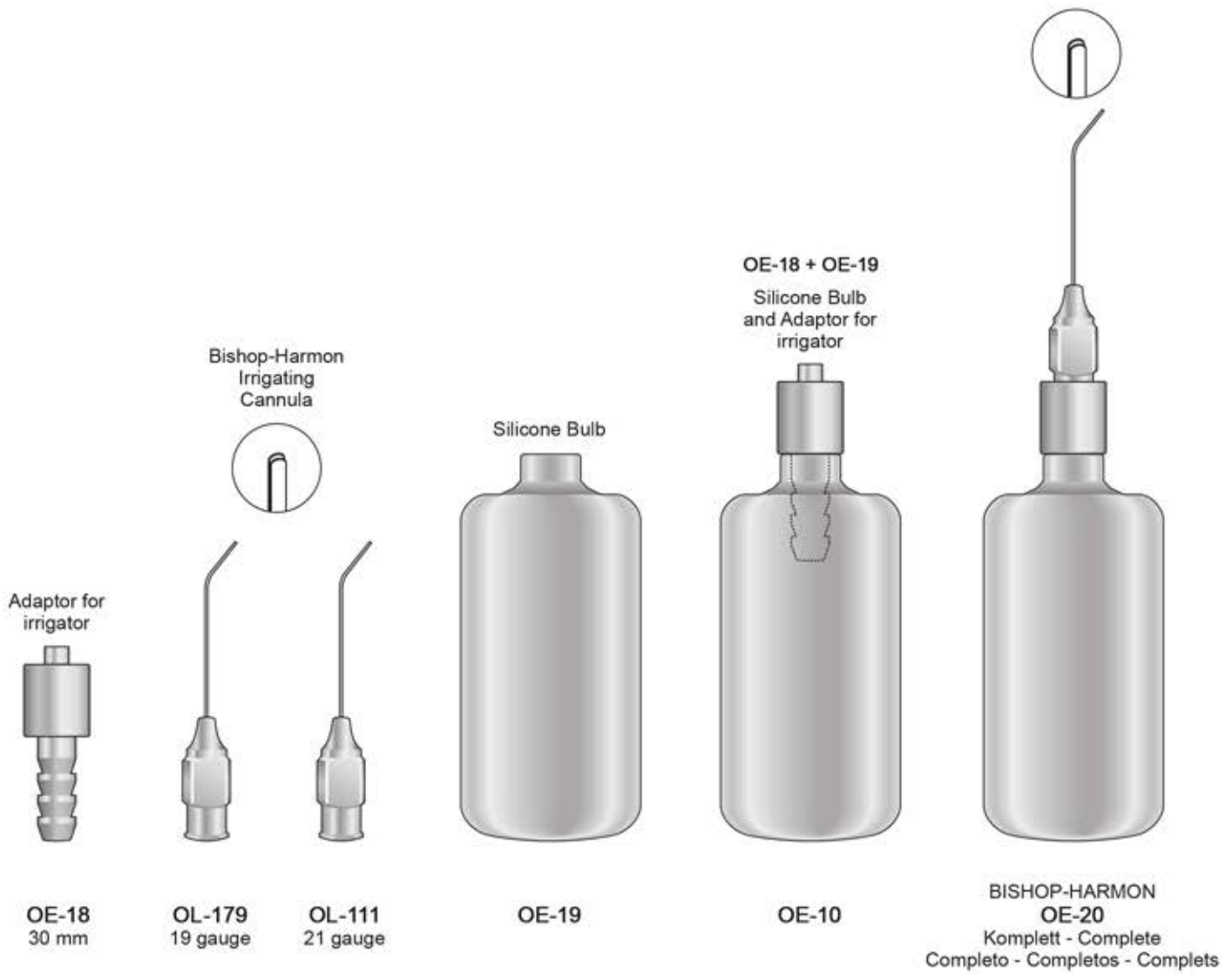

Irrigating - Aspirating Cannula

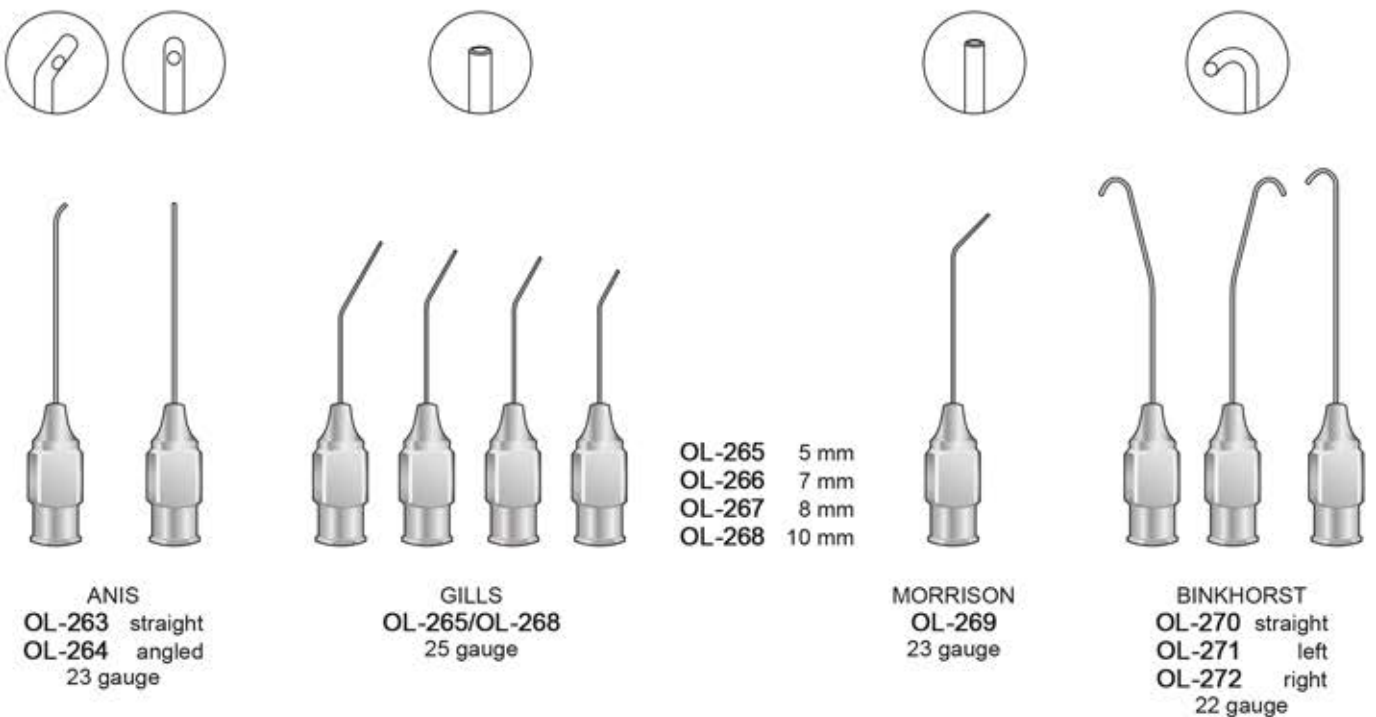



WILBRANDT-BINKHORST
 OL-273 straight
 OL-274 left
 OL-275 right
 23 gauge



McINTYRE-BINKHORST
 OL-276 right
 OL-277 straight
 OL-278 left
 26 gauge



KNOLLE-PEARCE
 OL-279
 23 gauge



DREWS
 OL-280
 23 gauge

Serrated Loop



SHETTS
 OL-281
 20 gauge

Nucleus Loop
 3 mm Wide,
 Serrated



HOFMANN
 OL-282

Irrigating
 Lens nucleus Loop,
 Serrated



SIMCOE
 OL-283 right
 OL-284 left
 25 gauge



ANIS
 OL-285
 23 gauge

Lens manipulating
Cannula

Ø 2mm

Irrigating Lens
manipulatorIrrigating Capsule
RetractorSALTZ
OL-290
20 gaugeKRATZ
OL-291
30 gaugeKUGLEN
OL-292 straight
OL-293 angled
25 gaugeInstrumentständer - Instrument Storage Rack
Supporto per strumenti - Suporte para instrumentos
Support pour instrumentsLagerungsgestell für 15 Stück Nadeln
Rack for 15 needles
Piastra per 15 aghi oftalmici

150 x 100 x 2 mm

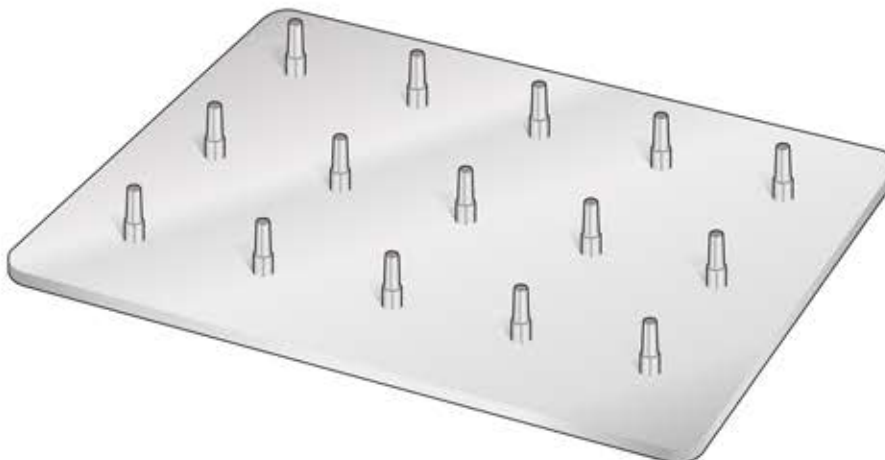

BS-20

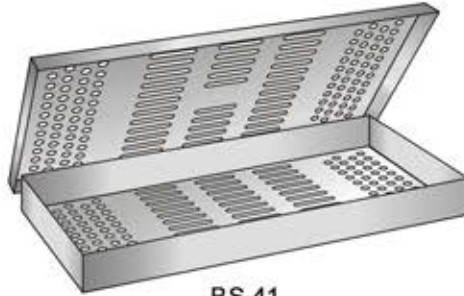
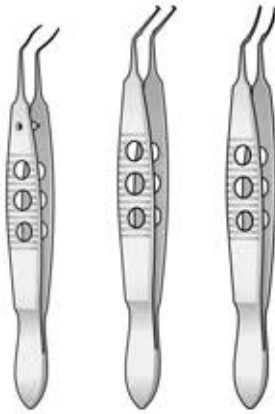

BS-41
275 x 130 x 25 mm

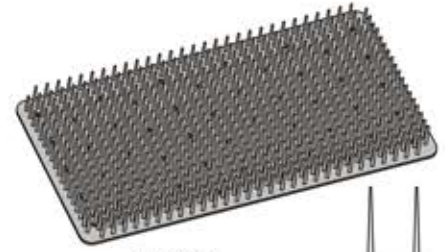

TS-103
260 x 120 mm



JAFFE **LEHNER**
MF-280 **MF-264** **MF-265**
100 mm 105 mm 105 mm

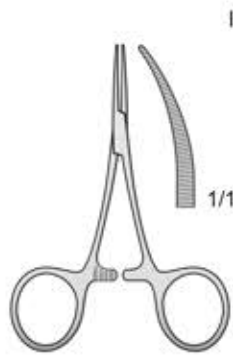

Irisspatel

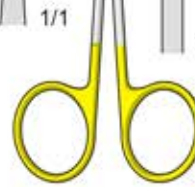

TC



Meßbereich
Measuring range
Campo di misura
Alcance de medición
Etendue de mesure
0 - 20 mm

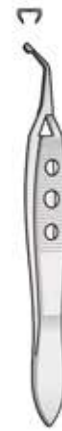
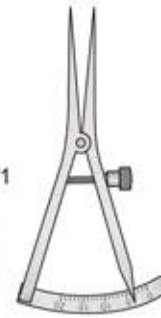

1/1

**HARTMANN-
BABY-MOSQUITO**
P-121
95 mm

**TROUTMAN-
BARRAQUER**
NK-266
Fig.2 90 mm

MF-79
95 mm

MF-158
85 mm

COLIBRI
MF-172
83 mm

BD-42
110 mm

FM-119
115 mm

CASTROVIEJO
OR-17
90 mm

GRAEFE
MF-296 **BD-07**
110 mm 100 mm



1/1



1/1



1/1

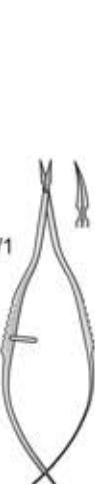

1/1



SISKEY **HIRSCHMANN**
NK-349 **NK-347**
120 mm 120 mm

NK-417
116 mm

BARRAQUER
FD-155
125 mm

BARRAQUER
FD-151
125 mm

FD-100
125 mm

VANNAS
FD-80
85 mm

FD-50
110 mm

**LIEBERMANN-
TENNANT**
NK-422

**BISHOP-
HARMON**
OE-20



VANNAS
FD-79
85 mm

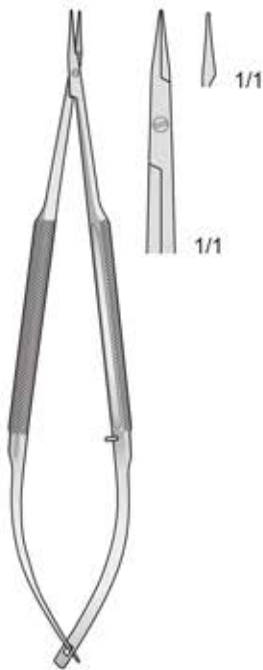

BARRAQUER
FD-152
150 mm



St.MARTIN
MF-200
85 mm

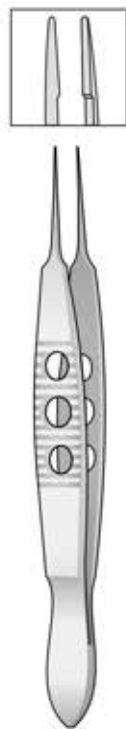

JAFFE
MF-221 Straight
MF-222 Curved
110 mm

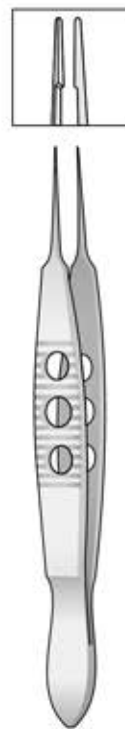

MC PHERSON
MF-231
105 mm



UTRATA
MF-261/MF-262
105 mm

Linsenhaken 0,2 mm
Stumpf, Gerade

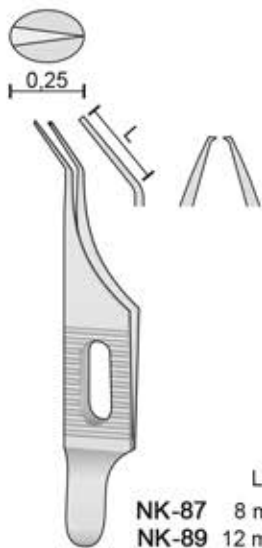

NK-87 8 mm
NK-89 12 mm
NK-87/NK-89
70 mm



TROUTMAN-BARRAQUER
NK-265 0.25 mm x 15 mm
NK-266 0.5 mm x 15 mm
90 mm



SINSKEY
NK-348
120 mm



CASTROVIEJO
NK-23
130 mm

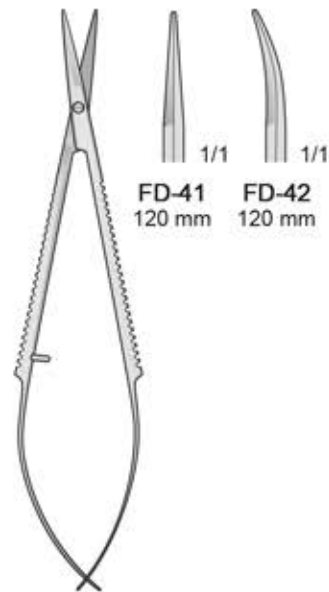

FD-41/FD-42
120 mm

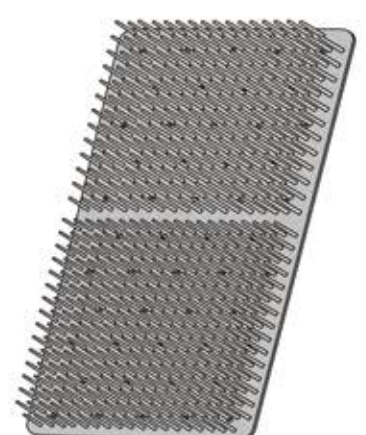
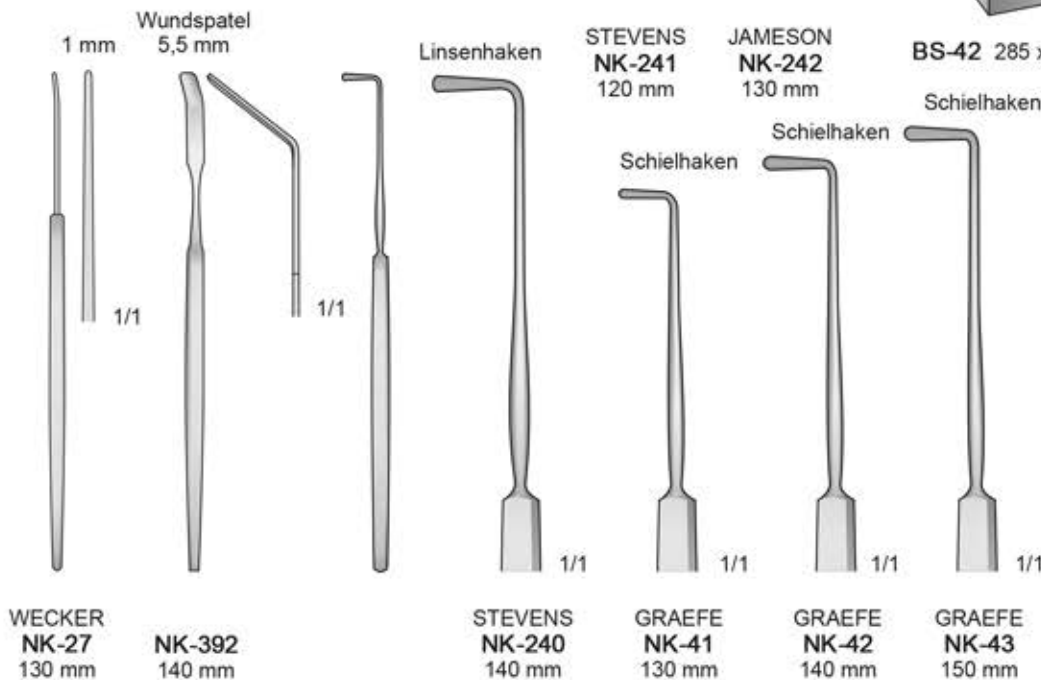
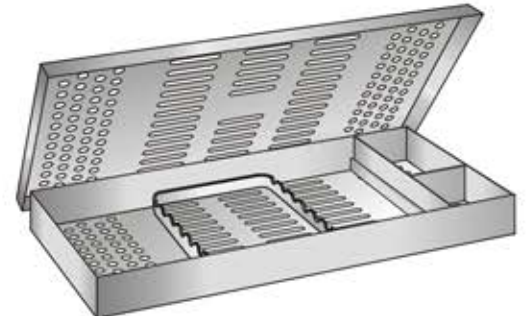
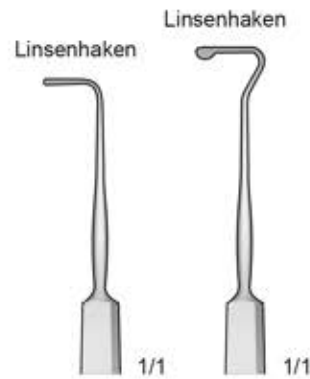
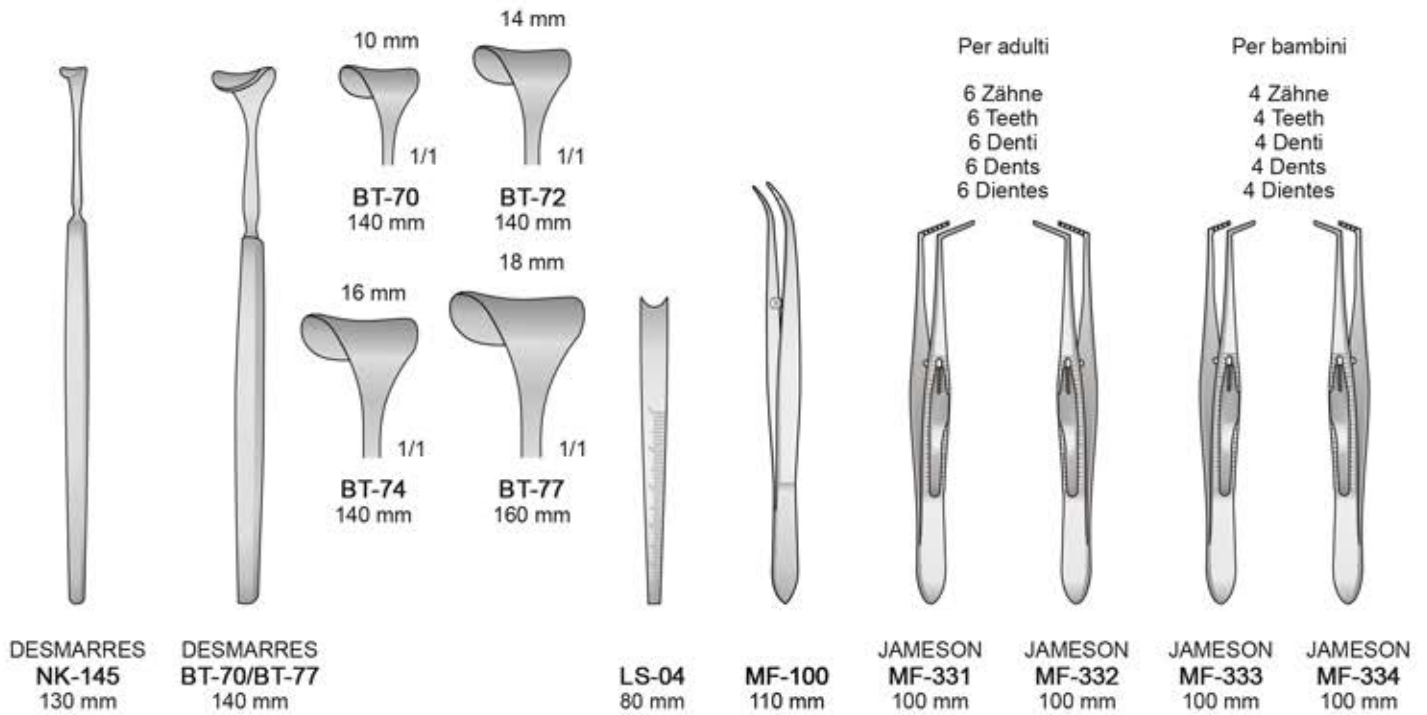

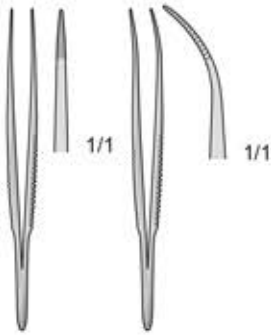

MF-79 95 mm MF-29 95 mm

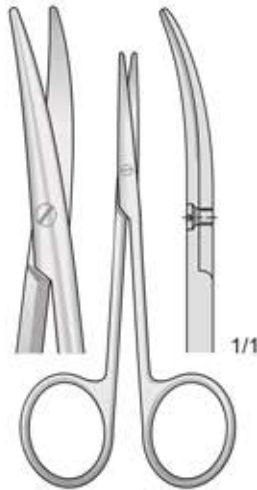

BABY - METZENBAUM FM-48 115 mm



WESTCOTT FD-65 120 mm

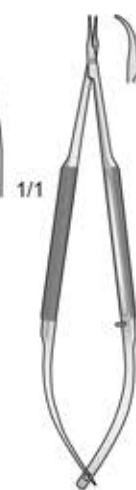

BARRAQUER FD-155 125 mm



BARRAQUER FD-215 120 mm



FD-244 135 mm



LIEBERMANN-TENNANT NK-422 80 mm

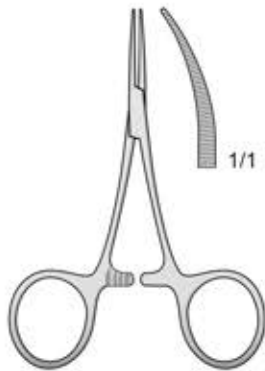

HARTMANN-BABY-MOSQUITO P-121 95 mm

Crochet à strabisme
Strabismus Hooks

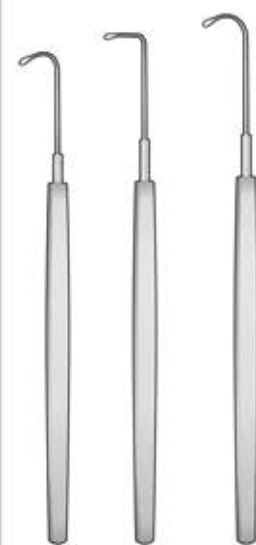

WORST NK-435 130 mm NK-434 135 mm NK-436 140 mm NK-450 100 mm

Muskelhaken



CULLER NK-209 120 mm NK-452 6,0/7,0 mm 118 mm

Strabismus Loops Weiss, Double
Anse da strabismo
Anses à strabisme de weiss, double

1,3 mm 2,0 mm 4,0 mm 4,7 mm

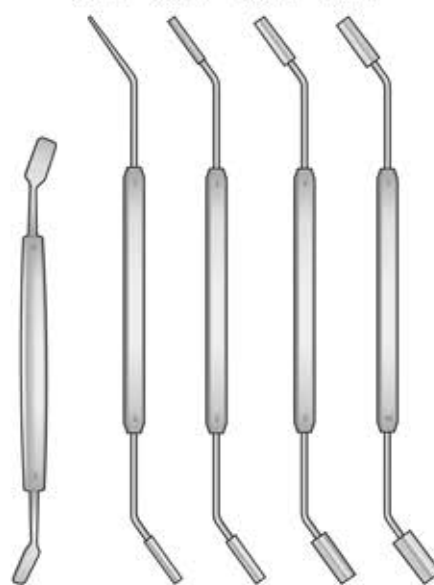

2,6 mm 3,3 mm 5,2 mm 6,6 mm NK-451 4,0/5,0 mm 118 mm NK-456 150 mm NK-457 150 mm NK-458 150 mm NK-459 150 mm

Meßbereich
Measuring range
Campo di misura
Alcance de medición
Etendue de mesure
0 - 20 mm

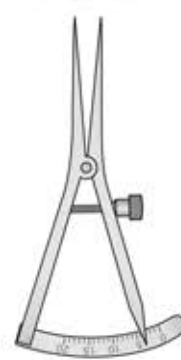

CASTROVIEJO OR-17 90 mm

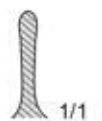

BM-32 1/1



BM-33 1/1



DIEFFENBACH BM-32/BM-33 40 mm

Maintenance and Sterilization

Wartung und Sterilisierung

Maintenance et Stérilisation

Mantenimiento y Esterilización

Manutenzione e Esterilización

Lubricating and sharpening oil

SHARPENOIL

It is a non-coloured oil, which is an indispensable complement for lubricating and manual sharpening of surgical instruments. It should be applied to ensure perfect function and fluid movement of all surgical instruments (on all hinges or all other part which are subject to movement or friction).

Must always be used during all sharpening operations. It is used to activate the abrasive properties of all stones (Arkansas, India, etc.), and to reduce the possibility of overheating the instruments during sharpening.



DB-OL
SCHARPENÖL
30 cc

Bacteriostatic Anti-Corrosion Milk

CLEANLACT

Extends your surgical instrument's lifetime. A periodic use of Cleanlact prevents corrosion; it has a bacteriostatic and lubricating action on all instruments; it guarantees perfect maintenance by eliminating eventual stains, halos and browning due to sterilization, disinfection and washing with tap water. Must use periodically, diluted or concentrated (see special instructions on packaging).



CLEANLACT
DB-10M
250 cc
DB-50M
500 cc
DB-1L
1000 cc

ARKANSAS
Schleifsteine
Sharpening stones
Pietre per affilatura
Materiales para afilar
Pierres d'affutage



DB-299
ARKANSAS
conica n° 299



DB-96
ARKANSAS
piatta n° 8



DB-6A
ARKANSAS n° 6A



DB-4
ARKANSAS
piatta n° 4



DB-22A
ARKANSAS

Sterilbehälter für Nadeln - Box for needles
 Scatola per sterilizzazione aghi da sutura
 Boite pour aiguilles de suture - Estuche para agujas



BS-1
 Ø 78 mm h 15 mm

Jarin glass with lid in stainless steel
 Vaso in vetro con coperchio in acciaio inox
 Pot en verre avec couvercle en acier inox



VPC-6 Ø 100x100 mm
VPC-8 Ø 120x120 mm

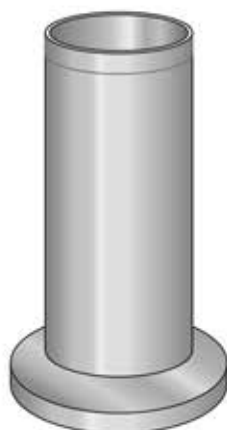

CS-51 Ø 50 mm h 100 mm
CS-52 Ø 50 mm h 150 mm
CS-55 Ø 80 mm h 180 mm



VPC-10 Ø 100x100 mm
VPC-12 Ø 120x120 mm

Runder Sterilbehälter mit Ausguss
 Lotion bowls capsules
 Capsule inox con fondo piano e becco
 Capsule en acier inox



CS-01 Ø 40 mm 15 cc
CS-02 Ø 60 mm 75 cc
CS-03 Ø 80 mm 225 cc
CS-04 Ø 100 mm 325 cc

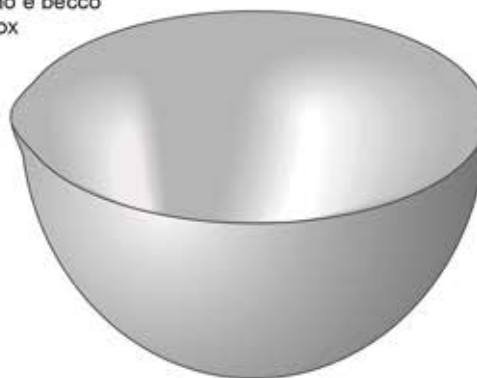

CS-80 Ø 180 mm 1000 cc
CS-81 Ø 200 mm 1450 cc
CS-82 Ø 220 mm 2000 cc
CS-83 Ø 240 mm 3300 cc

Rostfrei - Stainless steel - Inox
Inoxidable

Bacinella a 7 scomparti

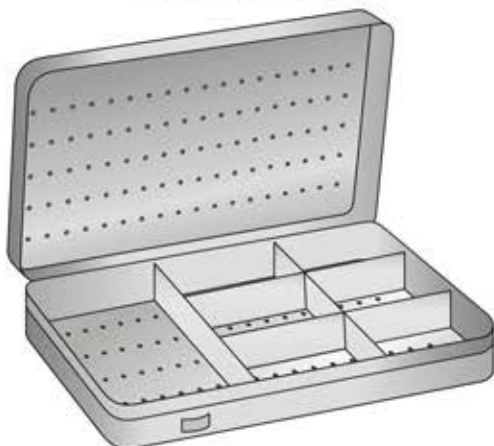

BS-27
150 x 90 x 20 mm

Bacinella a 3 scomparti

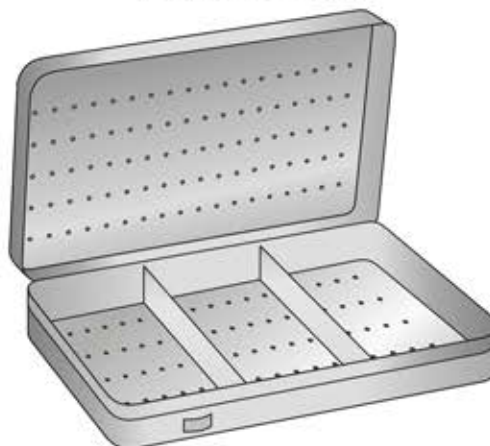

BS-23
150 x 90 x 20 mm

Bacinella a 10 scomparti

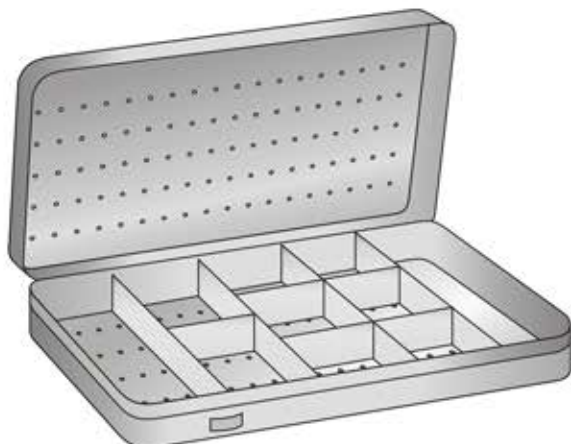

BS-28
220 x 120 x 20 mm

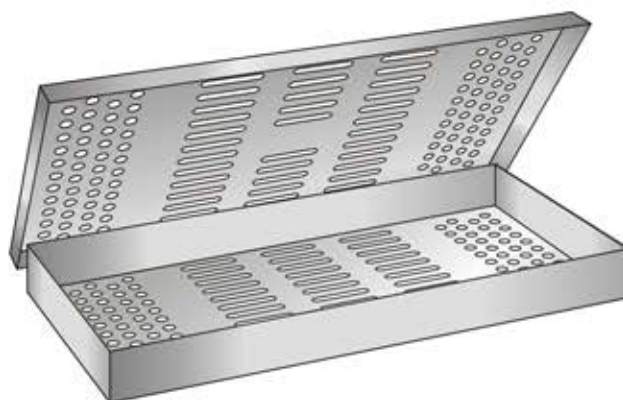

BS-41
275 x 130 x 25 mm

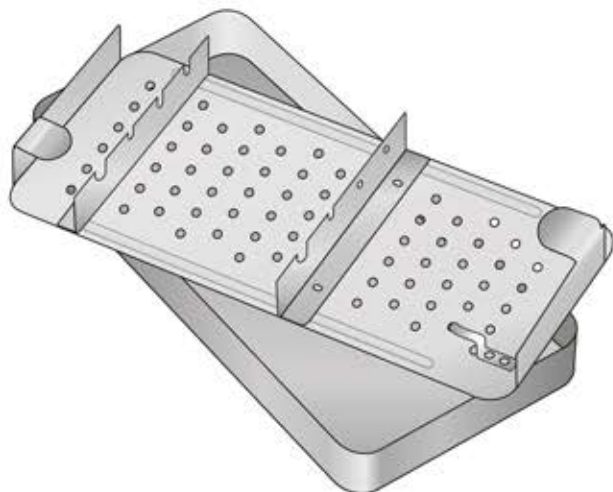

BS-30
180 x 90 x 35 mm 2 ripiani

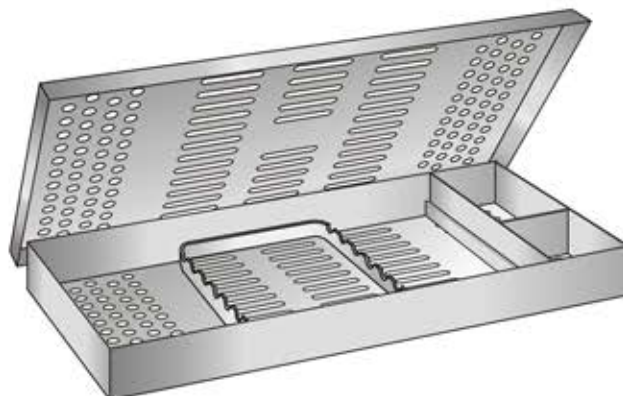

BS-40 275 x 130 x 25 mm Con griglia e scomparti
BS-42 285 x 190 x 25 mm Con griglia e scomparti

Tray Inox mit Silikoneinrichtung - Stainless Steel Cassettes with Silicone Racks
 Tray Inox con griglia in silicone - Recipientes de acero con equipo de silicona
 Cassettes en acier avec aménagement en silicone

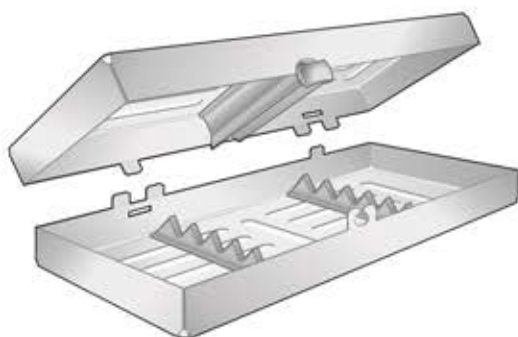

BS-59 Für 5 Instrumente
 185 x 75 x 35 mm For 5 Instruments
 Per 5 strumenti
 Para 5 instrumentos
 Pour 5 instruments

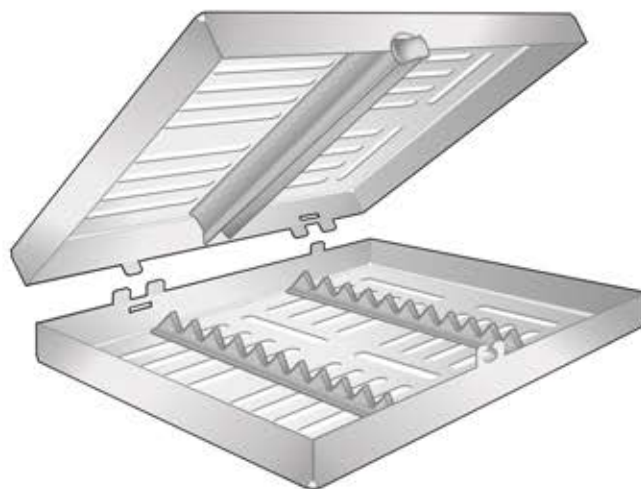

BS-60 Für 10 Instrumente
 185 x 135 x 35 mm For 10 Instruments
 Per 10 strumenti
 Para 10 instrumentos
 Pour 10 instruments

BS-61 Für 20 Instrumente
 290 x 185 x 35 mm For 20 Instruments
 Per 20 strumenti
 Para 20 instrumentos
 Pour 20 instruments

Nierenschalen
 Kidney bowls
 Bacinelle reniformi
 Riñoneras
 Bassins réniformes



BR-20 200 mm
BR-25 250 mm
BR-28 280 mm

Schalen
 Trays
 Vassoi porta-strumenti
 Bandejas
 Bassins



VS-20 210 x 110 x 25 mm
VS-26 250 x 180 x 30 mm
VS-30 300 x 220 x 30 mm

Sterilisierbar
Autoclavable
Autoclavabili

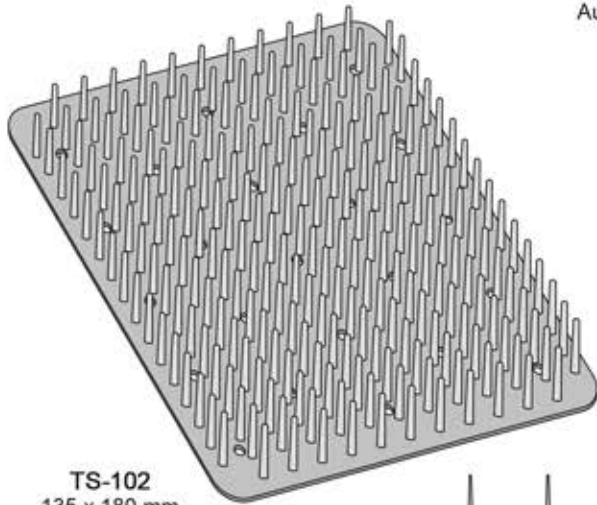

TS-102
135 x 180 mm

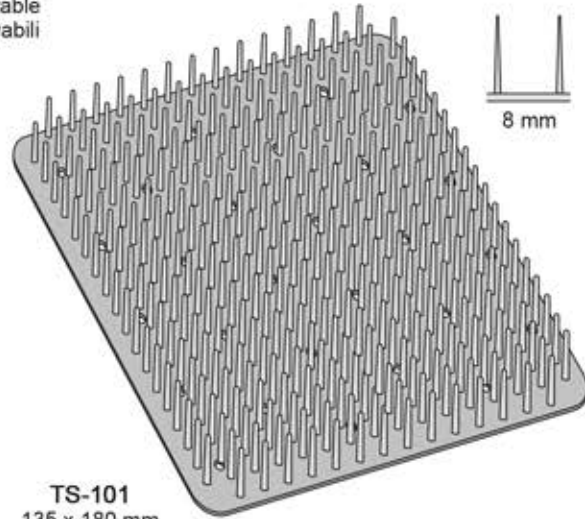
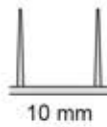

TS-101
135 x 180 mm

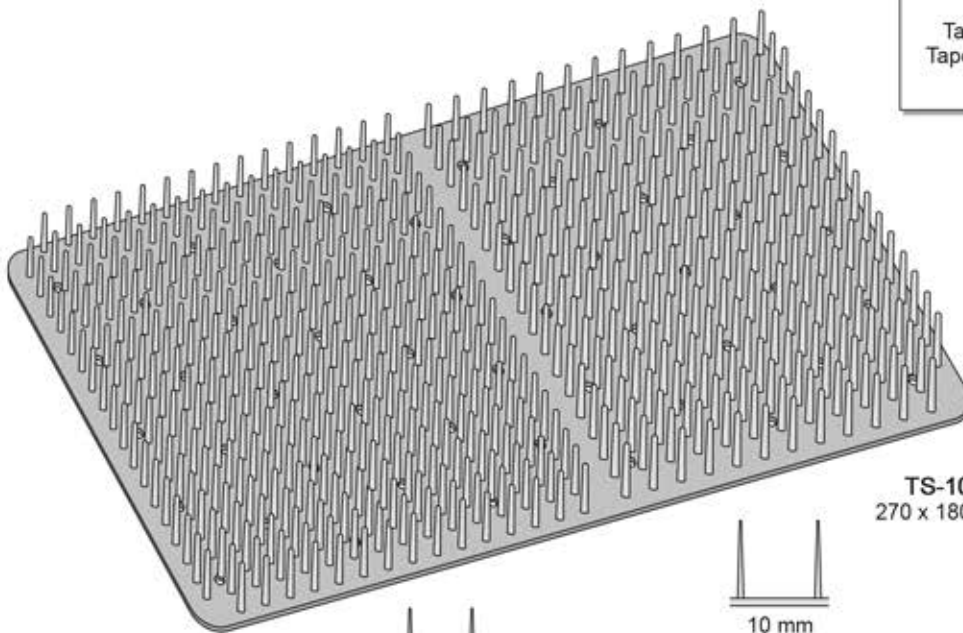

TS-104
270 x 180 mm

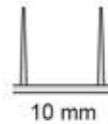

Silikon matte
Matte en silicone
Tappeti in aghi di silicone
Tapete en agujas de silicona
Tapis en Silicone

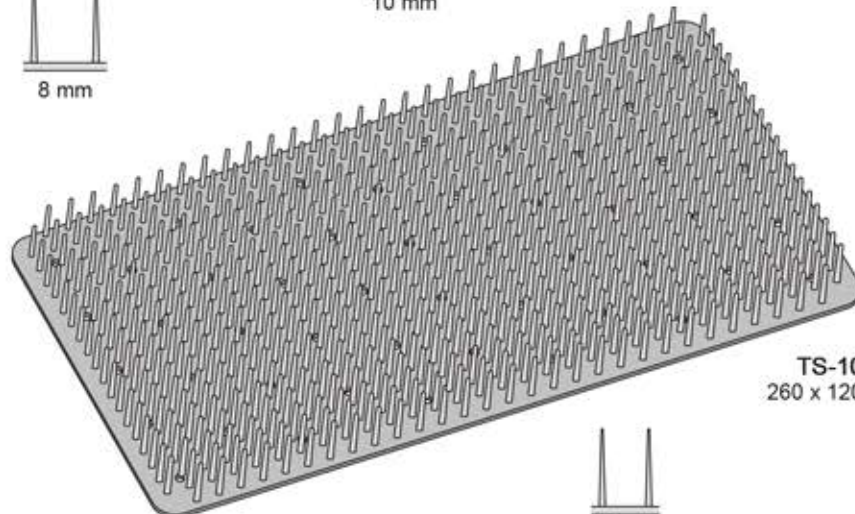

TS-103
260 x 120 mm



Sterilisierzangen zum Fassen und Halten Steriler Instrumente
 Sterilizing forceps for picking up and holding of sterile instruments
 Pinze per prelevare strumenti sterilizzati



GS-02
145 mm



DAVIS
GS-03
160 mm



DAVIS
GS-04
200 mm

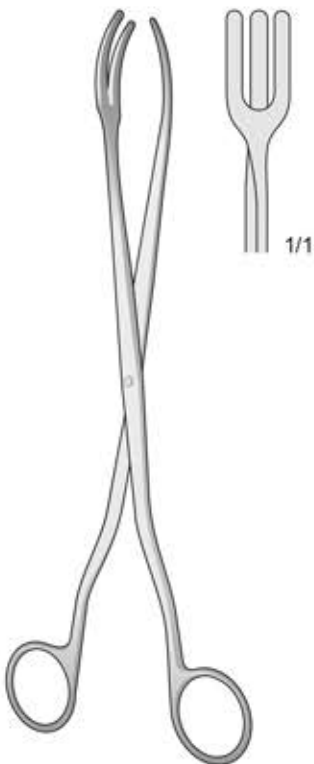

GS-10
200 mm

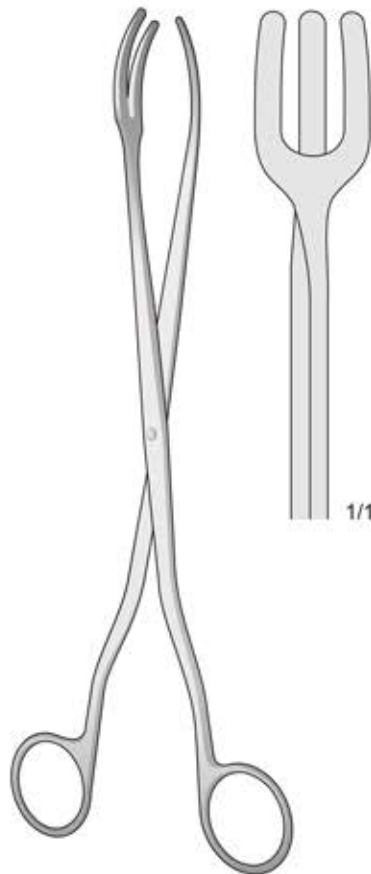

GS-11
300 mm

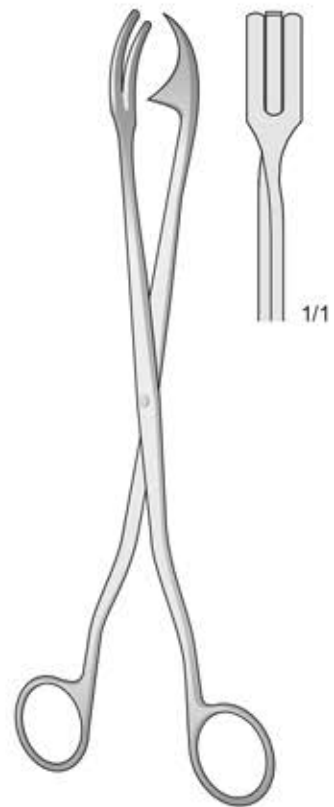

ROGGE
GS-06
230 mm

Alphabetic Index
Alphabetischen Index
Index alphabetique
Indice alfabético
Indice alfabetico

A

AGRICOLA , Lidsperrerr	149
ALLIS , Arterienklemmen	134
ALVIS , Messer	14
AMBROSIO , Augenkanülen	154
AMENABAR , Lidinstrumente	58
ANDERSON-CRITCHETT , Messer	12
ANEL , Augenkanülen	150
ANIS , Augenkanülen	158, 159
- Markierer	145
ARLT , Starschlingen	51
ARROWSMITH , Markierer	144
- Hornhaut und Fixierpinzetten	94
ARRUGA , Lidsperrerr	148
- Messer	4
- Wundlöffel	35
- Haken	37
ARKANSAS , Zubehör	168
ATKINSON , Augenkanülen	152
AXENFELD , Lidsperrerr	149
- Messer	12
- Chalazionslöffel	32
- Wundhaken	35
AYERS , Chirurgische Pinzetten	112

B

BABY-ALLIS , Arterienklemmen	134
BABY-METZENBAUM , Scheren	79
BACKHAUS , Tuchklemmen	134
BANGERTER , Mikro Spatel	50
BARKAN , Messer	13
BARRAQUER , Lidsperrerr	146
- Keratoplastikmesser	17
- Mikro Spatel	48, 49
- Hornhautpinzette	89
- Cilienpinzetten	113
- Mikro Nadelhalter	127, 128, 129, 131, 161, 162
BEAUPRE , Cilienpinzetten	113
BECHERT , Implantations-instrumente	42
BECHERT-McPHERSON , Chirurgische Pinzetten	107
BECKER , Messer	15
BEER , Cilienpinzetten	113
BERKELEY , Markierer	143
BERENS , Messer	8
- Kauter	55
BINKHORST , Augenkanülen	158
BISHOP-HARMON , Chirurgische Pinzetten	82
- Feine Anatomische Pinzetten	83
- Augenkanülen	158, 161
BLASCOVICS , Plastikmesser	18
BONACCOLTO , Fixierpinzetten	93
BONN , Messer	12
- Fadenpinzetten	95, 101, 102, 103, 104
- Implantations-instrumente	43
- Mikro Pinzetten	92
BORES , Hornhaut und Fixierpinzette	94
- Markierer	140, 143, 144
BOTVIN , Mikro Pinzetten	91
BOWMANN , Messer	13
- Tränenkanalsonden	45
- Lidsperrerr	147
BRACKEN , Fixierpinzetten	80
- Augenkanülen	157
BRACKEN-FARKAS , Fixierpinzetten	80
BRAND , Irisretraktor	33
BUNGE , Löffel	23
BURCH , Messer	13

C

CALF , Linsenimplantation	111
CALIPER , Meßinstrumente	135
CASTROVIEJO , Wundhaken	146

- Messer	8
- Tränenkanaldilatatoren	44
- Hornhautscheren	66
- Mikro Spatel	47, 48, 49, 50, 53, 162
- Mikro Nadelhalter	125, 126, 128, 129, 130
- Keratoplastikspatel	57
- Meßinstrumente	135, 161
- Fadenpinzette	99, 101, 104
CHAYET , Markierer	141
CITELLI , Knochenstanzen	28
CLAYMANN-JAFFE , Implantation-Instrumente	43
COLIBRI , Mikro Pinzetten	90
- Hornhautpinzette	88, 161
CONWAY , Lidhalter	59
COOK , Lidsperrerr	148
CULLER , Mikro Spatel	55
- Haken	36, 164

D

DAVIEL , Löffel	30
DAVIS , Sterilisierzangen	173
DE LA ROZA , Unterbindungsnaedeln	38
DESMARRES , Messer	11
- Lidhalter	59, 163
- Chalazionpinzetten	112
DEUTSCHMANN , Messer	4
DIEFFENBACH , Bulldogklemmen	132
DIX , Fremdkörper-Doppelinstrumente	19, 20
DODICK , Chirurgische Pinzetten	109
DREWS , Augenkanülen	156, 159

E

ELLIS , Messer	14
- Markierer	145
ELSCHNIG , Plastikmesser	18
- Löffel	30
- Mikro Spatel	49
- Fixierpinzetten	80
- Starschlingen	51
ERNEST-CALF , Nucleuspinzette	105

F

FAULKNER , Linsenimplantation	110
FINE-THORNTON , Bulbus Ringe	139
FINK , Lidinstrumente	58
FISCHER , Spatel	54
FIXIERKRALLE , Fixazionhaken	35
FRANCIS , Messer	14
FRIEDMANN , Knochenstanzen	27

G

GASKIN , Fadenpinzetten	96
- Chirurgische Pinzetten	106, 109
GESS , Augenkanülen	152
GILLS , Augenkanülen	155, 158
GIMBEL , Augenkanülen	157
- Bulbus Ring	139
GILL , Messer	12
- Mikro Pinzetten	91
GOLDSTEIN , Lidsperrerr	149
GONNIN-AMSLER , Markierinstrument	57
GRAEATHER , Augenkanülen	156
- Implantations-Instrumente	42
GRADLE , Cilienpinzetten	113
GRAEFE , Lidsperrerr	147
- Messer	4, 8, 10, 15
- Löffel	30
- Haken	33, 35
- Scheren	78
- Fixierpinzetten	81

- Feine Anatomische Pinzetten	83, 161
- Mikro Pinzetten	91
- Schielhaken	36, 163
GRANDON , Augenkanülen	155
GREEN , Fixierpinzetten	81
- Spatel	54
- Haken	34
GROSS , Irisretraktor	32
GUTHRIE , Haken	29, 34
GUYTON-LUNDSGAARD , Messer	12

H

HAAB , Messer	10
HABERLE-McPHERSON , Chirurgische Pinzetten	107
HALSTED , Arterienklemmen	133
HALSTED-MOSQUITO , Arterienklemmen	133
HAMBURG , Messer	8
HARMS , Fadenpinzetten	102
- Trabekularsonde	44
HARTMANN , Nasenspeculum	27
HARTMANN-BABY-MOSQUITO , Arterienklemmen	133, 161
HEATH , Löffel	23
HEBRA , Chalazionslöffel	22
HEILDELBERG , Haltende Instrumente	39
HESLIN , Augenkanülen	153
HESS , Löffel	30
- Haken	37
HESSBERG , Unterbindungsnadeln	38
HIRSCHMANN , Implantations-Instrumente	42, 161
HOFFER , Markierer	140, 143
- Fadenpinzetten	104
HOFFER-McPHERSON , Fadenpinzetten	97
HOFMANN , Augenkanülen	159
- Markierer	142
HOFMANN-THORNTON , Bulbus Ring	139
HUNT , Chirurgische Pinzetten	112

I

IRIS , Chirurgische Scheren	76
------------------------------------	----

J

JACOBI , Unterbindungsnadeln	38
JACOBSON , Scheren	73
JAEGER , Lanzenmesser	6
- Lidplatte	58
- Haken	33
JAEGER-GRIESHABER , Lanzenmesser	7
JAFFE , Implantations-Instrumente	43, 161, 162
- Implantations-Instrumente	42, 162
- Chirurgische Pinzetten	108
- Faden Pinzetten	99, 100
JAFFE-KNOLLE , Implantations-Instrumente	42
JAMESON , Chirurgische Pinzetten	112, 163
- Haken	36, 163
JENSEN , Augenkanülen	157
JENSEN-THOMAS , Augenkanülen	155

K

KANSAS , Nucleuspinzetten	105
KAYE , Scheren mit Großen Ringen	75
KELLNAR , Retraktor	44
KELMANN , Augenkanülen	151, 156
- Fadenpinzetten	104
KELMANN-McPHERSON , Fadenpinzetten	96, 97, 98
- Chirurgische Pinzetten	107
KERRISON , Knochenstanzen	28
KERSHNER , Lidsperrerr	150
KIMURA , Mikro Spatel	48
KIRBY , Retraktor	16
- Haken	52

KLAR EVATEUR , Lidhalter	58
KNAPP , Messer	9
- Haken	34
- Mikro Spatel	53
KNAPP-CLARK , Lidsperrerr	147
KNOLLE , Augenkanülen	157
KNOLLE-KELMAN , Augenkanülen	156
KNOLLE-PIERCE , Augenkanülen	159
KRAFF , Augenkanülen	156
- Chirurgische Pinzetten	106
- Nucleuspinzetten	105
KRATZ , Augenkanülen	156, 160
KREMER , Fixierpinzetten	94
KUGLEN , Augenkanülen	160
- Implantations-Instrumente	43
KUHNT , Messer	10, 11
- Fixierpinzetten	80

L

LA FORCE , Messer	3
LA GRANGE , Scheren	77
LAMBERT , Chirurgische Pinzetten	112
LANCASTER , Lidsperrerr	147
LANDOLT , Scheren	78
LEHNER , hirurgische Pinzetten	108, 161
LESTER , Implantations-Instrumente	42
- Fixierpinzetten	93
LEVINSON , Messer	14
LEWIS , Starschlingen	51
LIEBERMANN-TENNANT , Lidsperrerr	150, 161
LIEPPMAN , Augenkanülen	156
LINDNER , Mikro Spatel	53
LINDSTROM , Markierer	142, 145
LISTER-BURCH , Lidsperrerr	147
LITTAUER , Cilienpinzette	113
LIVRNOIS , Implantationspinzette	110, 111
LOCKLIN , Scheren	78
LÖFFEL , Doppelinstrumente	31
LU , Markierer	141
LUENEBURG , Elevatorien	40

M

MACKENSEN , Trabekularsonde	44
MALBRAN , Haken	36
McDONALD , Markierer	143
McGANNEN , Retraktor	35
McGREGOR , Fixierpinzetten	93
McINTYRE , Augenkanülen	151, 152, 153, 156, 157
McINTYRE-BINKHORST , Augenkanülen	159
McPHERSON , Fadenpinzetten	63
- Fadenpinzetten	97, 98, 162
McREYNOLDS , Spatel	54
MEAD , Chirurgische Hammer	29
MELLINGER , Lidsperrerr	146
MELLINGER-AXENFELD , Lidsperrerr	146
MELLINGER-BEARD , Lidsperrerr	149
MENDEZ , Markierer	140, 141, 144
MEYER-SCHWICKERATH , Lokalisator	35
MEYHOEFER , Chalazionslöffel	21
- Doppellöffel	31
MICRO , Fadenpinzetten	95, 103
MICRO-HALSTED , Arterienklemmen	133
MICRO-IRIS , Scheren	76
MINI-FRIEDMANN , Knochenstanzen	27
MOD. BONN , Irishaken	33
MOD. ESSEN , Spatel	56
MOD. FRANKFURT , Spatel	55
MOD. GIESSEN , Spatel	56
MOD. TÜBINGEN , Irishaken	33
MOORFIELD , Doppelinstrumente	31
MORRISON , Augenkanülen	155, 158
MULDOON , Tränenkanaldilatatoren	44
MÜLLER , Lidsperrerr	149
MURDOK , Lidsperrerr	148

N

NANO, Markierer	141
NEW ORLEANS, Starschlingen	51
NEVYAS, Chirurgische Pinzetten	108
NICATI, Messer	14
NISHI, Augenkanülen	153
NORDAN-RUIZ, Markierer	142
NOYES, Scheren	69

O

O'BRIEN, Ligaturscheren	78
O'CONNOR, Haken	34
OSHER, Chirurgische Pinzetten	106
OSHIKA-FAULKNER, Implantationspinzette	110

P

PAPST, Messer	8
PARK, Lidsperrerr	148
PARK-GUYTON, Lidsperrerr	148
PARK-MAUMENEE, Lidsperrerr	148
PATON, Messer	11
- Keratoplastikspatel	57
PAUL, Wundhaken	35
PAUFIQUE, Keratoplastikmesser	17
- Fadenpinzetten	95, 103
PERRY, Chirurgische Pinzetten	82
PHACO, Messer	8
PIANGE, Messer	14
PIERSE, Mikro Pinzetten	90
POLACK, Mikro Pinzetten	90
POTTS-YASARGIL, Scheren	73
PRINCE, Kauter	55
PROST, Lidsperrerr	149

R

RAININ, Augenkanülen	151
RANDOLPH, Augenkanülen	151
REILL, Mikro Nadelhalter	129
RIZZUTI, Haken	52
ROGGE, Sterilisierzangen	173
ROLLET, Messer	15
- Haken	34
RUBMAN-KATZIN, Augenkanülen	156

S

SALTZ, Augenkanülen	157, 160
SATO, Messer	10
SAUTTER, Spatel	56
SAUER, Lidsperrerr	149
SCHAEDEL, Tuchklemmen	134
SCHEIE, Messer	13
SCHEPENS, Lidhalter	58
SCHWEIZER, Messer	14
SCOBEE, Haken	36
SEIFFERT, Sonden	39
SHAAF, Fremdkörppinzette	115
SHAHINIAN, Augenkanülen	151
SHAMMAS, Augenkanülen	156
SHAPIRO, Augenkanülen	157
SHEETS, Augenkanülen	151, 159
SHEETS-McPHERSON, Chirurgische Pinzetten	109
SHEPARD, Implantation-Instrumente	43
SICHEL, Messer	10
SKEELE, Chalazionslöffel	22
SIMCOE, Augenkanülen	154, 157, 159
SINSKEY, Implantations-Instrumente	42, 161
SMITH-FISCHER, Spatel	54
SMITH-GREEN, Messer	4

SNELLEN, Starschlingen	51
- Entropiumpinzetten	113
SNIDER-CASTROVIEJO, Fadenpinzetten	99
SPENCER, Ligaturscheren	78
STARNADEL, Messer	13
STEINERT, Implantationspinzette	110
STEVENS, Haken	36, 163
STEVENS, Scheren	77
STEVENS, Scheren mit Großen Ringen	75
STEVENSON, Lidsperrerr	149
STILLE, Scheren	79
STITCH, Scheren mit Großen Ringen	75
ST.MARTIN, Fadenpinzetten	95, 103, 162
SWISS, Augenkanülen	154

T

TENNANT, Fadenpinzetten	96, 99, 100
TENNANT-TROUMAN, Fixierpinzetten	81
THORNTON, Markierer	140, 141, 142, 143, 145
THORPE, Fixierpinzetten	93
THURMAND, Augenkanülen	153
- Markierer	144
TOOK, Messer	11
TROUTMAN, Augenkanülen	151
- Hornhautscheren	66
- Hornhautpinzetten	89
- Fixierpinzetten	81
- Fadenpinzetten	101, 102, 104
TROUTMANN-BARRAQUER, Mikro Spatel	49, 161, 162
TULEVECH, Augenkanülen	151

U

UTRATA, Chirurgische Pinzetten	108, 162
--------------------------------	----------

V

VANNAS, Federschere	63, 161, 162
VILLASENOR-NAVARRO, Markierer	140
Vitrectomie Instrumente	41
VOLKER, Chirurgische Pinzetten	114
VOLKER-ADSON, Chirurgische Pinzetten	115
VOLKER-CASTROVIEJO, Chirurgische Pinzetten	115
VOLKER-HARMS, Chirurgische Pinzetten	115
VOLKER-MOORFIELD, Chirurgische Pinzetten	114
VOLKER-PATON, Chirurgische Pinzetten	114
VOLKER-THORPE, Chirurgische Pinzetten	114

W

WADSWORTH-TODD, Kauter	55
WALTON, Messer	15
- Scheren mit Großen Ringen	75
WEBER, Messer	9
- Starschlingen	51
WECKER, Messer	10
- Iridektomiescheren	64
- Mikro Spatel	46, 163
- Spatel	55
WELLS, Enukeleationslöffel	30
WEISS, Lidsperrerr	147
WELSH, Augenkanülen	151
WEST, Augenkanülen	151
- Meißel	40
WESTCOTT, Scheren	69
WHEELER, Messer	4
- Mikro Spatel	53
WIENER, Haken	34
WILBRANDT-BINKHORST, Augenkanülen	159
WILDER, Tränenkanaldilatatoren	44
WILLIAMS, Lidsperrerr	147
WILLS-HOSPITAL, Kauter	55
WILMER, Scheren	78

WITSCHEL, Chirurgische Pinzetten	106
WOODRUFF, Unterbindungsnadeln	38
WORST, Schielhaken	37, 164

Y

YASARGIL, Scheren	73
YOSHITOMI-NEUHANN, Chirurgische Pinzetten	107
YOUENS, Augenkanülen	153

Z

ZIEGLER, Messer	9, 10
-----------------	-------

A

AGRICOLA , Eye Speculums	149
ALLIS , Hemostatic Forceps	134
ALVIS , Knives	14
AMBROSIO , Eye Cannulas	154
AMENABAR , Lid Plate	58
ANDERSON-CRITCHETT , Knives	12
ANEL , Eye Cannulas	150
ANIS , Eye Cannulas	158, 159
- Marker	145
ARLT , Lens Loops	51
ARROWSMITH , Marker	144
- Corneal and Fixation Forceps	94
ARRUGA , Eye Speculums	148
- Knives	4
- Protector	35
- Hooks	37
ARKANSAS , Accesories	168
ATKINSON , Eye Cannulas	152
AXENFELD , Eye Speculums	149
- Knives	12
- Chalazion Curettes	32
- Retractors	35
AYERS , Tissue Forceps	112

B

BABY-ALLIS , Hemostatic Forceps	134
BABY-METZENBAUM , Scissors	79
BACKHAUS , Towel Forceps	134
BANGERTER , Micro Spatula	50
BARKAN , Knives	13
BARRAQUER , Eye Speculums	146
- Keratoplasty Knives	17
- Micro Spatel	48, 49
- Corneal Forceps	89
- Cilia Forceps	113
- Micro Needle Holders	127, 128, 129, 131, 161, 162
BEAUPRE , Cilia Forceps	113
BECHERT , Instrument for implantation	42
BECHERT-McPHERSON , Tissue Forceps	107
BECKER , Knives	15
BEER , Cilia Forceps	113
BERKELEY , Marker	143
BERENS , Knives	8
- Cauteries	55
BINKHORST , Eye Cannulas	158
BISHOP-HARMON , Tissue Forceps	82
- Delicate dressing Forceps	83
- Eye Cannulas	158, 161
BLASCOVICS , Plastic-Surgery Knife	18
BONACCOLTO , Fixation Forceps	93
BONN , Knives	12
- Suturing Forceps	95, 101, 102, 103, 104
- Instrument for implantation	43
- Micro Forceps	92
BORES , Corneal Fixation Forceps	94
- Marker	140, 143, 144
BOTVIN , Micro Forceps	91
BOWMANN , Knives	13
- Lachrymal Probes	45
- Eye Cannulas	147
BRACKEN , Fixation Forceps	80
- Eye Cannulas	157
BRACKEN-FARKAS , Fixation Forceps	80
BRAND , Iris Retractor	33
BUNGE , Spoons	23
BURCH , Knives	13

C

CALF , Lens implantation	111
CALIPER , Meßinstrumente	135
CASTROVIEJO , Retractors	146

- Knives	8
- Dilators	44
- Corneal Scissors	66
- Micro Spatula	47, 48, 49, 50, 53, 162
- Micro Needle Holders	125, 126, 128, 129, 130
- Keratoplasty Spatula	57
- Measuring Instruments	135, 161
- Suturing Forceps	99, 101, 104
CHAYET , Marker	141
CITELLI , Bone nibbling Rongeurs	28
CLAYMANN-JAFFE , Instruments for Impiantation	43
COLIBRI , Micro Forceps	90
- Corneal Forceps	88, 161
CONWAY , Lid Retractor	59
COOK , Eye Specula	148
CULLER , Micro Spatula	55
- Hooks	36, 164

D

DAVIEL , Spoons	30
DAVIS , Sterilizing Forcpes	173
DE LA ROZA , Ligature needles	38
DESMARRES , Knives	11
- Lid Retractor	59, 163
- Chalazion Forceps	112
DEUTSCHMANN , Knives	4
DIEFFENBACH , Bulldog Clamps	132
DIX , Foreign Body instruments	19, 20
DODICK , Tissue Forceps	109
DREWS , Eye Cannulas	156, 159

E

ELLIS , Knives	14
- Marker	145
ELSCHNIG , Plastic-Surgery Knife	18
- Spoons	30
- Micro Spatulas	49
- Fixation Forceps	80
- Lens Loops	51
ERNEST-CALF , Nucleus Forceps	105

F

FAULKNER , Lens implantation	110
FINE-THORNTON , Bulb Rings	139
FINK , Lid instruments	58
FISCHER , Spatula	54
FIXIERKRALLE , Fixation Claw	35
FRANCIS , Knives	14
FRIEDMANN , Bone nibbling Rongeur	27

G

GASKIN , Suturing Forceps	96
- Tissue Forceps	106, 109
GESS , Eye Cannulas	152
GILLS , Eye Cannulas	155, 158
GIMBEL , Eye Cannulas	157
- Bulb Rings	139
GILL , Knives	12
- Micro Forceps	91
GOLDSTEIN , Eye Specula	149
GONNIN-AMSLER , Marker	57
GRAEATHER , Eye Cannulas	156
- Instruments for Implantation	42
GRADLE , Cilia Forceps	113
GRAEFE , Eye Specula	147
- Knives	4, 8, 10, 15
- Spoons	30
- Hook	33, 35
- Scissors	78
- Fixation Forceps	81

- Delicate Dressing Forceps	83, 161
- Micro Forceps	91
- Strabismus Hook	36, 163
GRANDON , Eye Cannulas	155
GREEN , Fixation Forceps	81
- Spatulas	54
- Hook	34
GROSS , Iris Retractor	32
GUTHRIE , Hooks	29, 34
GUYTON-LUNDSGAARD , Knives	12

H

HAAB , Knives	10
HABERLE-McPHERSON , Tissue Forceps	107
HALSTED , Hemostatic Forceps	133
HALSTED-MOSQUITO , Hemostatic Forceps	133
HAMBURG , Knives	8
HARMS , Suturing Forceps	102
- Trabecular Probes	44
HARTMANN , Nasal Speculum	27
HARTMANN-BABY-MOSQUITO , Hemostatic Forceps	133, 161
HEATH , Spoons	23
HEBRA , Chalazion Curettes	22
HEILDELBERG , Holding instruments	39
HESLIN , Eye Cannulas	153
HESS , Spoons	30
- Hook	37
HESSBERG , Ligature needle holder	38
HIRSCHMANN , Instruments for implantation	42, 161
HOFFER , Marker	140, 143
- Suturing Forceps	104
HOFFER-McPHERSON , Suturing Forceps	97
HOFMANN , Eye Cannulas	159
- Marker	142
HOFMANN-THORNTON , Bulb Rings	139
HUNT , Tissue Forceps	112

I

IRIS , Operating scissors	76
----------------------------------	----

J

JACOBI , Ligature needle holder	38
JACOBSON , Scissors	73
JAEGER , Keratomes	6
- Lid plate	58
- Hooks	33
JAEGER-GRIESHABER , Keratomes	7
JAFFE , Implanatation Instruments	43, 161, 162
- Implanatation Instruments	42, 162
- Tissue Forceps	108
- Suturing Forceps	99, 100
JAFFE-KNOLLE , Implanatation Instruments	42
JAMESON , Tissue Forceps	112, 163
- Hook	36, 163
JENSEN , Eye cannulas	157
JENSEN-THOMAS , Eye cannulas	155

K

KANSAS , Nucleus Forceps	105
KAYE , Scissors with large rings	75
KELLNAR , Retractor	44
KELMANN , Eye cannulas	151, 156
- Suturing Forceps	104
KELMANN-McPHERSON , Suturing Forceps	96, 97, 98
- Tissue Forceps	107
KERRISON , Bone nibbling Rongeurs	28
KERSHNER , Eye Specula	150
KIMURA , Micro Spatulas	48
KIRBY , Retractors	16
- Hooks	52

KLAR EVATEUR , Lid Retractor	58
KNAPP , Knives	9
- Hooks	34
- Micro Spatulas	53
KNAPP-CLARK , Eye Specula	147
KNOLLE , Eye cannulas	157
KNOLLE-KELMAN , Eye cannulas	156
KNOLLE-PIERCE , Eye cannulas	159
KRAFF , Eye cannulas	156
- Tissue Forceps	106
- Nucleus Forceps	105
KRATZ , Eye cannulas	156, 160
KREMER , Corneal Fixation Forceps	94
KUGLEN , Eye cannulas	160
- Instruments for Implantation	43
KUHNT , Knives	10, 11
- Fixation Forceps	80

L

LA FORCE , Knives	3
LA GRANGE , Scissors	77
LAMBERT , Tissue Forceps	112
LANCASTER , Eye Speculums	147
LANDOLT , Scissors	78
LEHNER , Tissue Forceps	108, 161
LESTER , Instruments for Implantation	42
- Fixation Forceps	93
LEVINSON , Knives	14
LEWIS , Lens Loops	51
LIEBERMANN-TENNANT , Eye Specula	150, 161
LIEPPMAN , Eye cannulas	156
LINDNER , Micro Spatulas	53
LINDSTROM , Marker	142, 145
LISTER-BURCH , Eye Speculums	147
LITTAUER , Cilia Forceps	113
LIVEROIS , Implantation Forceps	110, 111
LOCKLIN , Scissors	78
LÖFFEL , Double Instruments	31
LU , Marker	141
LUENEBURG , Elevator	40

M

MACKENSEN , Trabecular Probes	44
MALBRAN , Hook	36
McDONALD , Marker	143
McGANNEN , Retractor	35
McGREGOR , Fixation Forceps	93
McINTYRE , Eye cannulas	151, 152, 153, 156, 157
McINTYRE-BINKHORST , Eye cannulas	159
McPHERSON , Suturing Forceps	63
- Suturing Forceps	97, 98, 162
McREYNOLDS , Spatula	54
MEAD , Surgical mallet	29
MELLINGER , Eye Speculums	146
MELLINGER-AXENFELD , Eye Speculums	146
MELLINGER-BEARD , Eye Speculums	149
MENDEZ , Marker	140, 141, 144
MEYER-SCHWICKERATH , Retractor	35
MEYHOEFER , Chalazion Curettes	21
- Double Spoon	31
MICRO , Suturing Forceps	95, 103
MICRO-HALSTED , Hemostatic Forceps	133
MICRO-IRIS , Scissors	76
MINI-FRIEDMANN , Bone nibbling Forceps	27
MOD. BONN , Iris Hook	33
MOD. ESSEN , Spatula	56
MOD. FRANKFURT , Spatula	55
MOD. GIESSEN , Spatulas	56
MOD. TÜBINGEN , Iris Hooks	33
MOORFIELD , Double instruments	31
MORRISON , Eye cannulas	155, 158
MULDOON , Lacrymal dilators	44
MÜLLER , Eye Speculums	149
MURDOK , Eye Speculums	148

N

NANO, Marker	141
NEW ORLEANS, Lens Loops	51
NEVYAS, Tissue Forceps	108
NICATI, Knives	14
NISHI, Eye Cannulas	153
NORDAN-RUIZ, Marker	142
NOYES, Scissors	69

O

O'BRIEN, Ligature Scissors	78
O'CONNOR, Hook	34
OSHER, Tissue Forceps	106
OSHIKA-FAULKNER, Implantation Forceps	110

P

PAPST, Knives	8
PARK, Eye Speculums	148
PARK-GUYTON, Eye Speculums	148
PARK-MAUMENEE, Eye Speculums	148
PATON, Knives	11
- Keratoplasty Spatula	57
PAUL, Retractor	35
PAUFIQUE, Keratoplasty Knives	17
- Suturing Forceps	95, 103
PERRY, Tissue Forceps	82
PHACO, Knives	8
PIANGE, Knives	14
PIERSE, Micro Forceps	90
POLACK, Micro Forceps	90
POTTS-YASARGIL, Scissors	73
PRINCE, Cauteries	55
PROST, Eye Speculums	149

R

RAININ, Eye Cannulas	151
RANDOLPH, Eye Cannulas	151
REILL, Micro Needle holders	129
RIZZUTI, Hooks	52
ROGGE, Sterilizing Forceps	173
ROLLET, Knives	15
- Hook	34
RUBMAN-KATZIN, Eye Cannulas	156

S

SALTZ, Eye Cannulas	157, 160
SATO, Knives	10
SAUTTER, Spatulas	56
SAUER, Eye Speculums	149
SCHAEDEL, Towel Forceps	134
SCHEIE, Knives	13
SCHEPENS, Lid Retractor	58
SCHWEIZER, Knives	14
SCOBEE, Hook	36
SEIFFERT, Probes	39
SHAAF, Cilia and Foreign body forceps	115
SHAHINIAN, Eye Cannulas	151
SHAMMAS, Eye Cannulas	156
SHAPIRO, Eye Cannulas	157
SHEETS, Eye Cannulas	151, 159
SHEETS-McPHERSON, Tissue Forceps	109
SHEPARD, Instruments for implantation	43
SICHEL, Knives	10
SKEELE, Chalazion Curettes	22
SIMCOE, Eye Cannulas	154, 157, 159
SINSKEY, Instruments for implantation	42, 161
SMITH-FISCHER, Spatulas	54
SMITH-GREEN, Knives	4

SNELLEN, Lens Loops	51
- Entropium Forceps	113
SNIDER-CASTROVIEJO, Suturing Forceps	99
SPENCER, Ligature Scissors	78
STARNADEL, Knives	13
STEINERT, Implantation Forceps	110
STEVENS, Hooks	36, 163
STEVENS, Scissors	77
STEVENS, Scissors with large rings	75
STEVENSON, Eye Speculums	149
STILLE, Scissors	79
STITCH, Scissors with large rings	75
ST.MARTIN, Suturing Forceps	95, 103, 162
SWISS, Eye Cannulas	154

T

TENNANT, Suturing Forceps	96, 99, 100
TENNANT-TROUMAN, Fixation Forceps	81
THORNTON, Marker	140, 141, 142, 143, 145
THORPE, Fixation Forceps	93
THURMAND, Eye Cannulas	153
- Marker	144
TOOK, Knives	11
TROUTMAN, Eye Cannulas	151
- Corneal Scissors	66
- Corneal Forceps	89
- Fixation Forceps	81
- Suturing Forceps	101, 102, 104
TROUTMANN-BARRAQUER, Micro Spatulas	49, 161, 162
TULEVECH, Eye Cannulas	151

U

UTRATA, Tissue Forceps	108, 162
------------------------	----------

V

VANNAS, Capsulotomy Scissors	63, 161, 162
VILLASENOR-NAVARRO, Marker	140
Vitrectomy Instruments	41
VOLKER, Tissue Forceps	114
VOLKER-ADSON, Tissue Forceps	115
VOLKER-CASTROVIEJO, Tissue Forceps	115
VOLKER-HARMS, Tissue Forceps	115
VOLKER-MOORFIELD, Tissue Forceps	114
VOLKER-PATON, Tissue Forceps	114
VOLKER-THORPE, Tissue Forceps	114

W

WADSWORTH-TODD, Cauteries	55
WALTON, Knives	15
- Scissors with large rings	75
WEBER, Knives	9
- Lens Loops	51
WECKER, Knives	10
- Iridectomy Scissors	64
- Micro Spatulas	46, 163
- Spatulas	55
WELLS, Enucleation Spoon	30
WEISS, Eye Speculums	147
WELSH, Eye Cannulas	151
WEST, Eye Cannulas	151
- Bone Chisel	40
WESTCOTT, Scissors	69
WHEELER, Knives	4
- Micro Spatulas	53
WIENER, Hook	34
WILBRANDT-BINKHORST, Eye Cannulas	159
WILDER, Lacrymal Dilator	44
WILLIAMS, Eye Speculums	147
WILLS-HOSPITAL, Cauteries	55
WILMER, Scissors	78

WITSCHEL, Tissue Forceps	106
WOODRUFF, Ligature needles	38
WORST, Strabismus Hook	37, 164

Y

YASARGIL, Scissors	73
YOSHITOMI-NEUHANN, Tissue Forceps	107
YOUENS, Eye Cannulas	153

Z

ZIEGLER, Knives	9, 10
-----------------	-------

A

AGRICOLA , Blefarostati	149
ALLIS , Pinze emostatiche	134
ALVIS , Coltellini	14
AMBROSIO , Aghi cannule	154
AMENABAR , Strumento per palpebre	58
ANDERSON-CRITCHETT , Coltellino	12
ANEL , Aghi cannule	150
ANIS , Aghi cannule	158, 159
- Marcatori	145
ARLT , Anse per cristallino	51
ARROWSMITH , Marcatori	144
- Pinzette per fissazione corneale	94
ARRUGA , Blefarostati	148
- Coltellini	4
- Protettore	35
- Uncini	37
ARKANSAS , Accessori	168
ATKINSON , Aghi cannule	152
AXENFELD , Blefarostati	149
- Coltellino	12
- Cucchiaino da calazio	32
- Divaricatore	35
AYERS , Pinzette chirurgiche	112

B

BABY-ALLIS , Pinze emostatiche	134
BABY-METZENBAUM , Forbici	79
BACKHAUS , Pinze fissateli	134
BANGERTER , Micro Spatole	50
BARKAN , Coltellino	13
BARRAQUER , Blefarostati	146
- Bisturi per cheratoplastica	17
- Micro Spatole	48, 49
- Pinzette corneali	89
- Pinzette depilatorie	113
- Micro Port'aghi	127, 128, 129, 131, 161, 162
BEAUPRE , Pinzette depilatorie	113
BECHERT , Strumenti per impianti	42
BECHERT-McPHERSON , Pinzette chirurgiche	107
BECKER , Coltellino	15
BEER , Pinzette depilatorie	113
BERKELEY , Marcatore	143
BERENS , Coltellino	8
- Cauterio	55
BINKHORST , Aghi cannule	158
BISHOP-HARMON , Pinzette chirurgiche	82
- Pinzette anatomiche delicate	83
- Aghi cannule	158, 161
BLASCOVICS , Bisturi per chirurgia plastica	18
BONACCOLTO , Pinzette da fissazione	93
BONN , Coltellino	12
- Pinzette da sutura	95, 101, 102, 103, 104
- Strumenti per impianti	43
- Micro Pinzette	92
BORES , Pinzette per fissazione corneale	94
- Marcatori	140, 143, 144
BOTVIN , Micro Pinzette	91
BOWMANN , Coltellino	13
- Sonda lacrimali	45
- Blefarostati	147
BRACKEN , Pinzette da fissazione	80
- Aghi cannule	157
BRACKEN-FARKAS , Pinzette da fissazione	80
BRAND , Retrattore per iride	33
BUNGE , Cucchiaini	23
BURCH , Coltellino	13

C

CALF , Pinzette per impianti	111
CALIPER , Meßinstrumente	135
CASTROVIEJO , Divaricatori	146

- Coltellino	8
- Dilatore lacrimale	44
- Forbici corneali	66
- Micro spatola	47, 48, 49, 50, 53, 162
- Micro Port'aghi	125, 126, 128, 129, 130
- Spatola per cheratoplastica	57
- Strumento per misurazione	135, 161
- Pinzette da sutura	99, 101, 104
CHAYET , Marcatore	141
CITELLI , Pinze ossivore	28
CLAYMANN-JAFFE , Strumenti per impianti	43
COLIBRI , Micro Pinzette	90
- Pinzette corneali	88, 161
CONWAY , Retrattore palpebrale	59
COOK , Blefarostati	148
CULLER , Micro spatola	55
- Uncino	36, 164

D

DAVIEL , Cucchiaini	30
DAVIS , Pinze per prelevare strumenti sterilizzati	173
DE LA ROZA , Aghi per legature	38
DESMARRES , Coltellino	11
- Retrattori palpebrali	59, 163
- Pinzette da calazio	112
DEUTSCHMANN , Coltellino	4
DIEFFENBACH , Pinze Bulldog	132
DIX , Strumenti per corpi estranei	19, 20
DODICK , Pinzette chirurgiche	109
DREWS , Aghi cannule	156, 159

E

ELLIS , Coltellino	14
- Marcatori	145
ELSCHNIG , Bisturi per chirurgia plastica	18
- Cucchiaini	30
- Micro Spatole	49
- Pinzette da fissazione	80
- Anse per cristallino	51
ERNEST-CALF , Pinzette per nucleo	105

F

FAULKNER , Pinzette per impianti	110
FINE-THORNTON , Anello per bulbo	139
FINK , Strumenti per palpebre	58
FISCHER , Spatola	54
FIXIERKRALLE , Uncino doppio	35
FRANCIS , Coltellino	14
FRIEDMANN , Pinze ossivore	27

G

GASKIN , Pinzette da sutura	96
- Pinzette chirurgiche	106, 109
GESS , Aghi cannule	152
GILLS , Aghi cannule	155, 158
GIMBEL , Aghi cannule	157
- Anello per bulbo	139
GILL , Coltellino	12
- Micro Pinzette	91
GOLDSTEIN , Blefarostato	149
GONNIN-AMSLER , Compasso marcatore	57
GRAEATHER , Aghi cannule	156
- Strumenti per impianti	42
GRADLE , Pinzette depilatorie	113
GRAEFE , Blefarostati	147
- Coltellini	4, 8, 10, 15
- Cucchiaini	30
- Uncini	33, 35
- Forbici	78
- Pinzette da fissazione	81

- Pinzette anatomiche delicate	83, 161
- Micro Pinzette	91
- Uncino da strabismo	36, 163
GRANDON , Aghi cannule	155
GREEN , Pinzette da fissazione	81
- Spatole	54
- Uncino	34
GROSS , Retrattori per iride	32
GUTHRIE , Uncini	29, 34
GUYTON-LUNDSGAARD , Coltellino	12

H

HAAB , Coltellino	10
HABERLE-McPHERSON , Pinzette chirurgiche	107
HALSTED , Pinze emostatiche	133
HALSTED-MOSQUITO , Pinze emostatiche	133
HAMBURG , Coltellino	8
HARMS , Pinzette da sutura	102
- Trabeculotomo	44
HARTMANN , Speculum nasale	27
HARTMANN-BABY-MOSQUITO , Pinze emostatiche	133, 161
HEATH , Cucchiali	23
HEBRA , Cucchiali da calazio	22
HEILDELBERG , Portacotone	39
HESLIN , Aghi cannule	153
HESS , Cucchiaio	30
- Uncino	37
HESSBERG , Ago per legature	38
HIRSCHMANN , Strumenti per impianti	42, 161
HOFFER , Marcatori	140, 143
- Pinzette da sutura	104
HOFFER-McPHERSON , Pinzette da sutura	97
HOFMANN , Aghi cannule	159
- Marcatore	142
HOFMANN-THORNTON , Anello per bulbo	139
HUNT , Pinzette chirurgiche	112

I

IRIS , Forbici chirurgiche	76
-----------------------------------	----

J

JACOBI , Ago per legature	38
JACOBSON , Forbici	73
JAEGER , Cherartotomi	6
- Placca per palpebre	58
- Uncini	33
JAEGER-GRIESHABER , Cheratotomi	7
JAFFE , Strumento per impianti	43, 161, 162
- Strumento per impianti	42, 162
- Pinzette chirurgiche	108
- Pinzette da sutura	99, 100
JAFFE-KNOLLE , Strumenti per impianti	42
JAMESON , Pinzette chirurgiche	112, 163
- Uncino	36, 163
JENSEN , Aghi cannule	157
JENSEN-THOMAS , Aghi cannule	155

K

KANSAS , Pinzette per nucleo	105
KAYE , Forbici ad anelli grandi	75
KELLNAR , Retrattore	44
KELMANN , Aghi cannule	151, 156
- Pinzette da sutura	104
KELMANN-McPHERSON , Pinzette da sutura	96, 97, 98
- Pinzette chirurgiche	107
KERRISON , Pinze ossivore	28
KERSHNER , Blefarostati	150
KIMURA , Micro Spatole	48
KIRBY , Retrattori	16
- Uncini	52

KLAR EVATEUR , Retrattore palpebrale	58
KNAPP , Coltellini	9
- Uncini	34
- Micro spatole	53
KNAPP-CLARK , Blefarostato	147
KNOLLE , Aghi cannule	157
KNOLLE-KELMAN , Aghi cannule	156
KNOLLE-PIERCE , Aghi cannule	159
KRAFF , Aghi cannule	156
- Pinzette chirurgiche	106
- Pinzette per nucleo	105
KRATZ , Aghi cannule	156, 160
KREMER , Pinzette per fissazione corneale	94
KUGLEN , Aghi cannule	160
- Strumenti per impianti	43
KUHNT , Coltellini	10, 11
- Pinzette da fissazione	80

L

LA FORCE , Coltellino	3
LA GRANGE , Forbici	77
LAMBERT , Pinzette chirurgiche	112
LANCASTER , Blefarostato	147
LANDOLT , Forbici	78
LEHNER , Pinzette chirurgiche	108, 161
LESTER , Strumenti per impianti	42
- Pinzette da fissazione	93
LEVINSON , Coltellino	14
LEWIS , Anse per cristallino	51
LIEBERMANN-TENNANT , Blefarostato	150, 161
LIEPPMAN , Aghi cannule	156
LINDNER , Micro Spatole	53
LINDSTROM , Marcatori	142, 145
LISTER-BURCH , Blefarostato	147
LITTAUER , Pinzette depilatorie	113
LIVEROIS , Pinzette per impianti	110, 111
LOCKLIN , Forbici	78
LÖFFEL , Strumenti doppi	31
LU , Marcatore	141
LUENEBURG , Elevatore	40

M

MACKENSEN , Trabeculotomo	44
MALBRAN , Uncino	36
McDONALD , Marcatore	143
McGANNEN , Retrattore	35
McGREGOR , Pinzette da fissazione	93
McINTYRE , Aghi cannule	151, 152, 153, 156, 157
McINTYRE-BINKHORST , Aghi cannule	159
McPHERSON , Pinzette da sutura	63
- Pinzette da sutura	97, 98, 162
McREYNOLDS , Spatola	54
MEAD , Martello chirurgico	29
MELLINGER , Blefarostato	146
MELLINGER-AXENFELD , Blefarostato	146
MELLINGER-BEARD , Blefarostato	149
MENDEZ , Marcatore	140, 141, 144
MEYER-SCHWICKERATH , Localizzatore	35
MEYHOEFER , Cucchiali da calazio	21
- Cucchiaio doppio	31
MICRO , Pinzette da sutura	95, 103
MICRO-HALSTED , Pinze emostatiche	133
MICRO-IRIS , Forbici	76
MINI-FRIEDMANN , Pinze ossivore	27
MOD. BONN , Uncini da iride	33
MOD. ESSEN , Spatole	56
MOD. FRANKFURT , Spatola	55
MOD. GIESSEN , Spatole	56
MOD. TÜBINGEN , Uncini da iride	33
MOORFIELD , Strumento doppio	31
MORRISON , Aghi cannule	155, 158
MULDOON , Dilatatore lacrimale	44
MÜLLER , Blefarostato	149
MURDOK , Blefarostato	148

N

NANO, Marcatori	141
NEW ORLEANS, Anse per cristallino	51
NEVYAS, Pinzette Chirurgiche	108
NICATI, Coltellino	14
NISHI, Aghi cannule	153
NORDAN-RUIZ, Marcatori	142
NOYES, Forbici	69

O

O'BRIEN, Forbici per legature	78
O'CONNOR, Uncino	34
OSHER, Pinzette chirurgiche	106
OSHIKA-FAULKNER, Pinzette per impianti	110

P

PAPST, Coltellino	8
PARK, Blefarostato	148
PARK-GUYTON, Blefarostato	148
PARK-MAUMENEE, Blefarostato	148
PATON, Coltellino	11
- Spatola per cheratoplastica	57
PAUL, Divaricatore	35
PAUFIQUE, Bisturi per cheratoplastica	17
- Pinzette da sutura	95, 103
PERRY, Pinzette chirurgiche	82
PHACO, Coltellino	8
PIANGE, Coltellino	14
PIERSE, Micro Pinzette	90
POLACK, Micro Pinzette	90
POTTS-YASARGIL, Forbici	73
PRINCE, Cauterio	55
PROST, Blefarostati	149

R

RAININ, Aghi cannule	151
RANDOLPH, Aghi cannule	151
REILL, Micro Port'aghi	129
RIZZUTI, Uncini	52
ROGGE, Pinze per prelevare strumenti sterilizzati	173
ROLLET, Coltellino	15
- Uncino	34
RUBMAN-KATZIN, Aghi cannule	156

S

SALTZ, Aghi cannule	157, 160
SATO, Coltellino	10
SAUTTER, Spatole	56
SAUER, Blefarostato	149
SCHAEDEL, Pinze fissateli	134
SCHIEI, Coltellino	13
SCHEPENS, Retrattore palpebrale	58
SCHWEIZER, Coltellino	14
SCOBEE, Uncino	36
SEIFFERT, Sonda	39
SHAAF, Pinzette per cilia e corpi estranei	115
SHAHINIAN, Aghi cannule	151
SHAMMAS, Aghi cannule	156
SHAPIRO, Aghi cannule	157
SHEETS, Aghi cannule	151, 159
SHEETS-McPHERSON, Pinzette chirurgiche	109
SHEPARD, Strumenti per impianti	43
SICHEL, Coltellino	10
SKEELE, Cucchiari da calazio	22
SIMCOE, Aghi cannule	154, 157, 159
SINSKEY, Strumenti per impianti	42, 161
SMITH-FISCHER, Spatola	54
SMITH-GREEN, Coltellino	4

SNELLEN, Anse per cristallino	51
- Pinzette da entropion	113
SNIDER-CASTROVIEJO, Pinzette da sutura	99
SPENCER, Forbici per legature	78
STARNADEL, Coltellino	13
STEINERT, Pinzette per impianti	110
STEVENS, Uncini	36, 163
STEVENS, Forbici	77
STEVENS, Forbici ad anelli grandi	75
STEVENSON, Blefarostato	149
STILLE, Forbici	79
STITCH, Forbici ad anelli grandi	75
ST.MARTIN, Pinzette da sutura	95, 103, 162
SWISS, Aghi cannule	154

T

TENNANT, Pinzette da sutura	96, 99, 100
TENNANT-TROUMAN, Pinzette da fissazione	81
THORNTON, Marcatori	140, 141, 142, 143, 145
THORPE, Pinzette da fissazione	93
THURMAND, Aghi cannule	153
- Marcatore	144
TOOK, Coltellino	11
TROUTMAN, Aghi cannule	151
- Forbici corneali	66
- Pinzette corneali	89
- Pinzette da fissazione	81
- Pinzette da sutura	101, 102, 104
TROUTMANN-BARRAQUER, Micro spatole	49, 161, 162
TULEVECH, Aghi cannule	151

U

UTRATA, Pinzette chirurgiche	108, 162
------------------------------	----------

V

VANNAS, Forbici per cataratta	63, 161, 162
VILLASENOR-NAVARRO, Marcatore	140
Vitrectomia, Pinze e forbici	41
VOLKER, Pinzette chirurgiche	114
VOLKER-ADSON, Pinzette chirurgiche	115
VOLKER-CASTROVIEJO, Pinzette chirurgiche	115
VOLKER-HARMS, Pinzette chirurgiche	115
VOLKER-MOORFIELD, Pinzette chirurgiche	114
VOLKER-PATON, Pinzette chirurgiche	114
VOLKER-THORPE, Pinzette chirurgiche	114

W

WADSWORTH-TODD, Cauterio	55
WALTON, Coltellino	15
- Forbici ad anelli grandi	75
WEBER, Coltellino	9
- Anse per cristallino	51
WECKER, Coltellino	10
- Forbici per iridectomia	64
- Micro Spatole	46, 163
- Spatole	55
WELLS, Cucchiario da enucleazione	30
WEISS, Blefarostati	147
WELSH, Aghi cannule	151
WEST, Aghi cannule	151
- Scalpelli da osso	40
WESTCOTT, Forbici	69
WHEELER, Coltellino	4
- Micro Spatole	53
WIENER, Uncino	34
WILBRANDT-BINKHORST, Aghi cannule	159
WILDER, Dilatatori lacrimali	44
WILLIAMS, Blefarostati	147
WILLS-HOSPITAL, Cauterio	55
WILMER, Forbici	78

WITSCHEL, Pinzette chirurgiche	106
WOODRUFF, Aghi per legature	38
WORST, Uncini da strabismo	37, 164

Y

YASARGIL, Forbici	73
YOSHITOMI-NEUHANN, Pinzette chirurgiche	107
YOUENS, Aghi cannule	153

Z

ZIEGLER, Coltellini	9, 10
---------------------	-------

A

AGRICOLA , Blefarostatos	149
ALLIS , Pinzas hemostáticas	134
ALVIS , Cuchillee	14
AMBROSIO , Cánulas para ojos	154
AMENABAR , Instrumentos para párpados	58
ANDERSON-CRITCHETT , Cuchillee	12
ANEL , Cánulas para ojos	150
ANIS , Cánulas para ojos	158, 159
- Marcadores	145
ARLT , Asas de lentes	144
ARROWSMITH , Marcadores	144
- Pinzas para fijación corneal	94
ARRUGA , Blefarostatos	148
- Cuchillee	4
- Protector	35
- Ganchos	37
ARKANSAS , Accesorios	168
ATKINSON , Cánulas para ojos	152
AXENFELD , Blefarostatos	149
- Cuchillee	12
- Cucharillas para chalazión	32
- Separador	35
AYERS , Pinzas quirúrgicas	112

B

BABY-ALLIS , Pinzas hemostáticas	134
BABY-METZENBAUM , Tijeras	79
BACKHAUS , Pinzas de campo	134
BANGERTER , Micro Espátulas	50
BARKAN , Cuchillee	13
BARRAQUER , Blefarostatos	146
- Cuchillo para queratoplástica	17
- Micro Espátulas	48, 49
- Pinzas para corneal	89
- Pinzas depilatoria	113
- Micro Portaaguas	127, 128, 129, 131, 161, 162
BEAUPRE , Pinzas depilatoria	113
BECHERT , Ganchos para lente intraoculares	42
BECHERT-McPHERSON , Pinzas quirúrgicas	107
BECKER , Cuchillee	15
BEER , Pinzas depilatoria	113
BERKELEY , Marcadores	143
BERENS , Cuchillee	8
- Cauterios	55
BINKHORST , Cánulas para ojos	158
BISHOP-HARMON , Pinzas quirúrgicas	82
- Pinzas de disección finas	83
- Cánulas para ojos	158, 161
BLASCOVICS , Cuchillo para cirugía plástica	18
BONACCOLTO , Pinzas para fijación	93
BONN , Cuchillee	12
- Pinzas para sutura	95, 101, 102, 103, 104
- Ganchos para lente intraoculares	43
- Micro Pinzas	92
BORES , Pinzas para fijación corneal	94
- Marcadores	140, 143, 144
BOTVIN , Micro Pinzas	91
BOWMANN , Cuchillee	13
- Estiletos para canal lacrimal	45
- Blefarostatos	147
BRACKEN , Pinzas para fijación	80
- Cánulas para ojos	157
BRACKEN-FARKAS , Pinzas para fijación	80
BRAND , Separador para iris	33
BUNGE , Cucharillas	23
BURCH , Cuchillee	13

C

CALF , Pinzas para implantación	111
CALIPER , Meßinstrumente	135
CASTROVIEJO , Separador	146

- Cuchillee	8
- Dilatadores lacrimales	44
- Tijeras corneal	66
- Micro Espátulas	47, 48, 49, 50, 53, 162
- Micro Portaaguas	125, 126, 128, 129, 130
- Espátula para queratoplástica	57
- Instrumentos para medidas	135, 161
- Pinzas para sutura	99, 101, 104
CHAYET , Marcadores	141
CITELLI , Pinzas cortante para huesos	28
CLAYMANN-JAFFE , Ganchos para lente intraoculares	43
COLIBRI , Micro Pinzas	90
- Pinzas para corneal	88, 161
CONWAY , Retractores de párpados	59
COOK , Blefarostatos	148
CULLER , Micro Espátulas	55
- Ganchos	36, 164

D

DAVIEL , Cucharillas	30
DAVIS , Pinzas para esterilización	173
DE LA ROZA , Aguas para ligaduras	38
DESMARRES , Cuchillee	11
- Retractores de párpados	59, 163
- Pinzas para chalazión	112
DEUTSCHMANN , Cuchillee	4
DIEFFENBACH , Clamps Bulldog	132
DIX , Instrumentos para cuerpos extraños	19, 20
DODICK , Pinzas quirúrgicas	109
DREWS , Cánulas para ojos	156, 159

E

ELLIS , Cuchillee	14
- Marcadores	145
ELSCHNIG , Cuchillo para cirugía plástica	18
- Cucharillas	30
- Micro Espátula	49
- Pinzas para fijación	80
- Asas de lentes	51
ERNEST-CALF , Pinzas para nucleo	105

F

FAULKNER , Pinzas para implantación	110
FINE-THORNTON , Anillos para bulbo	139
FINK , Instrumentos de párpados	58
FISCHER , Espátula	54
FIXIERKRALLE , Garra fijadora	35
FRANCIS , Cuchillee	14
FRIEDMANN , Pinzas cortante para huesos	27

G

GASKIN , Pinzas para sutura	96
- Pinzas quirúrgicas	106, 109
GESS , Cánulas para ojos	152
GILLS , Cánulas para ojos	155, 158
GIMBEL , Cánulas para ojos	157
- Anillos para bulbo	139
GILL , Cuchillee	12
- Micro Pinzas	91
GOLDSTEIN , Blefarostatos	149
GONNIN-AMSLER , Marcador graduado	57
GRAEATHER , Cánulas para ojos	156
- Ganchos para lente intraoculares	42
GRADLE , Pinzas depilatoria	113
GRAEFE , Blefarostatos	147
- Cuchillee	4, 8, 10, 15
- Cucharillas	30
- Ganchos	33, 35
- Tijeras	78
- Pinzas de fijación	81

- Pinzas de disección finas	83, 161
- Micro Pinzas	91
- Ganchos para estrabismo	36, 163
GRANDON , Cánulas para ojos	155
GREEN , Pinzas para fijación	81
- Espátulas	54
- Ganchos	34
GROSS , Retractores para iris	32
GUTHRIE , Ganchos	29, 34
GUYTON-LUNDSGAARD , Cuchillee	12

H

HAAB , Cuchillee	10
HABERLE-McPHERSON , Pinzas quirúrgicas	107
HALSTED , Pinzas hemostáticas	133
HALSTED-MOSQUITO , Pinzas hemostáticas	133
HAMBURG , Cuchillee	8
HARMS , Pinzas para sutura	102
- Estiletes trabeculares	44
HARTMANN , Espéculos nasales	27
HARTMANN-BABY-MOSQUITO , Pinzas hemostáticas	133, 161
HEATH , Cucharillas	23
HEBRA , Cucharillas para chalazión	22
HEILDELBERG , Portaalgodón	39
HESLIN , Cánulas para ojos	153
HESS , Cucharillas	30
- Ganchos	37
HESSBERG , Agujas para ligaduras	38
HIRSCHMANN , Ganchos para lente intraoculares	42, 161
HOFFER , Marcadores	140, 143
- Pinzas para sutura	104
HOFFER-McPHERSON , Pinzas para sutura	97
HOFMANN , Cánulas para ojos	159
- Marcadores	142
HOFMANN-THORNTON , Anillos para bulbo	139
HUNT , Pinzas quirúrgicas	112

I

IRIS , Tijeras quirúrgicas	76
-----------------------------------	----

J

JACOBI , Agujas para ligaduras	38
JACOBSON , Tijeras	73
JAEGER , Cherartotomi	6
- Placca per palpebre	58
- Uncini	33
JAEGER-GRIESHABER , Querátomos	7
JAFFE , Ganchos para lente intraoculares	43, 161, 162
- Ganchos para lente intraoculares	42, 162
- Pinzas quirúrgicas	108
- Pinzas para sutura	99, 100
JAFFE-KNOLLE , Ganchos para lente intraoculares	42
JAMESON , Pinzas quirúrgicas	112, 163
- Ganchos	36, 163
JENSEN , Cánulas para ojos	157
JENSEN-THOMAS , Cánulas para ojos	155

K

KANSAS , Pinzas para nucleo	105
KAYE , Tijeras con anillos especialmente grande	75
KELLNAR , Retractores	44
KELMANN , Cánulas para ojos	151, 156
- Pinzas para sutura	104
KELMANN-McPHERSON , Pinzas para sutura	96, 97, 98
- Pinzas quirúrgicas	107
KERRISON , Pinzas cortante para huesos	28
KERSHNER , Blefarostatos	150
KIMURA , Micro Espátulas	48
KIRBY , Retractores	16
- Ganchos	52

KLAR EVATEUR , Retractores de párpados	58
KNAPP , Cuchillee	9
- Ganchos	34
- Micro Espátulas	53
KNAPP-CLARK , Blefarostatos	147
KNOLLE , Cánulas para ojos	157
KNOLLE-KELMAN , Cánulas para ojos	156
KNOLLE-PIERCE , Cánulas para ojos	159
KRAFF , Cánulas para ojos	156
- Pinzas quirúrgicas	106
- Pinzas para nucleo	105
KRATZ , Cánulas para ojos	156, 160
KREMER , Pinzas para fijación cómeal	94
KUGLEN , Cánulas para ojos	160
- Ganchos para lente intraoculares	43
KUHNT , Cuchillee	10, 11
- Pinzas para fijación	80

L

LA FORCE , Cuchillee	3
LA GRANGE , Tijeras	77
LAMBERT , Pinzas quirúrgicas	112
LANCASTER , Blefarostatos	147
LANDOLT , Tijeras	78
LEHNER , Pinzas quirúrgicas	108, 161
LESTER , Ganchos para lente intraoculares	42
- Pinzas para fijación	93
LEVINSON , Cuchillee	14
LEWIS , Asas de lentes	51
LIEBERMANN-TENNANT , Blefarostatos	150, 161
LIEPPMAN , Cánulas para ojos	156
LINDNER , Micro Espátulas	53
LINDSTROM , Marcadores	142, 145
LISTER-BURCH , Blefarostatos	147
LITTAUER , Pinzas depilatoria	113
LIVERNOIS , Pinzas para implantación	110, 111
LOCKLIN , Tijeras	78
LÖFFEL , Instrumentos dobles	31
LU , Marcadores	141
LUENEBURG , Elevadores	40

M

MACKENSEN , Estiletes trabeculares	44
MALBRAN , Ganchos	36
McDONALD , Marcadores	143
McGANNEN , Retractores para iris	35
McGREGOR , Pinzas para fijación	93
McINTYRE , Cánulas para ojos	151, 152, 153, 156, 157
McINTYRE-BINKHORST , Cánulas para ojos	159
McPHERSON , Pinzas para sutura	63
- Pinzas para sutura	97, 98, 162
McREYNOLDS , Espátula	54
MEAD , Martillo quirúrgico	29
MELLINGER , Blefarostatos	146
MELLINGER-AXENFELD , Blefarostatos	146
MELLINGER-BEARD , Blefarostatos	149
MENDEZ , Marcadores	140, 141, 144
MEYER-SCHWICKERATH , Localizador	35
MEYHOEFER , Cucharillas para chalazión	21
- Cucharillas dobles	31
MICRO , Pinzas para sutura	95, 103
MICRO-HALSTED , Pinzas hemostáticas	133
MICRO-IRIS , Tijeras	76
MINI-FRIEDMANN , Pinzas gubias	27
MOD. BONN , Ganchos para iris	33
MOD. ESSEN , Espátula	56
MOD. FRANKFURT , Espátulas	55
MOD. GIESSEN , Espátulas	56
MOD. TÜBINGEN , Ganchos para iris	33
MOORFIELD , Instrumentos dobles	31
MORRISON , Cánulas para ojos	155, 158
MULDOON , Dilatador lacrimal	44
MÜLLER , Blefarostatos	149
MURDOK , Blefarostatos	148

N

NANO, Marcadores	141
NEW ORLEANS, Asas de lentes	51
NEVYAS, Pinzas quirúrgicas	108
NICATI, Cuchillee	14
NISHI, Cánulas para ojos	153
NORDAN-RUIZ, Marcadores	142
NOYES, Tijeras	69

O

O'BRIEN, Tijeras para ligaduras	78
O'CONNOR, Ganchos	34
OSHER, Pinzas quirúrgicas	106
OSHIKA-FAULKNER, Pinzas para implantación	110

P

PAPST, Cuchillee	8
PARK, Blefarostatos	148
PARK-GUYTON, Blefarostatos	148
PARK-MAUMENEE, Blefarostatos	148
PATON, Cuchillee	11
- Espátulas para queratoplástica	57
PAUL, Separadores	35
PAUFIQUE, Cuchillo para queratoplástica	17
- Pinzas para sutura	95, 103
PERRY, Pinzas quirúrgicas	82
PHACO, Cuchillee	8
PIANGE, Cuchillee	14
PIERSE, Micro Pinzas	90
POLACK, Micro Pinzas	90
POTTS-YASARGIL, Tijeras	73
PRINCE, Cauterios	55
PROST, Blefarostatos	149

R

RAININ, Cánulas para ojos	151
RANDOLPH, Cánulas para ojos	151
REILL, Micro Portaagujas	129
RIZZUTI, Ganchos	52
ROGGE, Pinzas para esterilización	173
ROLLET, Cuchillee	15
- Ganchos	34
RUBMAN-KATZIN, Cánulas para ojos	156

S

SALTZ, Cánulas para ojos	157, 160
SATO, Cuchillee	10
SAUTTER, Espátulas	56
SAUER, Blefarostatos	149
SCHAEDEL, Pinzas de campo	134
SCHEIE, Cuchillee	13
SCHEPENS, Retractores de párpados	58
SCHWEIZER, Cuchillee	14
SCOBEE, Ganchos	36
SEIFFERT, Estiletes	39
SHAAF, Pinzas	115
SHAHINIAN, Cánulas para ojos	151
SHAMMAS, Cánulas para ojos	156
SHAPIRO, Cánulas para ojos	157
SHEETS, Cánulas para ojos	151, 159
SHEETS-McPHERSON, Pinzas quirúrgicas	109
SHEPARD, Instrumentos para implantación	43
SICHEL, Cuchillee	10
SKEELE, Cucharillas para chalación	22
SIMCOE, Cánulas para ojos	154, 157, 159
SINSKEY, Instrumentos para implantación	42, 161
SMITH-FISCHER, Espátula	54
SMITH-GREEN, Cuchillee	4

SNELLEN, Asas de lentes	51
- Pinzas para entropión	113
SNIDER-CASTROVIEJO, Pinzas para sutura	99
SPENCER, Tijeras para ligaduras	78
STARNADEL, Cuchillee	13
STEINERT, Pinzas para implantación	110
STEVENS, Ganchos	36, 163
STEVENS, Tijeras	77
STEVENS, Tijeras con anillos especialmente grandes	75
STEVENSON, Blefarostatos	149
STILLE, Tijeras	79
STITCH, Tijeras con anillos especialmente grandes	75
ST.MARTIN, Pinzas para sutura	95, 103, 162
SWISS, Cánulas para ojos	154

T

TENNANT, Pinzas para sutura	96, 99, 100
TENNANT-TROUMAN, Pinzas para fijación	81
THORNTON, Marcadores	140, 141, 142, 143, 145
THORPE, Pinzas para fijación	93
THURMAND, Cánulas para ojos	153
- Marcadores	144
TOOK, Cuchillee	11
TROUTMAN, Cánulas para ojos	151
- Tijeras córnea	66
- Pinzas córnea	89
- Pinzas para fijación	81
- Pinzas para sutura	101, 102, 104
TROUTMANN-BARRAQUER, Micro Espátula	49, 161, 162
TULEVECH, Cánulas para ojos	151

U

UTRATA, Pinzas quirúrgicas	108, 162
----------------------------	----------

V

VANNAS, Tijeras para catarata	63, 161, 162
VILLASENOR-NAVARRO, Marcadores	140
Vitrectomie Instrumental	41
VOLKER, Pinzas quirúrgicas	114
VOLKER-ADSON, Pinzas quirúrgicas	115
VOLKER-CASTROVIEJO, Pinzas quirúrgicas	115
VOLKER-HARMS, Pinzas quirúrgicas	115
VOLKER-MOORFIELD, Pinzas quirúrgicas	114
VOLKER-PATON, Pinzas quirúrgicas	114
VOLKER-THORPE, Pinzas quirúrgicas	114

W

WADSWORTH-TODD, Cauterios	55
WALTON, Cuchillee	15
- Tijeras con anillos especialmente grandes	75
WEBER, Cuchillee	9
- Asas de lentes	51
WECKER, Cuchillee	10
- Tijeras para iridectomía	64
- Micro Espátulas	46, 163
- Espátulas	55
WELLS, Espátula para enucleación	30
WEISS, Blefarostatos	147
WELSH, Cánulas para ojos	151
WEST, Cánulas para ojos	151
- Cíncel	40
WESTCOTT, Tijeras	69
WHEELER, Cuchillee	4
- Micro Espátulas	53
WIENER, Ganchos	34
WILBRANDT-BINKHORST, Cánulas para ojos	159
WILDER, Dilatares lacrimales	44
WILLIAMS, Blefarostatos	147
WILLS-HOSPITAL, Cauterios	55
WILMER, Tijeras	78

WITSCHERL, Pinzas quirúrgicas	106
WOODRUFF, Agujas para ligaduras	38
WORST, Ganchos para estrabismo	37, 164

Y

YASARGIL, Tijeras	73
YOSHITOMI-NEUHANN, Pinzas quirúrgicas	107
YOUENS, Cánulas para ojos	153

Z

ZIEGLER, Cuchillee	9, 10
--------------------	-------

A

AGRICOLA , Blépharostats	149
ALLIS , Pincés hémostatiques	134
ALVIS , Couteaux	14
AMBROSIO , Canulés oculaires	154
AMENABAR , Instruments à paupières	58
ANDERSON-CRITCHETT , Couteaux	12
ANEL , Canulés oculaires	150
ANIS , Canulés oculaires	158, 159
- Marquers	145
ARLT , Anses	51
ARROWSMITH , Marquer	144
- Pincés à fixation cornéenne	94
ARRUGA , Blépharostats	148
- Couteaux	4
- Protecteur	35
- Crochets	37
ARKANSAS , Accessoires	168
ATKINSON , Canulés oculaires	152
AXENFELD , Blépharostats	149
- Couteaux	12
- Curettes tranchantes à chalazion	32
- Ecarteur	35
AYERS , Pincés chirurgicales	112

B

BABY-ALLIS , Pincés hémostatiques	134
BABY-METZENBAUM , Ciseaux	79
BACKHAUS , Pincés à champs	134
BANGERTER , Micro Spatules	50
BARKAN , Couteaux	13
BARRAQUER , Blépharostats	146
- Couteau pour kératoplastique	17
- Micro Spatules	48, 49
- Pincés à cornée	89
- Pincés à cils	113
- Micro Porte aiguilles	127, 128, 129, 131, 161, 162
BEAUPRE , Pincés à cils	113
BECHERT , Crochet à iris et à lentille	42
BECHERT-McPHERSON , Pincés chirurgicales	107
BECKER , Couteaux	15
BEER , Pincés à cils	113
BERKELEY , Marquer	143
BERENS , Couteaux	8
- Cautéres	55
BINKHORST , Canulés oculaires	158
BISHOP-HARMON , Pincés chirurgicales	82
- Pincés à dissection à mors très fins	83
- Canulés oculaires	158, 161
BLASCOVICS , Couteau pour plastique	18
BONACCOLTO , Pincés à fixer	93
BONN , Couteau	12
- Pincés à sutures	95, 101, 102, 103, 104
- Crochets à iris et à lentille	43
- Micro Pincés	92
BORES , Pincés à fixation cornéenne	94
- Marquer	140, 143, 144
BOTVIN , Micro Pincés	91
BOWMANN , Couteaux	13
- Stylets pour le canal lacrymal	45
- Blépharostats	147
BRACKEN , Pincés pour fixation	80
- Canulés oculaires	157
BRACKEN-FARKAS , Pincés pour fixation	80
BRAND , Rétracteur à iris	33
BUNGE , Curettes	23
BURCH , Couteau	13

C

CALF , Pincés pour implantation	111
CALIPER , Meßinstrumente	135
CASTROVIEJO , Ecarteur	146

- Couteaux	8
- Dilatateurs lacrymal	44
- Ciseaux pour la cornée	66
- Micro Spatules	47, 48, 49, 50, 53, 162
- Micro Porte aiguilles	125, 126, 128, 129, 130
- Spatule pour kératoplastique	57
- Instruments pour mesurer	135, 161
- Pincés à sutures	99, 101, 104
CHAYET , Marquer	141
CITELLI , Pincés à os	28
CLAYMANN-JAFFE , Crochets à iris et à lentille	43
COLIBRI , Micro Pincés	90
- Pincés à cornée	88, 161
CONWAY , Rétracteur de paupières	59
COOK , Blépharostats	148
CULLER , Micro Spatules	55
- Crochets	36, 164

D

DAVIEL , Curettes	30
DAVIS , Pince à stérilisation	173
DE LA ROZA , Aiguilles à ligatures	38
DESMARRES , Couteaux	11
- Rétracteur à paupières	59, 163
- Pincés à chalazion	112
DEUTSCHMANN , Couteau	4
DIEFFENBACH , Clamps Bulldog	132
DIX , Instruments à corps étrangers	19, 20
DODICK , Pincés chirurgicales	109
DREWS , Canulés oculaires	156, 159

E

ELLIS , Couteau	14
- Marquer	145
ELSCHNIG , Couteau pour plastique	18
- Curettes	30
- Micro Spatules	49
- Pincés à fixer	80
- Anses	51
ERNEST-CALF , Pincés à noyau	105

F

FAULKNER , Pince pour l'implantation	110
FINE-THORNTON , Anneaux pour le bulbe	139
FINK , Instruments à paupières	58
FISCHER , Spatules	54
FIXIERKRALLE , Griffe à fixation	35
FRANCIS , Couteau	14
FRIEDMANN , Pincés à os	27

G

GASKIN , Pincés à sutures	96
- Pincés chirurgicales	106, 109
GESS , Canulés oculaires	152
GILLS , Canulés oculaires	155, 158
GIMBEL , Canulés oculaires	157
- Anneaux pour le bulbe	139
GILL , Couteau	12
- Micro Pincés	91
GOLDSTEIN , Blépharostats	149
GONNIN-AMSLER , Marquer graduée	57
GRAEATHER , Canulés oculaires	156
- Instruments pour l'implantation	42
GRADLE , Pincés à cils	113
GRAEFE , Blépharostats	147
- Couteaux	4, 8, 10, 15
- Curettes	30
- Crochets	33, 35
- Ciseaux	78
- Pincés à fixation	81

- Pincés à dissection à mors tré fins	83, 161
- Micro Pincés	91
- Crochets à strabisme	36, 163
GRANDON , Canulés oculaires	155
GREEN , Pincés à fixation	81
- Spatules	54
- Crochets	34
GROSS , Rétracteur à iris	32
GUTHRIE , Crochets	29, 34
GUYTON-LUNDSGAARD , Couteaux	12

H

HAAB , Couteau	10
HABERLE-McPHERSON , Pincés chirurgicales	107
HALSTED , Pincés hémostatiques	133
HALSTED-MOSQUITO , Pincés hémostatiques	133
HAMBURG , Couteaux	8
HARMS , Pincés à suture	102
- Sondes trabeculaires	44
HARTMANN , Spéculum nasaux	27
HARTMANN-BABY-MOSQUITO , Pincés hémostatiques	133, 161
HEATH , Curettes	23
HEBRA , Curettes à chalazion	22
HEILDELBERG , Porte cotons	39
HESLIN , Canulés oculaires	153
HESS , Curette	30
- Crochets	37
HESSBERG , Aiguilles à ligatures	38
HIRSCHMANN , Instruments pour l'implantation	42, 161
HOFFER , Marquer	140, 143
- Pincés à sutures	104
HOFFER-McPHERSON , Pincés à sutures	97
HOFMANN , Canulés oculaires	159
- Marquer	142
HOFMANN-THORNTON , Anneaux pour le bulbe	139
HUNT , Pincés chirurgicales	112

I

IRIS , Ciseaux chirurgicales	76
-------------------------------------	----

J

JACOBI , Aiguilles à ligatures	38
JACOBSON , Ciseaux	73
JAEGER , Kératomes	6
- Plaque à paupières	58
- Crochets	33
JAEGER-GRIESHABER , Kératomes	7
JAFFE , Instruments pour l'implantation	43, 161, 162
- Instruments pour l'implantation	42, 162
- Pincés chirurgicales	108
- Pincés à sutures	99, 100
JAFFE-KNOLLE , Instruments pour l'implantation	42
JAMESON , Pincés chirurgicales	112, 163
- Crochets	36, 163
JENSEN , Canulés oculaires	157
JENSEN-THOMAS , Canulés oculaires	155

K

KANSAS , Pincés à noyau	105
KAYE , Ciseaux avec large anneaux	75
KELLNAR , Rétracteur	44
KELMANN , Canulés oculaires	151, 156
- Pincés à sutures	104
KELMANN-McPHERSON , Pincés à sutures	96, 97, 98
- Pincés chirurgicales	107
KERRISON , Pincés à os	28
KERSHNER , Blépharostats	150
KIMURA , Micro Spatules	48
KIRBY , Rétracteur	16
- Crochets	52

KLAR EVATEUR , Releveur de paupières	58
KNAPP , Couteaux	9
- Crochets	34
- Micro Spatules	53
KNAPP-CLARK , Blépharostats	147
KNOLLE , Canulés oculaires	157
KNOLLE-KELMAN , Canulés oculaires	156
KNOLLE-PIERCE , Canulés oculaires	159
KRAFF , Canulés oculaires	156
- Pincés chirurgicales	106
- Pincés à noyau	105
KRATZ , Canulés oculaires	156, 160
KREMER , Pincés à fixation cornéenne	94
KUGLEN , Canulés oculaires	160
- Instruments pour l'implantation	43
KUHNT , Couteaux	10, 11
- Pincés à fixation	80

L

LA FORCE , Couteaux	3
LA GRANGE , Ciseaux	77
LAMBERT , Pincés chirurgicales	112
LANCASTER , Blépharostats	147
LANDOLT , Ciseaux	78
LEHNER , Pincés chirurgicales	108, 161
LESTER , Instruments pour l'implantation	42
- Pincés à fixation	93
LEVINSON , Couteaux	14
LEWIS , Anses	51
LIEBERMANN-TENNANT , Blépharostats	150, 161
LIEPPMAN , Canulés oculaires	156
LINDNER , Micro Spatules	53
LINDSTROM , Marquer	142, 145
LISTER-BURCH , Blépharostats	147
LITTAUER , Pincés à cils	113
LIVERNOIS , Pincés pour l'implantation	110, 111
LOCKLIN , Ciseaux	78
LÖFFEL , Instruments doubles	31
LU , Marquer	141
LUENEBURG , Elévateurs	40

M

MACKENSEN , Sondes trabeculaires	44
MALBRAN , Crochets	36
McDONALD , Marquer	143
McGANNEN , Rétracteur	35
McGREGOR , Pincés à fixation	93
McINTYRE , Canulés oculaires	151, 152, 153, 156, 157
McINTYRE-BINKHORST , Canulés oculaires	159
McPHERSON , Pincés à sutures	63
- Pincés à sutures	97, 98, 162
McREYNOLDS , Spatules	54
MEAD , Maillet chirurgicaux	29
MELLINGER , Blépharostats	146
MELLINGER-AXENFELD , Blépharostats	146
MELLINGER-BEARD , Blépharostats	149
MENDEZ , Marquer	140, 141, 144
MEYER-SCHWICKERATH , Localisateur	35
MEYHOEFER , Curettes à chalazion	21
- Curette double	31
MICRO , Pincés à sutures	95, 103
MICRO-HALSTED , Pincés hémostatiques	133
MICRO-IRIS , Ciseaux	76
MINI-FRIEDMANN , Pincés à os	27
MOD. BONN , Crochets à iris	33
MOD. ESSEN , Spatules	56
MOD. FRANKFURT , Spatules	55
MOD. GIESSEN , Spatules	56
MOD. TÜBINGEN , Crochets à iris	33
MOORFIELD , Instruments doubles	31
MORRISON , Canulés oculaires	155, 158
MULDOON , Dilatateurs lacrymal	44
MÜLLER , Blépharostats	149
MURDOK , Blépharostats	148

N

NANO, Marquer	141
NEW ORLEANS, Anses	51
NEVYAS, Pincés chirurgicales	108
NICATI, Couteau	14
NISHI, Canulés oculaires	153
NORDAN-RUIZ, Marquer	142
NOYES, Ciseaux	69

O

O'BRIEN, Ciseaux pour ligatures	78
O'CONNOR, Crochets	34
OSHER, Pincés chirurgicales	106
OSHIKA-FAULKNER, Pincés pour l'implantation	110

P

PAPST, Couteau	8
PARK, Blépharostats	148
PARK-GUYTON, Blépharostats	148
PARK-MAUMENEE, Blépharostats	148
PATON, Couteau	11
- Spatule pour kératoplastique	57
PAUL, Ecarteur	35
PAUFIQUE, Couteau pour kératoplastique	17
- Pincés à sutures	95, 103
PERRY, Pincés chirurgicales	82
PHACO, Couteaux	8
PIANGE, Couteaux	14
PIERSE, Micro Pincés	90
POLACK, Micro Pincés	90
POTTS-YASARGIL, Ciseaux	73
PRINCE, Cautéres	55
PROST, Blépharostats	149

R

RAININ, Canulés oculaires	151
RANDOLPH, Canulés oculaires	151
REILL, Micro Porte aiguilles	129
RIZZUTI, Crochets	52
ROGGE, Pincés à stérilisation	173
ROLLET, Couteau	15
- Crochets	34
RUBMAN-KATZIN, Canulés oculaires	156

S

SALTZ, Canulés oculaires	157, 160
SATO, Couteau	10
SAUTTER, Spatules	56
SAUER, Blépharostats	149
SCHAEDEL, Pincés à champs	134
SCHEIE, Couteau	13
SCHEPENS, Releveur de paupières	58
SCHWEIZER, Couteaux	14
SCOBEE, Crochets	36
SEIFFERT, Sondes	39
SHAAF, Pincés	115
SHAHINIAN, Canulés oculaires	151
SHAMMAS, Canulés oculaires	156
SHAPIRO, Canulés oculaires	157
SHEETS, Canulés oculaires	151, 159
SHEETS-McPHERSON, Pincés chirurgicales	109
SHEPARD, Instruments pour l'implantation	43
SICHEL, Couteaux	10
SKEELE, Curettes à chalazion	22
SIMCOE, Canulés oculaires	154, 157, 159
SINSKEY, Instruments pour l'implantation	42, 161
SMITH-FISCHER, Spatules	54
SMITH-GREEN, Couteau	4

SNELLEN, Anses	51
- Pincés à entropion	113
SNIDER-CASTROVIEJO, Pincés à sutures	99
SPENCER, Ciseaux pour ligatures	78
STARNADEL, Couteau	13
STEINERT, Pincés pour l'implantation	110
STEVENS, Crochets	36, 163
STEVENS, Ciseaux	77
STEVENS, Ciseaux avec larges anneaux	75
STEVENSON, Blépharostats	149
STILLE, Ciseaux	79
STITCH, Ciseaux avec larges anneaux	75
ST.MARTIN, Pincés à sutures	95, 103, 162
SWISS, Canulés oculaires	154

T

TENNANT, Pincés à sutures	96, 99, 100
TENNANT-TROUMAN, Pincés à fixation	81
THORNTON, Marquer	140, 141, 142, 143, 145
THORPE, Pincés à fixation	93
THURMAND, Canulés oculaires	153
- Marquer	144
TOOK, Couteaux	11
TROUTMAN, Canulés oculaires	151
- Ciseaux pour la cornée	66
- Pincés pour la cornée	89
- Pincés à fixation	81
- Pincés à sutures	101, 102, 104
TROUTMANN-BARRAQUER, Micro Spatules	49, 161, 162
TULEVECH, Canulés oculaires	151

U

UTRATA, Pincés chirurgicales	108, 162
------------------------------	----------

V

VANNAS, Ciseaux pour la cataracte	63, 161, 162
VILLASENOR-NAVARRO, Marquer	140
Vitrectomie Instruments	41
VOLKER, Pincés chirurgicales	114
VOLKER-ADSON, Pincés chirurgicales	115
VOLKER-CASTROVIEJO, Pincés chirurgicales	115
VOLKER-HARMS, Pincés chirurgicales	115
VOLKER-MOORFIELD, Pincés chirurgicales	114
VOLKER-PATON, Pincés chirurgicales	114
VOLKER-THORPE, Pincés chirurgicales	114

W

WADSWORTH-TODD, Cautéres	55
WALTON, Couteau	15
- Ciseaux avec larges anneaux	75
WEBER, Couteau	9
- Anses	51
WECKER, Couteau	10
- Ciseaux à iridectomie	64
- Micro Spatules	46, 163
- Spatules	55
WELLS, Spatule échancrée pour l'enucléation	30
WEISS, Blépharostats	147
WELSH, Canulés oculaires	151
WEST, Canulés oculaires	151
- Ciseaux-burins	40
WESTCOTT, Ciseaux	69
WHEELER, Couteau	4
- Micro Spatules	53
WIENER, Crochets	34
WILBRANDT-BINKHORST, Canulés oculaires	159
WILDER, Dilatateurs lacrymal	44
WILLIAMS, Blépharostats	147
WILLS-HOSPITAL, Cautéres	55
WILMER, Ciseaux	78

WITSCHER, Pincas chirurgicales	106
WOODRUFF, Aiguilles pour ligatures	38
WORST, Crochets à strabisme	37, 164

Y

YASARGIL, Ciseaux	73
YOSHITOMI-NEUHANN, Pincas chirurgicales	107
YOUENS, Canulés oculaires	153

Z

ZIEGLER, Couteaux	9, 10
-------------------	-------

Alphanumerical Index

Alphanumerischen Index

Index alphanumérique

Índice alfanumérico

Indice alfanumerico



Alphanumerical Index

Alphanumerischen Index

Index alphanumérique

Indice alfanumérico

Indice alfanumerico

BB-46	24	BM-89	132	DB-179	28	FD-158	129	FG-102	76	LS-04	135, 163
BD-04	83	BM-90	132	DB-180	28	FD-159	129	FG-103	76	LS-07	135
BD-06	82	BM-93	132	DB-181	28	FD-162	128	FG-105	76	LS-08	135
BD-07	83, 161	BM-95	132	DB-182	28	FD-164	130	FG-114	78	LS-09	135
BD-09T	83	BM-96	132	DB-183	28	FD-165	131	FG-115	78	MA-B3	24
BD-130	112	BM-97	132	DB-1L	167	FD-166	131	FG-122	78	MA-B7K	24
BD-131	112	BM-98	132	DB-22A	168	FD-167	126	FG-13	76	MF-01	120
BD-132	112	BM-99	132	DB-23	46	FD-168	126	FG-15	76	MF-02	120
BD-135	81	BR-20	171	DB-299	168	FD-186	73	FG-151	78	MF-03	120
BD-136	81	BR-25	171	DB-4	168	FD-187	73	FG-2	76	MF-04	120
BD-189	81	BR-28	171	DB-5M	167	FD-191	73	FG-200	74	MF-05	120
BD-200	122	BS-1	169	DB-6-A	168	FD-214	127	FG-201	74	MF-06	120
BD-201	122	BS-20	160	DB-96	168	FD-215	127, 164	FG-202	74	MF-07	120
BD-204	122	BS-23	170	DB-OL	167	FD-216	127	FG-203	74	MF-08	120
BD-205	122	BS-27	170	DS-08	58	FD-217	127	FG-204	74	MF-09	120
BD-206	122	BS-28	170	ES-45	113	FD-231	64	FG-205	74	MF-10	120
BD-207	82	BS-30	170	ES-46	113	FD-232	64	FG-206	74	MF-100	100, 163
BD-208	82	BS-40	170	ES-48	113	FD-233	64	FG-207	74	MF-11	120
BD-209	82	BS-41	161, 170	ES-64	113	FD-234	64	FG-208	74	MF-12	120
BD-254	93	BS-42	163, 170	ES-65	113	FD-236	127	FG-209	75	MF-13	118
BD-255	80	BS-59	171	FD-01	70	FD-237	127	FG-21	77	MF-14	118
BD-256	80	BS-60	171	FD-02	70	FD-240	125	FG-210	75	MF-15	118
BD-257	80	BS-61	171	FD-03	65	FD-241	125	FG-211	75	MF-150	84
BD-258	80	BT-09	58	FD-04	65	FD-244	164	FG-212	75	MF-151	84
BD-259	80	BT-10	15	FD-05	65	FD-40	68	FG-215	75	MF-152	84
BD-260	112	BT-12	15	FD-06	72	FD-41	65, 162	FG-216	75	MF-153	84
BD-261	112	BT-13	15	FD-07	70	FD-42	65, 162	FG-217	75	MF-154	84
BD-263	112	BT-14	15	FD-08	72	FD-43	70	FG-218	75	MF-155	84
BD-296	113	BT-203	29	FD-09	70	FD-44	70	FG-219	75	MF-156	84
BD-297	113	BT-204	29	FD-10	69	FD-45	72	FG-22	77	MF-157	84
BD-298	113	BT-230	34	FD-100	110, 161	FD-46	72	FG-23	77	MF-158	85
BD-299	113	BT-231	34	FD-105	128	FD-47	71	FG-24	77	MF-158	161
BD-30T	83	BT-232	33	FD-106	128	FD-48	71	FG-30	78	MF-159	85
BD-31T	83	BT-233	33	FD-107	128	FD-49	65	FG-4	76	MF-16	118
BD-32	83	BT-234	34	FD-108	128	FD-50	65, 161	FG-5	76	MF-160	85
BD-33	83	BT-235	34	FD-109	128	FD-51	70	FG-50	77	MF-161	85
BD-333	81	BT-236	34	FD-11	68	FD-52	70	FG-51	77	MF-162	86
BD-334	81	BT-237	34	FD-110	128	FD-53	71	FG-52	77	MF-163	86
BD-35	82	BT-238	35	FD-111	128	FD-54	71	FG-53	77	MF-164	86
BD-36	82	BT-239	35	FD-112	128	FD-55	65	FL-12	29	MF-165	86
BD-40	83	BT-240	35	FD-113	130	FD-56	65	FL-12R	29	MF-166	87
BD-41	83	BT-241	35	FD-114	130	FD-57	70	FL-133	40	MF-167	87
BD-42	82, 161	BT-242	35	FD-115	130	FD-58	70	FL-134	40	MF-168	87
BD-42T	83	BT-243	16	FD-116	130	FD-59	71	FL-165	32	MF-169	87
BD-43	82	BT-244	16	FD-117	113	FD-60	71	FL-166	32	MF-17	118
BD-43T	83	BT-70	59	FD-118	81	FD-61	68	FL-167	32	MF-170	88
BD-60	122	BT-71	59	FD-119	63	FD-62	68	FM-111	79	MF-171	88
BD-62	122	BT-72	59	FD-12	69	FD-64	69	FM-118	79	MF-172	88
BD-64	122	BT-73	59	FD-120	63	FD-65	69, 164	FM-119	79, 161	MF-172	161
BD-96	83	BT-74	59	FD-121	131	FD-66	66	FM-29	79	MF-173	88
BF-38	134	BT-75	59	FD-122	131	FD-67	66	FM-44	79	MF-174	88
BF-42	134	BT-77	59	FD-123	63	FD-68	66	FM-47	79	MF-175	83
BF-46	134	BT-79	59	FD-124	67	FD-69	66	FM-48	79, 164	MF-176	82
BM-100	132	BV-01	146	FD-125	67	FD-70	66	FO-15	27	MF-177	82
BM-101	132	BV-02	146	FD-126	67	FD-71	66	FO-162	28	MF-178	91
BM-140	132	BV-03	146	FD-127	67	FD-72	66	FO-163	28	MF-179	91
BM-141	132	BV-04	147	FD-13	69	FD-73	66	FO-165	28	MF-180	91
BM-142	132	BV-05	146	FD-130	67	FD-74	66	FO-17	27	MF-181	91
BM-27	132	BV-06	147	FD-131	113	FD-79	63, 162	FR-10	40	MF-182	92
BM-32	132, 164	BV-08	149	FD-132	67	FD-80	63, 161	GS-02	173	MF-183	92
BM-33	132, 164	BV-53	146	FD-134	67	FD-81	63	GS-03	173	MF-184	92
BM-34	132	CS-01	169	FD-136	67	FD-82	125	GS-04	173	MF-185	92
BM-35	132	CS-02	169	FD-137	72	FD-83	125	GS-06	173	MF-186	92
BM-36	132	CS-03	169	FD-138	72	FD-84	125	GS-08	173	MF-187	93
BM-37	132	CS-04	169	FD-146	68	FD-85	125	GS-10	173	MF-188	93
BM-38	132	CS-51	169	FD-147	68	FD-86	125	GS-11	173	MF-189	93
BM-39	132	CS-52	169	FD-15	69	FD-87	125	LB-11	24	MF-19	118
BM-54	38	CS-55	169	FD-150	128	FD-88	125	LB-15	24	MF-190	93
BM-55	38	CS-80	169	FD-151	128, 161	FD-89	125	LB-364	24	MF-191	94
BM-56	38	CS-81	169	FD-152	129, 162	FD-96	126	LB-365	24	MF-192	94
BM-57	38	CS-82	169	FD-153	129	FD-97	126	LB-366	24	MF-193	94
BM-58	38	CS-83	169	FD-154	129	FD-98	126	LB-40	24	MF-194	94
BM-59	38	DB-10M	167	FD-155	129, 161, 164	FD-99	126	LG-1	77	MF-195	94
BM-87	132	DB-177	28	FD-156	129	FG-1	76	LK-1	78	MF-196	94
BM-88	132	DB-178	28	FD-157	129	FG-101	76	LK-3	78	MF-197	94



Alphanumerical Index

Alphanumerischen Index

Index alphanumérique

Indice alfanumérico

Indice alfanumerico

MF-198	95	MF-271	109	MF-49	118	NK-127	148	NK-195	10	NK-261	50
MF-199	95	MF-272	109	MF-50	118	NK-128	148	NK-196	10	NK-262	50
MF-20	118	MF-273	109	MF-52	118	NK-129	148	NK-197	10	NK-263	49
MF-200	95, 162	MF-274	109	MF-53	118	NK-13	47	NK-198	10	NK-264	49
MF-201	95	MF-275	110	MF-54	118	NK-130	148	NK-199	10	NK-265	49, 162
MF-202	103	MF-276	110	MF-55	118	NK-131	148	NK-2	24	NK-266	49, 161, 162
MF-203	103	MF-277	110	MF-56	118	NK-132	146	NK-20	4	NK-267	49
MF-204	103	MF-278	110	MF-58	120	NK-133	146	NK-200	10	NK-268	49
MF-205	103	MF-279	110	MF-59	120	NK-134	149	NK-201	10	NK-269	51
MF-206	103	MF-28	116	MF-60	120	NK-135	149	NK-202	11	NK-27	46, 55, 163
MF-207	102	MF-280	110, 161	MF-61	120	NK-136	149	NK-203	11	NK-270	51
MF-208	102	MF-280		MF-62	120	NK-137	149	NK-204	11	NK-271	51
MF-209	102	MF-281	111	MF-64	120	NK-138	149	NK-205	11	NK-272	51
MF-21	118	MF-282	111	MF-65	120	NK-139	149	NK-206	11	NK-273	51
MF-210	102	MF-283	111	MF-66	120	NK-14	8	NK-207	11	NK-274	51
MF-211	102	MF-284	111	MF-67	120	NK-140	149	NK-208	50	NK-275	37
MF-212	102	MF-285	114	MF-68	120	NK-141	149	NK-209	36, 164	NK-276	35
MF-213	101	MF-286	114	MF-73	117	NK-142	58	NK-21	47	NK-277	35
MF-214	101	MF-287	114	MF-74	117	NK-143	58	NK-210	11	NK-278	30
MF-215	101	MF-288	114	MF-75	117	NK-144	59	NK-211	12	NK-279	30
MF-216	101	MF-289	115	MF-76	117	NK-145	59	NK-212	12	NK-28	46, 55
MF-217	101	MF-29	116	MF-77	117	NK-145	163	NK-213	12	NK-280	30
MF-218	101	MF-29	164	MF-78	117	NK-146	58	NK-214	12	NK-281	30
MF-219	101	MF-290	115	MF-79	117, 161, 164	NK-147	4	NK-215	12	NK-282	30
MF-22	118	MF-291	115	MF-80	117	NK-148	4	NK-216	12	NK-283	30
MF-220	101	MF-292	115	MF-81	119	NK-149	4	NK-217	13	NK-284	30
MF-221	100, 162	MF-293	111	MF-82	119	NK-15	3	NK-218	13	NK-285	30
MF-222	100, 162	MF-294	115	MF-83	119	NK-150	4	NK-219	13	NK-286	21
MF-223	100	MF-295	111	MF-84	119	NK-151	4	NK-22	47	NK-287	21
MF-224	100	MF-296	110, 161	MF-85	119	NK-152	4	NK-220	13	NK-288	21
MF-225	99	MF-30	116	MF-86	119	NK-153	4	NK-221	13	NK-289	21
MF-226	99	MF-31	116	MF-87	119	NK-154	4	NK-222	13	NK-29	46
MF-227	99	MF-32	116	MF-88	119	NK-155	4	NK-223	13	NK-290	21
MF-228	99	MF-33	116	MF-89	121	NK-156	4	NK-224	14	NK-291	21
MF-229	99	MF-331	112, 163	MF-90	121	NK-157	4	NK-225	14	NK-292	21
MF-23	118	MF-332	112, 163	MF-91	121	NK-158	4	NK-226	14	NK-293	21
MF-230	99	MF-333	112, 163	MF-92	121	NK-159	6	NK-227	14	NK-294	21
MF-231	98, 162	MF-334	112, 163	MF-93	121	NK-16	8	NK-228	14	NK-295	21
MF-232	98	MF-34	116	MF-94	121	NK-160	6	NK-229	14	NK-296	22
MF-233	98	MF-35	116	MF-95	121	NK-161	6	NK-23	47	NK-297	22
MF-235	97	MF-36	116	MF-96	121	NK-162	6	NK-23	162	NK-298	22
MF-236	97	MF-37	116	NK-03	47	NK-163	6	NK-230	14	NK-299	22
MF-237	97	MF-38	116	NK-04	47	NK-164	6	NK-231	14	NK-30	5
MF-238	97	MF-39	116	NK-06	9	NK-166	6	NK-232	15	NK-300	22
MF-239	96	MF-40	116	NK-07	14	NK-167	6	NK-233	15	NK-301	22
MF-24	116	MF-401	41	NK-08	9	NK-168	6	NK-234	15	NK-302	22
MF-240	96	MF-402	41	NK-09	3	NK-169	6	NK-235	15	NK-303	22
MF-241	96	MF-403	41	NK-1	24	NK-17	3	NK-236	35	NK-304	22
MF-242	96	MF-404	41	NK-10	9	NK-170	7	NK-237	35	NK-305	23
MF-243	104	MF-405	41	NK-103	50	NK-171	7	NK-238	35	NK-306	23
MF-244	104	MF-406	41	NK-104	50	NK-172	7	NK-239	18	NK-307	23
MF-245	104	MF-407	41	NK-105	50	NK-173	7	NK-239	35	NK-308	23
MF-246	104	MF-408	41	NK-106	147	NK-174	7	NK-24	47	NK-309	23
MF-247	104	MF-409	41	NK-107	3	NK-175	7	NK-240	36, 16	NK-310	23
MF-248	104	MF-41	116	NK-108	3	NK-176	7	NK-241	36, 163	NK-311	23
MF-25	116	MF-410	41	NK-109	48	NK-177	7	NK-242	36, 163	NK-312	23
MF-253	105	MF-411	41	NK-11	47	NK-178	7	NK-243	36	NK-313	23
MF-254	105	MF-412	41	NK-110	48	NK-179	7	NK-244	36	NK-314	23
MF-255	105	MF-413	41	NK-111	48	NK-18	4	NK-245	36	NK-315	16
MF-257	106	MF-414	41	NK-112	48	NK-180	7	NK-247	56	NK-316	16
MF-258	106	MF-415	41	NK-113	147	NK-181	8	NK-248	56	NK-317	16
MF-259	106	MF-416	41	NK-114	147	NK-182	8	NK-249	56	NK-318	16
MF-26	116	MF-417	41	NK-115	147	NK-183	8	NK-25	47	NK-319	16
MF-260	106	MF-418	41	NK-116	147	NK-184	8	NK-250	56	NK-32	5
MF-261	108, 162	MF-419	41	NK-117	147	NK-185	8	NK-251	56	NK-320	52
MF-262	108, 162	MF-42	116	NK-118	147	NK-186	8	NK-252	55	NK-321	52
MF-263	108	MF-420	41	NK-119	147	NK-187	9	NK-253	55	NK-322	52
MF-264	108, 161	MF-421	41	NK-12	24	NK-188	9	NK-254	55	NK-323	17
MF-265	108, 161	MF-422	41	NK-120	147	NK-189	9	NK-255	55	NK-324	17
MF-266	107	MF-423	41	NK-121	147	NK-19	3	NK-256	55	NK-325	17
MF-267	107	MF-424	41	NK-122	148	NK-190	9	NK-257	55	NK-327	57
MF-268	107	MF-43	116	NK-123	148	NK-191	9	NK-258	50	NK-328	57
MF-269	107	MF-44	116	NK-124	148	NK-192	9	NK-259	50	NK-330	18
MF-27	116	MF-47	118	NK-125	148	NK-193	9	NK-26	47	NK-331	18
MF-270	107	MF-48	118	NK-126	148	NK-194	10	NK-260	50	NK-332	44

NK-333	32	NK-422	150, 161, 164	OE-112	143	OE-92	143	OL-233	156	OM-22	27
NK-334	32	NK-423	48	OE-113	145	OE-93	143	OL-234	156	OM-23	27
NK-335	33	NK-424	48	OE-114	145	OE-94	143	OL-235	156	OR-14	135
NK-336	33	NK-425	48	OE-115	145	OE-95	143	OL-236	156	OR-15	135
NK-337	33	NK-427	42	OE-116	145	OE-96	143	OL-237	156	OR-17	135, 161, 164
NK-338	33	NK-43	36, 163	OE-119	144	OE-97	143	OL-238	156	OR-19	135
NK-339	33	NK-434	37, 164	OE-120	144	OE-98	143	OL-239	156	OR-20	135
NK-34	5	NK-435	37, 164	OE-121	144	OE-99	143	OL-240	156	OR-40	135
NK-340	43	NK-436	37, 164	OE-122	144	OF-14	139	OL-241	157	OR-42	135
NK-341	43	NK-44	46	OE-123	144	OF-15	139	OL-242	157	OR-45	135
NK-342	43	NK-45	51	OE-124	145	OF-16	139	OL-243	157	P-100	134
NK-343	43	NK-450	58, 164	OE-125	145	OF-17	139	OL-244	157	P-101	133
NK-344	43	NK-451	57, 164	OE-126	145	OF-18	139	OL-245	157	P-102	133
NK-345	43	NK-452	57, 164	OE-127	145	OF-19	139	OL-246	157	P-120	133
NK-346	43	NK-456	60, 164	OE-128	145	OF-20	139	OL-247	157	P-121	133, 161, 164
NK-347	43, 161	NK-457	60, 164	OE-129	145	OF-21	139	OL-248	157	P-264	133
NK-348	43, 162	NK-458	60, 164	OE-130	145	OF-22	139	OL-249	157	P-265	133
NK-348		NK-459	60, 164	OE-131	145	OF-24	139	OL-250	157	P-50	134
NK-349	42, 43, 161	NK-46	51	OE-132	145	OF-25	139	OL-251	157	P-91	133
NK-350	43	NK-47	51	OE-133	145	OL-111	158	OL-252	157	P-92	133
NK-36	5	NK-48	48	OE-18	158	OL-179	158	OL-253	157	P-93	133
NK-360	44	NK-49	3	OE-19	158	OL-180	151	OL-254	157	P-94	133
NK-361	44	NK-59	37	OE-20	158	OL-181	151	OL-255	157	P-96	133
NK-362	44	NK-59L	37	OE-20	161	OL-182	151	OL-256	157	P-97	133
NK-363	44	NK-60	90	OE-40	139	OL-183	151	OL-257	157	PF-16	39
NK-364	44	NK-61	90	OE-41	139	OL-184	151	OL-258	157	PF-30	45
NK-365	44	NK-62	90	OE-42	139	OL-185	151	OL-259	157	PF-31	45
NK-366	44	NK-63	90	OE-43	139	OL-186	151	OL-260	157	PF-33	45
NK-36B	5	NK-64	90	OE-44	141	OL-187	151	OL-261	157	PF-34	45
NK-370	39	NK-65	90	OE-45	141	OL-188	151	OL-262	157	PF-35	45
NK-371	39	NK-66	90	OE-46	141	OL-189	151	OL-263	158	PF-37	45
NK-372	31	NK-67	90	OE-47	141	OL-190	151	OL-264	158	PF-60	39
NK-373	31	NK-68	90	OE-48	141	OL-191	151	OL-265	158	PF-61	39
NK-374	31	NK-69	90	OE-49	141	OL-192	151	OL-266	158	SC-1	78
NK-375	31	NK-70	90, 163	OE-50	141	OL-193	151	OL-267	158	SC-9	78
NK-376	53	NK-71	90	OE-51	141	OL-194	151	OL-268	158	TS-101	172
NK-377	53	NK-72	90, 163	OE-52	141	OL-195	151	OL-269	158	TS-102	172
NK-378	53	NK-73	90	OE-54	139	OL-196	151	OL-270	158	TS-103	161, 172
NK-379	53	NK-74	47, 163	OE-55	140	OL-197	151	OL-271	158	TS-104	163, 172
NK-38	5	NK-75	47	OE-56	140	OL-198	151	OL-272	158	VPC-10	169
NK-380	53	NK-76	47	OE-57	139	OL-199	151	OL-273	159	VPC-12	169
NK-381	53	NK-77	90, 163	OE-58	140	OL-20	48	OL-274	159	VPC-6	169
NK-382	53	NK-78	90	OE-59	140	OL-200	151	OL-275	159	VPC-8	169
NK-383	53	NK-79	146	OE-60	140	OL-201	151	OL-276	159	VS-20	171
NK-384	54	NK-80	146	OE-61	142	OL-202	152	OL-277	159	VS-26	171
NK-385	54	NK-81	146	OE-62	142	OL-203	152	OL-278	159	VS-30	171
NK-386	54	NK-82	146	OE-63	142	OL-204	152	OL-279	159		
NK-387	54	NK-83	146	OE-64	142	OL-205	152	OL-280	159		
NK-388	19	NK-84	146	OE-65	142	OL-206	152	OL-281	159		
NK-389	19	NK-86	146	OE-66	142	OL-207	152	OL-282	159		
NK-39	3	NK-87	90, 162	OE-67	142	OL-208	152	OL-283	159		
NK-390	19	NK-88	90	OE-68	142	OL-209	152	OL-284	159		
NK-391	36	NK-89	90, 162	OE-69	142	OL-210	152	OL-285	159		
NK-392	56, 163	NK-92	149	OE-70	142	OL-211	152	OL-286	153		
NK-393	20	NK-93	47	OE-71	142	OL-212	154	OL-287	153		
NK-394	20	NK-94	46	OE-72	142	OL-213	154	OL-288	153		
NK-395	20	NK-95	11	OE-73	143	OL-214	154	OL-289	153		
NK-396	20	NK-96	11	OE-74	143	OL-215	154	OL-290	160		
NK-397	20	NK-97	44	OE-75	143	OL-216	154	OL-291	160		
NK-399	42	NK-97A	44	OE-76	143	OL-217	155	OL-292	160		
NK-40	5	NK-98	44	OE-77	143	OL-218	155	OL-293	160		
NK-401	89	NK-99	44	OE-78	143	OL-219	155	OL-294	153		
NK-403	89	OE-10	158	OE-79	143	OL-220	155	OL-295	153		
NK-405	89	OE-100	143	OE-80	143	OL-221	155	OL-296	153		
NK-407	89	OE-101	143	OE-81	143	OL-222	155	OL-297	153		
NK-41	36, 163	OE-102	143	OE-82	143	OL-223	155	OL-51	150		
NK-410	90	OE-103	143	OE-83	143	OL-224	155	OL-52	150		
NK-412	91	OE-104	143	OE-84	143	OL-225	156	OL-53	150		
NK-413	91	OE-105	143	OE-85	143	OL-226	156	OL-54	150		
NK-414	91	OE-106	143	OE-86	143	OL-227	156	OL-55	150		
NK-415	91	OE-107	143	OE-87	143	OL-228	156	OL-56	150		
NK-417	42, 161	OE-108	143	OE-88	143	OL-229	156	OL-84	150		
NK-42	36, 163	OE-109	143	OE-89	143	OL-230	156	OL-85	150		
NK-420	150	OE-110	143	OE-90	143	OL-231	156	OM-09	58		
NK-421	150	OE-111	143	OE-91	143	OL-232	156	OM-20	27		