



BROMED
INSTRUMENTS

Das Instrument.



Chirurgische Instrumente Katalog

Mikro-Chirurgie

Catalogue des instruments chirurgicaux

Micro-Chirurgie

Catálogo de instrumentos quirúrgicos

Micro-Cirugía

Catalogo di strumenti chirurgici

Micro-Chirurgia

Catalogue of Surgical Instruments

Micro-Surgery



Specialties Microsurgery



BROMMED
INSTRUMENTS



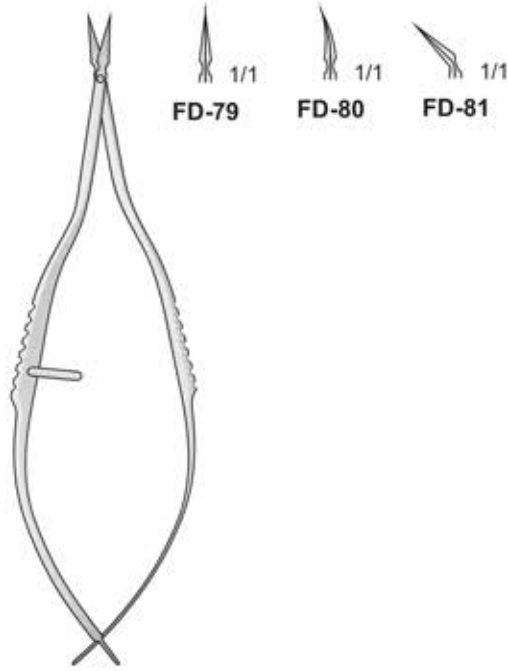

VANNAS
FD-79/FD-81
85 mm



FD-61
110 mm

Spitz - Sharp
Acuta - Agudas - Pointu

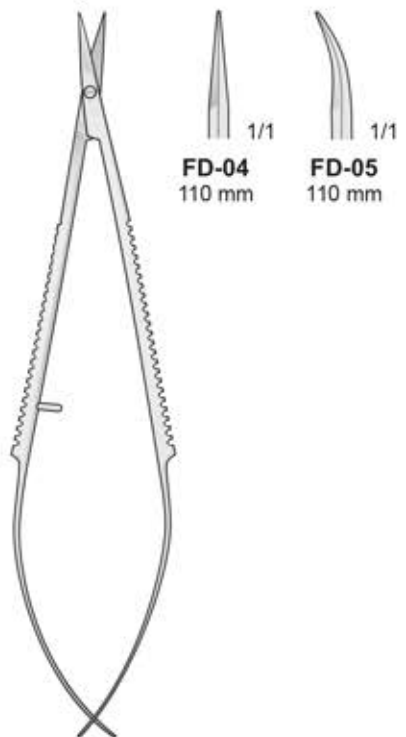

FD-04/FD-05
110 mm

Stumpf - Blunt
Smussa - Romas - Mousse

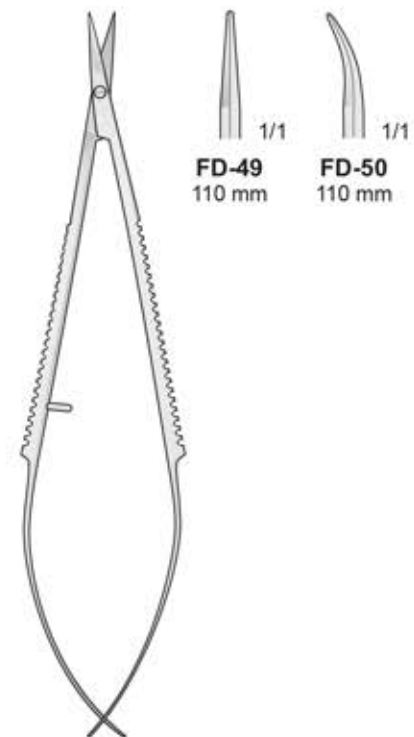

FD-50
110 mm

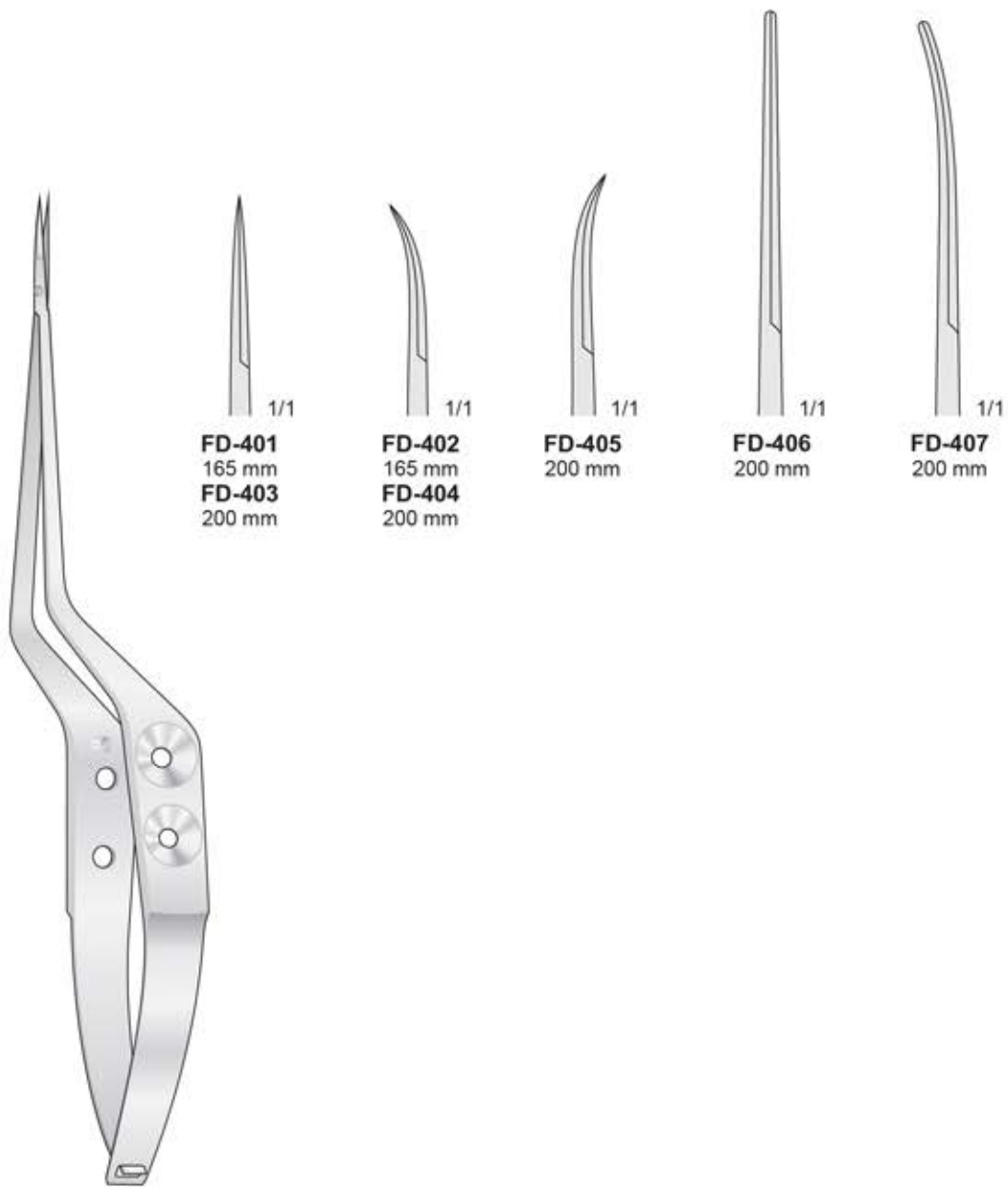

YASARGIL
FD-401/FD-407

Gezahnt
Serrated
Dentellata
Dentadas
Dentelés

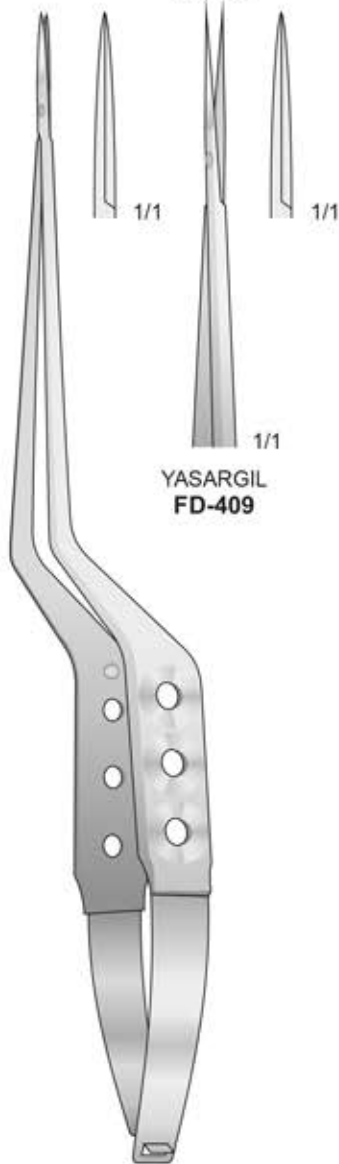

YASARGIL
FD-409

YASARGIL
FD-408
225 mm

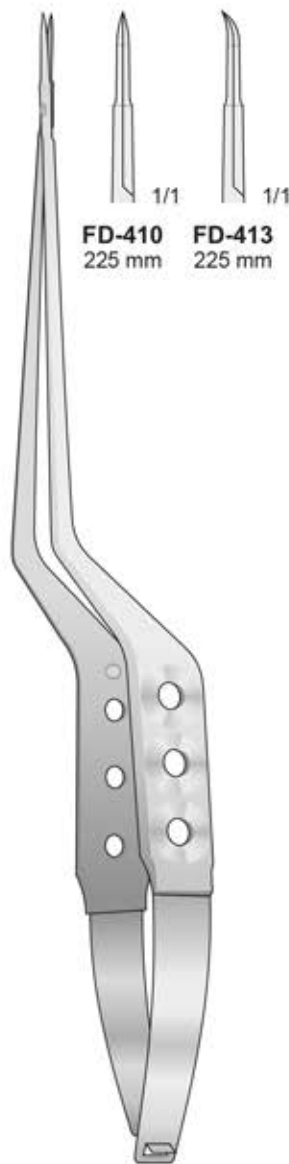

FD-410 225 mm
FD-413 225 mm

VANNAS
FD-410/FD-413
225 mm

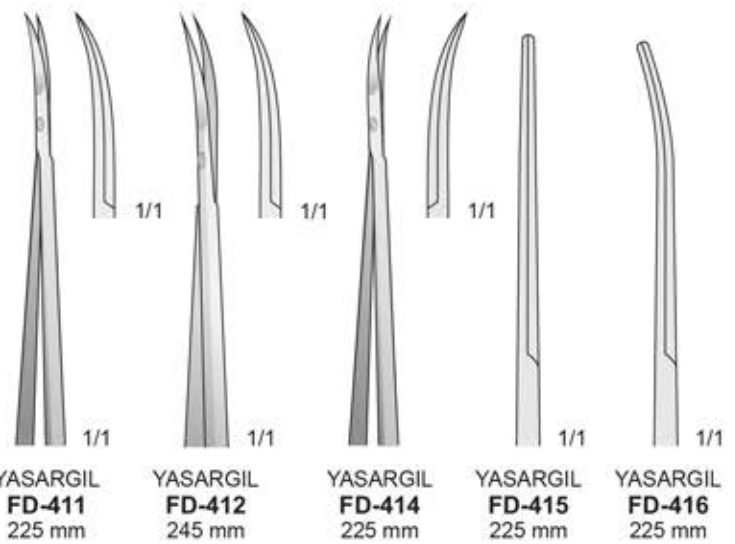

YASARGIL
FD-411
225 mm

YASARGIL
FD-412
245 mm

YASARGIL
FD-414
225 mm

YASARGIL
FD-415
225 mm

YASARGIL
FD-416
225 mm

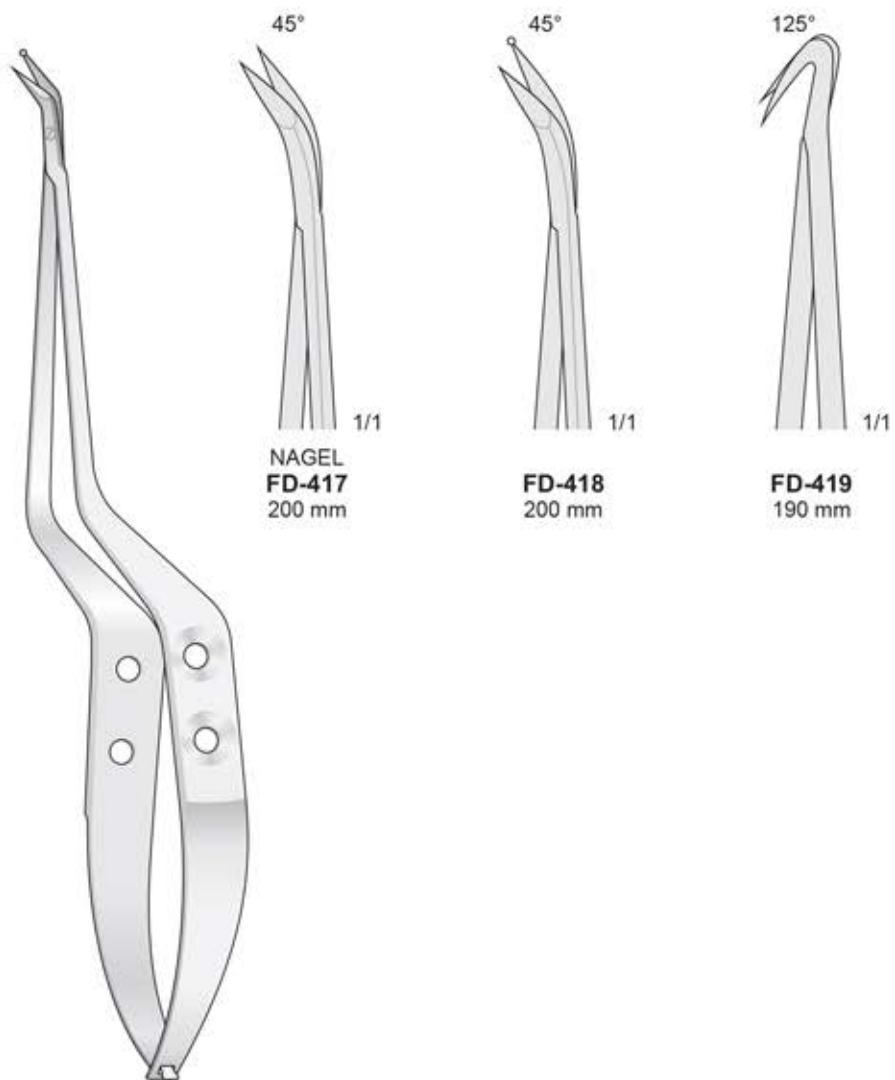

FD-417/FD-419



FD-306/FD-311
190 mm



FD-306



FD-307



1/1



FD-310



FD-311



1/1

Spitz - Sharp
Acuta - Agudas - Pointu



FD-139 **FD-140**



FD-139/FD-140
220 mm

Spitz - Sharp
Acuta - Agudas - Pointu

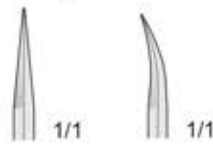

FD-141 **FD-142**



FD-141/FD-142
225 mm

Stumpf - Blunt
Smussa - Romas - Mousse

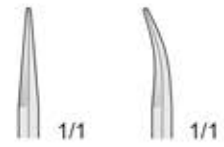

FD-143 **FD-144**



FD-143/FD-144
225 mm

Stumpf - Blunt
Smussa - Romas - Mousse

Spitz - Sharp
Acuta - Agudas - Pointu

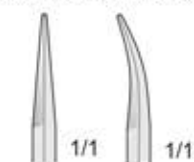

FD-75 FD-76

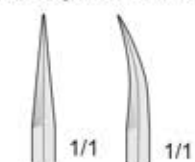

FD-77 FD-78

Stumpf
Blunt
Smussa

Schneiden gezahnt - Spitz
Serrated blades - Sharp
Lame zigrinate - Acuta

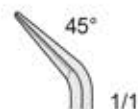

FD-75/FD-76
230 mm

FD-77/FD-78
230 mm

FD-133
160 mm

FD-145
160 mm



FD-430/FD-444



1/1

FD-430
120 mm
FD-432
160 mm
MILLES
FD-434
160 mm
YASARGIL
FD-436
185 mm



1/1

FD-431
120 mm
FD-433
160 mm
MILLES
FD-435
160 mm
JACOBSON
FD-437
185 mm



1/1

VANNAS
FD-438
120 mm
VANNAS
FD-441
160 mm



1/1

VANNAS
FD-439
120 mm
VANNAS
FD-442
160 mm



1/1

BIEMER
FD-443
130 mm



1/1

VANNAS
FD-440
120 mm



1/1

POTTS-YASARGIL
FD-444
185 mm



FD-182/FD-183
160 mm



FD-182
160 mm

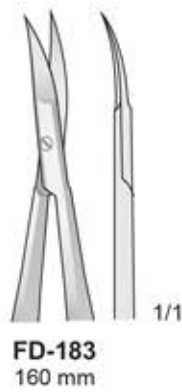

FD-183
160 mm

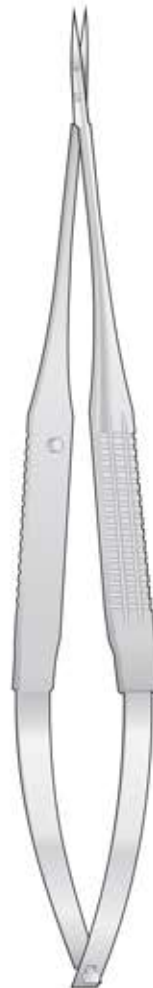

FD-186/FD-199



**YASARGIL
FD-186**
185 mm

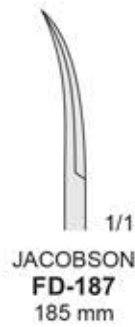

**JACOBSON
FD-187**
185 mm



**VANNAS
FD-195**
120 mm

**VANNAS
FD-198**
160 mm



**VANNAS
FD-196**
120 mm

**VANNAS
FD-199**
160 mm



**VANNAS
FD-197**
120 mm



**POTTS-YASARGIL
FD-191**
185 mm

Stumpf - Blunt
Smussa - Romas
Mousse

Stumpf - Blunt
Smussa - Romas
Mousse

Spitz - Sharp
Acuta - Aguda
Pointu

Spitz - Sharp
Acuta - Aguda
Pointu

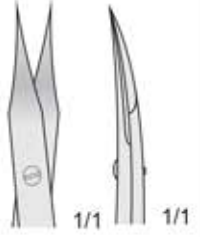
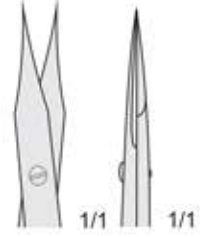
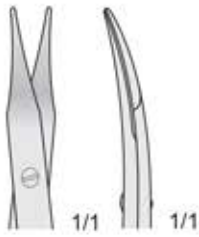
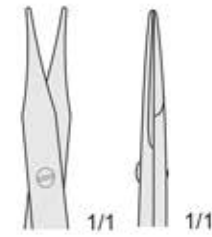

Gerade - Straight
Diritta - Rectas
Droites

Gebogen - Curved
Curva - Curvas
Courbes

Gerade - Straight
Diritta - Rectas
Droites

Gebogen - Curved
Curva - Curvas
Courbes

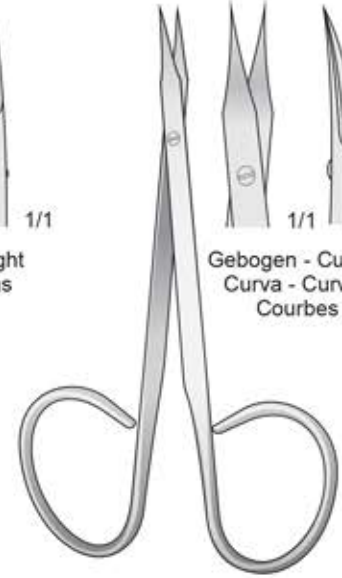
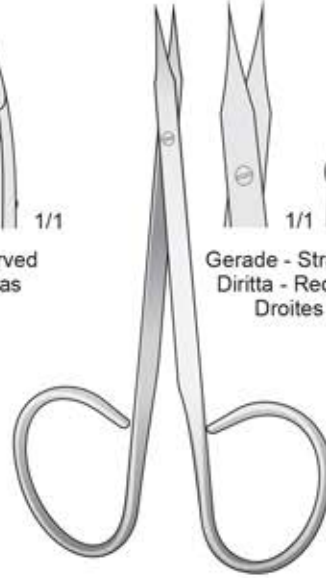
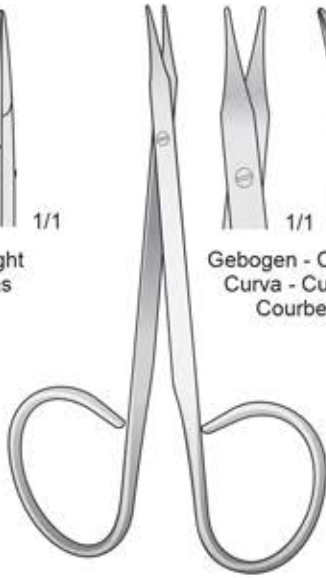
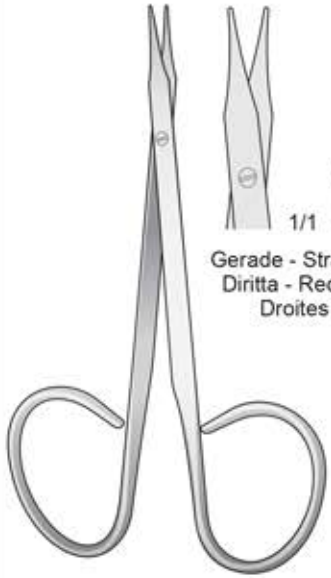

STEVENS
FG-209
100 mm

STEVENS
FG-210
100 mm

WALTON
FG-211
100 mm

WALTON
FG-212
100 mm

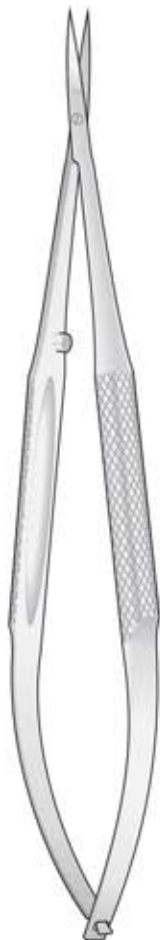

FD-224/FD-230



FD-224 145 mm
FD-227 180 mm



FD-230 230 mm





FD-225 145 mm
FD-228 180 mm

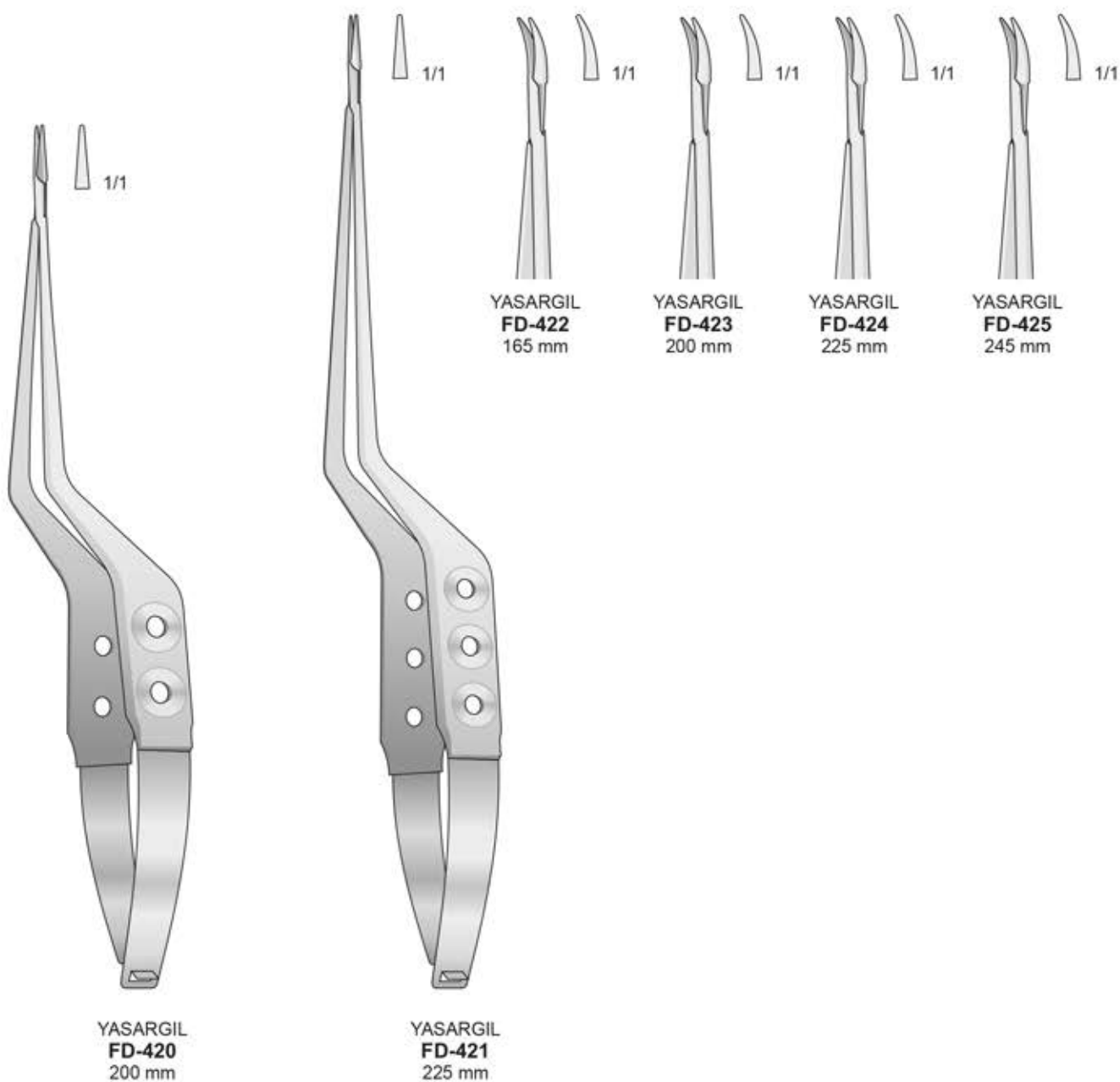

FD-226 145 mm
FD-229 180 mm





 1/1
FD-426
 160 mm
FD-427
 185 mm
 1/1
FD-428
 160 mm
FD-429
 185 mm



FD-426/FD-429



 1/1
FD-101
 1/1
FD-102

FD-101/FD-102
225 mm



 1/1
FD-103
 1/1
FD-104

FD-103/FD-104
225 mm

Glattes Maul - Smooth Jaw
Morso liscio - Boca lisa
Mors lisse



FD-148/FD-149
185 mm

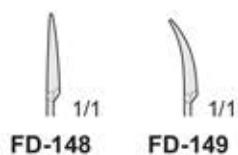

REILL
FD-152/FD-157
150 mm

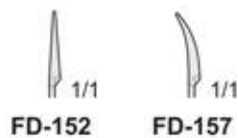

BARRAQUER
FD-150/FD-151
120 mm

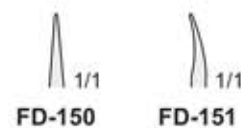

Glattes Maul - Smooth Jaw
 Morso liscio - Boca lisa
 Mors lisse

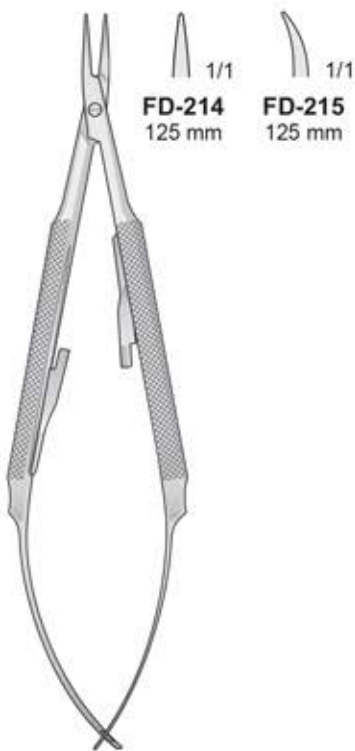

BARRAQUER
 FD-214/FD-215
 125 mm



BARRAQUER
 FD-216/FD-218

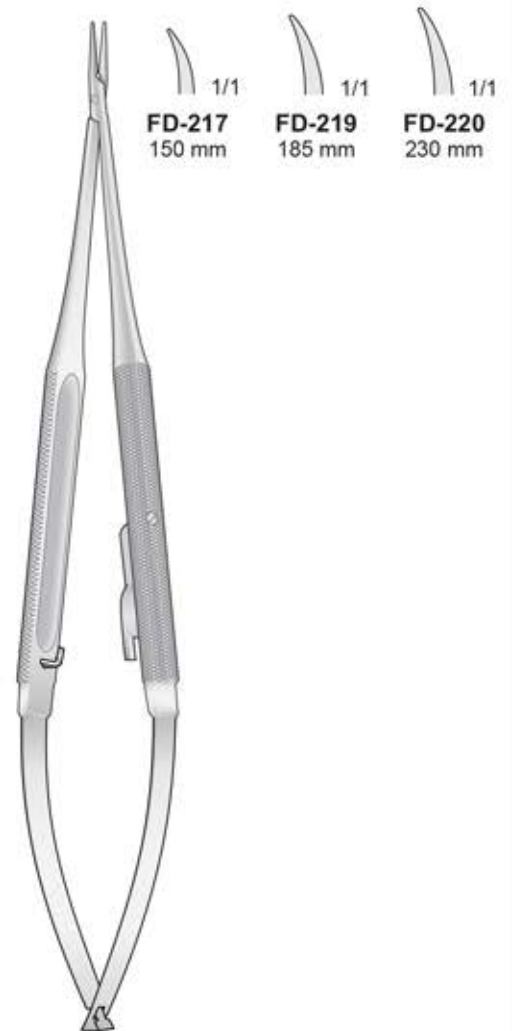

FD-217/FD-220

Glattes Maul
Smooth Jaw
Morso liscio
Boca lisa
Mors lisse



FD-17
140 mm

FD-19
140 mm

TC

Glattes Maul
Smooth Jaw
Morso liscio
Boca lisa
Mors lisse

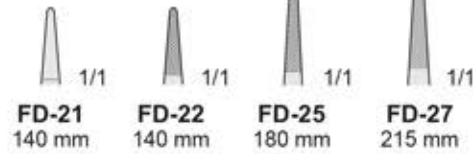

FD-21
140 mm

FD-22
140 mm

FD-25
180 mm

FD-27
215 mm

Glattes Maul
Smooth Jaw
Morso liscio
Boca lisa
Mors lisse

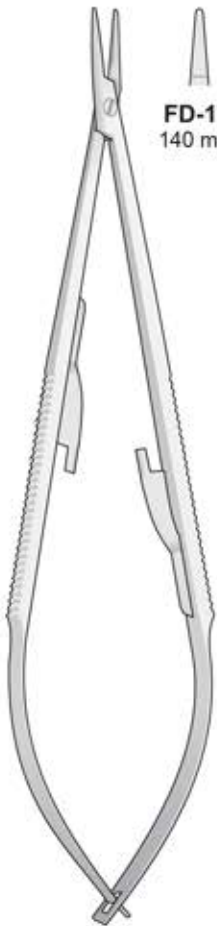

CASTROVIEJO
FD-17/FD-19
145 mm

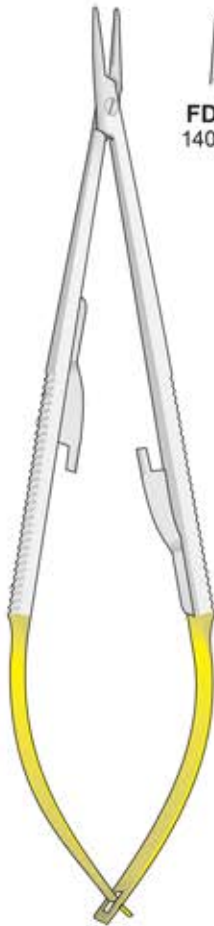

CASTROVIEJO
FD-21/FD-27

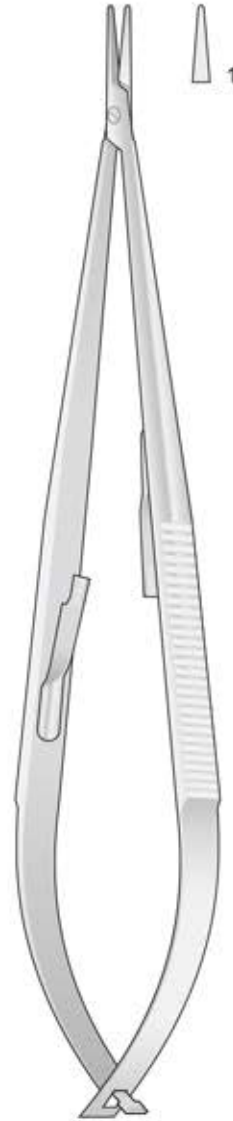

JACOBSON
FD-63
180 mm

Titan - Titanium - Titanio - Titane

Rund - Griffe Ø 8 mm

Mikro Nadelhalter
Micro Needle Holders
Micro port'aghi
Micro portaagujas
Micro porte aiguilles

Mikro Scheren
Micro Scissors
Micro forbici
Micro Tijeras
Micro ciseaux



1/1 1/1
FD-562T FD-563T

FD-562T/FD-563T
180 mm

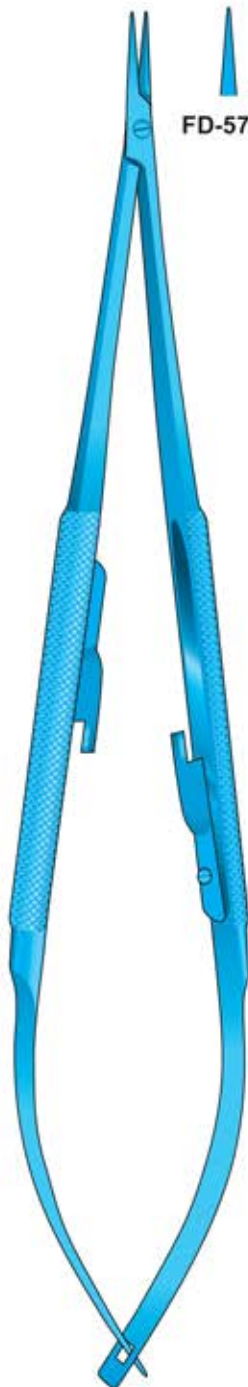

1/1 1/1
FD-574T FD-575T

FD-574T/FD-575T
180 mm

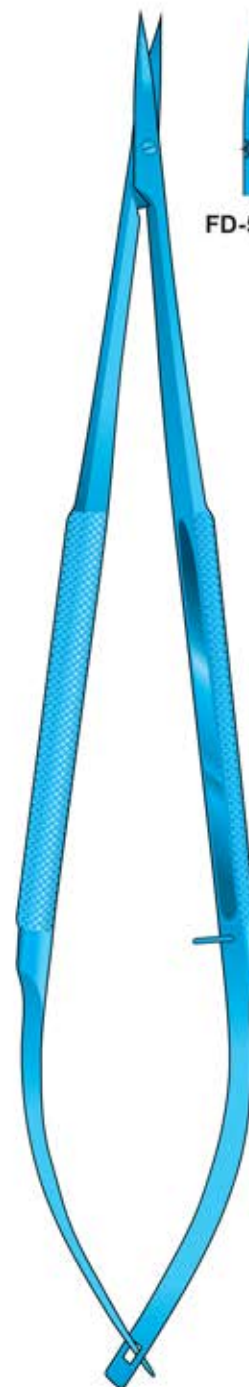

1/1 1/1
FD-587T FD-588T

FD-587T/FD-588T
180 mm

Titan - Titanium - Titanio - Titane

Mikro-Pinzette Ø 8 mm



MF-130T/MF-141T



Titan - Titanium - Titanio - Titane

Mikro-Knüpfpinzette Ø 8 mm

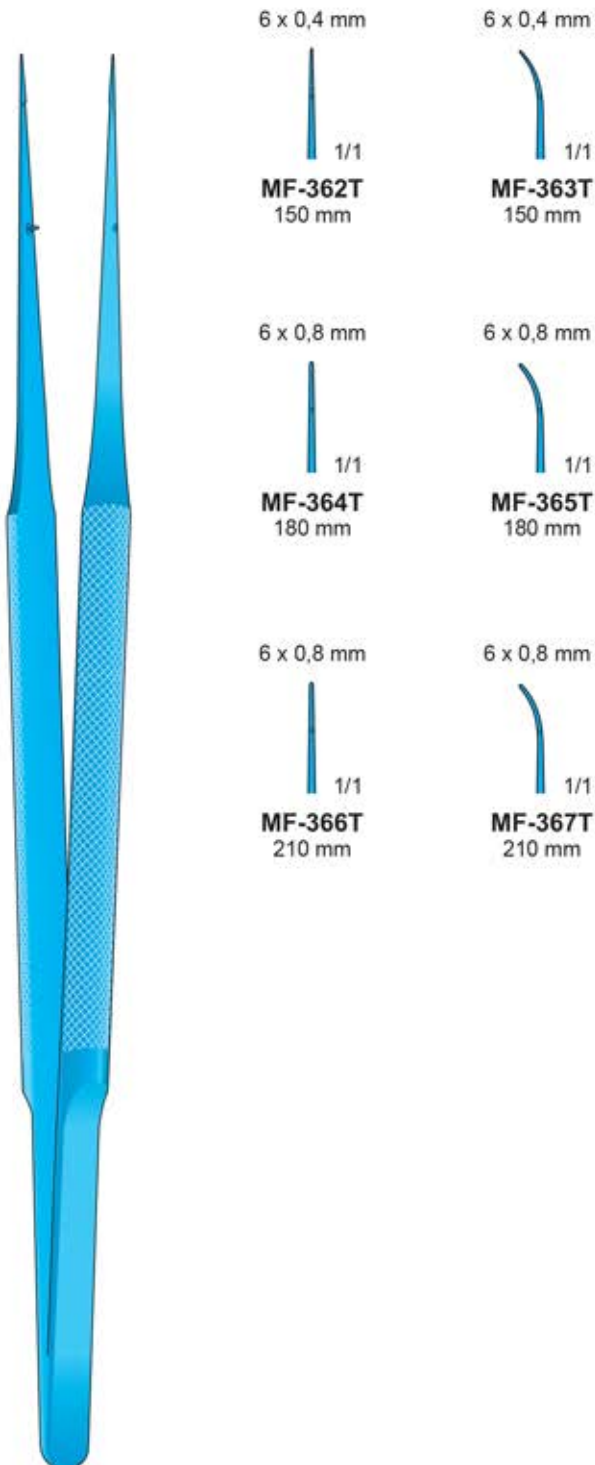

MF-362T/MF-367T

Titan - Titanium - Titanio - Titane

Mikro-Ringpinzette Ø 8 mm

Glatt - Smooth
Liscia - Lisa
Lisses

Gerieft - Serrated
Zigrinata - Estriadas
Stries



1 x 0,5 mm



1/1

MF-142T
150 mm

2 x 1 mm



1/1

MF-145T
150 mm

1 x 0,5 mm



1/1

MF-342T
150 mm

2 x 1 mm



1/1

MF-345T
150 mm

1 x 0,5 mm



1/1

MF-143T
180 mm

2 x 1 mm



1/1

MF-146T
180 mm

1 x 0,5 mm



1/1

MF-343T
180 mm

2 x 1 mm



1/1

MF-346T
180 mm

1 x 0,5 mm



1/1

MF-144T
210 mm

2 x 1 mm



1/1

MF-147T
210 mm

1 x 0,5 mm



1/1

MF-344T
210 mm

2 x 1 mm



1/1

MF-347T
210 mm

MF-142T/MF-347T

Titan - Titanium - Titanio - Titane

Mikro-Atrauma-Pinzette Ø 8 mm



Atrauma-Fino
1,2 mm



1/1

MF-348T
150 mm

Atrauma-Fino
1,2 mm



1/1

MF-349T
150 mm

Atrauma-Standard
1,8 mm



1/1

MF-354T
150 mm

Atrauma-Standard
1,8 mm



1/1

MF-355T
150 mm

Atrauma-Fino
1,2 mm



1/1

MF-350T
180 mm

Atrauma-Fino
1,2 mm



1/1

MF-351T
180 mm

Atrauma-Standard
1,8 mm



1/1

MF-356T
180 mm

Atrauma-Standard
1,8 mm



1/1

MF-357T
180 mm

Atrauma-Fino
1,2 mm



1/1

MF-352T
210 mm

Atrauma-Fino
1,2 mm



1/1

MF-353T
210 mm

Atrauma-Standard
1,8 mm



1/1

MF-358T
210 mm

Atrauma-Standard
1,8 mm



1/1

MF-359T
210 mm

MF-348T/MF-359T

Titan - Titanium - Titanio - Titane

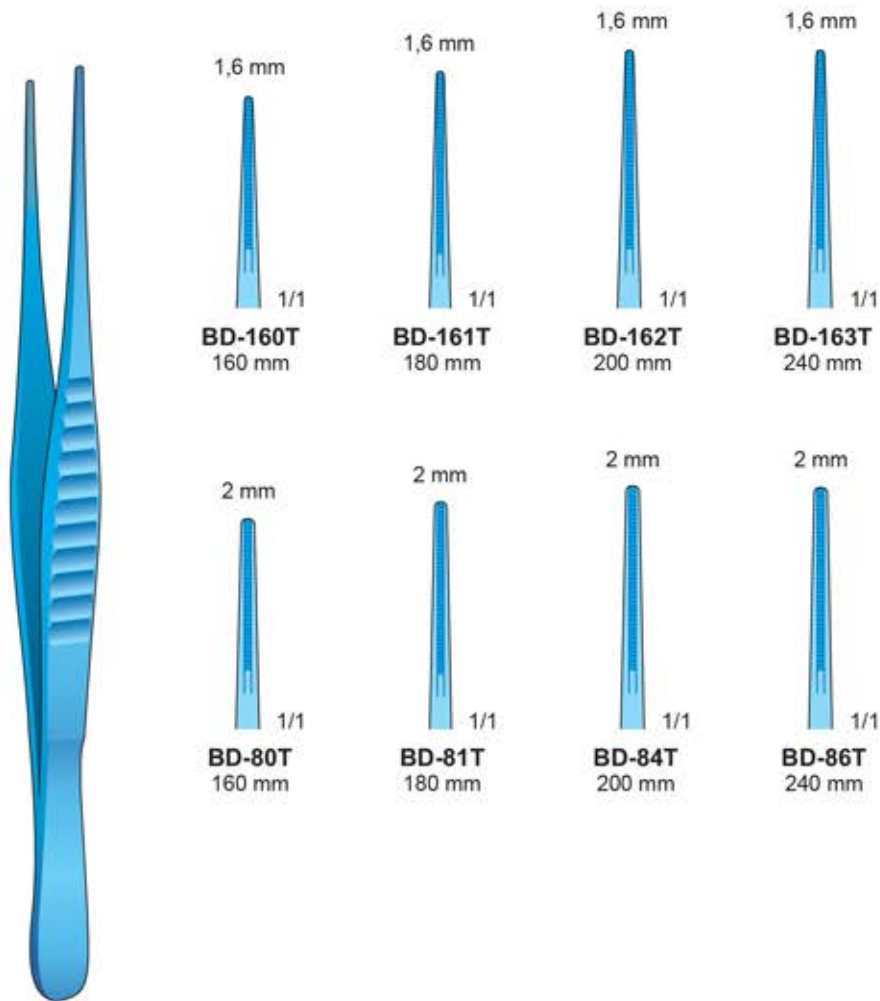
DE BAKEY
BD-80T/BD-163T



DE BAKEY
BD-165/BD-173

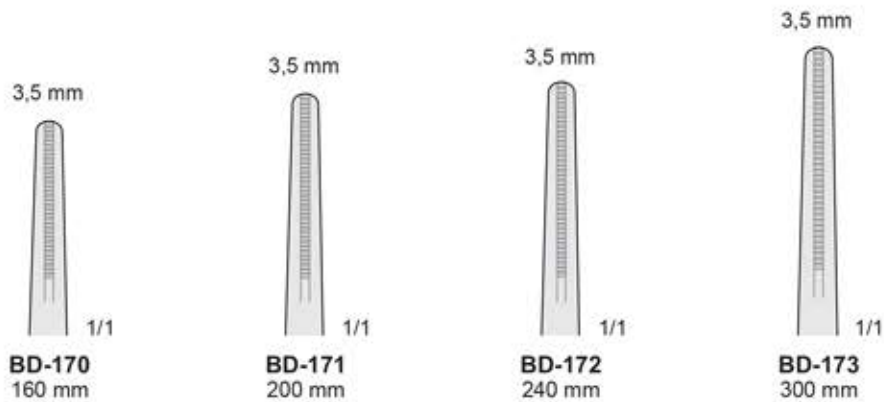
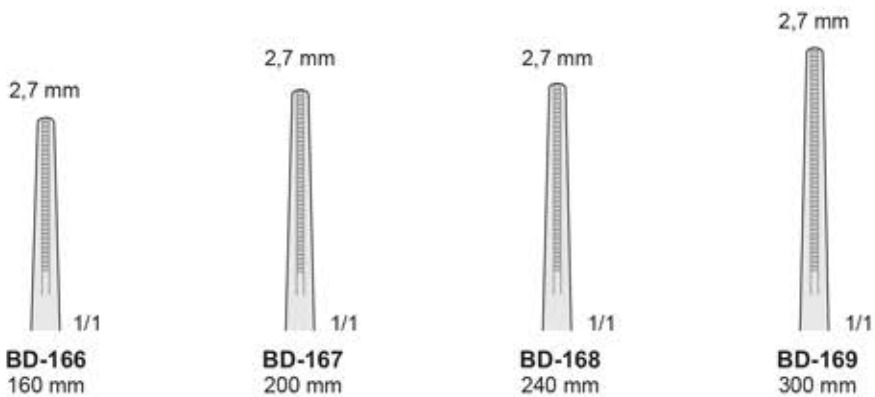



BD-160
160 mm



BD-161
180 mm



BD-162
200 mm



BD-163
240 mm

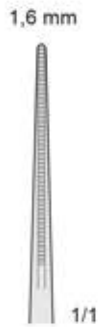

BD-164
300 mm

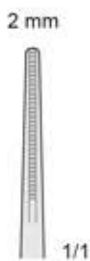

BD-80
160 mm

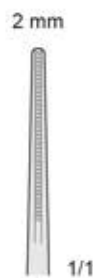

BD-81
180 mm



BD-84
200 mm

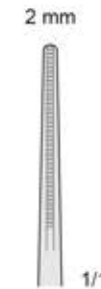

BD-86
240 mm

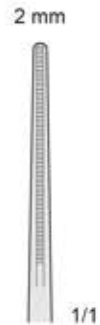

BD-88
300 mm



BD-82
160 mm



BD-83
180 mm

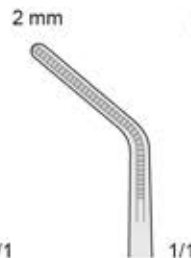

BD-85
200 mm



BD-87
240 mm

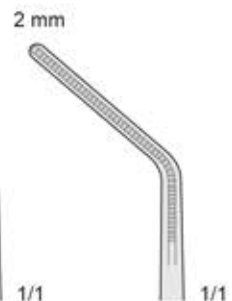

BD-89
300 mm



DE BAKEY
BD-80/BD-164

Rundgriff Ø 8 mm - Round Handle Ø 8 mm
Manico rotondo Ø 8 mm - Mango redondo Ø 8 mm
Manche rond Ø 8 mm

Mikro-Knüpfpinzetten mit Plateau - Micro Suture Tying Forceps with platform
Micro pinze per legature con piattino - Micro-Pinzas de ligadura con plataforma
Micro-Pinces à ligature avec plate-forme

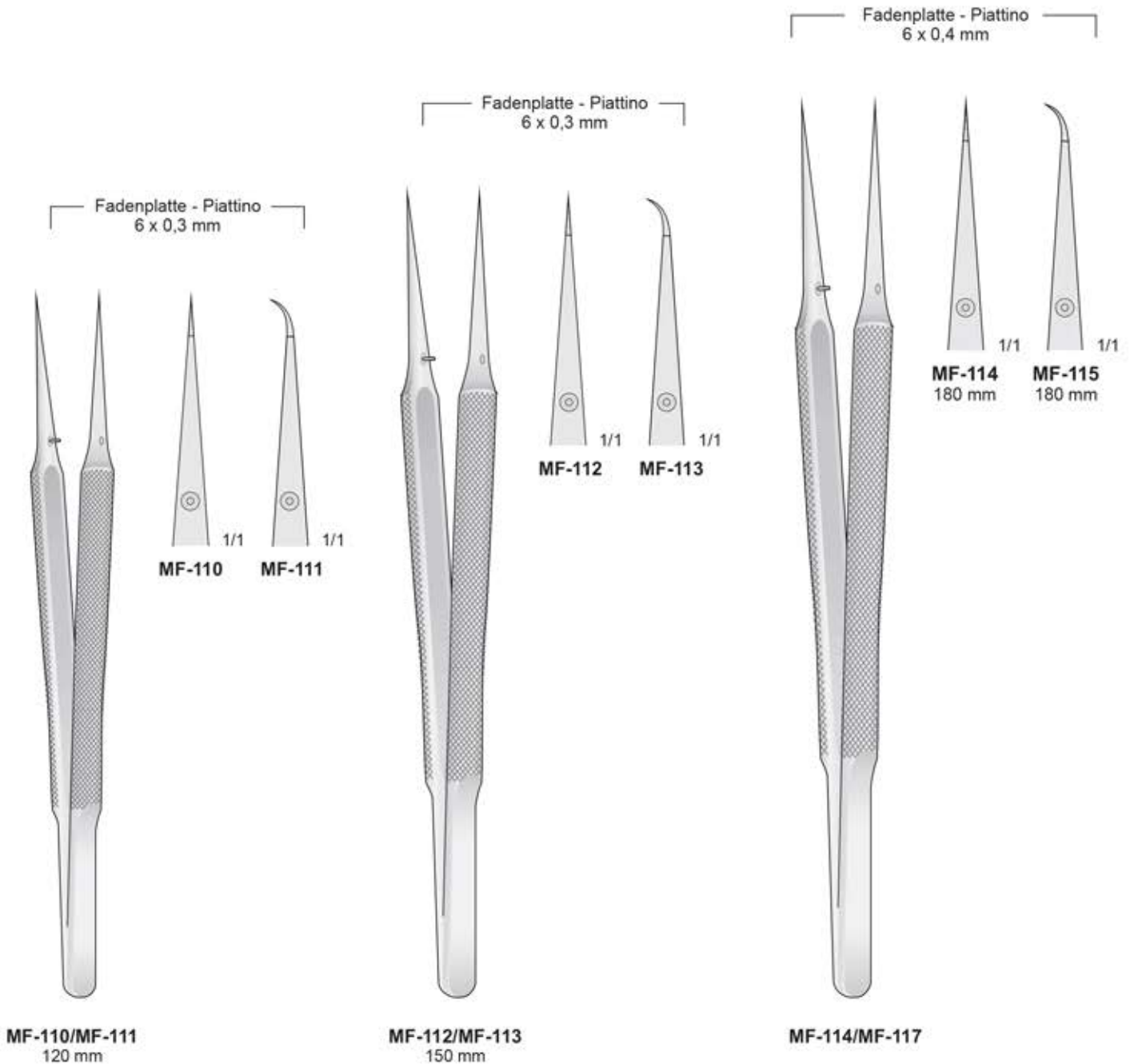

Mikro-Knüpfpinzetten mit Plateau - Micro Suture Tying Forceps with platform
Micro pinze per legature con piattino - Micro-Pinzas de ligadura con plataforma
Micro-Pincas à ligature avec plate-forme

Rundgriff Ø 8 mm
Round Handle Ø 8 mm
Manico rotondo Ø 8 mm
Mango redondo Ø 8 mm
Manche rond Ø 8 mm

Fadenplatte - Piattino
6 x 0,8 mm

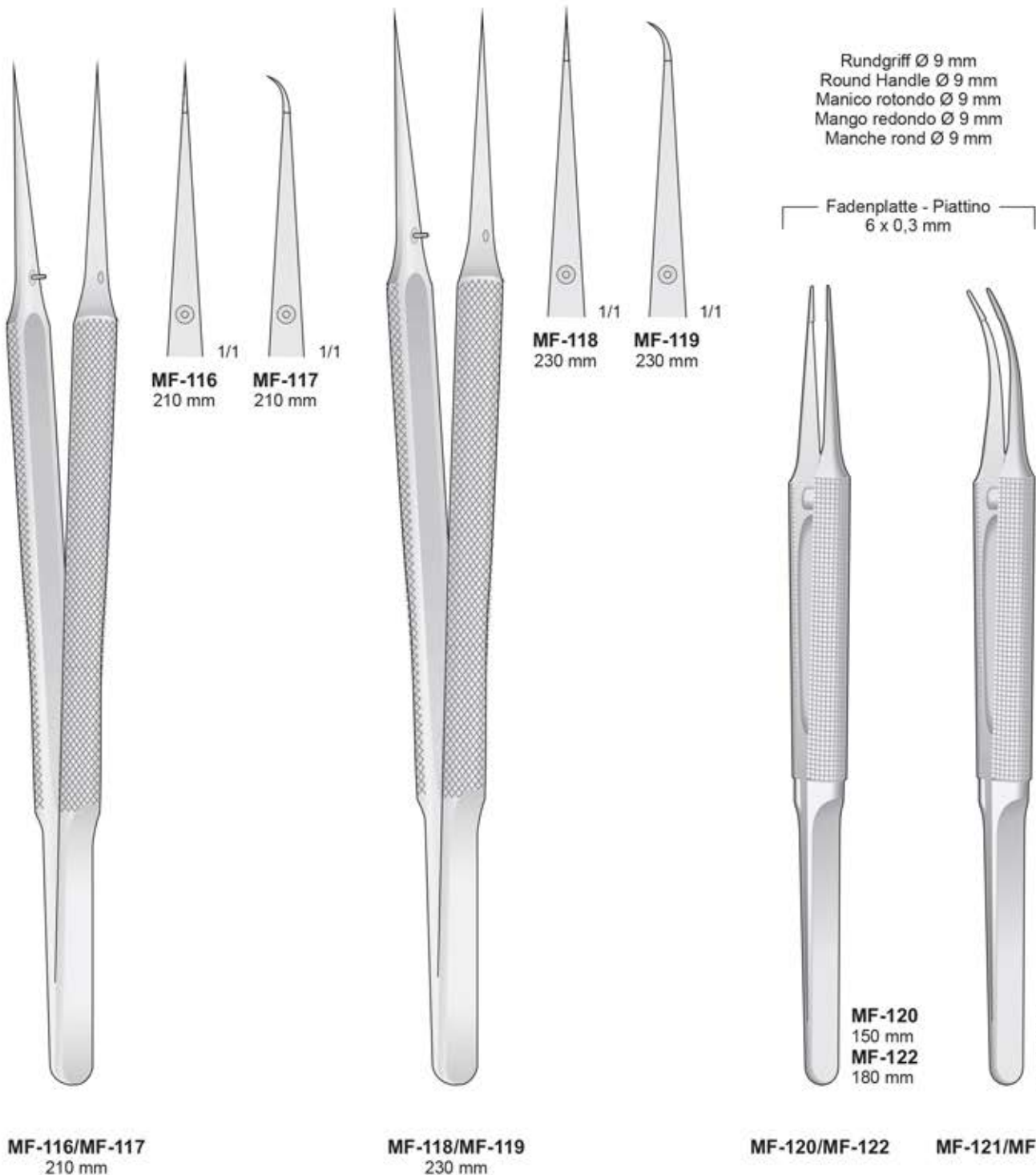

Mikro Pinzette - Rundgriff Ø 8 mm
 Mit Führungsstift diamantiert
 Fadenplatte 6x0,7 mm

Diamantiert
 Diamond Coated
 Diamantate
 Diamantadas
 Diamanté

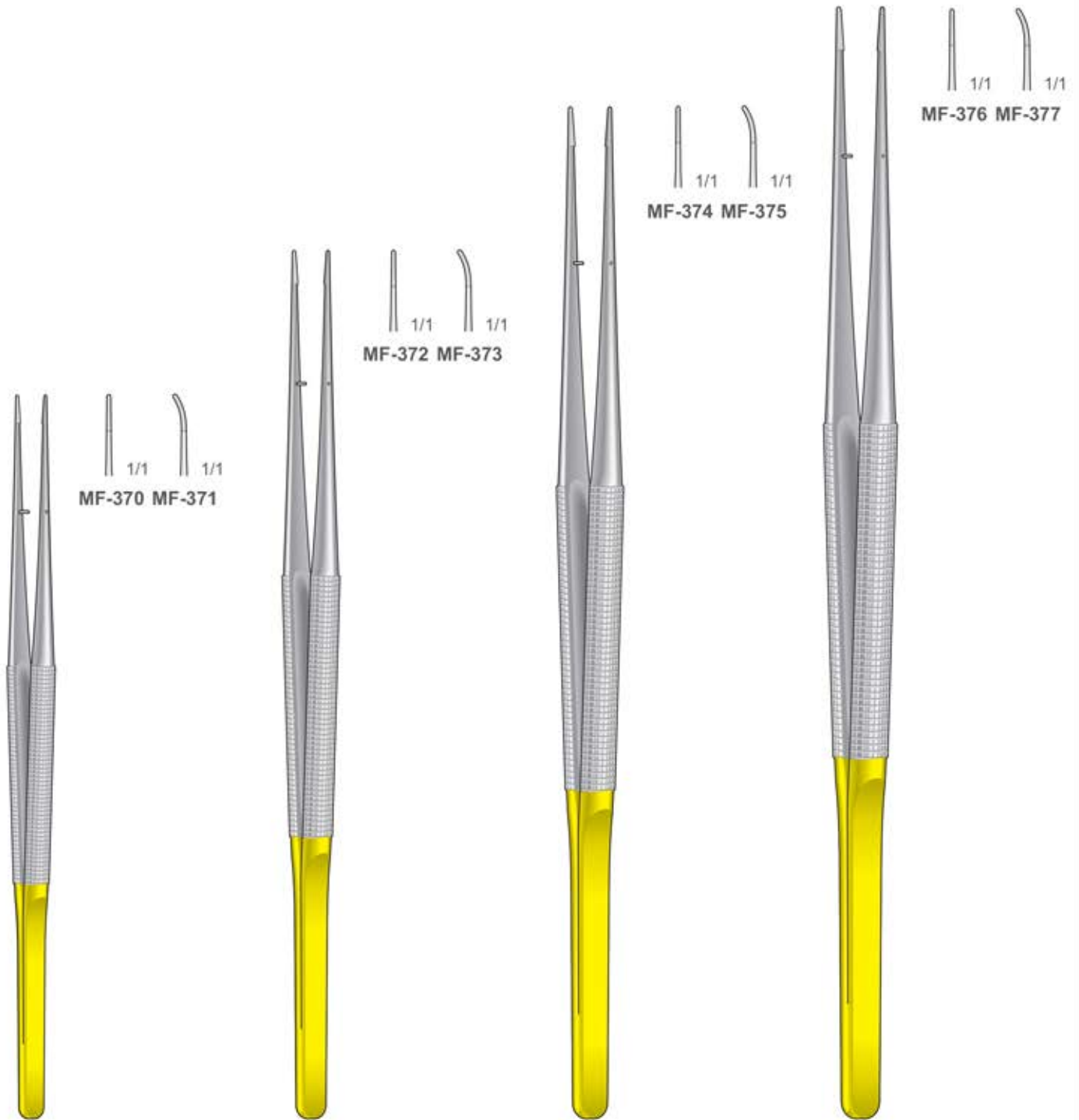

MF-370/MF-371
 150 mm

MF-372/MF-373
 180 mm

MF-374/MF-375
 210 mm

MF-376/MF-377
 230 mm

Mikro Pinzette - Rundgriff Ø 8 mm
 Mit Führungsstift diamantiert
 Fadenplatte 6x0,7 mm

Diamantiert
 Diamond Coated
 Diamantate
 Diamantadas
 Diamanté

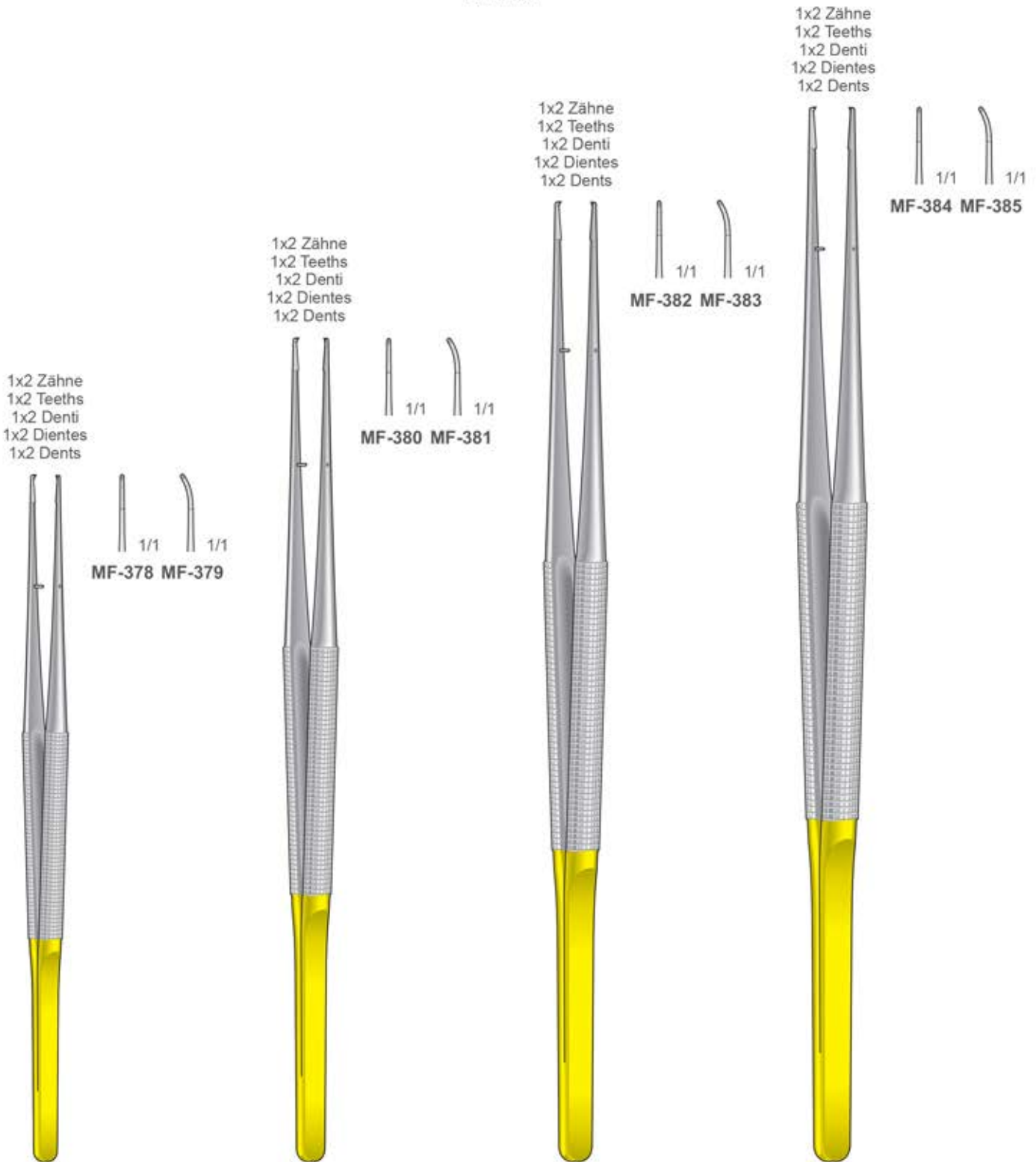

MF-378/MF-379
150 mm

MF-380/MF-381
180 mm

MF-382/MF-383
210 mm

MF-384/MF-385
230 mm

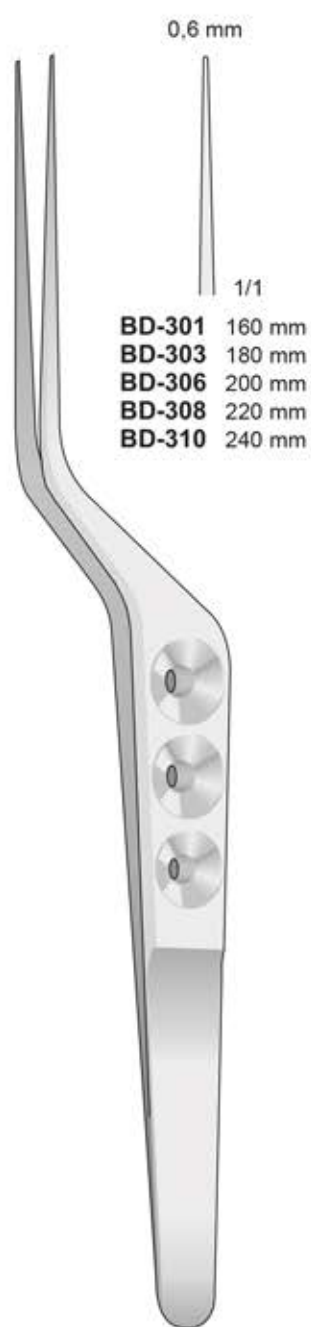

YASARGIL
BD-301/BD-310

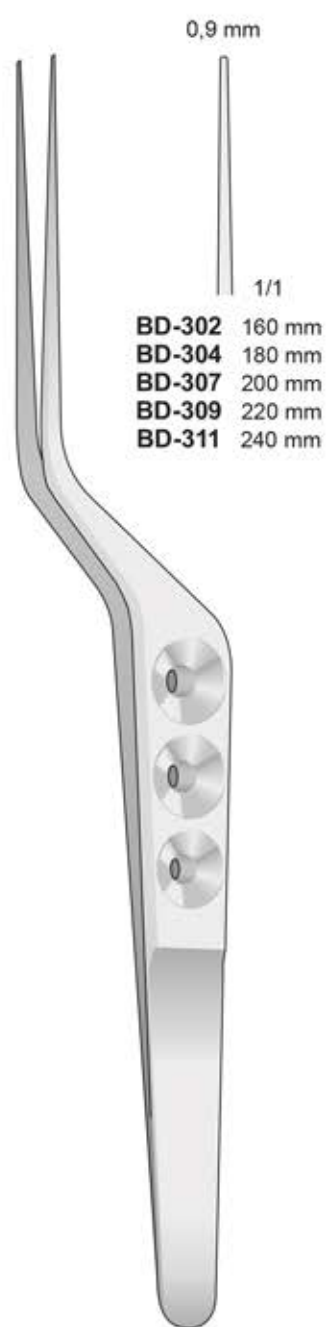

YASARGIL
BD-302/BD-311

1x2 Zähne
 1x2 Teeth
 1x2 Denti
 1x2 Dientes
 1x2 Dents



YASARGIL
BD-305
180 mm

Tumor Gewebefasszangen
 Tumor Tissue Grasping Forceps
 Pinza per tumori
 Pinzas para tumores
 Pinces pour tumeurs



BD-312/BD-320
220 mm

Ø 3 mm



YASARGIL
BD-312
 220 mm

Ø 3 mm



YASARGIL-SAMII
BD-318
 240 mm

Ø 5 mm



YASARGIL
BD-313
 220 mm

Ø 5 mm



YASARGIL-SAMII
BD-319
 240 mm

Ø 5 mm



YASARGIL-SAMII
BD-320
 240 mm

Ø 3 mm



YASARGIL
BD-314
 220 mm

Ø 5 mm



YASARGIL
BD-315
 220 mm

Ø 3 mm



HEIFETZ
BD-316
 220 mm

Ø 5 mm



HEIFETZ
BD-317
 220 mm

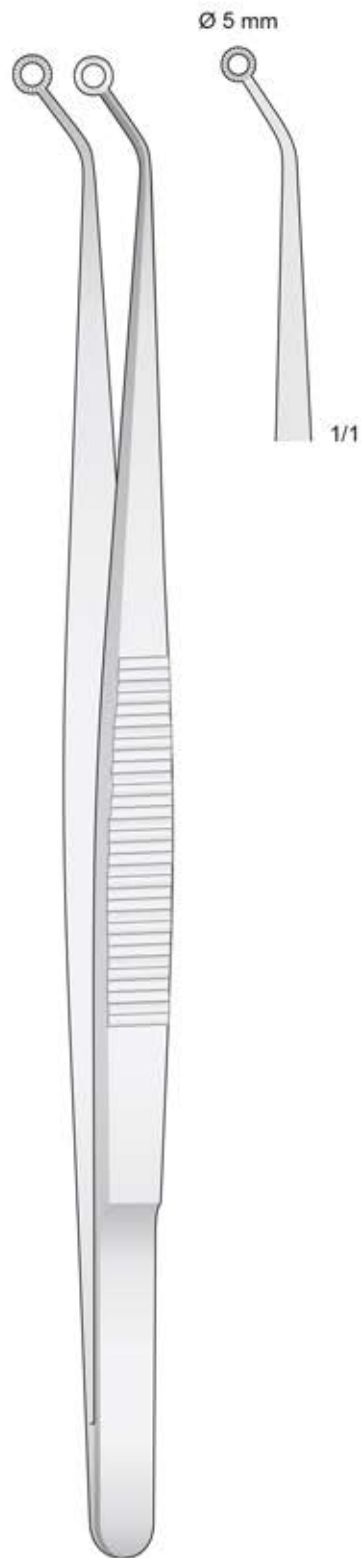

HUNT
BD-332
 200 mm

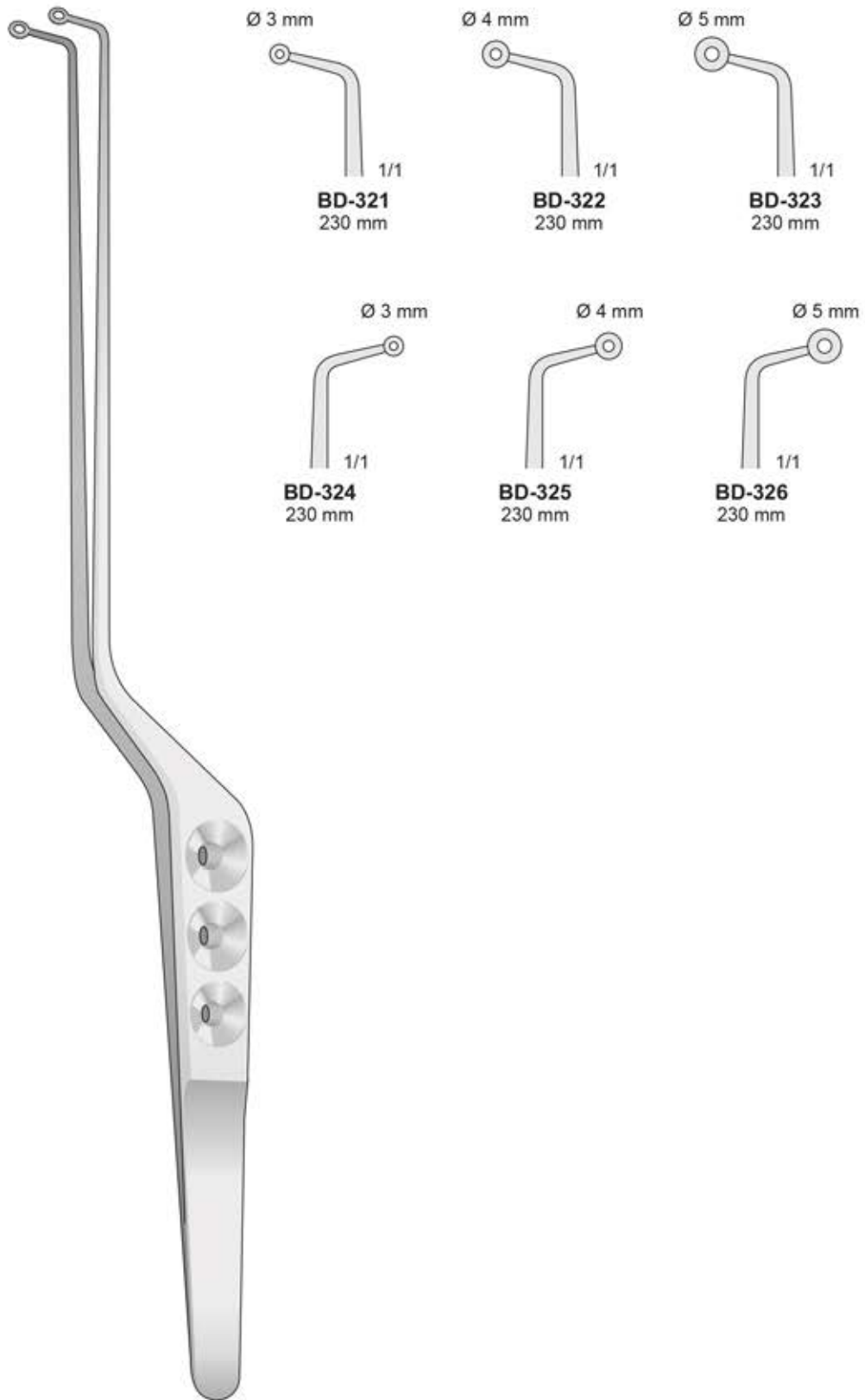

SAMII
BD-321/BD-326
230 mm

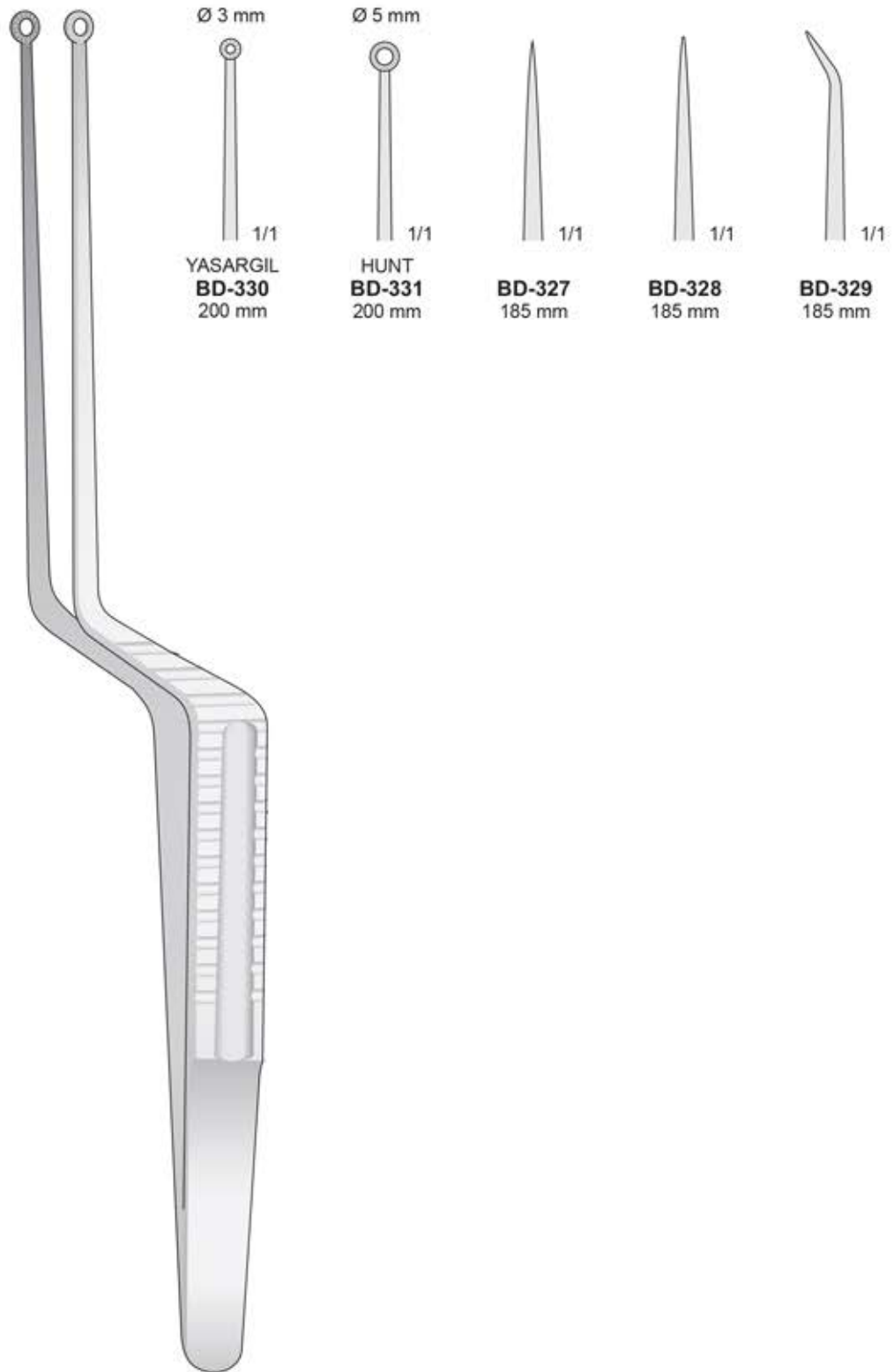

BD-327/BD-331

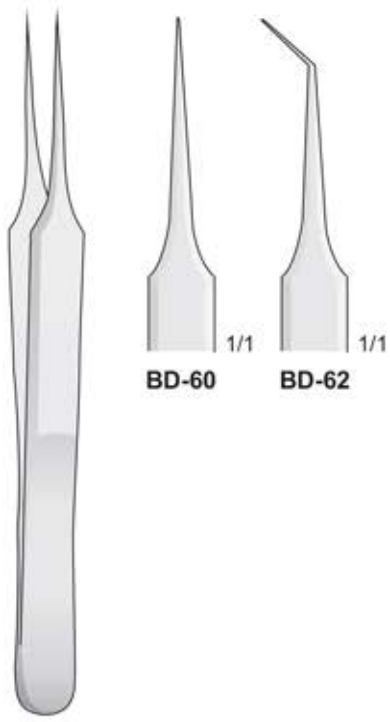

BD-60/BD-62
110 mm



BD-206
115 mm

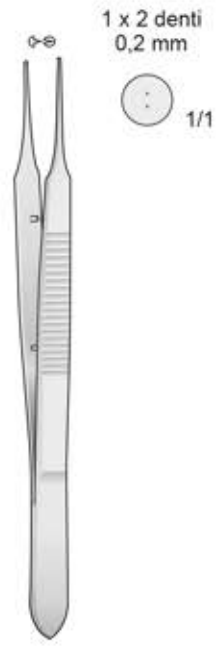

BD-238
95 mm

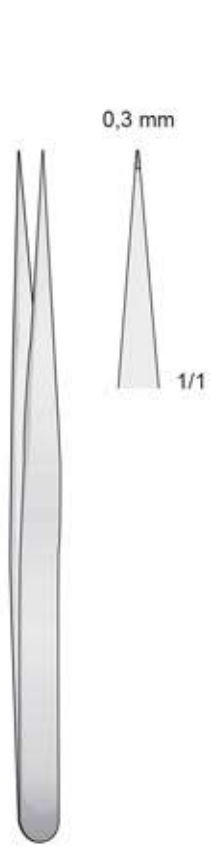

BD-235
120 mm

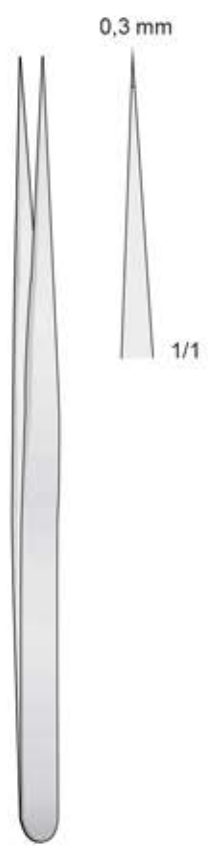

**VISE
BD-236**
135 mm

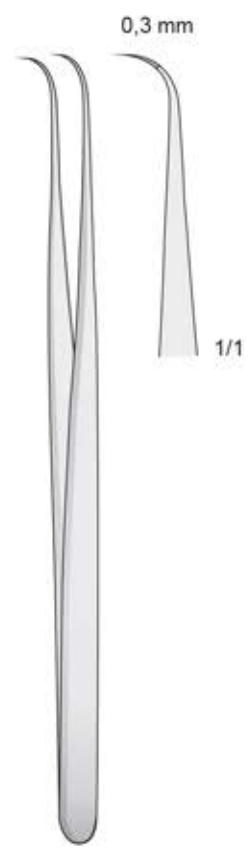

**VISE
BD-237**
135 mm

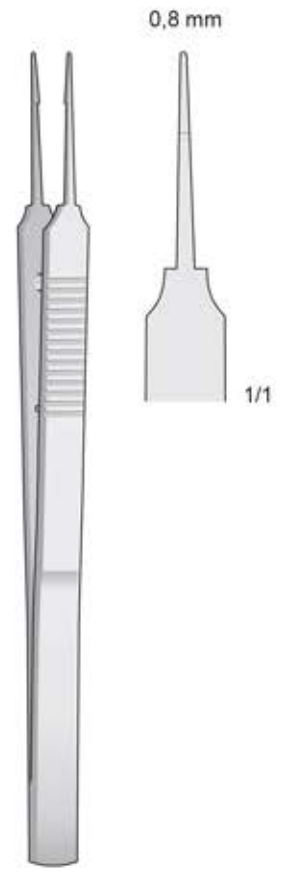

**AUSTIN
BD-239**
140 mm

Mikro Precision Pinzetten

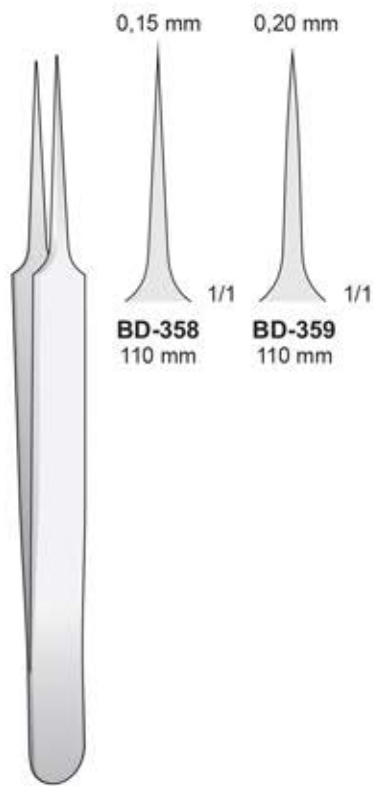

BD-358/BD-359
110 mm

Titan - Titanium - Titanio - Titane

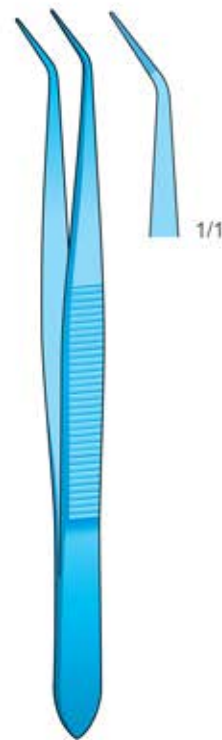

BD-341T
115 mm

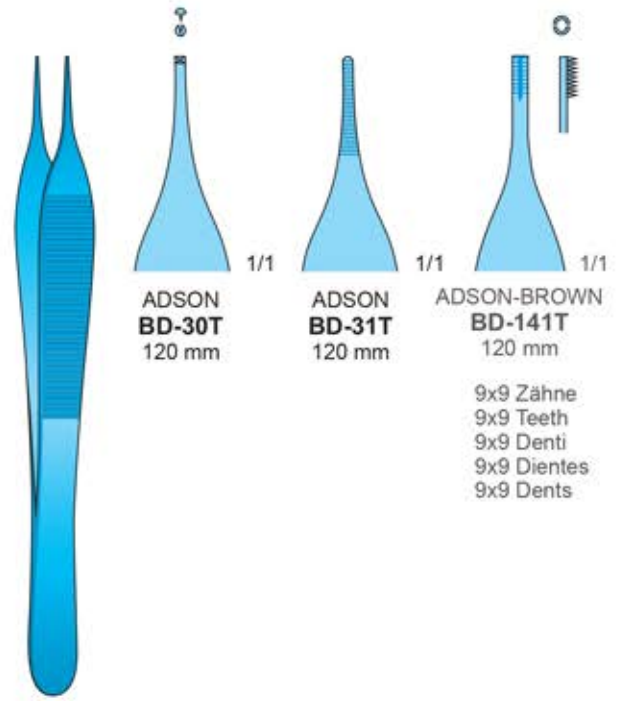

BD-30T/BD-141T
120 mm

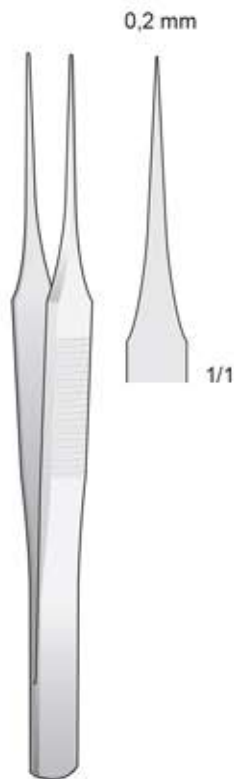

BD-360
110 mm

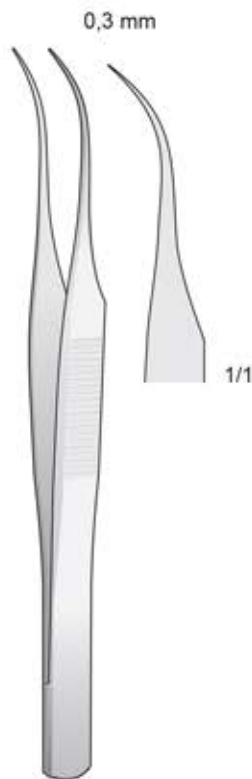

BD-361
110 mm

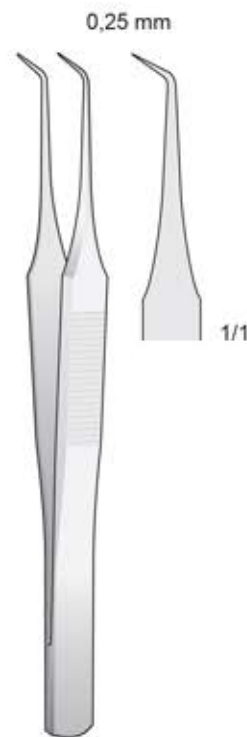

BD-362
100 mm

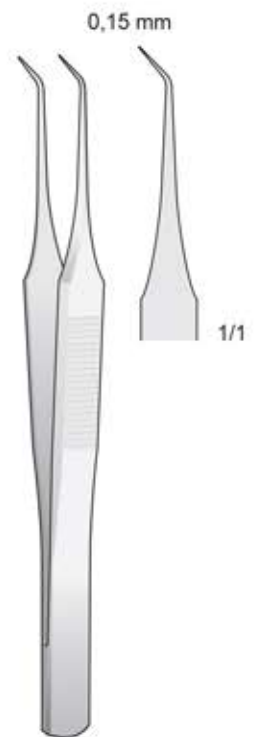

BD-363
100 mm

Titan - Titanium - Titanio - Titane

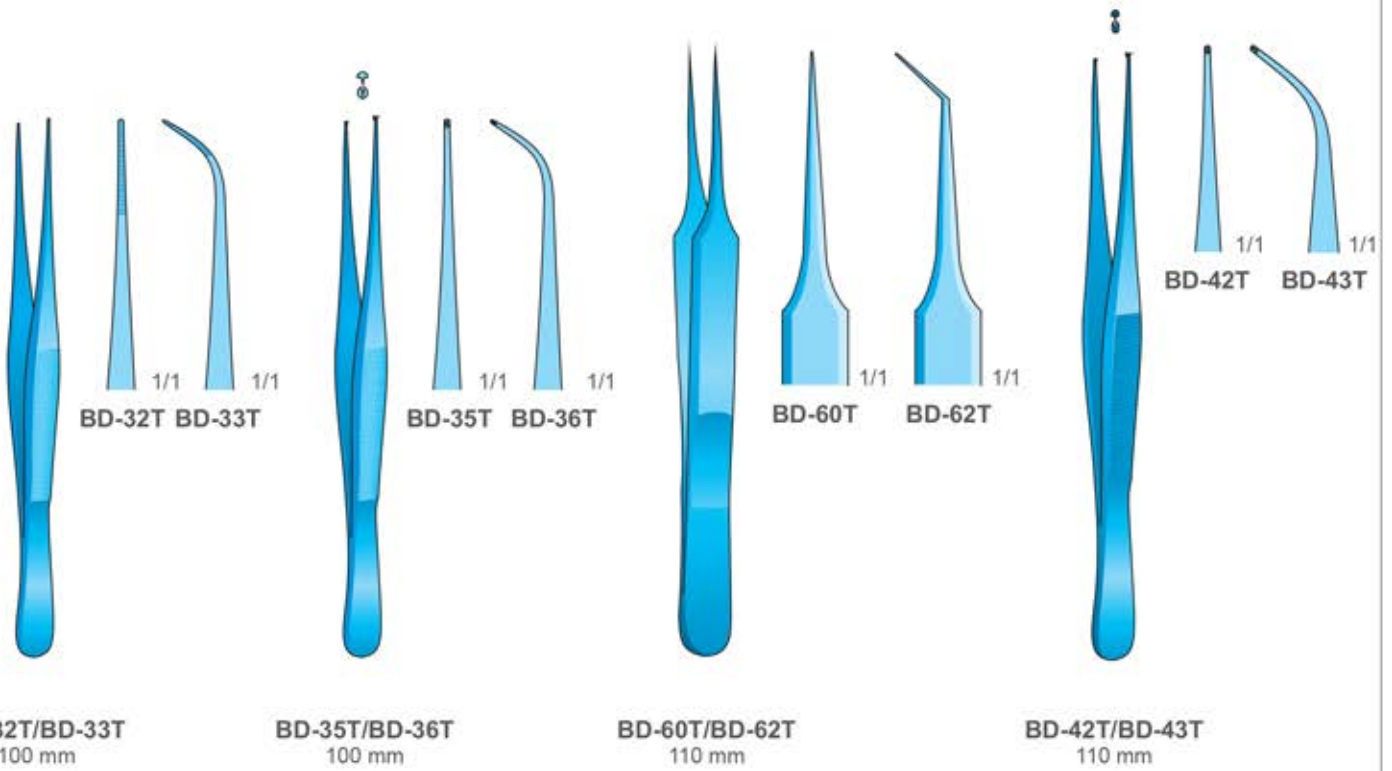

Mikro Precision Pinzetten

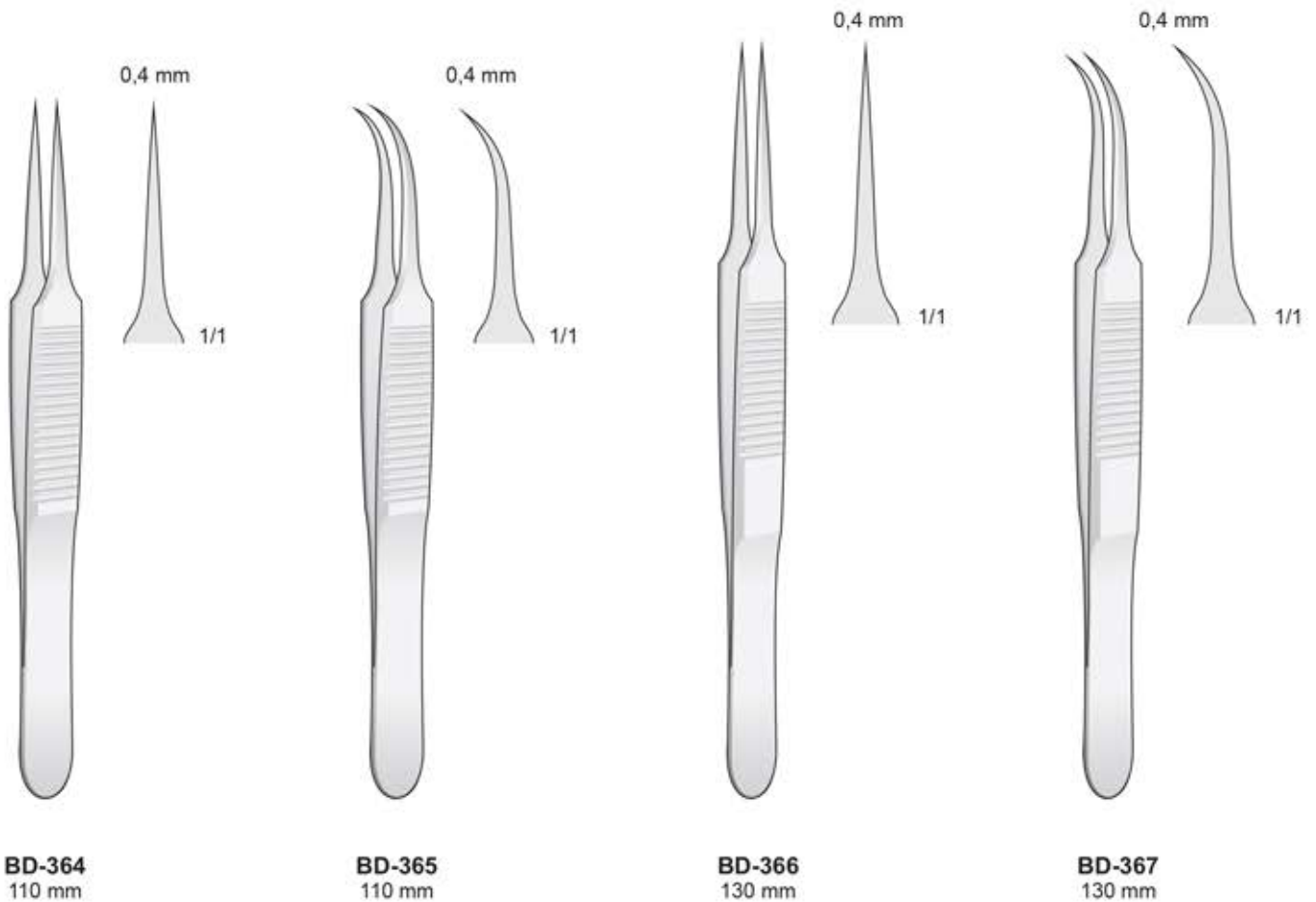

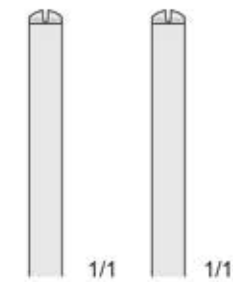

BB-46
135 mm

BB-48
155 mm

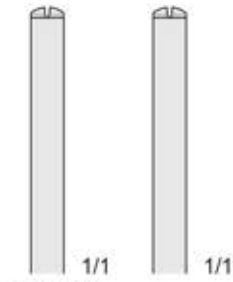

CASPAR
BB-50
180 mm

BB-52
200 mm

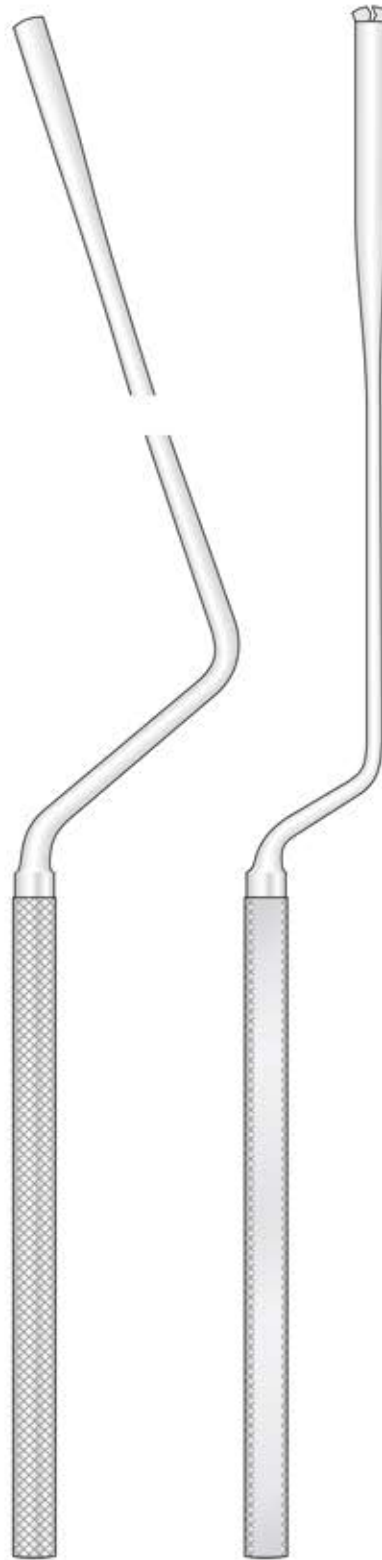

LANDOLT
BB-38
250 mm

LANDOLT
BB-40
210 mm

Packung mit 10 Stück - Package with 10 units
Confezione 10 pezzi - Paquete con 10 unidades
Boîte avec 10 lames

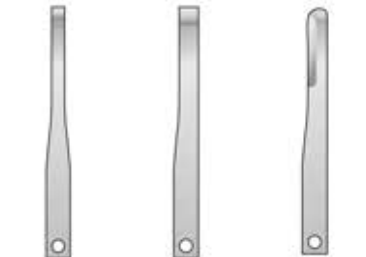

LB-361

LB-362

LB-364

Packung mit 10 Stück - Package with 10 units
Confezione 10 pezzi - Paquete con 10 unidades
Boîte avec 10 lames



LB-365

LB-367

LB-368

Packung mit 1 Stück - Package with 1 unit
Confezione 1 pezzo - Paquete con 1 unidade
Boîte avec 1 lame



LB-363

LB-366

LB-369

BB-46/BB-52



Packung mit 100 Stück - Package with 100 units
 Scatola da 100 pezzi - Paquete con 100 unidades
 Boîte avec 100 lames

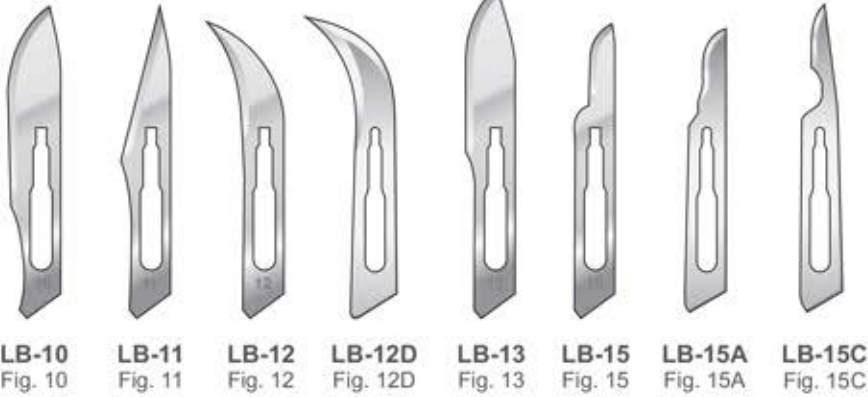

LB-10 Fig. 10 **LB-11** Fig. 11 **LB-12** Fig. 12 **LB-12D** Fig. 12D **LB-13** Fig. 13 **LB-15** Fig. 15 **LB-15A** Fig. 15A **LB-15C** Fig. 15C

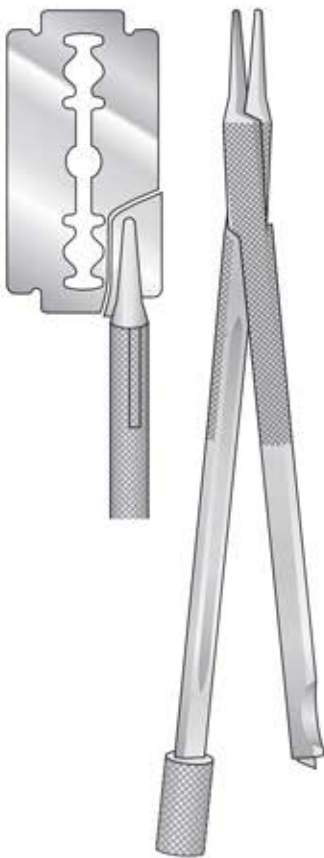
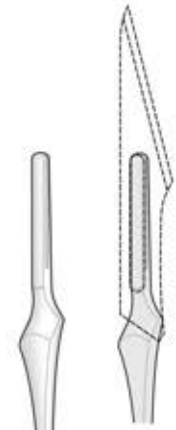

NK-12
120 mm



LB-40
 Packung 10 Klengen
 Package 10 blades
 Scatola da 10 lame
 Cajita de 10 hojas
 Boîte de 10 lames



MA-B3
Fig. 3



MA-B7
Fig. 7



MA-B15
210 mm

Dura Dissektoren
 Dura Dissectors
 Dissettori per Dura-Madre
 Disecadores para Dura-Madre
 Dissecteurs à Dure-Mère

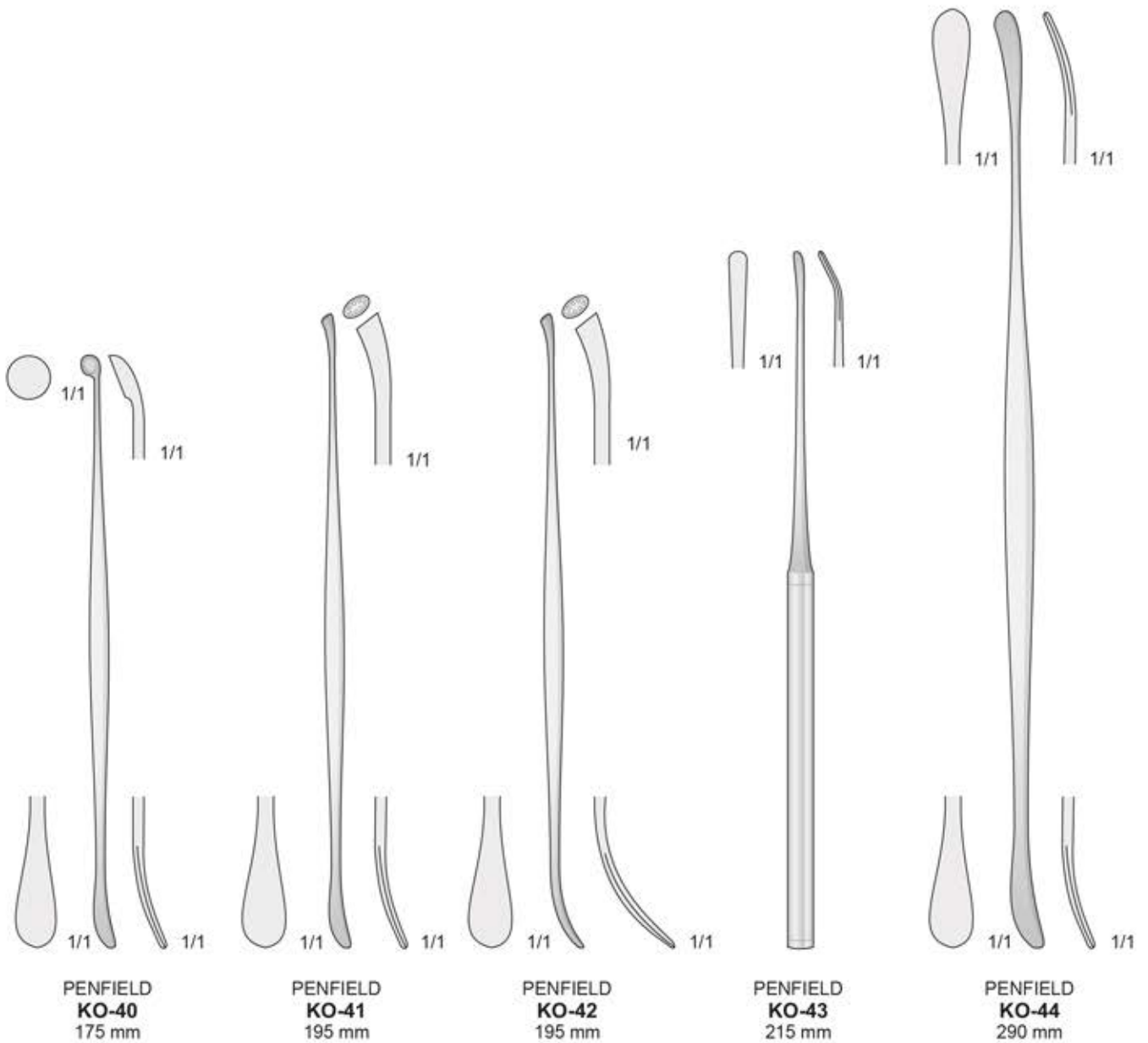



DAVIS
KO-21
245 mm

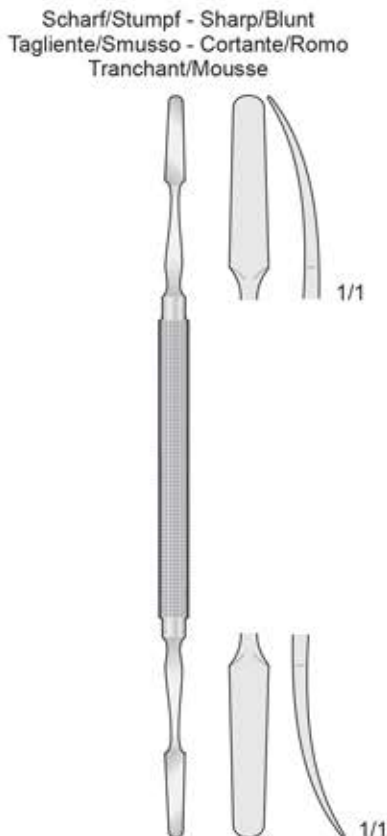

KILIAN
KO-11
180 mm

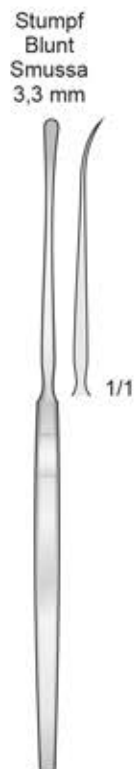

HALLE
KO-72
180 mm

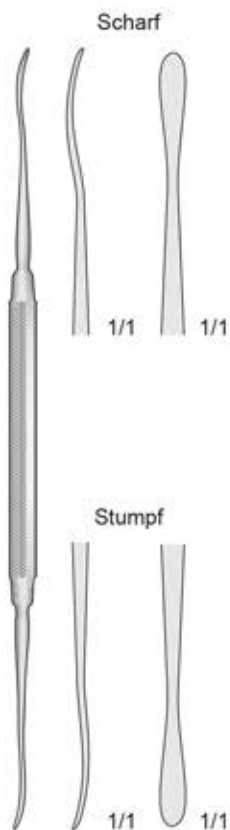

FREER
FR-16
185 mm

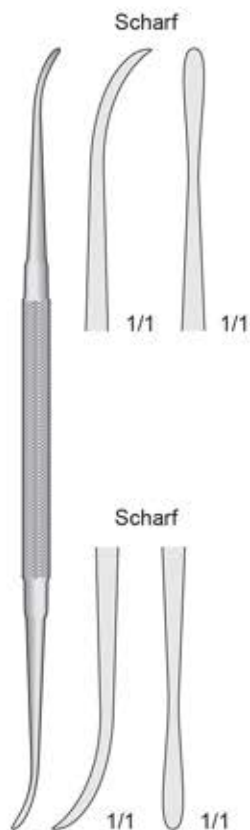

FREER-YASARGIL
FR-17
185 mm



FREER
FR-64
190 mm



FREER
FR-65
190 mm



FREER
FREER
180 mm

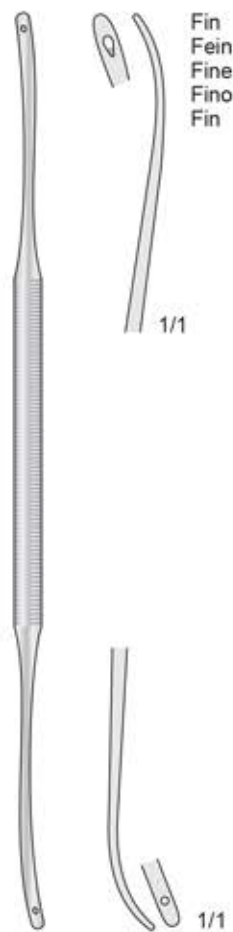

KO-14 - 180 mm
KO-15 - 240 mm

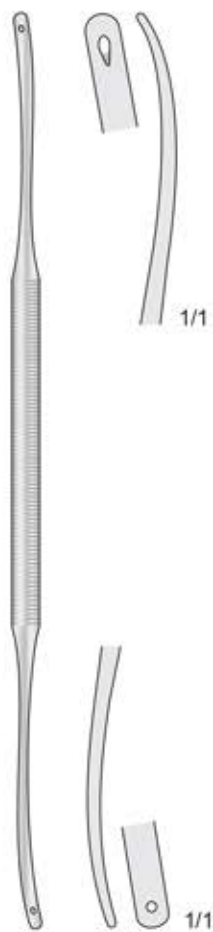

KO-16 - 180 mm
KO-17 - 240 mm



OLIVECRONA
KO-47 - 180mm
KO-48 - 240mm



OLIVECRONA
KO-49 - 195mm
KO-50 - 240mm

Hauthäkchen
Cutaneous hook
Uncini cutanei
Ganchos cutáneos
Erignes cutanées



**COTTLE
BT-196**
160 mm



**FREER
BT-200**
150 mm



**GILLIES
BT-15**
180 mm



**GILLIES
BT-16**
180 mm

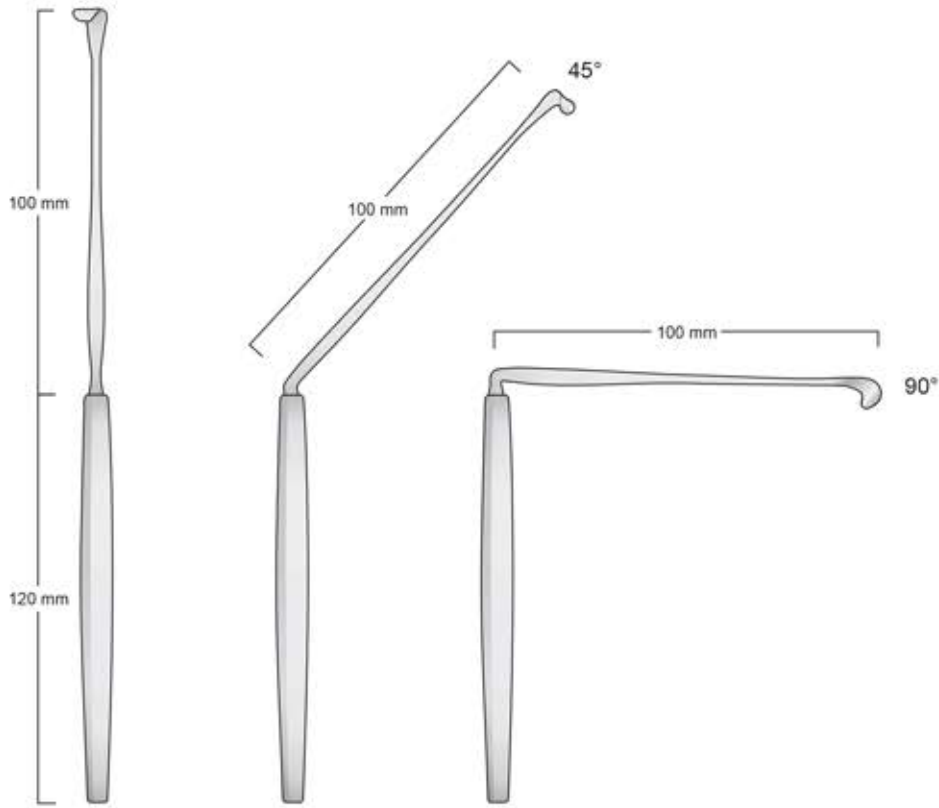

LOVE
DO-56
220 mm

LOVE
DO-57
205 mm

LOVE
DO-58
120 mm

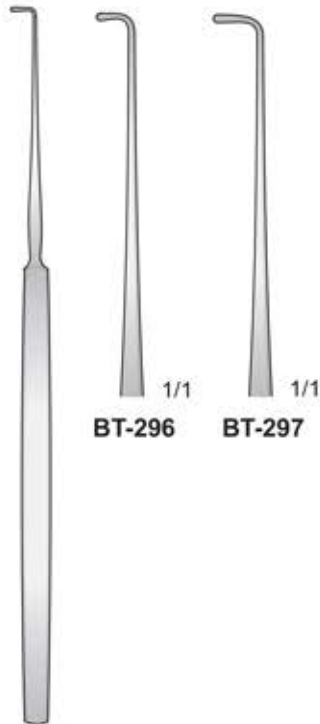

BT-296 1/1
BT-297 1/1

CUSHING
BT-296/BT-297
190 mm

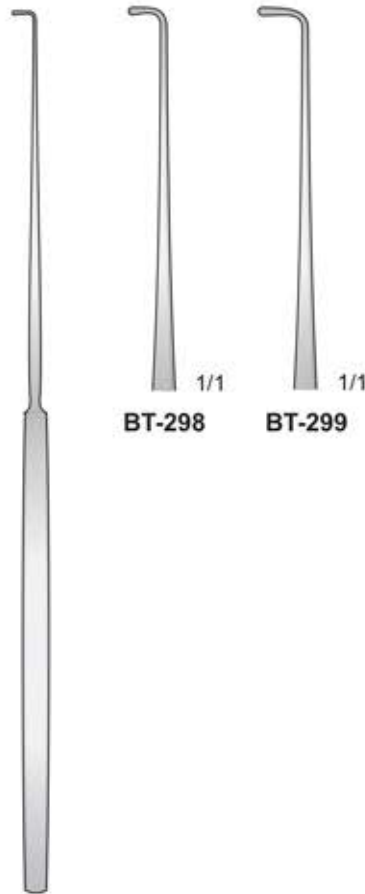

BT-298 1/1
BT-299 1/1

CUSHING
BT-298/BT-299
280 mm



LOVE
DO-174
210 mm



CASPAR
BT-300/BT-303
245 mm



KRAYENBÜHL
BT-304/BT-311
185 mm

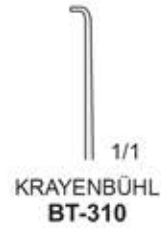
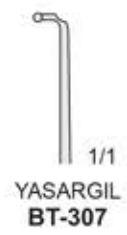



YASARGIL
FD-331/FD-336



YASARGIL
FD-331
185 mm

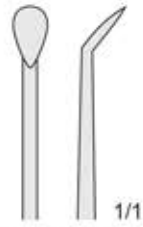

YASARGIL
FD-332
185 mm

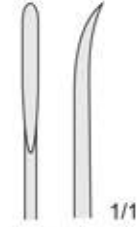

YASARGIL
FD-333
185 mm

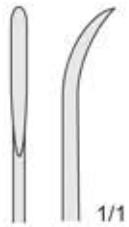

YASARGIL
FD-334
185 mm



FD-335
230 mm



FD-336
230 mm

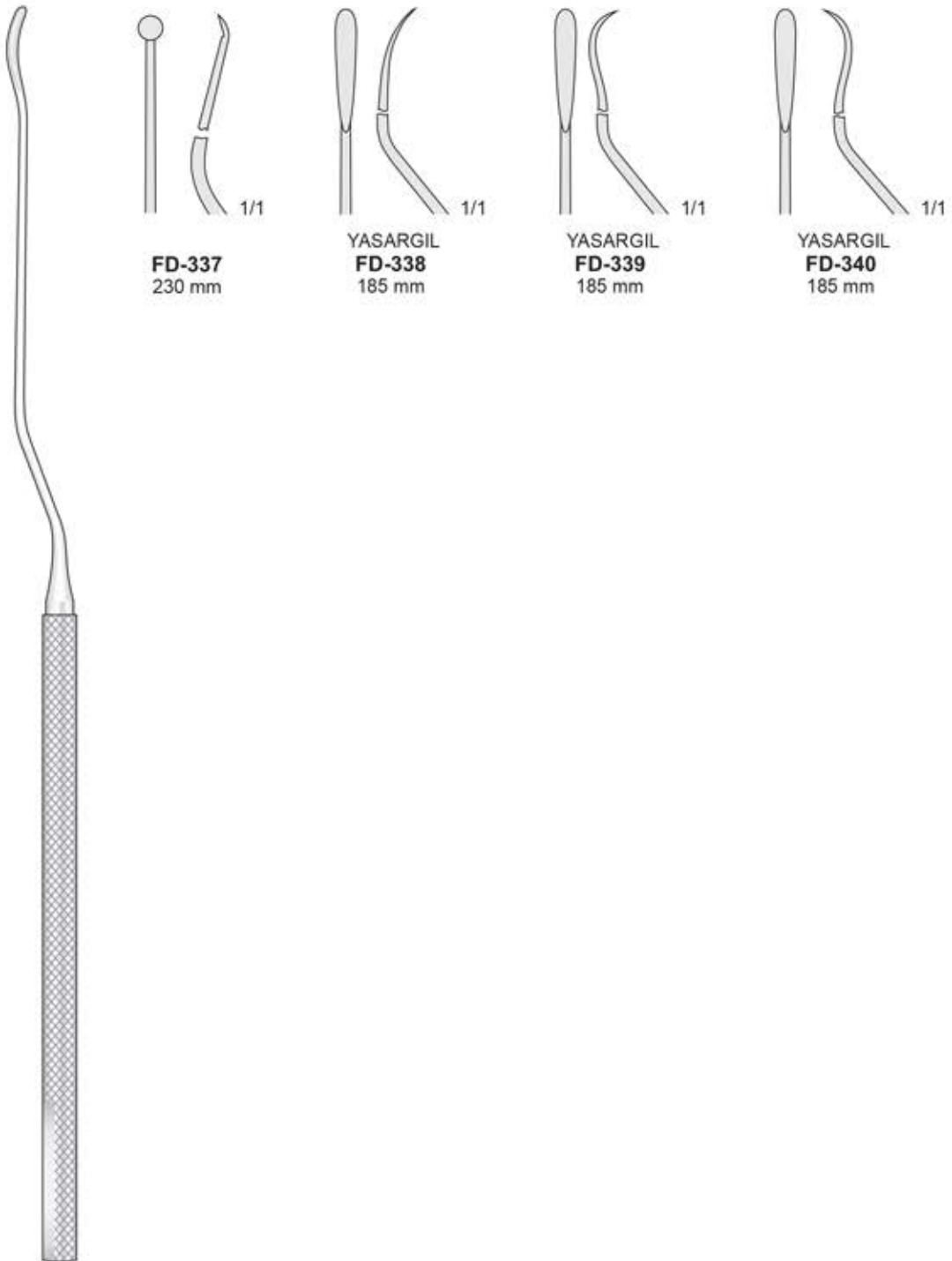

YASARGIL
FD-337/FD-340



YASARGIL
FD-341/FD-343

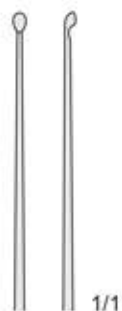

FD-341
230 mm

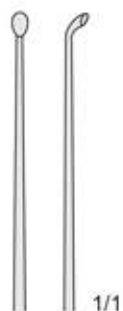

FD-342
230 mm

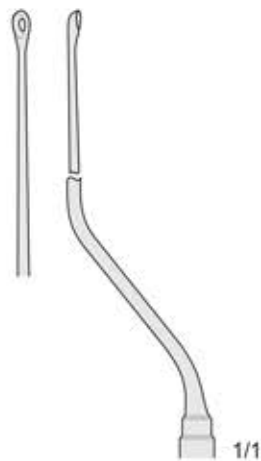

YASARGIL
FD-343
185 mm

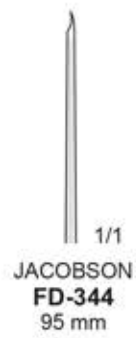

Griff für auswechselbare
Gefäßmesser und Haken
Handle for interchangeable
Vessel Knives and Hooks
Manico intercambiabile
per uncini e coltelli

MA-8
125 mm



FD-347/FD-351



FD-347
230 mm



FD-348
230 mm



90°

FD-349
185 mm

Scharfen Häkchen
Sharp Hook
Uncino acuto



90°

FISCH
FD-350
185 mm

Scharfen Häkchen
Sharp Hook
Uncino acuto



1/1

JACOBSON
FD-351
185 mm

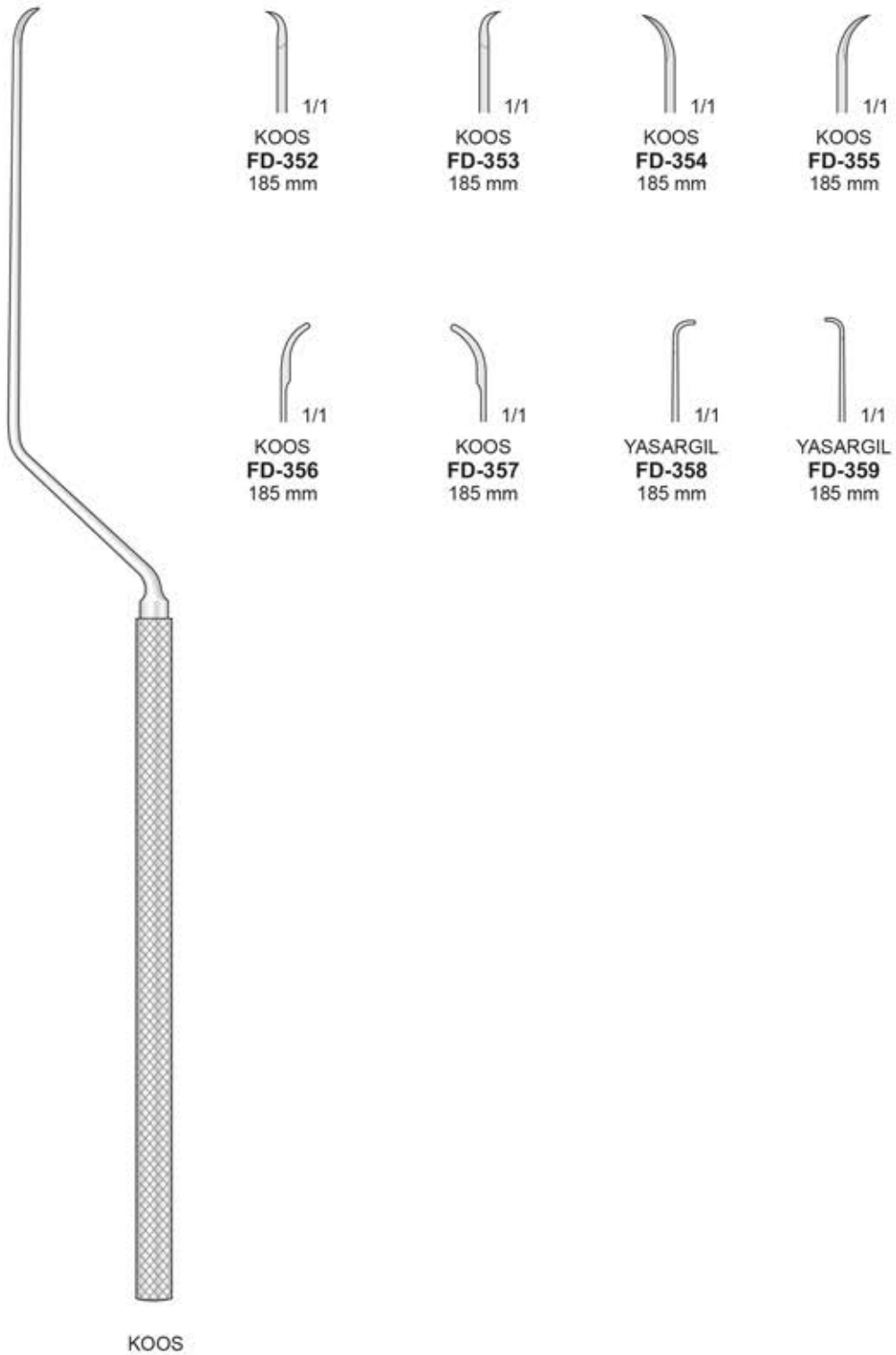

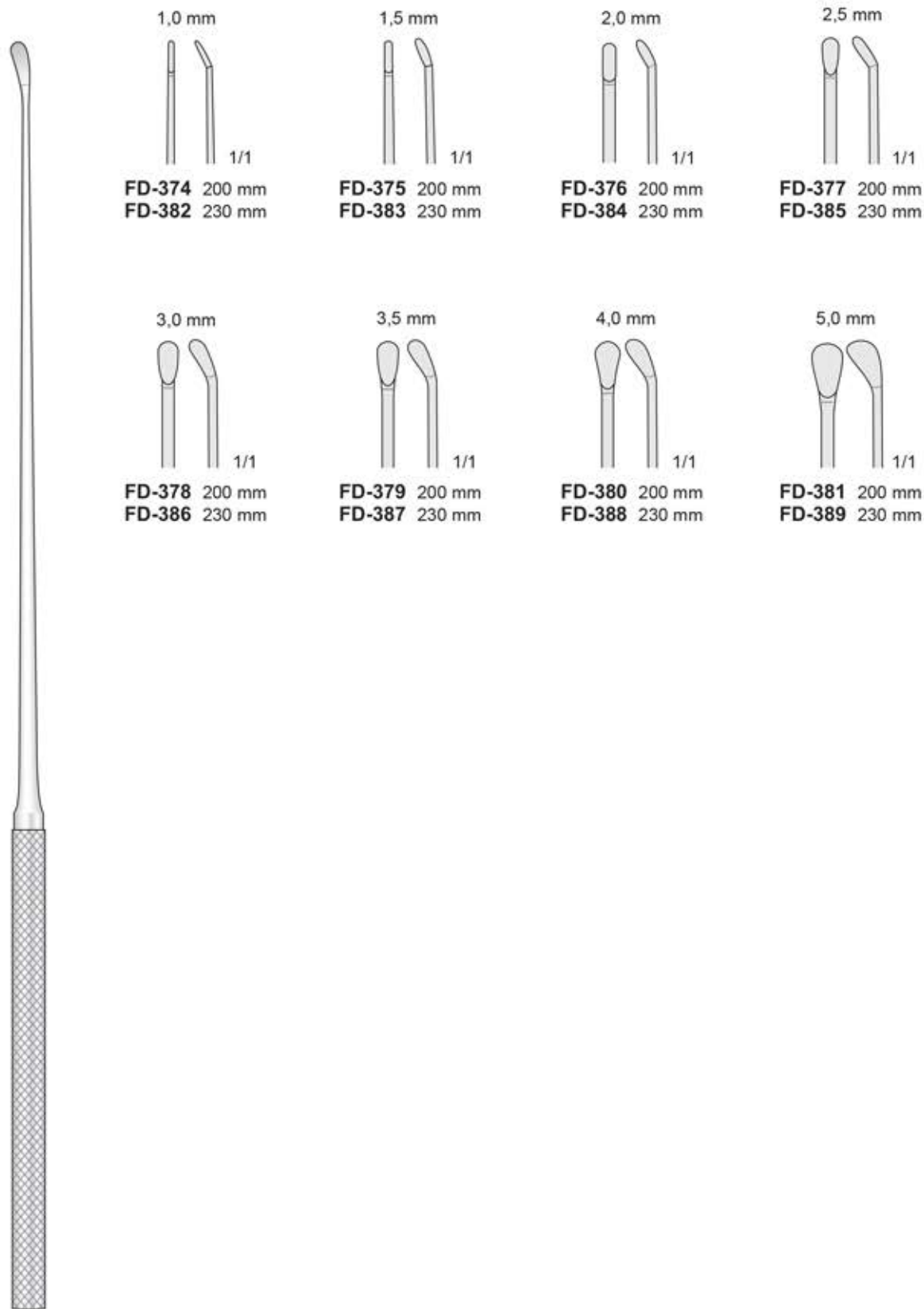

1,0 mm
 FD-374 200 mm
 FD-382 230 mm

1,5 mm
 FD-375 200 mm
 FD-383 230 mm

2,0 mm
 FD-376 200 mm
 FD-384 230 mm

2,5 mm
 FD-377 200 mm
 FD-385 230 mm

3,0 mm
 FD-378 200 mm
 FD-386 230 mm

3,5 mm
 FD-379 200 mm
 FD-387 230 mm

4,0 mm
 FD-380 200 mm
 FD-388 230 mm

5,0 mm
 FD-381 200 mm
 FD-389 230 mm

SAMII
 FD-374/FD-389

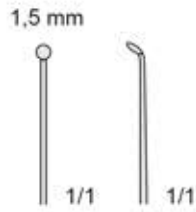

FD-390 200 mm
FD-394 230 mm

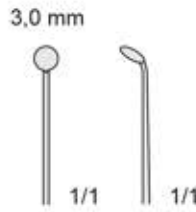

FD-391 200 mm
FD-395 230 mm

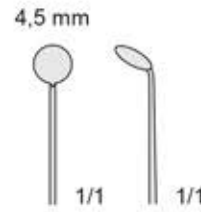

FD-392 200 mm
FD-396 230 mm

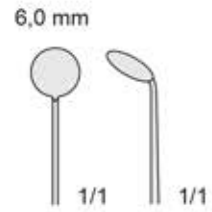

FD-393 200 mm
FD-397 230 mm

Lanzettenmesser
Lancet Knives



FD-398
230 mm



FD-399
230 mm

SAMII
FD-390/FD-399



FF-301/FD-308

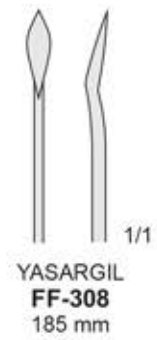
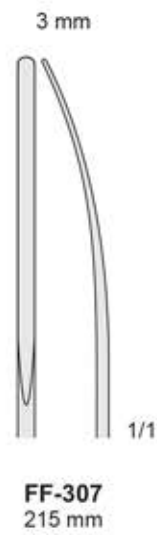
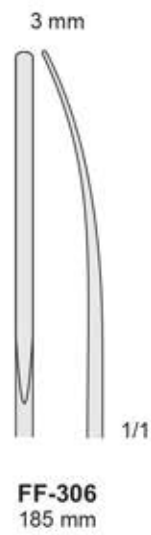
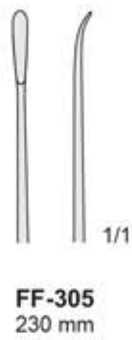
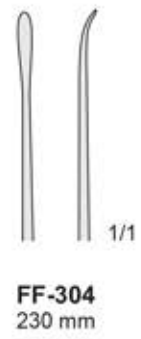
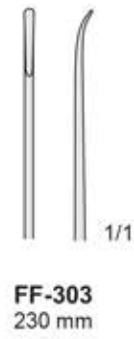
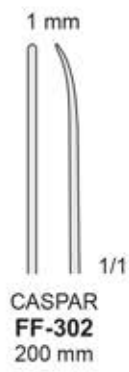
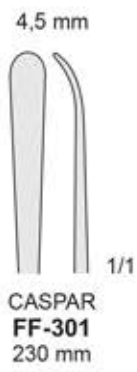

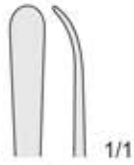

4,5 mm

CASPAR
FF-309
230 mm

2 mm

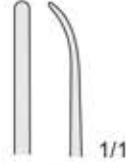
CASPAR
FF-310
230 mm

1 mm

CASPAR
FF-311
210 mm

1 mm

CASPAR
FF-312
210 mmFF-313
230 mmFF-314
230 mm

FF-309/FF-314



CASPAR
FF-315/FF-316



1/1

CASPAR
FF-316
230 mm



1/1

JACOBSON
FF-315
185 mm



FD-366
185 mm

Ø 1,8 mm



1/1



1/1

Schutzhülse zur Lagerung
und Sterilisation
Protector for Storing
and Sterilisation



3 mm



FF-317

4 mm



FF-318

5 mm



FF-319

8 mm



FF-320

OKONEK-YASARGIL
FF-317/FF-320
230 mm

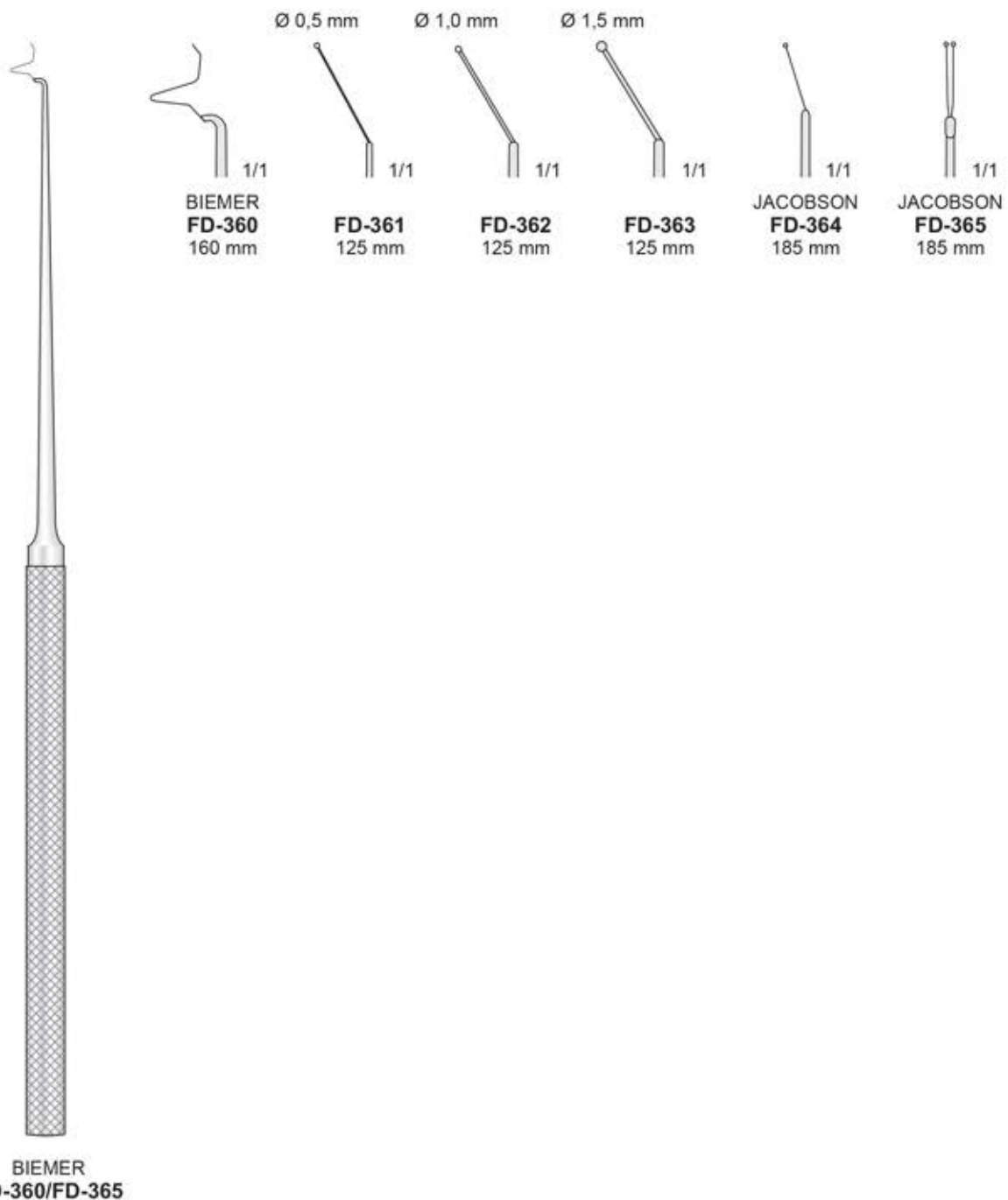

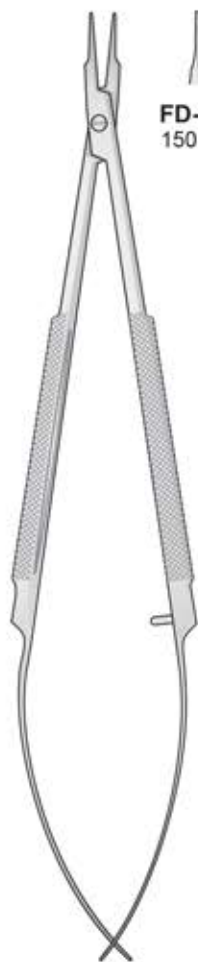

 1/1
FD-121
150 mm

 1/1
FD-122
150 mm

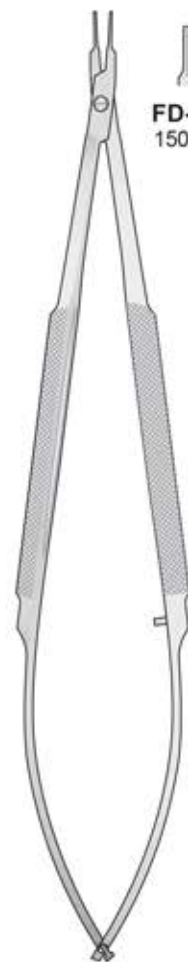

 1/1
FD-165
150 mm

 1/1
FD-166
150 mm



 1/1
FD-169
135 mm

BARRAQUER
FD-121/FD-122
150 mm

BARRAQUER
FD-165/FD-166
150 mm

BARRAQUER
FD-169
135 mm

		Einzelklemmen Single Clamp Clip solo Clip suelto Clip simple	Einzelklemmen Single Clamp Clip solo Clip suelto Clip simple	Approximator Approximator Approssimatore Aproximador Aproximateur	Approximator Approximator Approssimatore Aproximador Aproximateur	Doppelklemmen Double Clamp Clip doppio Clip doble Clip double
8 mm						
Ø Gefäß / Vessel 0,4 - 1,0 mm	Vein - Vene Artery - Arterie	FE-21 FE-22	FE-27 FE-28	FE-37 FE-38	FE-43 FE-44	FE-49 FE-50
11 mm						
Ø Gefäß / Vessel 0,6 - 1,5 mm	Vein - Vene Artery - Arterie	FE-23 FE-24	FE-29 FE-30	FE-39 FE-40	FE-45 FE-46	FE-51 FE-52
17 mm						
Ø Gefäß / Vessel 1,0 - 2,25 mm	Vein - Vene Artery - Arterie	FE-25 FE-26	FE-31 FE-32	FE-41 FE-42	FE-47 FE-48	FE-53 FE-54
25 mm						
Ø Gefäß / Vessel 1,5 - 3,5 mm	Vein - Vene Artery - Arterie	FE-33 FE-34	FE-55 FE-56			
36 mm						
Ø Gefäß / Vessel 2,0 - 5,0 mm	Vein - Vene Artery - Arterie	FE-35 FE-36	FE-57 FE-58			

Klemmen-Anlegepinzette
Clamp Applying Forceps
Pinzetta per applicare clips
Pinzas para aplicar clips
Pincas pour poser les clips



FE-59 mit Schloß, with lock
FE-60 ohne Schloß, without lock
140 mm

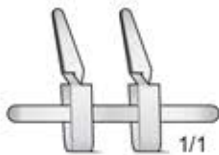

BIEMER-MÜLLER
FD-507/FD-511

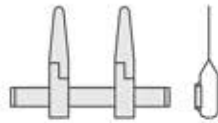

FD-507 5,0 mm 9,0 mm 25-30 gr.

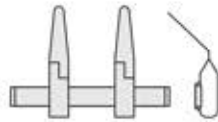

FD-508 5,0 mm 9,0 mm 25-30 gr.

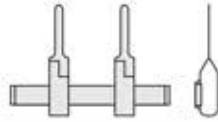

FD-509 5,0 mm 9,0 mm 25-30 gr.

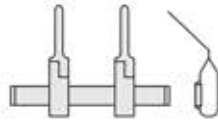

FD-510 5,0 mm 9,0 mm 25-30 gr.

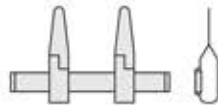

FD-511 3,5 mm 4,5 mm 25-30 gr.

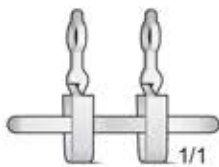

MÜLLER
FD-512/FD-515

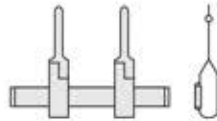

FD-512 Ø 1,0 mm 25-30 gr.

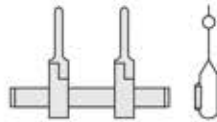

FD-513 Ø 2,0 mm 25-30 gr.

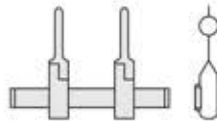

FD-514 Ø 3,0 mm 25-30 gr.

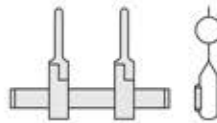

FD-515 Ø 4,0 mm 25-30 gr.

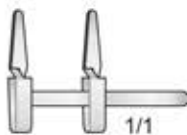

BIEMER
FD-517



FD-518

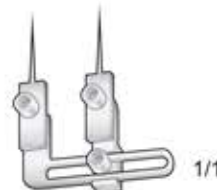

BIEMER
FD-519

FD-516

Approximator mit Anlegepinzette
Approximator with Applying forceps

FD-517

Approximator allein
Approximator only

FD-518

Approximator mit Schlüssel
Approximator with key

FD-519

Approximator mit Schlüssel
Approximator with key

FD-520

1 Paar Ersatznadeln
1 Pair of spare needles



BIEMER
FD-500/FD-502



FD-500 4,0 mm 6,0 mm 30-40 gr.



FD-501 5,0 mm 9,0 mm 30-40 gr.



FD-502 5,0 mm 9,0 mm 20-25 gr.



MEHDORN
FD-503/FD-506



FD-503 4 x 1,0 mm 10-15 gr.

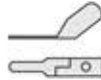

FD-504 4 x 1,4 mm 15-20 gr.



FD-505 6 x 1,0 mm 10-15 gr.



FD-506 6 x 1,4 mm 15-20 gr.



1/1

FB-84
35 mm



1/1

FB-85
35 mm



1/1

FB-86
45 mm

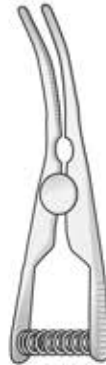

1/1

FB-87
45 mm

*These products are not available for sale or distribution in the USA.
For further information on product availability, please contact your local representative.*

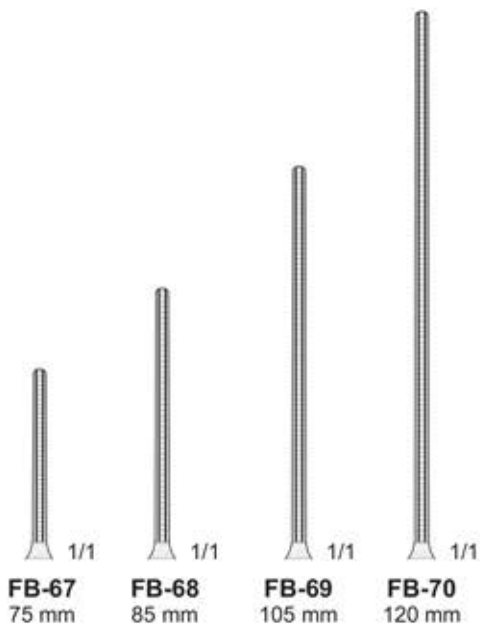

FB-67/FB-70

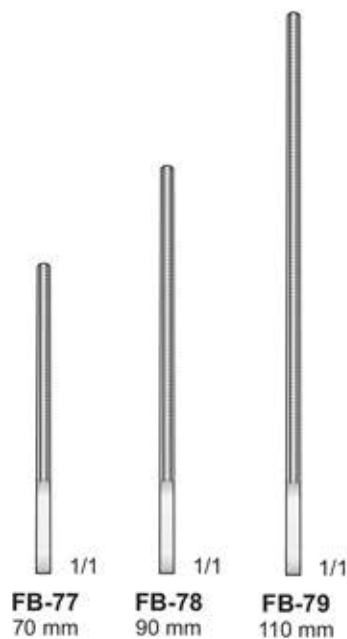

**GLOVER
FB-76/FB-79**

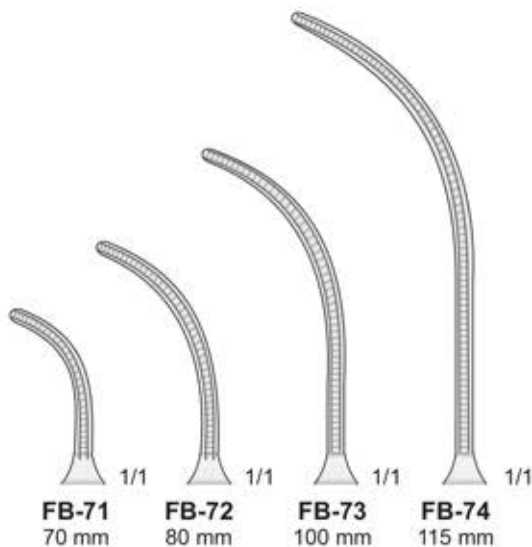

FB-71/FB-74

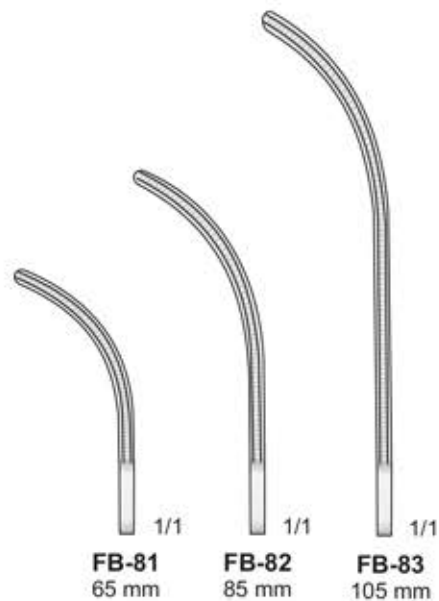

**GLOVER
FB-80/FB-83**

Titan - Titanium - Titanio - Titane

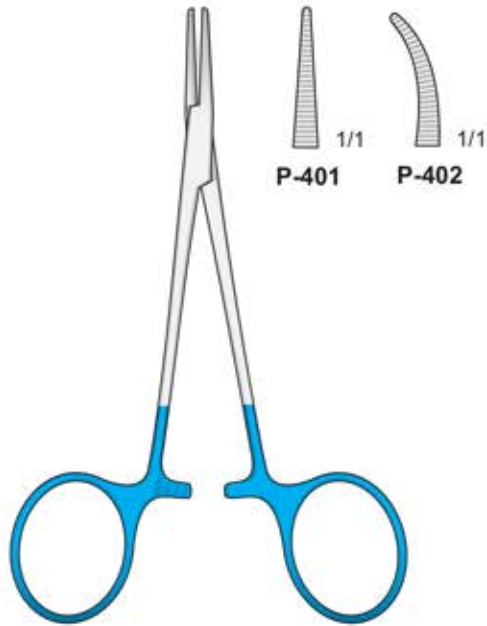
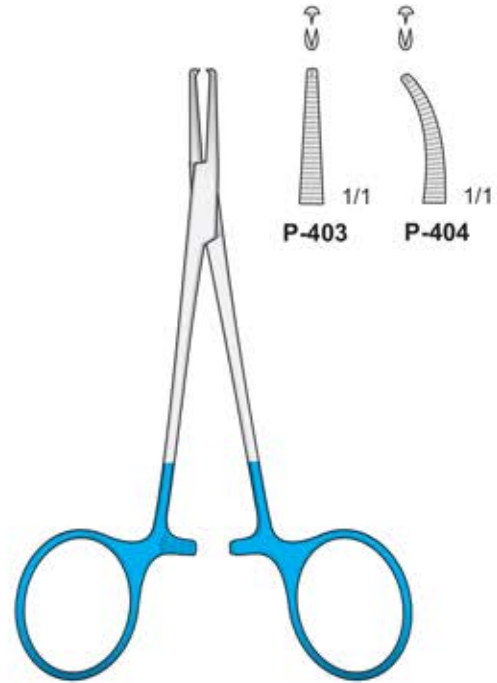
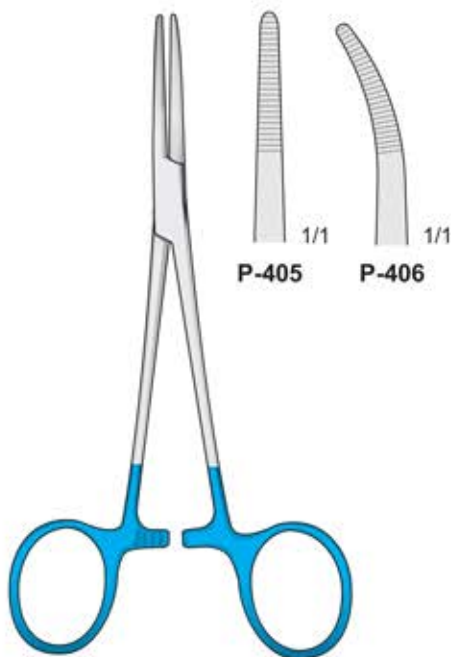
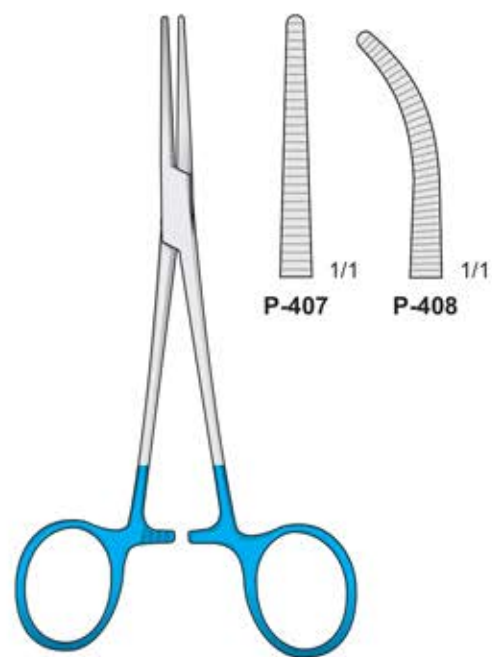
HALSTED-MOSQUITO
P-401/P-402
120 mmHALSTED-MOSQUITO
P-403/P-404
120 mmKELLY
P-405/P-406
140 mmCRILE
P-407/P-408
140 mm

LEYLA Retractor System

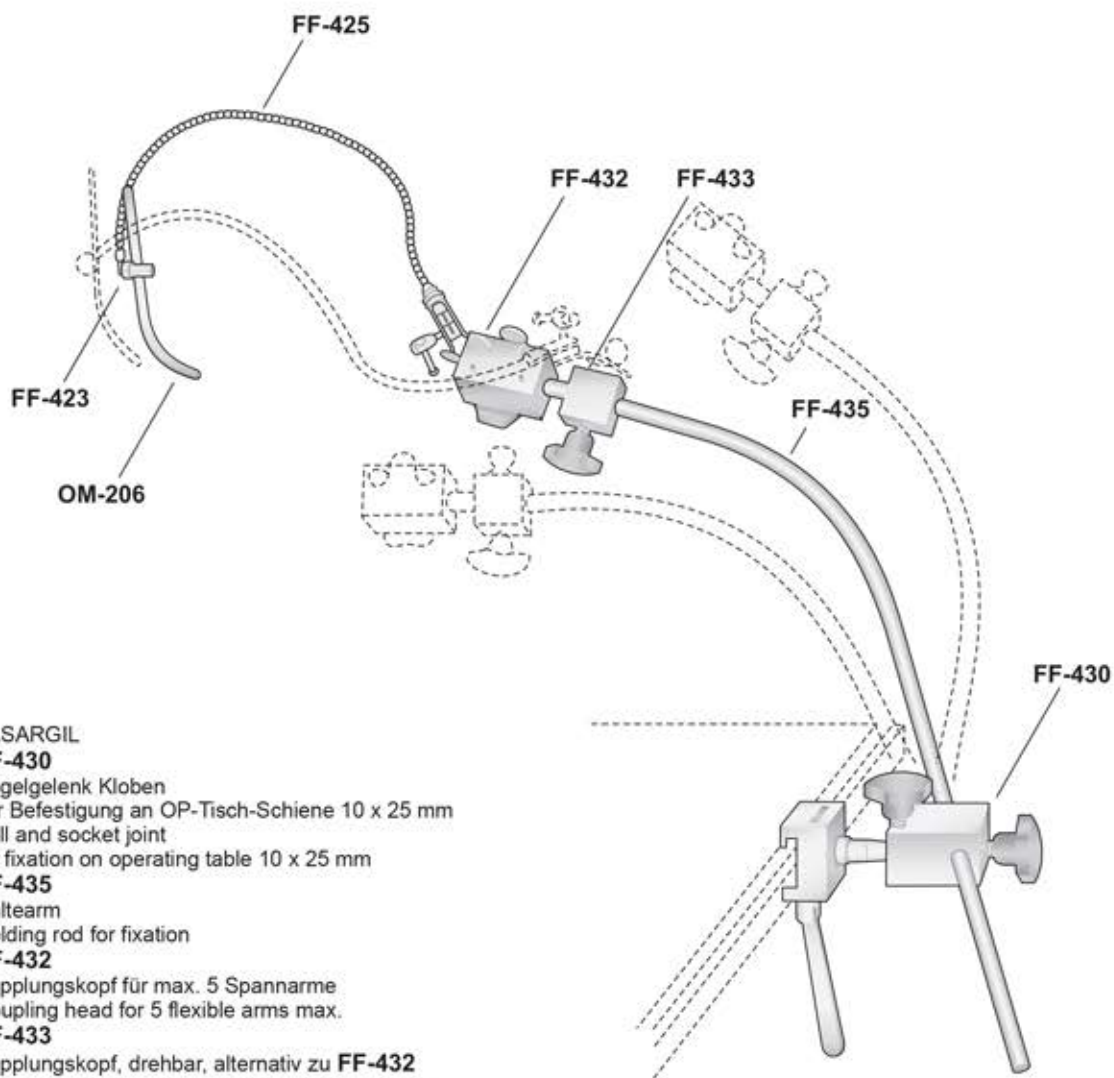

YASARGIL

FF-430

Kugelgelenk Kloben
zur Befestigung an OP-Tisch-Schiene 10 x 25 mm
Ball and socket joint
for fixation on operating table 10 x 25 mm

FF-435

Haltearm
Holding rod for fixation

FF-432

Kupplungskopf für max. 5 Spannarme
Coupling head for 5 flexible arms max.

FF-433

Kupplungskopf, drehbar, alternativ zu **FF-432**
Coupling head, turnable, alternative to **FF-432**

FF-434

Kupplungskopf, seitlich offen, alternativ zu **FF-432**
Coupling head, laterally open, alternative to **FF-432**

FF-425

Flexibler Spannarm
Flexible arm

FF-423

Halter für flache Hirnspatel
Holder for flat brain spatula

OM-206

Hirnspatel
Brain spatula

LEYLA Retractor System

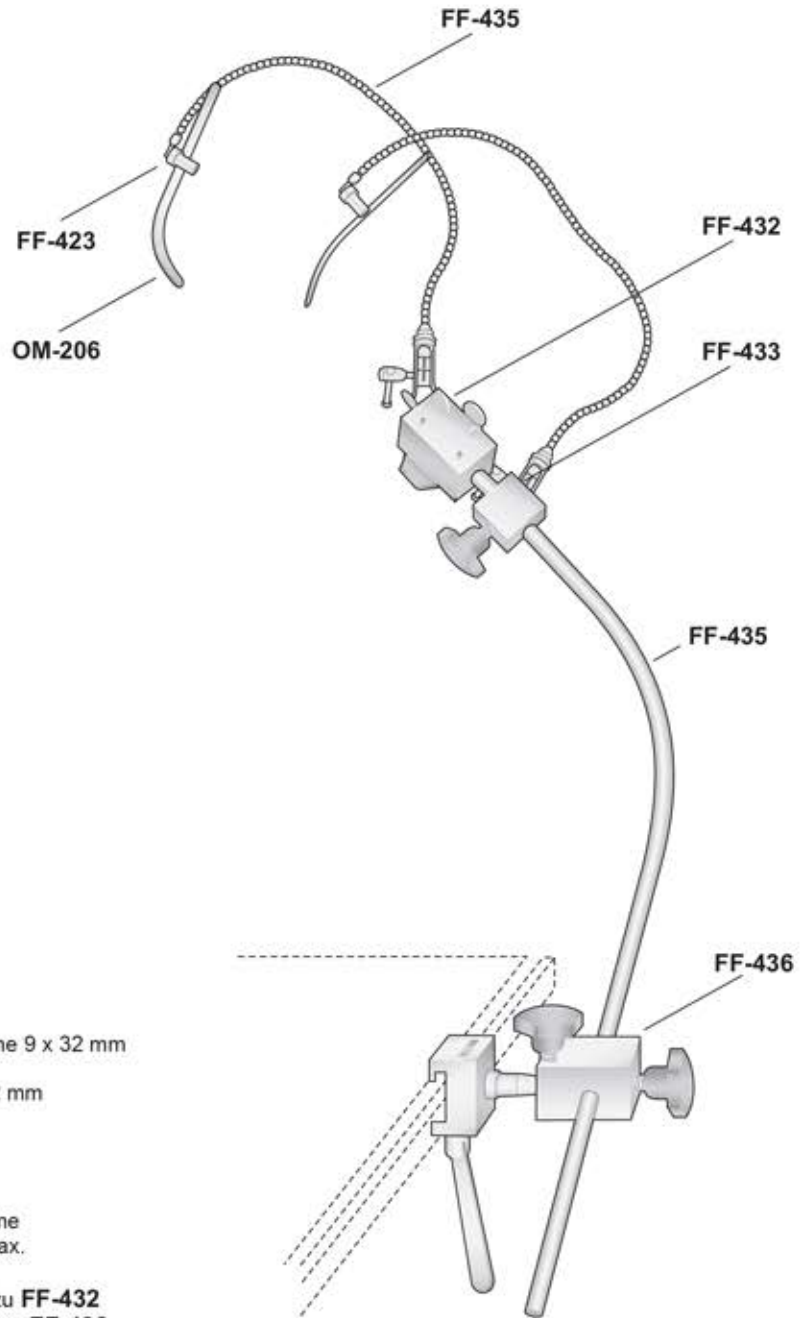

YASARGIL

FF-436

Kugelgelenk Kloben
zur Befestigung an OP-Tisch-Schiene 9 x 32 mm
Ball and socket joint
for fixation on operating table 9 x 32 mm

FF-435

Haltearm
Holding rod for fixation

FF-432

Kupplungskopf für max. 5 Spannarme
Coupling head for 5 flexible arms max.

FF-433

Kupplungskopf, drehbar, alternativ zu **FF-432**
Coupling head, turnable, alternative to **FF-432**

FF-434

Kupplungskopf, seitlich offen, alternativ zu **FF-432**
Coupling head, laterally open, alternative to **FF-432**

FF-425

Flexibler Spannarm
Flexible arm

FF-423

Halter für flache Hirnspatel
Holder for flat brain spatula

OM-206

Hirnspatel
Brain spatula

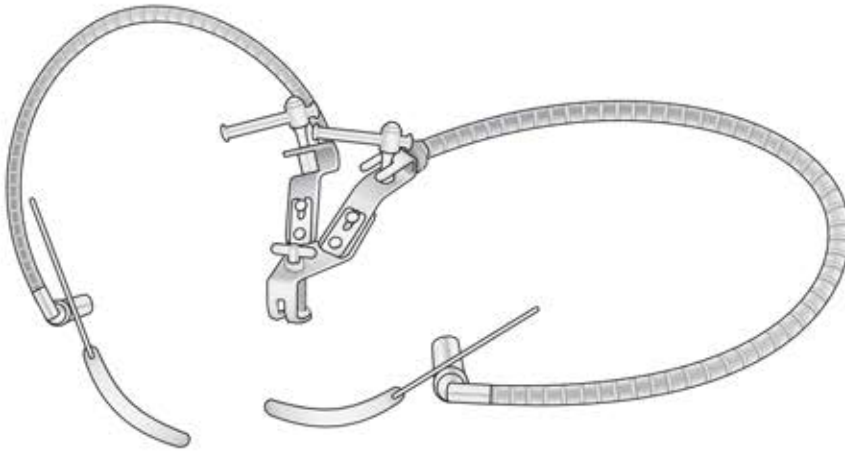

FF-420

Hirnspatelhalter, flexibel, für flache Spatel, mit 1 Spannarm, komplett, bestehend aus: Brain retractor, k flexible, for flat spatula, with 1 flexible arm, complete, consisting of:

FF-427

Fixiervorrichtung für 1 Spannarm
Fixation base for 1 flexible arm

FF-425

Spannarm
Flexible arm only

FF-423

Spatelhalter für flache Spatel
Support for flat brain spatulas

YASARGIL

FF-422

Hirnspatelhalter, flexibel, für flache Spatel, mit 2 Spannarm, komplett, bestehend aus: Brain retractor, k flexible, for flat spatula, with 2 flexible arm, complete, consisting of:

FF-428

Fixiervorrichtung für 2 Spannarm
Fixation base for 2 flexible arm

FF-425

Spannarm (2x)
Flexible arm only (2x)

FF-423

Spatelhalter für flache Spatel (2x)
Support for flat brain spatulas (2x)

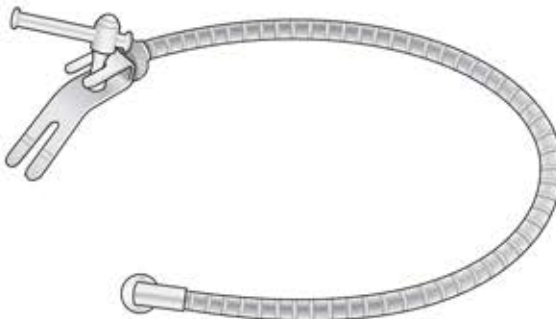

YASARGIL

FF-425

Flexibler Spannarm allein
Flexible arm only

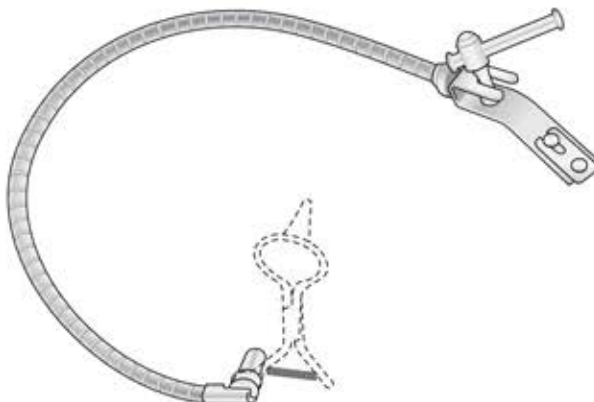

YASARGIL

FF-421

Ohrspekulahalter komplett, bestehend aus: Ear specula holder complete, consisting of:

FF-425

Spannarm allein
Flexible arm only

FF-426

Fixiervorrichtung zum befestigen an Rohrteilen bis Ø 16 mm
Clamp for fixation on bars up to 16 mm

FF-429

Ohrtrichterhalter allein
Ear specula holder only



FF-423



FF-428

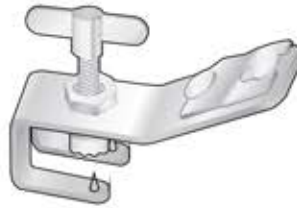

FF-427



FF-426



- OM-201 7 mm + 9 mm
- OM-202 11 mm + 13 mm
- OM-203 15 mm + 18 mm
- OM-204 18 mm + 22 mm

CUSHING
OM-201/OM-204
180 mm

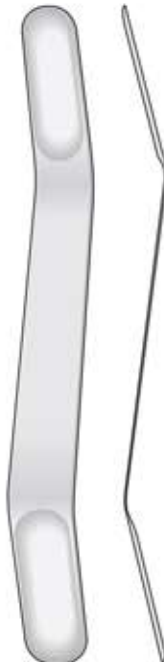

- OM-208 7 mm + 9 mm
- OM-209 11 mm + 13 mm
- OM-210 15 mm + 18 mm
- OM-211 18 mm + 22 mm

OLIVECRONA
OM-208/OM-211
180 mm

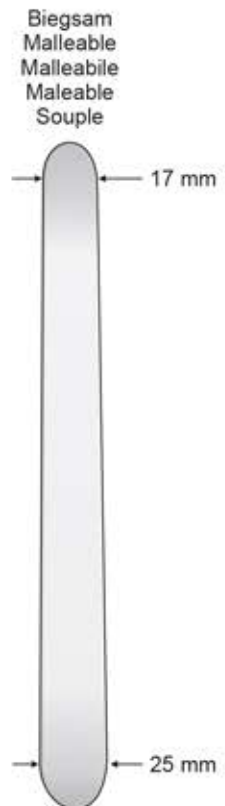

TUFFIER
OM-99
200 mm

OM-85

Komplettsset mit 3 Spatel
 Set complete with 3 spatulas
 Set completo con 3 spatole
 Set completos con 3 espátulas
 Set complete avec 3 spatules

OM-80 + OM-81 + OM-82

Biegsam - Malleable - Malleabili
 Maleables - Souples

18 mm



22 mm

OM-80
200 mm

14 mm



16 mm

OM-81
200 mm

5 mm



8 mm

OM-82
240 mm

Rostfrei - Stainless Steel - Acciaio - Acero - Acer
 Biegsam - Malleable - Malleabili - Maleables - Souples

18 mm



22 mm

OM-87
200 mm

14 mm



16 mm

OM-88
200 mm

Schwarz Verchromt
 Black anodized
 Cromato nero
 Cromado en negro
 Chromé noir

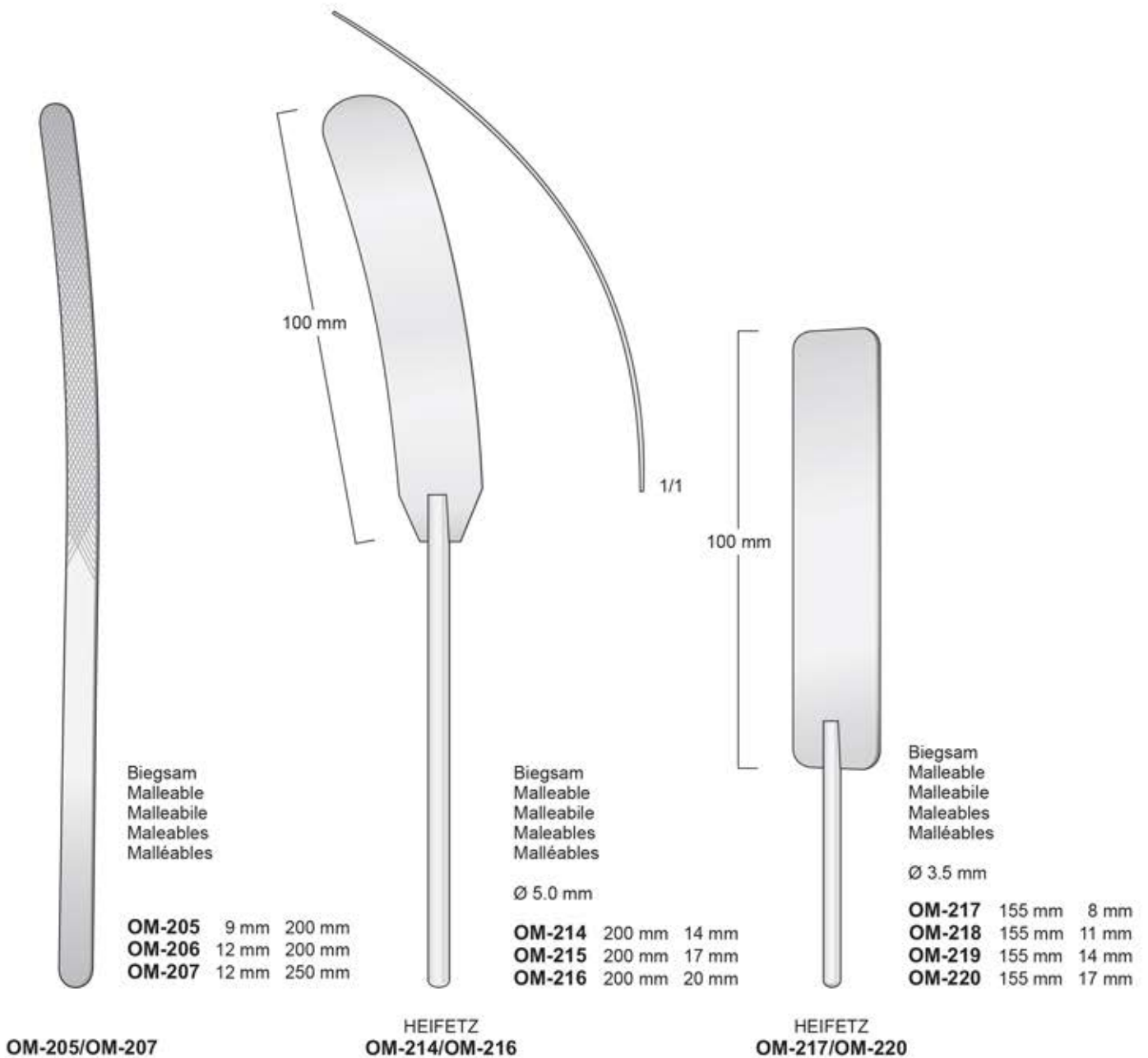

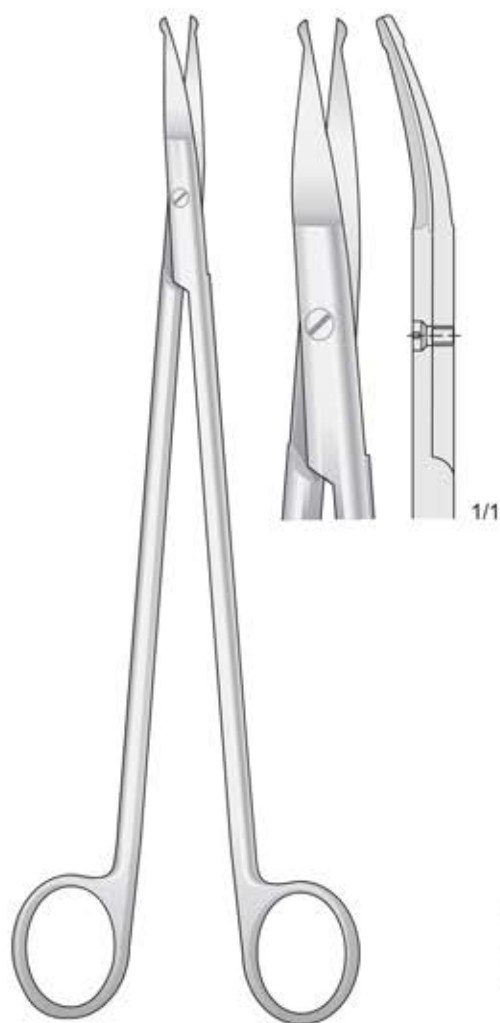

STRULLY
FG-107
220 mm

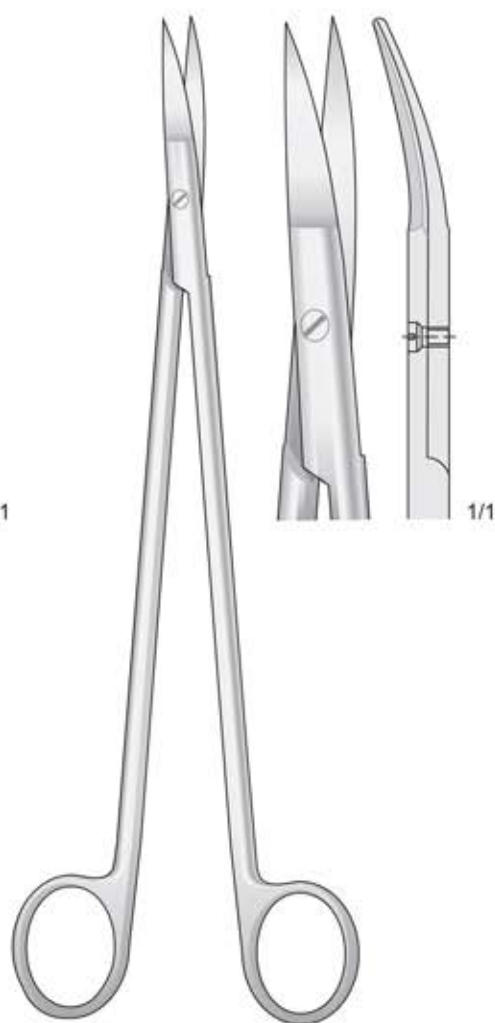

STRULLY
FG-106
220 mm

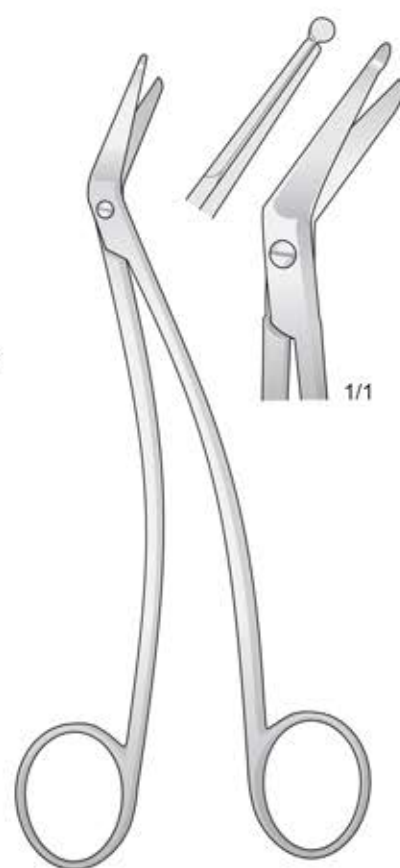

SCHMIEDEN-TAYLOR
FG-152
155 mm

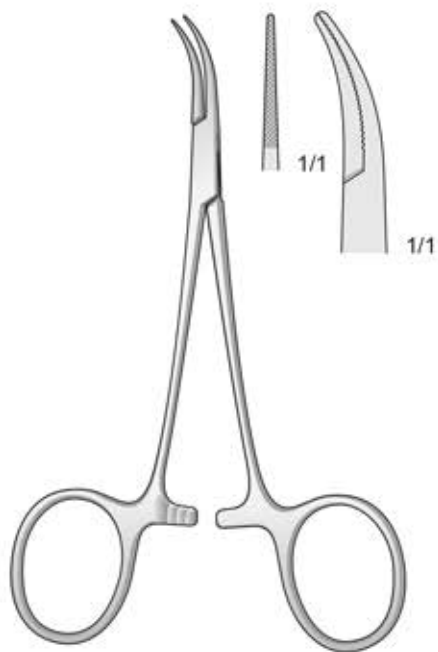

DANDY-MOSQUITO
P-332
120 mm

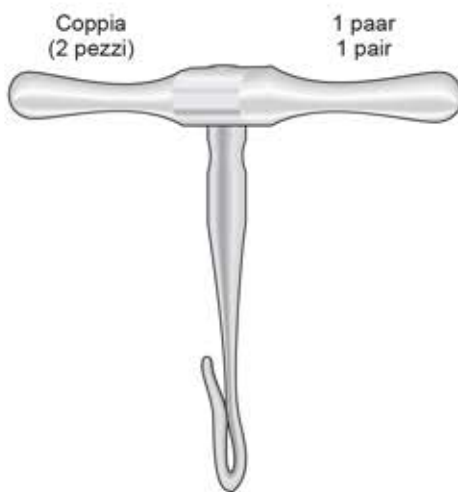

GIGLI
FK-11

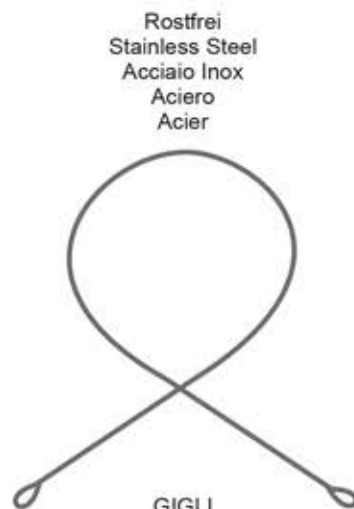

Rostfrei
Stainless Steel
Acciaio Inox
Acier
Acier

GIGLI
FK-13
300 mm
FK-14
500 mm

Seitwärts gebogen
Curved to side
Curve sul lato
Curvas laterales
Courbes latérales



DANDY
P-16/P-122
140 mm



Kopfhautklemme
Scalp Haemostatic forceps
Pinza emostatica per il cuoio capelluto
Pinza hemostáticas para pericraneo



DE MARTEL
FB-120
180 mm

FR-20

FR-21 FR-22 + FR-23 FR-24 FR-25 FR-26
 Komplet, mit Fräsern Fig. 1-4 und Verlängerungsstück
 Complete, with burrs no. 1-4 and extension piece
 Completo, con frese Fig. 1-4 e giunto di prolungamento
 Completo, con fresas no. 1-4 y pieza de prolongación
 Complet, avec fraises no. 1-4 et pièce de rallonge



Verlängerungsstück
 Extension Piece
 Giunto di prolungamento
 Pieza de prolongación
 Pièce de rallonge

**HUDSON
FR-22**



Fig. 1

**HUDSON
FR-23**
Ø 9 mm

Kegelfräser
 Conical Burr
 Fresa cuneiforme
 Fresa cónica
 Fraise conique



Fig. 2

**HUDSON
FR-24**
Ø 14 mm

Kegelfräser
 Conical Burr
 Fresa cuneiforme
 Fresa cónica
 Fraise conique



Fig. 3

**HUDSON
FR-25**
Ø 16 mm

Kugelfräser
 Spherical Burr
 Fresa sferica
 Fresa esférica
 Fraise spherique



Fig. 4

**HUDSON
FR-26**
Ø 22 mm

Kugelfräser
 Spherical Burr
 Fresa sferica
 Fresa esférica
 Fraise spherique

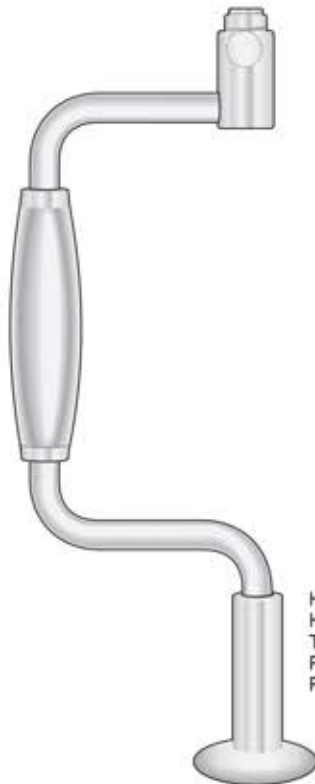

Handbohr allein
 Hand drill only
 Trapano solo
 Perforador suelto
 Perforateur seul

**HUDSON
FR-21**
280 mm



Fig. 5

**ADSON
FR-27**
Ø 15 mm

Bohrer
 Burr
 Punta
 Fresa
 Fraise



Fig. 6

**Mc KENZIE
FR-28**
Ø 13 mm

Bohrer
 Burr
 Punta
 Fresa
 Fraise



Fig. 7

**CUSHING
FR-29**
Ø 14 mm

Flachbohrer
 Flat Trephine
 Trapano piatto
 Taladro plano
 Fraise plate



Fig. 8

FR-30
Ø 2 mm

Spiralbohrer
 Twist Drill
 Punta a spirale
 Broca espiral
 Mèche hélicoïdale

Galeahaken - Galea Hooks
Uncini per Galea - Gancho para Galea
Crochets à Galea

Kopfhautklammer
Scalp Clip
Agrafes per il cuoio capelluto
Grapa para cuero cabelludo
Agrafes pour cuir chevelu



RANEY
FO-83

Anlege- und Abnehmzange für die Kopfhautklammern
Applying and Removing forceps for Scalp haemostasis
Pinza per applicare e rimuovere le agrafe
emostatiche al cuoio capelluto
Pinza para aplicar y quitar agrafes
Pince pour appliquer et enlever les clips



RANEY
FO-86

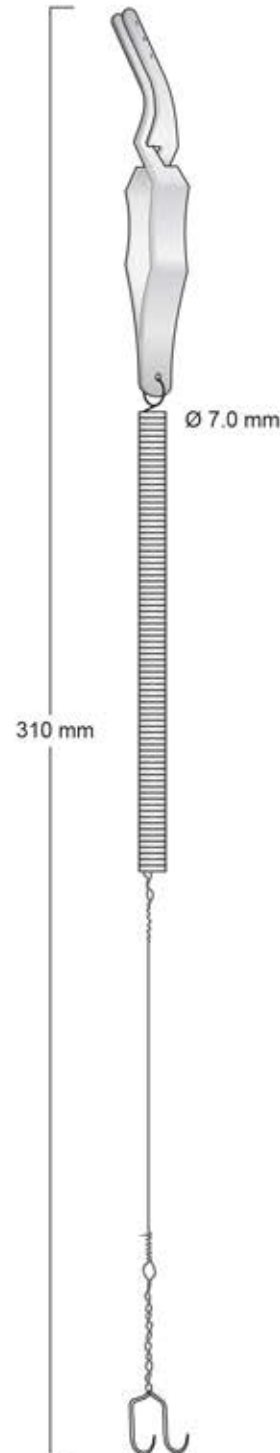

YASARGIL
FF-68
310 mm

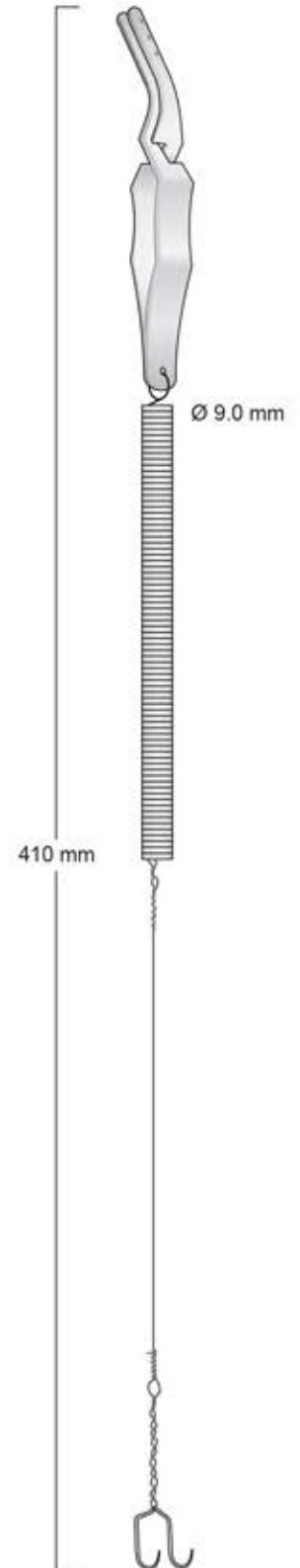

YASARGIL
FF-69
410 mm

*These products are not available for sale or distribution in the USA.
For further information on product availability, please contact your local representative.*

Gerade
Straight
Diritta
Rectas
Droites

180 mm

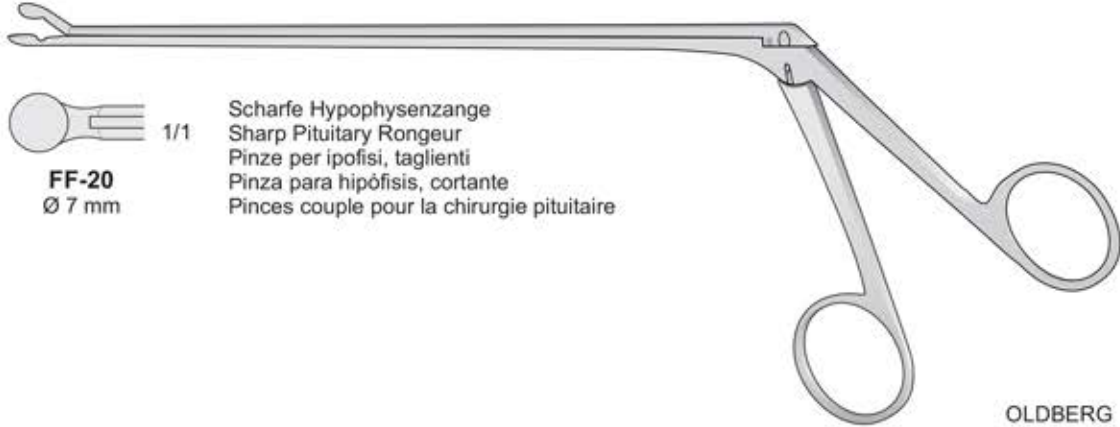

FF-20
Ø 7 mm

1/1

Scharfe Hypophysenzange
Sharp Pituitary Rongeur
Pinze per ipofisi, taglienti
Pinza para hipofisis, cortante
Pinces couple pour la chirurgie pituitaire

**OLDBERG
FF-20**

Gerade
Straight
Diritta
Rectas
Droites

190 mm

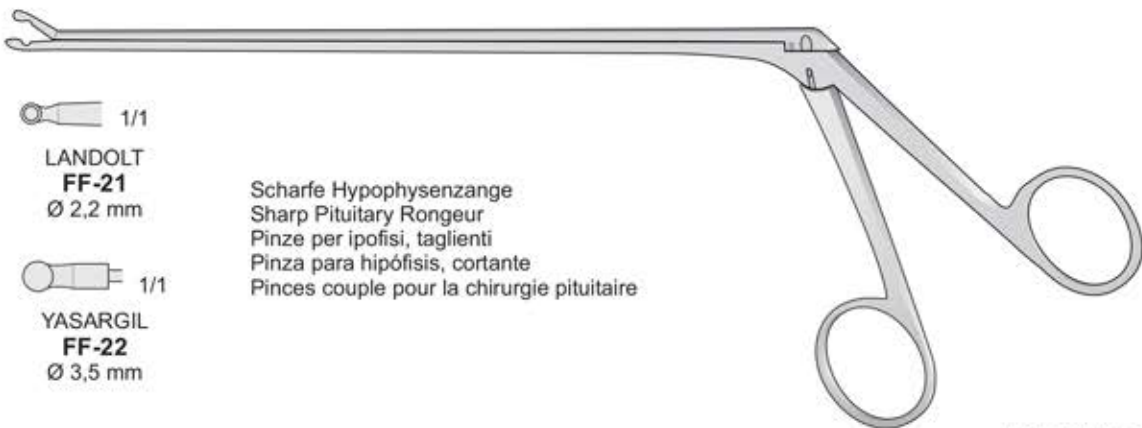

1/1
**LANDOLT
FF-21**
Ø 2,2 mm



1/1
**YASARGIL
FF-22**
Ø 3,5 mm

Scharfe Hypophysenzange
Sharp Pituitary Rongeur
Pinze per ipofisi, taglienti
Pinza para hipofisis, cortante
Pinces couple pour la chirurgie pituitaire

FF-21/FF-22

Gerade
Straight
Diritta
Rectas
Droites

200 mm

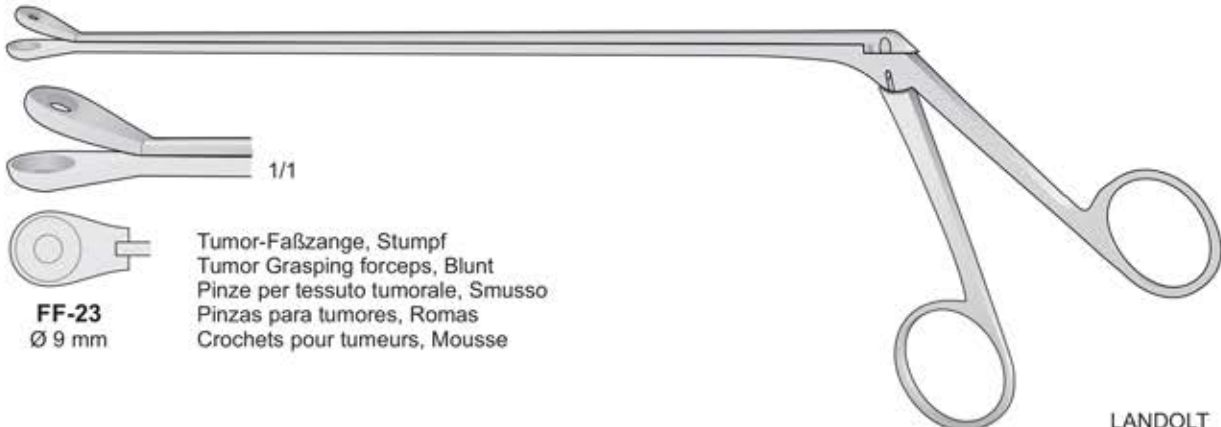

FF-23
Ø 9 mm

Tumor-Faßzange, Stumpf
Tumor Grasping forceps, Blunt
Pinze per tessuto tumorale, Smusso
Pinzas para tumores, Romas
Crochets pour tumeurs, Mousse

**LANDOLT
FF-23**

*These products are not available for sale or distribution in the USA.
For further information on product availability, please contact your local representative.*

Gerade
Straight
Diritta
Rectas
Droites

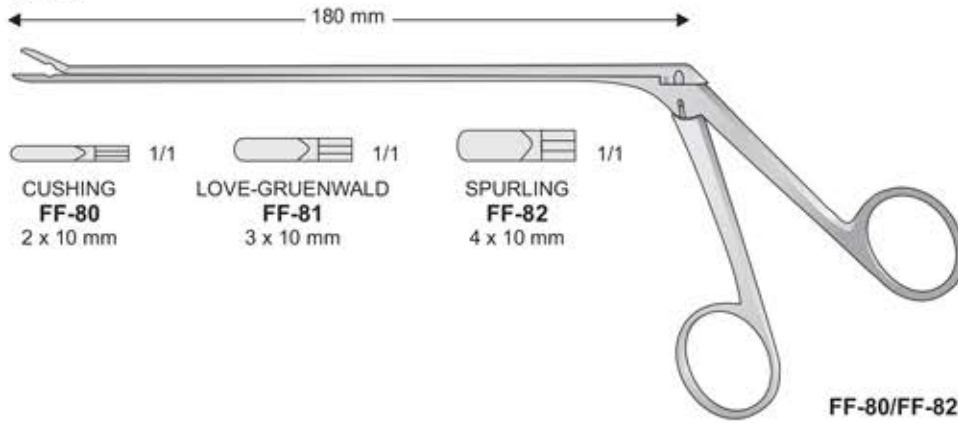

Aufwärtsgebogen
Top curved
Curva verso l'alto
Curvos
Courbe vers le haut

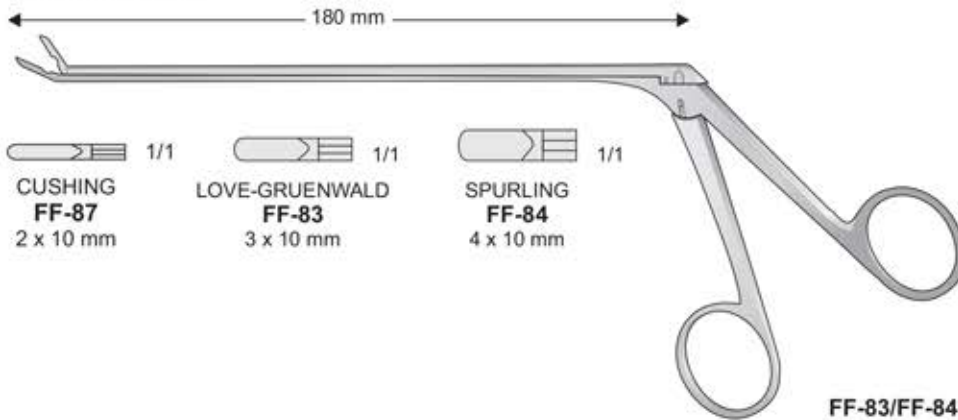

Abwärts gebogen
Bottom curved
Curva verso il basso
Curvos
Courbe vers le bas

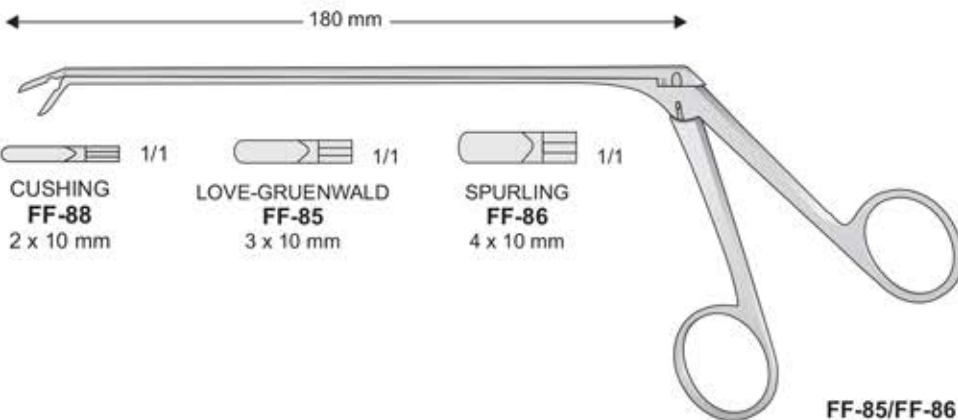

*These products are not available for sale or distribution in the USA.
For further information on product availability, please contact your local representative.*

Gerade
Straight
Diritta
Rectas
Droites

← 155 mm →

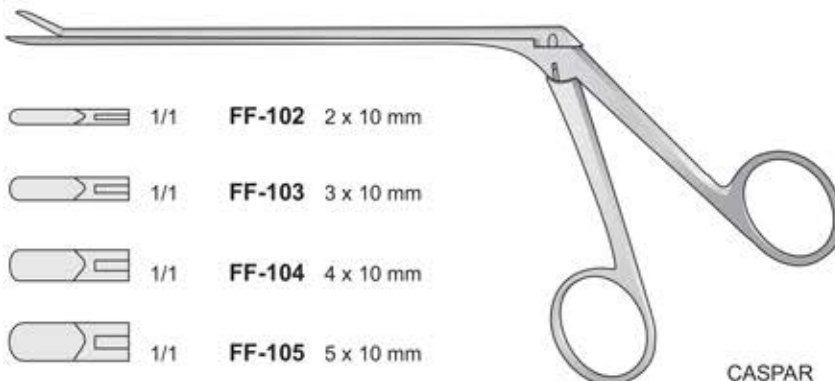

- | | | | |
|--|-----|---------------|-----------|
| | 1/1 | FF-102 | 2 x 10 mm |
| | 1/1 | FF-103 | 3 x 10 mm |
| | 1/1 | FF-104 | 4 x 10 mm |
| | 1/1 | FF-105 | 5 x 10 mm |

CASPAR
FF-102/FF-105

Aufwärtsgebogen
Top curved
Curva verso l'alto
Curvos
Courbe vers le haut

← 155 mm →

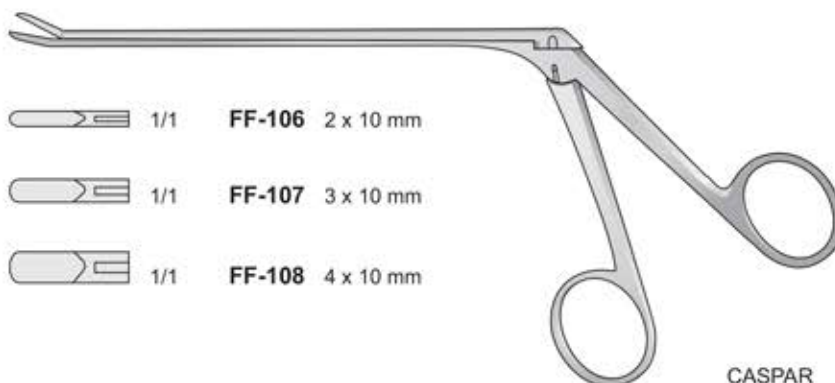

- | | | | |
|--|-----|---------------|-----------|
| | 1/1 | FF-106 | 2 x 10 mm |
| | 1/1 | FF-107 | 3 x 10 mm |
| | 1/1 | FF-108 | 4 x 10 mm |

CASPAR
FF-106/FF-108

Abwärts gebogen
Bottom curved
Curva verso il basso
Curvos
Courbe vers le bas

← 155 mm →

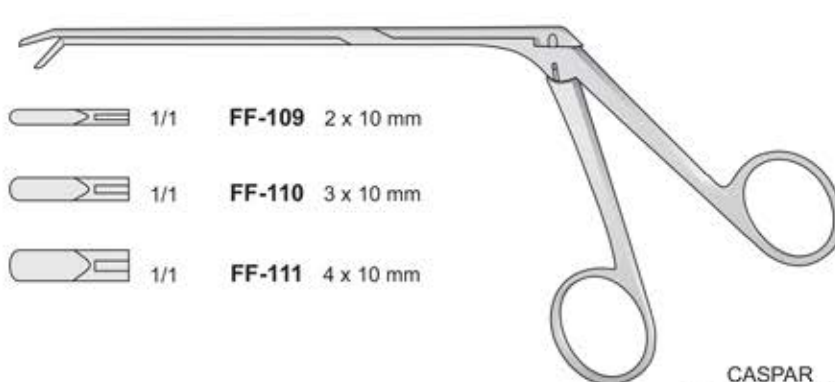

- | | | | |
|--|-----|---------------|-----------|
| | 1/1 | FF-109 | 2 x 10 mm |
| | 1/1 | FF-110 | 3 x 10 mm |
| | 1/1 | FF-111 | 4 x 10 mm |

CASPAR
FF-109/FF-111

*These products are not available for sale or distribution in the USA.
For further information on product availability, please contact your local representative.*

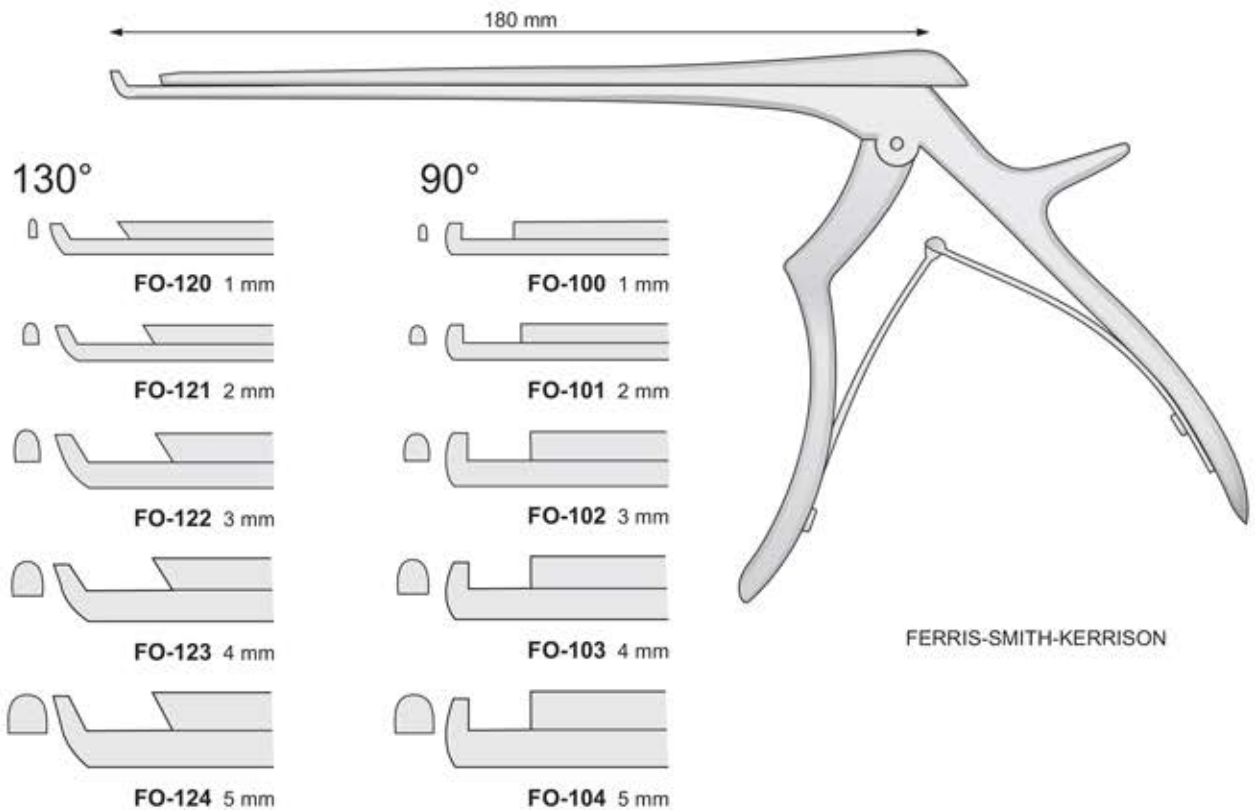
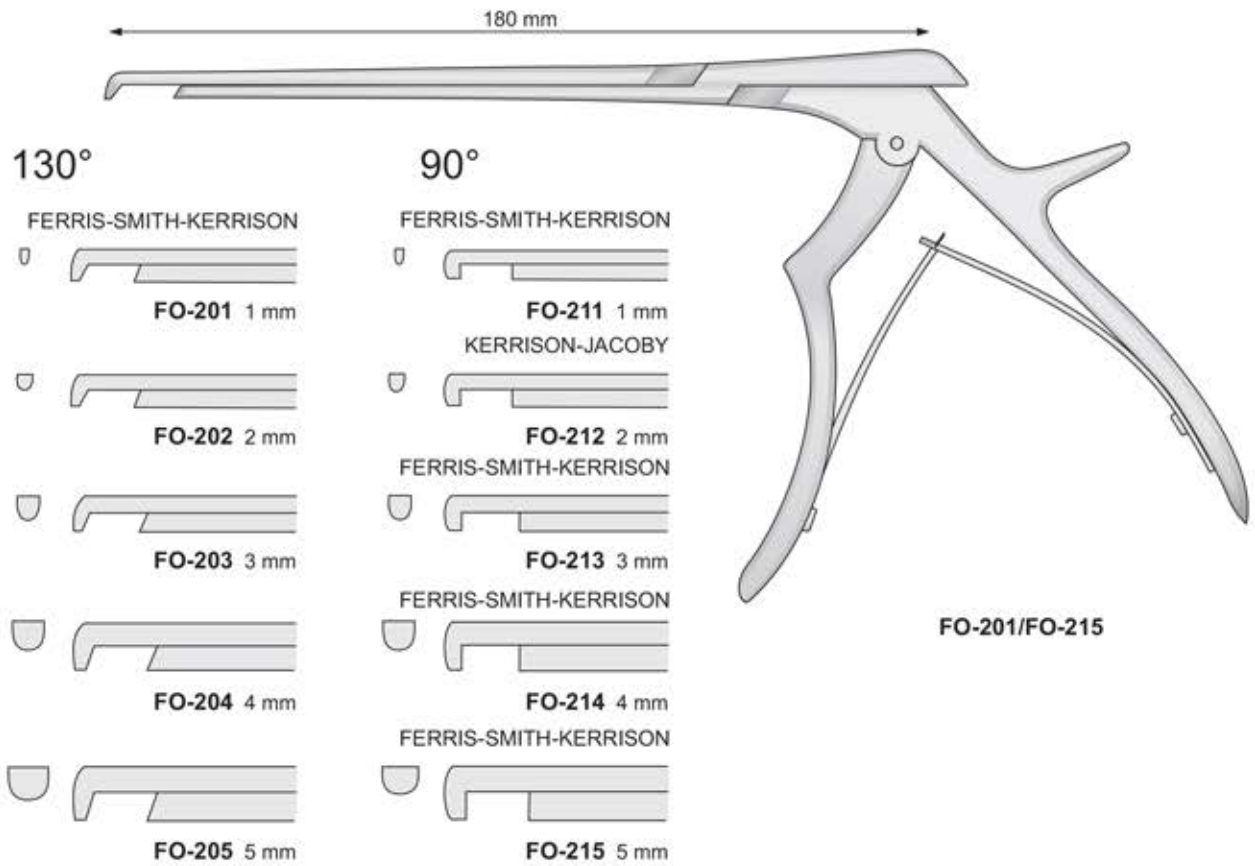

Taglio singolo

8 mm



**COSCIA
FL-368**
180 mm

4 mm

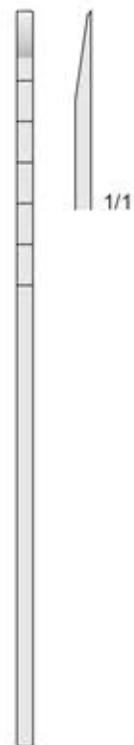

**COTTLE
DO-130**
180 mm

7 mm



**COTTLE
DO-131**
180 mm

9 mm

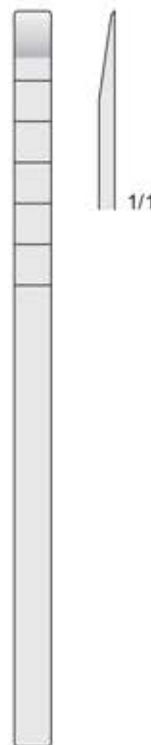

**COTTLE
DO-132**
180 mm

12 mm

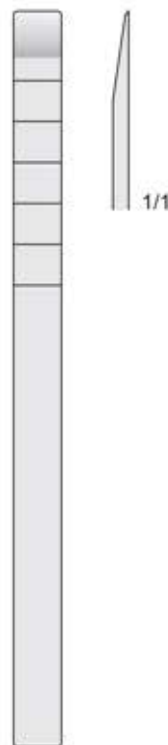

**COTTLE
DO-133**
180 mm

Ø 30 mm
240 g



**COTTLE
FL-104**
185 mm

- 1 Seite flach
- 1 Seite convex
- 1 Side flat
- 1 Side convex
- 1 Lato piatto
- 1 Lato convesso
- 1 Parte plana
- 1 Parte convexa
- 1 Face plate
- 1 Face convexe



**LANDOLT
FF-213**
210 mm

Spekula für Trans-Sphenoidale Hypophysektomie
Specula for Trans-Sphenoidal Hypophysectomy
Specolo per ipofisi transfenoidale



CUSHING-LANDOLT
FF-210 70 x 15 mm
FF-211 90 x 15 mm
FF-212 110 x 15 mm



PAPAVERO-HARTMANN
OM-39
140 mm



PAPAVERO-CASPAR
FF-214 80 x 11 mm
FF-215 90 x 13 mm
FF-216 100 x 15 mm



COTTLE
OM-25/OM-29
150 mm

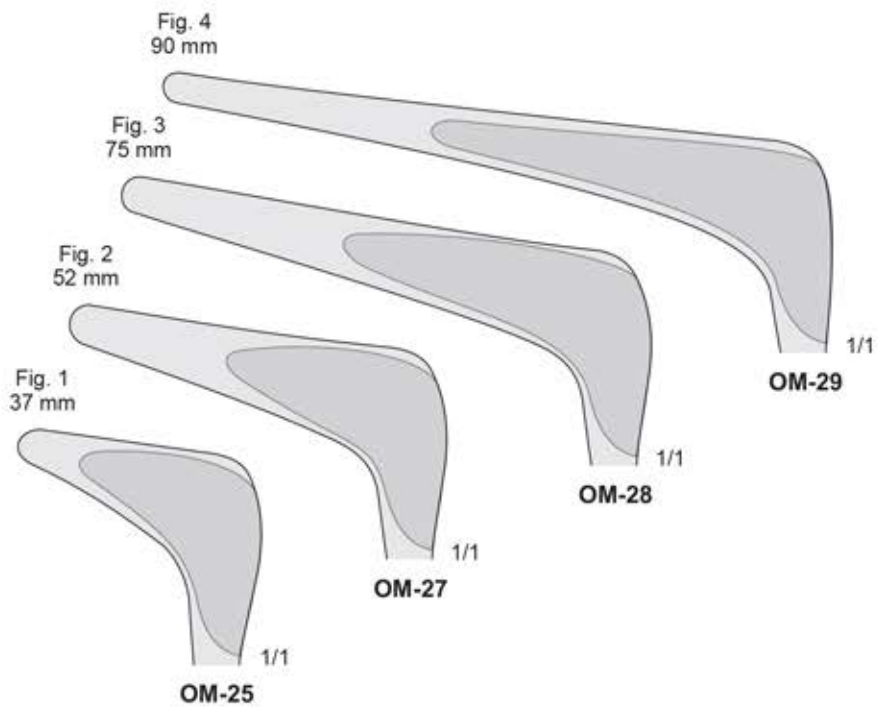

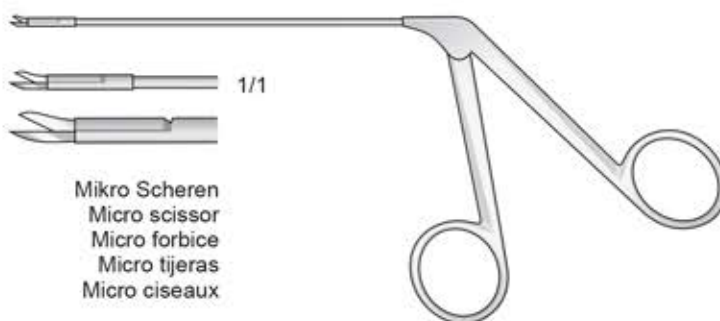

Mikro Scheren
Micro scissor
Micro forbice
Micro tijeras
Micro ciseaux

BELLUCCI
DB-106
80 mm



Mikro-Schere
Micro Scissor

FAHLBUSCH
FF-401
165 mm



Scharfe Zange
Forceps, Scoop-shaped

NICOLA
FF-402
165 mm



Mikro-Schere Gerade
Micro Scissor Straight

NICOLA
FF-403
165 mm

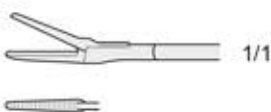

Faßzange
Forceps

YASARGIL-NICOLA
FF-404
165 mm

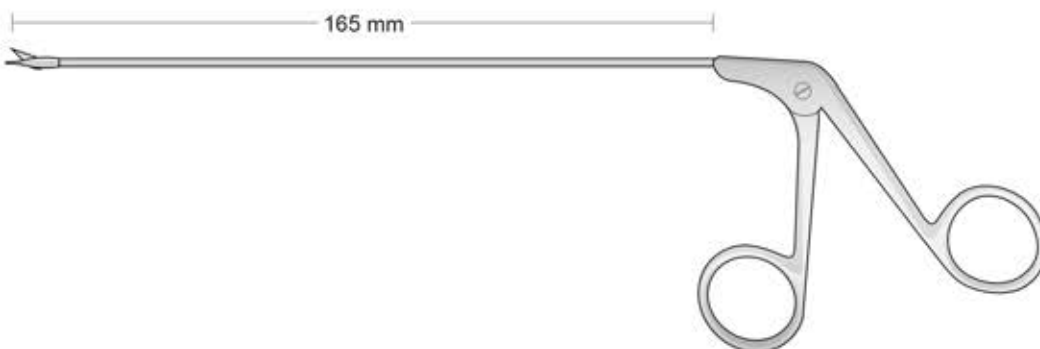

NICOLA
FF-403
165 mm



Kürette
Horizontal 45°
Curette
Horizontal 45°

Ø 4.0 mm

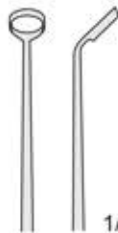

1/1

RAY
FF-321
180 mm

Kürette
Vertikal 45°
Curette
Vertical 45°

Ø 4.0 mm



1/1

RAY
FF-322
180 mm

RAY
FF-321/FF-322
180 mm



NICOLA
FF-323/FF-326
215 mm

Ø 6.5 mm



1/1

NICOLA
FF-323
215 mm

Nach Rechts Schneidend
Cutting to the right
Tagliente a destra
Cortante a la derecha
Couple à droite

Ø 6.5 mm



1/1

NICOLA
FF-324
215 mm

Nach Links Schneidend
Cutting to the left
Tagliente a sinistra
Cortante a la izquierda
Couple à gauche

6,5 mm



1/1

NICOLA
FF-325
215 mm

Kürette, Biegsam
Curette, Malleable
Curette, Malleabile
Cucharillo, Maleable
Curettes, Maleable



1/1

NICOLA
FF-326
215 mm

Raspatorium
Raspatory
Raspatore
Legras
Rugines

Enukleator - Enucleator
Enucleatori

Stumpf
Blunt
Smusso
Romas
Mousse



HARDY
FF-330 Right/Rechts
FF-340 Left/Links
245 mm

Stumpf
Blunt
Smusso
Romas
Mousse



HARDY
FF-331 Right/Rechts
FF-341 Left/Links
245 mm

Spitz
Sharp
Acuto
Agudas
Pointu



HARDY
FF-332 Right/Rechts
FF-342 Left/Links
245 mm

Spitz
Sharp
Acuto
Agudas
Pointu



HARDY
FF-333 Right/Rechts
FF-343 Left/Links
245 mm

120 mm

Implantations-Gabel
Implant Fork



HARDY
FF-334
245 mm

Dissektor Innen Scharf
Dissector Sharpened inner edge



HARDY-FAHLBUSCH
FF-335
245 mm



HARDY-FAHLBUSCH
FF-336
245 mm



HARDY
FF-330/FF-343
245 mm

Enucleator, Stumpf, Biagsam
Enucleator, Blunt, Malleable

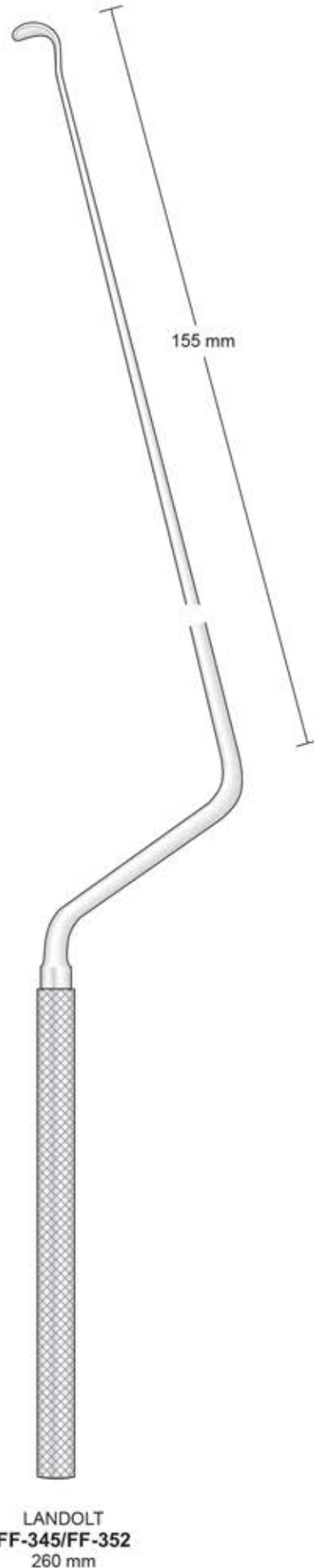
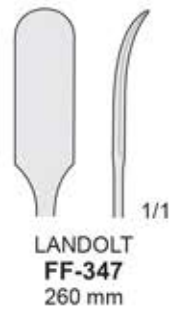
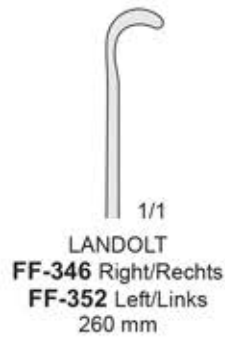
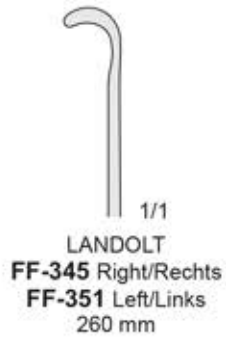

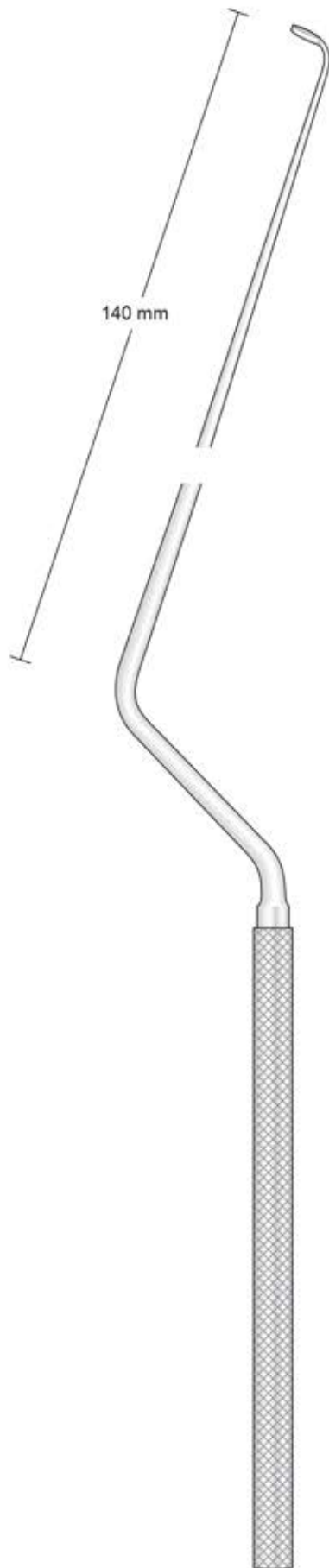

Kürette - Curette - Curette
Curetas - Curette

Ø 4.0 mm

Ø 6.0 mm



FF-353
260 mm

FF-354
260 mm

Biegsam - Malleable - Malleabili
Maleable - Maleable

HARDY
FF-353/FF-354
260 mm

Löffel, Biegsam
Scoop, Malleable
Cucchiaio, Malleabile
Cuchillo, Maleable
Curette, Maleable



1/1
FAHLBUSCH
FF-360
260 mm

Kürette
Curette
Curette
Curetas
Curette



1/1
FAHLBUSCH
FF-361
260 mm

Ø 2.2 mm
Raspatorium, Fest
Raspatories, Rigid
Raspatore, Rigido
Legras
Rugines



1/1
LANDOLT-REULEN
FF-362
260 mm

Ø 3.2 mm
Küretten, Fest
Curette, Rigid
Curette, Rigido
Curetas
Curettes



1/1
LANDOLT-REULEN
FF-363
260 mm



1/1
LANDOLT-REULEN
FF-364
260 mm

Stumpfes Häkchen, Fest
Blunt Hook, Rigid
Uncino smusso, Rigido



1/1
LANDOLT-REULEN
FF-365
260 mm

Dissektor, Fest
Dissector, Rigid
Dissettore, Rigido

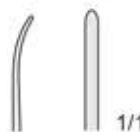

1/1
LANDOLT-REULEN
FF-366
260 mm



FAHLBUSCH
FF-360/FF-366
260 mm

Oberfläche schwarz beschichtet
Surface black-coated

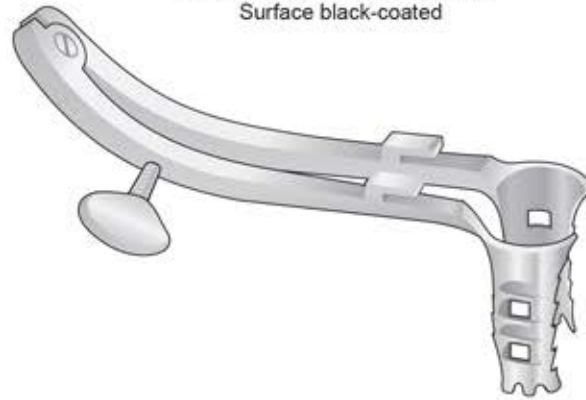

CASPAR
BV-201/BV-208

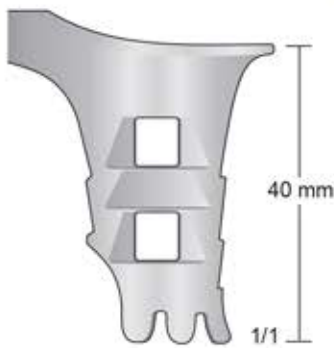

BV-201



BV-202

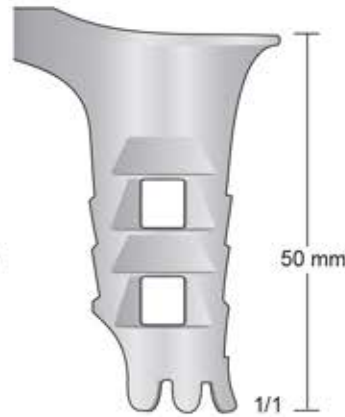

BV-203

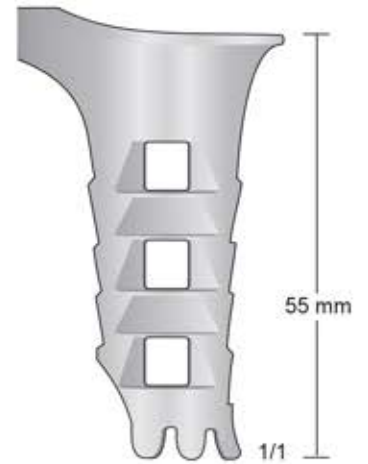

BV-204

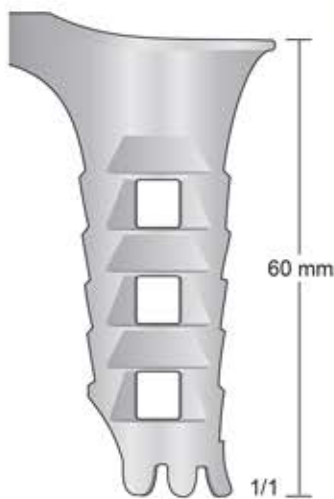

BV-205

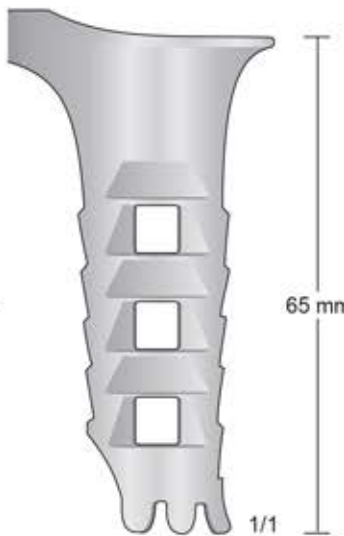

BV-206

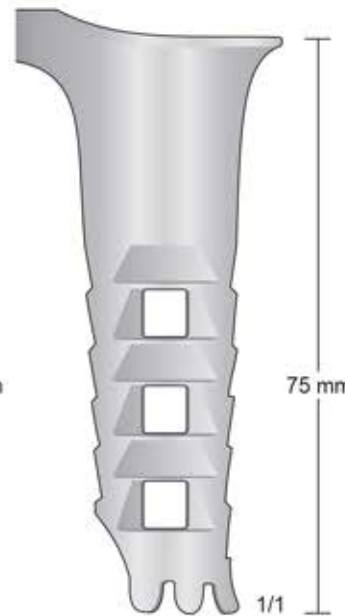

BV-207

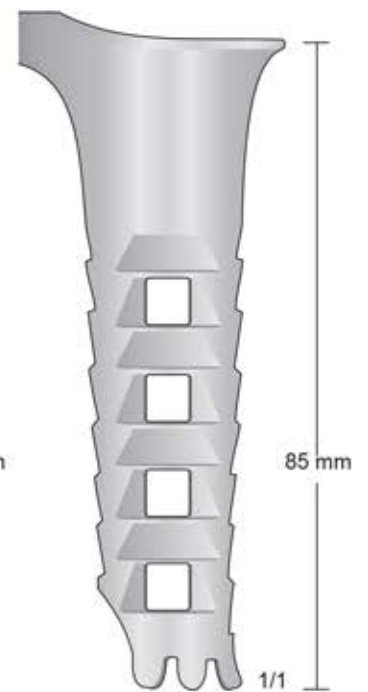

BV-208



**CASPAR
BV-210**

Sperrer komplett mit
Retractor complete with
Divaricatore completo di
Separador completo con
Ecarteur complet avec

- BV-211** Valva anti-riflesso mm. 35
- BV-212** Valva anti-riflesso mm. 40
- BV-213** Valva anti-riflesso mm. 45
- BV-214** Valva anti-riflesso mm. 50
- BV-215** Valva anti-riflesso mm. 55
- BV-216** Valva anti-riflesso mm. 60

BV-209

Sperrer allein
Retractor only
Divaricatore solo
Separador suelto
Ecarteur seul

**CASPAR
BV-209**

Blätter Geschwärzt
Surface Black-finish
Valve anti-riflesso
Inoxidable en negro
Surface noircie

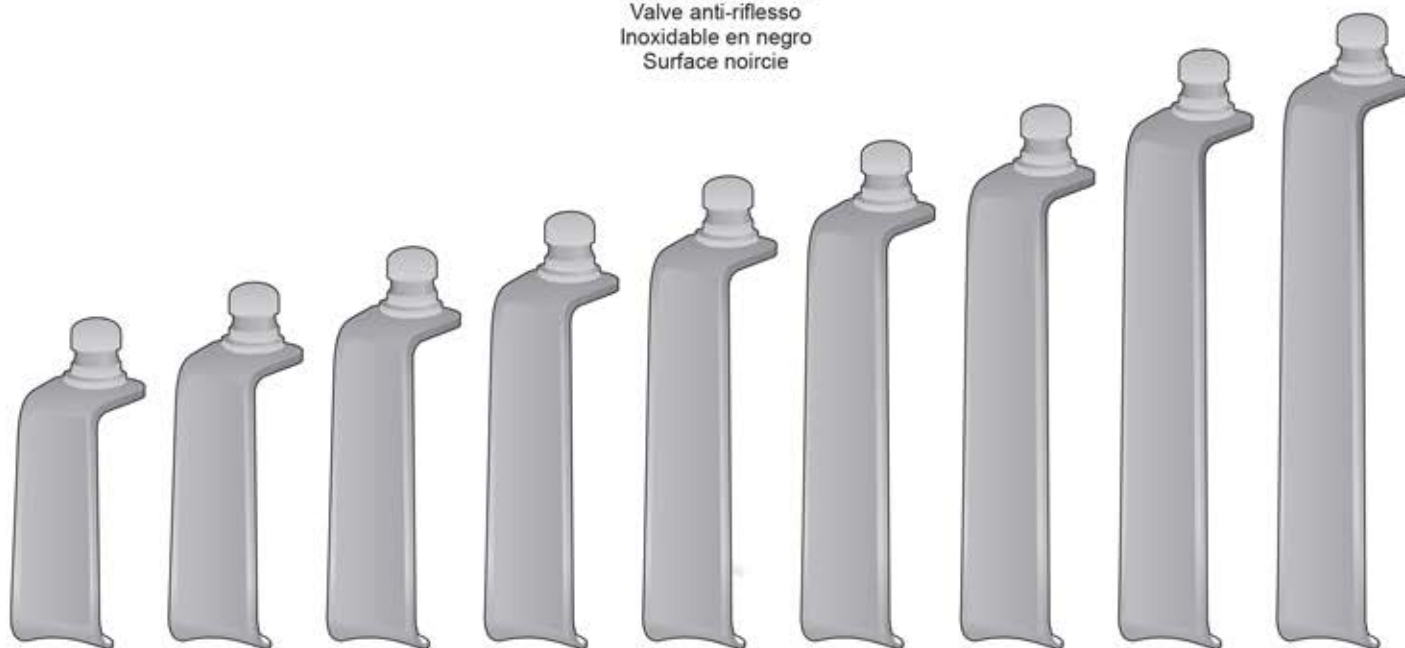

- BV-211**
35 mm
- BV-212**
40 mm
- BV-213**
45 mm
- BV-214**
50 mm
- BV-215**
55 mm
- BV-216**
60 mm
- BV-217**
65 mm
- BV-218**
75 mm
- BV-219**
85 mm



CASPAR
BV-230
Gegensperrerr komplett
mit 7 Blätter
Retractor complete
with 7 blades
Divaricatore completo
con 7 valve

CASPAR
BV-238
Gegensperrerr allein
mit 1 festem Blatt
Retractor only
with 1 fixed blade

CASPAR
BV-230
170 mm

Blätter Geschwärzt
Surface Black-finish
Valve anti-riflesso
Inoxidable en negro
Surface noircie

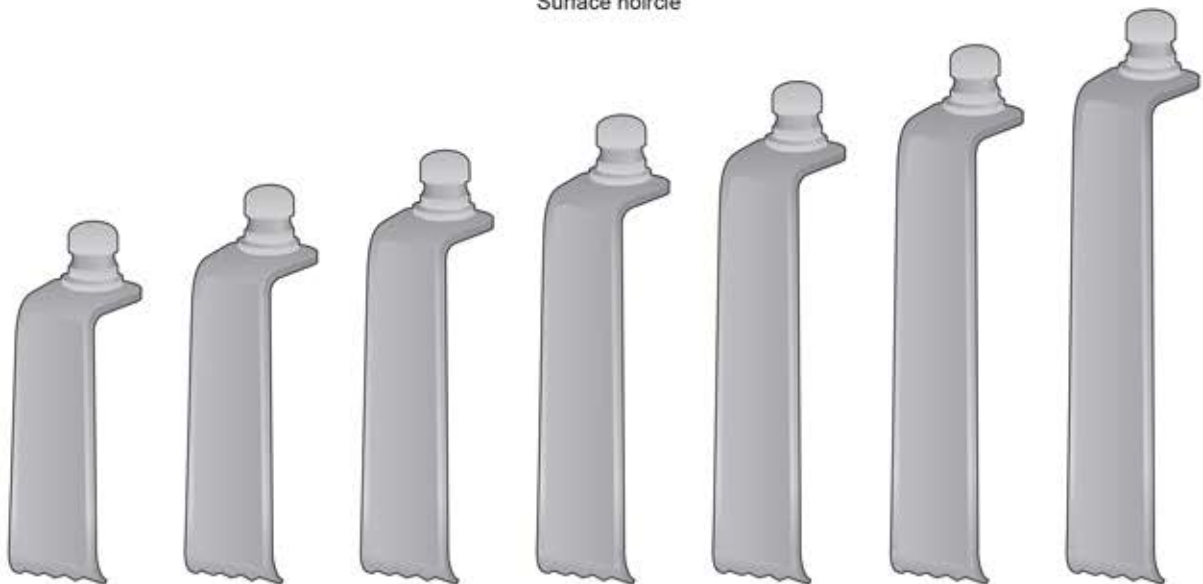

BV-231
40 mm

BV-232
45 mm

BV-233
50 mm

BV-234
55 mm

BV-235
60 mm

BV-236
65 mm

BV-237
70 mm

Char. 6	=	2 mm
Char 7	=	2,5 mm
Char 8	=	2,7 mm
Char 9	=	3 mm
Char 10	=	3,3 mm
Char 12	=	4 mm
Char 15	=	5 mm

Saugkanüle, isoliert
mit Saugunterbrecher und Mandrin
Suction cannula, insulated
with finger cut-off and stylet

Ø 4 mm

Ch.12

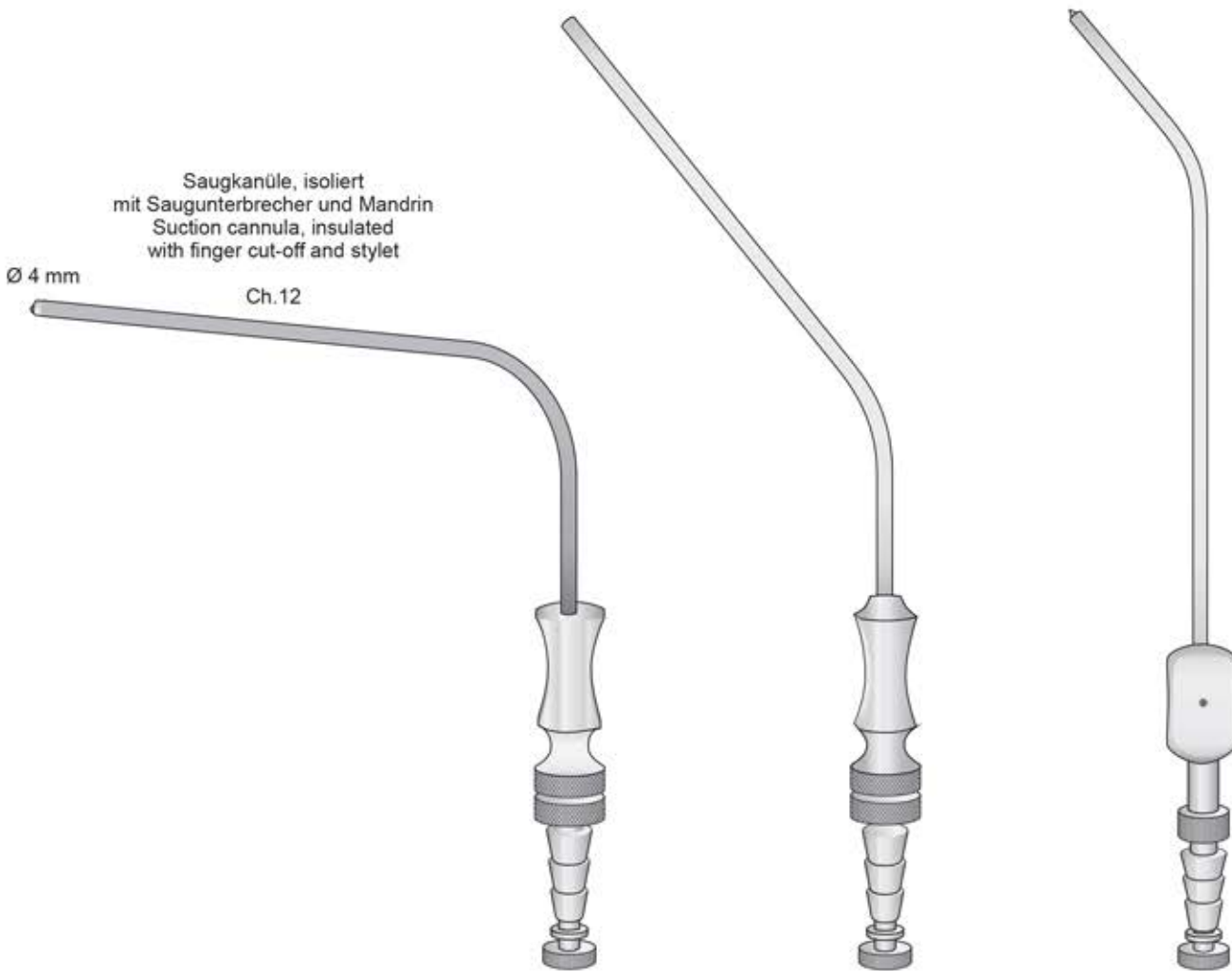

FERGUSON
GF-252
150 mm

FRAZIER
GF-240 Ch. 6 2,0 mm
GF-241 Ch. 7 2,5 mm
GF-241B Ch. 8 2,7 mm
GF-242 Ch. 9 3,0 mm
GF-242B Ch. 10 3,3 mm
GF-243 Ch. 12 4,0 mm
GF-244 Ch. 15 5,0 mm
180 mm

PLESTER
GF-150 Ch. 6 2,0 mm
GF-151 Ch. 7 2,5 mm
GF-151B Ch. 8 2,7 mm
GF-152 Ch. 9 3,0 mm
GF-152B Ch. 10 3,3 mm
GF-153 Ch. 12 4,0 mm
GF-154 Ch. 15 5,0 mm
200 mm

YASARGIL	Usable length	Ø
GF-210	130 mm	1,5 mm
GF-211	150 mm	1,5 mm
GF-212	180 mm	1,5 mm
GF-213	220 mm	1,5 mm

YASARGIL	Usable length	Ø
GF-214	130 mm	2,0 mm
GF-215	150 mm	2,0 mm
GF-216	180 mm	2,0 mm
GF-217	220 mm	2,0 mm

YASARGIL	Usable length	Ø
GF-222	130 mm	2,5 mm
GF-223	150 mm	2,5 mm
GF-224	180 mm	2,5 mm
GF-225	220 mm	2,5 mm

YASARGIL	Usable length	Ø
GF-226	130 mm	3,5 mm
GF-227	150 mm	3,5 mm
GF-228	180 mm	3,5 mm
GF-229	220 mm	3,5 mm

YASARGIL	Usable length	Ø
GF-230	180 mm	4,5 mm

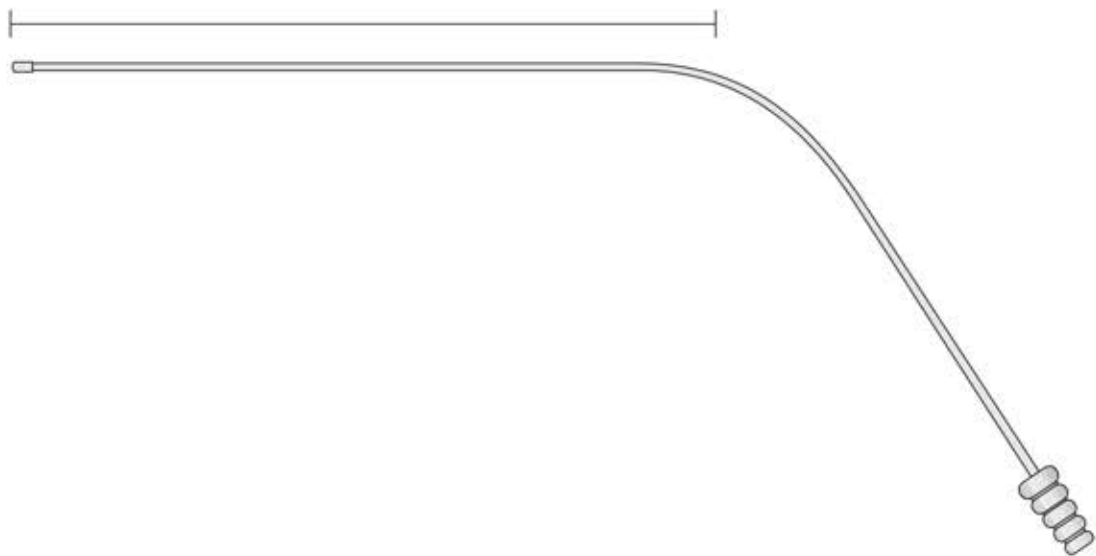

YASARGIL
GF-210/GF-230



Item	Page	Item	Page	Item	Page
BB-38	37	BD-313	31	BV-218	90
BB-40	37	BD-314	31	BV-219	90
BB-46	37	BD-315	31	BV-230	91
BB-48	37	BD-316	31	BV-231	91
BB-50	37	BD-317	31	BV-232	91
BB-52	37	BD-318	31	BV-233	91
		BD-319	31	BV-234	91
BD-30T	35	BD-320	31	BV-235	91
BD-31T	35	BD-321	32	BV-236	91
BD-32T	36	BD-322	32	BV-237	91
BD-33T	36	BD-323	32	BV-238	91
BD-35T	36	BD-324	32		
BD-36T	36	BD-325	32	DB-106	82
BD-42T	36	BD-326	32		
BD-43T	36	BD-327	33	DO-56	43
BD-60	34	BD-328	33	DO-57	43
BD-60T	36	BD-329	33	DO-58	43
BD-62	34	BD-330	33	DO-130	80
BD-62T	36	BD-331	33	DO-131	80
BD-80	25	BD-332	31	DO-132	80
BD-80T	23	BD-341T	35	DO-133	80
BD-81	25	BD-358	35	DO-174	43
BD-81T	23	BD-359	35	DO-270	71
BD-82	25	BD-360	35	DO-271	71
BD-83	25	BD-361	35	DO-272	71
BD-84	25	BD-362	35	DO-273	71
BD-84T	23	BD-363	35	DO-279	71
BD-85	25	BD-364	36	DO-280	71
BD-86	25	BD-365	36	DO-281	71
BD-86T	23	BD-366	36	DO-282	71
BD-87	25	BD-367	36		
BD-88	25			FB-67	63
BD-89	25	BT-15	42	FB-68	63
BD-141T	35	BT-16	42	FB-69	63
BD-160	25	BT-196	42	FB-70	63
BD-160T	23	BT-200	42	FB-71	63
BD-161	25	BT-296	43	FB-72	63
BD-161T	23	BT-297	43	FB-73	63
BD-162	25	BT-298	43	FB-74	63
BD-162T	23	BT-299	43	FB-77	63
BD-163	25	BT-300	44	FB-78	63
BD-163T	23	BT-301	44	FB-79	63
BD-164	25	BT-302	44	FB-81	63
BD-165	24	BT-303	44	FB-82	63
BD-166	24	BT-304	45	FB-83	63
BD-167	24	BT-305	45	FB-84	62
BD-168	24	BT-306	45	FB-85	62
BD-169	24	BT-307	45	FB-86	62
BD-170	24	BT-308	45	FB-87	62
BD-171	24	BT-309	45	FB-120	73
BD-172	24	BT-310	45		
BD-173	24	BT-311	45	FD-04	3
BD-206	34			FD-05	3
BD-235	34	BV-201	89	FD-17	17
BD-236	34	BV-202	89	FD-19	17
BD-237	34	BV-203	89	FD-21	17
BD-238	34	BV-204	89	FD-22	17
BD-239	34	BV-205	89	FD-25	17
BD-301	30	BV-206	89	FD-27	17
BD-302	30	BV-207	89	FD-50	3
BD-303	30	BV-208	89	FD-61	3
BD-304	30	BV-209	90	FD-63	17
BD-305	30	BV-210	90	FD-75	9
BD-306	30	BV-211	90	FD-76	9
BD-307	30	BV-212	90	FD-77	9
BD-308	30	BV-213	90	FD-78	9
BD-309	30	BV-214	90	FD-79	3
BD-310	30	BV-215	90	FD-80	3
BD-311	30	BV-216	90	FD-81	3
BD-312	31	BV-217	90	FD-101	14

Articolo	Pagina	Articolo	Pagina	Articolo	Pagina
FD-102	14	FD-352	51	FD-430	10
FD-103	14	FD-353	51	FD-431	10
FD-104	14	FD-354	51	FD-432	10
FD-121	59	FD-355	51	FD-433	10
FD-122	59	FD-356	51	FD-434	10
FD-133	9	FD-357	51	FD-435	10
FD-139	8	FD-358	51	FD-436	10
FD-140	8	FD-359	51	FD-437	10
FD-141	8	FD-360	58	FD-438	10
FD-142	8	FD-361	58	FD-439	10
FD-143	8	FD-362	58	FD-440	10
FD-144	8	FD-363	58	FD-441	10
FD-145	9	FD-364	58	FD-442	10
FD-148	15	FD-365	58	FD-443	10
FD-149	15	FD-366	56	FD-444	10
FD-150	15	FD-374	52	FD-500	62
FD-151	15	FD-375	52	FD-501	62
FD-152	15	FD-376	52	FD-502	62
FD-157	15	FD-377	52	FD-503	62
FD-165	59	FD-378	52	FD-504	62
FD-166	59	FD-379	52	FD-505	62
FD-169	59	FD-380	52	FD-506	62
FD-182	11	FD-381	52	FD-507	61
FD-183	11	FD-382	52	FD-508	61
FD-186	11	FD-383	52	FD-509	61
FD-187	11	FD-384	52	FD-510	61
FD-191	11	FD-385	52	FD-511	61
FD-195	11	FD-386	52	FD-512	61
FD-196	11	FD-387	52	FD-513	61
FD-197	11	FD-388	52	FD-514	61
FD-198	11	FD-389	52	FD-515	61
FD-199	11	FD-390	53	FD-516	61
FD-214	16	FD-391	53	FD-517	61
FD-215	16	FD-392	53	FD-518	61
FD-216	16	FD-393	53	FD-519	61
FD-217	16	FD-394	53	FD-520	61
FD-218	16	FD-395	53	FD-562T	18
FD-219	16	FD-396	53	FD-563T	18
FD-220	16	FD-397	53	FD-574T	18
FD-224	12	FD-398	53	FD-575T	18
FD-225	12	FD-399	53	FD-587T	18
FD-226	12	FD-401	4	FD-588T	18
FD-227	12	FD-402	4		
FD-228	12	FD-403	4	FE-21	60
FD-229	12	FD-404	4	FE-22	60
FD-230	12	FD-405	4	FE-23	60
FD-306	7	FD-406	4	FE-24	60
FD-307	7	FD-407	4	FE-25	60
FD-310	7	FD-408	5	FE-26	60
FD-311	7	FD-409	5	FE-27	60
FD-331	46	FD-410	5	FE-28	60
FD-332	46	FD-411	5	FE-29	60
FD-333	46	FD-412	5	FE-30	60
FD-334	46	FD-413	5	FE-31	60
FD-335	46	FD-414	5	FE-32	60
FD-336	46	FD-415	5	FE-33	60
FD-337	47	FD-416	5	FE-34	60
FD-338	47	FD-417	6	FE-35	60
FD-339	47	FD-418	6	FE-36	60
FD-340	47	FD-419	6	FE-37	60
FD-341	48	FD-420	13	FE-38	60
FD-342	48	FD-421	13	FE-39	60
FD-343	48	FD-422	13	FE-40	60
FD-344	49	FD-423	13	FE-41	60
FD-345	49	FD-424	13	FE-42	60
FD-347	50	FD-425	13	FE-43	60
FD-348	50	FD-426	14	FE-44	60
FD-349	50	FD-427	14	FE-45	60
FD-350	50	FD-428	14	FE-46	60
FD-351	50	FD-429	14	FE-47	60

Articolo	Pagina	Articolo	Pagina	Articolo	Pagina
FE-48	60	FF-325	84	FO-103	79
FE-49	60	FF-326	84	FO-104	79
FE-50	60	FF-330	85	FO-120	79
FE-51	60	FF-331	85	FO-121	79
FE-52	60	FF-332	85	FO-122	79
FE-53	60	FF-333	85	FO-123	79
FE-54	60	FF-334	85	FO-124	79
FE-55	60	FF-335	85	FO-201	79
FE-56	60	FF-336	85	FO-202	79
FE-57	60	FF-340	85	FO-203	79
FE-58	60	FF-341	85	FO-204	79
FE-59	60	FF-342	85	FO-205	79
FE-60	60	FF-343	85	FO-211	79
		FF-345	86	FO-212	79
FF-20	76	FF-346	86	FO-213	79
FF-21	76	FF-347	86	FO-214	79
FF-22	76	FF-348	86	FO-215	79
FF-23	76	FF-349	86		
FF-68	75	FF-350	86	FR-16	38
FF-69	75	FF-351	86	FR-17	38
FF-80	77	FF-352	86	FR-20	74
FF-81	77	FF-353	87	FR-23	74
FF-82	77	FF-354	87	FR-24	74
FF-83	77	FF-360	88	FR-25	74
FF-84	77	FF-361	88	FR-26	74
FF-85	77	FF-362	88	FR-27	74
FF-86	77	FF-363	88	FR-28	74
FF-87	77	FF-364	88	FR-29	74
FF-88	77	FF-365	88	FR-30	74
FF-102	78	FF-366	88	FR-64	38
FF-103	78	FF-401	82	FR-65	38
FF-104	78	FF-402	82		
FF-105	78	FF-403	82	FREER	38
FF-106	78	FF-404	82		
FF-107	78	FF-420	67	GF-150	92
FF-108	78	FF-421	67	GF-151	92
FF-109	78	FF-422	67	GF-151B	92
FF-110	78	FF-423	65, 66, 67, 68	GF-152	92
FF-111	78	FF-425	65, 66, 67	GF-152B	92
FF-210	80	FF-426	67, 68	GF-153	92
FF-211	80	FF-427	67, 68	GF-154	92
FF-212	80	FF-428	67, 68	GF-210	93
FF-213	80	FF-429	67	GF-211	93
FF-214	81	FF-430	65	GF-212	93
FF-215	81	FF-432	65, 66	GF-213	93
FF-216	81	FF-433	65, 66	GF-214	93
FF-301	54	FF-434	65, 66	GF-215	93
FF-302	54	FF-435	65, 66	GF-216	93
FF-303	54	FF-436	66	GF-217	93
FF-304	54			GF-222	93
FF-305	54	FG-106	72	GF-223	93
FF-306	54	FG-107	72	GF-224	93
FF-307	54	FG-152	72	GF-225	93
FF-308	54	FG-209	12	GF-226	93
FF-309	55	FG-210	12	GF-227	93
FF-310	55	FG-211	12	GF-228	93
FF-311	55	FG-212	12	GF-229	93
FF-312	55			GF-230	93
FF-313	55	FK-11	73	GF-240	92
FF-314	55	FK-13	73	GF-241	92
FF-315	56	FK-14	73	GF-241B	92
FF-316	56			GF-242	92
FF-317	57	FL-104	80	GF-242B	92
FF-318	57	FL-368	80	GF-243	92
FF-319	57			GF-244	92
FF-320	57	FO-83	75	GF-252	92
FF-321	83	FO-86	75		
FF-322	83	FO-100	79	KO-11	40
FF-323	84	FO-101	79	KO-14	41
FF-324	84	FO-102	79	KO-15	41

Articolo	Pagina	Articolo	Pagina	Articolo	Pagina
KO-16	41	MF-342T	21	OM-218	70
KO-17	41	MF-343T	21	OM-219	70
KO-21	40	MF-344T	21	OM-220	70
KO-40	39	MF-345T	21		
KO-41	39	MF-346T	21	P-16	73
KO-42	39	MF-347T	21	P-122	73
KO-43	39	MF-348T	22	P-332	73
KO-44	39	MF-349T	22	P-401	64
KO-47	41	MF-350T	22	P-402	64
KO-48	41	MF-351T	22	P-403	64
KO-49	41	MF-352T	22	P-404	64
KO-50	41	MF-353T	22	P-405	64
KO-72	40	MF-354T	22	P-406	64
		MF-355T	22	P-407	64
LB-10	38	MF-356T	22	P-408	64
LB-11	38	MF-357T	22		
LB-12	38	MF-358T	22		
LB-12D	38	MF-359T	22		
LB-13	38	MF-362T	20		
LB-15	38	MF-363T	20		
LB-15A	38	MF-364T	20		
LB-15C	38	MF-365T	20		
LB-40	38	MF-366T	20		
LB-361	37	MF-367T	20		
LB-362	37	MF-370	28		
LB-363	37	MF-371	28		
LB-364	37	MF-372	28		
LB-365	37	MF-373	28		
LB-366	37	MF-374	28		
LB-367	37	MF-375	28		
LB-368	37	MF-376	28		
LB-369	37	MF-377	28		
		MF-378	29		
MA-B3	38	MF-379	29		
MA-B7	38	MF-380	29		
MA-B15	38	MF-381	29		
MA-10	49	MF-382	29		
		MF-383	29		
MF-110	26	MF-384	29		
MF-111	26	MF-385	29		
MF-112	26				
MF-113	26	NK-12	38		
MF-114	26				
MF-115	26	OM-25	81		
MF-116	27	OM-27	81		
MF-117	27	OM-28	81		
MF-118	27	OM-29	81		
MF-119	27	OM-39	81		
MF-120	27	OM-80	69		
MF-121	27	OM-81	69		
MF-122	27	OM-82	69		
MF-123	27	OM-85	69		
MF-130T	19	OM-87	69		
MF-131T	19	OM-88	69		
MF-132T	19	OM-99	66		
MF-133T	19	OM-201	68		
MF-134T	19	OM-202	68		
MF-135T	19	OM-203	68		
MF-136T	19	OM-204	68		
MF-137T	19	OM-205	70		
MF-138T	19	OM-206	65, 66, 70		
MF-139T	19	OM-207	70		
MF-140T	19	OM-208	68		
MF-141T	19	OM-209	68		
MF-142T	21	OM-210	68		
MF-143T	21	OM-211	68		
MF-144T	21	OM-214	70		
MF-145T	21	OM-215	70		
MF-146T	21	OM-216	70		
MF-147T	21	OM-217	70		



BROMED
INSTRUMENTS