

Das Instrument.



BROMED
INSTRUMENTS



*Superscharfe Schere
Ciseaux Super-tranchant
Tijeras super-corte
Forbici super-taglienti*

Super-Cut Scissors



BROMED
INSTRUMENTS



Super-Cut Scissors



BROMED
INSTRUMENTS



SUPER CUT

Regular Edge SUPER CUT Edge

Super Cut Scissors have specially designed cutting edges. One regular edge and one sharp-knife edge.

Extremely Sharp Razor Edge / Atraumatic
 Extrem Scharfe Spitzer Beck / Atraumatische
 Tranchant extrêmement aiguës / Atraumatique
 Borde extremadamente afilado / Atraumatica
 Taglio estremamente affilato / Atraumatica

Tungsten-Carbide Inserts
 Mit Hartmetalleinsätzen
 Plaquettes en carbure de tungstène
 Plaquetas de carburo de tungsteno
 Inserti in carburo di tungsteno

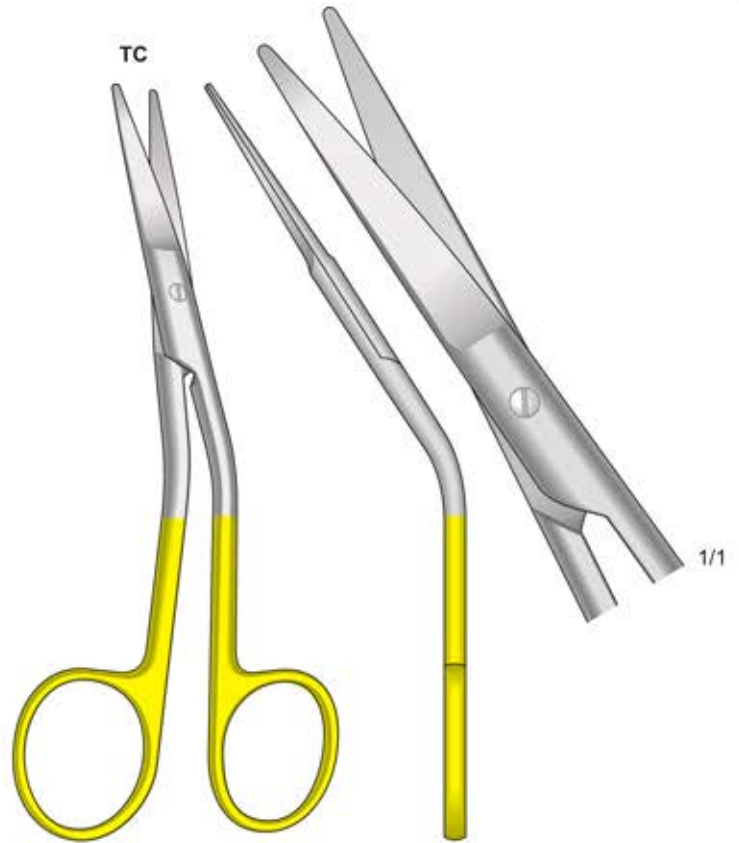

COTTLE
FG-195
 160 mm

Super Cut

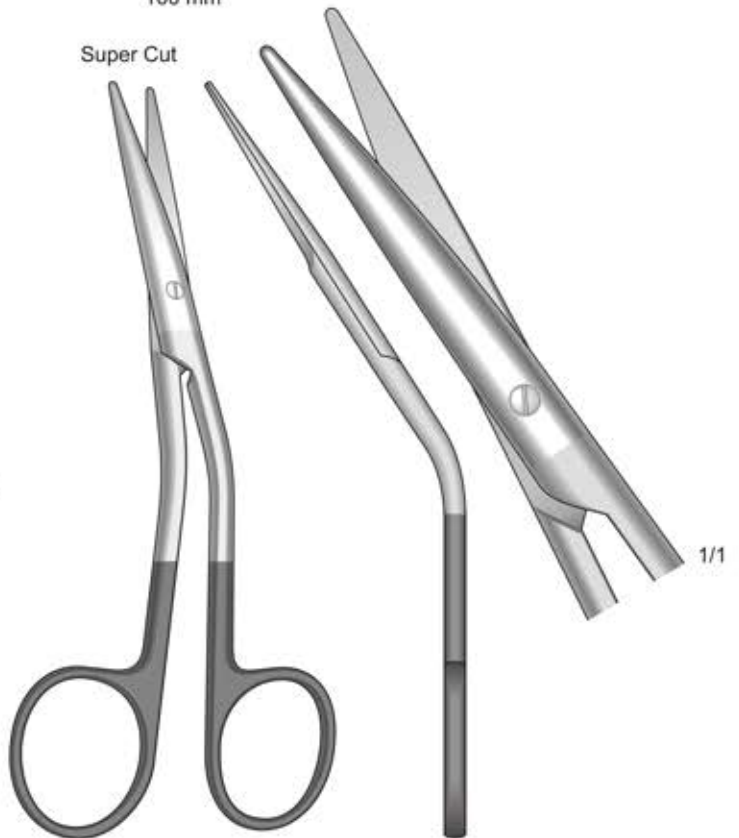

COTTLE
FG-193
 160 mm

Super Cut

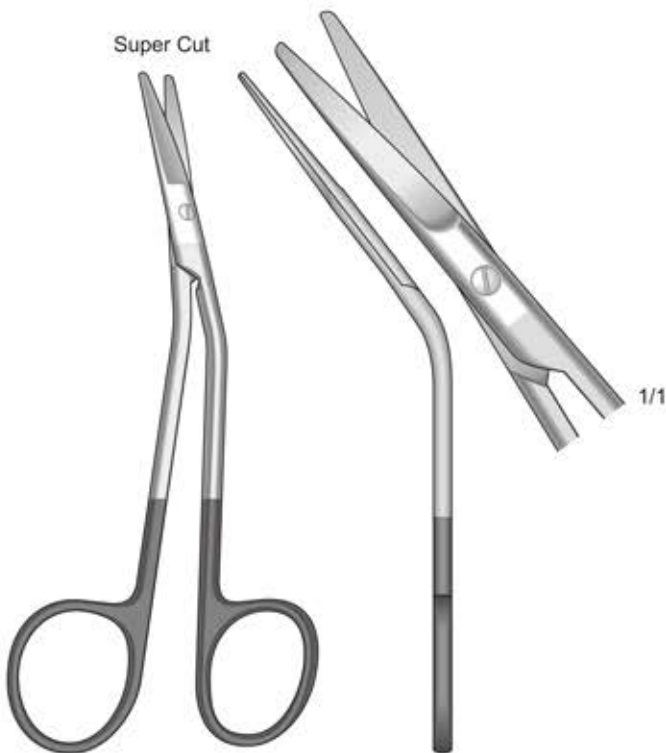

FOMON
FG-192
 130 mm



Extremely Sharp Razor Edge / Atraumatic
 Extrem Scharfe Spitzer Beck / Atraumatische
 Tranchant extrêmement aiguisée / Atraumatique
 Borda extremadamente afilado / Atraumática
 Taglio estremamente affilato / Atraumatica



One side serrated
 Eine seite gezahnt
 Un côté dentelé
 Un lado dentado
 Un lato dentellato

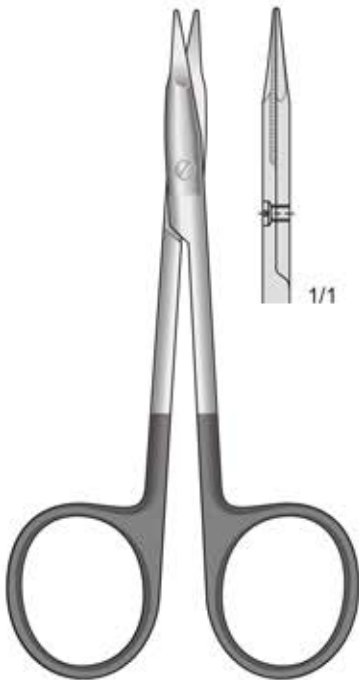

**STEVENS
 FM-302**
 105 mm

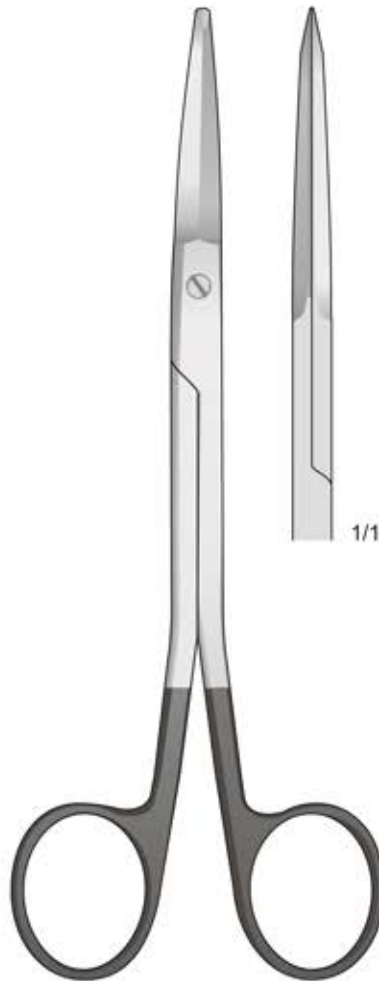

**FACE-LIFT
 FM-308**
 160 mm

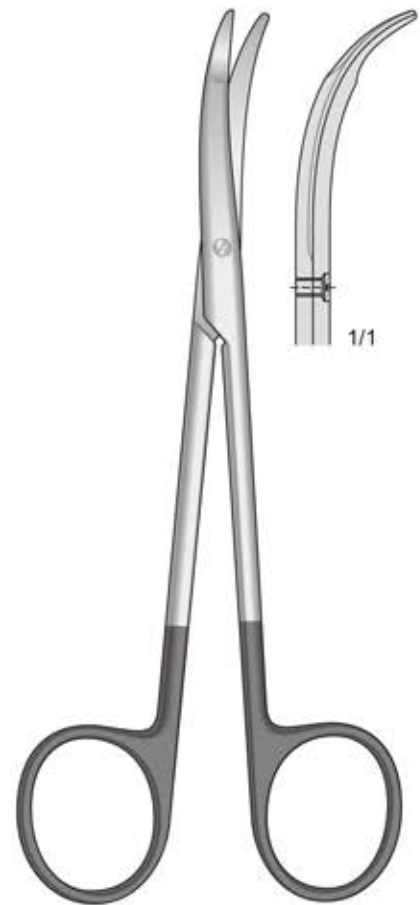

**FOMON
 FG-163**
 140 mm



Extremely Sharp Razor Edge / Atraumatic
 Extrem Scharfe Spitzer Beck / Atraumatische
 Tranchant extrêmement aiguisée / Atraumatique
 Borde extremadamente afilado / Atraumática
 Taglio estremamente affilato / Atraumatica



One side serrated
 Eine seite gezahnt
 Un côté dentelé
 Un lado dentado
 Un lato dentellato

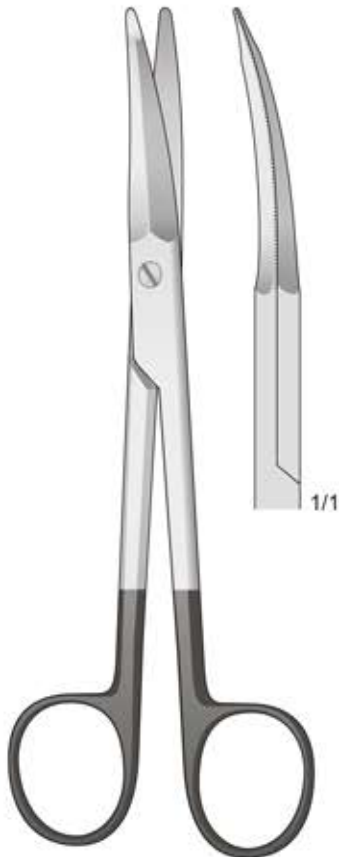

REES-FACE-LIFT
FM-304
 150 mm

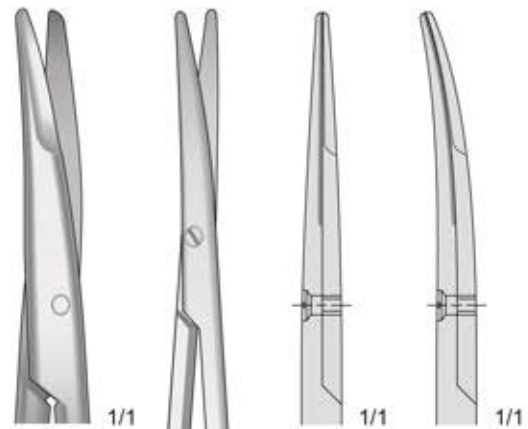

FM-318
 180 mm

FM-319
 180 mm



METZENBAUM
FM-318/FM-319
 180 mm



Extremely Sharp Razor Edge / Atraumatic
Extrem Scharfe Spitzer Beck / Atraumatische
Tranchant extrêmement aiguës / Atraumatique
Borde extremadamente afilado / Atraumática
Taglio estremamente affilato / Atraumatica



One side serrated
Eine seite gezahnt
Un côté dentelé
Un lado dentado
Un lato dentellato

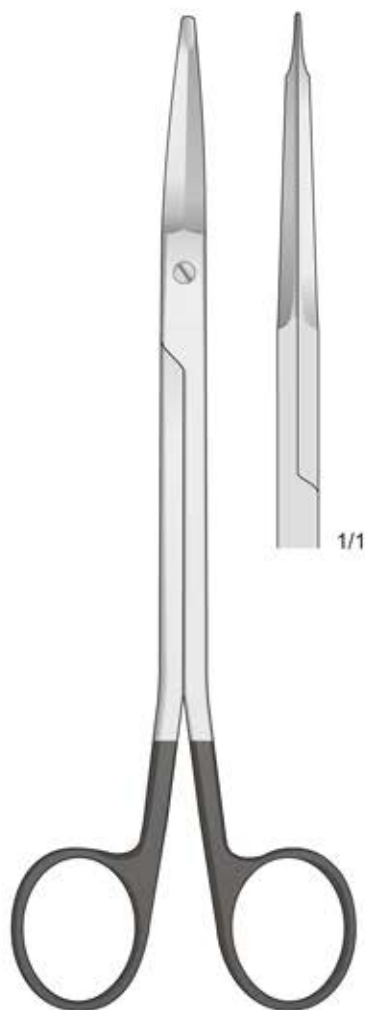

FREEMANN-KAYE
FM-332
180 mm

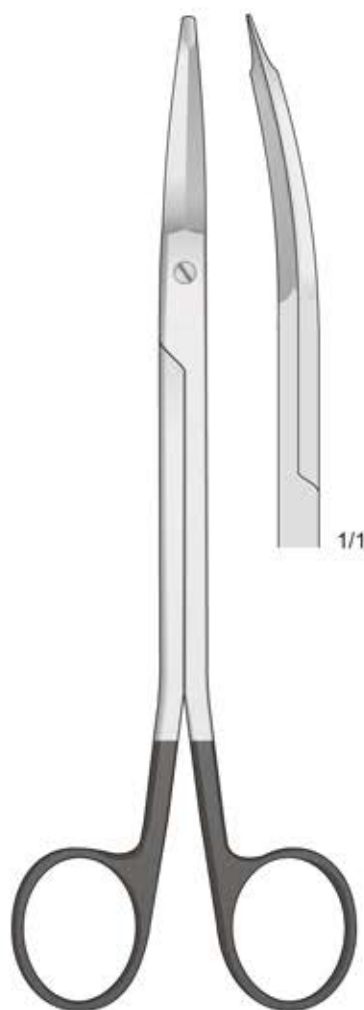

FREEMANN-KAYE
FM-333
180 mm

Vergoldet



Extremely Sharp Razor Edge / Atraumatic
Extrem Scharfe Spitzer Beck / Atraumatische
Tranchant extrêmement aiguisée / Atraumatique
Borde extremadamente afilado / Atraumática
Taglio estremamente affilato / Atraumatica



One side serrated
Eine seite gezahnt
Un côté dentelé
Un lado dentado
Un lato dentellato

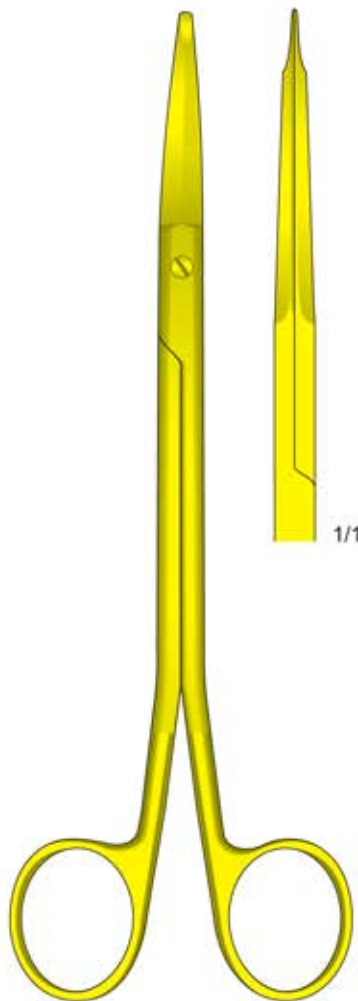

FREEMAN KAYE
FM-332G
180 mm

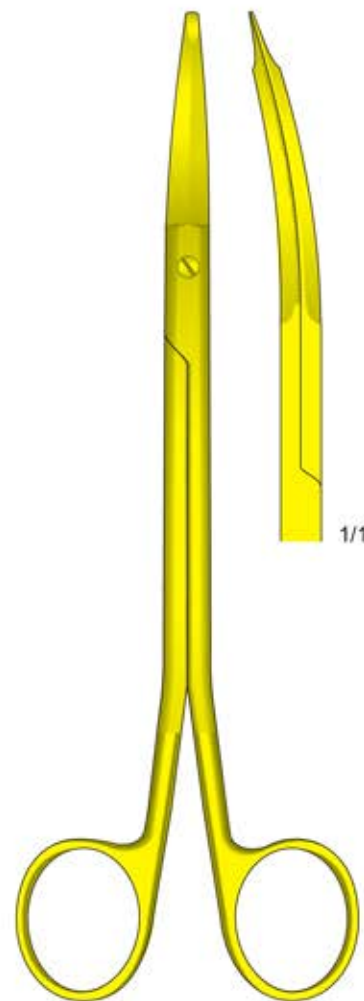

FREEMAN KAYE
FM-333G
180 mm

Vergoldet



Extremely Sharp Razor Edge / Atraumatic
Extrem Scharfe Spitzer Beck / Atraumatische
Tranchant extrêmement aiguïlée / Atraumatique
Borde extremadamente afilado / Atraumática
Taglio estremamente affilato / Atraumatica



One side serrated
Eine seite gezahnt
Un côté dentelé
Un lado dentado
Un lato dentellato

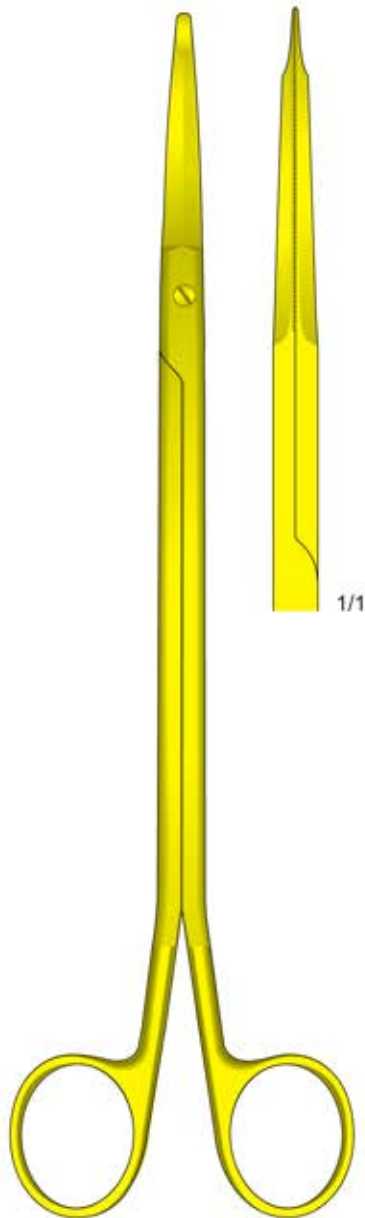

GORNEY
FM-313G
230 mm

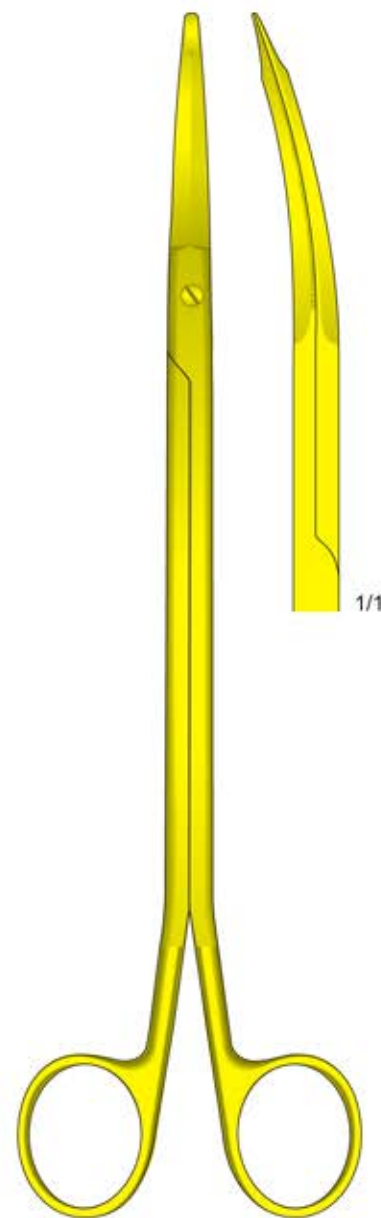

GORNEY
FM-314G
230 mm

Super Cut

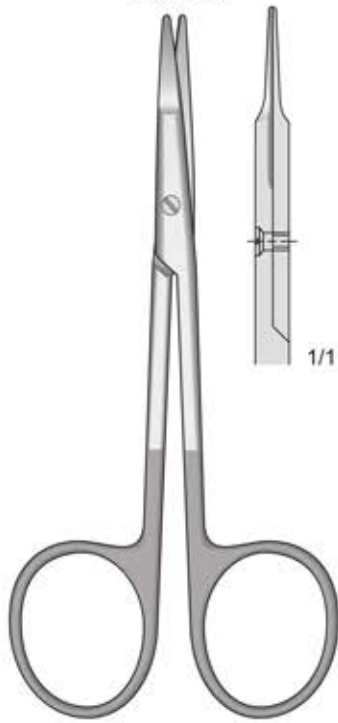

GREENBERG-PAR
FM-294
115 mm

Super Cut

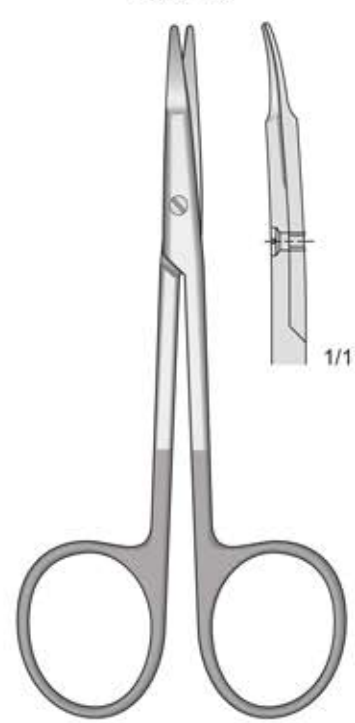

GREENBERG-PAR
FM-295
115 mm



Extremely Sharp Razor Edge / Atraumatic
Extrem Scharfe Spitzer Beck / Atraumatische
Tranchant extrêmement aiguë / Atraumatique
Borde extremadamente afilado / Atraumática
Taglio estremamente affilato / Atraumatica



One side serrated
Eine seite gezahnt
Un côté dentelé
Un lado dentado
Un lato dentellato

Super Cut

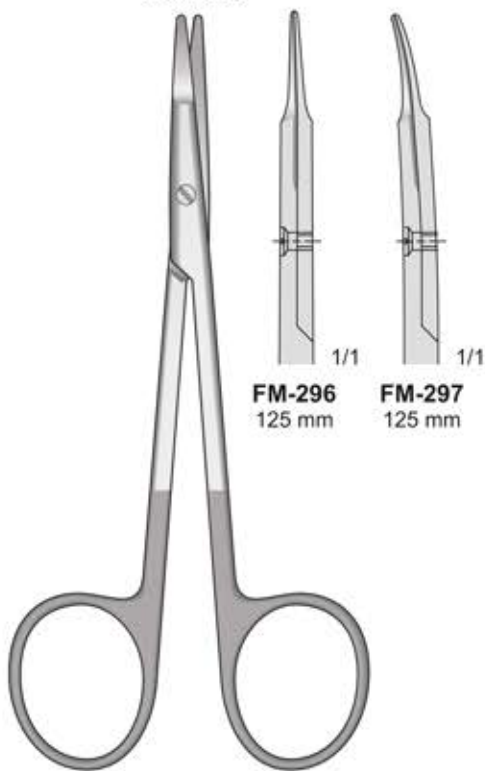

KILNER
FM-296/FM-297
125 mm

Super Cut

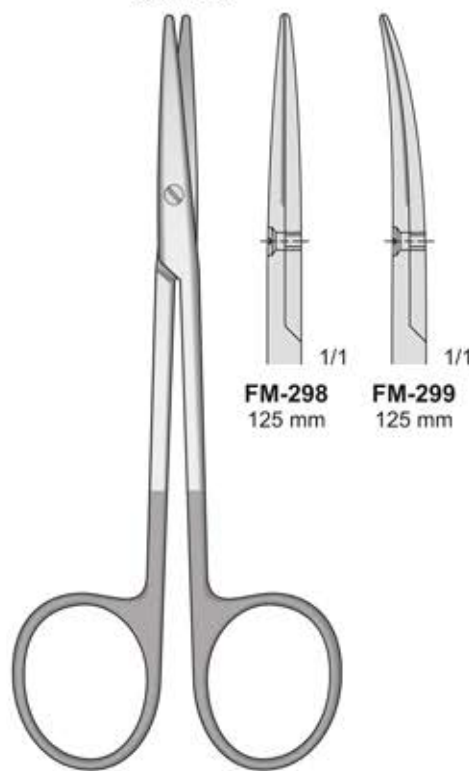

METZENBAUM
FM-298/FM-299
125 mm

Super Cut

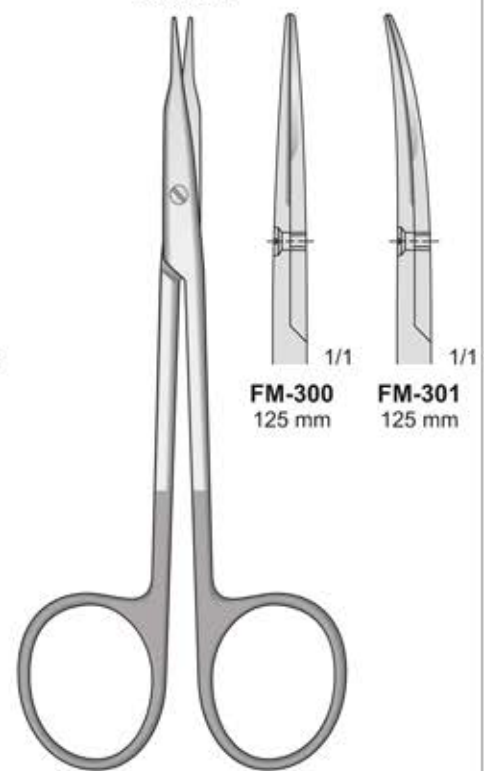

STEVENS
FM-300/FM-301
125 mm

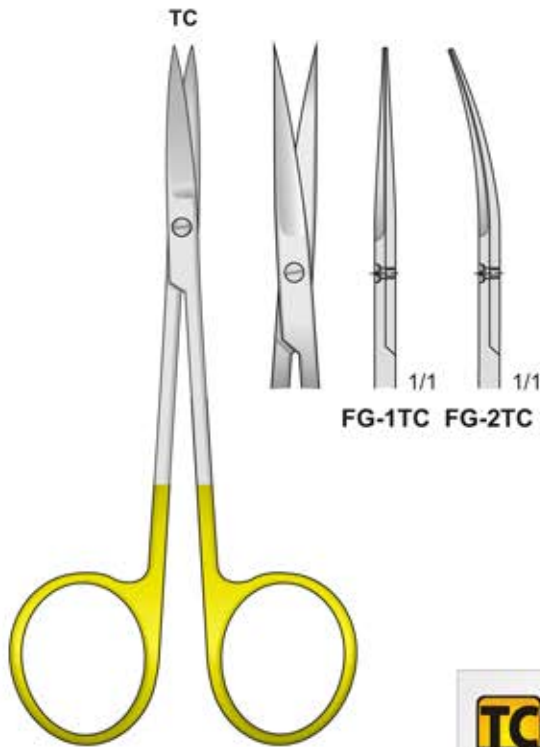

IRIS
FG1-TC/FG2-TC
115 mm

TC
TUNGSTEN
CARBIDE

Tungsten-Carbide Inserts
Mit Hartmetalleinsätzen
Plaquettes en carbure de tungstène
Plaquetas de carburo de tungsteno
Inserti in carburo di tungsteno

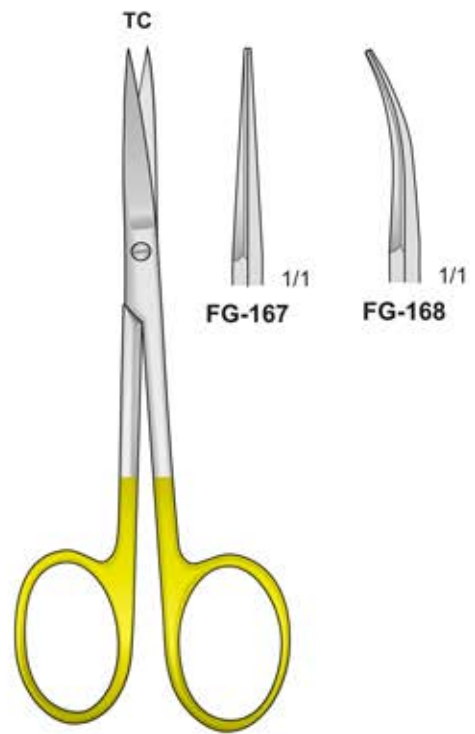

FG-167/FG-168
110 mm

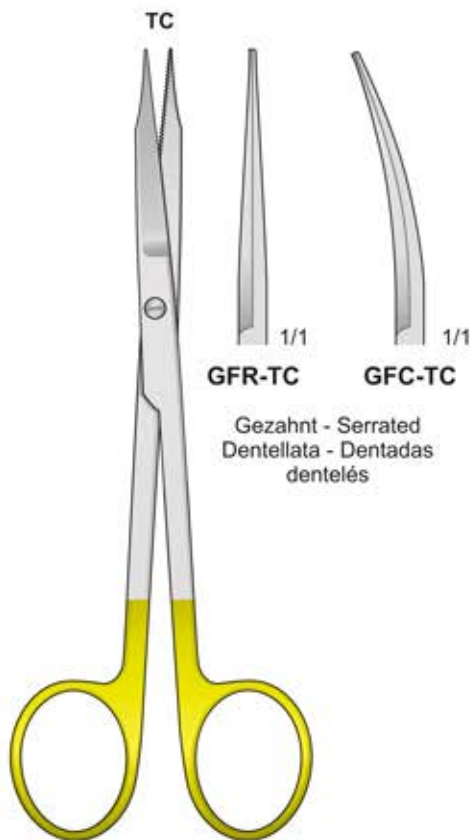

GOLDMAN-FOX
GFC-TC/GFR-TC
135 mm

Gezant - Serrated
Dentellata - Dentadas
dentelés

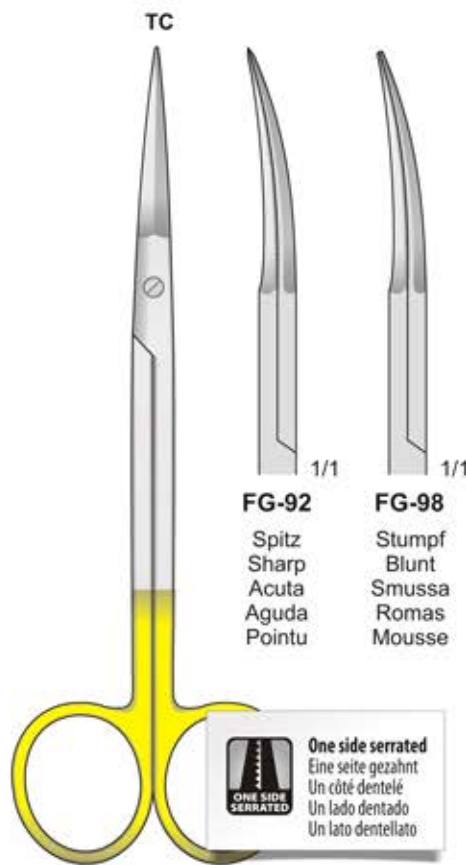

PECK-JOSEPH
FG-92/FG-98
140 mm

**ONE SIDE
SERRATED**

One side serrated
Eine seite gezant
Un côté dentelé
Un lado dentado
Un lato dentellato

FG-92
Spitz
Sharp
Acuta
Aguda
Pointu

FG-98
Stumpf
Blunt
Smussa
Romas
Mousse

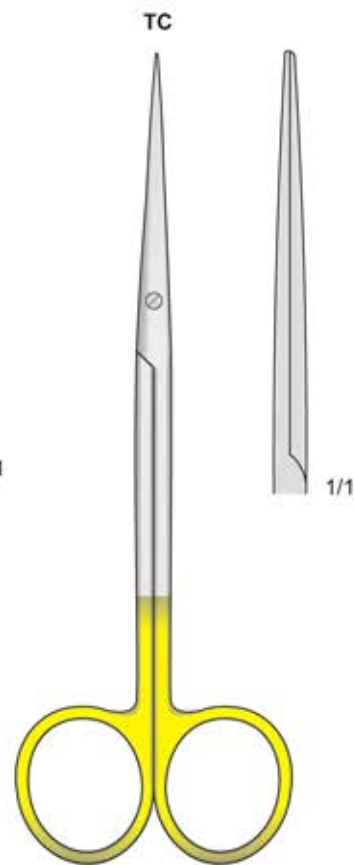

METZENBAUM-FINO
FM-96
140 mm

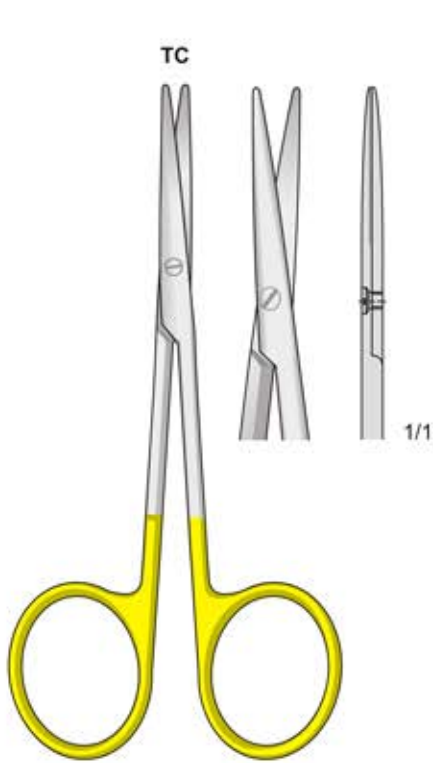

FM-118
115 mm

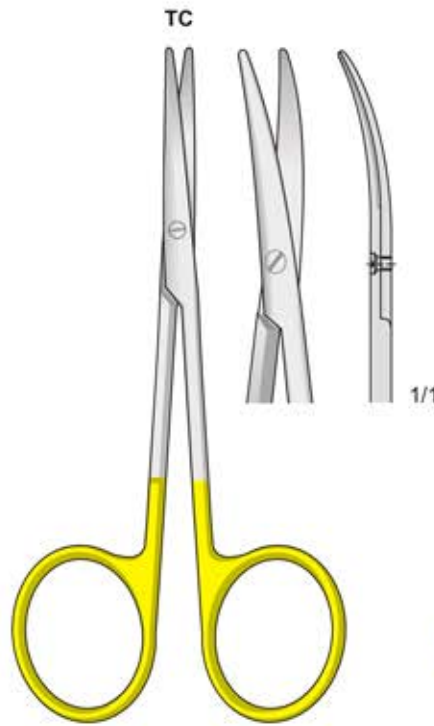

FM-119
115 mm

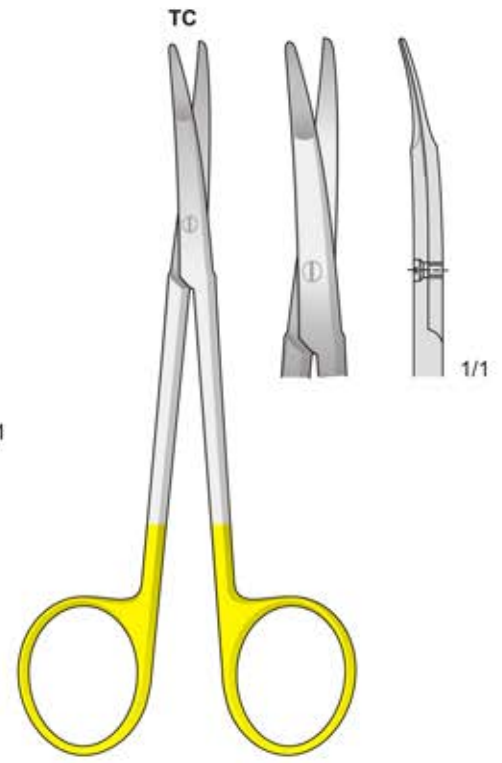

KILNER (RAGNELL)
FM-350
125 mm

TC
Tungsten-Carbide Inserts
Mit Hartmetalleinsätzen
Plaquettes en carbure de tungstène
Plaquetas de carburo de tungsteno
Inserti in carburo di tungsteno

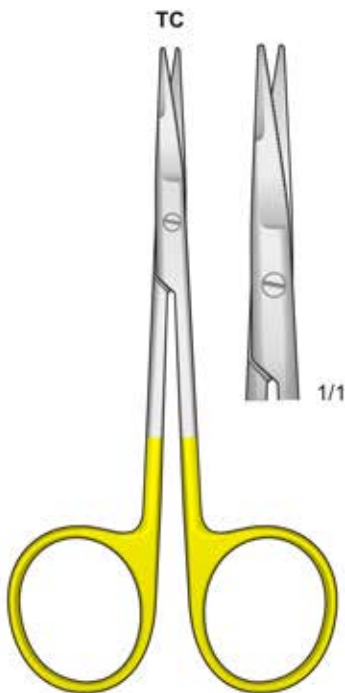

PAR-TYPE
FM-316
115 mm

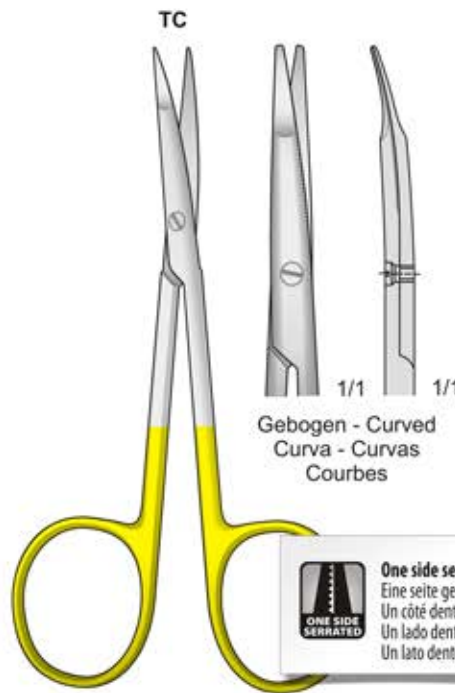

GREENBERG-PAR
FM-317
115 mm

Gebogen - Curved
Curva - Curvas
Courbes

ONE SIDE SERRATED
One side serrated
Eine Seite gezähnt
Un côté dentelé
Un lado dentado
Un lato dentellato

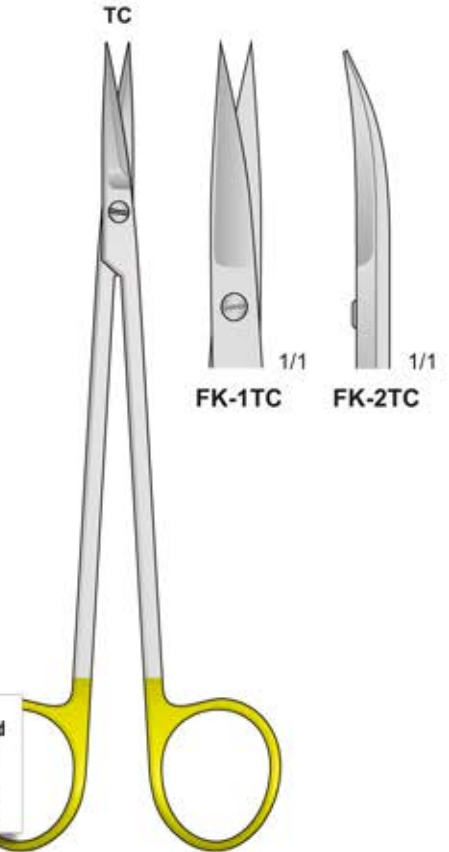

KELLY
FK-1TC/FK-2TC
160 mm

Standard
TC



FM-50
130 mm



FM-51
145 mm



FM-52
165 mm



FM-53
185 mm

FM-50/FM-53



Tungsten-Carbide Inserts
Mit Hartmetalleinsätzen
Plaquettes en carbure de tungstène
Plaquetas de carburo de tungsteno
Inserti in carburo di tungsteno

TC



FM-148
130 mm



FM-149
145 mm



FM-150
165 mm

FM-148/FM-150

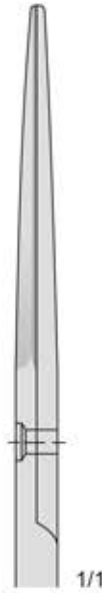
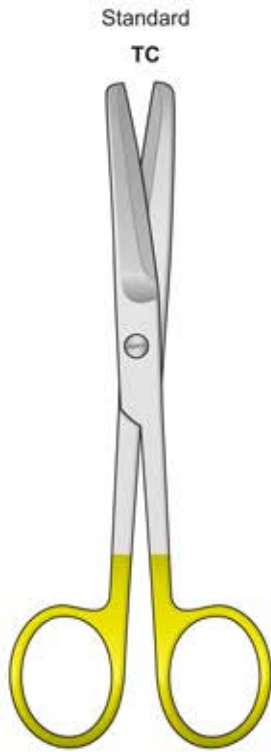

FM-54
130 mm

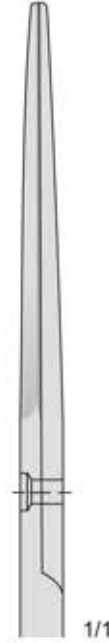

FM-55
145 mm



FM-56
165 mm



FM-57
185 mm

FM-54/FM-57

Tungsten-Carbide Inserts
Mit Hartmetalleinsätzen
Plaquettes en carbure de tungstène
Plaquetas de carburo de tungsteno
Inserti in carburo di tungsteno

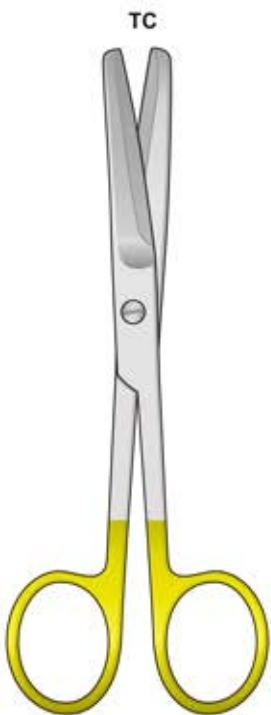

FM-151
130 mm

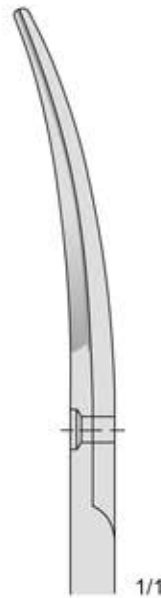

FM-152
145 mm

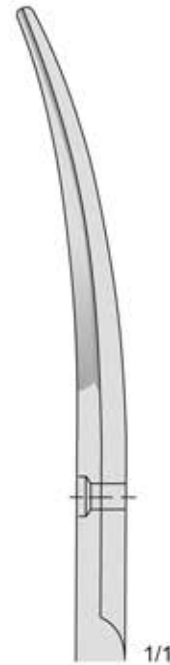

FM-153
165 mm

FM-151/FM-153

Standard
TC



FM-58
130 mm



FM-59
145 mm



FM-60
165 mm



FM-61
185 mm

FM-58/FM-61



Tungsten-Carbide Inserts
Mit Hartmetalleinsätzen
Plaquettes en carbure de tungstène
Plaquetas de carburo de tungsteno
Inserti in carburo di tungsteno

TC



FM-145
130 mm



FM-146
145 mm

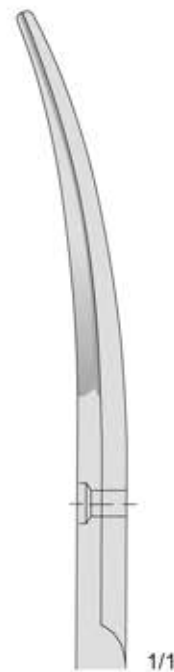

FM-147
165 mm

FM-145/FM-147

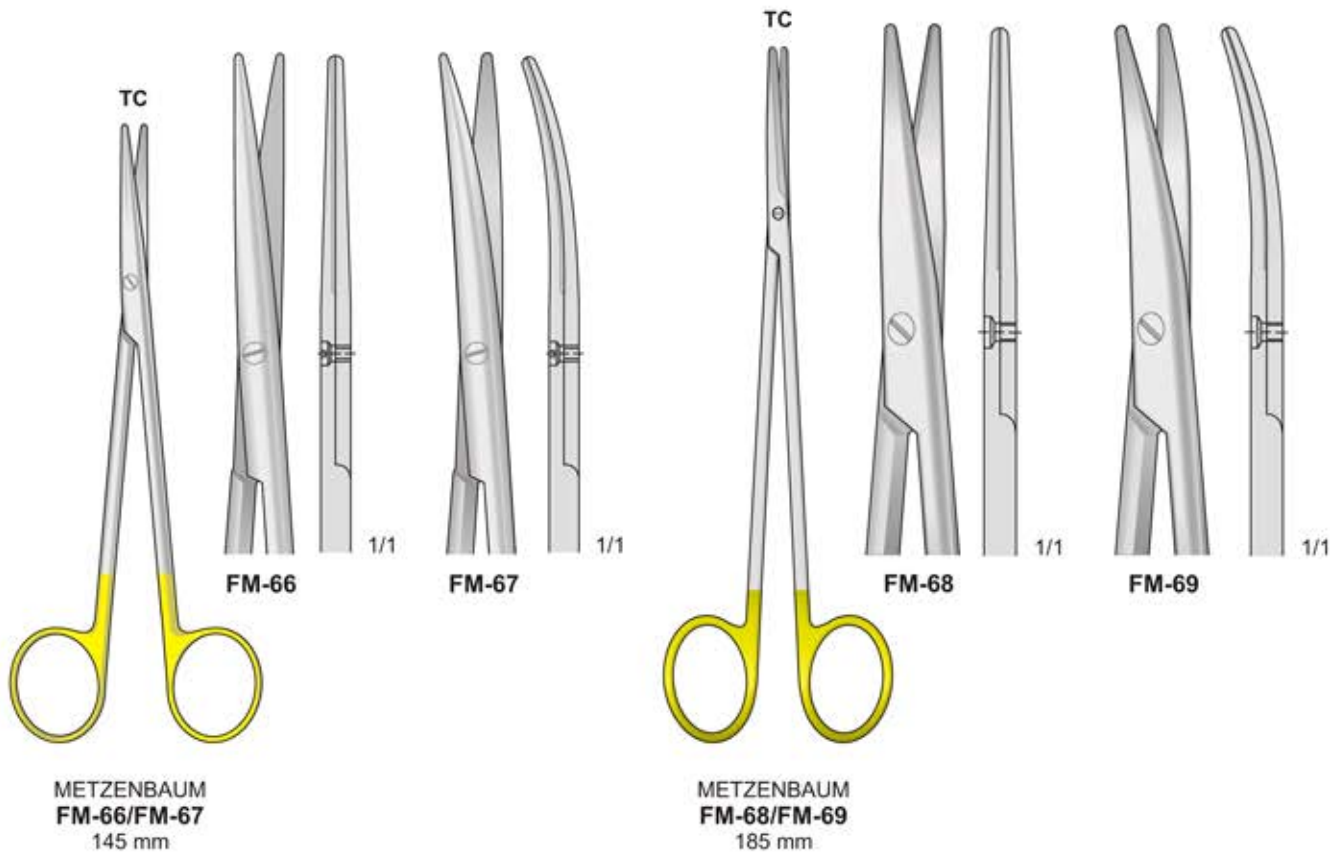

Tungsten-Carbide Inserts
Mit Hartmetalleinsätzen
Plaquettes en carbure de tungstène
Plaquetas de carburo de tungsteno
Inserti in carburo di tungsteno

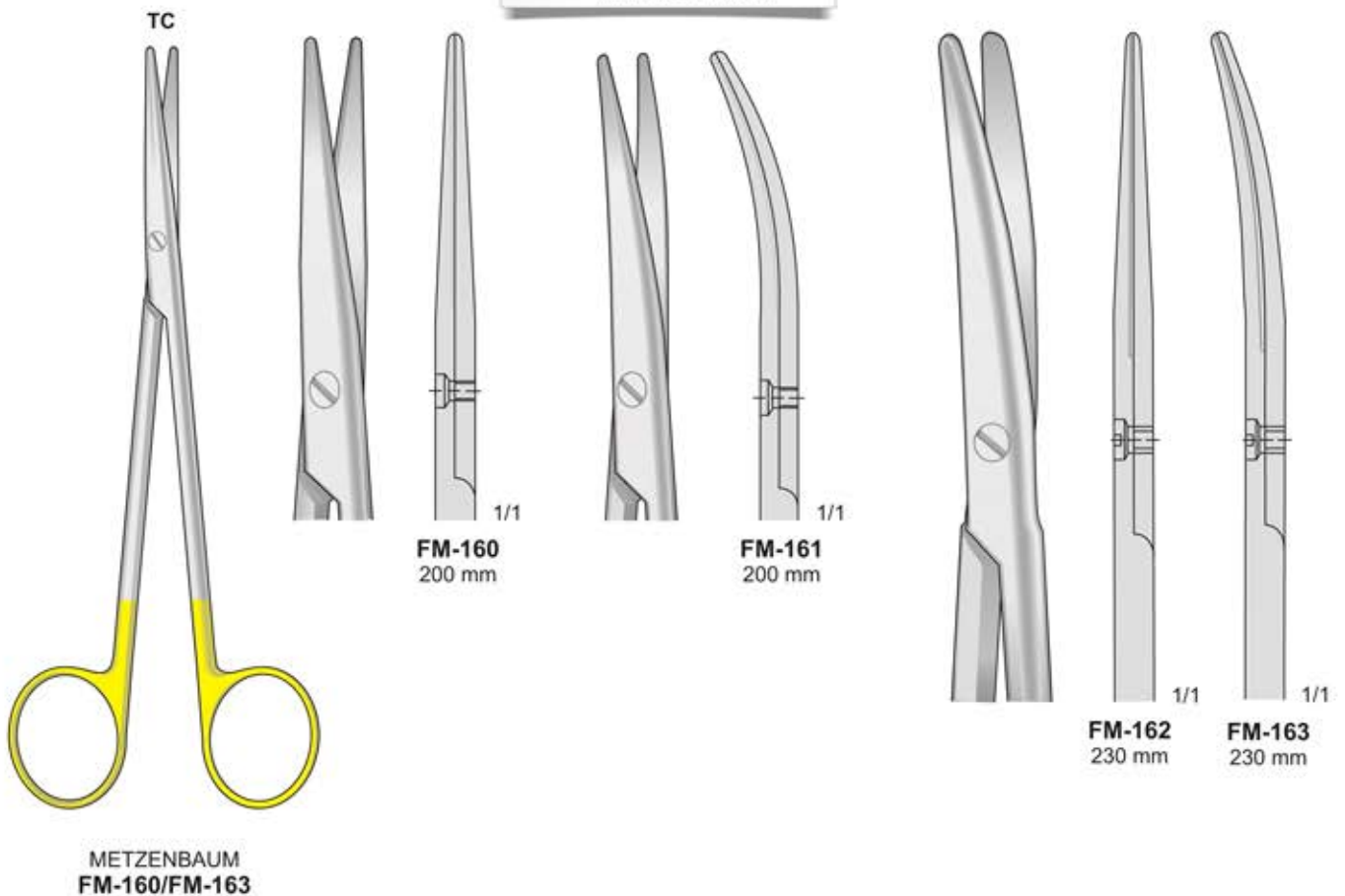

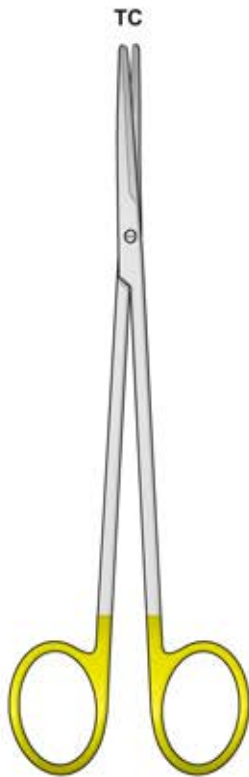

METZENBAUM-FINO
FM-201/FM-205



FM-201
140 mm

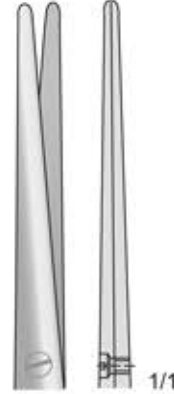

FM-203
180 mm

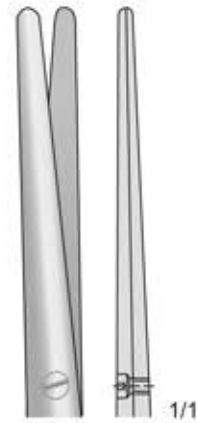

FM-205
200 mm

Tungsten-Carbide Inserts
Mit Hartmetalleinsätzen
Plaquettes en carbure de tungstène
Plaquetas de carburo de tungsteno
Inserti in carburo di tungsteno

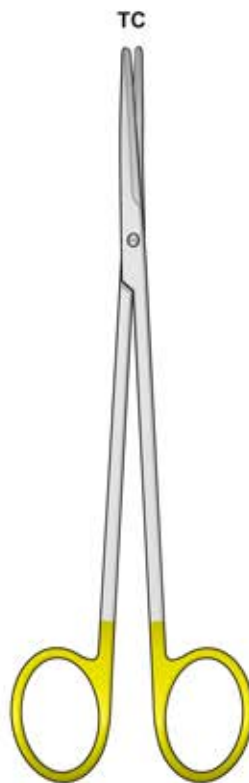

METZENBAUM-FINO
FM-207/FM-211

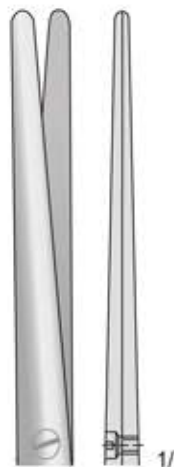

FM-207
230 mm

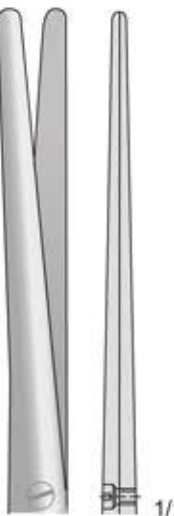

FM-209
250 mm

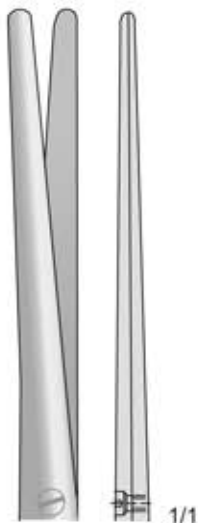

FM-211
280 mm

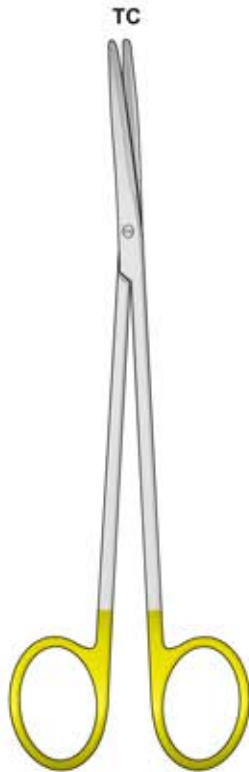

METZENBAUM-FINO
FM-202/FM-206

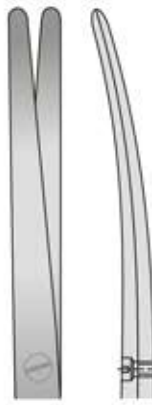

FM-202
140 mm



FM-204
180 mm

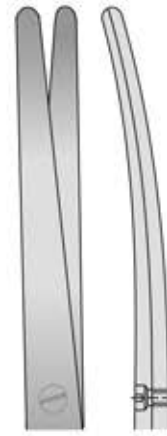

FM-206
200 mm

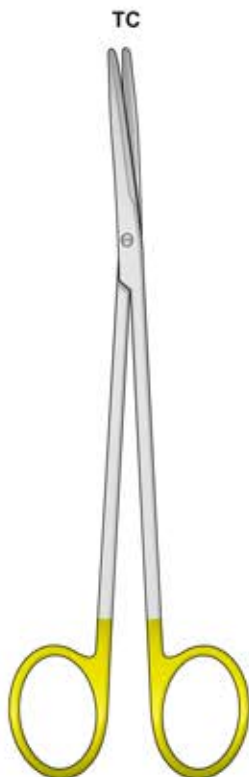

METZENBAUM-FINO
FM-208/FM-212

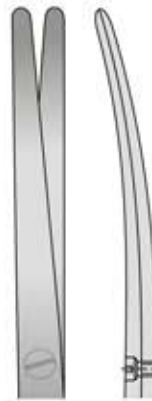

FM-208
230 mm

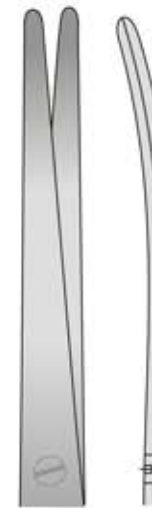

FM-210
250 mm

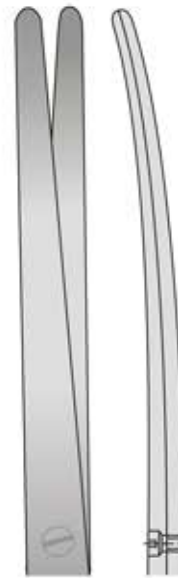

FM-212
280 mm

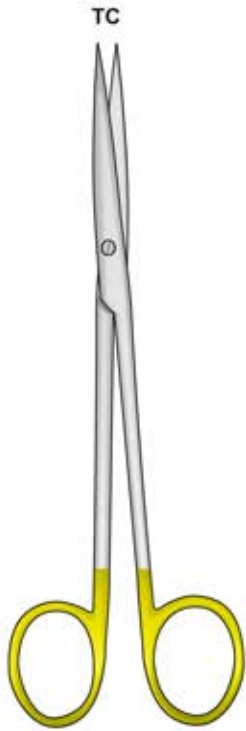

METZENBAUM-FINO
FM-96/FM-99

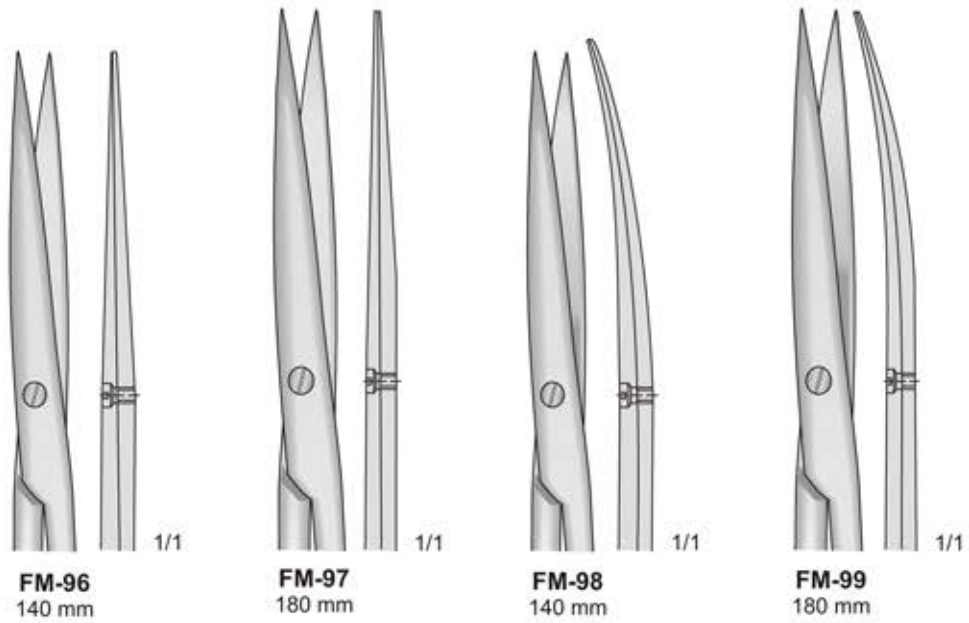

FM-96
140 mm

FM-97
180 mm

FM-98
140 mm

FM-99
180 mm

TC
Tungsten-Carbide Inserts
Mit Hartmetalleinsätzen
Plaquettes en carbure de tungstène
Plaquetas de carburo de tungsteno
Inserti in carburo di tungsteno

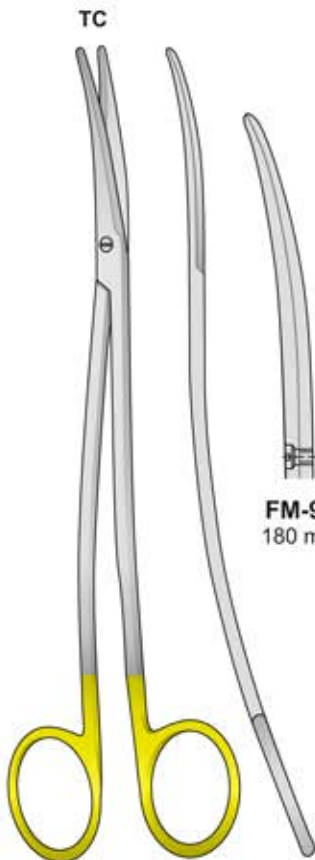

METZENBAUM-FINO
FM-90/FM-94

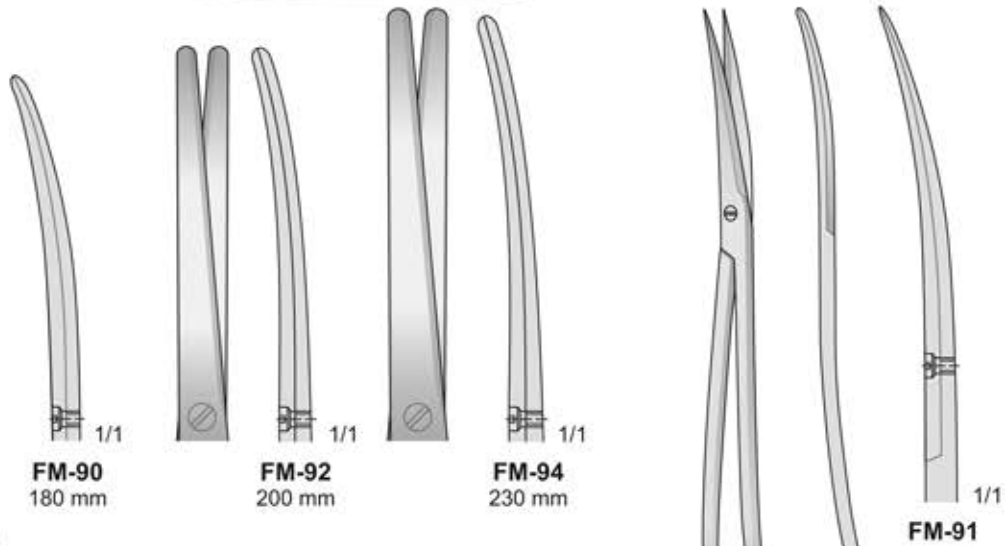

FM-90
180 mm

FM-92
200 mm

FM-94
230 mm

FM-91

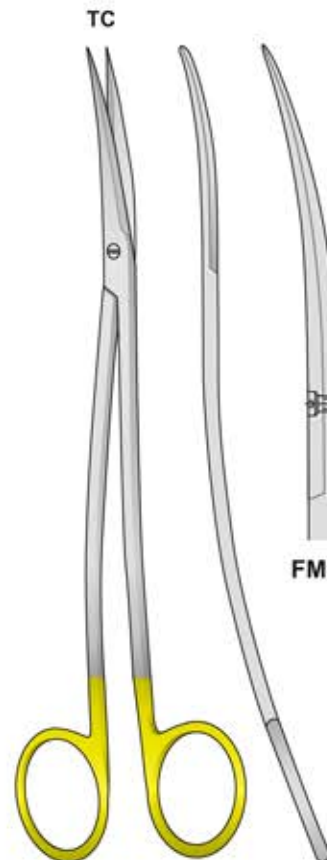

METZENBAUM-FINO
FM-91
180 mm

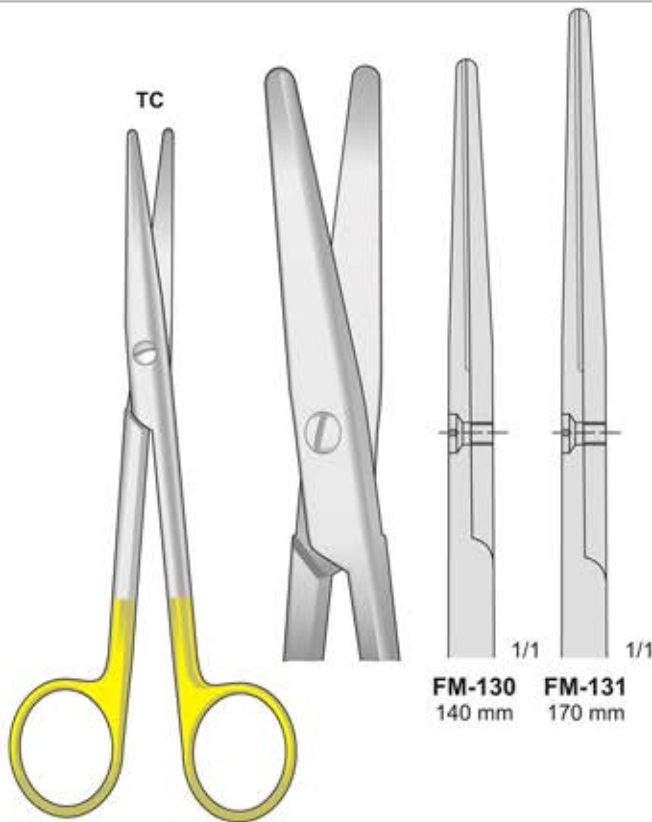

MAYO-STILLE
FM-130/FM-131

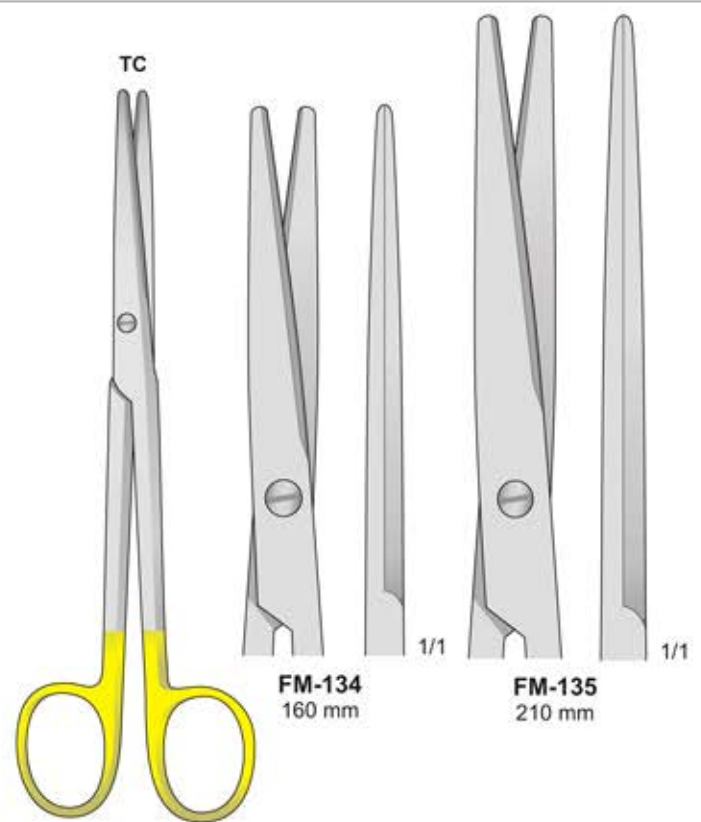

LEXER
FM-134/FM-135



Tungsten-Carbide Inserts
Mit Hartmetalleinsätzen
Plaquettes en carbure de tungstène
Plaquetas de carburo de tungsteno
Inserti in carburo di tungsteno

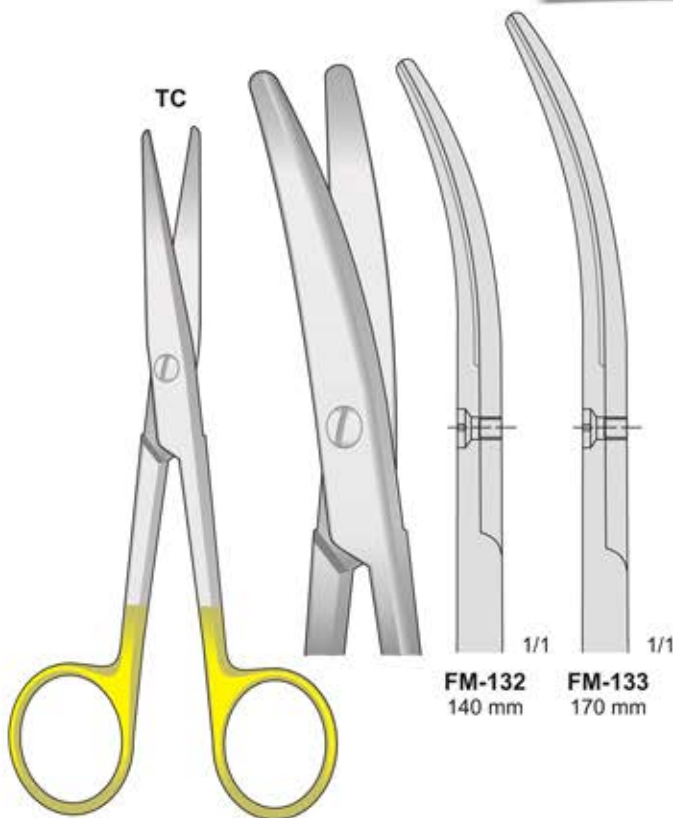

MAYO-STILLE
FM-132/FM-133

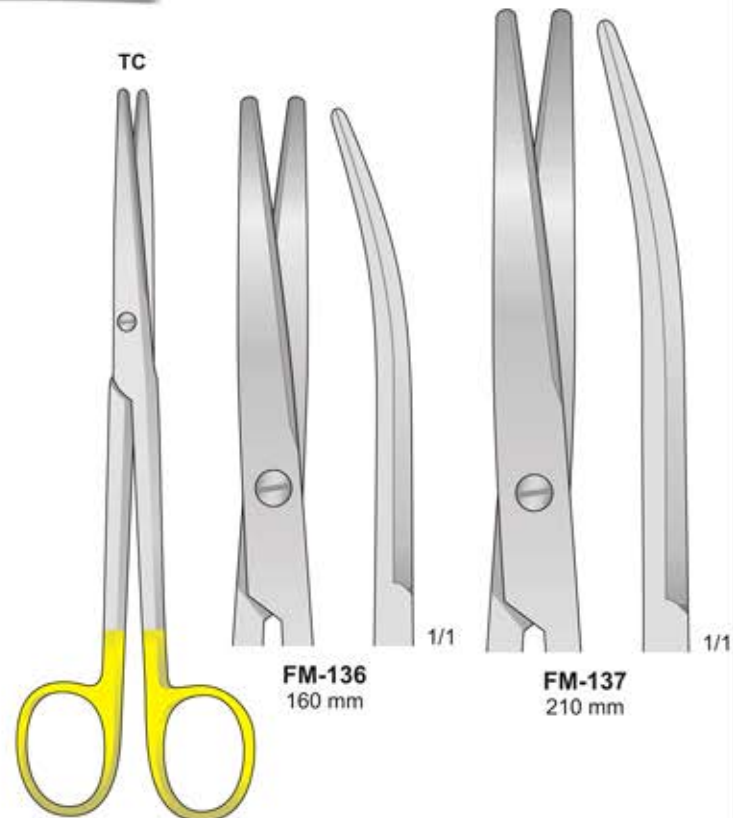

LEXER
FM-136/FM-137

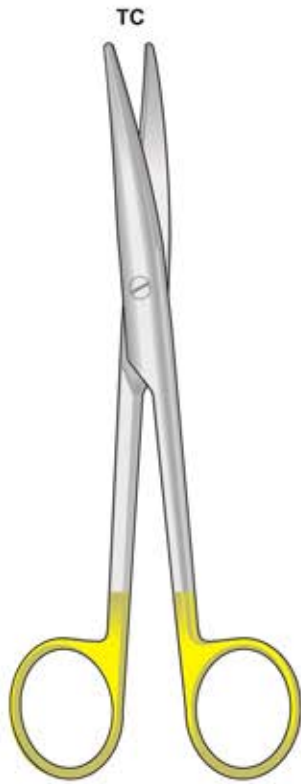

MAYO-LEXER
FM-139
165 mm

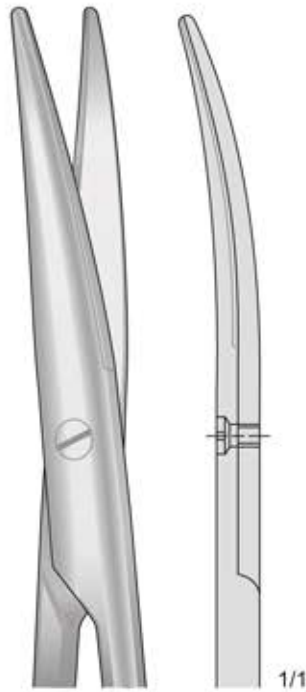

FM-139
165 mm

TC
TUNGSTEN
CARBIDE

Tungsten-Carbide Inserts
Mit Hartmetalleinsätzen
Plaquettes en carbure de tungstène
Plaquetas de carburo de tungsteno
Inserti in carburo di tungsteno



MAYO
FM-140/FM-143

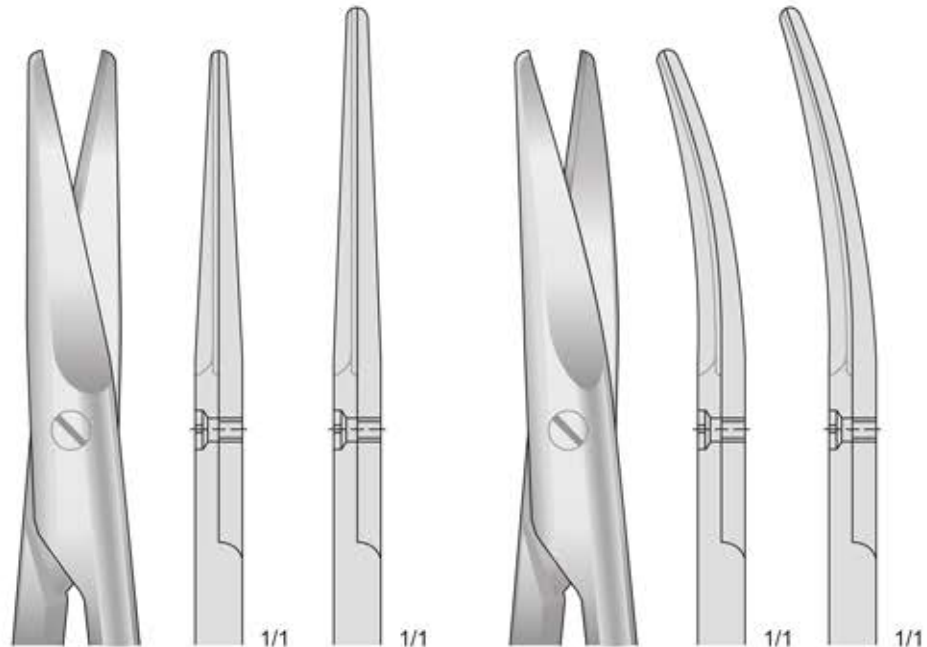

FM-140
140 mm

FM-142
170 mm

FM-141
140 mm

FM-143
170 mm

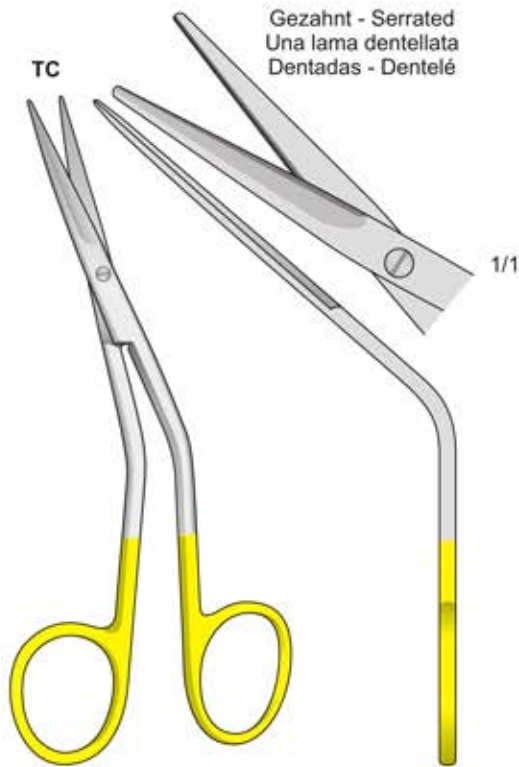

FOMON
FG-165
135 mm

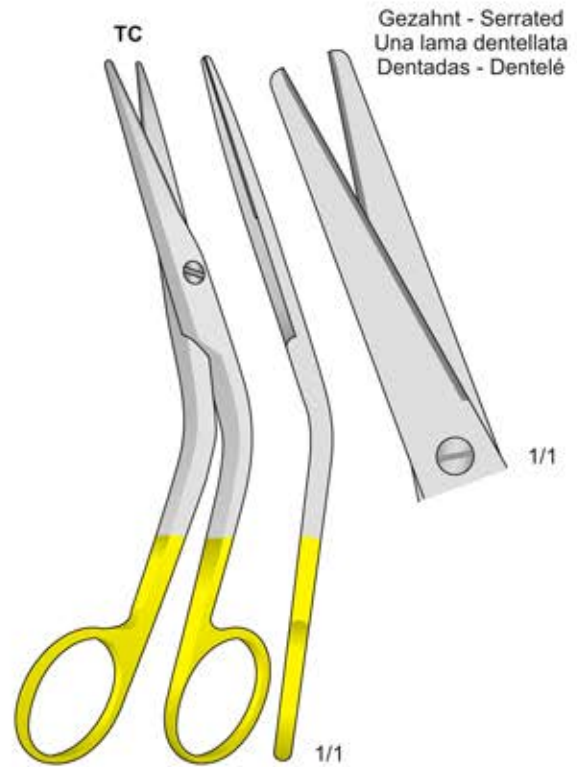

COTTLE
FG-166
160 mm

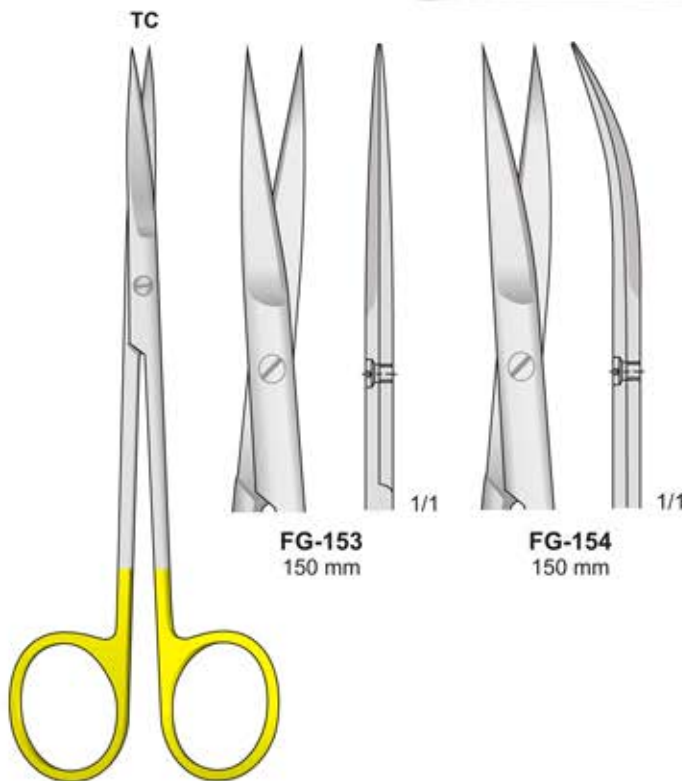

JOSEPH
FG-153/FG-154
150 mm

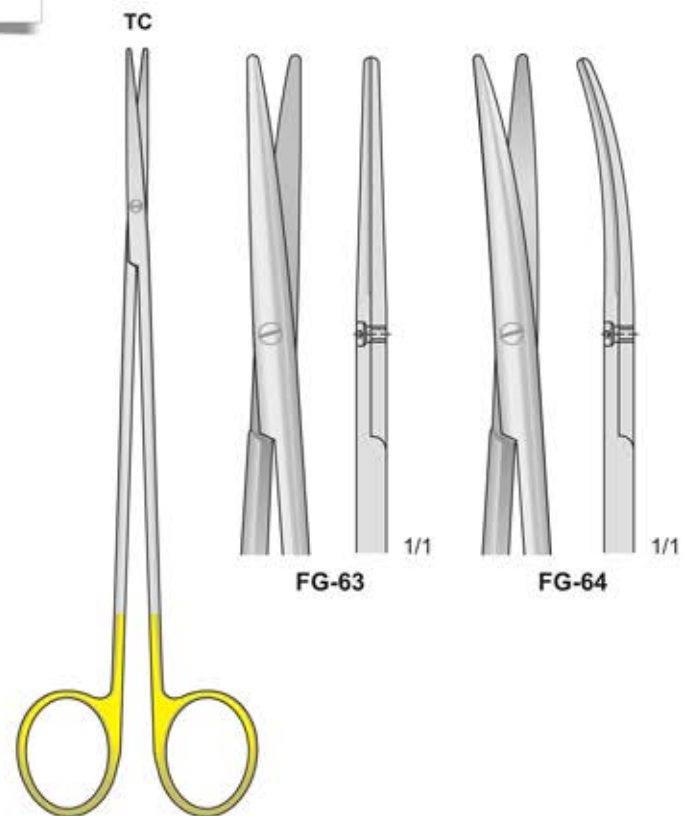

TOENNIS-ADSON
FG-63/FG-64
180 mm



Tungsten-Carbide Inserts
 Mit Hartmetalleinsätzen
 Plaquettes en carbure de tungstène
 Plaquetas de carburo de tungsteno
 Inserti in carburo di tungsteno



One side serrated
 Eine seite gezahnt
 Un côté dentelé
 Un lado dentado
 Un lato dentellato

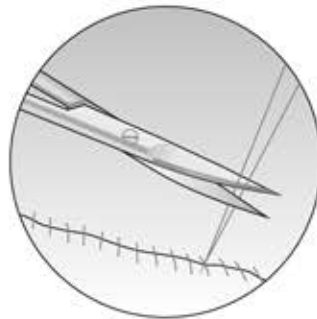

Wellenschliff
 TC

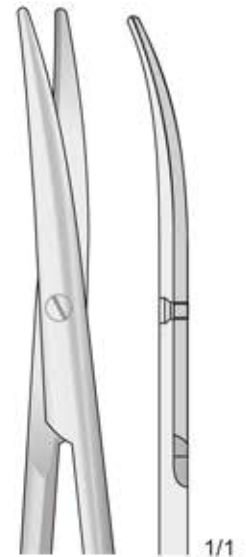

1/1

Wellenschliff
 TC

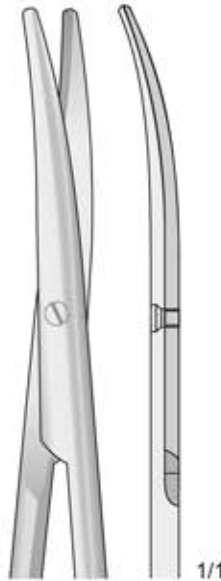

1/1

Wellenschliff
 TC



1/1

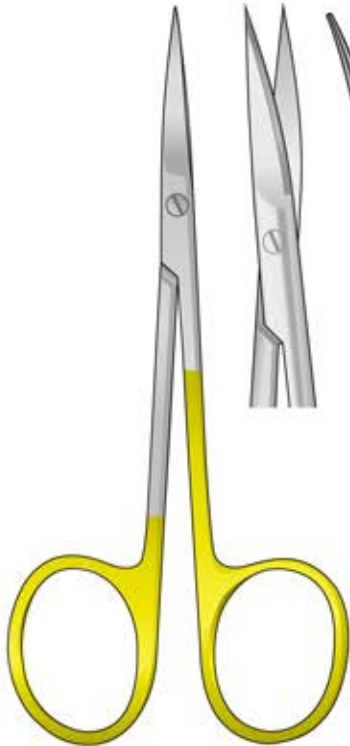

IRIS
FM-100
 110 mm

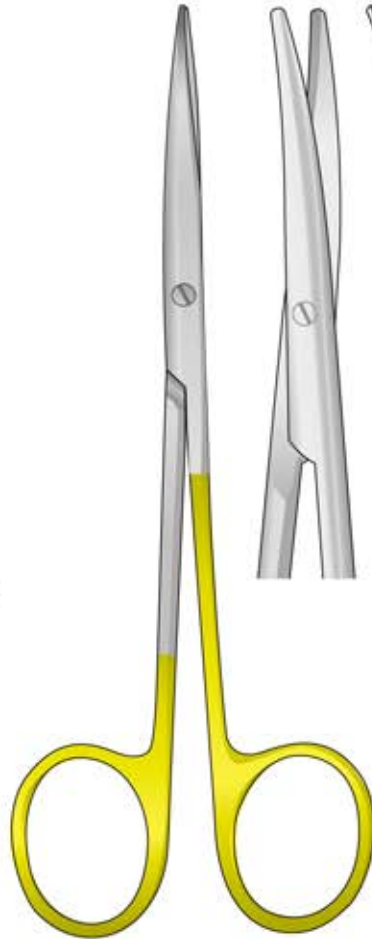

METZENBAUM
FM-102
 145 mm

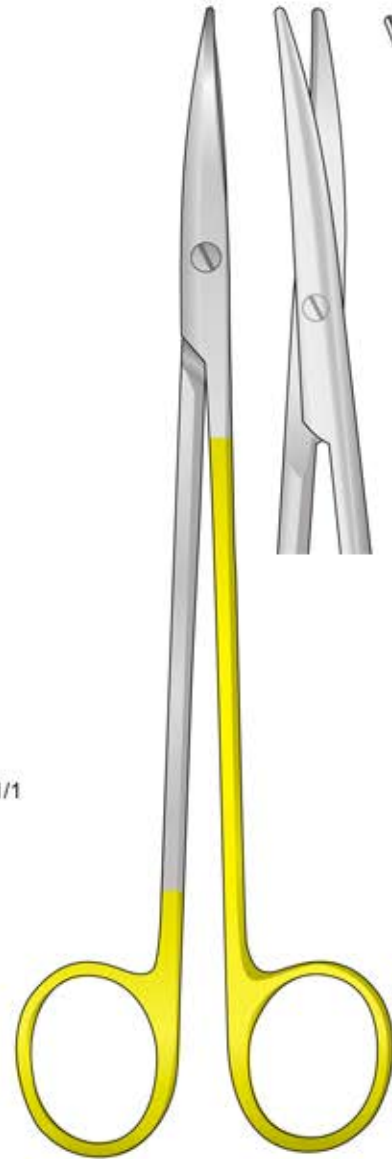

METZENBAUM
FM-104
 185 mm



Tungsten-Carbide Inserts
 Mit Hartmetalleinsätzen
 Plaquettes en carbure de tungstène
 Plaquetas de carburo de tungsteno
 Inserti in carburo di tungsteno



One side serrated
 Eine seite gezahnt
 Un côté dentelé
 Un lado dentado
 Un lato dentellato

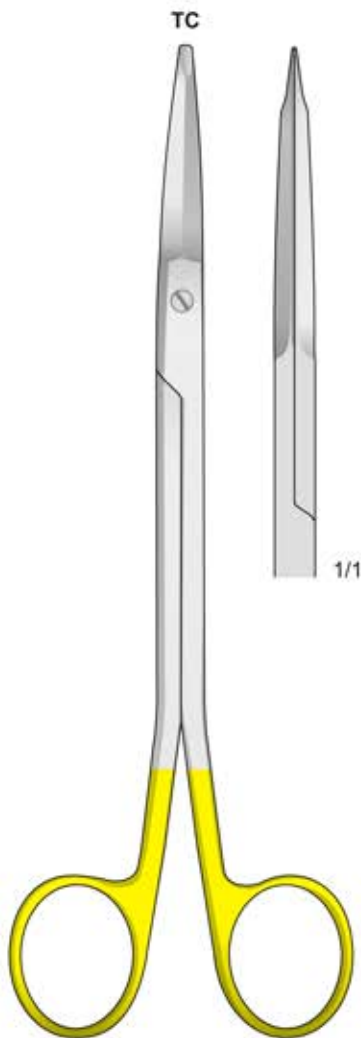

FREEMAN-GORNEY
FM-311
 180 mm

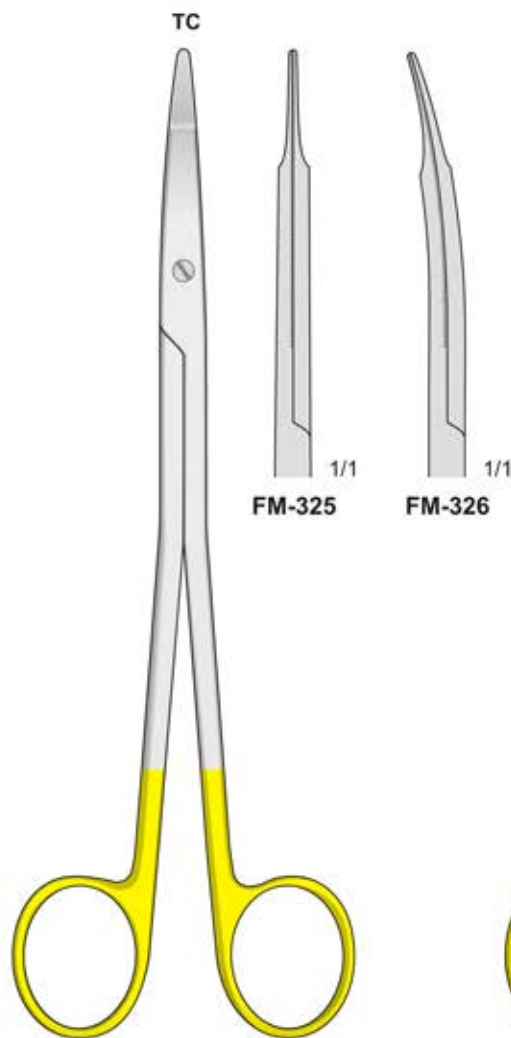

FREEMAN
FM-325/FM-326
 180 mm

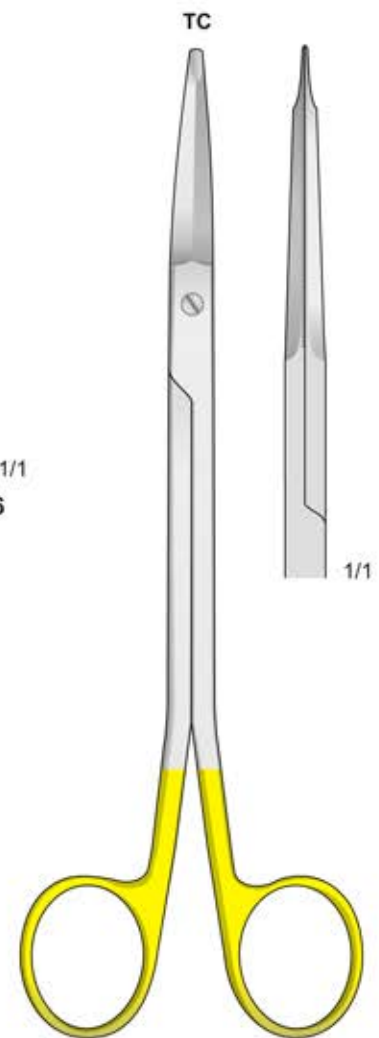

FREEMAN-KAYE
FM-334
 180 mm



Tungsten-Carbide Inserts
 Mit Hartmetalleinsätzen
 Plaquettes en carbure de tungstène
 Plaquetas de carburo de tungsteno
 Inserti in carburo di tungsteno



One side serrated
 Eine seite gezahnt
 Un côté dentelé
 Un lato dentado
 Un lato dentellato

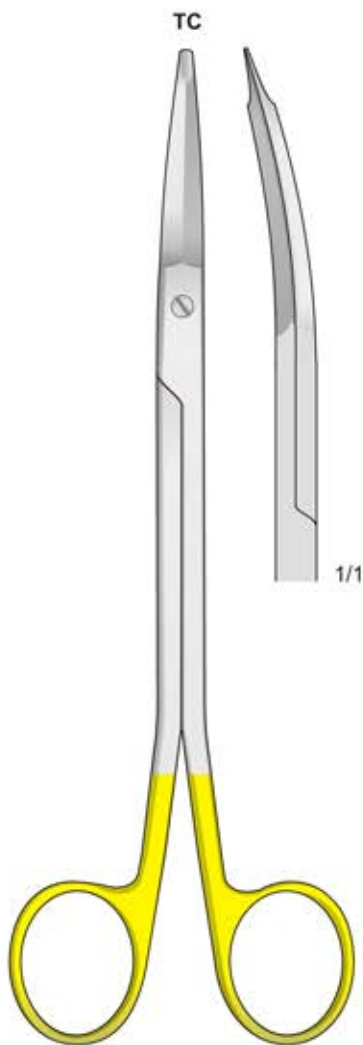

FREEMAN-KAYE
FM-335
 180 mm

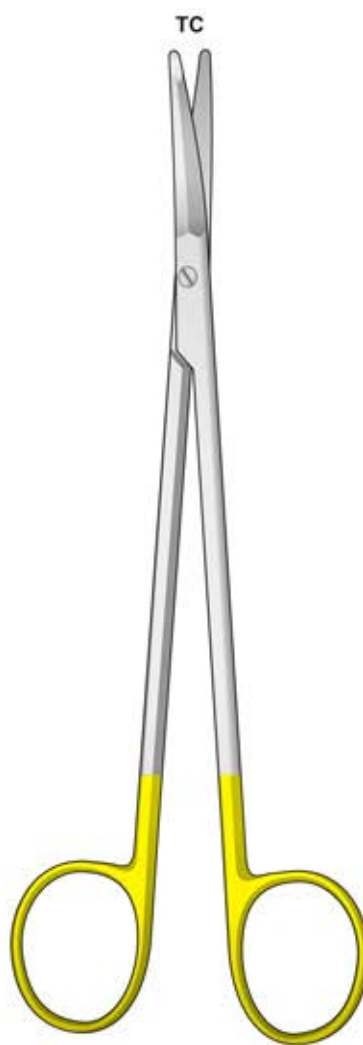

FACE LIFT
FM-338
 180 mm

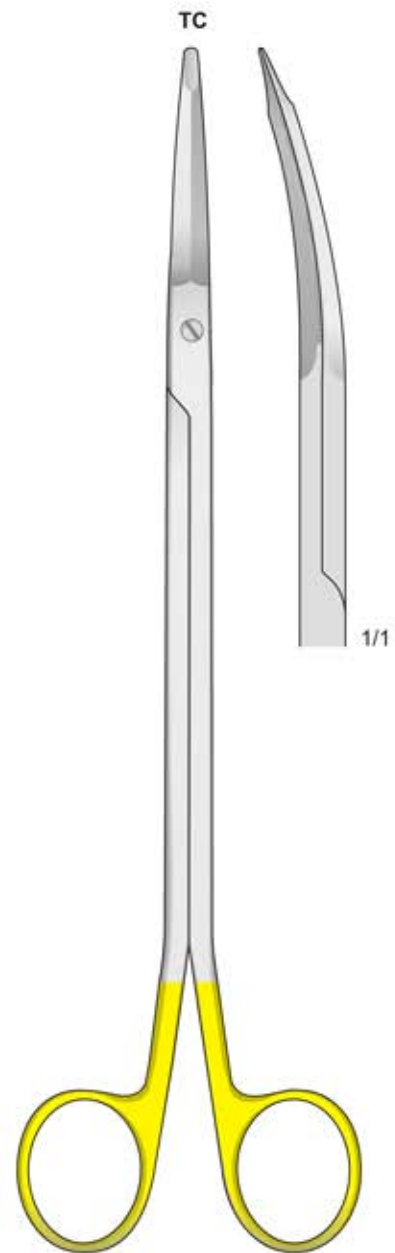

GORNEY
FM-312
 230 mm



Tungsten-Carbide Inserts
 Mit Hartmetalleinsätzen
 Plaquettes en carbure de tungstène
 Plaquetas de carburo de tungsteno
 Inserti in carburo di tungsteno



One side serrated
 Eine seite gezahnt
 Un côté dentelé
 Un lato dentado
 Un lato dentellato

S-Förming Gebogen
 S-Shaped
 Forma S
 Informa a S
 Forme S

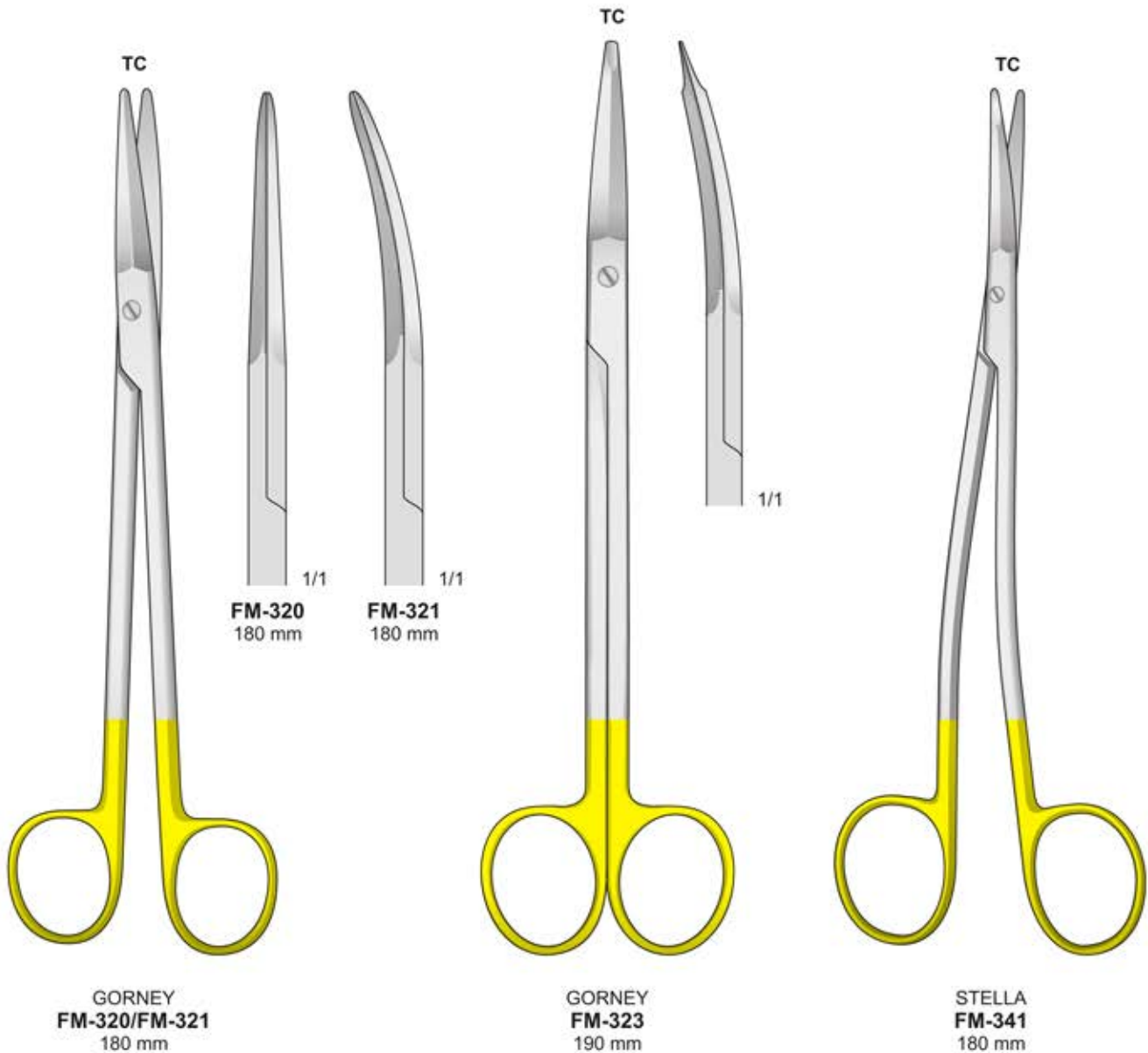

GORNEY
FM-320/FM-321
 180 mm

GORNEY
FM-323
 190 mm

STELLA
FM-341
 180 mm



Tungsten-Carbide Inserts
 Mit Hartmetalleinsätzen
 Plaquettes en carbure de tungstène
 Plaquetas de carburo de tungsteno
 Inserti in carburo di tungsteno



One side serrated
 Eine seite gezahnt
 Un côté dentelé
 Un lado dentado
 Un lato dentellato

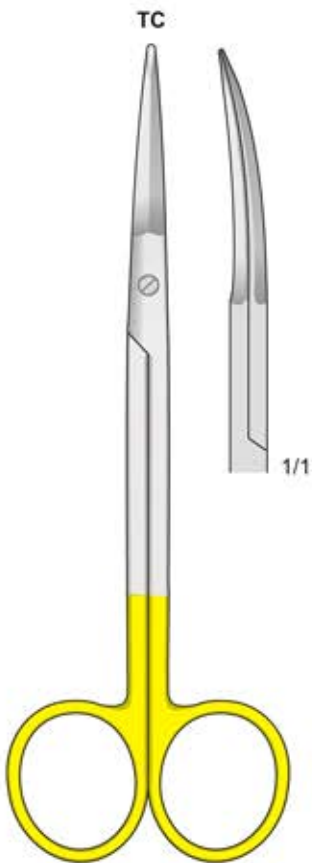

GREGORY
FM-339
 140 mm

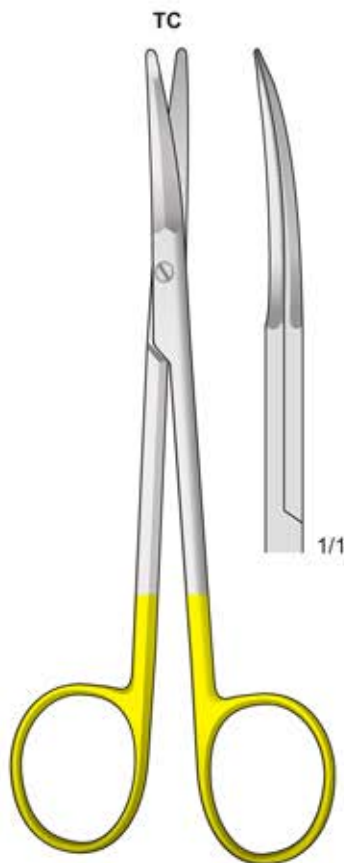

FACE LIFT
FM-340
 150 mm



FACE LIFT
FM-342
 140 mm



Tungsten-Carbide Inserts
 Mit Hartmetalleinsätzen
 Plaquettes en carbure de tungstène
 Plaquetas de carburo de tungsteno
 Inserti in carburo di tungsteno



One side serrated
 Eine seite gezahnt
 Un côté dentelé
 Un lado dentado
 Un lato dentellato



Extremely Sharp Razor Edge / Atraumatic
 Extrem Scharfe Spitzer Beck / Atraumatische
 Tranchant extrêmement aiguisée / Atraumatique
 Borde extremadamente afilado / Atraumática
 Taglio estremamente affilato / Atraumatica

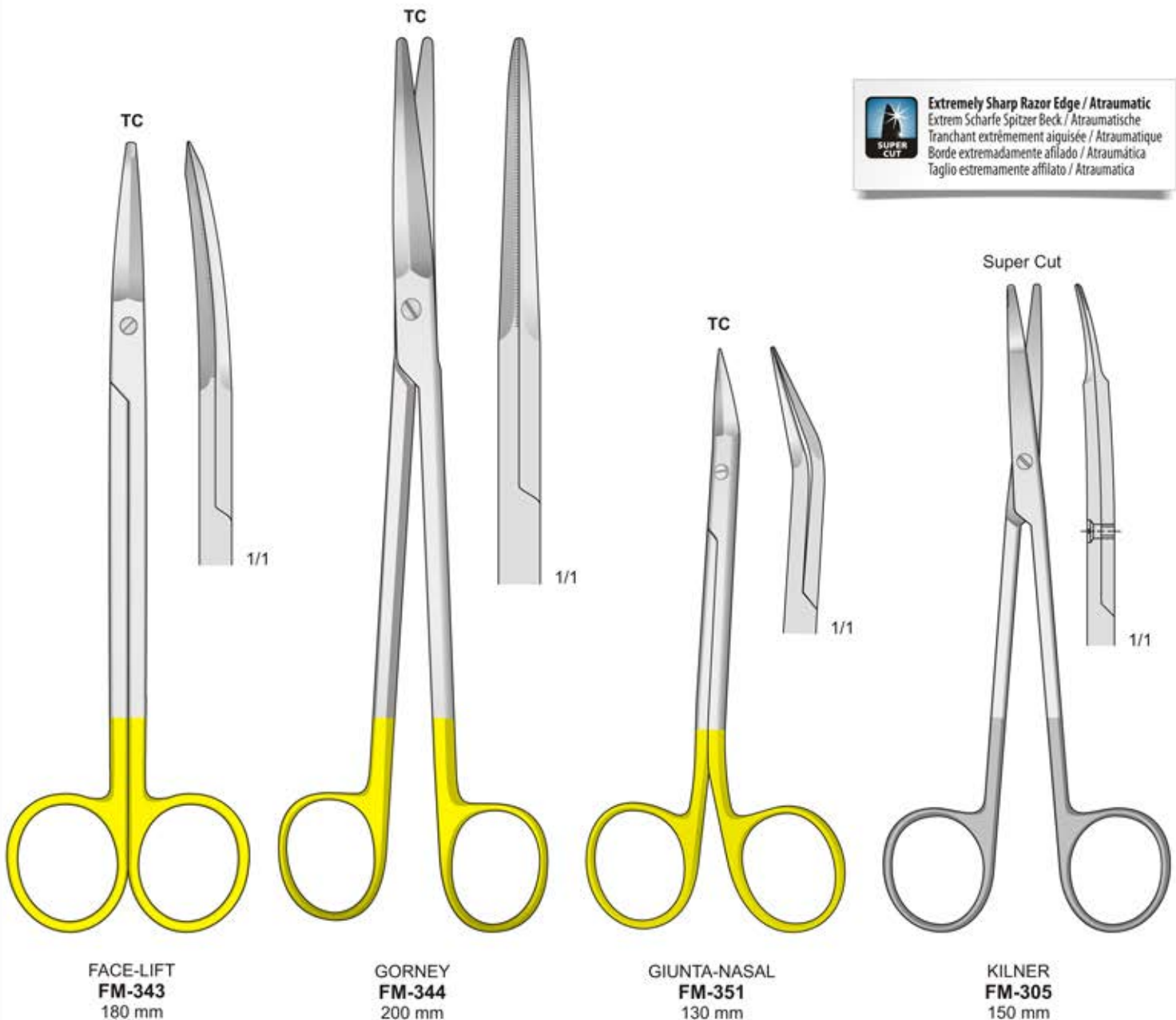

FACE-LIFT
FM-343
 180 mm

GORNEY
FM-344
 200 mm

GIUNTA-NASAL
FM-351
 130 mm

KILNER
FM-305
 150 mm



Extremely Sharp Razor Edge / Atraumatic
 Extrem Scharfe Spitzer Beck / Atraumatische
 Tranchant extrêmement aiguisée / Atraumatique
 Borde extremadamente afilado / Atraumática
 Taglio estremamente affilato / Atraumatica



Tungsten-Carbide Inserts
 Mit Hartmetalleinsätzen
 Plaquettes en carbure de tungstène
 Plaquetas de carburo de tungsteno
 Inserti in carburo di tungsteno



One side serrated
 Eine seite gezahnt
 Un côté dentelé
 Un lado dentado
 Un lato dentellato

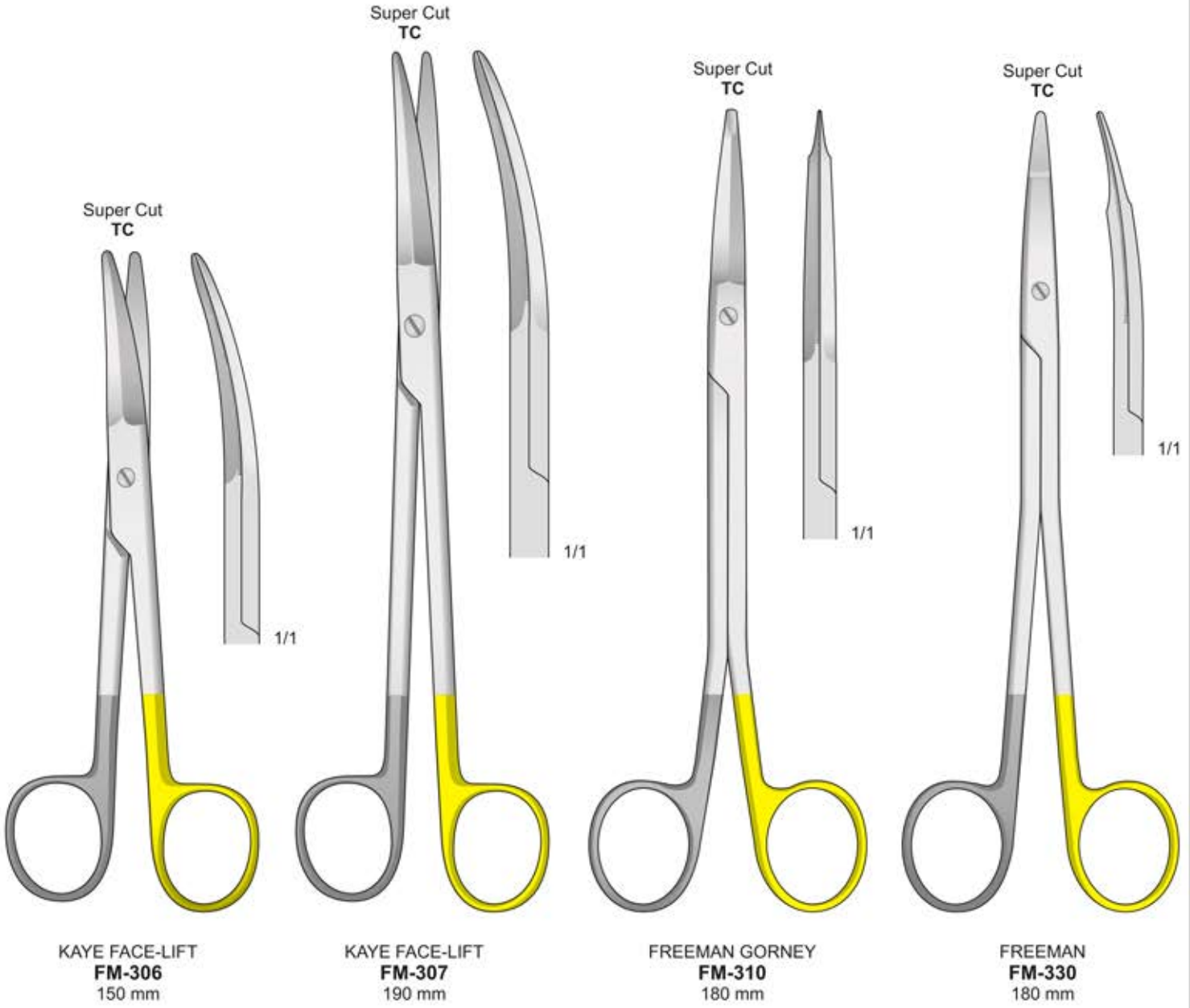

KAYE FACE-LIFT
FM-306
 150 mm

KAYE FACE-LIFT
FM-307
 190 mm

FREEMAN GORNEY
FM-310
 180 mm

FREEMAN
FM-330
 180 mm



Extremely Sharp Razor Edge / Atraumatic
 Extrem Scharfe Spitzer Beck / Atraumatische
 Tranchant extrêmement aiguisée / Atraumatique
 Borde extremadamente afilado / Atraumática
 Taglio estremamente affilato / Atraumatica



Tungsten-Carbide Inserts
 Mit Hartmetalleinsätzen
 Plaquettes en carbure de tungstène
 Plaquetas de carburo de tungsteno
 Inserti in carburo di tungsteno



One side serrated
 Eine seite gezahnt
 Un côté dentelé
 Un lado dentado
 Un lato dentellato

Super Cut
TC

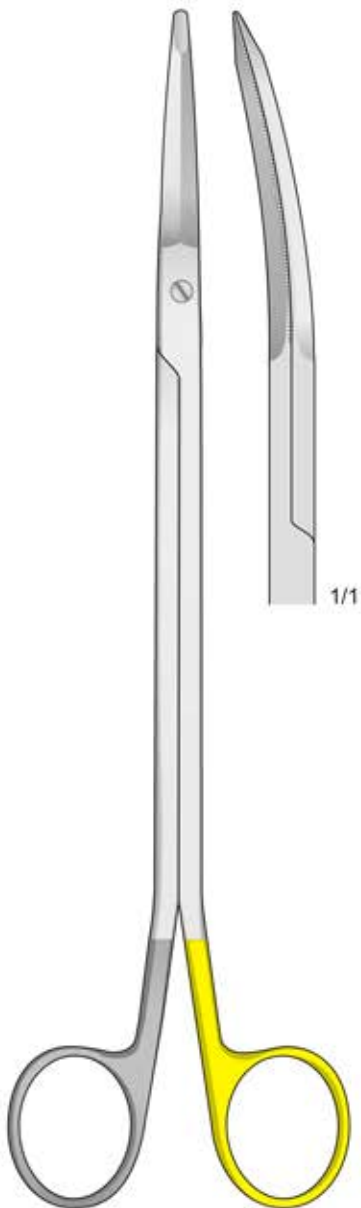

GORNEY
FM-331
230 mm

Super Cut

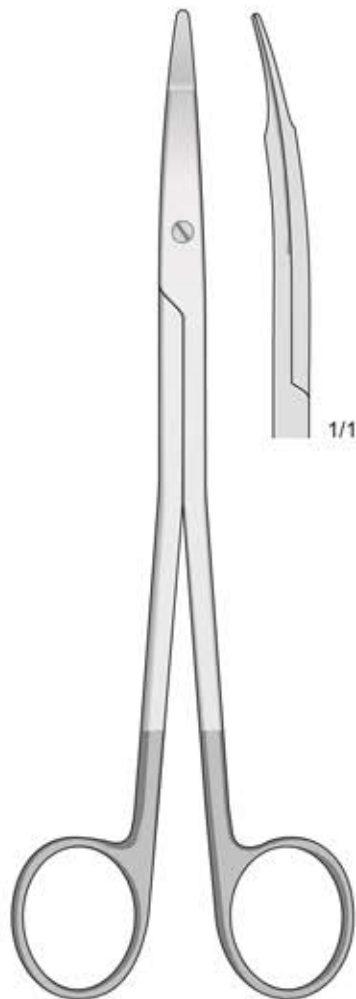

FREEMAN
FM-328
180 mm

Super Cut
TC

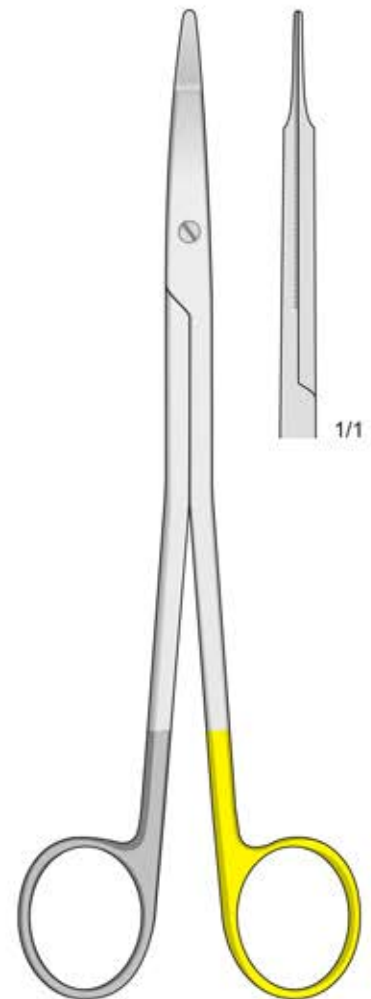

FREEMAN
FM-329
180 mm



Extremely Sharp Razor Edge / Atraumatic
 Extrem Scharfe Spitzer Beck / Atraumatische
 Tranchant extrêmement aiguisée / Atraumatique
 Borde extremadamente afilado / Atraumática
 Taglio estremamente affilato / Atraumatica



Tungsten-Carbide Inserts
 Mit Hartmetalleinsätzen
 Plaquettes en carbure de tungstène
 Plaquetas de carburo de tungsteno
 Inserti in carburo di tungsteno



One side serrated
 Eine seite gezahnt
 Un côté dentelé
 Un lado dentado
 Un lato dentellato

Super Cut
TC

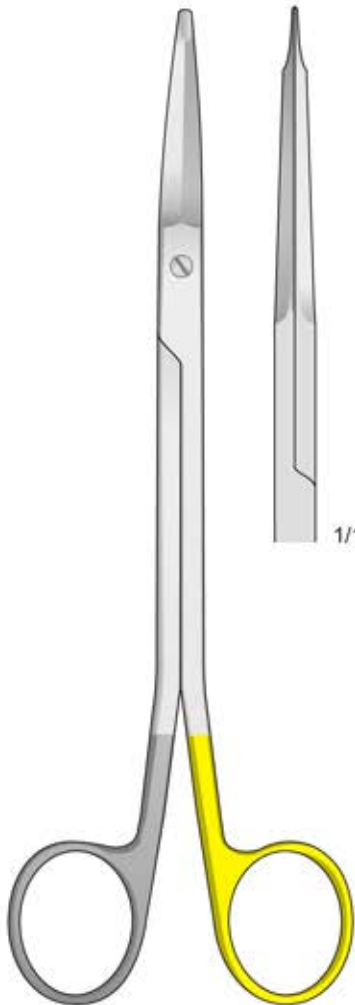

FREEMAN KAYE
FM-336
 180 mm

Super Cut
TC

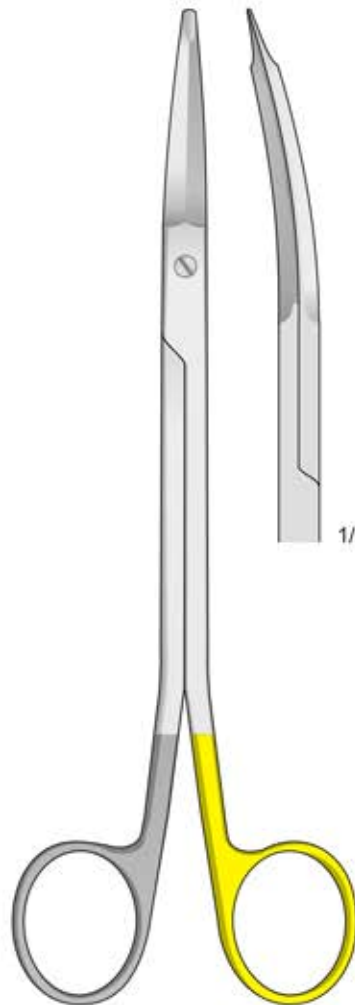

FREEMAN KAYE
FM-337
 180 mm

Super Cut
TC

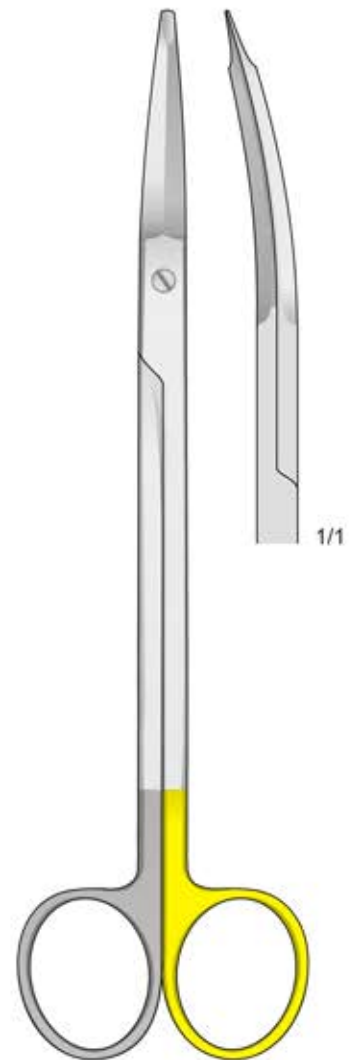

GORNEY
FM-324
 190 mm



Tungsten-Carbide Inserts
 Mit Hartmetalleinsätzen
 Plaquettes en carbure de tungstène
 Plaquetas de carburo de tungsteno
 Inserti in carburo di tungsteno

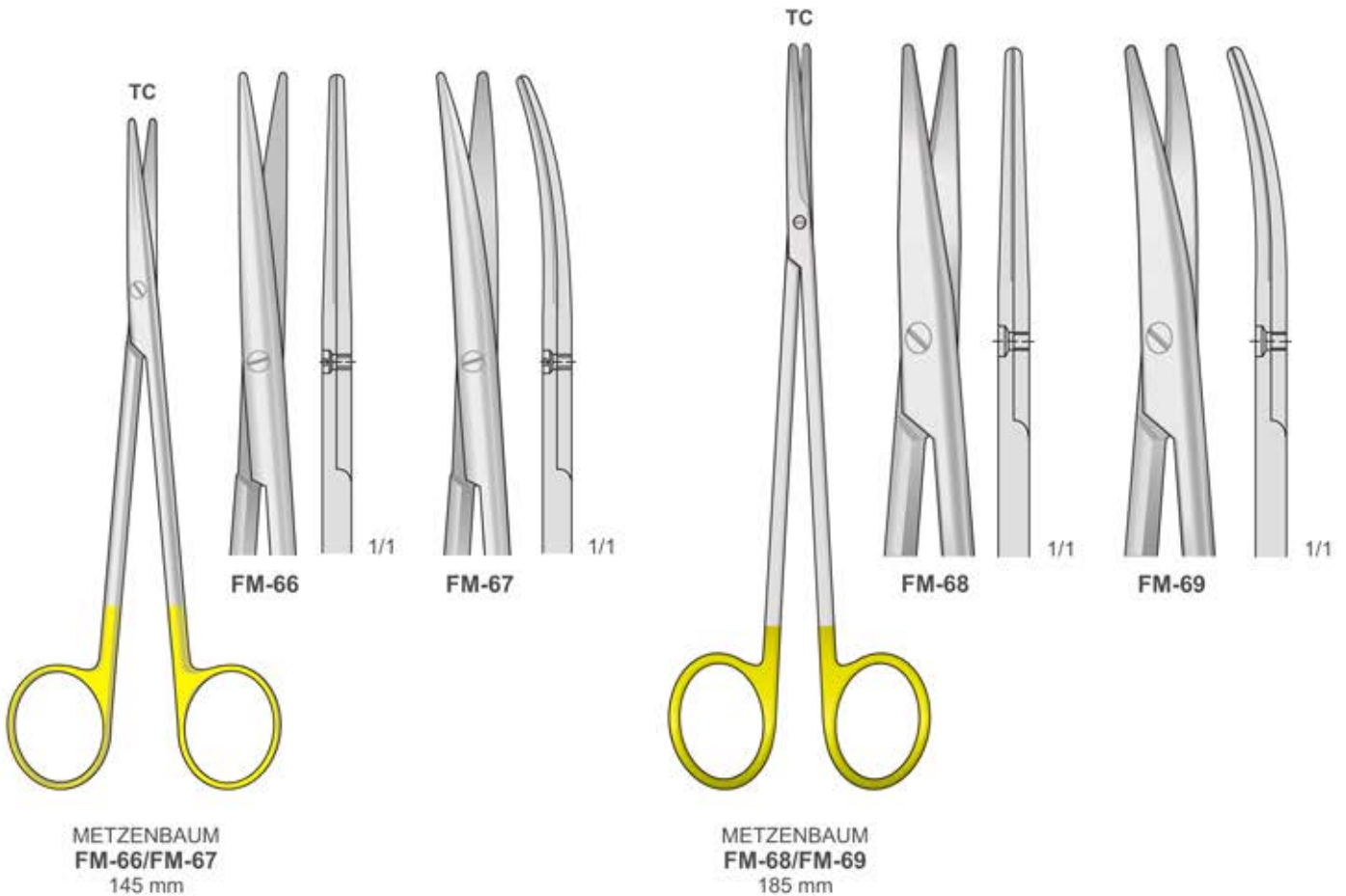

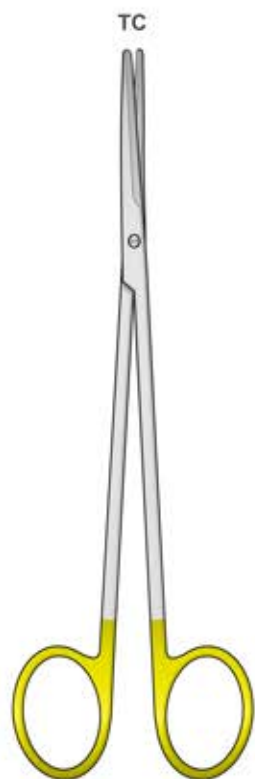

METZENBAUM-FINO
FM-201/FM-204

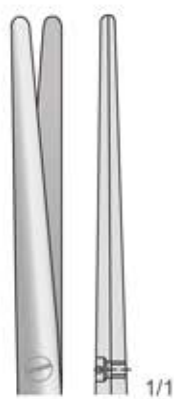

FM-201
140 mm

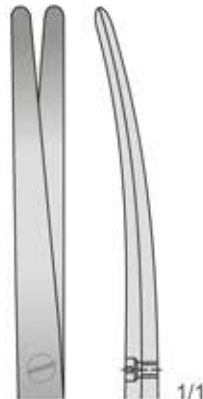

FM-202
140 mm

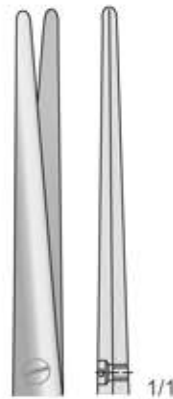

FM-203
180 mm

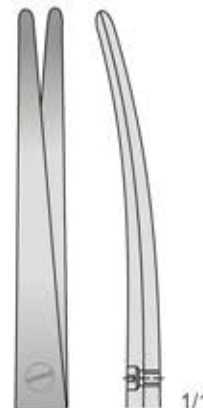

FM-204
180 mm



Tungsten-Carbide Inserts
Mit Hartmetalleinsätzen
Plaquettes en carbure de tungstène
Plaquetas de carburo de tungsteno
Inserti in carburo di tungsteno

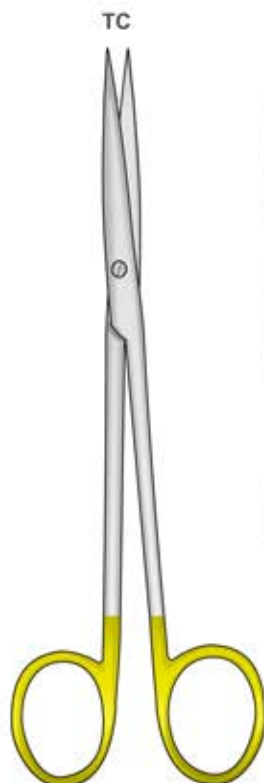

METZENBAUM-FINO
FM-96/FM-99

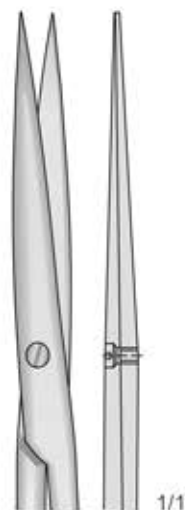

FM-96
140 mm

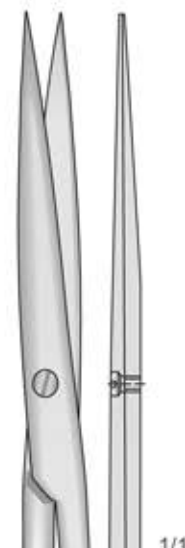

FM-97
180 mm

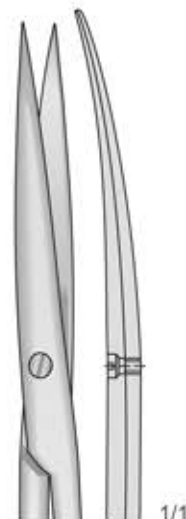

FM-98
140 mm

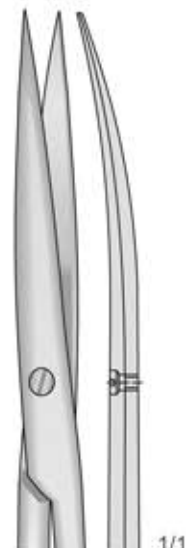

FM-99
180 mm

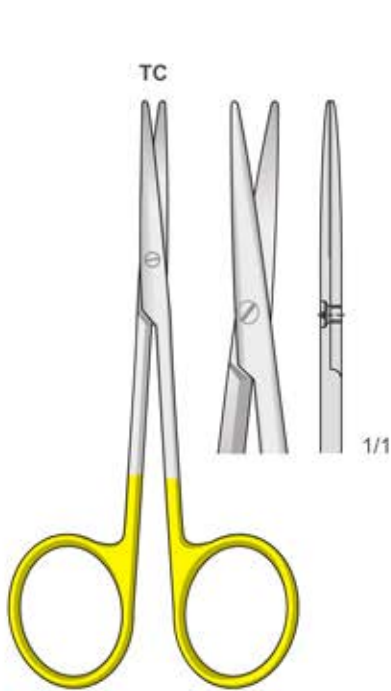

LEXER-BABY (KNAPP)
FM-118
115 mm

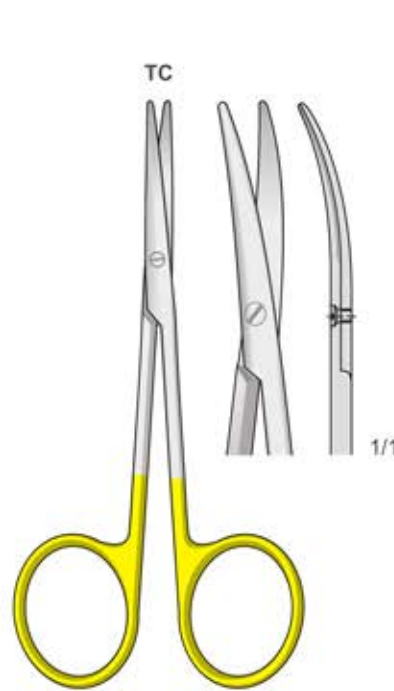

LEXER-BABY (KNAPP)
FM-119
115 mm

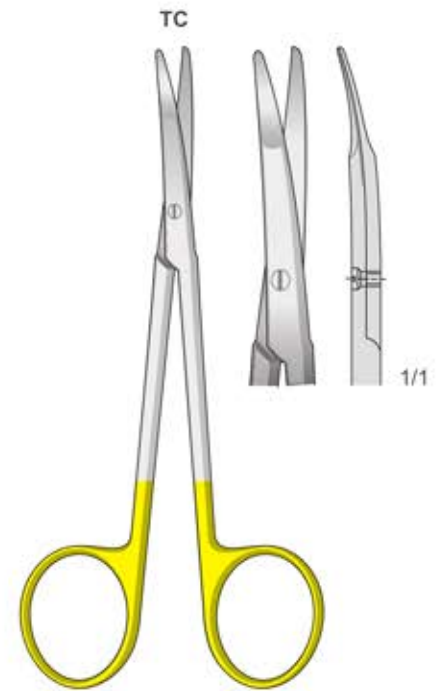

KILNER
FM-350
125 mm



Tungsten-Carbide Inserts
Mit Hartmetalleinsätzen
Plaquettes en carbure de tungstène
Plaquetas de carburo de tungsteno
Inserti in carburo di tungsteno

Gebogen - Curved
Curva - Curvas
Courbes

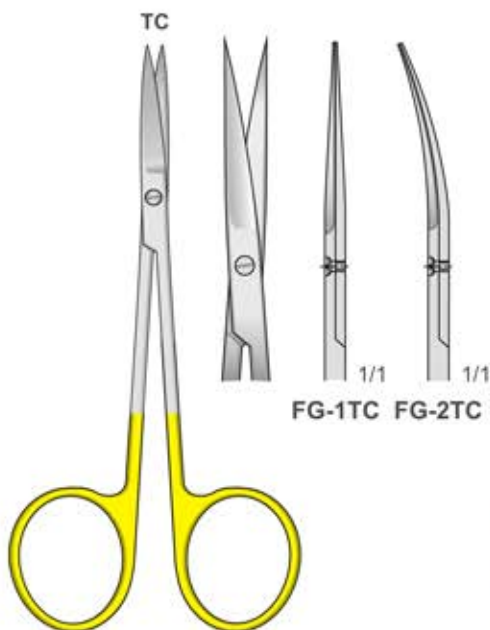

IRIS
FG-1TC/FG-2TC
115 mm

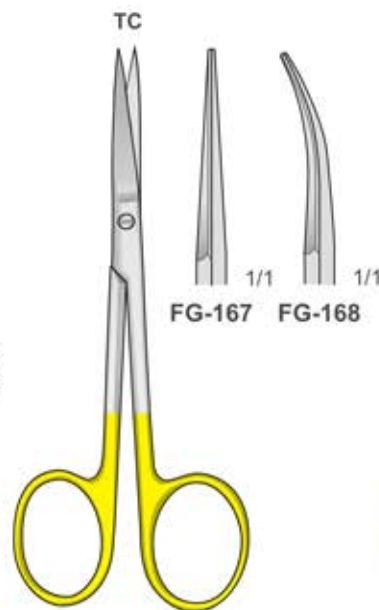

FG-167/FG-168
110 mm

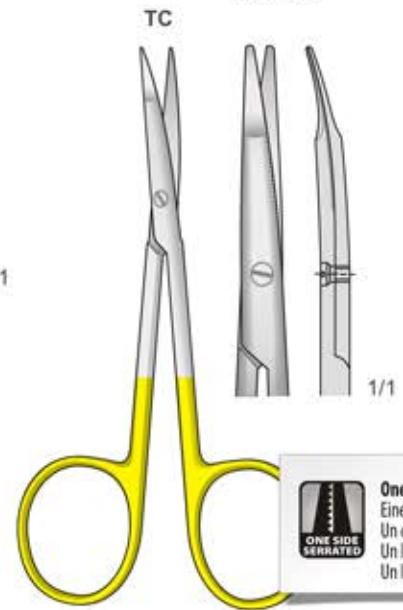

GREENBERG-PAR
FM-317
115 mm



One side serrated
Eine Seite gezahnt
Un côté dentelé
Un lado dentado
Un lato dentellato

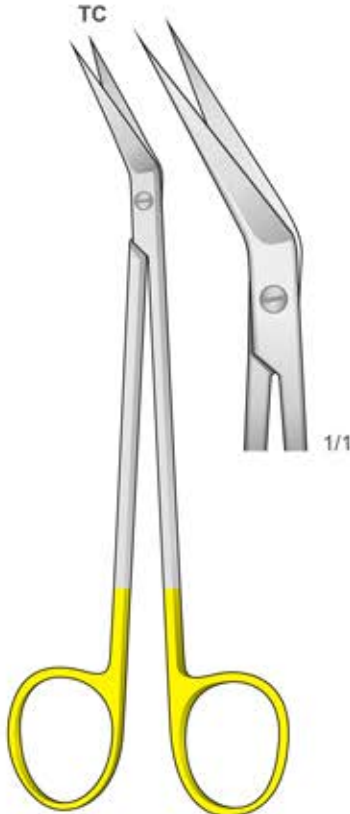

LK-10
160 mm

TC
TUNGSTEN CARBIDE
Tungsten-Carbide Inserts
Mit Hartmetalleinsätzen
Plaquettes en carbure de tungstène
Plaquetas de carburo de tungsteno
Inserti in carburo di tungsteno

ONE SIDE SERRATED
One side serrated
Eine seite gezahnt
Un côté dentelé
Un lado dentado
Un lato dentellato

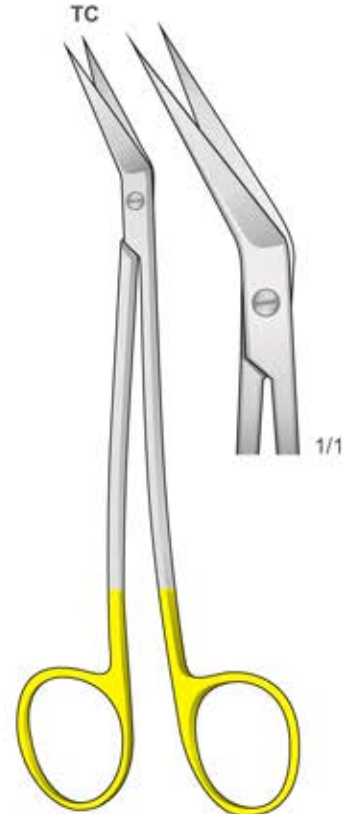

LK-12
160 mm

SUPER CUT
Extremely Sharp Razor Edge / Atraumatic
Extrem Scharfe Spitzer Beck / Atraumatische
Tranchant extrêmement aiguisée / Atraumatique
Borde extremadamente afilado / Atraumática
Taglio estremamente affilato / Atraumatica

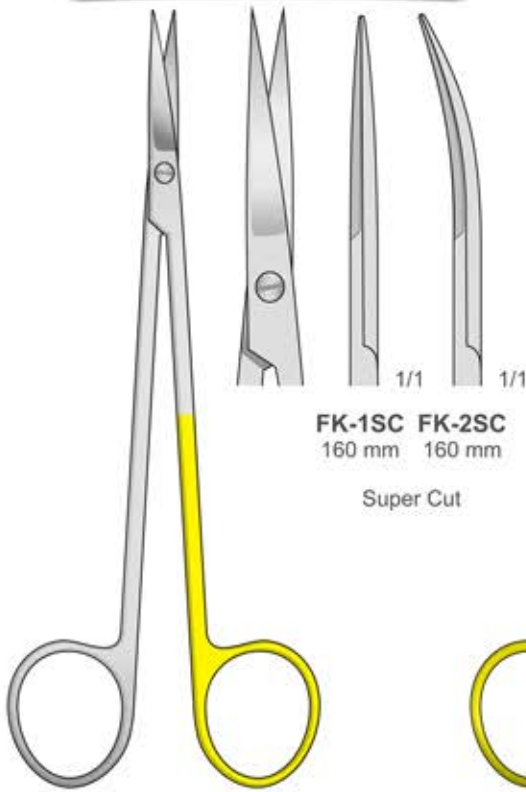

KELLY
FK-1SC/FK-2SC
160 mm

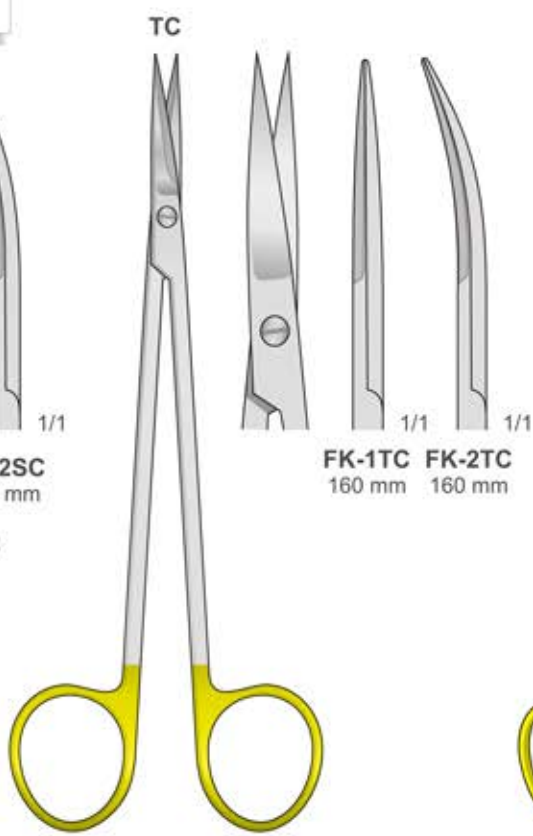

KELLY
FK-1TC/FK-2TC
160 mm

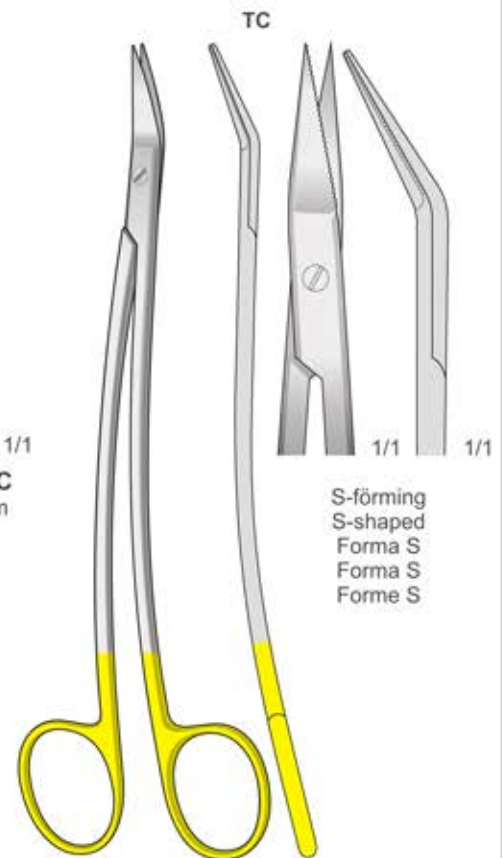

DEAN-TC
175 mm

S-förmig
S-shaped
Forma S
Forme S

Wellenschliff
TC

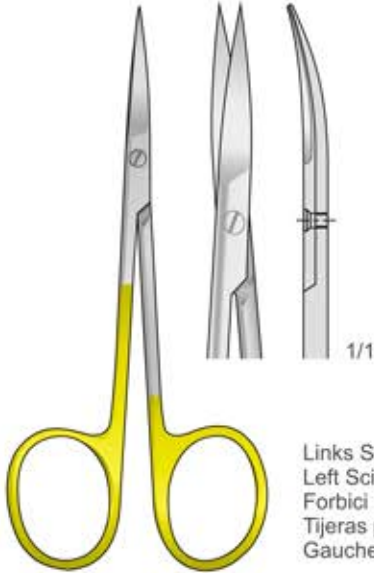

TC
TUNGSTEN
CARBIDE
Tungsten-Carbide Inserts
Mit Hartmetalleinsätzen
Plaquettes en carbure de tungstène
Plaquetas de carburo de tungsteno
Inserti in carburo di tungsteno

**ONE SIDE
SERRATED**
One side serrated
Eine seite gezahnt
Un côté dentelé
Un lato dentado
Un lato dentellato

Links Scheren
Left Scissors
Forbici per mancini
Tijeras para zurdos
Gauche Ciseaux

IRIS
FM-100L
110 mm

Wellenschliff
TC

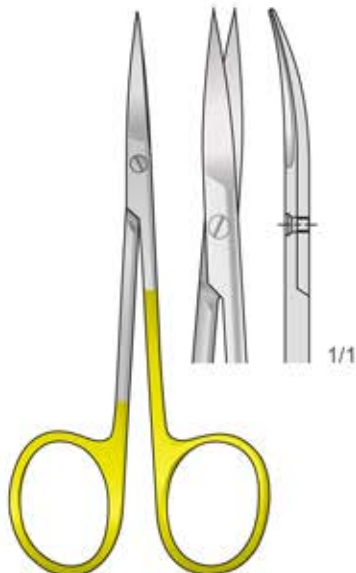

IRIS
FM-100
110 mm

Wellenschliff
TC

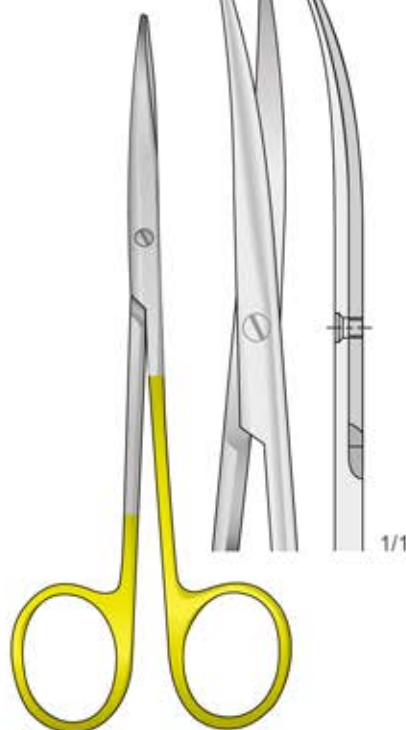

METZENBAUM
FM-102
145 mm

Wellenschliff
TC

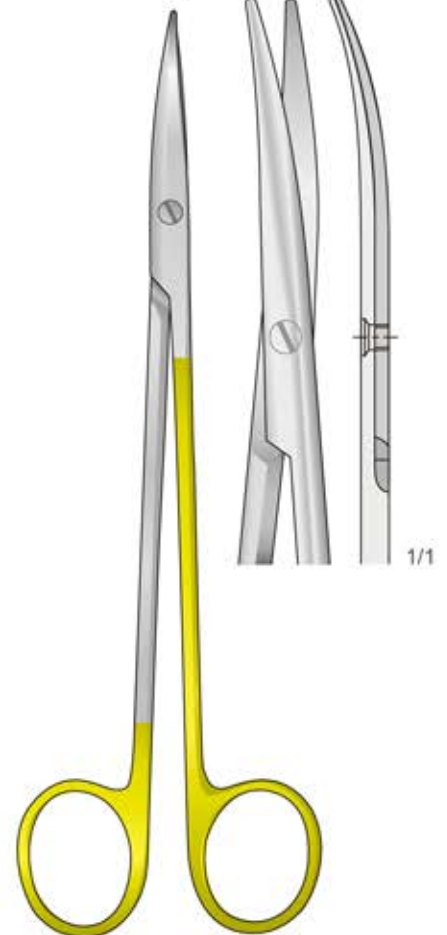

METZENBAUM
FM-104
185 mm



Alphanumerical
Index

Alphanumerischen
Index

Index
alphanumérique

Indice
alfanumérico

Indice
alfanumerico

Code	Page	Code	Page	Code	Page	Code	Page
DEAN-TC	34	FM-211	16	FM-61	14		
FG-153	21	FM-212	17	FM-66	15, 31		
FG-154	21	FM-294	9	FM-67	15, 31		
FG-163	4	FM-295	9	FM-68	15, 31		
FG-165	21	FM-296	9	FM-69	15, 31		
FG-166	21	FM-297	9	FM-90	18		
FG-167	10, 33	FM-298	9	FM-91	18		
FG-168	10, 33	FM-299	9	FM-92	18		
FG-192	3	FM-300	9	FM-94	18		
FG-193	3	FM-301	9	FM-96	10, 18, 32		
FG-1TC	10, 33	FM-302	4	FM-97	18, 32		
FG-2TC	10, 33	FM-304	5	FM-98	18, 32		
FG-63	21	FM-305	27	FM-99	18, 32		
FG-64	21	FM-306	28	GFC-TC	10		
FG-92	10	FM-307	28	GFR-TC	10		
FG-95	3	FM-308	4	LK-10	34		
FG-98	10	FM-310	28	LK-12	34		
FK-1SC	34	FM-311	23				
FK-1TC	11, 34	FM-312	24				
FK-2SC	34	FM-313G	8				
FK-2TC	11, 34	FM-314G	8				
FM-100	22, 35	FM-315	11				
FM-100L	35	FM-317	11, 33				
FM-102	22, 35	FM-318	5				
FM-104	22, 35	FM-319	5				
FM-118	11, 33	FM-320	25				
FM-119	11, 33	FM-321	25				
FM-130	19	FM-323	25				
FM-131	19	FM-324	30				
FM-132	19	FM-325	23				
FM-133	19	FM-326	23				
FM-134	19	FM-328	29				
FM-135	19	FM-329	29				
FM-136	19	FM-330	28				
FM-137	19	FM-331	29				
FM-139	20	FM-332	6				
FM-140	20	FM-332G	7				
FM-141	20	FM-333	6				
FM-142	20	FM-333G	7				
FM-143	20	FM-334	23				
FM-145	14	FM-335	24				
FM-146	14	FM-336	30				
FM-147	14	FM-337	30				
FM-148	12	FM-338	24				
FM-149	12	FM-339	26				
FM-150	12	FM-340	26				
FM-151	13	FM-341	25				
FM-152	13	FM-342	26				
FM-153	13	FM-343	27				
FM-160	15	FM-344	27				
FM-161	15	FM-350	11, 33				
FM-162	15	FM-351	27				
FM-163	15	FM-50	12				
FM-201	16, 32	FM-51	12				
FM-202	17, 32	FM-52	12				
FM-203	16, 32	FM-53	12				
FM-204	17, 32	FM-54	13				
FM-205	16	FM-55	13				
FM-206	17	FM-56	13				
FM-207	16	FM-57	13				
FM-208	17	FM-58	14				
FM-209	16	FM-59	14				
FM-210	17	FM-60	14				

