



BROMED
INSTRUMENTS

Das Instrument.



Dental-Instrumente Katalog

Zahnärztliche Chirurgie

Catalogue des instruments dentaires

Chirurgie dentaire

Catálogo de instrumentos dentales

Cirugía dental

Catalogo di strumenti dentali

Chirurgia dentale

Dental Instrument Catalogue

Dental Surgery



BROMED
INSTRUMENTS

Germany Stainless Steel CE 0411190411.com





Dental



Dental Surgery
Zahnärztliche Chirurgie
Chirurgie Dentaire
Cirugía Dental
Chirurgia Dentale



VI

Company Profile | Technical Information
Firmenprofil | Technische Informationen
Profil de l'entreprise | Information technique
Perfil de la empresa | Información técnica
Profilo Compagnia | Informazioni tecniche

A

Extracting Forceps

Zahnzangen
Daviers
Pinzas de extracción
Pinze da estrazione

1

B

Root Elevators

Wurzelheber
Elevatori per radici
Elevadores para raíces
Élévateurs pour racines

41

C

Scalpel Blades and Handles

Skalpellklingen und Skalpellgriffe
Lames et manches de bistouri
Hojas y mangos de bisturi
Lame e manici per bisturi

73

D

Surgical Scissors

Chirurgische Scheren
Ciseaux chirurgicaux
Tijeras quirúrgicas
Forbici Chirurgiche

81

E

Tissue and Dressing Forceps

Chirurgische und Anatomische Pinzetten
Pinces à tissu et à pansement
Pinzas quirúrgicas y anatómicas
Pinzette chirurgiche e anatomiche

111

F

Needle Holders

Nadelhalter
Porte-aiguilles
Porta-agujas
Port'aghi

139

G

Hemostatic Forceps | Towel Clamps

Arterienklemmen | Tuchklemmen
Pinces hémostatiques | Fixe-compresse
Pinzas hemostáticas | Pinzas de campo
Pinzette emostatiche | Fissateli

163

H

Retractors | Mouth Gags

Retraktoren | Mundsperrer
Écarteurs | Ouvre-bouche
Separadores | Abrebocas
Divaricatori | Apribocca

175

I

Implantology

Implantologie
Implantologie
Implantologia
Implantologia

197

J

Periosteal | Curettes | Rongeurs

Raspatorien | Küretten | Hohlmeißelzangen
Rugines | Curettes | Pinces gouges
Periostótomos | Curetas | Pinzas gubias
Scollaperiosteo | Curettes | Pinze ossivore

221

K

Dental Restoration | Periodontology

Restaurative Zahnheilkunde | Parodontologie
Odontologie conservatrice | Parodontie
Odontologia conservadora | Periodoncia
Odontoiatria conservativa | Parodontologia

247

L

Suction Tubes

Saugkanülen
Canules d'aspiration
Cánulas de aspiración
Cannule per aspirazione

313

M

Orthodontics

Kieferorthopädie
Orthodontie
Ortodoncia
Ortodonzia

321

N

Crown Instruments | Laboratory

Kroneninstrumente | Labor
Instruments à couronnes | laboratoire
Instrumentos para coronas | laboratorio
Strumenti per corone | laboratorio

333

O

Instrument Maintenance | Sterilization

Instrumentenwartung | Sterilisierung
Entretien des instruments | Stérilisation
Mantenimiento | Esterilización
Manutenzione | Sterilizzazione

347

A-Z

Alphabetical Index

Alphabetischen Index
Index alphabétique
Índice alfabético
Indice alfabetico

359

A1-Z1

Alphanumeric Index

Alphanumerischen Index
Index alphanumérique
Índice alfanumérico
Indice alfanumerico

363

Table of Contents
Inhaltsverzeichnis
Table des matières
Tabla de contenido
Tavola dei contenuti

Technical Information
 Technische Informationen
 Information technique
 Información técnica
 Informazioni tecniche



Gauge	Ø mm	Charrière (French)	Ø mm
40	0.12	1	1/16
39	0.13	2	1/8
38	0.15	3	3/16
37	0.17	4	1/4
36	0.19	5	5/16
35	0.21	6	3/8
34	0.22	7	7/16
33	0.25	8	1/2
32	0.27	9	9/16
31	0.28	10	5/8
30	0.30	11	3/4
29	0.33	12	7/8
28	0.35	13	15/16
27	0.40	14	1
26	0.46	15	1 1/16
25	0.50	16	1 1/8
24	0.56	17	1 1/4
23	0.61	18	1 3/8
22	0.71	19	1 7/8
21	0.81	20	2
20	0.91	21	2 1/16
19	1.01	22	2 1/8
18	1.22	23	2 1/4
17	1.42	24	2 3/8
16	1.62	25	2 7/8
15	1.83	26	3
14	2.03	27	3 1/8
13	2.34	28	3 1/4
12	2.64	29	3 3/8
11	2.94	30	3 7/8
10	3.25	31	4
11	3.25	32	4 1/8
10	3.25	33	4 1/4
11	3.25	34	4 3/8
12	3.25	35	4 7/8
13	3.25	36	5
14	3.25	37	5 1/8
15	3.25	38	5 1/4
16	3.25	39	5 3/8
17	3.25	40	5 7/8
18	3.25	41	6
19	3.25	42	6 1/8
20	3.25	43	6 1/4
21	3.25	44	6 3/8
22	3.25	45	6 7/8
23	3.25	46	7
24	3.25	47	7 1/8
25	3.25	48	7 1/4
26	3.25	49	7 3/8
27	3.25	50	7 7/8
28	3.25	51	8
29	3.25	52	8 1/8
30	3.25	53	8 1/4
31	3.25	54	8 3/8
32	3.25	55	8 7/8
33	3.25	56	9
34	3.25	57	9 1/8
35	3.25	58	9 1/4
36	3.25	59	9 3/8
37	3.25	60	9 7/8
38	3.25	61	10
39	3.25	62	10 1/8
40	3.25	63	10 1/4
41	3.25	64	10 3/8
42	3.25	65	10 7/8
43	3.25	66	11
44	3.25	67	11 1/8
45	3.25	68	11 1/4
46	3.25	69	11 3/8
47	3.25	70	11 7/8
48	3.25	71	12
49	3.25	72	12 1/8
50	3.25	73	12 1/4
51	3.25	74	12 3/8
52	3.25	75	12 7/8
53	3.25	76	13
54	3.25	77	13 1/8
55	3.25	78	13 1/4
56	3.25	79	13 3/8
57	3.25	80	13 7/8
58	3.25	81	14
59	3.25	82	14 1/8
60	3.25	83	14 1/4
61	3.25	84	14 3/8
62	3.25	85	14 7/8
63	3.25	86	15
64	3.25	87	15 1/8
65	3.25	88	15 1/4
66	3.25	89	15 3/8
67	3.25	90	15 7/8
68	3.25	91	16
69	3.25	92	16 1/8
70	3.25	93	16 1/4
71	3.25	94	16 3/8
72	3.25	95	16 7/8
73	3.25	96	17
74	3.25	97	17 1/8
75	3.25	98	17 1/4
76	3.25	99	17 3/8
77	3.25	100	17 7/8
78	3.25	101	18
79	3.25	102	18 1/8
80	3.25	103	18 1/4
81	3.25	104	18 3/8
82	3.25	105	18 7/8
83	3.25	106	19
84	3.25	107	19 1/8
85	3.25	108	19 1/4
86	3.25	109	19 3/8
87	3.25	110	19 7/8
88	3.25	111	20
89	3.25	112	20 1/8
90	3.25	113	20 1/4
91	3.25	114	20 3/8
92	3.25	115	20 7/8
93	3.25	116	21
94	3.25	117	21 1/8
95	3.25	118	21 1/4
96	3.25	119	21 3/8
97	3.25	120	21 7/8
98	3.25	121	22
99	3.25	122	22 1/8
100	3.25	123	22 1/4
101	3.25	124	22 3/8
102	3.25	125	22 7/8
103	3.25	126	23
104	3.25	127	23 1/8
105	3.25	128	23 1/4
106	3.25	129	23 3/8
107	3.25	130	23 7/8
108	3.25	131	24
109	3.25	132	24 1/8
110	3.25	133	24 1/4
111	3.25	134	24 3/8
112	3.25	135	24 7/8
113	3.25	136	25
114	3.25	137	25 1/8
115	3.25	138	25 1/4
116	3.25	139	25 3/8
117	3.25	140	25 7/8
118	3.25	141	26
119	3.25	142	26 1/8
120	3.25	143	26 1/4
121	3.25	144	26 3/8
122	3.25	145	26 7/8
123	3.25	146	27
124	3.25	147	27 1/8
125	3.25	148	27 1/4
126	3.25	149	27 3/8
127	3.25	150	27 7/8
128	3.25	151	28
129	3.25	152	28 1/8
130	3.25	153	28 1/4
131	3.25	154	28 3/8
132	3.25	155	28 7/8
133	3.25	156	29
134	3.25	157	29 1/8
135	3.25	158	29 1/4
136	3.25	159	29 3/8
137	3.25	160	29 7/8
138	3.25	161	30
139	3.25	162	30 1/8
140	3.25	163	30 1/4
141	3.25	164	30 3/8
142	3.25	165	30 7/8
143	3.25	166	31
144	3.25	167	31 1/8
145	3.25	168	31 1/4
146	3.25	169	31 3/8
147	3.25	170	31 7/8
148	3.25	171	32
149	3.25	172	32 1/8
150	3.25	173	32 1/4
151	3.25	174	32 3/8
152	3.25	175	32 7/8
153	3.25	176	33
154	3.25	177	33 1/8
155	3.25	178	33 1/4
156	3.25	179	33 3/8
157	3.25	180	33 7/8
158	3.25	181	34
159	3.25	182	34 1/8
160	3.25	183	34 1/4
161	3.25	184	34 3/8
162	3.25	185	34 7/8
163	3.25	186	35
164	3.25	187	35 1/8
165	3.25	188	35 1/4
166	3.25	189	35 3/8
167	3.25	190	35 7/8
168	3.25	191	36
169	3.25	192	36 1/8
170	3.25	193	36 1/4
171	3.25	194	36 3/8
172	3.25	195	36 7/8
173	3.25	196	37
174	3.25	197	37 1/8
175	3.25	198	37 1/4
176	3.25	199	37 3/8
177	3.25	200	37 7/8
178	3.25	201	38
179	3.25	202	38 1/8
180	3.25	203	38 1/4
181	3.25	204	38 3/8
182	3.25	205	38 7/8
183	3.25	206	39
184	3.25	207	39 1/8
185	3.25	208	39 1/4
186	3.25	209	39 3/8
187	3.25	210	39 7/8
188	3.25	211	40
189	3.25	212	40 1/8
190	3.25	213	40 1/4
191	3.25	214	40 3/8
192	3.25	215	40 7/8
193	3.25	216	41
194	3.25	217	41 1/8
195	3.25	218	41 1/4
196	3.25	219	41 3/8
197	3.25	220	41 7/8
198	3.25	221	42
199	3.25	222	42 1/8
200	3.25	223	42 1/4
201	3.25	224	42 3/8
202	3.25	225	42 7/8
203	3.25	226	43
204	3.25	227	43 1/8
205	3.25	228	43 1/4
206	3.25	229	43 3/8
207	3.25	230	43 7/8
208	3.25	231	44
209	3.25	232	44 1/8
210	3.25	233	44 1/4
211	3.25	234	44 3/8
212	3.25	235	44 7/8
213	3.25	236	45
214	3.25	237	45 1/8
215	3.25	238	45 1/4
216	3.25	239	45 3/8
217	3.25	240	45 7/8
218	3.25	241	46
219	3.25	242	46 1/8
220	3.25	243	46 1/4
221	3.25	244	46 3/8
222	3.25	245	46 7/8
223	3.25	246	47
224	3.25	247	47 1/8
225	3.25	248	47 1/4
226	3.25	249	47 3/8
227	3.25	250	47 7/8
228	3.25	251	48
229	3.25	252	48 1/8
230	3.25	253	48 1/4
231	3.25	254	48 3/8
232	3.25	255	48 7/8
233	3.25	256	49
234	3.25	257	49 1/8
235	3.25	258	49 1/4
236	3.25	259	49 3/8
237	3.25	260	49 7/8
238	3.25	261	50
239	3.25	262	50 1/8
240	3.25	263	50 1/4
241	3.25	264	50 3/8
242	3.25	265	50 7/8
243	3.25	266	51
244	3.25	267	51 1/8
245	3.25	268	51 1/4
246	3.25	269	51 3/8
247	3.25	270	51 7/8
248	3.25	271	52
249	3.25	272	52 1/8
250	3.25	273	52 1/4
251	3.25	274	52 3/8
252	3.25	275	52 7/8
253	3.25	276	53
254	3.25	277	53 1/8
255	3.25	278	53 1/4
256	3.25	279	53 3/8
257	3.25	280	53 7/8

Forceps
 Pinzetten | Pinces | Pinzas | Pinzette

Regular
 Standard
 Régulier
 Regular
 Regolare

1x2 Teeth
 Zähne
 Dents
 Dientes
 Denti

Scissors
 Scheren | Ciseaux | Tijeras | Forbici

Regular Edge

SUPER CUT Edge

Super Cut Scissors have specially designed cutting edges. One regular edge and one sharp-knife edge.

Extremely Sharp Razor Edge / Atraumatic
 Extrem Scharfe Spitzer Beck / Atraumatische Tranchant extrêmement aiguisée / Atraumática Borde extremadamente afilado / Atraumática Taglio estremamente affilato / Atraumatica

SUPER CUT

Tungsten-Carbide Inserts
 Mit Hartmetalleinsätzen
 Plaquettes en carbure de tungstène
 Plaquetas de carburo de tungsteno
 Inserti in carburo di tungsteno

TC TUNGSTEN CARBIDE

Sharp
 Scharfe
 Aiguisé
 Afilado
 Tagliente

SHARP

Regular
 Regular
 Régulier
 Regular
 Regolare

STANDARD

Serrated
 Gezahnt
 Dentelé
 Dentado
 Dentellato

SERRATED

One side serrated
 Eine Seite gezahnt
 Un côté dentelé
 Un lado dentado
 Un lato dentellato

ONE SIDE SERRATED

Pointed
 Spitz
 Pointu
 Puntigliado
 Acuto

POINTED

Blunt
 Stumpf
 Épointé
 Romo
 Smusso

BLUNT

Needle Holders
 Nadelhalter | Porte-aiguilles | Portaagujas | Port'aghi

R **Regular**
 Standard
 Régulier
 Regular
 Regolare

A

Extracting Forceps
Zahnzangen
Daviers
Pinzas de extracción
Pinze da estrazione





Zahnzangen, Englische Form
 Extracting Forceps, English Pattern
 Pinze per estrazione, Forma Inglese
 Pinzas da extracción, Forma Inglesa
 Daviers, Forme Anglaise



1
 Fig. 1

Obere Schneide- und Eckzähne
 Upper Incisors and cuspids
 Incisivi e canini superiori
 Incisivos y caninos superiores
 Incisives et canines supérieures



2
 Fig. 2

Obere Schneide- und Eckzähne
 Upper Incisors and cuspids
 Incisivi e canini superiori
 Incisivos y caninos superiores
 Incisives et canines supérieures

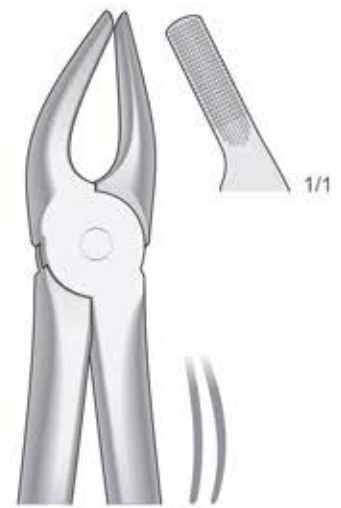

7
 Fig. 7

Obere Prämolaren
 Upper premolars
 Premolari superiori
 Premolares superiores
 Prémolaires supérieures

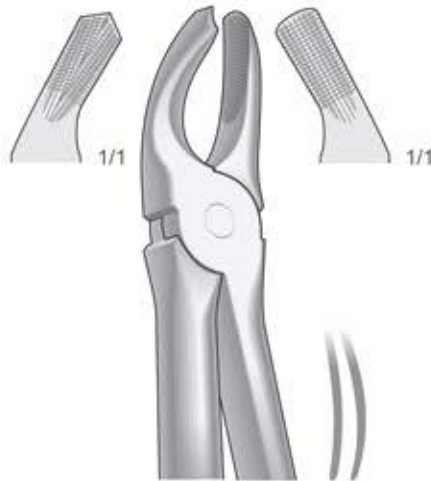

17
 Fig. 17

Obere Molaren, rechts
 Upper molars, right
 Molari superiori, destra
 Molares superiores, derechos
 Molaires supérieures, droites

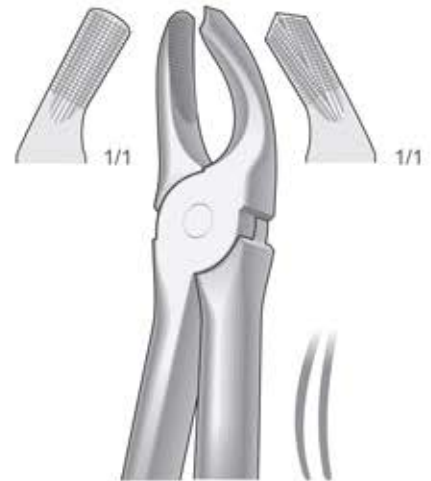

18
 Fig. 18

Obere Molaren, links
 Upper molars, left
 Molari superiori, sinistra
 Molares superiores, izquierdos
 Molaires supérieures, gauches



Zahnzangen, Englische Form
Extracting Forceps, English Pattern
Pinze per estrazione, Forma Inglese
Pinzas da extracción, Forma Inglesa
Daviers, Forme Anglaise



Obere Wurzeln und Schneidezähne
Upper Roots and incisors
Radici e incisivi superiori
Raíces y incisivos superiores
Racines et incisives supérieures

29
Fig. 29



Obere Wurzeln
Upper Roots
Radici superiori
Raíces superiores
Racines supérieures

30
Fig. 30



Zahnzangen, Englische Form
 Extracting Forceps, English Pattern
 Pinze per estrazione, Forma Inglese
 Pinzas da extracción, Forma Inglesa
 Daviers, Forme Anglaise



51
 Fig. 51

Obere Wurzeln
 Upper Roots
 Radici superiori
 Raíces superiores
 Racines supérieures



51A
 Fig. 51A

Obere Wurzeln
 Upper Roots
 Radici superiori
 Raíces superiores
 Racines supérieures

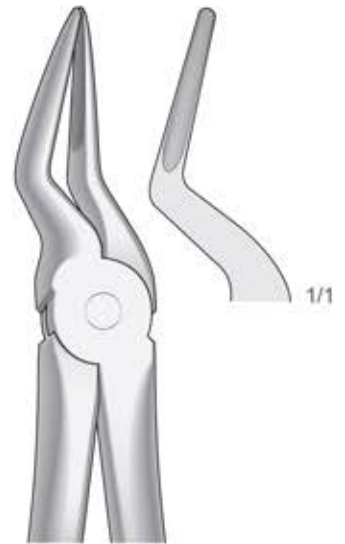

51L
 Fig. 51AL

Obere Wurzeln
 Upper Roots
 Radici superiori
 Raíces superiores
 Racines supérieures



67A
 Fig. 67A

Obere Dritte Molaren - Für Obere Weisheitszähne
 Upper molars - For Upper wisdom teeth
 Ottavi superiori - Per denti del giudizio superiori
 Molares superiores - Para muelas del juicio superiores
 Molaires supérieures - Pour dents de sagesse supérieures



Zahnzangen, Englische Form
Extracting Forceps, English Pattern
Pinze per estrazione, Forma Inglese
Pinzas da extracción, Forma Inglesa
Daviers, Forme Anglaise



33
Fig. 33

Untere Prämolaren, Schneidezähne und Wurzeln
Lower incisors, premolars and roots
Incisivi, premolari e radici inferiori
Incisivos, premolares y raíces inferiores
Incisives, prémolaires et racines inférieures

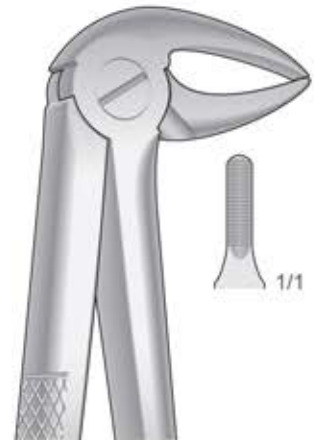

33A
Fig. 33A

Untere Wurzeln, schlankes Maul
Lower roots, Slender jaw
Radici inferiori, morso stretto
Raíces inferiores, boca estrecha
Racines inférieures, avec un bec très fin



13
Fig. 13

Untere Eckzähne und Prämolaren
Lower cuspids and premolars
Canini e premolari inferiori
Caninos y premolares inferiores
Canines et prémolaires inférieures

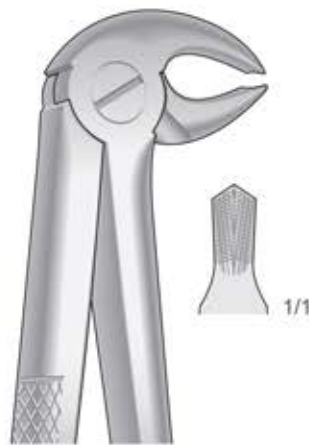

22
Fig. 22

Untere Molaren
Lower molars
Molari inferiori
Molares inferiores
Molaires inférieures



73
Fig. 73

Untere Molaren
Lower molars
Molari inferiori
Molares inferiores
Molaires inférieures



Zahnzangen, Englische Form
 Extracting Forceps, English Pattern
 Pinze per estrazione, Forma Inglese
 Pinzas da extracción, Forma Inglesa
 Daviers, Forme Anglaise



74N
 Fig. 74N

Untere Wurzeln, schneide-und Eckzähne
 Lower roots, Incisors and bicuspid
 Radici, incisivi e canini inferiori
 Raíces, incisivos y caninos inferiores
 Racines, incisives et canines inférieures

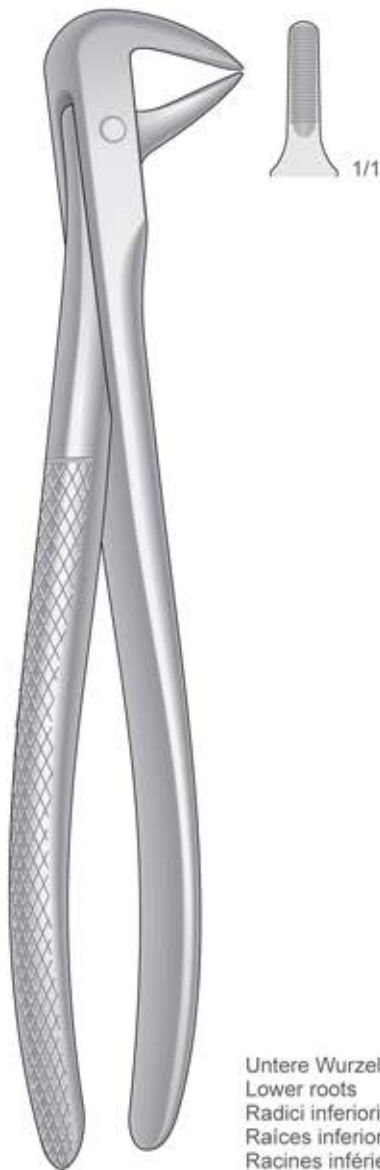

74
 Fig. 74

Untere Wurzeln
 Lower roots
 Radici inferiori
 Raíces inferiores
 Racines inférieures



75
 Fig. 75

Untere Eckzähne und Prämolaren
 Lower Cuspids and bicuspid
 Canini e premolari inferiori
 Caninos y premolares inferiores
 Canines et prémolaires inférieures



86A
 Fig. 86A

Untere Molaren
 Lower molars
 Molari inferiori
 Molares inferiores
 Molaires inférieures



Zahnzangen, Englische Form
Extracting Forceps, English Pattern
Pinze per estrazione, Forma Inglese
Pinzas da extracción, Forma Inglesa
Daviers, Forme Anglaise

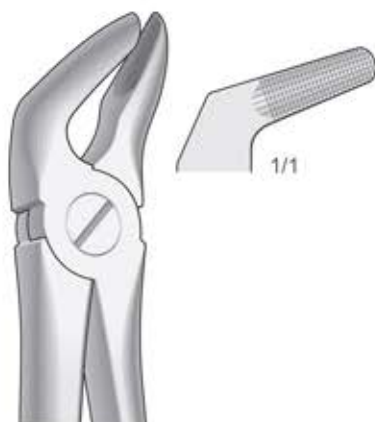

8
Fig. 8

Untere Prämolaren
Lower premolars
Premolari inferiori
Premolares inferiores
Prémolaires inférieures



21
Fig. 21

Untere Weisheitszähne und Molaren
Lower wisdom teeth and molars
Denti del giudizio e molari inferiori
Muelas del juicio y Molares inferiores
Dents de sagesse et molaires inférieures



4
Fig. 4

Untere Schneide- und Eckzähne
Lower Incisors and cuspids
Incisivi e canini inferiori
Incisivos y caninos inferiores
Incisives et canines inférieures

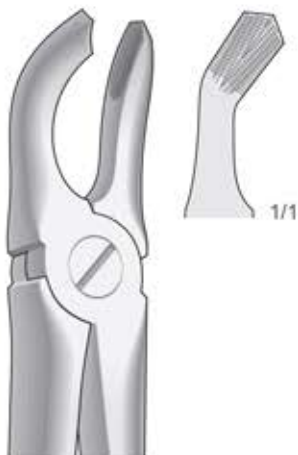
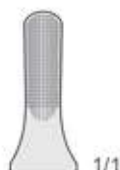

79
Fig. 79

Untere Weisheitszähne
Lower wisdom teeth
Denti del giudizio inferiori
Muelas del juicio inferiores
Dent de sagesse inférieures



79A
Fig. 79A

Untere Molaren und Weisheitszähne
Lower molars and wisdom teeth
Molari e denti del giudizio inferiori
Molares y muelas del juicio inferiores
Molaires et dent de sagesse inférieures



Zahnzangen, Englische Form
 Extracting Forceps, English Pattern
 Pinze per estrazione, Forma Inglese
 Pinzas da extracción, Forma Inglesa
 Daviers, Forme Anglaise



87
 Fig. 87

Untere Molaren
 Lower molars
 Molari inferiori
 Molares inferiores
 Molaires inférieures



89
 Fig. 89

Obere Molaren, rechts
 Upper molars, right
 Molari superiori, destra
 Molares superiores, derechos
 Molaires supérieures, droites

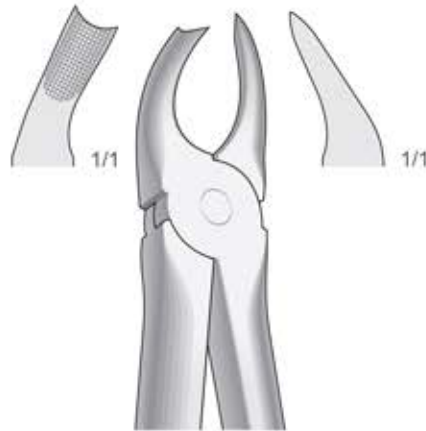

90
 Fig. 90

Obere Molaren, links
 Upper molars, left
 Molari superiori, sinistra
 Molares superiores, izquierdos
 Molaires supérieures, gauches



Zahnzangen, Englische Form
Extracting Forceps, English Pattern
Pinze per estrazione, Forma Inglese
Pinzas da extracción, Forma Inglesa
Daviers, Forme Anglaise



55
Fig. 55

Zum Trennen oberer Molarenwurzeln
For separating upper molar roots
Per radici dei molari superiori, presa in profondità
Para partir raices de molares superiores, profundo
Pour séparer les racines des molaires supérieures



68
Fig. 68

Untere Wurzeln
Lower Roots
Radici inferiori
Raices inferiores
Racines inférieures

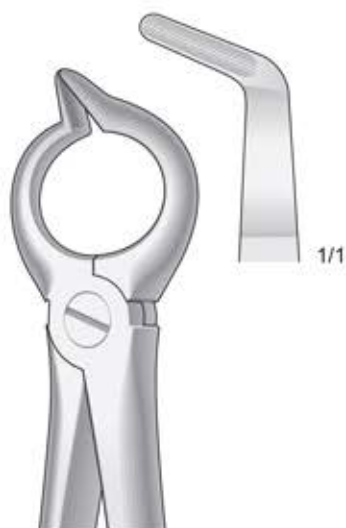

68A
Fig. 68A

Untere Wurzeln
Lower Roots
Radici inferiori
Raices inferiores
Racines inférieures



56
Fig. 56

Zum Trennen Unterer Molarenwurzeln
For separating lower molar roots
Per radici dei molari inferiori, presa in profondità
Para partir raices de molares inferiores, profundo
Pour séparer les racines des molaires inférieures



Zahnzangen, Englische Form
 Extracting Forceps, English Pattern
 Pinze per estrazione, Forma Inglese
 Pinzas da extracción, Forma Inglesa
 Daviers, Forme Anglaise

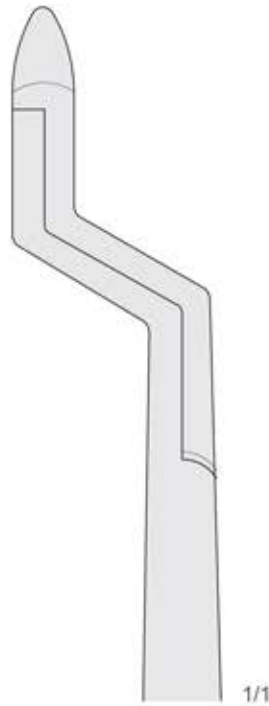
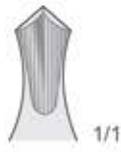

Untere Molaren und Weisheitszähne, rechts
 Lower molars and wisdom teeth, right
 Molari e denti del giudizio inferiori, a destra
 Molares y muelas del juicio inferiores, derecha
 Molaire et dent de sagesse inférieures, droites

ROUTURIER
 22 ½ R

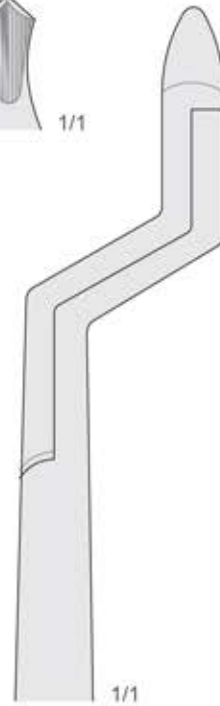
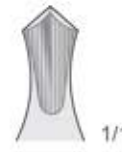

Untere Molaren und Weisheitszähne, links
 Lower molars and wisdom teeth, left
 Molari e denti del giudizio inferiori, a sinistra
 Molares y muelas del juicio inferiores, izquierda
 Molaire et dent de sagesse inférieures, gauches

ROUTURIER
 22 ½ L



Zahnzangen, Englische Form
Extracting Forceps, English Pattern
Pinze per estrazione, Forma Inglese
Pinzas da extracción, Forma Inglesa
Daviers, Forme Anglaise



49
Fig. 49



1/1



48
Fig. 48 - 44

Obere Wurzeln
Upper roots
Radici superiori
Raíces superiores
Racines supérieures



1/1



46L
Fig. 46L



1/1

Obere Wurzeln sehr feine
Upper very fine roots
Radici superiori molto sottili
Raíces superiores muy finas
Racines supérieures très fines

Untere Wurzeln
Lower roots
Radici inferiori
Raíces inferiores
Racines inférieures



Zahnzangen, Paßformgriff
 Extracting Forceps, Anatomical Handle
 Pinze per estrazione, Manico anatomico
 Pinzas da extracción, Mango anatómico
 Daviers, Manche anatomique

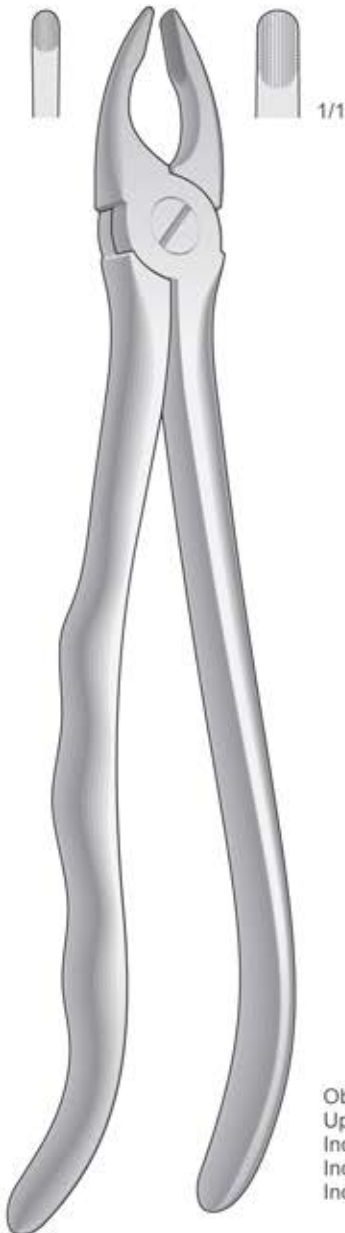

S-3AN
 Fig. 3

Obere Schneide- und Eckzähne
 Upper incisors and cuspids
 Incisivi e canini superiori
 Incisivos y caninos superiores
 Incisives et canines supérieures

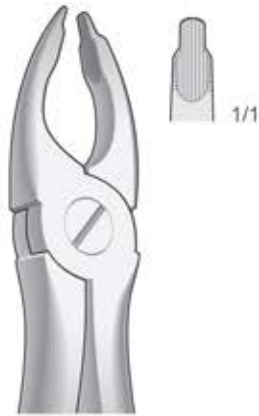

S-34
 Fig. 34

Obere Schneide- und Eckzähne
 Upper incisors and cuspids
 Incisivi e canini superiori
 Incisivos y caninos superiores
 Incisives et canines supérieures

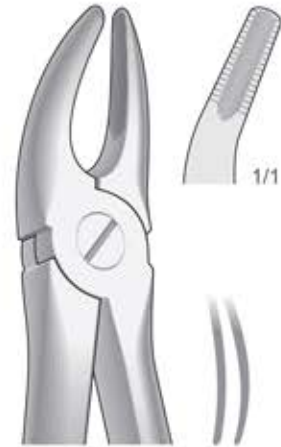

S-7
 Fig. 7

Obere Prämolaren
 Upper premolars
 Premolari superiori
 Premolares superiores
 Prémolaires supérieures

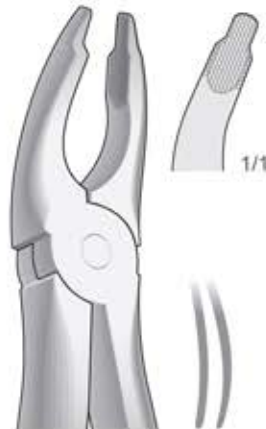

S-35
 Fig. 35

Obere Schneidezähne und Prämolaren, tiefgreifend
 Upper incisors and bicuspid, deep-gripping
 Incisivi e premolari superiori, presa in profondità
 Incisivos y premolares superiores, a gran calado
 Incisives et prémolaires supérieures, à attaque profonde



Zahnzangen, Paßformgriff
Extracting Forceps, Anatomical Handle
Pinze per estrazione, Manico anatomico
Pinzas da extracción, Mango anatómico
Daviers, Manche anatomique

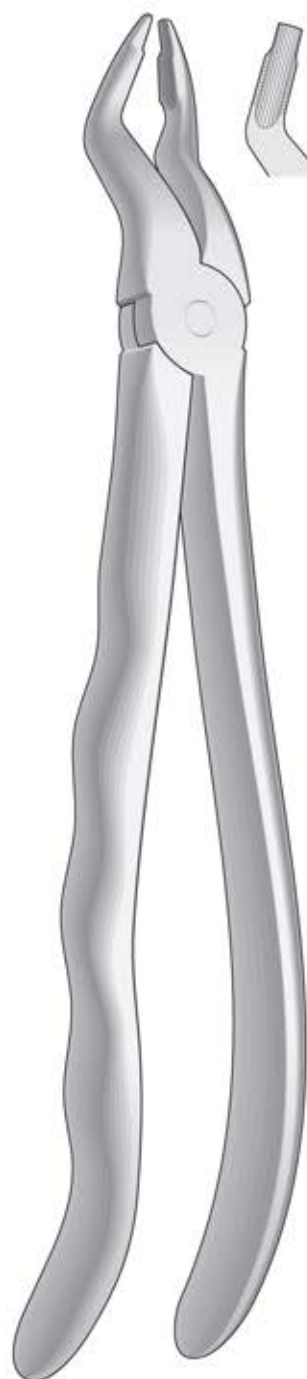

S-31
Fig. 31

Obere Prämolaren
Upper premolars
Premolari superiori
Premolares superiores
Prémolaires supérieures



S-66R
Fig. 66R (89)

Obere Molaren, rechts
Upper molars, right
Molari superiori, destra
Molares superiores, derechos
Molaires supérieures, droites



S-66L
Fig. 66L (90)

Obere Molaren, links
Upper molars, left
Molari superiori, sinistra
Molares superiores, izquierdos
Molaires supérieures, gauches

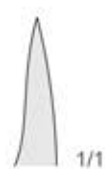



Zahnzangen, Paßformgriff
 Extracting Forceps, Anatomical Handle
 Pinze per estrazione, Manico anatomico
 Pinzas da extracción, Mango anatómico
 Daviers, Manche anatomique

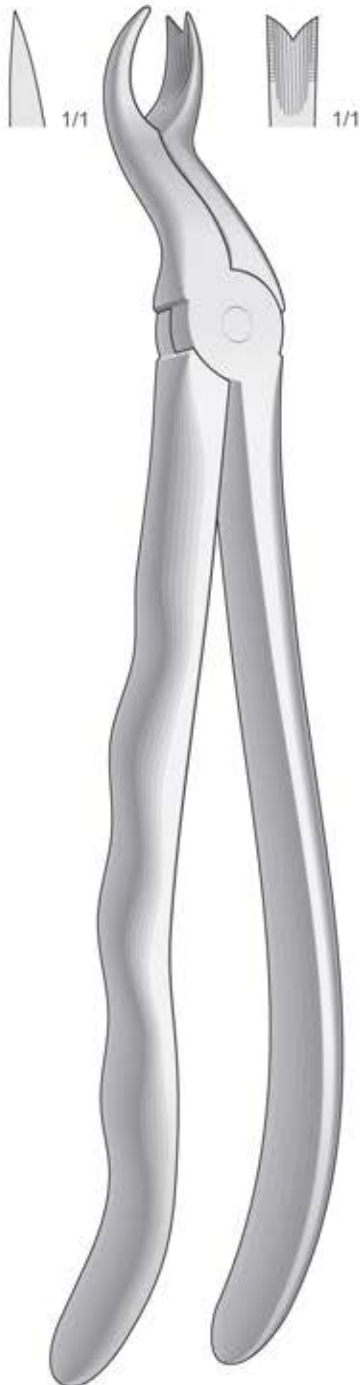

S-67R
 Fig. 67R

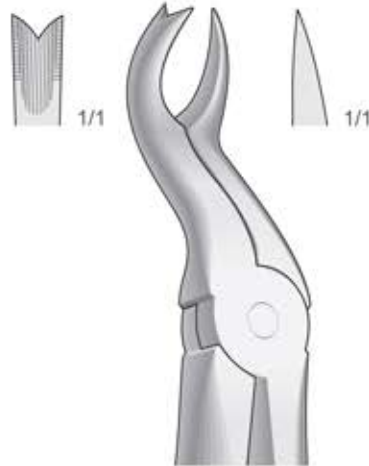

S-67L
 Fig. 67L

Obere Molaren, links
 Upper molars, left
 Molari superiori, sinistra
 Molares superiores, izquierdos
 Molaires supérieures, gauches



S-67N
 Fig. 67N

Obere Molaren
 Upper molars
 Molari superiori
 Molares superiores
 Molaires supérieures

Obere Molaren, rechts
 Upper molars, right
 Molari superiori, destra
 Molares superiores, derechos
 Molaires supérieures, droites



Zahnzangen, Paßformgriff
Extracting Forceps, Anatomical Handle
Pinze per estrazione, Manico anatomico
Pinzas da extracción, Mango anatómico
Daviers, Manche anatomique



FELSCH
S-80
Fig. 80

Für obere Weisheitszähne, mit Fangvorrichtung
For upper wisdom teeth, with retaining device
Denti del giudizio superiori, con dispositivo di presa
Muelas del juicio superiores, con dispositivo de retencion
Pour dents de sagesse supérieures, mors conçus pour recueillir la dent



S-51B
Fig. 51B

Obere Dritte Molaren
Upper molars
Ottavi superiori
Molares superiores
Molaires supérieures



S-97
Fig. 97

Obere Wurzelplitterzange
Upper Root Fragments
Frammenti e radici superiori
Fragmentos de raices superiores
Fragments des racines supérieures

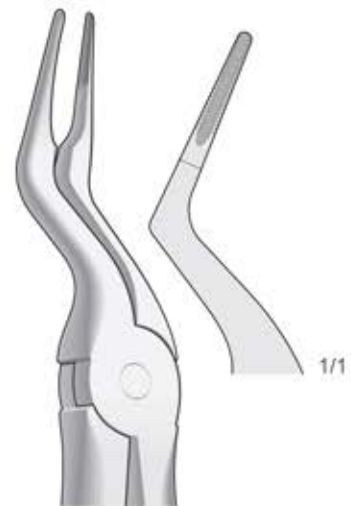

S-97B
Fig. 97B

Obere Wurzelplitterzange
Upper Root Fragments
Frammenti e radici superiori
Fragmentos de raices superiores
Fragments des racines supérieures



Zahnzangen, Paßformgriff
 Extracting Forceps, Anatomical Handle
 Pinze per estrazione, Manico anatomico
 Pinzas da extracción, Mango anatómico
 Daviers, Manche anatomique

Obere Wurzeln sehr feine
 Upper very fine roots
 Radici superiori molto sottili
 Raíces superiores muy finas
 Racines supérieures très fines

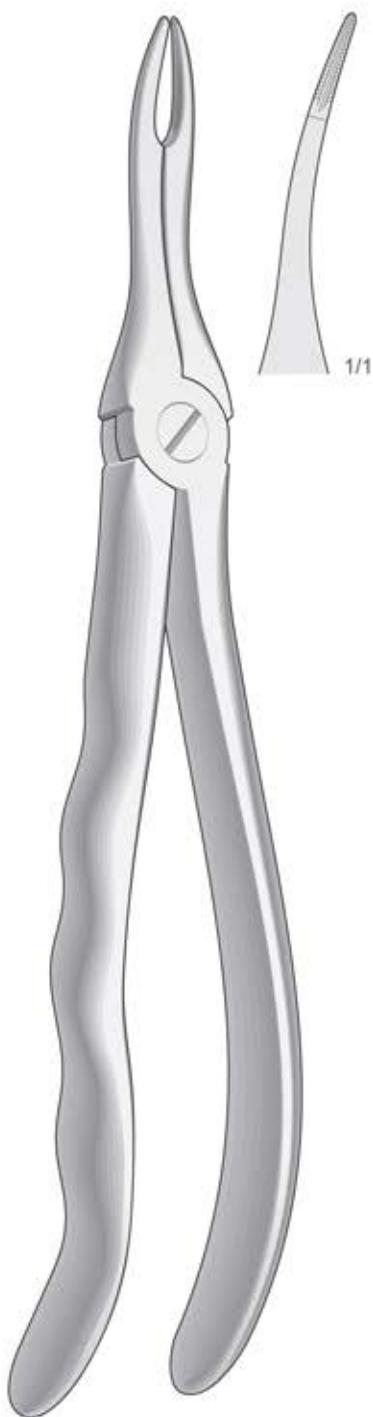

S-49
 Fig. 49



S-51LX
 Fig. 51LX



S-351S
 Fig. 351S



Zahnzangen, Paßformgriff
Extracting Forceps, Anatomical Handle
Pinze per estrazione, Manico anatomico
Pinzas da extracción, Mango anatómico
Daviers, Manche anatomique



I-74N
Fig. 74N

Untere Wurzeln Schneide- und Eckzähne
Lower roots, incisors and cuspids
Radici, incisivi e canini inferiori
Raíces, incisivos y caninos inferiores
Racines, incisives et canines inférieures



I-74
Fig. 74



I-36
Fig. 36

Untere Wurzeln Schneide- und Eckzähne
Lower roots, incisors and cuspids
Radici, incisivi e canini inferiori
Raíces, incisivos y caninos inferiores
Racines, incisives et canines inférieures



I-36N
Fig. 36N

Untere Wurzeln Schneide- und Eckzähne
Lower roots, incisors and cuspids
Radici, incisivi e canini inferiori
Raíces, incisivos y caninos inferiores
Racines, incisives et canines inférieures



Zahnzangen, Paßformgriff
 Extracting Forceps, Anatomical Handle
 Pinze per estrazione, Manico anatomico
 Pinzas da extracción, Mango anatómico
 Daviers, Manche anatomique



I-59
 Fig. 59

Untere Wurzelplitterzange
 Lower Root Fragments
 Frammenti e radici inferiori
 Fragmentos de raíces inferiores
 Fragments des racines inférieures



I-86C
 Fig. 86C

Untere Molaren mit kariösen oder abgebrochenen Kronen
 Lower molars with carious or broken caps
 Molari inferiori con corone cariate o spezzate
 Molares inferiores con coronas rotas o cariadas
 Molaire inférieures avec couronnes cariées ou cassées



I-73
 Fig. 73

Untere Molaren
 Lower molars
 Molari inferiori
 Molares inferiores
 Molaire inférieures

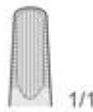

I-13
 Fig. 13

Untere Prämolaren und Eckzähne
 Lower premolars and cuspids
 Canini e premolari inferiori
 Caninos y premolares inferiores
 Canines et prémolaires inférieures



I-22
 Fig. 22

Untere Molaren
 Lower molars
 Molari inferiori
 Molares inferiores
 Molaire inférieures



Zahnzangen, Paßformgriff
Extracting Forceps, Anatomical Handle
Pinze per estrazione, Manico anatomico
Pinzas da extracción, Mango anatómico
Daviers, Manche anatomique

Untere Weisheitszähne
Lower wisdom teeth
Denti del giudizio inferiori
Muelas del juicio inferiores
Dent de sagesse inférieures

Untere Prämolaren
Lower premolars
Premolari inferiori
Premolares inferiores
Prémolaires inférieures

Untere Molaren
Lower Molars
Molari inferiori
Molares inferiores
Molaires inférieures



I-79
Fig. 79

I-79N
Fig. 79N

I-46N
Fig. 46N

I-87
Fig. 87



Zahnzangen, Paßformgriff
 Extracting Forceps, Anatomical Handle
 Pinze per estrazione, Manico anatomico
 Pinzas da extracción, Mango anatómico
 Daviers, Manche anatomique

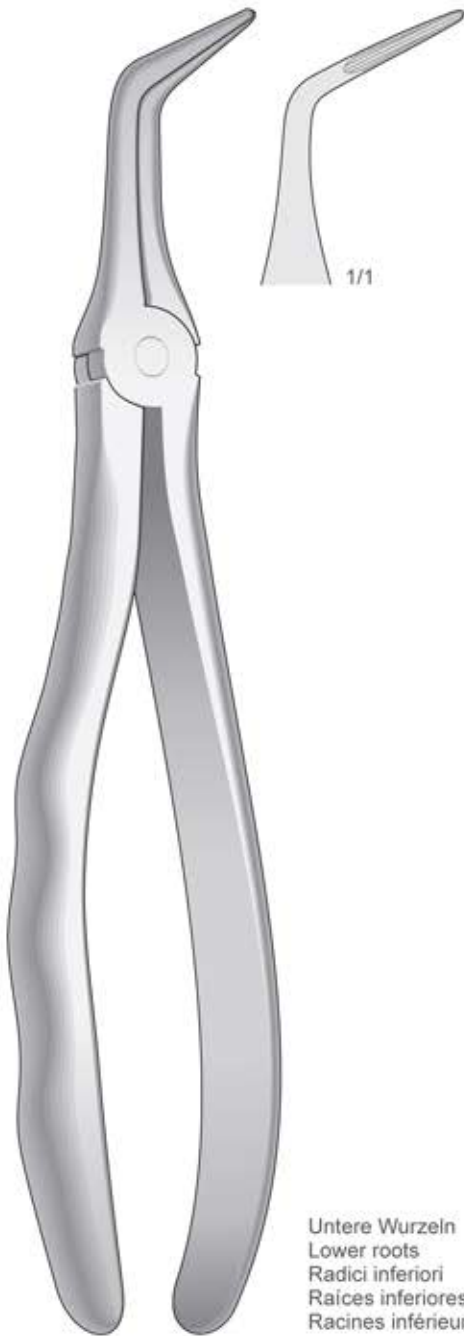

Untere Wurzeln
 Lower roots
 Radici inferiori
 Raíces inferiores
 Racines inférieures

I-46LX
 Fig. 46LX

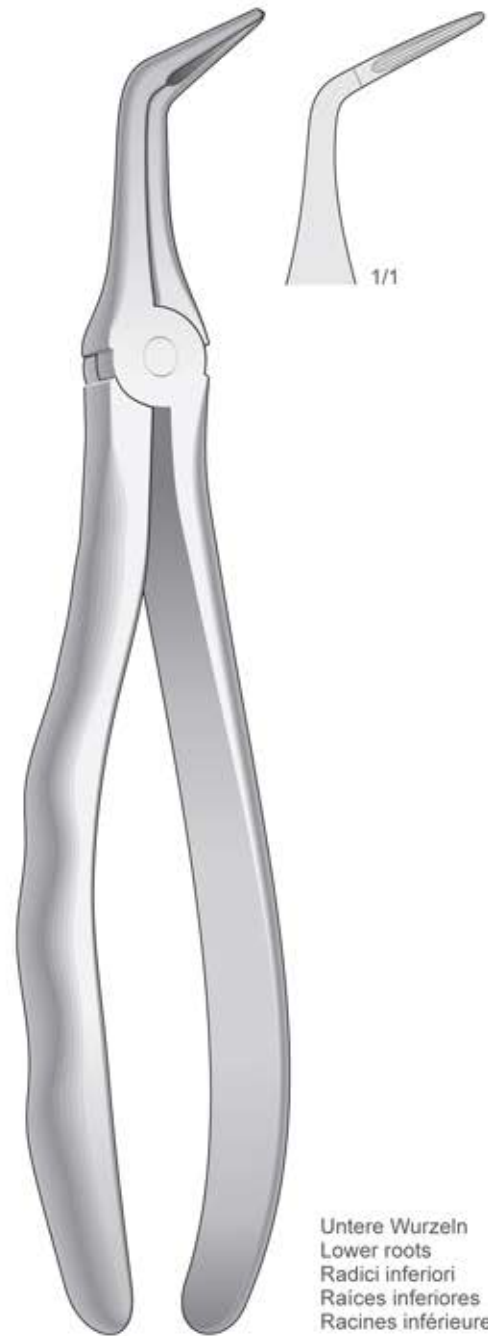

Untere Wurzeln
 Lower roots
 Radici inferiori
 Raíces inferiores
 Racines inférieures

I-46L
 Fig. 46L



Zahnzangen, Paßformgriff
Extracting Forceps, Anatomical Handle
Pinze per estrazione, Manico anatomico
Pinzas da extracción, Mango anatómico
Daviers, Manche anatomique

Untere Molaren und Weisheitszähne
Lower molars and wisdom teeth
Molari e denti del giudizio inferiori
Molares y muelas del juicio inferiores
Molaires et dent de sagesse inférieures



Links
Left
Sinistra
Izquierdos
Gauches

I-22 1/2 L



Rechts
Right
Destra
Derechos
Droites

I-22 1/2 R



Zahnzangen, Paßformgriff
 Extracting Forceps, Anatomical Handle
 Pinze per estrazione, Manico anatomico
 Pinzas da extracción, Mango anatómico
 Daviers, Manche anatomique

Untere Wurzeln sehr feine
 Lower very fine roots
 Radici inferiori molto sottili
 Raíces inferiores muy finas
 Racines inférieures très fines

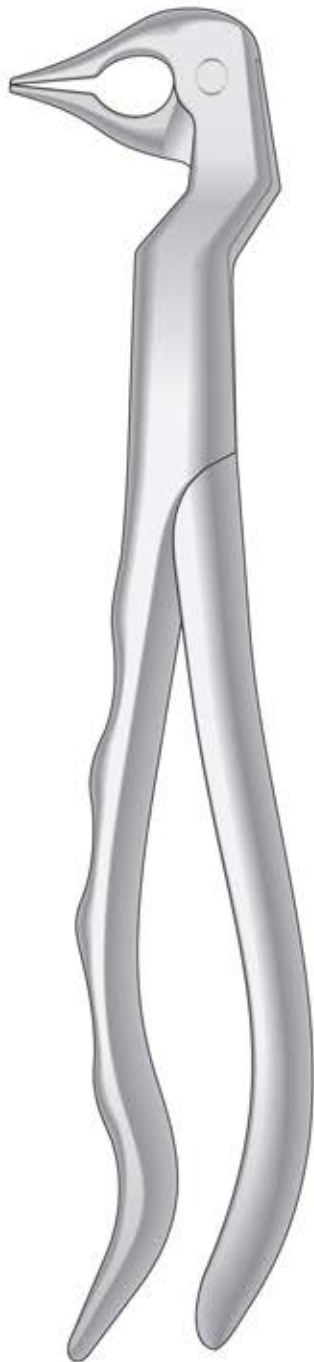

Links
 Left
 Sinistra
 Izquierdos
 Gauches

I-133 L
 Fig.133



Rechts
 Right
 Destra
 Derechos
 Droites

I-133 R
 Fig.133



I-333S
 Fig.333S



Zahnzangen, Amerikanische Form
Extracting Forceps, American Pattern
Pinze per estrazione, Forma Americana
Pinzas da extracci3n, Forma Americana
Daviers, Forme Am3ricaine



AM-1
Fig. 1

Obere Schneide- und Eckzähne
Upper incisors and cuspids
Incisivi e canini superiori
Incisivos y caninos superiores
Incisives et canines sup3rieures



**CRYER
AM-150**
Fig. 150

Obere Pr3molaren, Schneidezähne, Wurzeln
Upper Bicuspid, incisors and roots
Premolari, incisivi e radici superiori
Premolares, incisivos y raices superiores
Pr3molaires, incisives et racines sup3rieures



**CRYER
AM-150A**
Fig. 150A

Obere Pr3molaren, Schneidezähne, Wurzeln
Upper Bicuspid, incisors and roots
Premolari, incisivi e radici superiori
Premolares, incisivos y raices superiores
Pr3molaires, incisives et racines sup3rieures



AM-62
Fig. 62

Schneidezähne, Pr3molaren, Milchzähne
Incisors, premolars, deciduous teeth
Incisivi, premolari, denti da latte
Incisivos, premolares, dientes de leche
Incisives, pr3molaires, dents de lait



Zahnzangen, Amerikanische Form
 Extracting Forceps, American Pattern
 Pinze per estrazione, Forma Americana
 Pinzas da extracción, Forma Americana
 Daviers, Forme Américaine

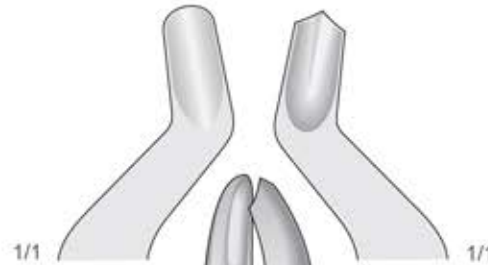
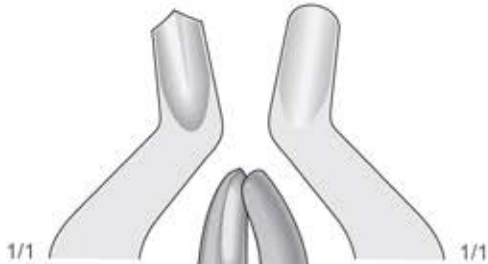

AM-53L
 Fig. 53L

Obere Molaren, Links
 Upper Molars, Left
 Molari superiori, Sinistra
 Molares superiores, Izquierdos
 Molaires supérieures, Gauches

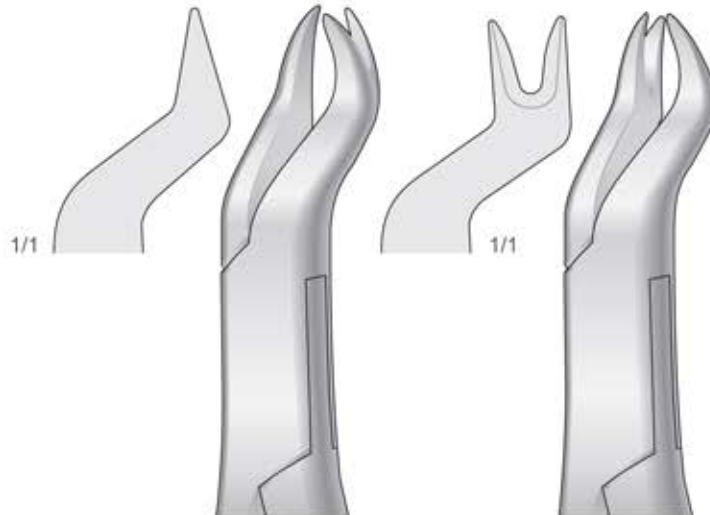

NEVIUS
AM-88R
 Fig. 88R

Obere Molaren, Rechts
 Upper Molars, Right
 Molari superiori, Destra
 Molares superiores, Derechos
 Molaires supérieures, Droites

NEVIUS
AM-88L
 Fig. 88L

Obere Molaren, Links
 Upper Molars, Left
 Molari superiori, Sinistra
 Molares superiores, Izquierdos
 Molaires supérieures, Gauches

AM-53R
 Fig. 53R



Zahnzangen, Amerikanische Form
Extracting Forceps, American Pattern
Pinze per estrazione, Forma Americana
Pinzas da extracci3n, Forma Americana
Daviers, Forme Américaine

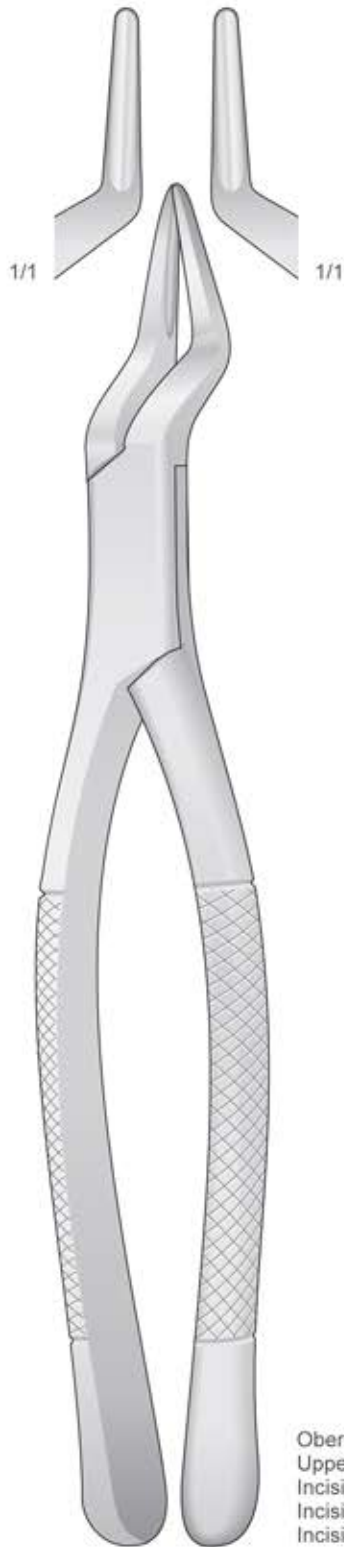

AM-65
Fig.65

Obere Schneidezähne und Wurzeln
Upper Incisors and Roots
Incisivi e radici superiori
Incisivos y raices superiores
Incisives et racines supérieures

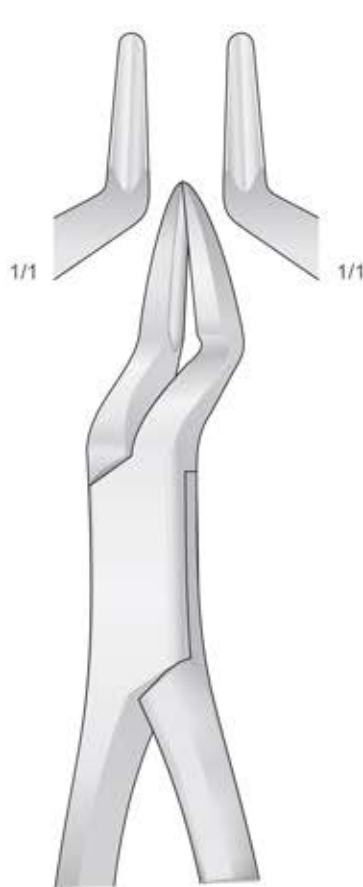

PARMLY
AM-32A
Fig. 32A

Obere Wurzeln und Prämolaren
Upper Roots and Premolars
Radici e premolari superiori
Raices y premolares superiores
Racines et prémolaires supérieures

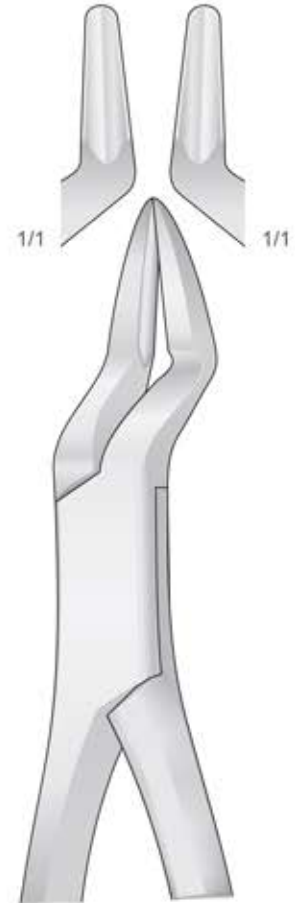

PARMLY
AM-32
Fig. 32

Obere Prämolaren und Molaren
Upper Premolars and Molars
Premolari e molari superiori
Premolares y Molares superiores
Prémolaires et Molaires supérieures



Zahnzangen, Amerikanische Form
 Extracting Forceps, American Pattern
 Pinze per estrazione, Forma Americana
 Pinzas da extracción, Forma Americana
 Daviers, Forme Américaine



AM-24
 Fig. 24



HARRIS
AM-18R
 Fig. 18R

Obere Molaren, Rechts
 Upper Molars, Right
 Molari superiori, Destra
 Molares superiores, Derechos
 Molaires supérieures, Droites



HARRIS
AM-18L
 Fig. 18L

Obere Molaren, Links
 Upper Molars, Left
 Molari superiori, Sinistra
 Molares superiores, Isquierdos
 Molaires supérieures, Gauches



AM-210
 Fig. 210

Obere Molaren
 Upper Molars
 Molari superiori
 Molares superiores
 Molaires supérieures

Obere Molaren
 Upper Molars
 Molari superiori
 Molares superiores
 Molaires supérieures



Zahnzangen, Amerikanische Form
Extracting Forceps, American Pattern
Pinze per estrazione, Forma Americana
Pinzas da extracciòn, Forma Americana
Daviers, Forme Américaine



1/1 1/1

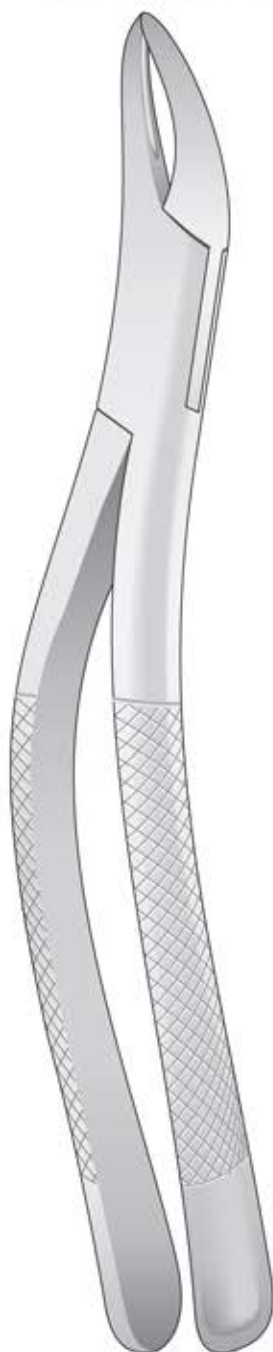

TOMES
AM-69
Fig.69

Obere und Untere
Upper and lower
Superiori e inferiori
Superiores y inferiores
Supérieures et inférieures

Wurzeln
Roots
Radici
Raices
Racines



1/1 1/1

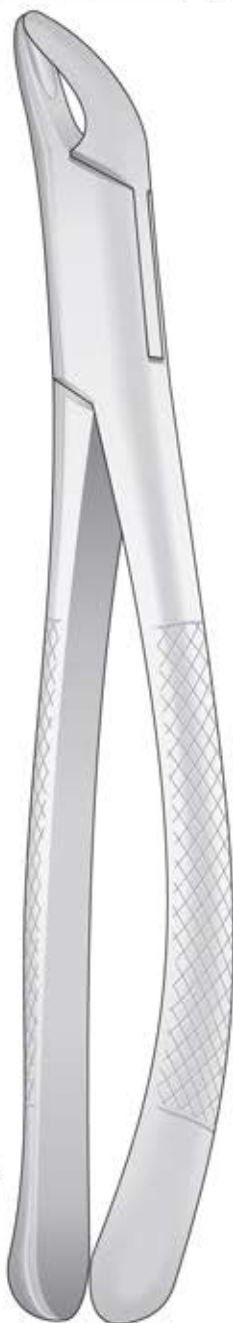

CRYER
AM-151
Fig.151

Untere
Lower
Inferiori
Inferiores
Inférieures

Schneidezähne, Prämolaren, Wurzeln
Incisors, Premolars, Roots
Incisivi, premolari, radici
Incisivos, premolares, raices
Incisives, prémolaires, racines



1/1 1/1



HULL
AM-101
Fig. 101

Für Eckzähne und Prämolaren,
Universalzange und Kinderzange
For canines and Premolars,
Universal and Tooth forceps for children
Canini e premolari,
universale e per bambini
Caninos y premolares,
universal y para niños
Canines et prémolaires,
universel et pour enfants



Zahnzangen, Amerikanische Form
 Extracting Forceps, American Pattern
 Pinze per estrazione, Forma Americana
 Pinzas da extracción, Forma Americana
 Daviers, Forme Américaine



AM-203
 Fig. 203

Untere Schneidezähne, Prämolaren, Wurzeln
 Lower Incisors, Premolars, Roots
 Incisivi, premolari, radici inferiori
 Incisivos, premolares, raices inferiores
 Incisives, prémolaires, racines inférieures



AM-17
 Fig. 17

Untere Molaren
 Lower Molars
 Molari inferiori
 Molares inferiores
 Molaires inférieures



AM-23
 Fig. 23

Untere Molaren
 Lower Molars
 Molari inferiori
 Molares inferiores
 Molaires inférieures



Zahnzangen, Amerikanische Form
Extracting Forceps, American Pattern
Pinze per estrazione, Forma Americana
Pinzas da extracciòn, Forma Americana
Daviers, Forme Américaine



AM-16
Fig. 16

Untere Molaren
Lower Molars
Molari inferiori
Molares inferiores
Molaires inférieures

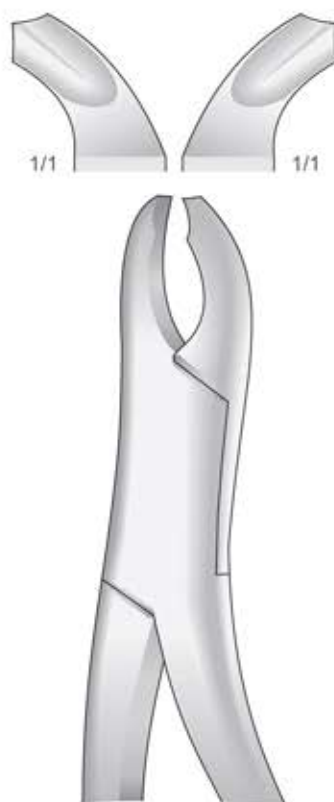

HARRIS
AM-15
Fig. 15

Untere Molaren
Lower Molars
Molari inferiori
Molares inferiores
Molaires inférieures



AM-103
Fig. 103

Untere Schneidezähne, Prämolaren, Wurzeln
Lower Incisors, Premolars, Roots
Incisivi, premolari, radici inferiori
Incisivos, premolares, raices inferiores
Incisives, prémolaires, racines inférieures



Zahnzangen, Amerikanische Form
 Extracting Forceps, American Pattern
 Pinze per estrazione, Forma Americana
 Pinzas da extracción, Forma Americana
 Daviers, Forme Américaine

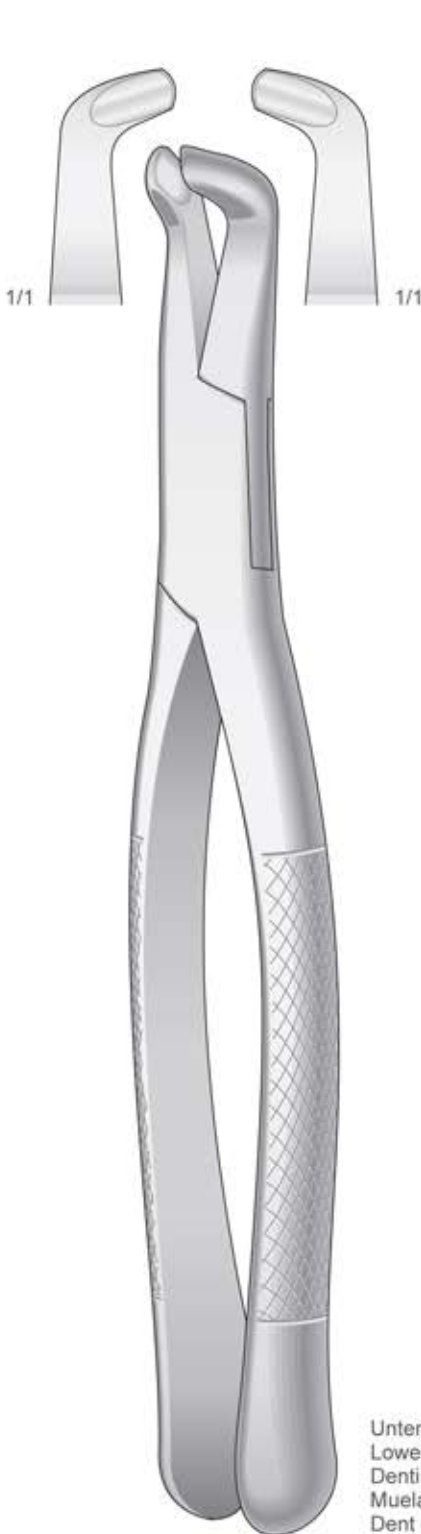

AM-222
 Fig. 222

Untere Weisheitszähne
 Lower wisdom teeth
 Denti del giudizio inferiori
 Muelas del juicio inferiores
 Dent de sagesse inférieures

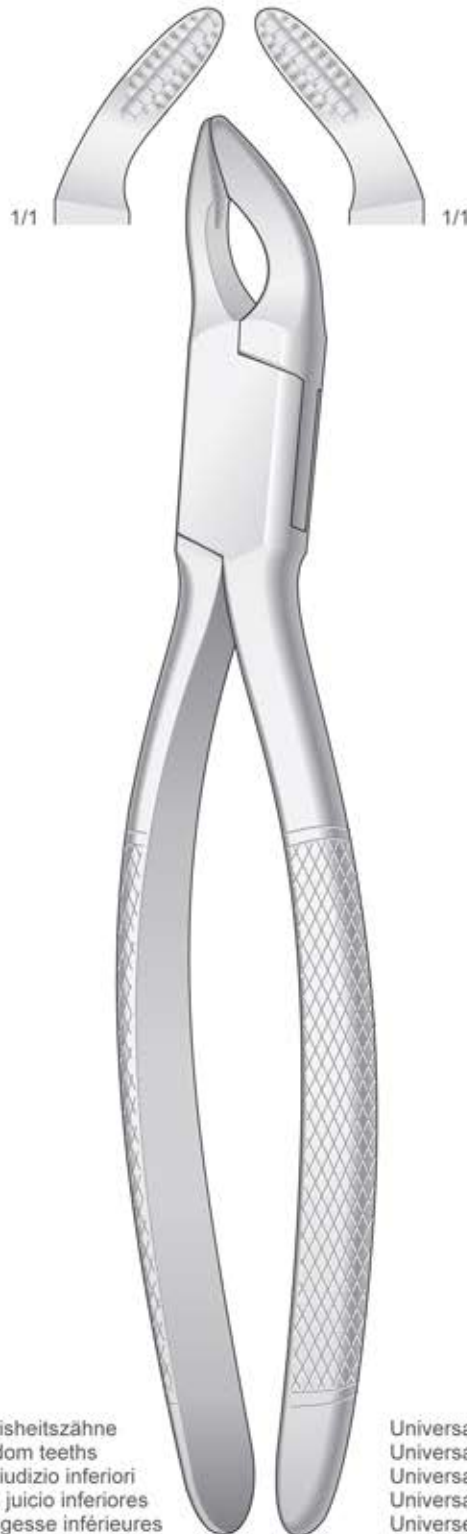

COHEN
AM-250

Universal
 Universal
 Universale
 Universal
 Universel

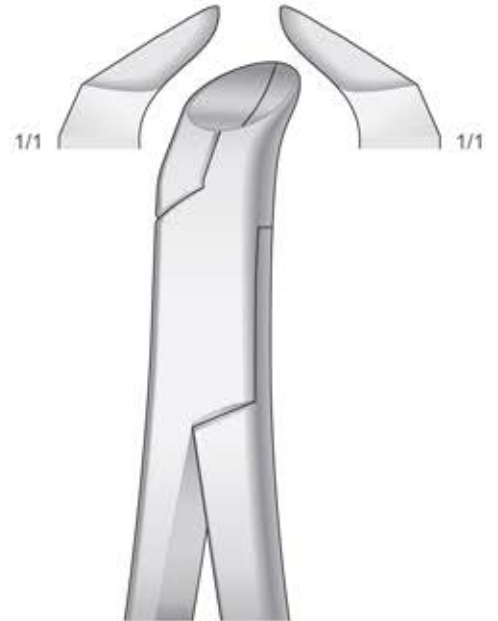

PHYSICK
AM-5
 Fig. 5

Untere Weisheitszähne
 Lower wisdom teeth
 Denti del giudizio inferiori
 Muelas del juicio inferiores
 Dent de sagesse inférieures



Zahnzangen, Amerikanische Form
 Extracting Forceps, American Pattern
 Pinze per estrazione, Forma Americana
 Pinzas da extracci3n, Forma Americana
 Daviers, Forme Am3ricaine

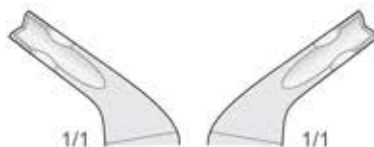

Obere
 Upper
 Superiori
 Superiores
 Sup3rieures

Pr3molaren, Schneidez3hne und Wurzeln
 Bicuspid, incisors and roots
 Premolari, incisivi e radici
 Premolares, incisivos y raices
 Premolaires, incisives et racines

AM-150X
 Fig. 150AS



Untere
 Lower
 Inferiori
 Inferiores
 Inf3rieures

Pr3molaren, Schneidez3hne und Wurzeln
 Bicuspid, incisors and roots
 Premolari, incisivi e radici
 Premolares, incisivos y raices
 Premolaires, incisives et racines

AM-151X
 Fig. 151AS



Zahnzangen, Amerikanische Form
 Extracting Forceps, American Pattern
 Pinze per estrazione, Forma Americana
 Pinzas da extracci3n, Forma Americana
 Daviers, Forme Am3ricaine

F3r Kinder
 For children
 Per bambini
 Para ni3os
 Pour enfants



CRYER
AM-150S
 Fig.150 S

AM-150AS
 Fig.150 XAS

CRYER
AM-151S
 Fig.151 S

AM-151AS
 Fig.151 XAS



Zahnzangen, Amerikanische Form
Extracting Forceps, American Pattern
Pinze per estrazione, Forma Americana
Pinzas da extracción, Forma Americana
Daviers, Forme Américaine

Geriefte - Serrated - Striata - Estriadas - Striées

Obere Schneidezähne, Prämolaren, Wurzeln
Upper incisors, premolars, roots
Incisivi, premolari e radici superiori
Incisivos, premolares y raíces superiores
Incisives, prémolaires et racines supérieures

Untere Schneidezähne, Prämolaren, Wurzeln
Lower incisors, premolars, roots
Incisivi, premolari e radici inferiori
Incisivos, premolares y raíces inferiores
Incisives, prémolaires et racines inférieures

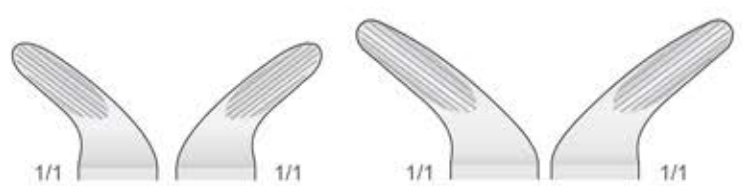
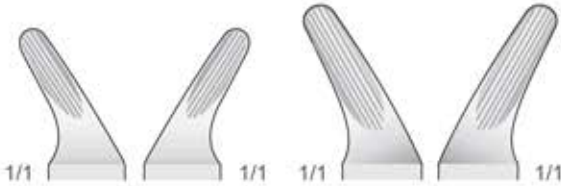

CRYER
AMG-150
Fig. 150

Für Erwachsene
For adults
Per adulti
Para adultos
Pour adults

Für Kinder
For children
Per bambini
Para niños
Pour enfants

CRYER
AMG-150S
Fig.150 S



CRYER
AMG-151
Fig. 151

Für Erwachsene
For adults
Per adulti
Para adultos
Pour adults

Für Kinder
For children
Per bambini
Para niños
Pour enfants

CRYER
AMG-151S
Fig.151 S



Zahnzangen
 Extracting Forceps
 Pinze per estrazione
 Pinzas da extracción
 Daviers

Schneidezähne, Eckzähne, Wurzeln
 Incisors, bicuspid and roots
 Incisivi, canini e radici
 Incisivos, caninos y raíces
 Incisives, canines et racines

Molaren
 Molars
 Molari
 Molares
 Molaïres

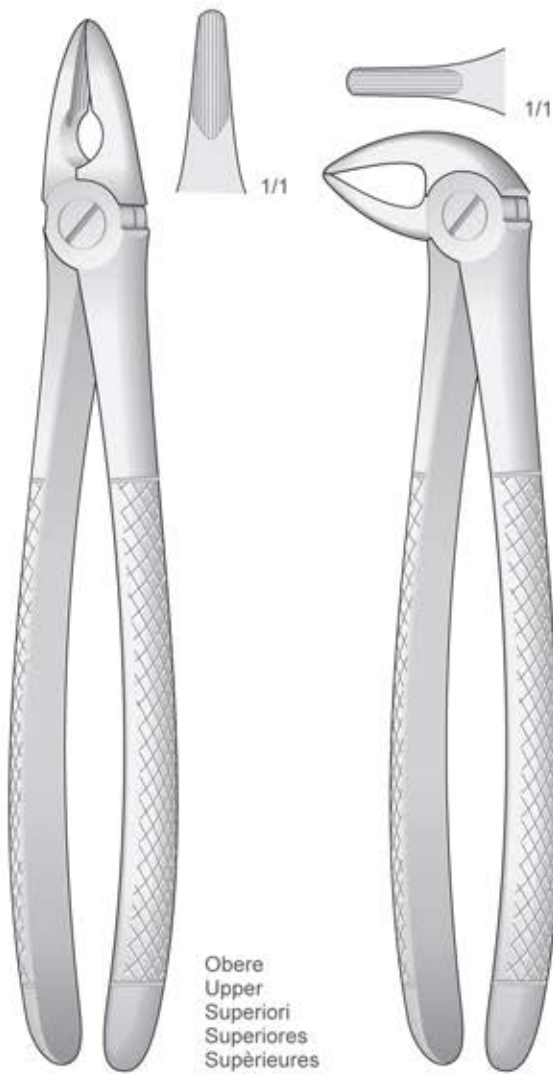

Obere
 Upper
 Superiori
 Superiores
 Supérieures

Untere
 Lower
 Inferiori
 Inferiores
 Inférieures

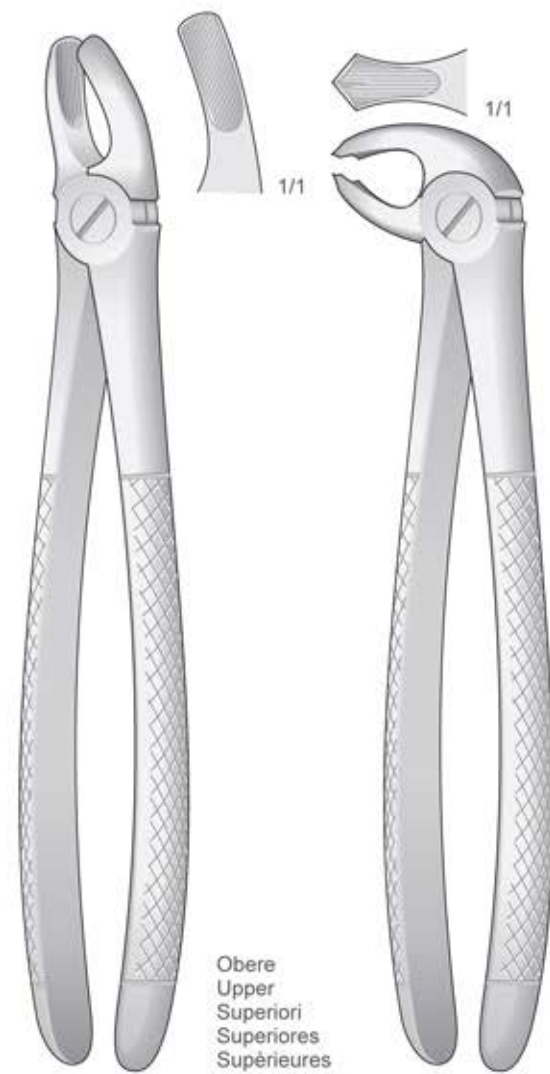

Obere
 Upper
 Superiori
 Superiores
 Supérieures

Untere
 Lower
 Inferiori
 Inferiores
 Inférieures

MEAD
 MD-1

MEAD
 MD-3

MEAD
 MD-2

MEAD
 MD-4



Kinderzahnzangen, Amerikanische Form
Extracting Forceps for children, American Pattern
Pinze per estrazione per bambini, Forma Americana
Forceps dentales para niños, Forma Americana
Daviers pour enfants, Forme Américaine

Molaren
Pedo Lower Molars
Molari
Molares
Molaires

Molaren
Pedo Lower Molars
Molari
Molares
Molaires

Zähne und wurzeln
Pedo upper incisors
Bicuspids and roots
Denti e radici
Dientes y raices
Dentes et racines

Zähne und wurzeln
Pedo lower incisors
Bicuspids and roots
Denti e radici
Dientes y raices
Dentes et racines

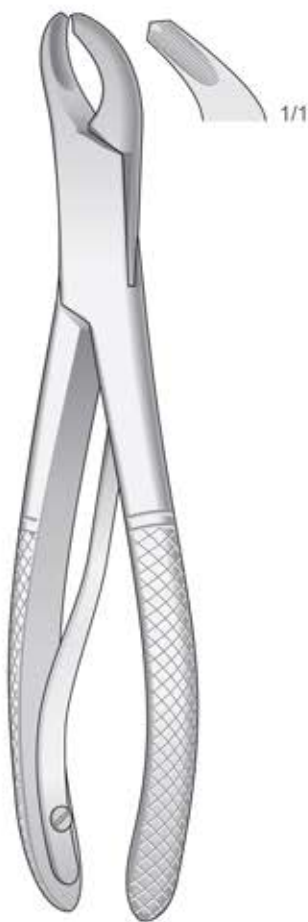

PEB-17S
Fig. 17SK

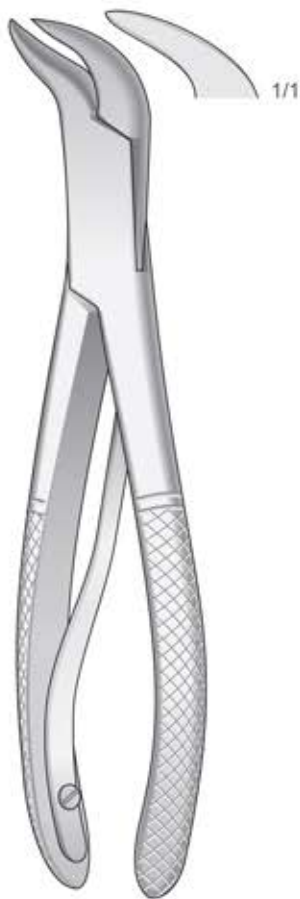

PEB-23S
Fig. 23SK



PEB-150S
Fig. 150SK

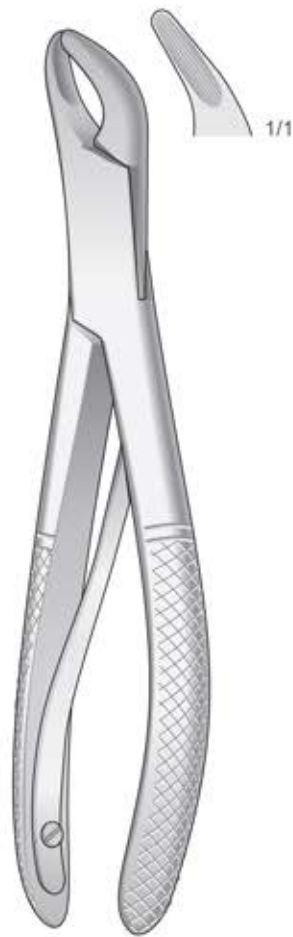

PEB-151S
Fig. 151SK



Kinderzahnzangen
 Extracting Forceps for children
 Pinze per estrazione per bambini
 Forceps dentales para niños
 Daviers pour enfants



PEB-1
 Fig. 137

Obere Schneidezähne
 Upper Incisors
 Incisivi superiori
 Incisivos superiores
 Incisives supérieures

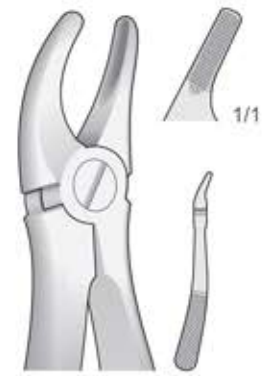

PEB-2
 Fig. 139

Obere Prämolaren
 Upper Premolars
 Premolari superiori
 Premolares superiores
 Prémolaires supérieures



PEB-4
 Fig. 51S

Obere Wurzeln
 Upper roots
 Radici superiori
 Raíces superiores
 Racines supérieures

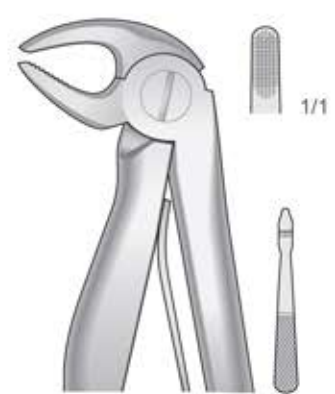

PEB-5
 Fig. 5

Untere Schneidezähne
 Lower incisors
 Incisivi inferiori
 Incisivos inferiores
 Incisives inférieures

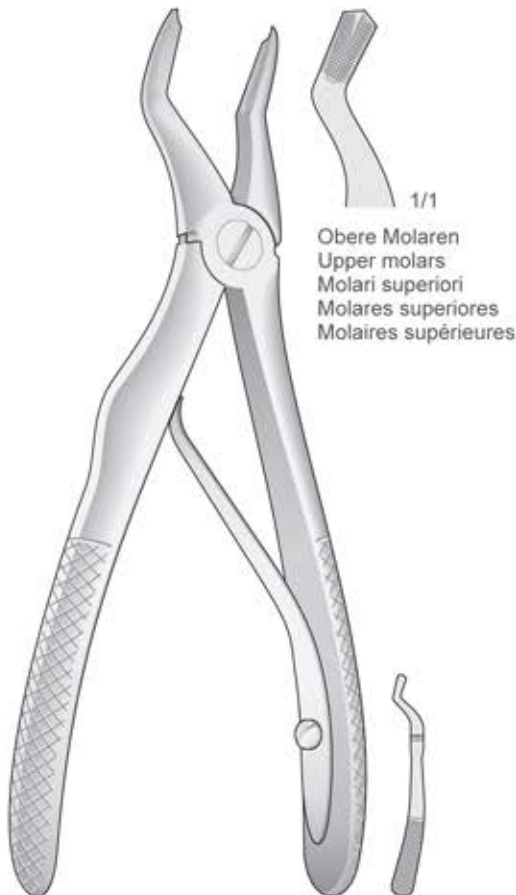

PEB-3

Obere Molaren
 Upper molars
 Molari superiori
 Molares superiores
 Molaires supérieures



PEB-6
 Fig. 6

Untere Molaren
 Lower Molars
 Molari inferiori
 Molares inferiores
 Molaires inférieures

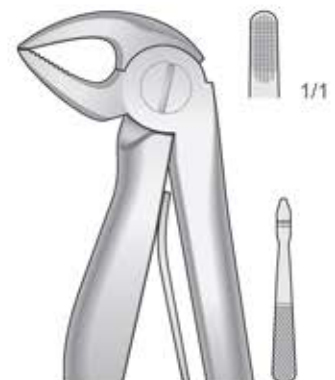

PEB-7
 Fig. 7

Untere Wurzeln
 Lower roots
 Radici inferiori
 Raíces inferiores
 Racines inférieures



Zahnzangen
Extracting Forceps
Pinze per estrazione
Pinzas da extracción
Daviers



Obere Wurzeln, Universal
Upper roots, Universal
Radici superiori, Universale
Raices superiores, Universal
Racines superieures, Universel

**WITZEL
DK-26**
170 mm



Untere Wurzeln, Universal
Lower roots, Universal
Radici inferiori, Universale
Raices inferiores, Universal
Racines inferieures, Universel

**WITZEL
DK-28**
165 mm



Obere Wurzeln, Universal
Upper roots, Universal
Radici superiori, Universale
Raices superiores, Universal
Racines superieures, Universel

400 (300)
165 mm



Untere Wurzeln, Universal
Lower roots, Universal
Radici inferiori, Universale
Raices inferiores, Universal
Racines inferieures, Universel

401 (301)
160 mm



Wurzelfragmentinstrumente
 Root Fragment Forceps
 Strumenti per frammenti di radici
 Instrumentos para fragmentos de raíces
 Instruments pour fragments de racines



PEET
DR-40
 120 mm

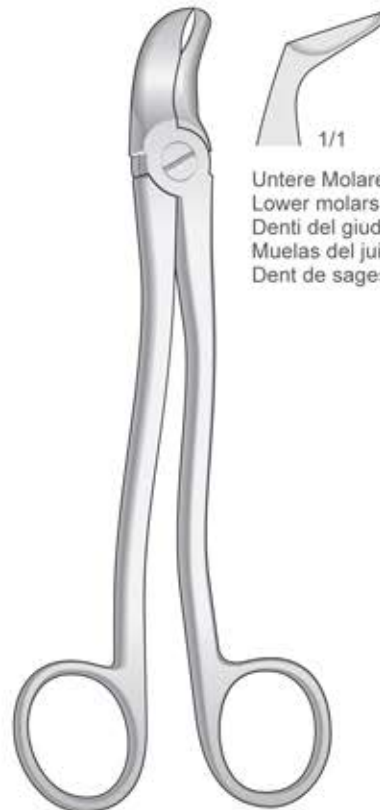

RO-1
 175 mm

Untere Molaren und Weisheitszähne
 Lower molars and wisdom teeth
 Denti del giudizio e molari inferiori
 Muelas del juicio y molares inferiores
 Dent de sagesse et molaires inférieures

Wurzelfragmente
 Root fragments
 Frammenti di radici
 Fragmentos de raíces
 Fragments de racines

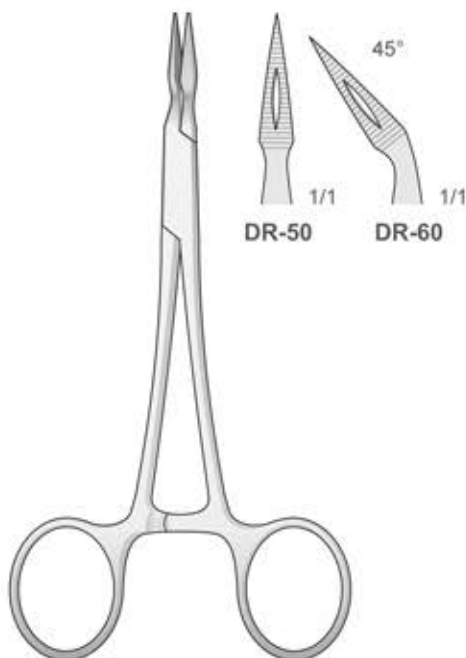

STIEGLITZ
DR-50/DR-60
 140 mm

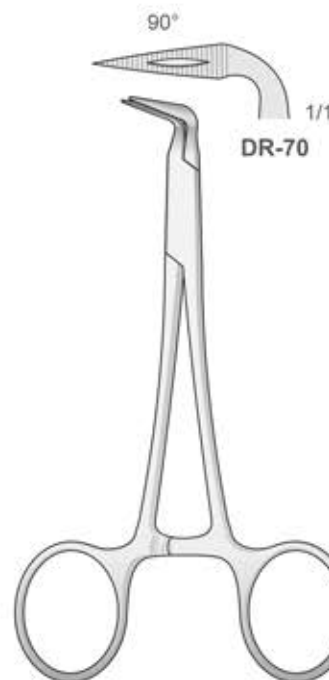

STIEGLITZ
DR-70
 120 mm



Wurzelfragmentinstrumente
Root Fragment Forceps
Strumenti per frammenti di radici
Instrumentos para fragmentos de raíces
Instruments pour fragments de racines



Diamantiert
With Diamond
Con diamante
Diamantada
Diamantées

DA-01M
130 mm

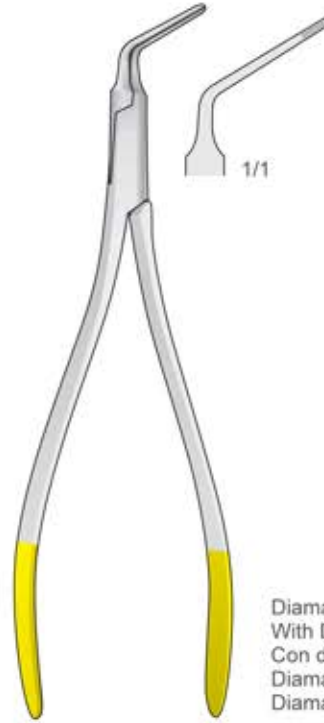

Diamantiert
With Diamond
Con diamante
Diamantada
Diamantées

DA-10
130 mm



DA-01
130 mm



DA-02
130 mm



DA-03
125 mm

B

Root Elevators
Wurzelheber
Elevatori per radici
Elevadores para raíces
Élévateurs pour racines





Wurzelheber
 Root Elevators
 Leve per radici
 Elevadores para raíces
 Elevateurs à racines

SMALL HANDLE

Luxatoren - Luxators
 Lussatori - Luxadores
 Luxateurs

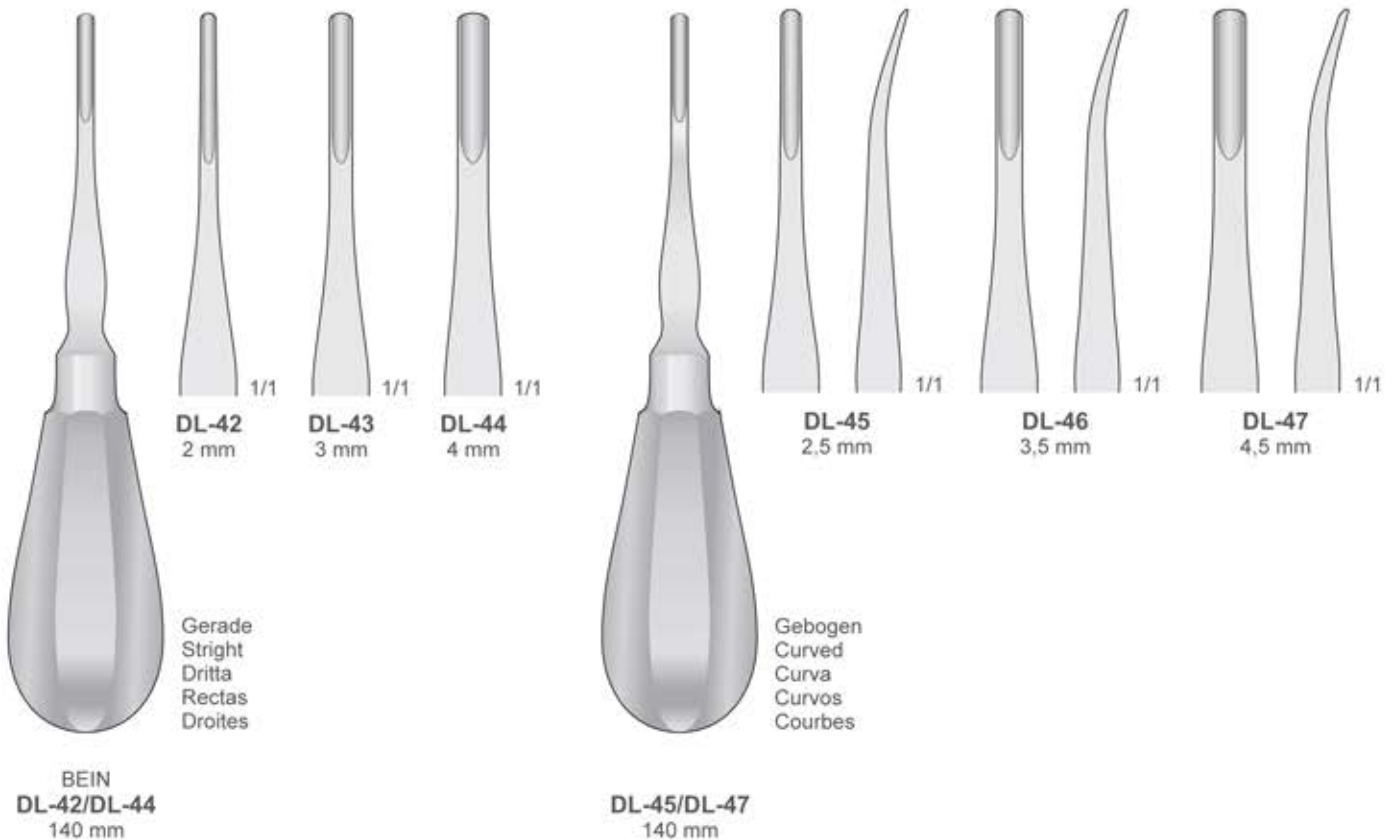
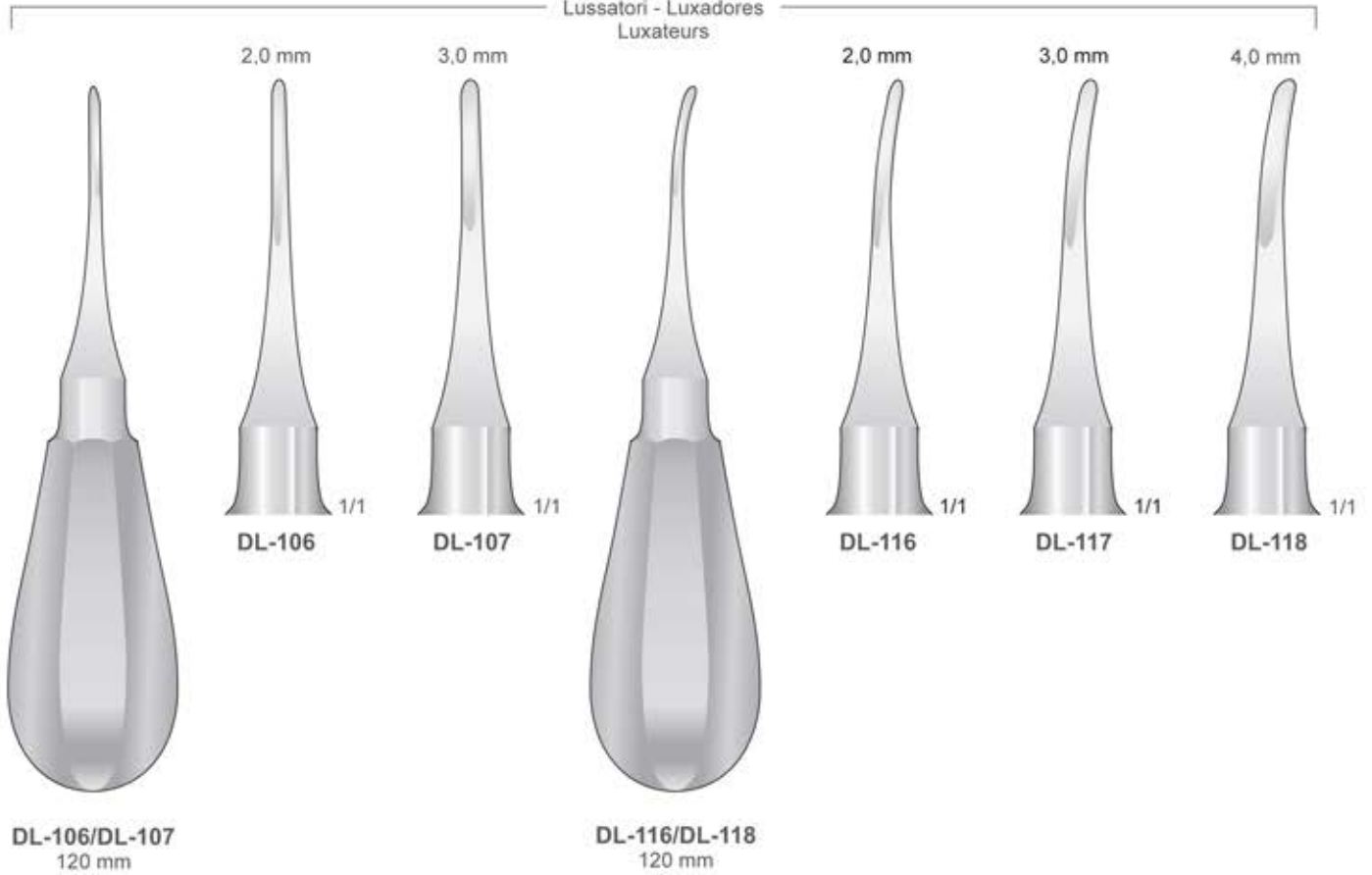



Wurzelheber
Root Elevators
Leve per radici
Elevadores para raíces
Elevateurs à racines



2,0 mm

1/1

DL-81
150 mm



2,5 mm

1/1

DL-82
150 mm



3,0 mm

1/1

DL-83
150 mm



3,5 mm

1/1

DL-84
150 mm



4,0 mm

1/1

DL-85
150 mm



4,5 mm

1/1

DL-86
150 mm



5,0 mm

1/1

DL-87
150 mm



DL-81/DL-87
150 mm



Wurzelheber
Root Elevators
Leve per radici
Elevadores para raíces
Elevateurs à racines





Wurzelheber
Root Elevators
Leve per radici
Elevadores para raíces
Elevateurs à racines

Luxatoren
Luxators
Lussatori
Luxadores
Luxateurs

2,0 mm



DL-102
150 mm

3,0 mm



DL-103
150 mm

2,0 mm



DL-112
150 mm

3,0 mm



DL-113
150 mm

4,0 mm



DL-104
150 mm

5,0 mm



DL-105
150 mm

4,0 mm



DL-114
150 mm

5,0 mm



DL-115
150 mm



DL-102/DL-105
150 mm



DL-112/DL-115
150 mm



Wurzelheber
 Root Elevators
 Leve per radici
 Elevadores para raíces
 Elevateurs à racines

Wurzelspitzenheber
 Root fragment Elevators
 Leve per frammenti di radice
 Elevadores para fragmentos de raíces
 Elévateurs de fragments de racines

Gezahnt
 Serrated
 Dentellata
 Dentada
 Dentelé



**HEIDBRINK
HE-1**
 140 mm



**HEIDBRINK
HE-2**
 140 mm



**HEIDBRINK
HE-3**
 140 mm



**HEIDBRINK
725-1/2**
 195 mm



**HEIDBRINK
725-3/4**
 195 mm



**HEIDBRINK
725-5/6**
 195 mm



**HEIDBRINK
725-3/4S**
 195 mm



Wurzelheber
Root Elevators
Leve per radici
Elevadores para raíces
Elevateurs à racines

Extraktionshebel für obere Weisheitszähne
Luxator for upper wisdom teeth
Leva per estrazione dente del giudizio superiore
Elevador de extracción de muelas del juicio superiores
Lever d'extraction pour dent de sagesse supérieures

Wurzelheber
Root Elevators
Leve per radici
Elevadores para raíces
Elevateurs de racines



ROSIN
DL-58
160 mm



WARWICK-JAMES
DL-20
160 mm



WARWICK-JAMES
DL-21
155 mm



WARWICK-JAMES
DL-22
155 mm

Obere
Upper
Superiori
Supérieures

Untere
Lower
Inferiori
Inférieures

Untere
Lower
Inferiori
Inférieures



Wurzelheber
 Root Elevators
 Leve per radici
 Elevadores para raíces
 Elevateurs à racines

Eine seite gezahnt
 One side serrated
 Un lato dentellato
 Dentadura más lado
 Dentelure sur un côté



Fig. 94



DL-76
 155 mm

Fig. 95



DL-77
 155 mm

Fig. 100L



DL-78
 155 mm

Fig. 100R



DL-79
 155 mm



Wurzelheber
Root Elevators
Leve per radici
Elevadores para raíces
Elevateurs à racines

Gezahnt
Serrated
Dentellate
Dentadas
Dentelé



Fig. 301



APEXO
DL-34
160 mm

Fig. 302



DL-35



APEXO
DL-35/DL-36
160 mm

Fig. 303



DL-36

Fig. 77L



DL-37



APEXO
DL-37/DL-38
160 mm

Fig. 77R



DL-38



Wurzelheber
Root Elevators
Leve per radici
Elevadores para raíces
Elevateurs à racines

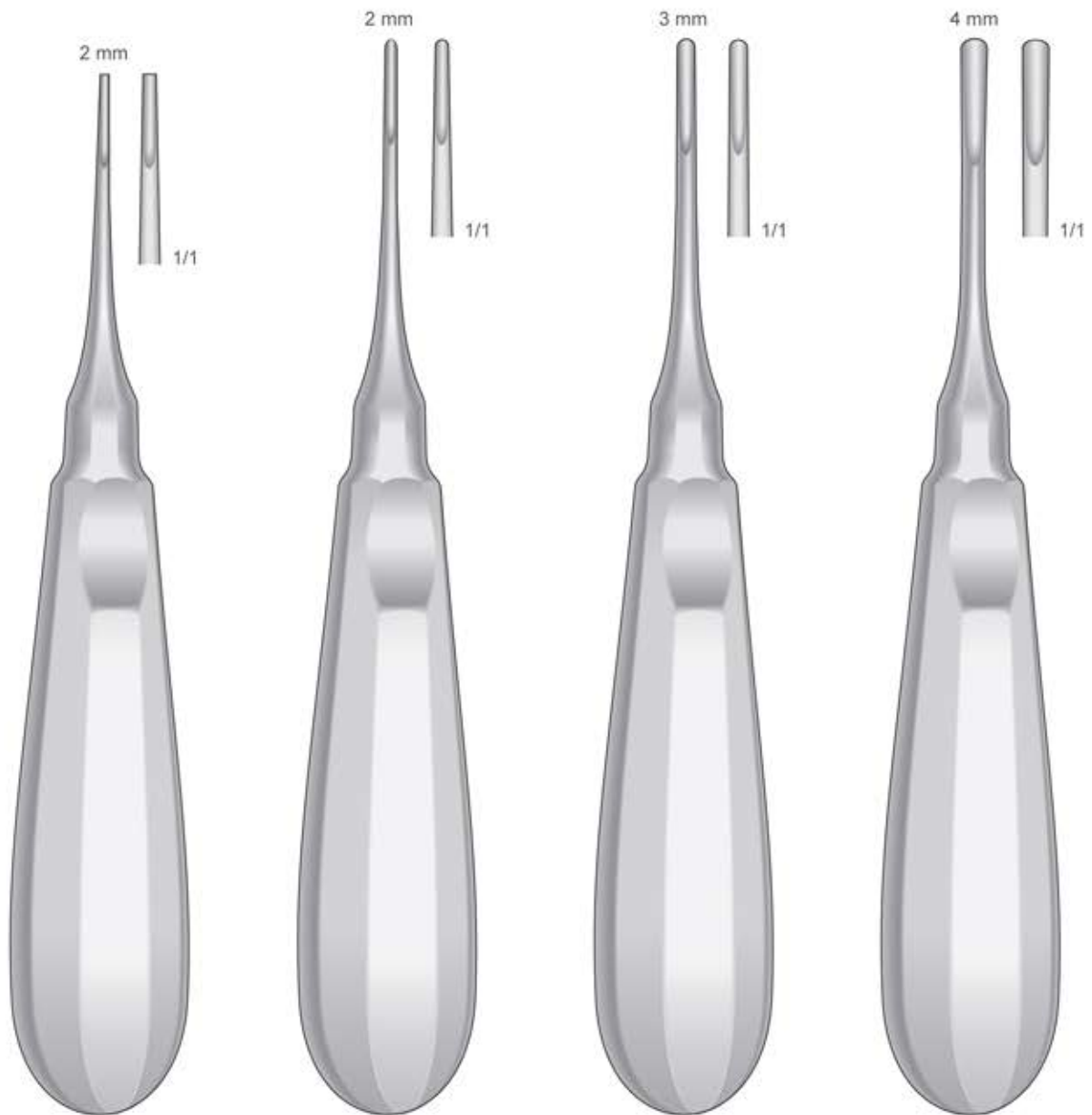

BEIN-1T
150 mm

BEIN-2
155 mm

BEIN-3
155 mm

BEIN-4
155 mm



Wurzelheber
Root Elevators
Leve per radici
Elevadores para raíces
Elevateurs à racines

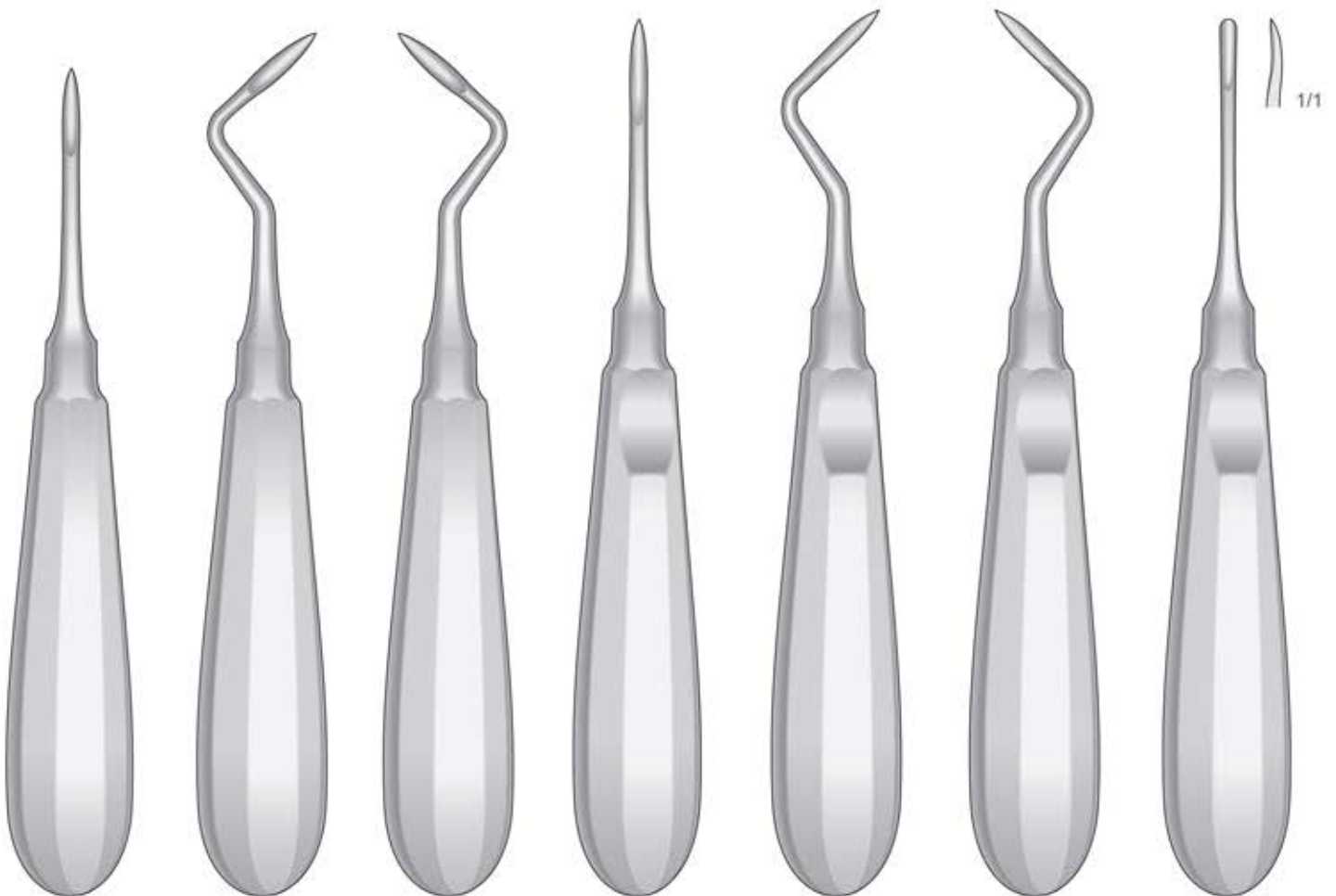

FLOHR-1
140 mm

FLOHR-2
150 mm

FLOHR-3
150 mm

APICAL-1
155 mm

APICAL-2
155 mm

APICAL-3
155 mm

APICAL-4
155 mm

Wurzelheber
 Root Elevators
 Leve per radici
 Elevadores para raíces
 Elevateurs à racines

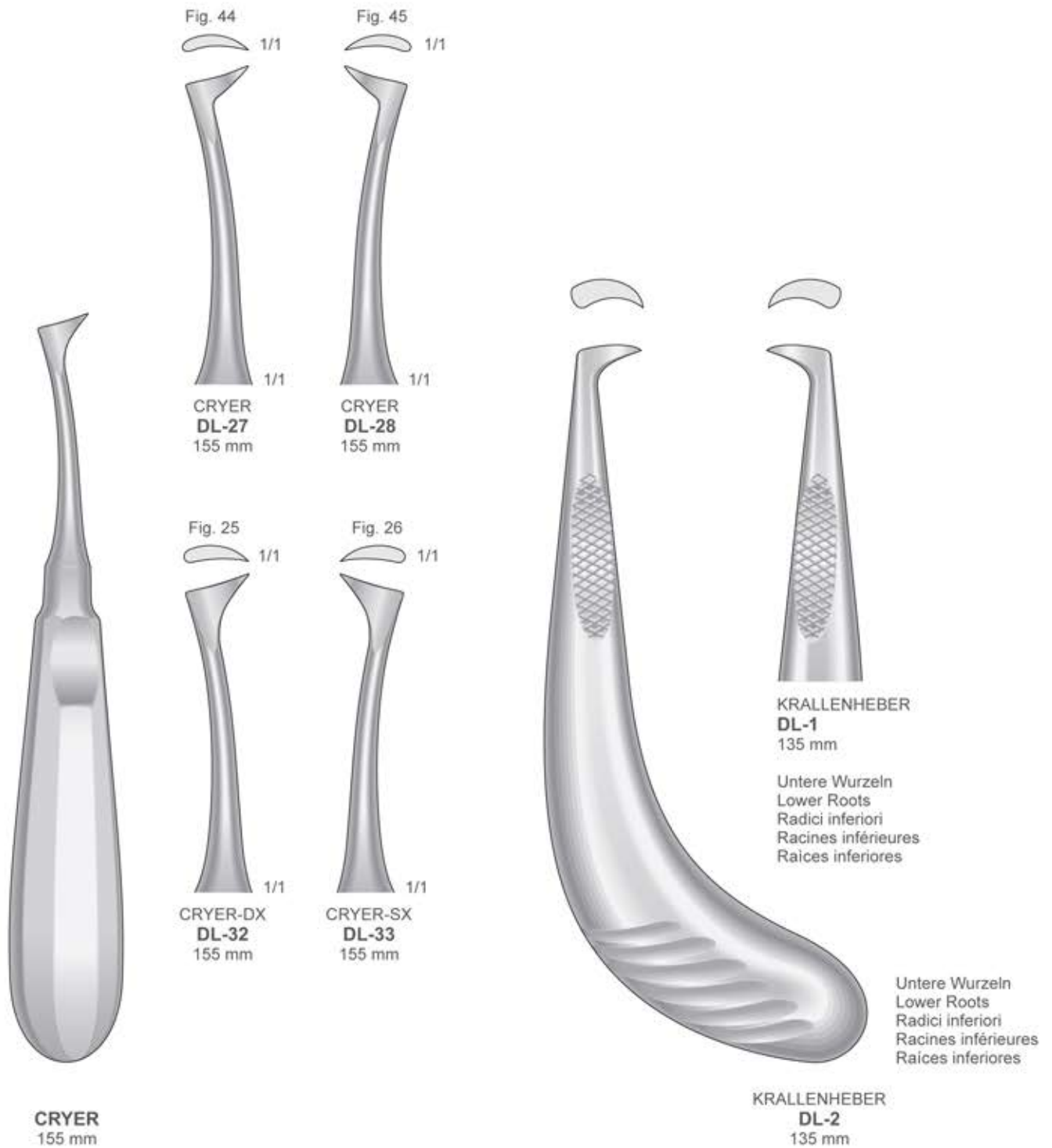

Wurzelheber
 Root Elevators
 Leve per radici
 Elevadores para raíces
 Elevateurs à racines



MIR-20
 Large
 160 mm
 Angled IN



MIR-24
 Large
 160 mm
 Angled OUT



MIR-23
 Small
 160 mm
 Angled IN



MIR-21
 Small
 160 mm
 Angled OUT



MIR-22
 Straight
 160 mm



MIR-25
 Bayonet
 160 mm



MIR-26
 Curved
 160 mm

Fig. 1
 2,0 mm

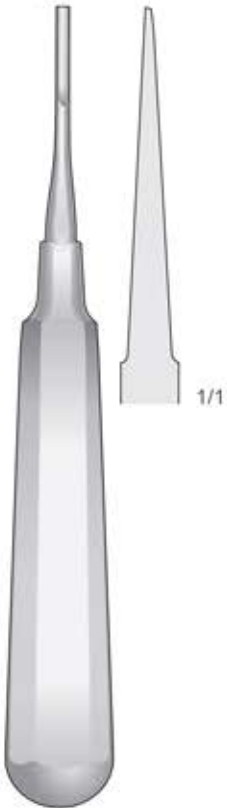

**COUPLAND
 CO-1**
 155 mm

Fig. 2
 3,6 mm

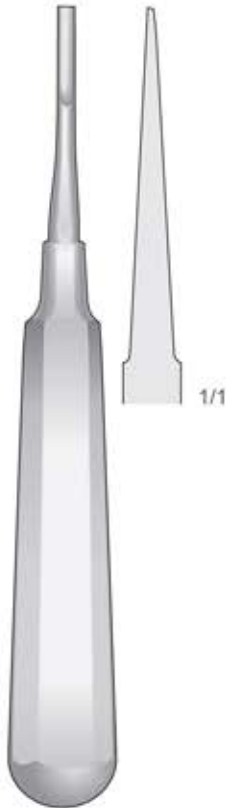

**COUPLAND
 CO-2**
 155 mm

Fig. 3
 4,2 mm

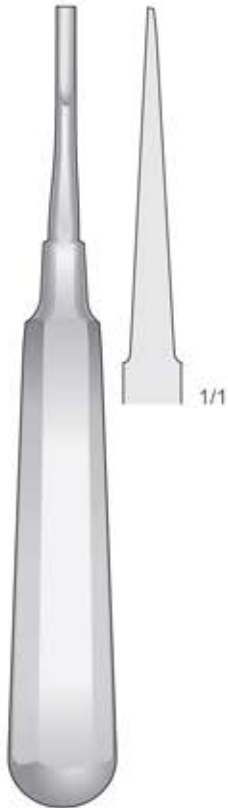

**COUPLAND
 CO-3**
 155 mm

Fig. 1
 3,0 mm

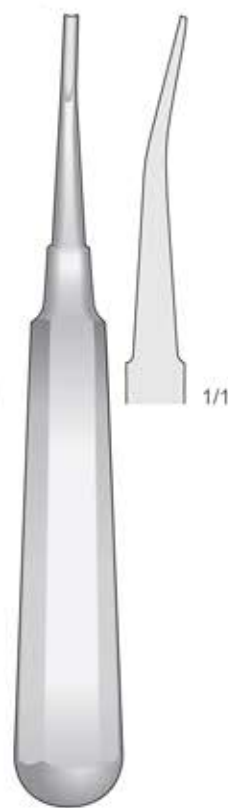

**COUPLAND
 CO-11**
 155 mm

Fig. 2
 3,6 mm

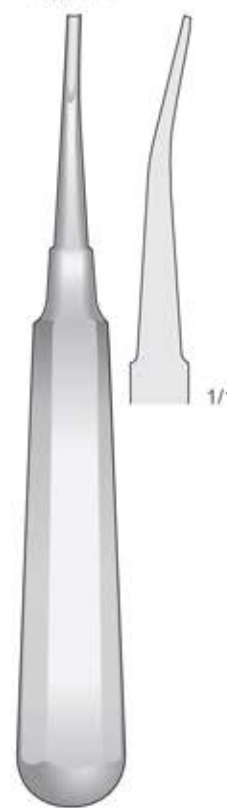

**COUPLAND
 CO-12**
 155 mm

Fig. 3
 4,2 mm

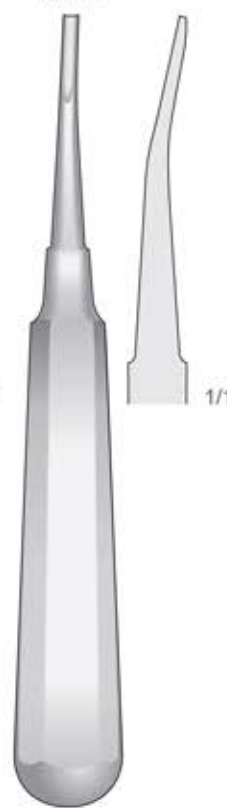

**COUPLAND
 CO-13**
 155 mm

Wurzelheber
Root Elevators
Leve per radici
Elevadores para raíces
Elevateurs à racines

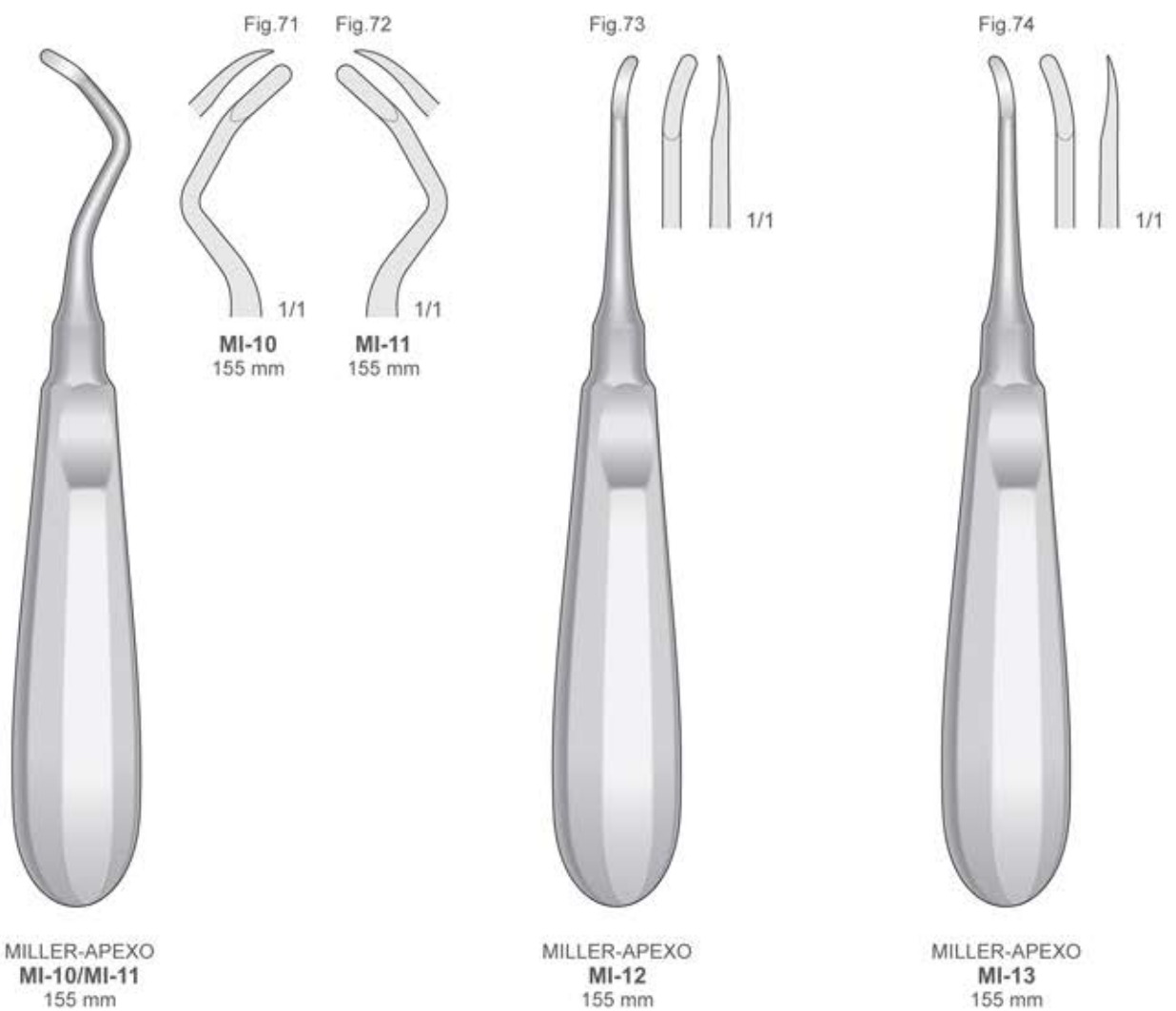



Wurzelheber
Root Elevators
Leve per radici
Elevadores para raíces
Elevateurs à racines





Wurzelheber
 Root Elevators
 Leve per radici
 Elevadores para raíces
 Elevateurs à racines



KOPP
DL-30
 130 mm



KOPP
DL-31
 130 mm



BEIN-1Z
 130 mm



BEIN-2Z
 155 mm



LINDO-LEVIEN
BEIN-4Z
 155 mm

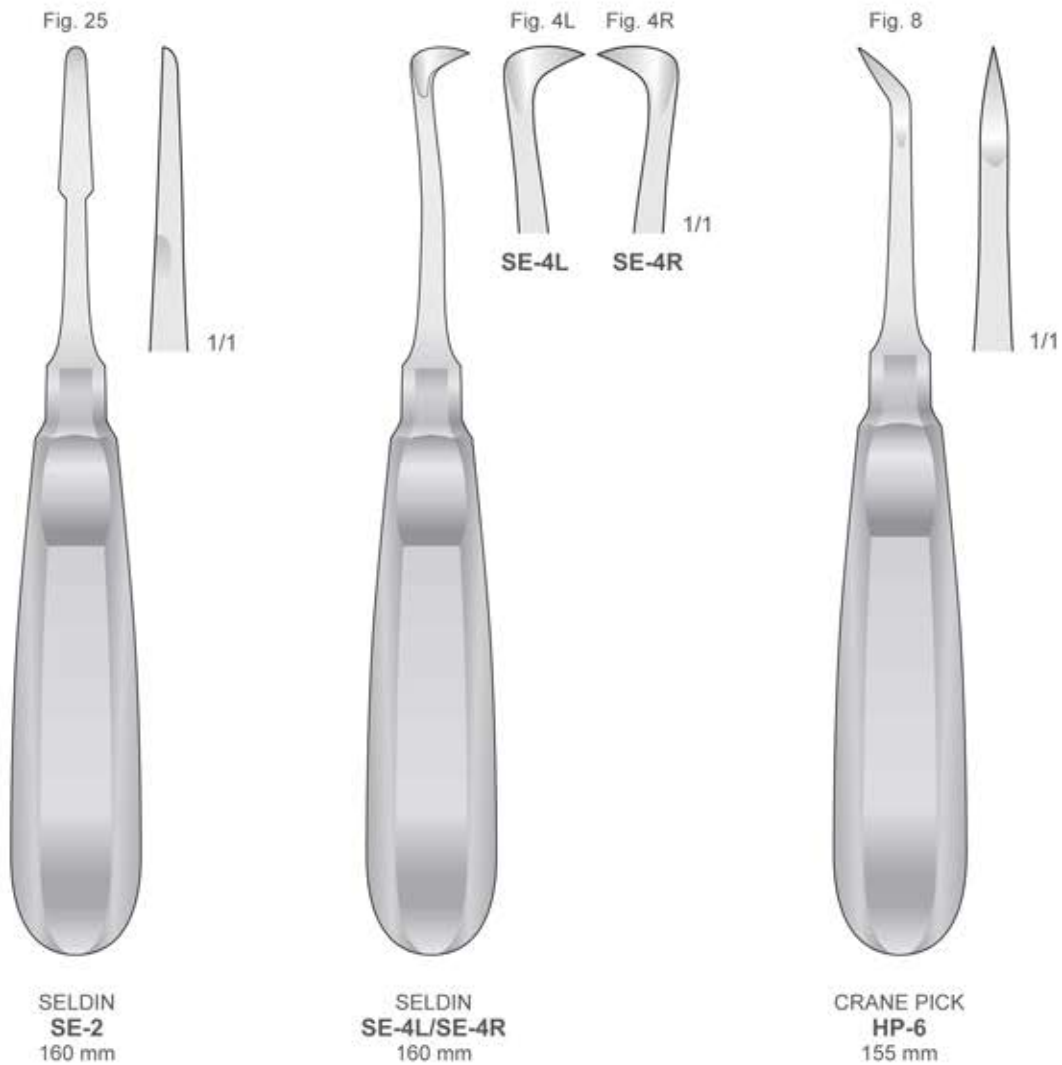

Wurzelheber
 Root Elevators
 Leve per radici
 Elevadores para raíces
 Elevateurs à racines

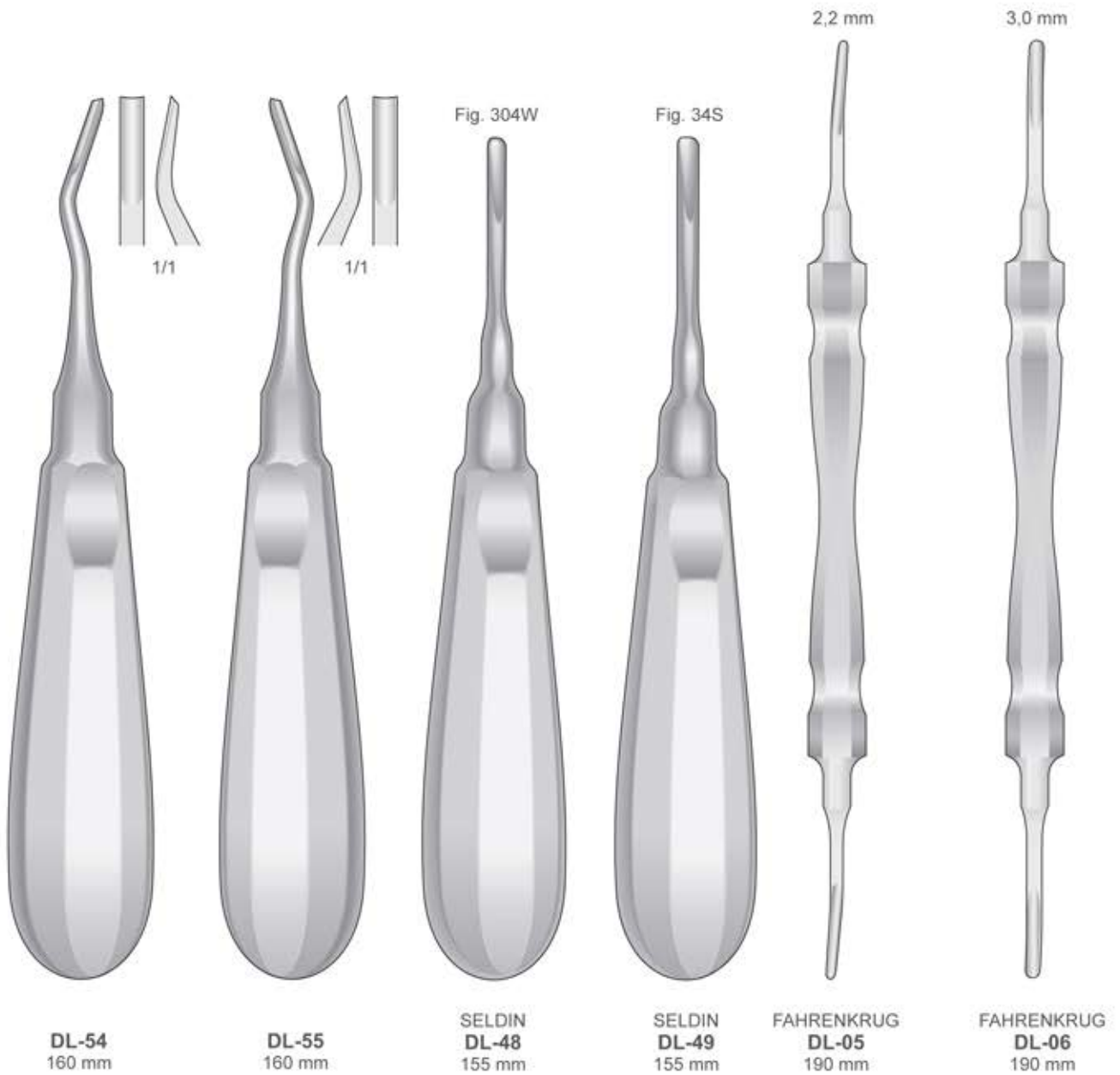

Wurzelheber
Root Elevators
Leve per radici
Elevadores para raíces
Elevateurs à racines

Fig. 6



POTT
DL-98
160 mm

Fig. 7



POTT
DL-99
160 mm

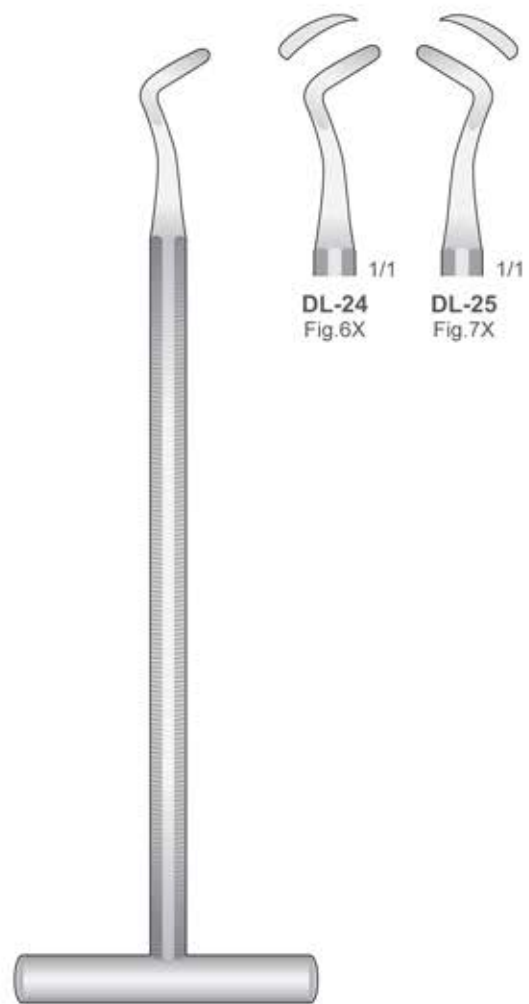

POTT
DL-24/DL-25
155 mm

Wurzelheber
 Root Elevators
 Leve per radici
 Elevadores para raíces
 Elevateurs à racines

Syndesmotome
 Syndesmotomes
 Sindesmotomi
 Syndesmótomos
 Syndesmotomes



BERNARD
 DL-73/DL-124

Gerade
 Straight
 Diritto
 Rectas
 Droites



BERNARD
 DL-73
 150 mm

Links
 Left
 Sinistra
 A la izquierda
 À gauche



BERNARD
 DL-74
 140 mm

Rechts
 Right
 Destro
 A la derecha
 À droite



BERNARD
 DL-75
 140 mm

Bajonett - Bayonet
 Baionetta - Bayoneta
 Baionnette



BERNARD
 DL-123
 150 mm



BERNARD
 DL-124
 150 mm

Wurzelheber
 Root Elevators
 Leve per radici
 Elevadores para raíces
 Elevateurs à racines

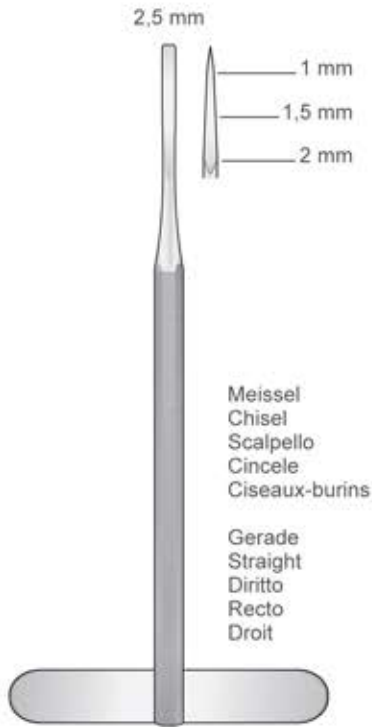

DL-88
130 mm

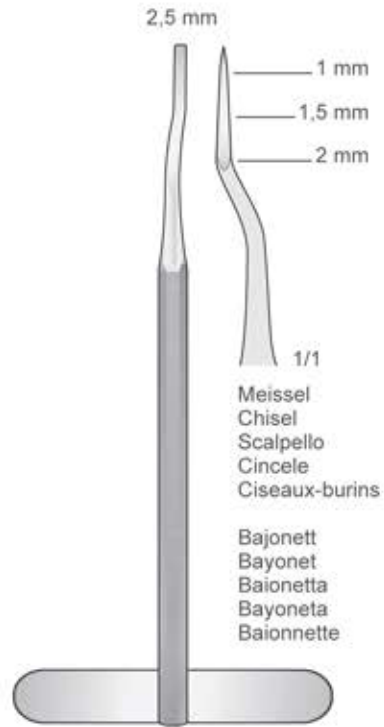

DL-89
130 mm

Syndesmotome
 Syndesmotomes
 Sindesmotomo
 Syndesmôtomos
 Syndesmotomes

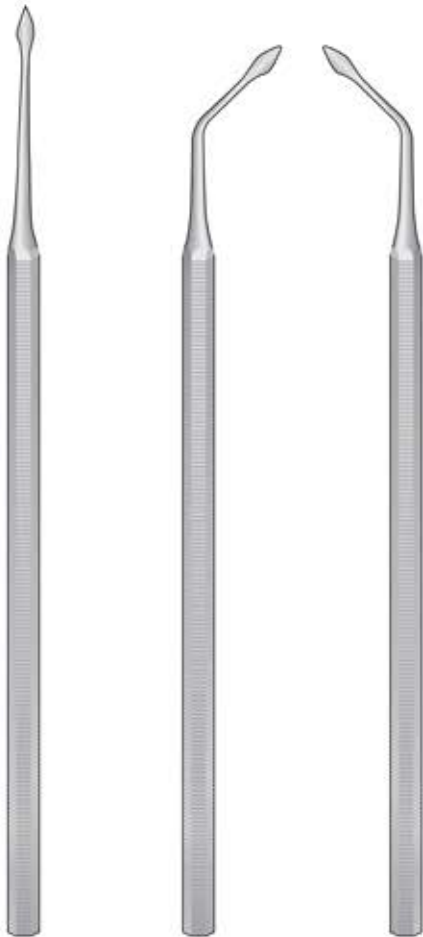

DL-63
158 mm

DL-62
152 mm

DL-61
152 mm

Raspatorien
 Raspatories
 Scollaperiosteo
 Legras
 Rugines

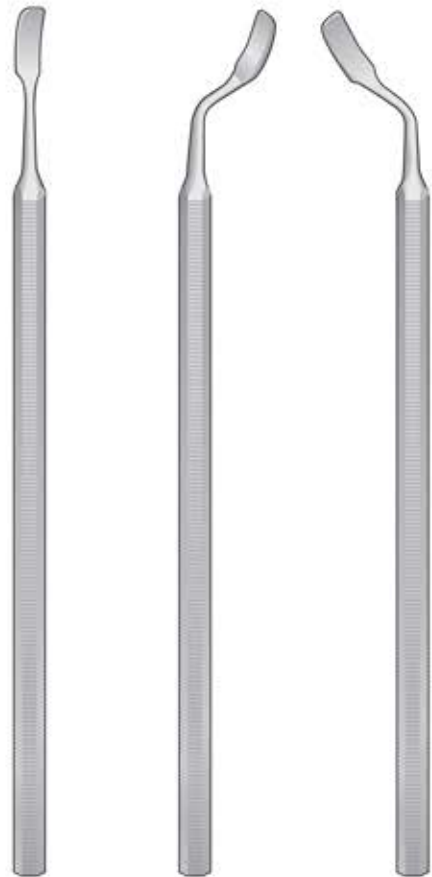

DL-59
150 mm

DL-68
150 mm

DL-69
150 mm

Wurzelheber
Root Elevators
Leve per radici
Elevadores para raíces
Elevateurs à racines



Untere Wurzeln
Lower Roots
Radici inferiori
Raíces inferiores
Racines inférieures

Links
Left
Sinistra
Izquierda
Gauche

WINTER
DL-100
Fig.1

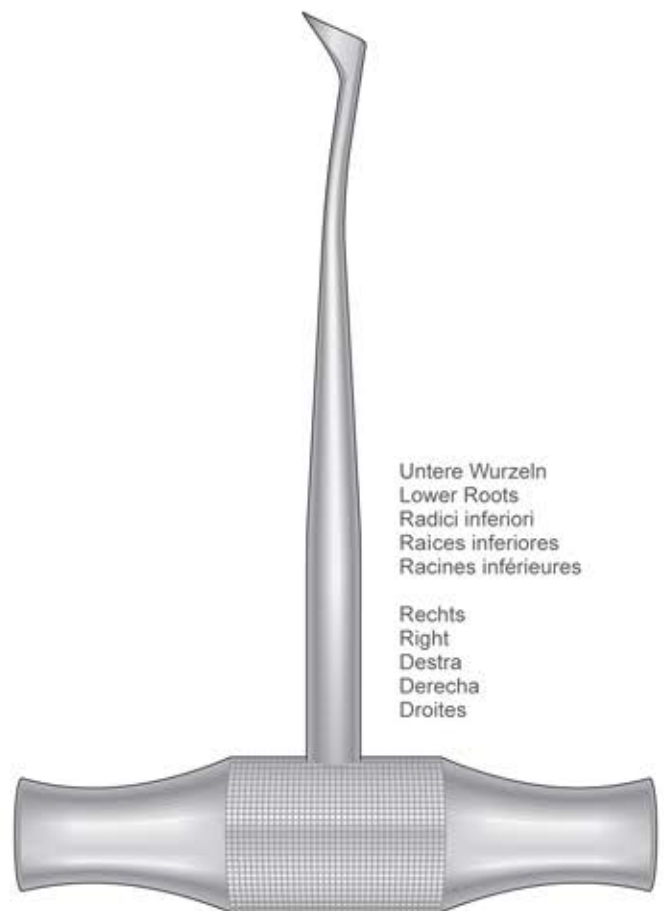

Untere Wurzeln
Lower Roots
Radici inferiori
Raíces inferiores
Racines inférieures

Rechts
Right
Destra
Derecha
Droites

WINTER
DL-101
Fig.2

Wurzelheber
Root Elevators
Leve per radici
Elevadores para raíces
Elevateurs à racines

Fig. 1L



WINTER
DL-64
120 mm

Fig. 1R



WINTER
DL-65
120 mm

Fig. 14L



WINTER
DL-66
125 mm

Fig. 14R



WINTER
DL-67
125 mm

Wurzelheber
 Root Elevators
 Leve per radici
 Elevadores para raíces
 Elevateurs à racines

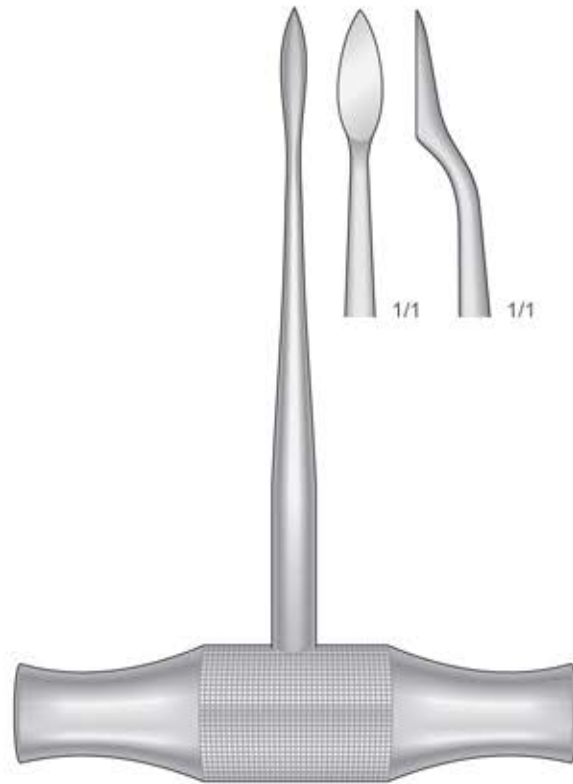

LECLUSE
DL-90
 130 mm

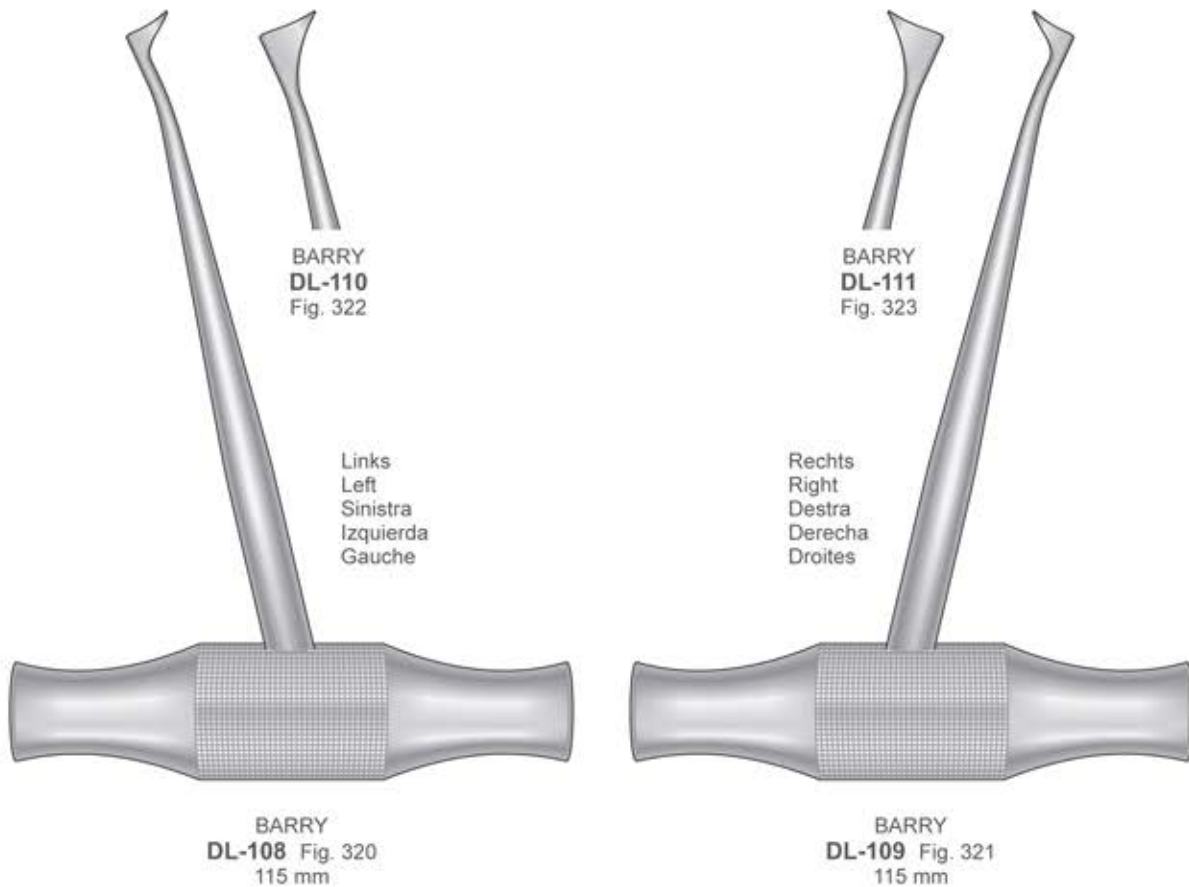

BARRY
DL-110
 Fig. 322

BARRY
DL-111
 Fig. 323

Links
 Left
 Sinistra
 Izquierda
 Gauche

Rechts
 Right
 Destra
 Derecha
 Droites

BARRY
DL-108 Fig. 320
 115 mm

BARRY
DL-109 Fig. 321
 115 mm



Wurzelheber
Root Elevators
Leve per radici
Elevadores para raíces
Elevateurs à racines

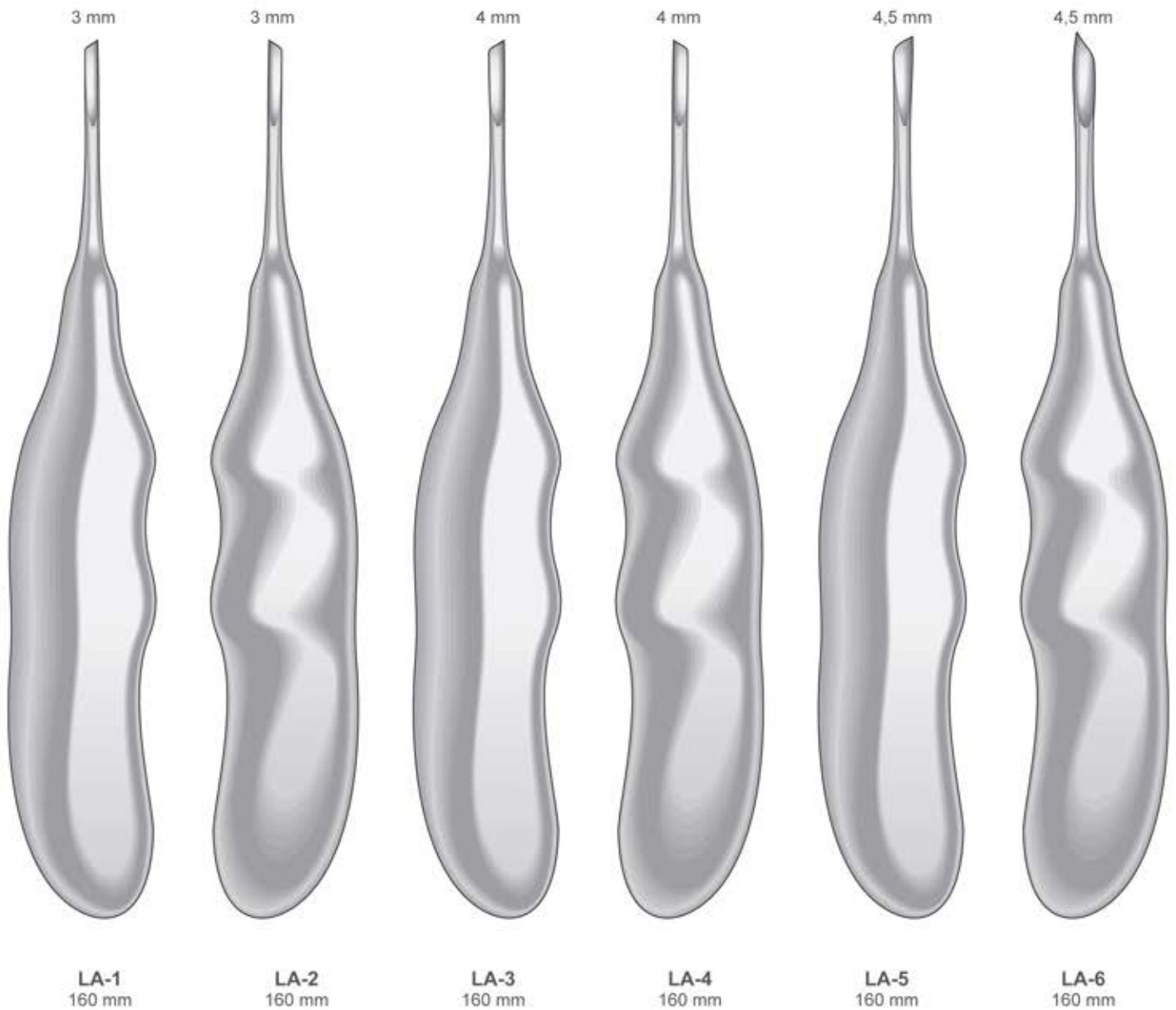

Wurzelheber
Root Elevators
Leve per radici
Elevadores para raíces
Elevateurs à racines



LA-7
160 mm



LA-8
160 mm



LA-9
160 mm



LA-10
160 mm



Wurzelheber
Root Elevators
Leve per radici
Elevadores para raíces
Elevateurs à racines

2 mm



LA-11
155 mm

3 mm



LA-12
155 mm

4 mm



LA-13
155 mm



LA-16
160 mm



LA-17
160 mm

Wurzelheber
Root Elevators
Leve per radici
Elevadores para raíces
Elevateurs à racines



LA-20
160 mm



LA-21
160 mm



LA-22
160 mm



LA-23
160 mm

Syndesmotome
Syndesmotomes
Sindesmotomo
Syndesmôtomos
Syndesmotomes



Massiv
Solid
Manico
Pieno
Massif

CHOMPRET
CH-11
150 mm



Massiv
Solid
Manico
Pieno
Massif

CHOMPRET
CH-12
150 mm



Massiv
Solid
Manico
Pieno
Massif

CHOMPRET
CH-13
150 mm



Massiv
Solid
Manico
Pieno
Massif

CHOMPRET
CH-14
145 mm



CHOMPRET
CH-1
165 mm



CHOMPRET
CH-2
165 mm



CHOMPRET
CH-3
165 mm



CHOMPRET
CH-4
160 mm

Zahnreiniger - Periotome
 Scalers - Periotomes
 Ablatori di tartaro - Periotomi
 Limpiadores de sarro - Periotomos
 Detarteurs - Périotomes

MORSE - SCALERS

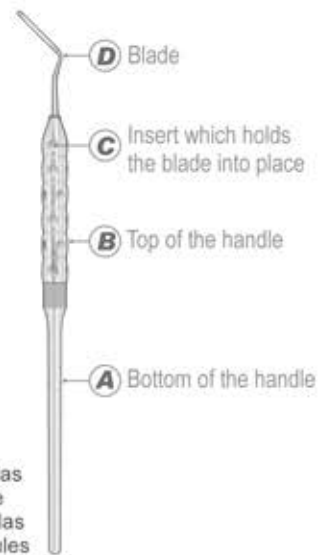
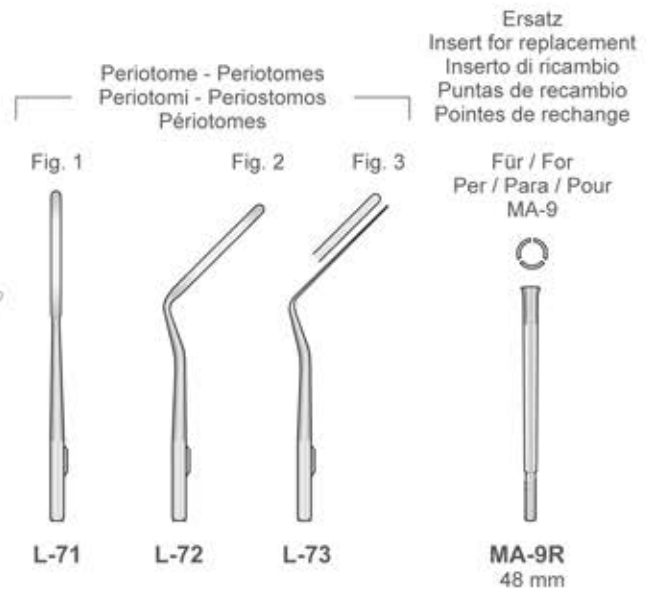
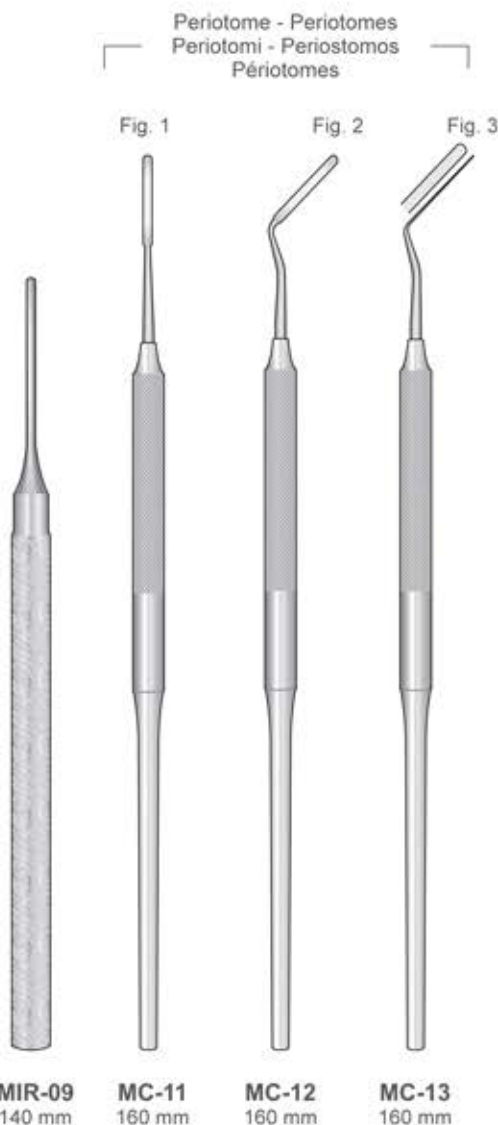
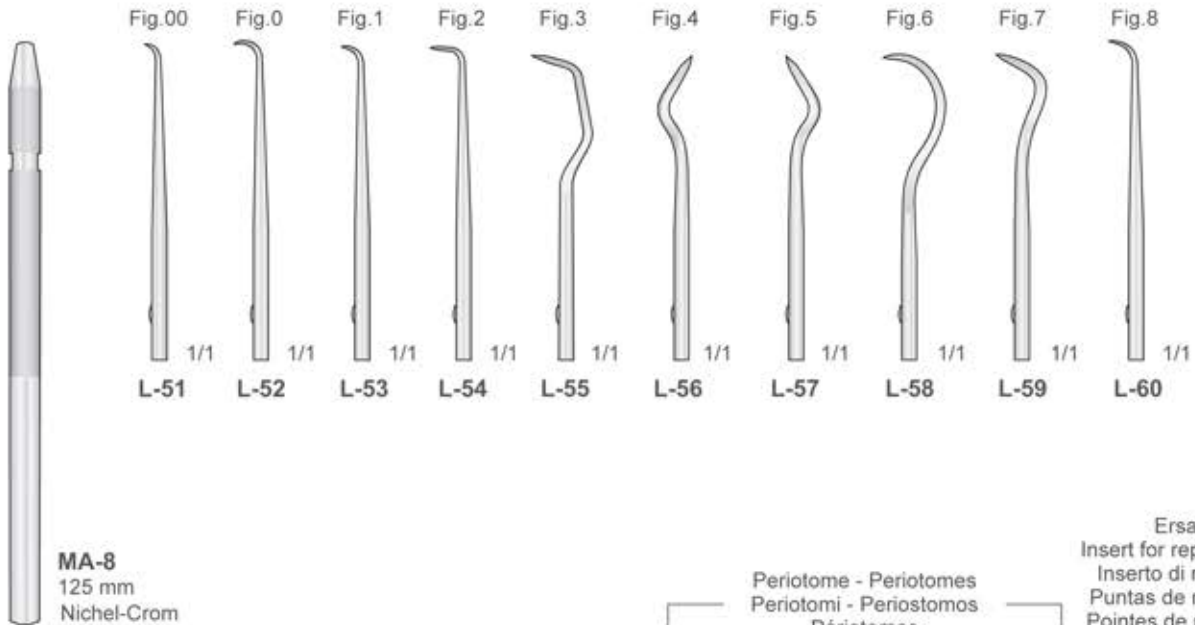

MC-70
 (MA-9 + L-71, L-72, L73)
 Komplet mit 1 Griff + 3 Spatel
 Complete with 1 Handle + 3 Spatulas
 Completo di 1 Manico + 3 Spatole
 Completo con 1 mango + 3 Espátulas
 Complete avec 1 Manche + 3 Spatules

Syndesmotome
Syndesmotomes
Sindesmotomi
Syndesmotómos
Syndesmotomes

SDM-C

Komplett mit 2 Griffe + 20 Klingen
Complete with 2 Handles + 20 Blades
Completo di 2 Manici + 20 lame
Completo con 2 mangos + 20 hojas
Complete avec 2 Manches + 20 lames

SD-M

Griff
Handle
Manico
Mango
Manche

SDM-9

Komplett mit 2 Griffe + 9 Klingen APICALI
Complete with 2 Handles + 9 Blades APICALI
Completo di 2 Manici + 9 lame APICALI
Completo con 2 mangos + 9 hojas APICALI
Complete avec 2 Manches + 9 lames APICALI

SDM-11

Komplett mit 2 Griffe + 11 Klingen CERVICALI
Complete with 2 Handles + 11 Blades CERVICALI
Completo di 2 Manici + 11 lame CERVICALI
Completo con 2 mangos + 11 hojas CERVICALI
Complete avec 2 Manches + 11 lames CERVICALI



SD-M

Lame CERVICALI



Lame APICALI



C |

Scalpel Blades and Handles
Skalpellslingen und Skalpellsgriffe
Lames et manches de bistouri
Hojas y mangos de bisturi
Lame e manici per bisturi



Skalpelli-griffe - Mikro Skalpellklingen
 Scalpel Handles - Micro Scalpel Blades
 Manici per bisturi - Micro lame per bisturi
 Mangos de bisturi - Micro hojas de bisturi
 Manches pour bistouris - Micro lames de bistouri



LB-40
 Packung 10 Klingen
 Package 10 blades
 Scatola da 10 lame
 Cajita de 10 hojas
 Boite de 10 lames

Skalpelli-griffe für Mikro-Klingen
 Scalpel handles for Micro blades
 Manici per micro lame
 Mangos de bisturi para micro hojas
 Manches de bistouris pour micro lames

Micro-Klingen
 Micro blades
 Micro lame
 Micro hojas
 Micro lames

Rasierklingen-Brecker und halter
 Razor blade breaker and holder
 Manico porta lame
 Mango para Hojas de afeitar
 Porte lames à rasoir

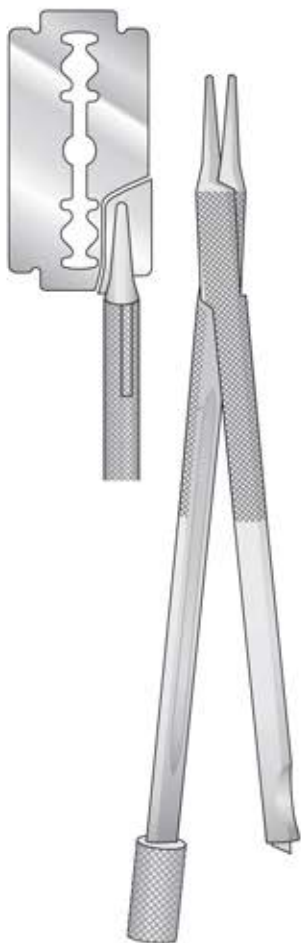

NK-12
 120 mm



BB-46
 135 mm



BB-48
 155 mm



LB-361
 Conf. 10 pz.



LB-362
 Conf. 10 pz.



LB-363
 Conf. 1 pz.



LB-364
 Conf. 10 pz.



LB-365
 Conf. 10 pz.



LB-366
 Conf. 1 pz.



LB-367
 Conf. 10 pz.



LB-368
 Conf. 10 pz.



LB-369
 Conf. 1 pz.

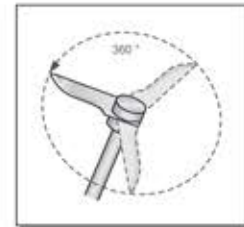

Für Mikro-Klingen
For Micro Blades
Per micro lame
Para micro Hojas
Pour Micro-Lame de bistouris



NK-1
100 mm



NK-3
130 mm



NK-2
150 mm



MA-B16
120 mm



GB-4
165 mm

Skalpelle und Skalpellgriffe
 Scalpel Blades and Handle
 Lame e manici per bisturi
 Hojas y mangos de bisturi
 Lames et manches de bistouri

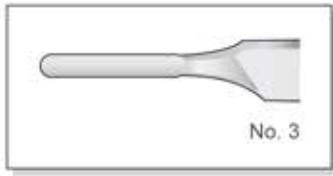

No. 3

Packungen à 100
 Packages of 100 ea
 Scatole da 100 pezzi
 Cajas de 100 c/u
 Boîtes de 100 pièces

LB-10
 Fig. 10

LB-11
 Fig. 11

LB-12
 Fig. 12

LB-12D
 Fig. 12D

LB-13
 Fig. 13

LB-15
 Fig. 15

LB-15A
 Fig. 15A

LB-15C
 Fig. 15C

MA-B3

MA-B3M
 Fig. 3M

MA-B7

MA-B7K

MA-B1
 Fig. 5

MA-B2
 Fig. 5A

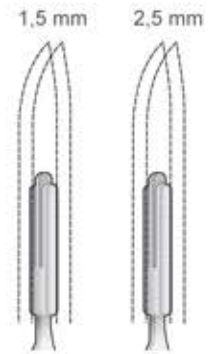
MA-B8/MA-B9
 155 mm

MA-B8 **MA-B9**

Doppelt Skalpellgriff
 Scalpel Handle double Blade
 Manico per bisturi a doppia lama
 Mango de bisturi doble hojas
 Manche pour bistouri double-lames

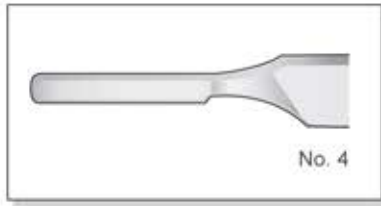
Skalpelle
Scalpel Blades
Lame per bisturi
Hojas de bisturi
Lames de bistouri



No. 4

Packungen à 100
Packages of 100 ea
Scatole da 100 pezzi
Cajas de 100 c/u
Boîtes de 100 pièces



LB-18
Fig. 18



LB-20
Fig. 20



LB-21
Fig. 21



LB-23
Fig. 23



Palatal, Gingival,
Connective Tissue Grafts
Uses standard
double-edged
razor blade

Mucotomo

**PAQUETTE
BLADE HOLDER
GB-2**
160 mm



MA-B4
Fig. 4

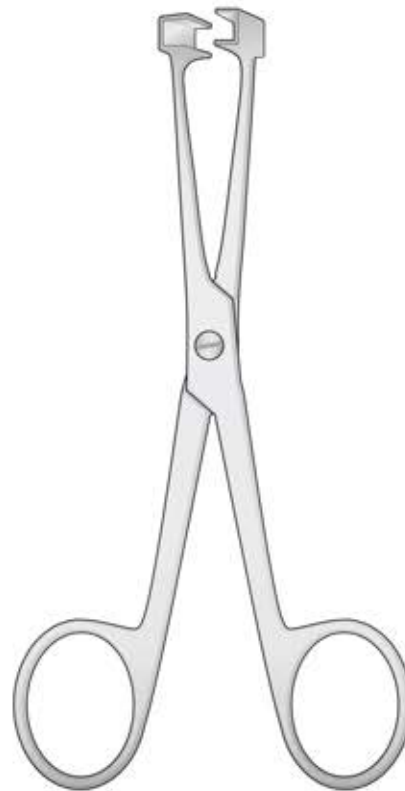

Klingenentfemer
Scalpel blade removing forceps
Pinze togililama
Pinza para quitar hojas de bisturias
Pince pour enlever les lames de bistours

GS-18
135 mm

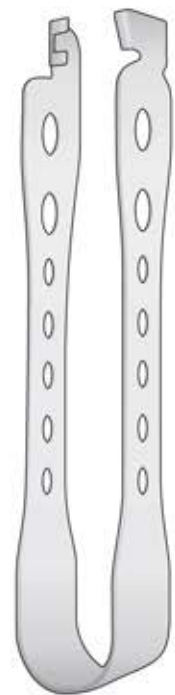

GS-16
115 mm

Messer
 Knives
 Coltelli
 Cuchillos
 Couteaux

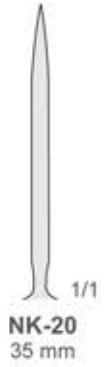
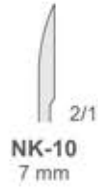

ZIEGLER
NK-06/NK-10
 115 mm

GRAEFE
NK-14/NK-16

GRAEFE
NK-18/NK-20
 140 mm



ELLIS
NK-09
 120 mm



NK-11
 125 mm



NK-17
 125 mm



NK-39
 125 mm

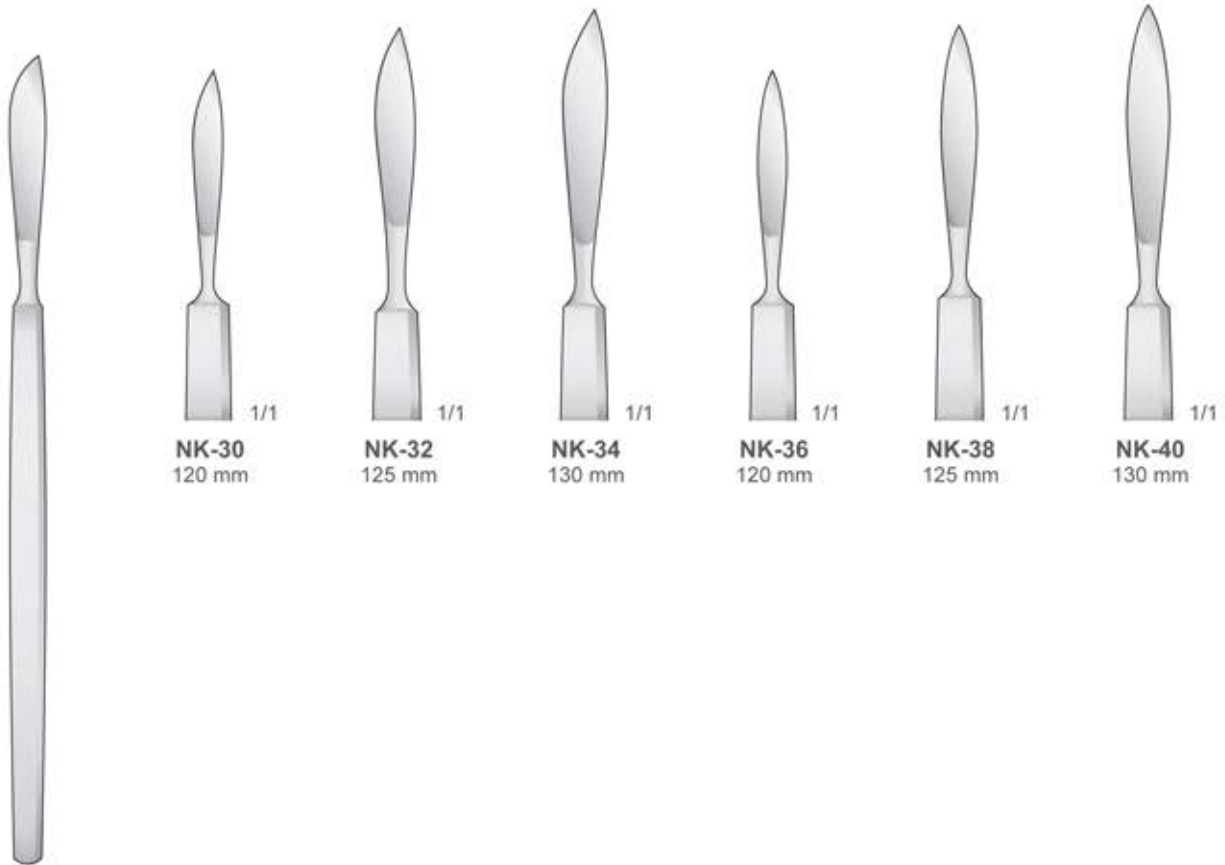

NK-30
120 mm

NK-32
125 mm

NK-34
130 mm

NK-36
120 mm

NK-38
125 mm

NK-40
130 mm

NK-30/NK-40

D

Surgical Scissors
Chirurgische Scheren
Ciseaux chirurgicaux
Tijeras quirúrgicas
Forbici Chirurgiche





Mikro-Scheren
 Micro Scissors
 Micro Forbici
 Micro Tijeras
 Micro Ciseaux

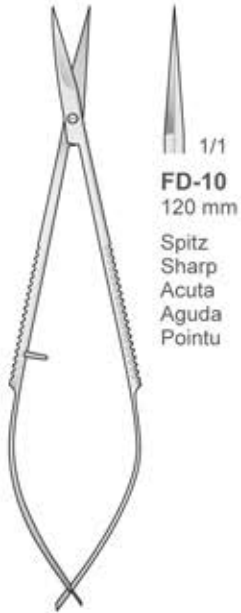

1/1
FD-10
 120 mm
 Spitz
 Sharp
 Acuta
 Aguda
 Pointu

NOYES
FD-10
 120 mm

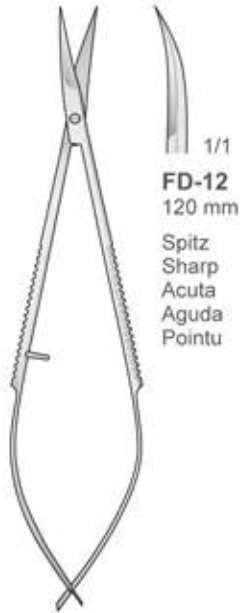

1/1
FD-12
 120 mm
 Spitz
 Sharp
 Acuta
 Aguda
 Pointu

NOYES
FD-12
 120 mm

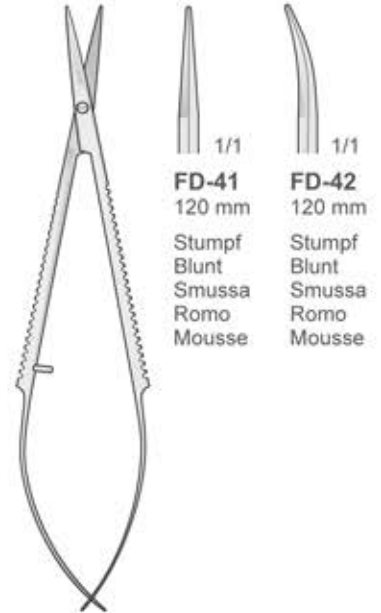

1/1 1/1
FD-41 **FD-42**
 120 mm 120 mm
 Stumpf
 Blunt
 Smussa
 Romo
 Mousse

FD-41/FD-42
 120 mm

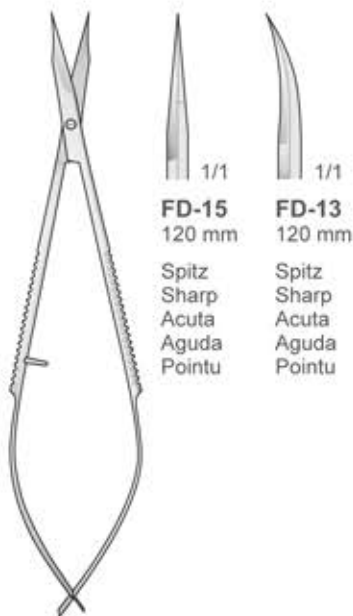

1/1 1/1
FD-15 **FD-13**
 120 mm 120 mm
 Spitz
 Sharp
 Acuta
 Aguda
 Pointu

WESTCOTT
FD-13/FD-15
 120 mm

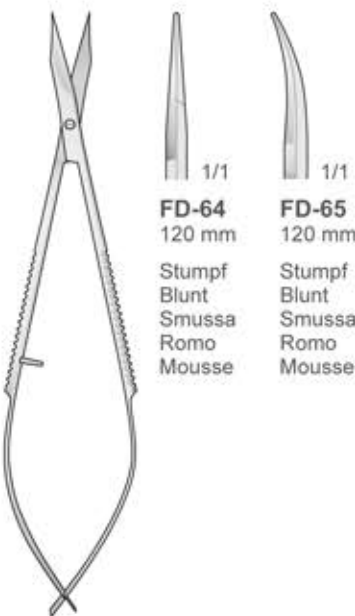

1/1 1/1
FD-64 **FD-65**
 120 mm 120 mm
 Stumpf
 Blunt
 Smussa
 Romo
 Mousse

WESTCOTT
FD-64/FD-65
 120 mm



1/1 1/1
FD-137 **FD-138**
 150 mm 150 mm

FD-137/FD-138
 150 mm



FD-182
160 mm
Spitz
Sharp
Acuta
Aguda
Pointu



FD-183
160 mm
Spitz
Sharp
Acuta
Aguda
Pointu

1/1

FD-182/FD-183
160 mm



FD-224
145 mm
Spitz
Sharp
Acuta
Aguda
Pointu



FD-225
145 mm
Spitz
Sharp
Acuta
Aguda
Pointu

1/1

1/1

FD-224/FD-225
145 mm



Gezahnt
Serrated
Dentellata
Dentada
Dentelé

Spitz
Sharp
Acuta
Aguda
Pointu

FD-145
160 mm



FD-06
160 mm
Spitz
Sharp
Acuta
Aguda
Pointu

1/1

FD-06
160 mm



FD-08
160 mm
Spitz
Sharp
Acuta
Aguda
Pointu

1/1

FD-08
160 mm



Scheren
 Scissors
 Forbici
 Tijeras
 Ciseaux

Spitz - Sharp
 Acuta - Aguda
 Pointu



STITCH
FG-216
 115 mm

Iris Scheren - Iris scissors
 Forbici Iris - Tijeras Iris
 Ciseaux Iris

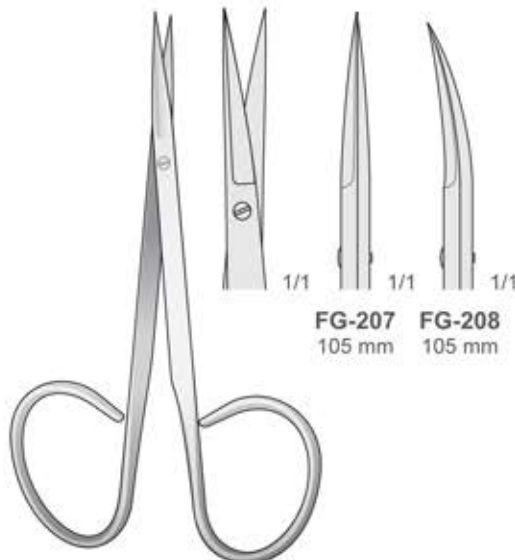

FG-207 **FG-208**
 105 mm 105 mm

FG-207/FG-208
 105 mm

Stumpf - Blunt
 Smussa - Romas
 Mousse

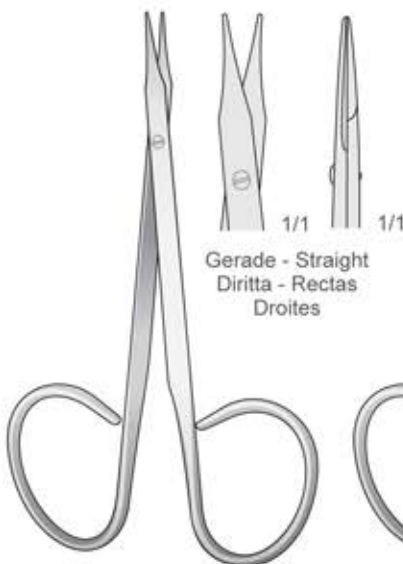

STEVENS
FG-209
 100 mm

Stumpf - Blunt
 Smussa - Romas
 Mousse

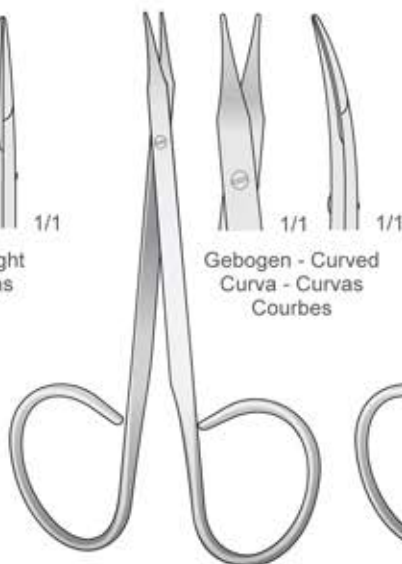

STEVENS
FG-210
 100 mm

Spitz - Sharp
 Acuta - Aguda
 Pointu

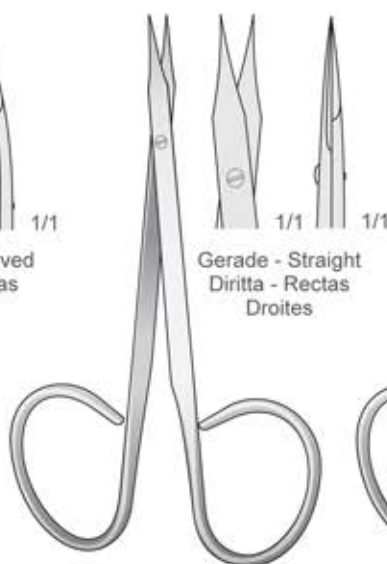

WALTON
FG-211
 100 mm

Spitz - Sharp
 Acuta - Aguda
 Pointu

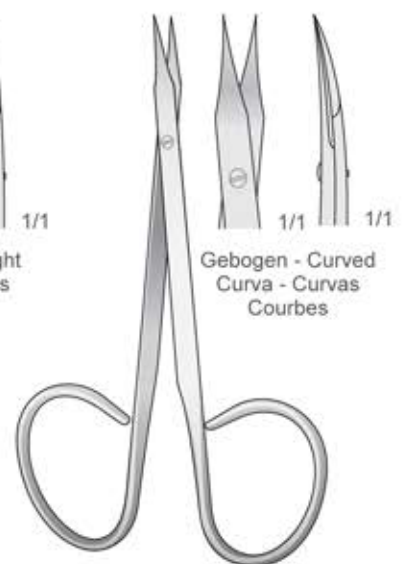

WALTON
FG-212
 100 mm

Gerade - Straight
 Diritta - Rectas
 Droites

Gebogen - Curved
 Curva - Curvas
 Courbes

Gerade - Straight
 Diritta - Rectas
 Droites

Gebogen - Curved
 Curva - Curvas
 Courbes



L = links
left
mancini
izquierdo
gauche

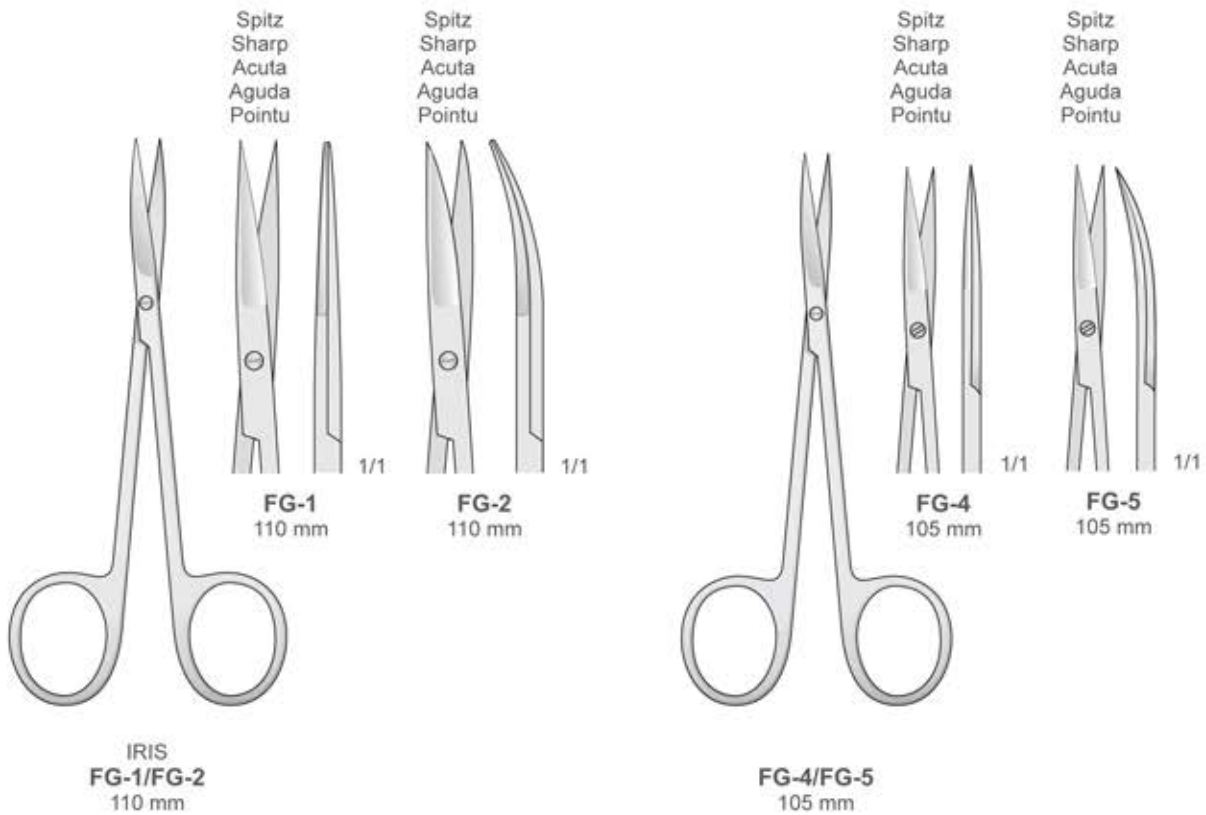
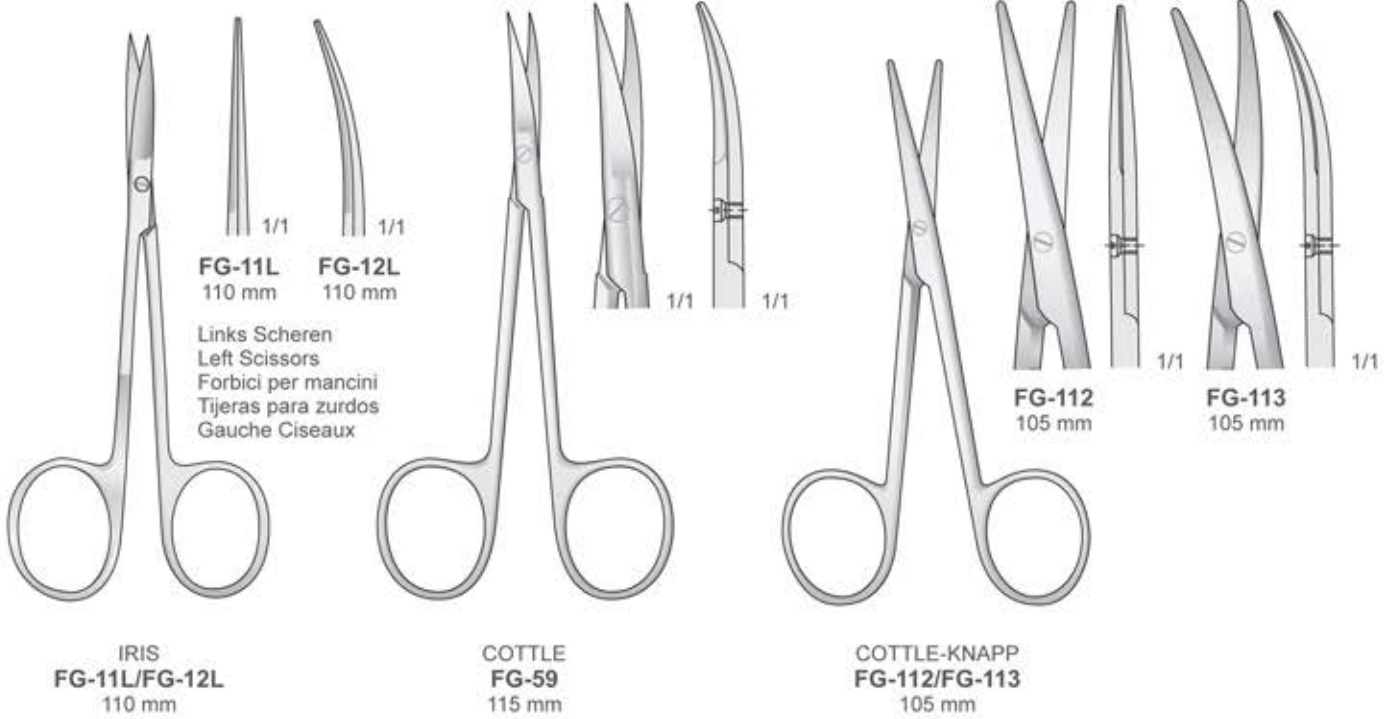



Scheren
 Scissors
 Forbici
 Tijeras
 Ciseaux

Gezahnt - Serrated
 Dentellata - Dentelé - Dentadas



FG-156
110 mm

FG-157
110 mm

FG-156/FG-157
110 mm

Gezahnt - Serrated
 Dentellata - Dentelé - Dentadas

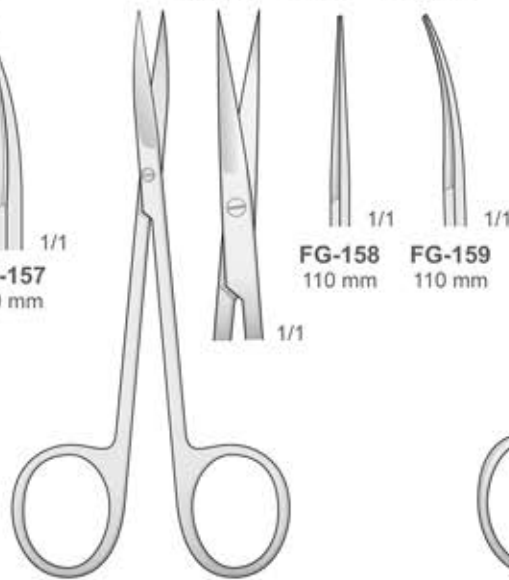

FG-158
110 mm

FG-159
110 mm

FG-158/FG-159
110 mm

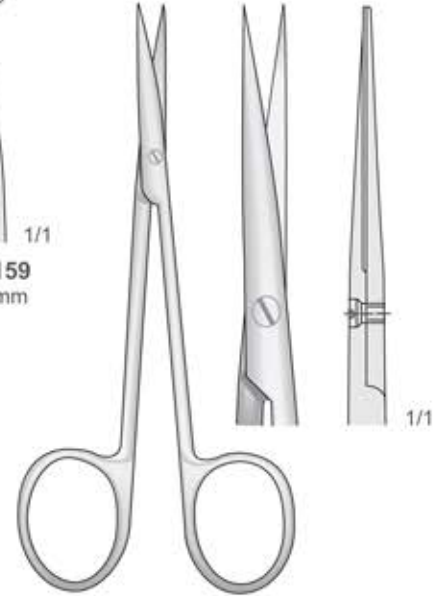

KILNER
FG-58
115 mm

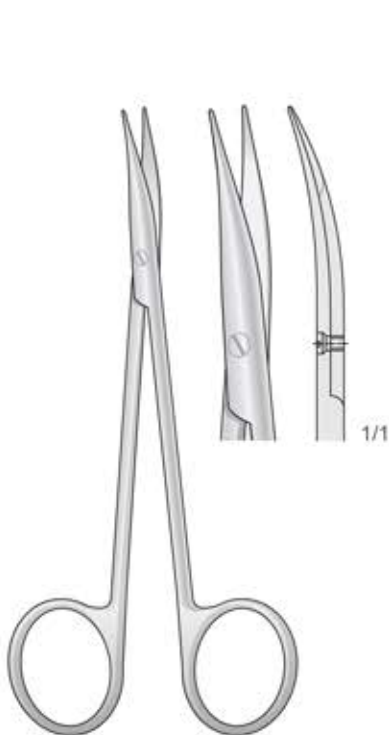

JAMESON-WERBER
FG-123
130 mm

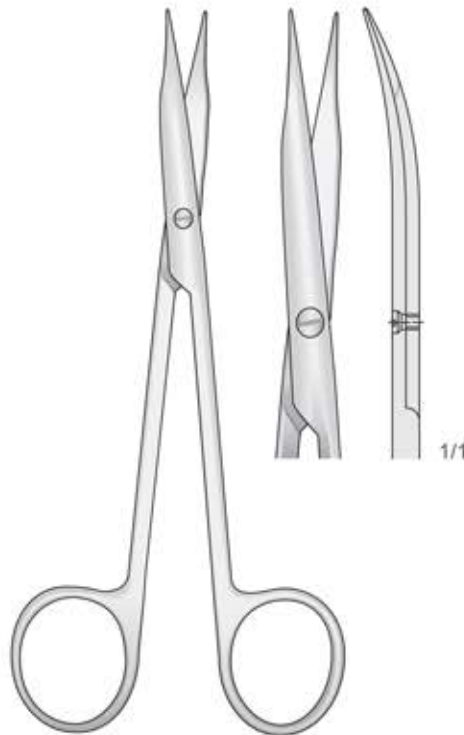

JAMESON
FG-124
145 mm

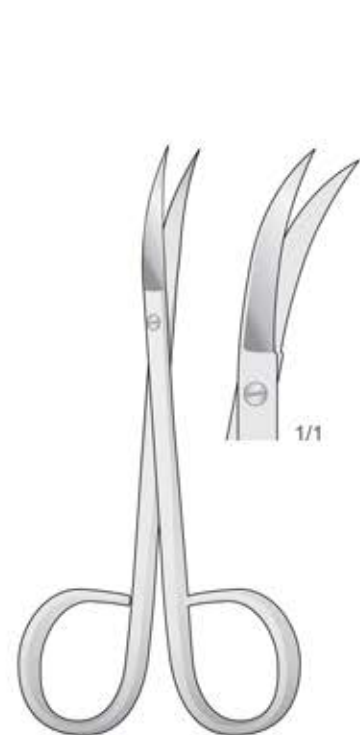

FG-3
115 mm

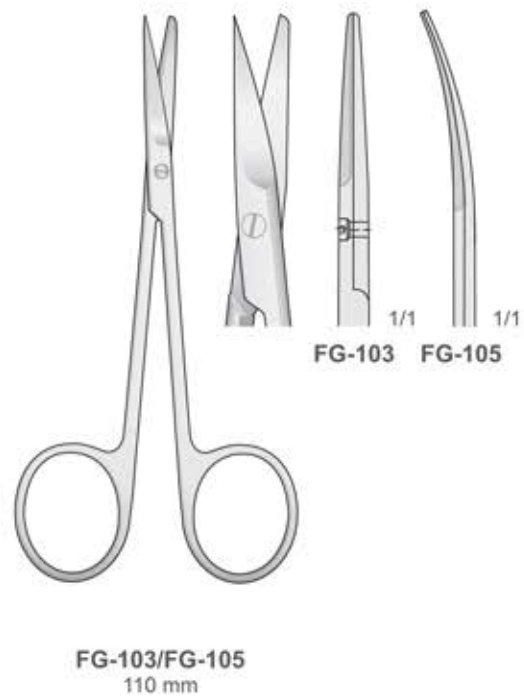
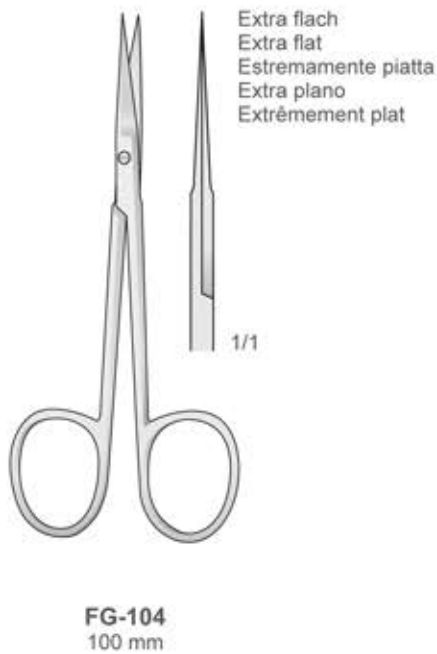
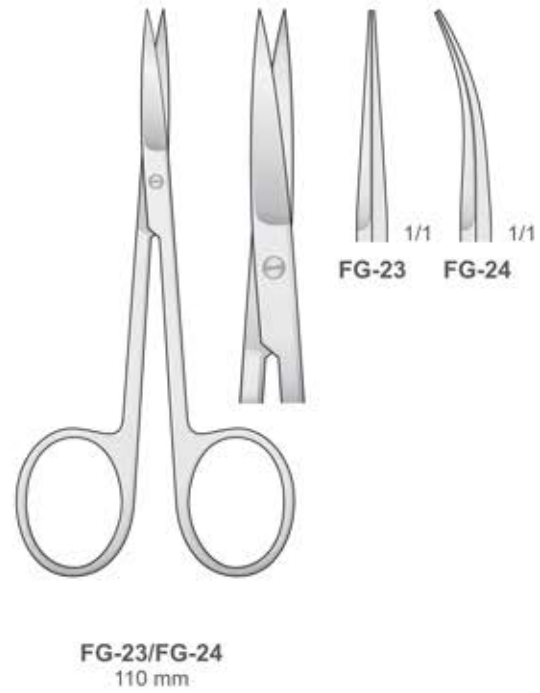
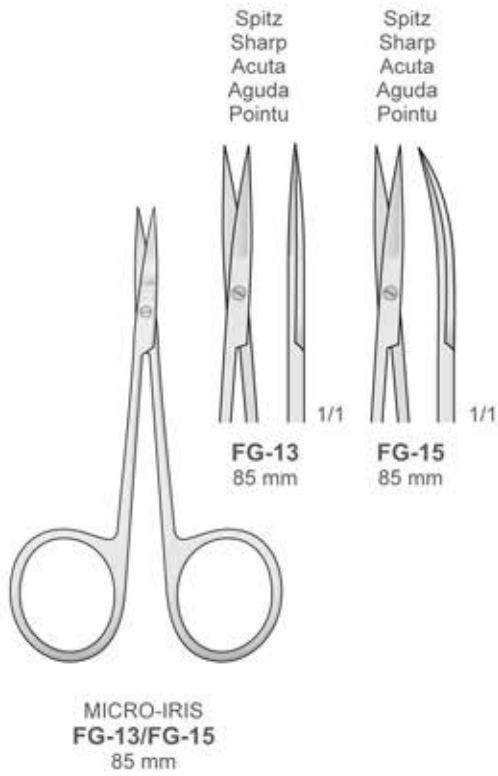



Scheren
 Scissors
 Forbici
 Tijeras
 Ciseaux

Spitz - Sharp
 Acuta - Agudo
 Aigu

Spitz - Sharp
 Acuta - Agudo
 Aigu



FM-126

FM-127

METZENBAUM
FM-126/FM-127
 145 mm

1/1 1/1
FM-12 FM-109

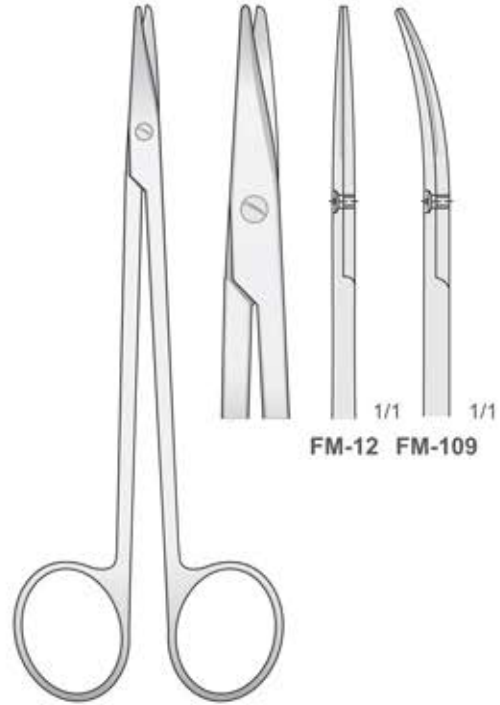

METZENBAUM
FM-12/FM-109
 150 mm

1/1
 Spitz
 Sharp
 Acuta
 Aguda
 Pointu

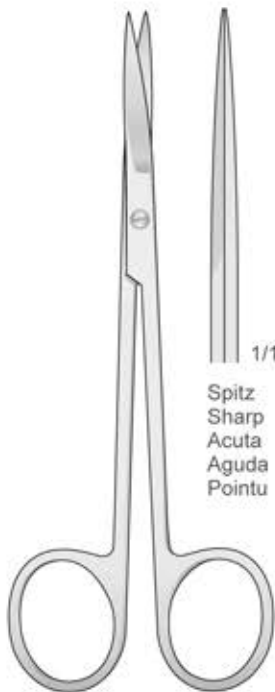

METZENBAUM
FG-28
 145 mm

1/1
 Spitz
 Sharp
 Acuta
 Aguda
 Pointu

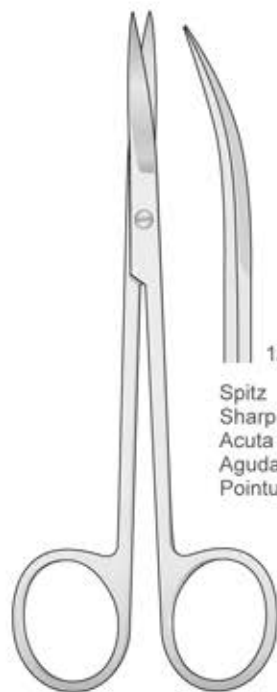

METZENBAUM
FG-14
 145 mm

FG-147
 150 mm

FG-148
 150 mm

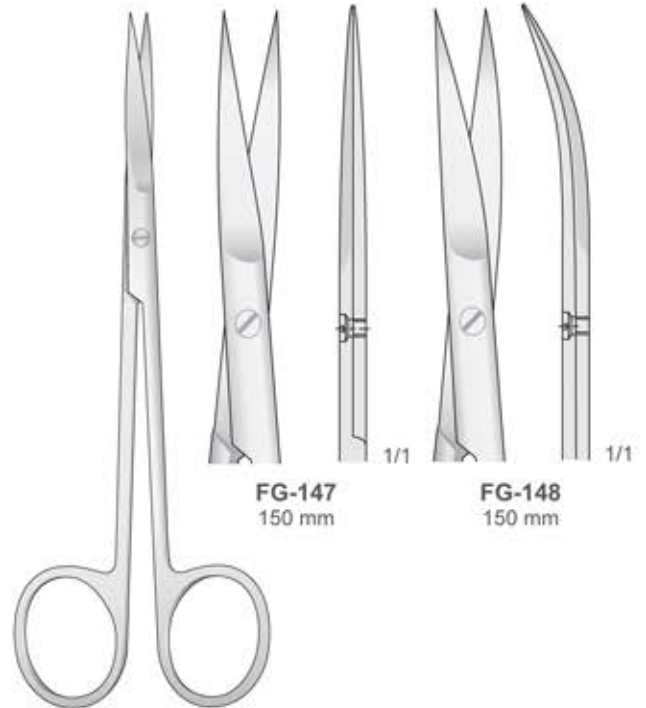

JOSEPH
FG-147/FG-148
 150 mm



Scheren
Scissors
Forbici
Tijeras
Ciseaux

Stumpf
Blunt
Smussa
Romas
Mousse

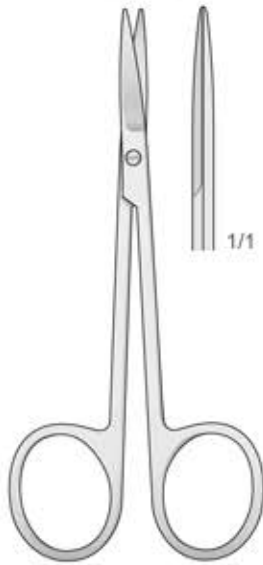

FG-101
110 mm

Stumpf
Blunt
Smussa
Romas
Mousse

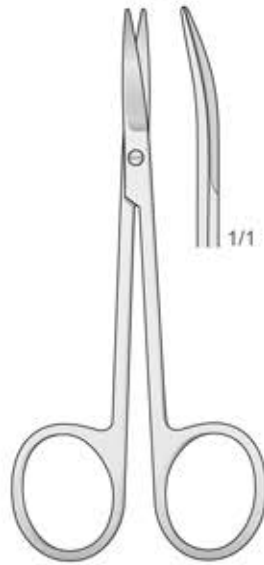

FG-102
110 mm

Stumpf
Blunt
Smussa
Romas
Mousse

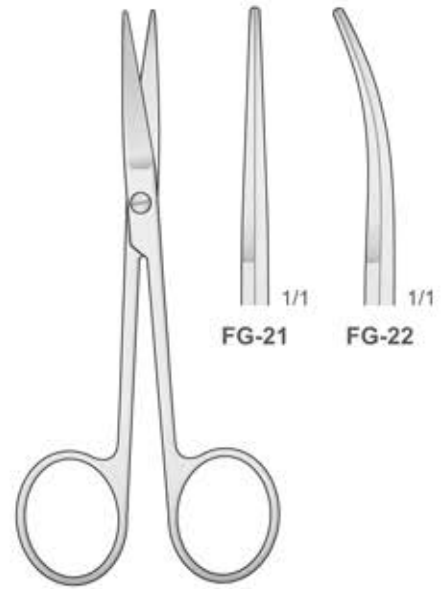

FG-21/FG-22
115 mm

Spitz
Sharp
Acute
Agudas
Pointu

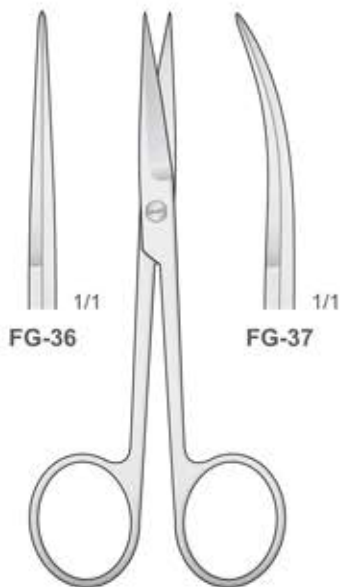

FG-36/FG-37
115 mm

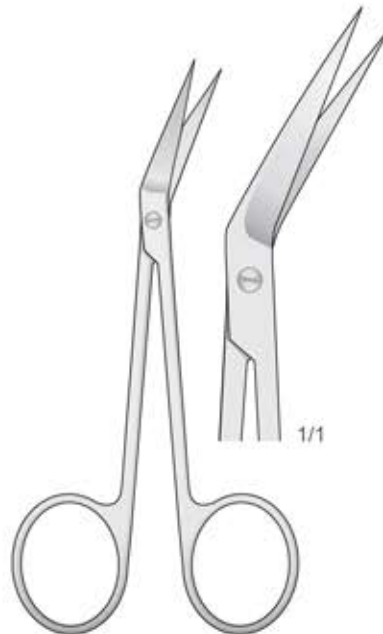

**LOCKLIN
LK-1**
115 mm

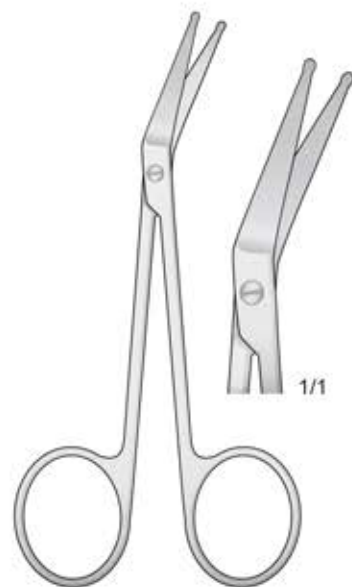

**LOCKLIN MOD.
LK-3**
110 mm



Scheren
 Scissors
 Forbici
 Tijeras
 Ciseaux



Mit einer Schneide gezahnt
 With one blade serrated
 Con una lama zigrinata
 Con una hoja dentada
 Avec lame dentelé

**KILNER
 FG-121**
 130 mm

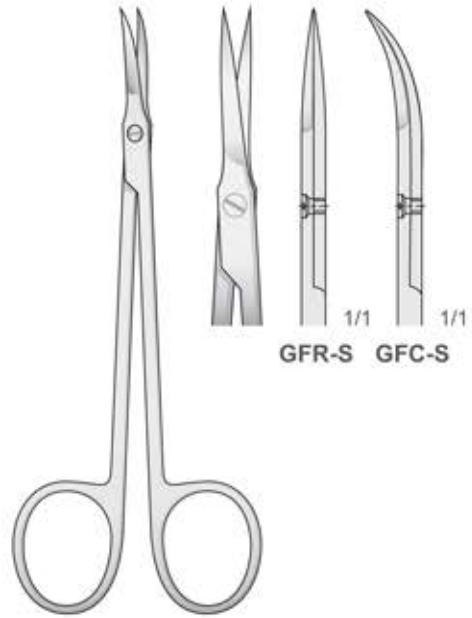

GFR-S GFC-S

GFR-S/GFC-S
 120 mm

Gezahnt - Serrated
 Dentellata - Dentadas
 Dentelé

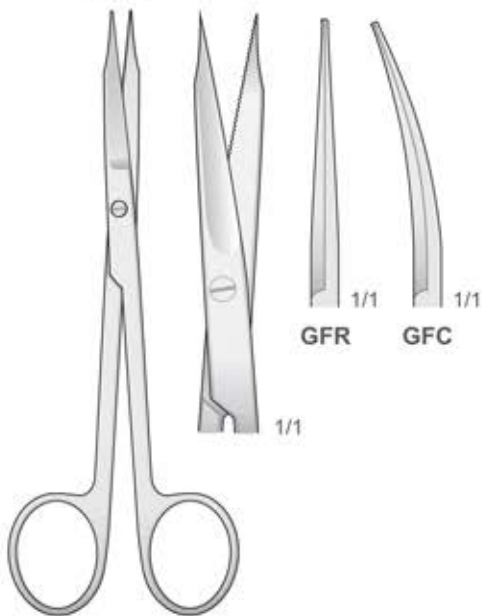

GFR GFC

**GOLDMAN-FOX
 GFR/GFC**
 120 mm

Gezahnt - Serrated
 Dentellata - Dentadas
 Dentelé

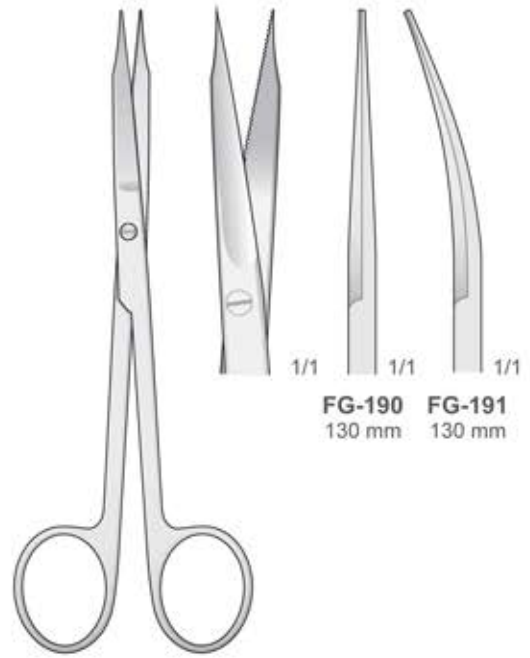

FG-190 FG-191
 130 mm 130 mm

**GOLDMAN-FOX
 FG-190/FG-191**
 130 mm



Gezahnt - Serrated
Dentellata - Dentadas
Dentelé



**LOCKLIN
LK-2**
160 mm

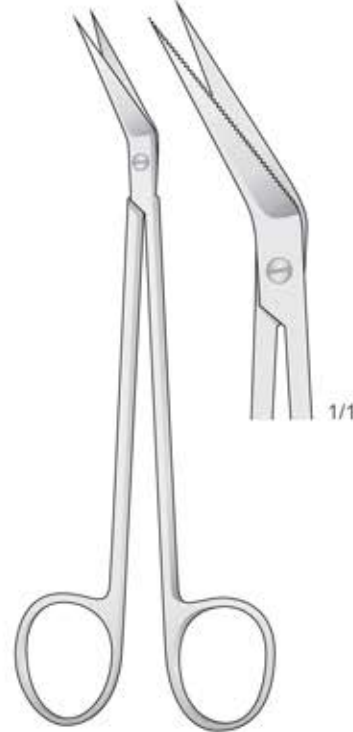

**LOCKLIN
LK-4**
160 mm

Gezahnt - Serrated
Dentellata - Dentadas
Dentelé

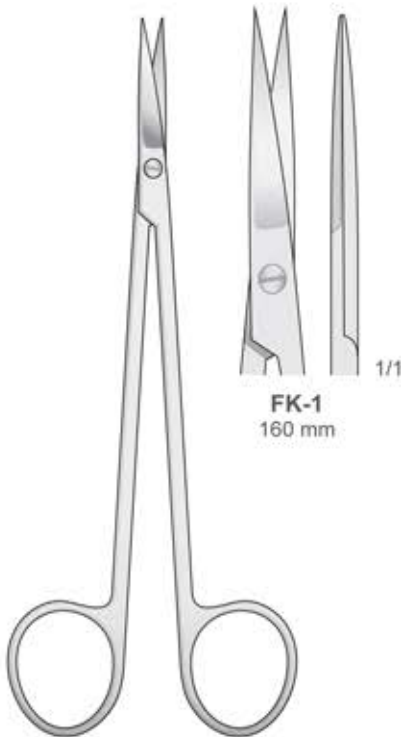

**KELLY
FK-1/FK-2**
160 mm

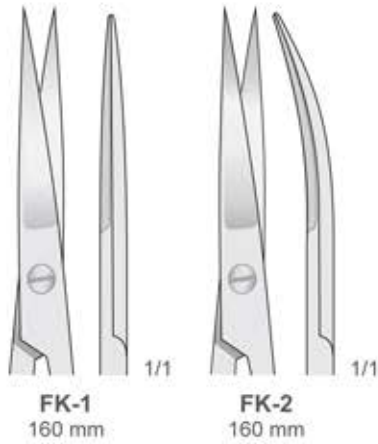

FK-2
160 mm

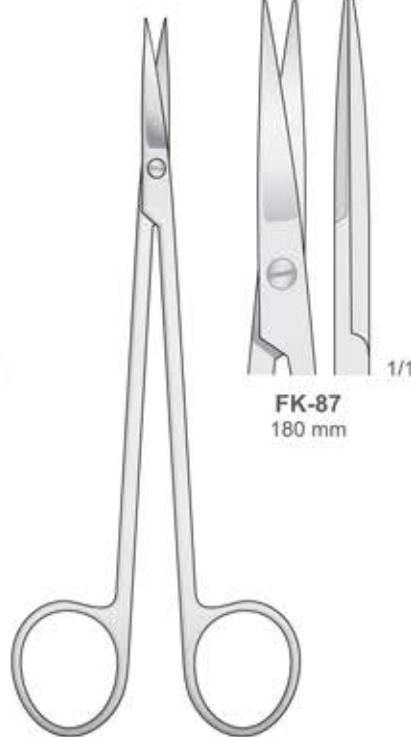

**KELLY
FK-87/FK-88**
180 mm

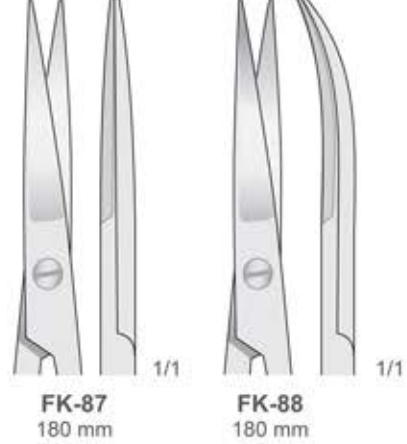

FK-88
180 mm



Scheren
 Scissors
 Forbici
 Tijeras
 Ciseaux

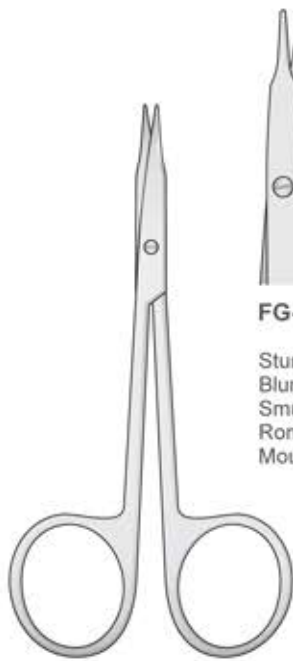

STEVENS
 FG-50/FG-53
 110 mm

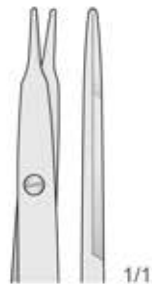

FG-50

Stumpf Gerade
 Blunt Straight
 Smussa Diritta
 Romas Rectas
 Mousse Droites



FG-51

Stumpf Gebogen
 Blunt Curved
 Smussa Curva
 Romas Curvas
 Mousse Courbes



FG-52

Spitz Gerade
 Sharp Straight
 Acuta Diritta
 Agudas Rectas
 Pointu Droites



FG-53

Spitz Gebogen
 Sharp Curved
 Acuta Curva
 Agudas Curvas
 Pointu Courbes

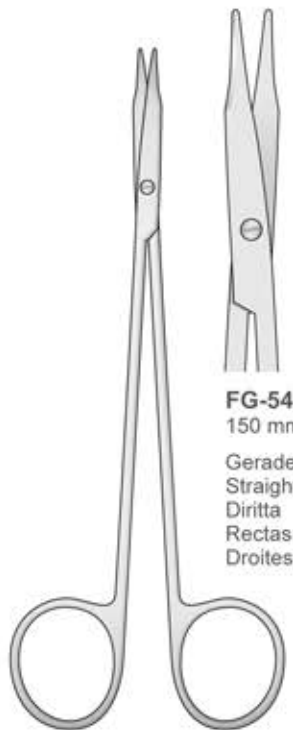

REYNOLDS
 FG-54/FG-55

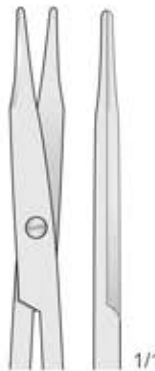

FG-54
 150 mm

Gerade
 Straight
 Diritta
 Rectas
 Droites



FG-55
 150 mm

Gebogen
 Curved
 Curva
 Curvas
 Courbes

Stumpf
 Blunt
 Smussa
 Romas
 Mousse



KILNER
 FG-19C/FG-67



FG-66
 120 mm

Gerade
 Straight
 Diritta
 Rectas
 Droites



FG-67
 120 mm

Gebogen
 Curved
 Curva
 Curvas
 Courbes



FG-19R
 135 mm

Gerade
 Straight
 Diritta
 Rectas
 Droites

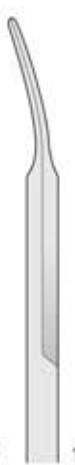

FG-19C
 135 mm

Gebogen
 Curved
 Curva
 Curvas
 Courbes



Scheren
Scissors
Forbici
Tijeras
Ciseaux

Gezahnt - Serrated
Dentellata - Dentadas
Dentelé

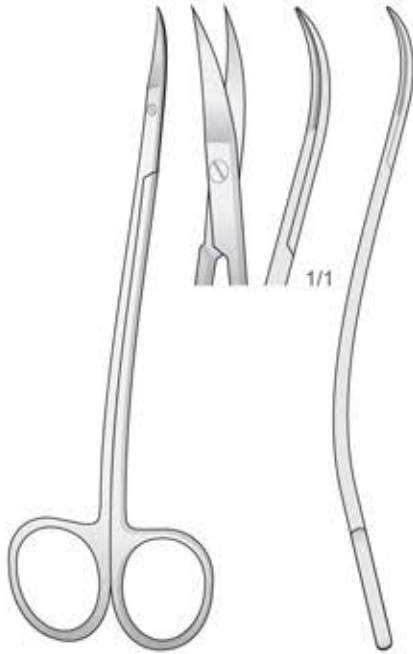

LA GRANGE
LG-1
115 mm



LA GRANGE
LG-6
155 mm

Gezahnt - Serrated
Dentellata - Dentada
Dentée

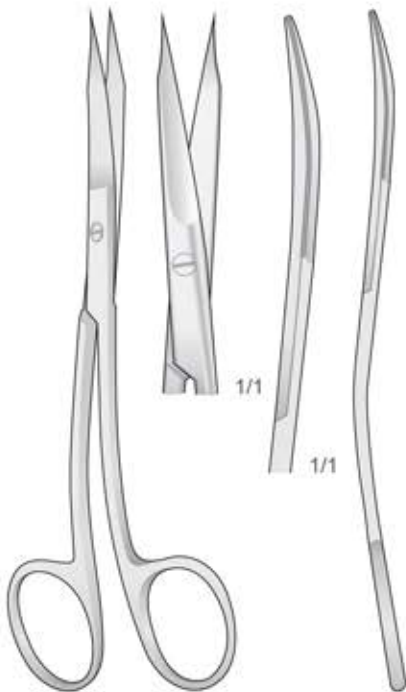

GOLDMAN-FOX S FORM
GFS
130 mm

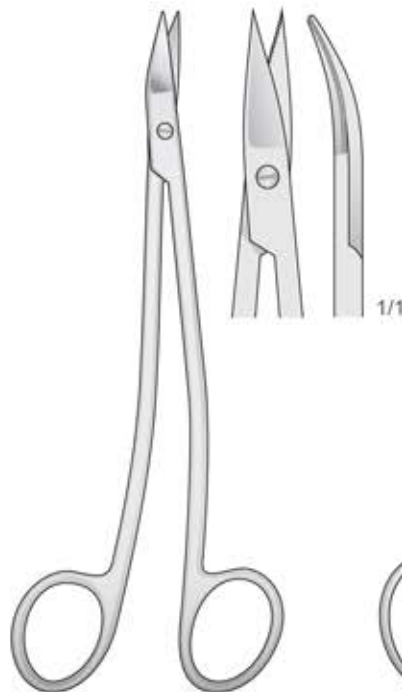

NEUMANN
FG-20
130 mm

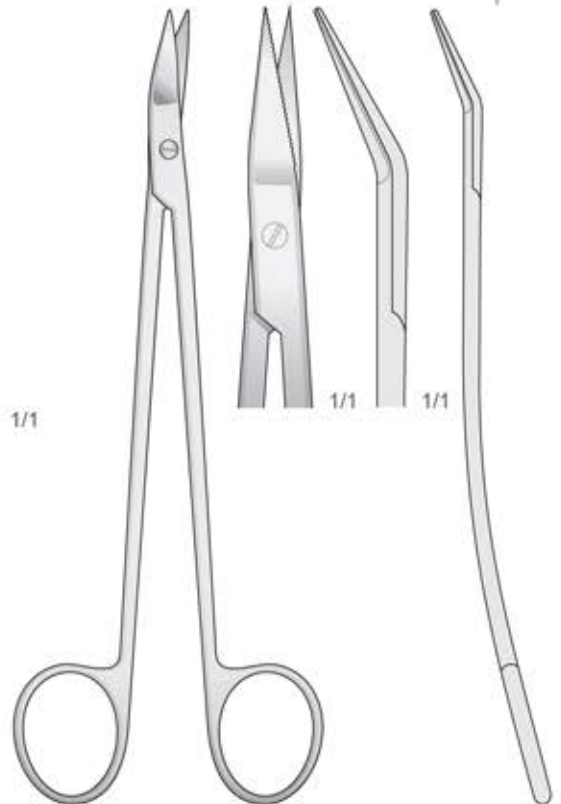

DEAN
DEAN
180 mm



Scheren
 Scissors
 Forbici
 Tijeras
 Ciseaux

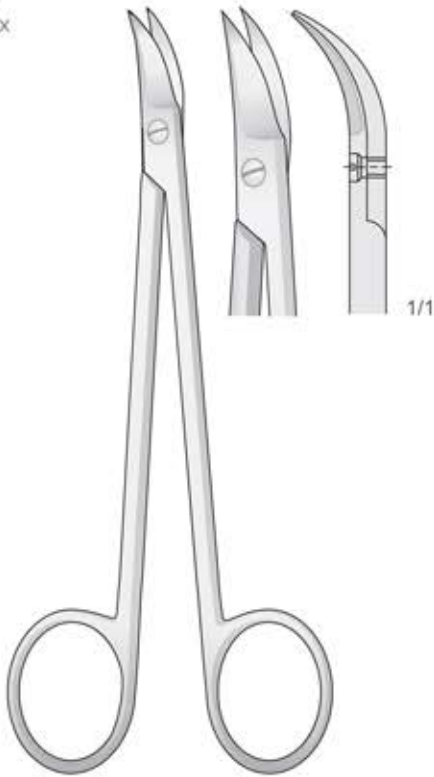

QUINBY
FG-38
 130 mm

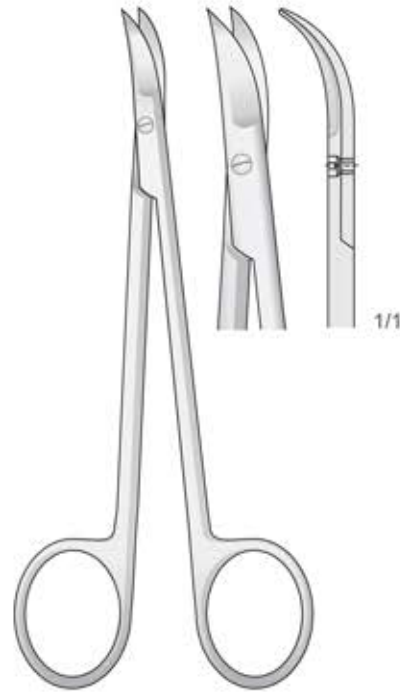

CHADWICK
FG-39
 115 mm

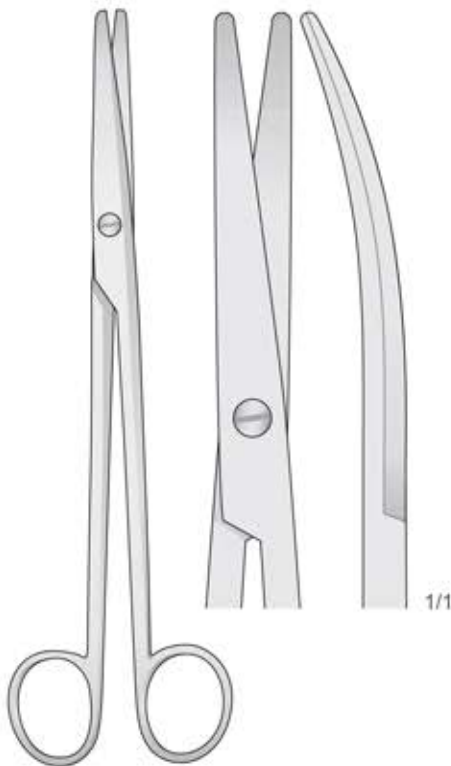

MAYO-LEXER
FM-79
 165 mm

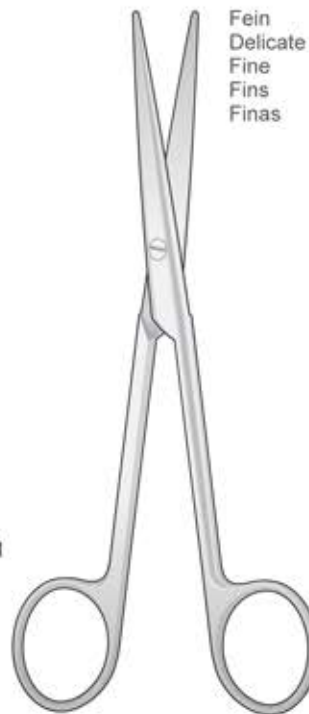

LEXER
FM-180/FM-181
 165 mm

Fein
 Delicate
 Fine
 Fins
 Finas



FM-180



FM-181



Scheren
Scissors
Forbici
Tijeras
Ciseaux

Stumpf
Blunt
Smusse
Romas
Mousses

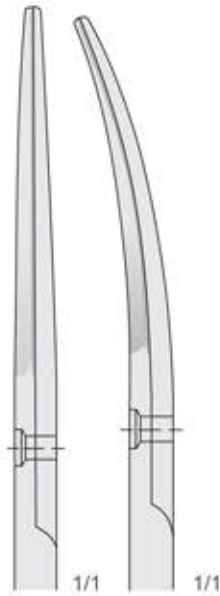

FM-9
145 mm

FM-10
145 mm



FM-49
115 mm

FM-27
130 mm

FM-63
115 mm

FM-28
130 mm

FM-9/FM-10
145 mm

FM-27/FM-63

Stumpf
Blunt
Smusse
Romas
Mousses

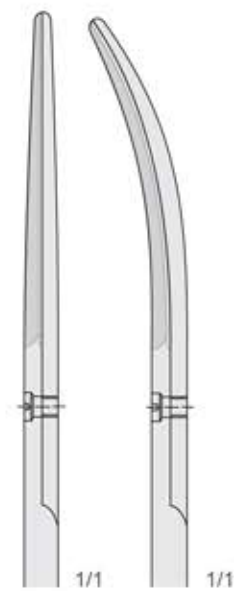

FM-5
140 mm

FM-6
140 mm

Spitz
Sharp
Acute
Agudo
Pointu

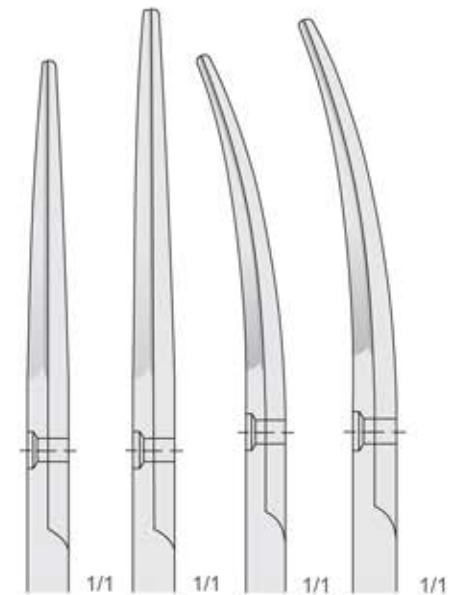

FM-41
130 mm

FM-7
145 mm

FM-42
130 mm

FM-8
145 mm

MAYO
FM-5/FM-6
140 mm

FM-7/FM-42



Scheren
 Scissors
 Forbici
 Tijeras
 Ciseaux

SUPER CUT

Regular Edge

SUPER CUT
Edge

Super Cut Scissors have specially designed cutting edges.
 One regular edge and one sharp-knife edge.

Extremely Sharp Razor Edge / Atraumatic
 Extrem Scharfe Spitzer Beck / Atraumatische
 Tranchant extrêmement aiguisée / Atraumatique
 Borde extremadamente afilado / Atraumática
 Taglio estremamente affilato / Atraumatica

One side serrated
 Eine seite gezahnt
 Un côté dentelé
 Un lado dentado
 Un lato dentellato

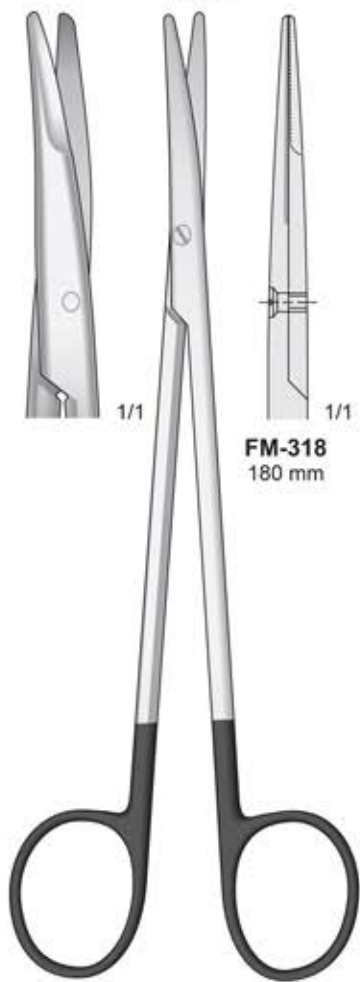
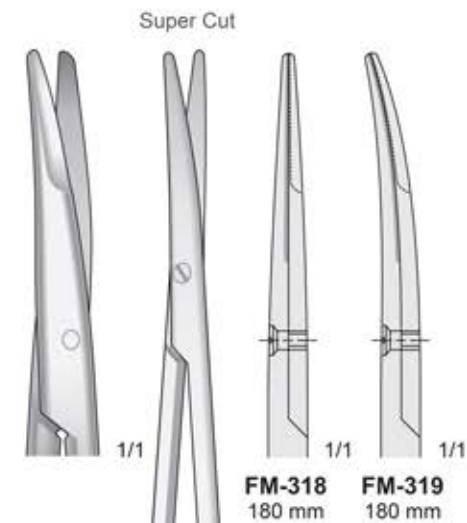

METZENBAUM
FM-318/FM-319
 180 mm

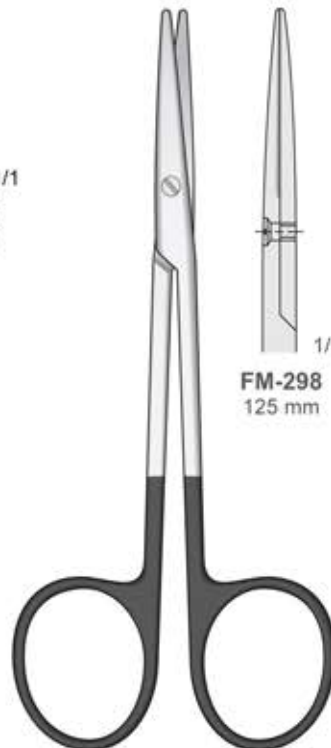
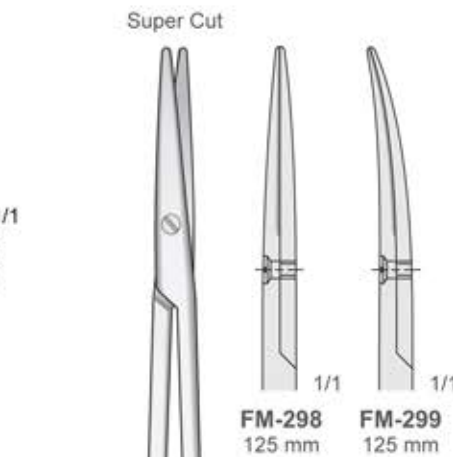

METZENBAUM
FM-298/FM-299
 125 mm

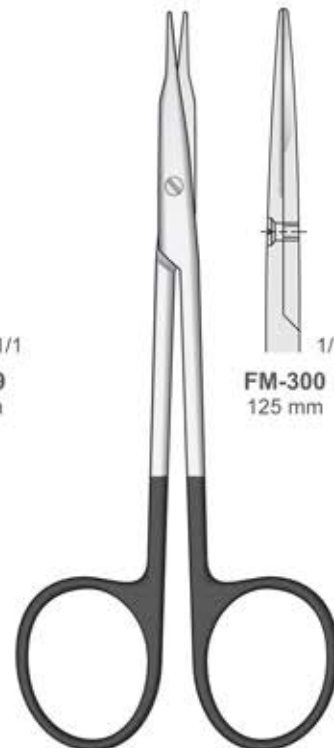

STEVENS
FM-300/FM-301
 125 mm



Scheren
Scissors
Forbici
Tijeras
Ciseaux

Fein
Delicate
Fine
Finas
Fins



FM-47
115 mm

FM-48
115 mm

BABY - METZENBAUM
FM-47/FM-48
115 mm

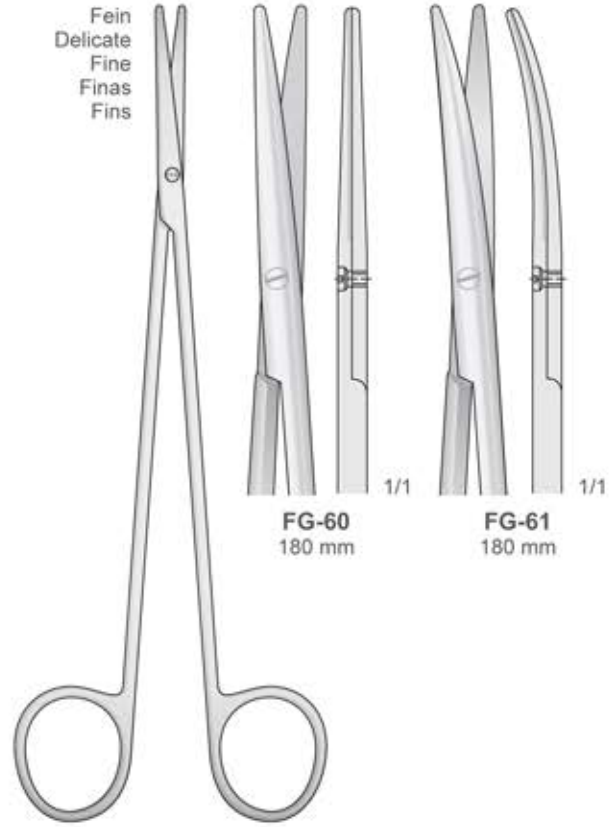

FG-60
180 mm

FG-61
180 mm

TOENNIS-ADSON
FG-60/FG-61
180 mm

Präparierscheren - Dissecting Scissors
Forbici per dissezione - Tijeras de disección - Ciseaux à dissection

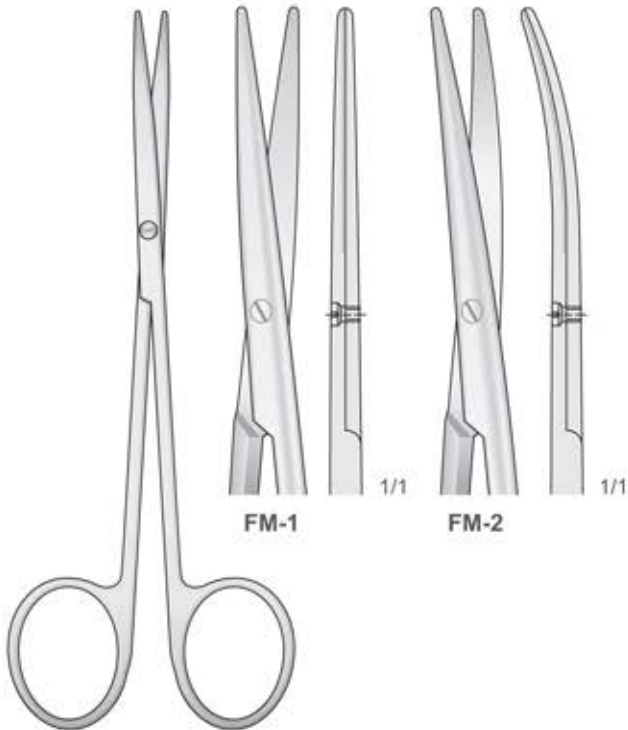

FM-1

FM-2

METZENBAUM
FM-1/FM-2
145 mm

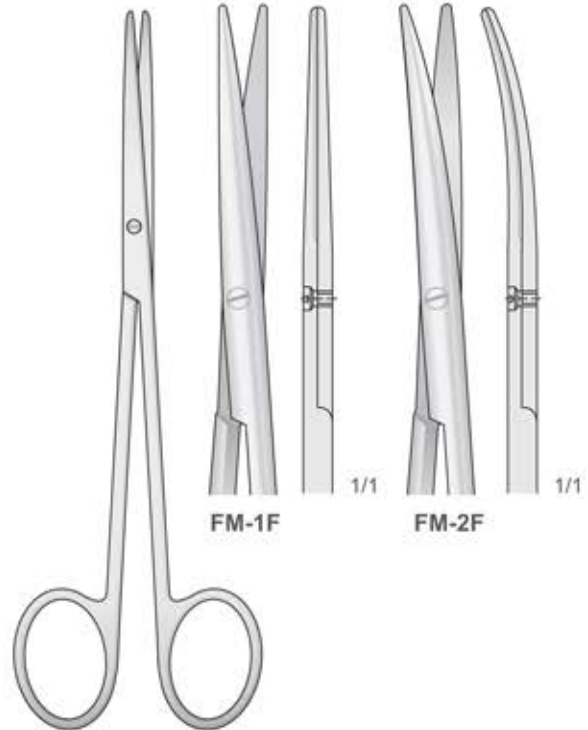

FM-1F

FM-2F

METZENBAUM-FINO
FM-1F/FM-2F
145 mm



Scheren
 Scissors
 Forbici
 Tijeras
 Ciseaux

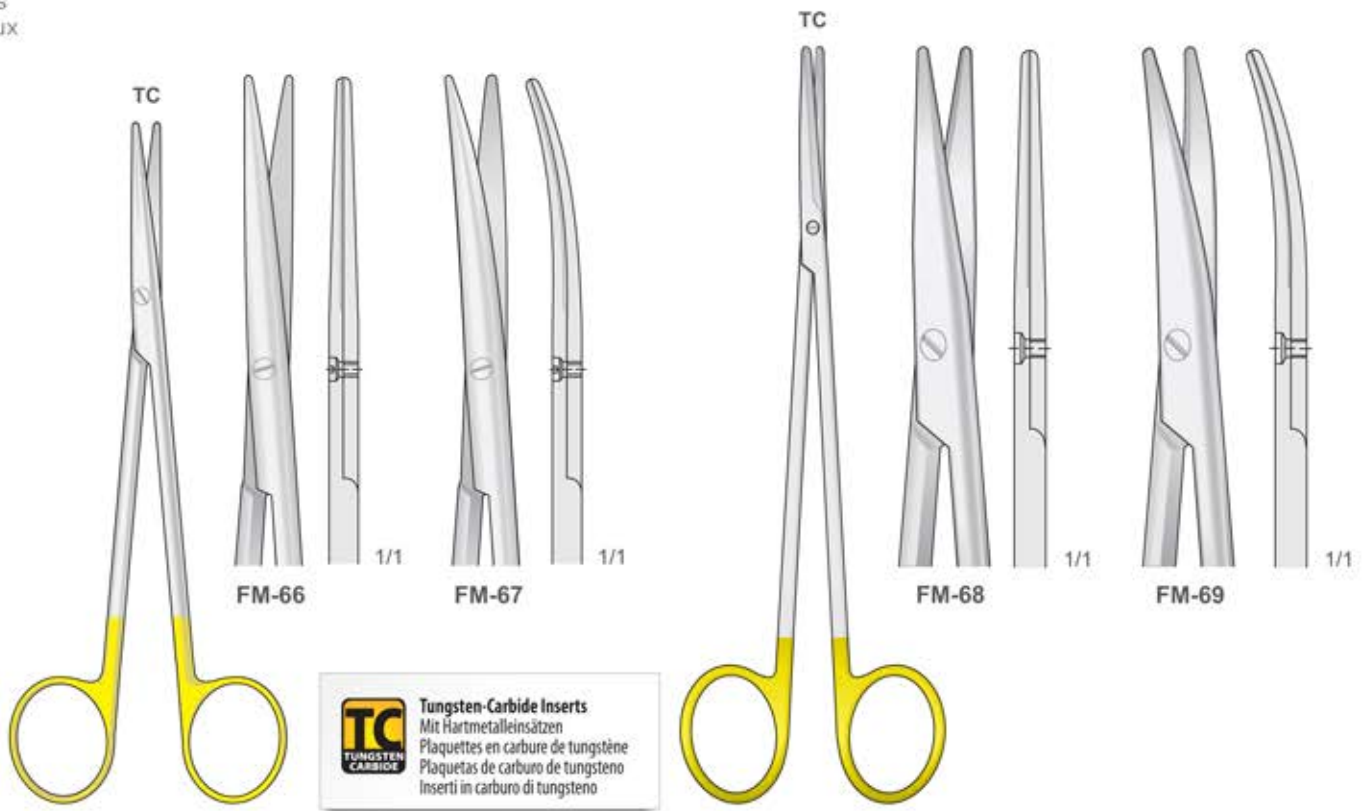

METZENBAUM
FM-66/FM-67
 145 mm

METZENBAUM
FM-68/FM-69
 185 mm

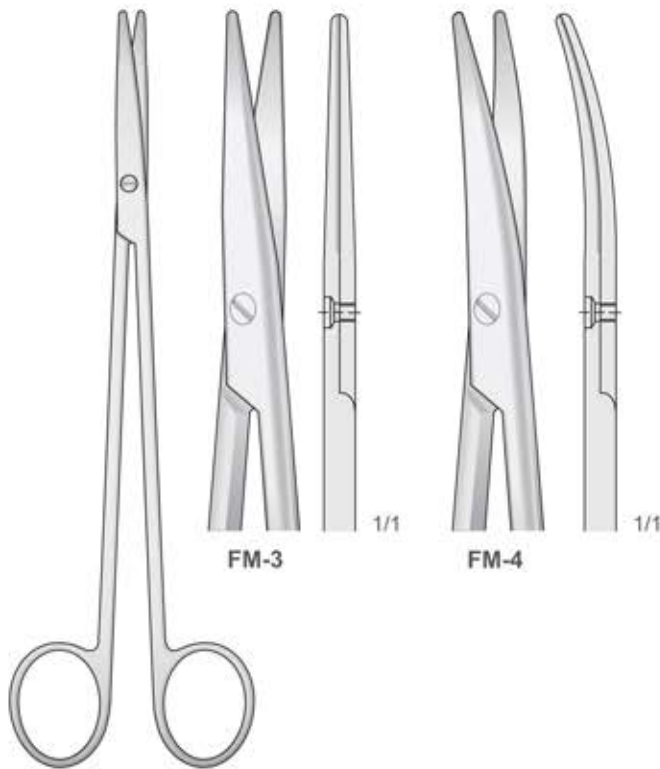

METZENBAUM
FM-3/FM-4
 185 mm

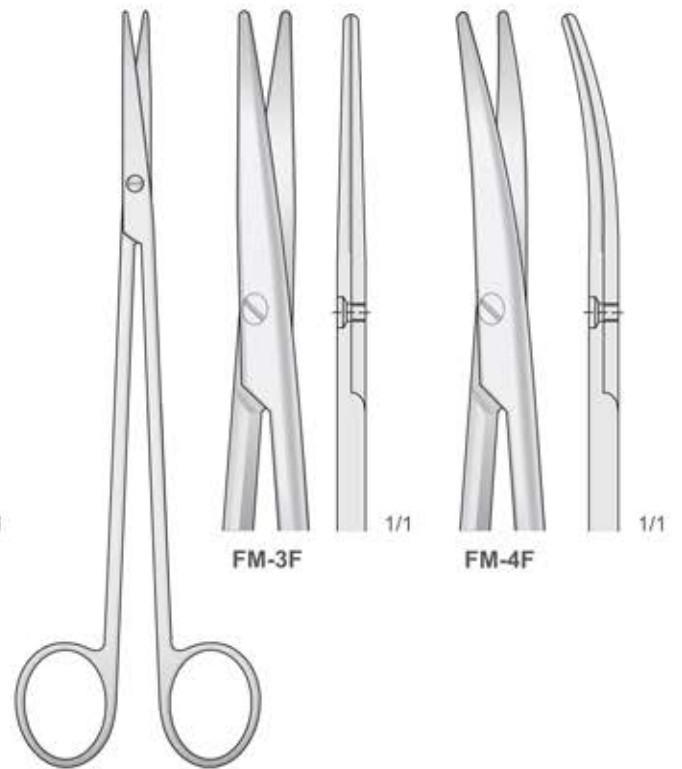

METZENBAUM-FINO
FM-3F/FM-4F
 185 mm

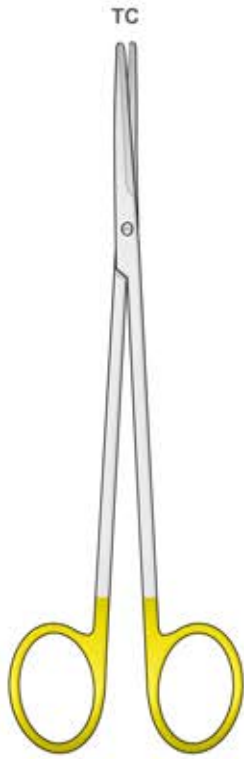

METZENBAUM-FINO
FM-201/FM-204



FM-201
140 mm

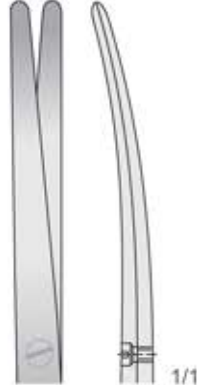

FM-202
140 mm

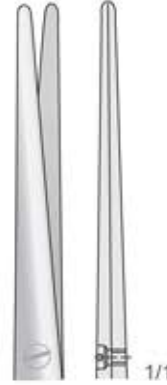

FM-203
180 mm



FM-204
180 mm



Tungsten-Carbide Inserts
Mit Hartmetalleinsätzen
Plaquettes en carbure de tungstène
Plaquetas de carburo de tungsteno
Inserti in carburo di tungsteno

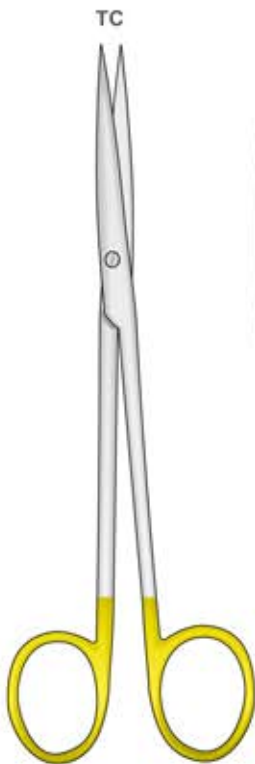

METZENBAUM-FINO
FM-96/FM-99

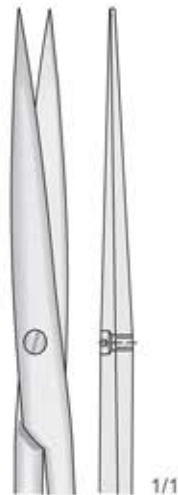

FM-96
140 mm



FM-97
180 mm

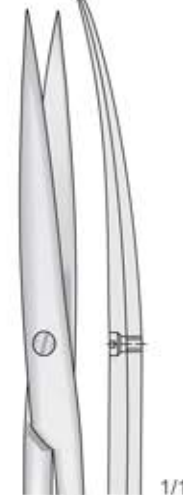

FM-98
140 mm



FM-99
180 mm



Scheren
Scissors
Forbici
Tijeras
Ciseaux



Tungsten-Carbide Inserts
Mit Hartmetalleinsätzen
Plaquettes en carbure de tungstène
Plaquetas de carburo de tungsteno
Inserti in carburo di tungsteno

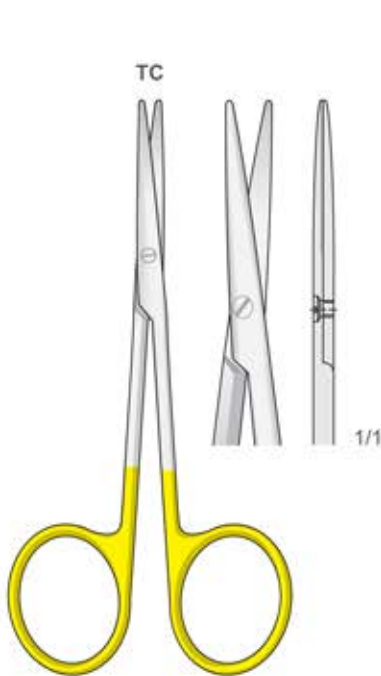

LEXER-BABY (KNAPP)
FM-118
115 mm

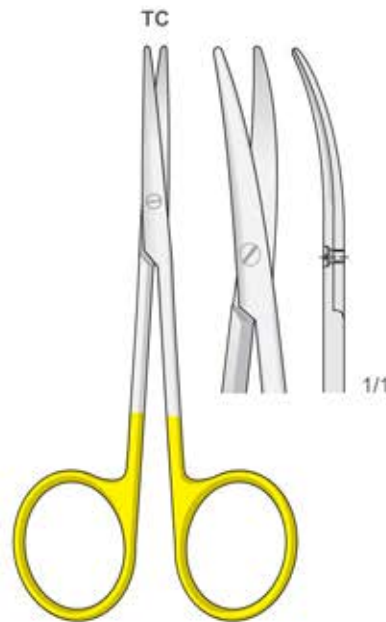

LEXER-BABY (KNAPP)
FM-119
115 mm

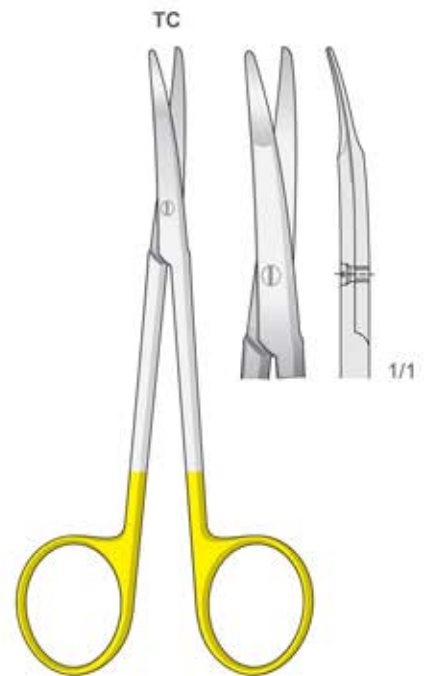

KILNER
FM-350
125 mm

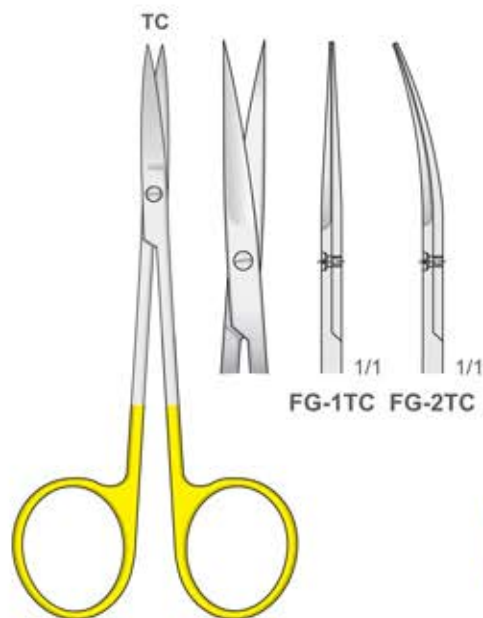

IRIS
FG-1TC/FG-2TC
115 mm

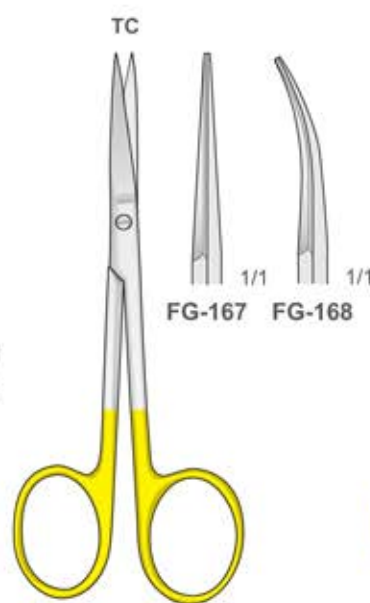

FG-167/FG-168
110 mm

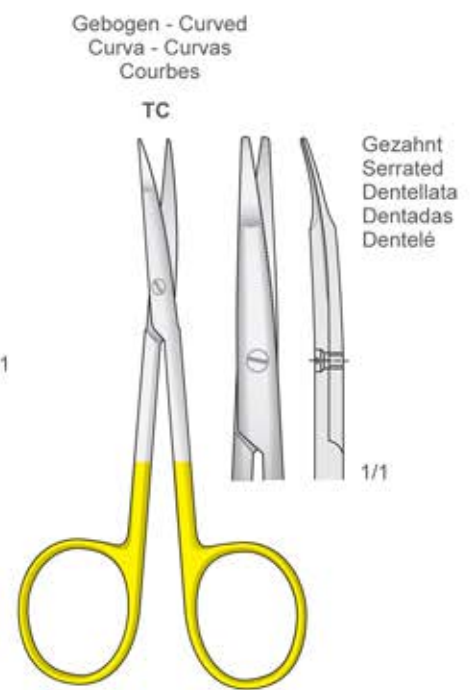

GREENBERG-PAR
FM-317
115 mm

Gebogen - Curved
Curva - Curvas
Courbes

Gezähnt
Serrated
Dentellata
Dentadas
Dentelé

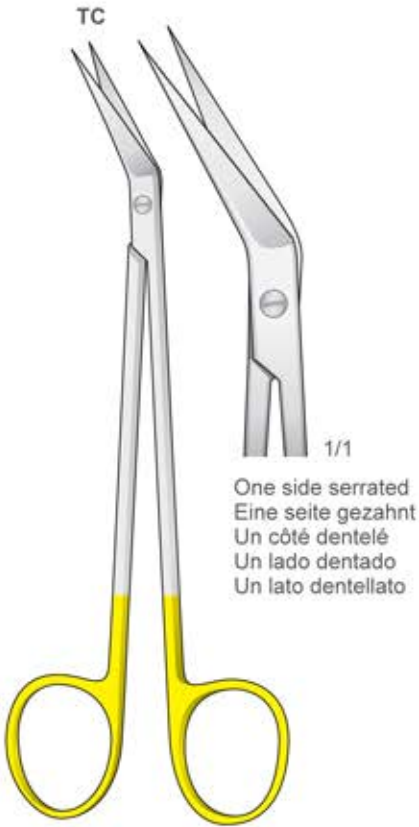

LK-10
160 mm

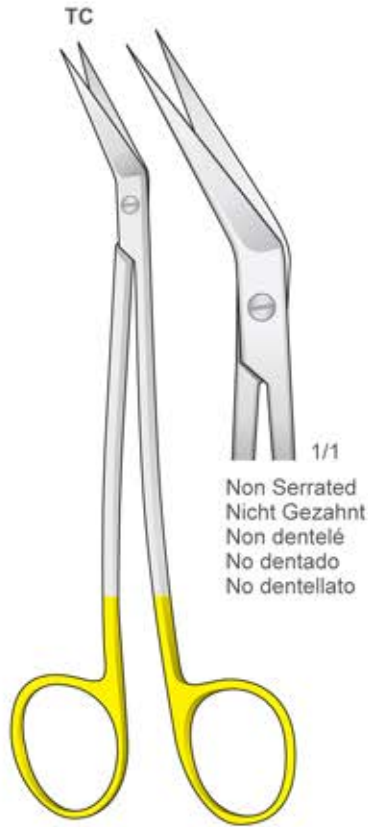

LK-12
160 mm



Eine Schneide gezahnt S-förmig gebogen
One toothed cutting edge S-shaped
Una lama dentata curva a forma S
Una hoja dentada forma S
Une lame dentelée courbés en S

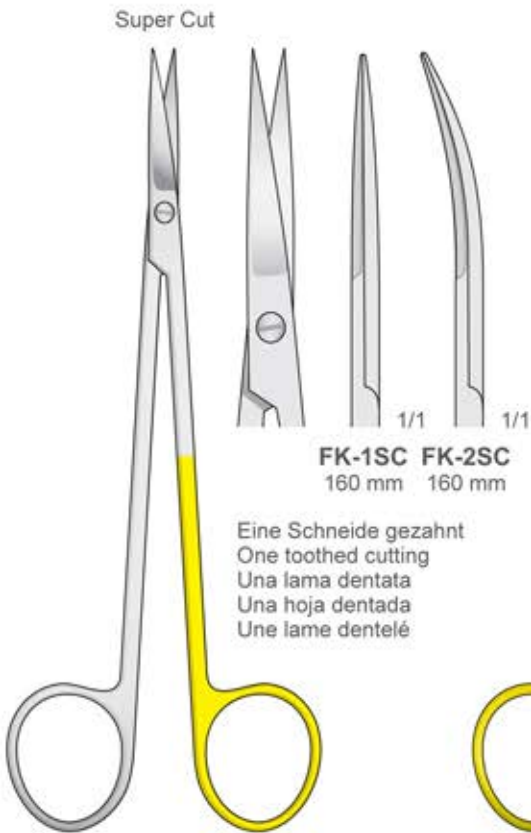

KELLY
FK-1SC/FK-2SC
160 mm

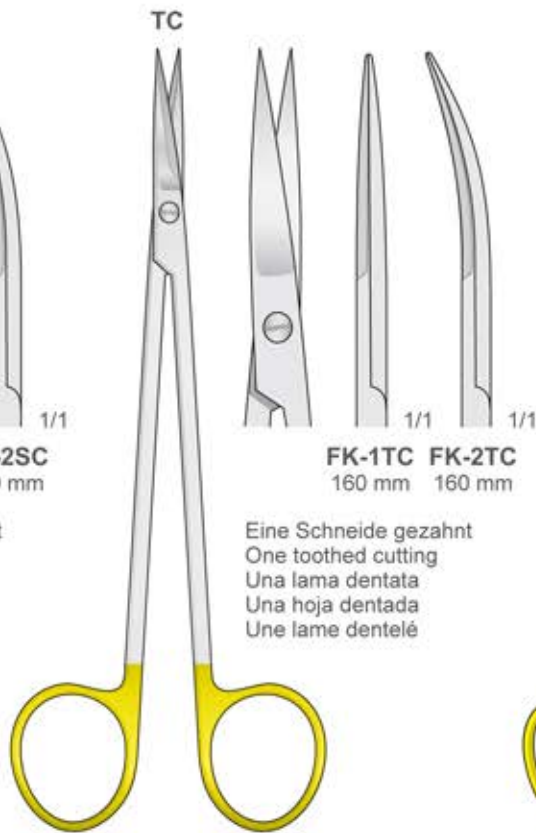

KELLY
FK-1TC/FK-2TC
160 mm

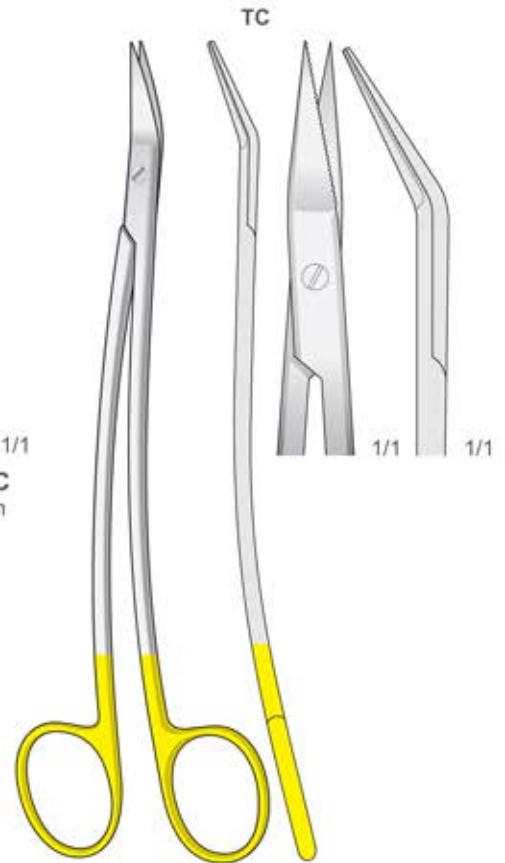

DEAN-TC
175 mm



Scheren
 Scissors
 Forbici
 Tijeras
 Ciseaux

Wellenschliff
 TC

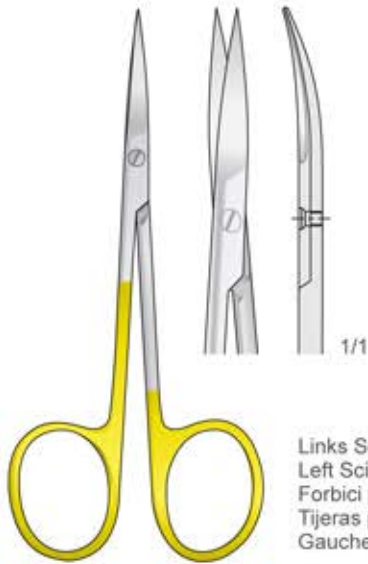

Links Scheren
 Left Scissors
 Forbici per mancini
 Tijeras para zurdos
 Gauche Ciseaux

IRIS
FM-100L
 110 mm



Tungsten-Carbide Inserts
 Mit Hartmetalleinsätzen
 Plaquettes en carbure de tungstène
 Plaquetas de carburo de tungsteno
 Inserti in carburo di tungsteno

Wellenschliff
 TC

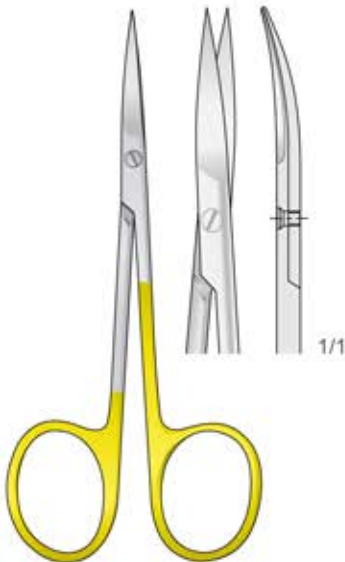

IRIS
FM-100
 110 mm

Wellenschliff
 TC

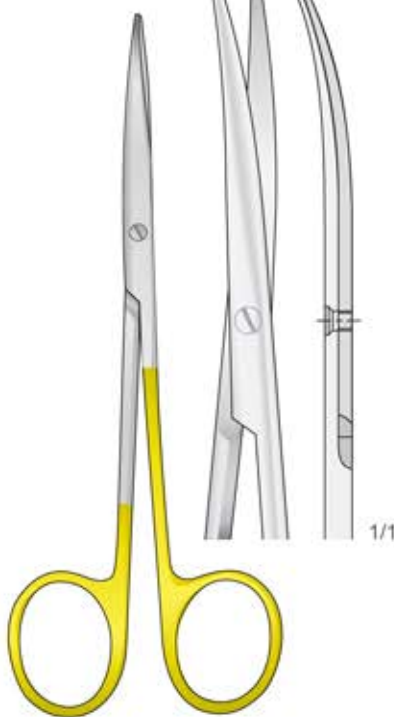

METZENBAUM
FM-102
 145 mm

Wellenschliff
 TC

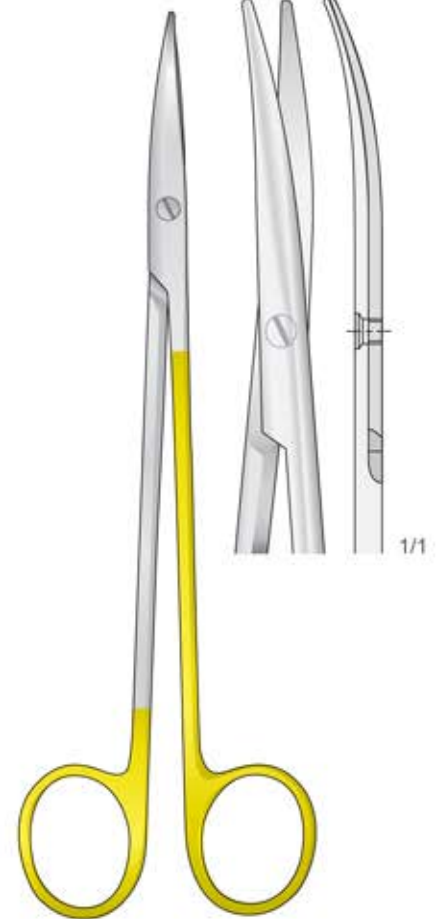

METZENBAUM
FM-104
 185 mm



Extremely Sharp Razor Edge / Atraumatic
Extrem Scharfe Spitzer Beck / Atraumatische
Tranchant extrêmement aiguisée / Atraumatique
Borde extremadamente afilado / Atraumática
Taglio estremamente affilato / Atraumatica

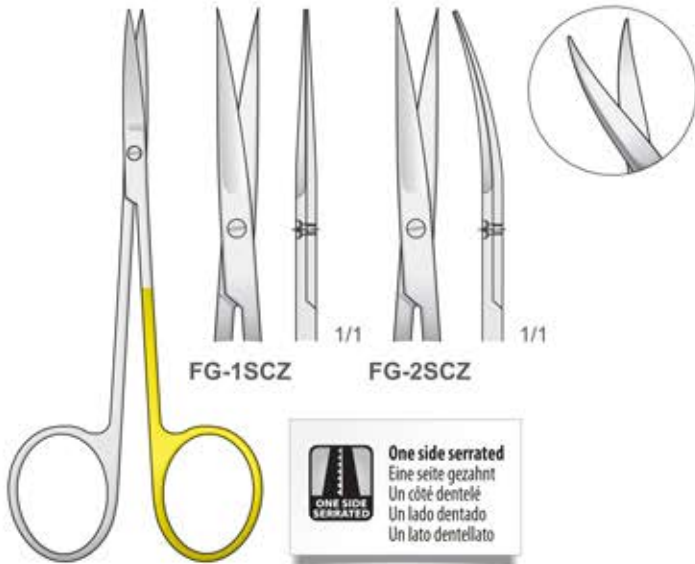

One side serrated
Eine seite gezahnt
Un côté dentelé
Un lado dentado
Un lato dentellato

FG-1SCZ/FG-2SCZ
110 mm

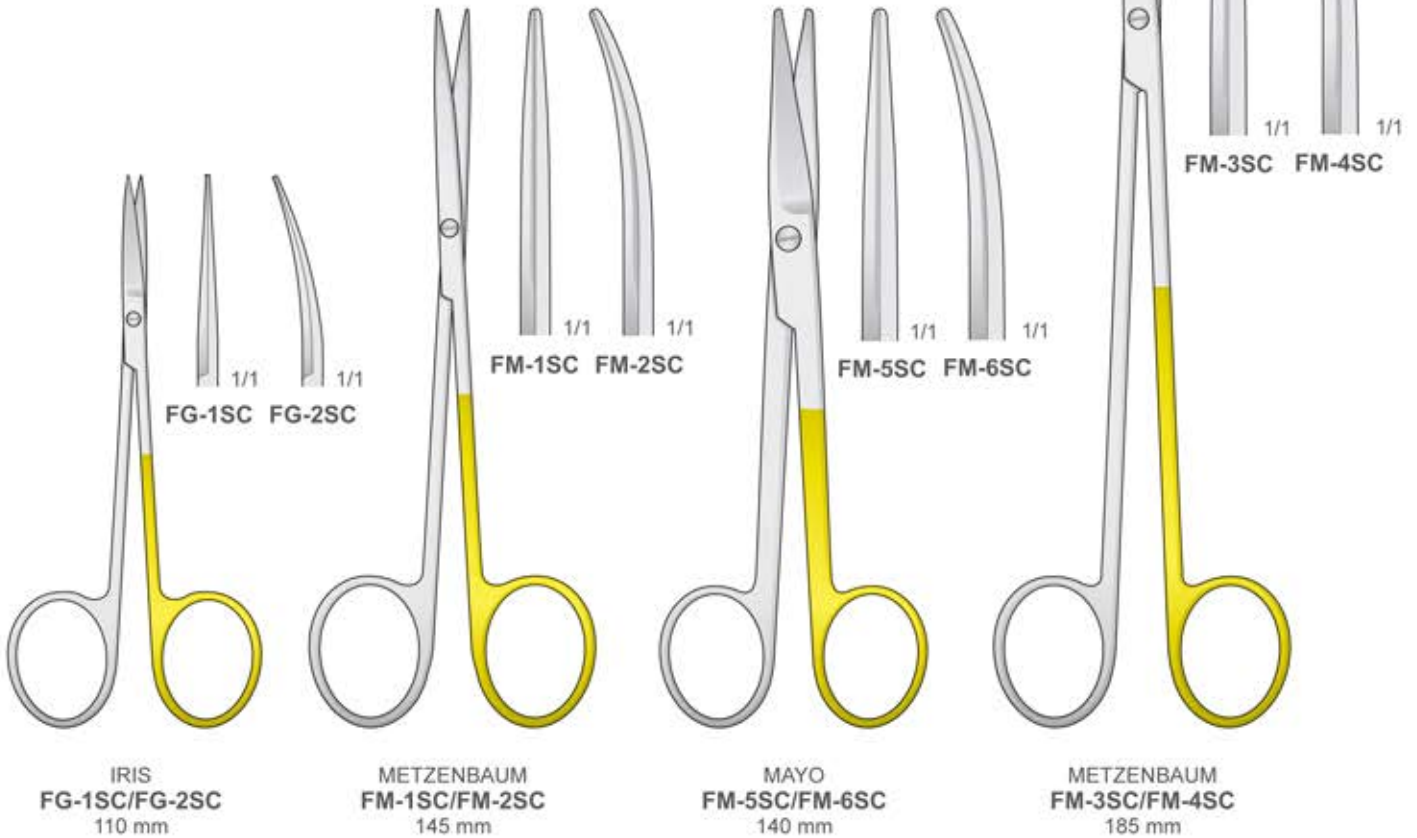

IRIS
FG-1SC/FG-2SC
110 mm

METZENBAUM
FM-1SC/FM-2SC
145 mm

MAYO
FM-5SC/FM-6SC
140 mm

METZENBAUM
FM-3SC/FM-4SC
185 mm



Scheren
Scissors
Forbici
Tijeras
Ciseaux

SUPER CUT

Regular Edge SUPER CUT Edge

Super Cut Scissors have specially designed cutting edges.
One regular edge and one sharp-knife edge.

- Extremely Sharp Razor Edge / Atraumatic**
 Extrem Scharfe Spitzer Beck / Atraumatische
 Tranchant extrêmement aiguisée / Atraumatique
 Borde extremadamente afilado / Atraumática
 Taglio estremamente affilato / Atraumatica
- One side serrated**
 Eine seite gezahnt
 Un côté dentelé
 Un lado dentado
 Un lato dentellato

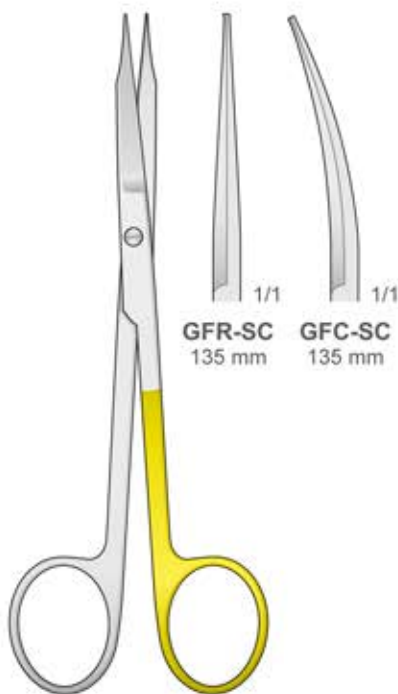

GOLDMAN-FOX
GFR-SC/GFC-SC
135 mm

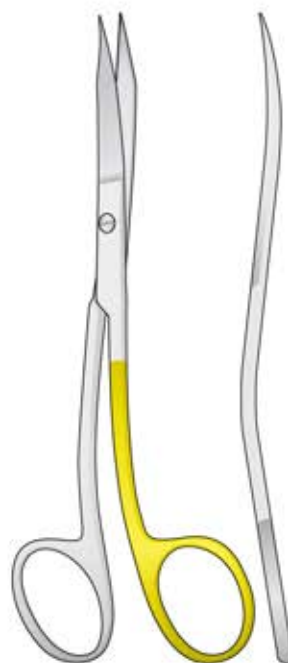

GOLDMAN-FOX S FORM
GFS-SC
130 mm

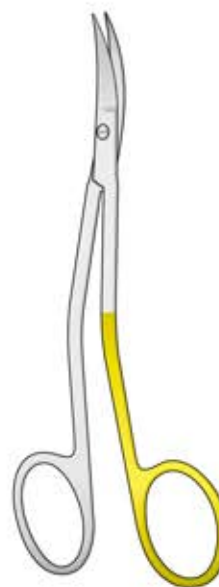

LA GRANGE
LG-1SC/LG-2SC
115 mm

Spitz
Sharp
Acute
Agudas
Pointu

Stumpf
Blunt
Smusse
Romas
Mousse

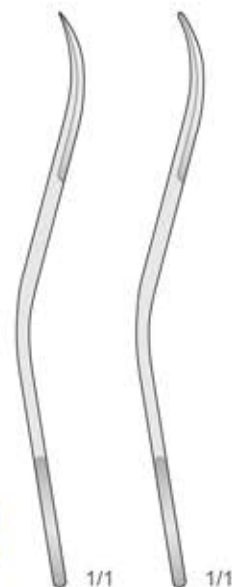

LA GRANGE **LA GRANGE** **LA GRANGE**
LG-1SC **LG-2SC**



JOSEPH
FG-153/FG-154
150 mm

TC
TUNGSTEN
CARBIDE

Tungsten-Carbide Inserts
Mit Hartmetalleinsätzen
Plaquettes en carbure de tungstène
Plaquetas de carburo de tungsteno
Inserti in carburo di tungsteno

**ONE SIDE
SERRATED**

One side serrated
Eine seite gezahnt
Un côté dentelé
Un lado dentado
Un lato dentellato

**ONE SIDE
SERRATED**

One side serrated
Eine seite gezahnt
Un côté dentelé
Un lado dentado
Un lato dentellato

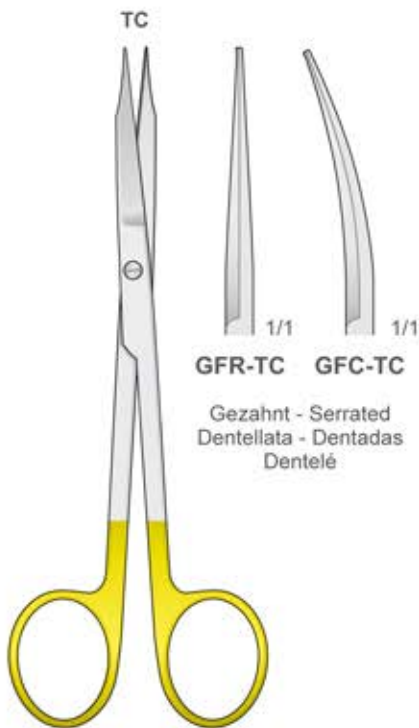

GOLDMAN-FOX
GFC-TC/GFR-TC
135 mm

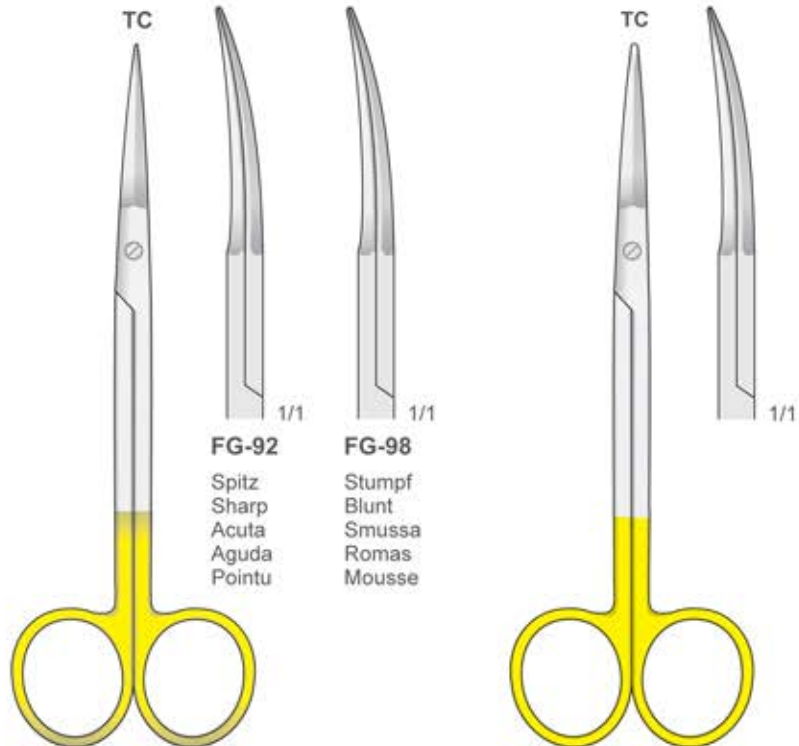

PECK-JOSEPH
FG-92/FG-98
140 mm

GREGORY
FM-339
140 mm



Scheren
 Scissors
 Forbici
 Tijeras
 Ciseaux



TC
TUNGSTEN
CARBIDE

Tungsten-Carbide Inserts
 Mit Hartmetalleinsätzen
 Plaquettes en carbure de tungstène
 Plaquetas de carburo de tungsteno
 Inserti in carburo di tungsteno

FM-146
 145 mm

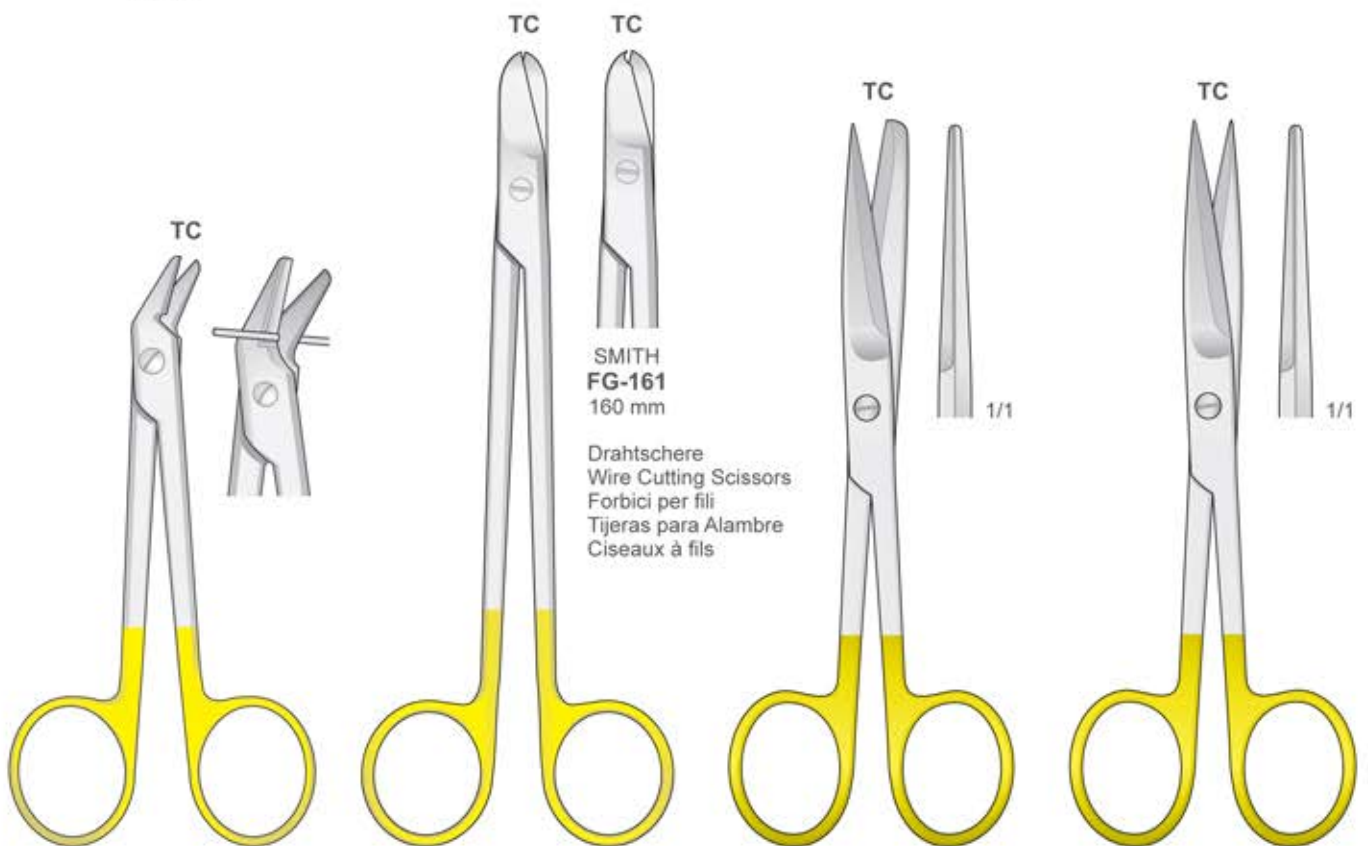

DP-120
 120 mm

SMITH
FG-160
 160 mm

FM-51
 145 mm

FM-59
 145 mm

SMITH
FG-161
 160 mm

Drahtschere
 Wire Cutting Scissors
 Forbici per fili
 Tijeras para Alambre
 Ciseaux à fils



Ligatur Scheren
Ligature Scissors
Forbici per legature
Tijeras para ligaduras
Ciseaux à ligatures

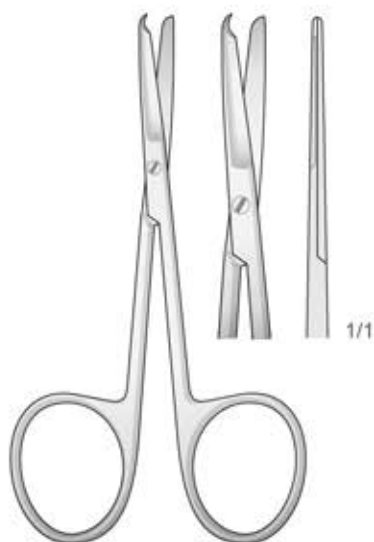

SPENCER
SC-9
90 mm



SPENCER
SC-1
110 mm



SPENCER
SC-5
110 mm



SPENCER
SC-2
145 mm



SPENCER
SC-14
120 mm



LITTAUER
SC-15
140 mm



SPENCER
SC-13
130 mm

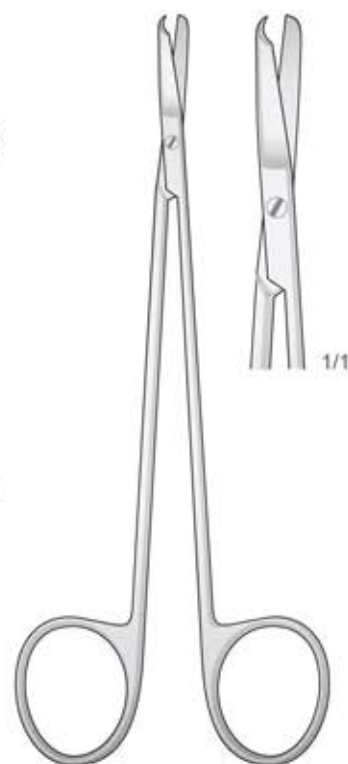

KELLY
SC-16
150 mm



Draht und blechscheren
 Wire and plate cutting scissors
 Forbici per fili metallici
 Tijeras para cortar alambre
 Ciseaux coupe-fils métalliques

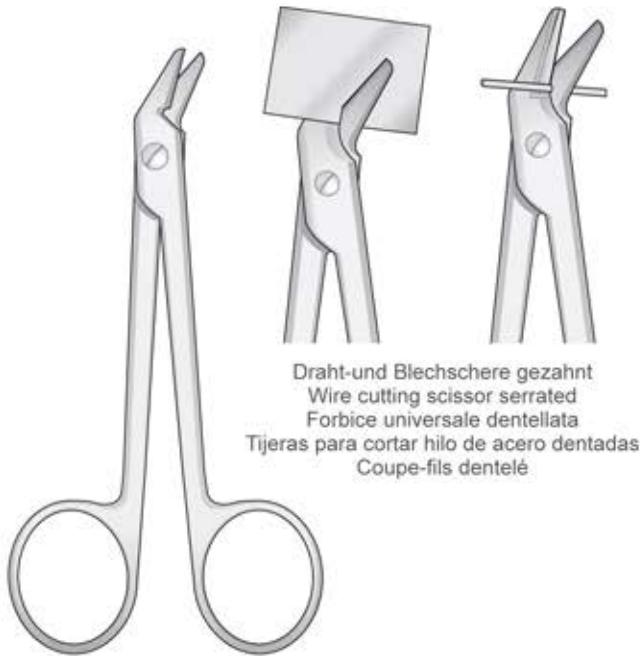

Draht-und Blehschere gezahnt
 Wire cutting scissor serrated
 Forbice universale dentellata
 Tijeras para cortar hilo de acero dentadas
 Coupe-fils dentelé

DP-90
 120 mm

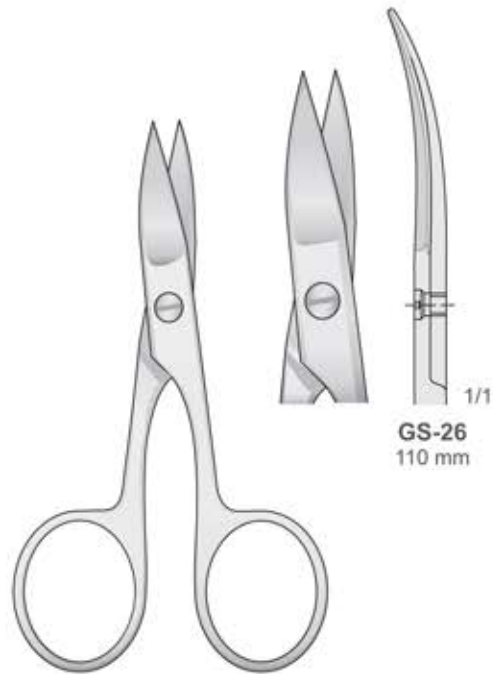

GS-26
 110 mm

Spitz
 Sharp
 Acute
 Agudas
 Pointu



BEEBE
DP-91/DP-101
 110 mm

Stumpf
 Blunt
 Smusse
 Romas
 Mousse



BEEBE
DP-102/DP-105
 110 mm

Receive a Free Multimedia Catalogue DVD.

Includes over 10,000 instruments
made in Germany
for all medical specialty fields.

Erhalten Sie ein kostenloses Exemplar des Multimedia-Katalogs auf DVD.

Umfasst mehr als 10.000 Instrumente,
hergestellt in Deutschland
für alle medizinischen Fachrichtungen.

Recevez gratuitement le DVD multimédia avec tous nos catalogues.

Comprend plus de 10.000 instruments
fabriqués en Allemagne
pour toutes les spécialités médicales.

Reciba gratis el DVD multimedia con todos nuestros catálogos.

Incluye más de 10.000 instrumentos
hechos en Alemania
para todas las especialidades médicas.

Ricevi gratuitamente il DVD multimediale con tutti i nostri cataloghi.

Comprende più di 10.000 strumenti
fatti in Germania
per tutte le specializzazioni mediche.



E

Tissue and Dressing Forceps
Chirurgische und Anatomische Pinzetten
Pinces à tissu et à pansement
Pinzas quirúrgicas y anatómicas
Pinzette chirurgiche e anatomiche





Mikro Pinzetten
 Delicate Forceps
 Micro Pinzette
 Pinzas finas
 Micro Pincers

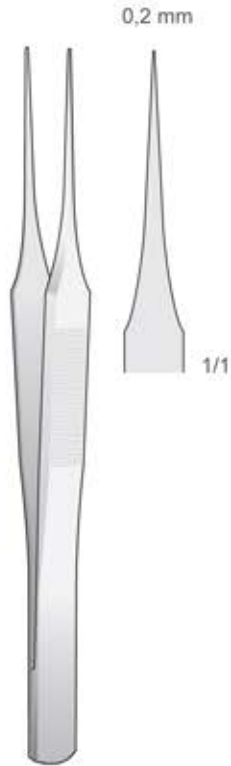

BD-360
110 mm

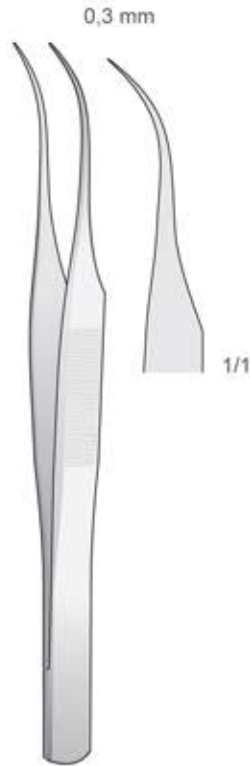

BD-361
110 mm

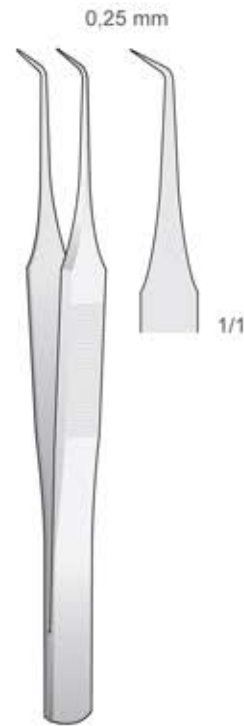

BD-362
100 mm

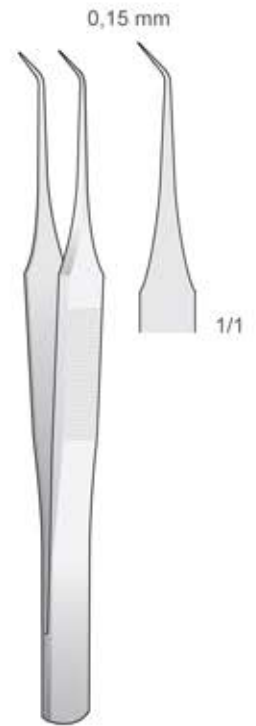

BD-363
100 mm

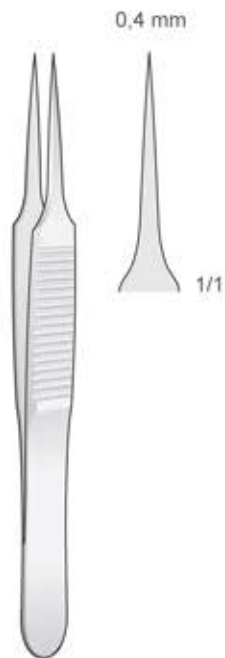

BD-364
110 mm

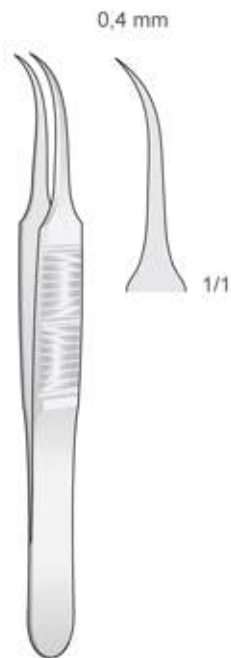

BD-365
110 mm

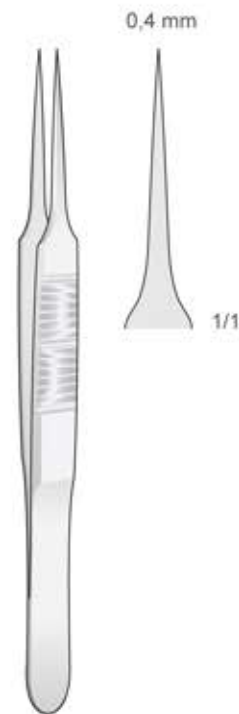

BD-366
130 mm

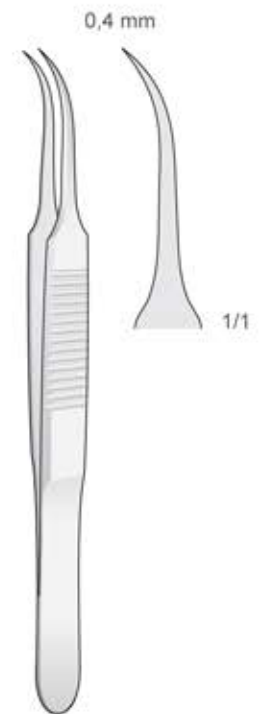

BD-367
130 mm

Mikro Pinzetten
Delicate Forceps
Micro Pinzette
Pinzas finas
Micro Pincas



Tissue Forceps
1x2 Teeth



BISHOP-HARMON
MF-177 1,2 mm
85 mm

Dressing Forceps
criss-cross serrated tips

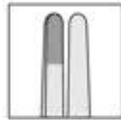

BISHOP-HARMON
MF-249 1,2 mm
85 mm



1/1
1x2 Zähne
1x2 Teeth
1x2 Denti
1x2 Dientes
1x2 Dents

CASTROVIEJO
BD-348 0,9 mm
120 mm



1/1
9x9 Zähne
9x9 Teeth
9x9 Denti
9x9 Dientes
9x9 Dents

BROWN
BD-349
120 mm

1,2 mm



ADSON
BD-207
120 mm



1,2 mm

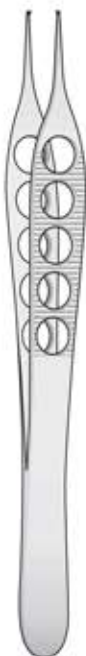

ADSON
BD-208
120 mm



ADSON-BROWN
BD-209
120 mm



7x7 Zähne
7x7 Teeth
7x7 Denti
7x7 Dientes
7x7 Dents



ADSON-BROWN
BD-253
120 mm

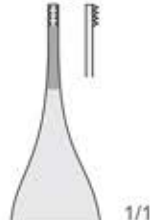



Mikro Pinzetten
 Delicate Forceps
 Micro Pinzette
 Pinzas finas
 Micro Pincers

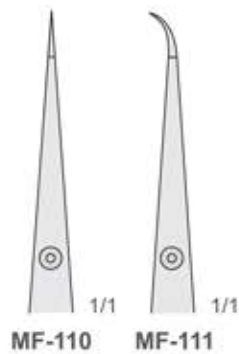

MF-110/MF-111
 120 mm

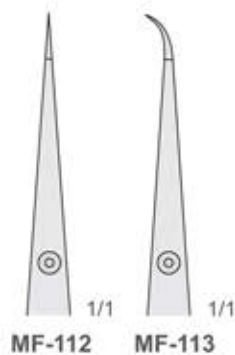

MF-112/MF-113
 150 mm

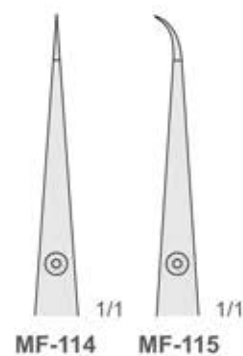

MF-114/MF-115
 180 mm

Mikro Pinzette - Rundgriff Ø 8 mm
 Mit Führungsstift diamantiert
 Fadenplatte 6x0,7 mm

Mikro Pinzetten
 Micro Forceps
 Micro Pinzette
 Micro Pinzas
 Micro Pincers



Diamond Tip
 Diamantiert
 Punta diamantata
 Punta de diamante
 Pointe de diamant

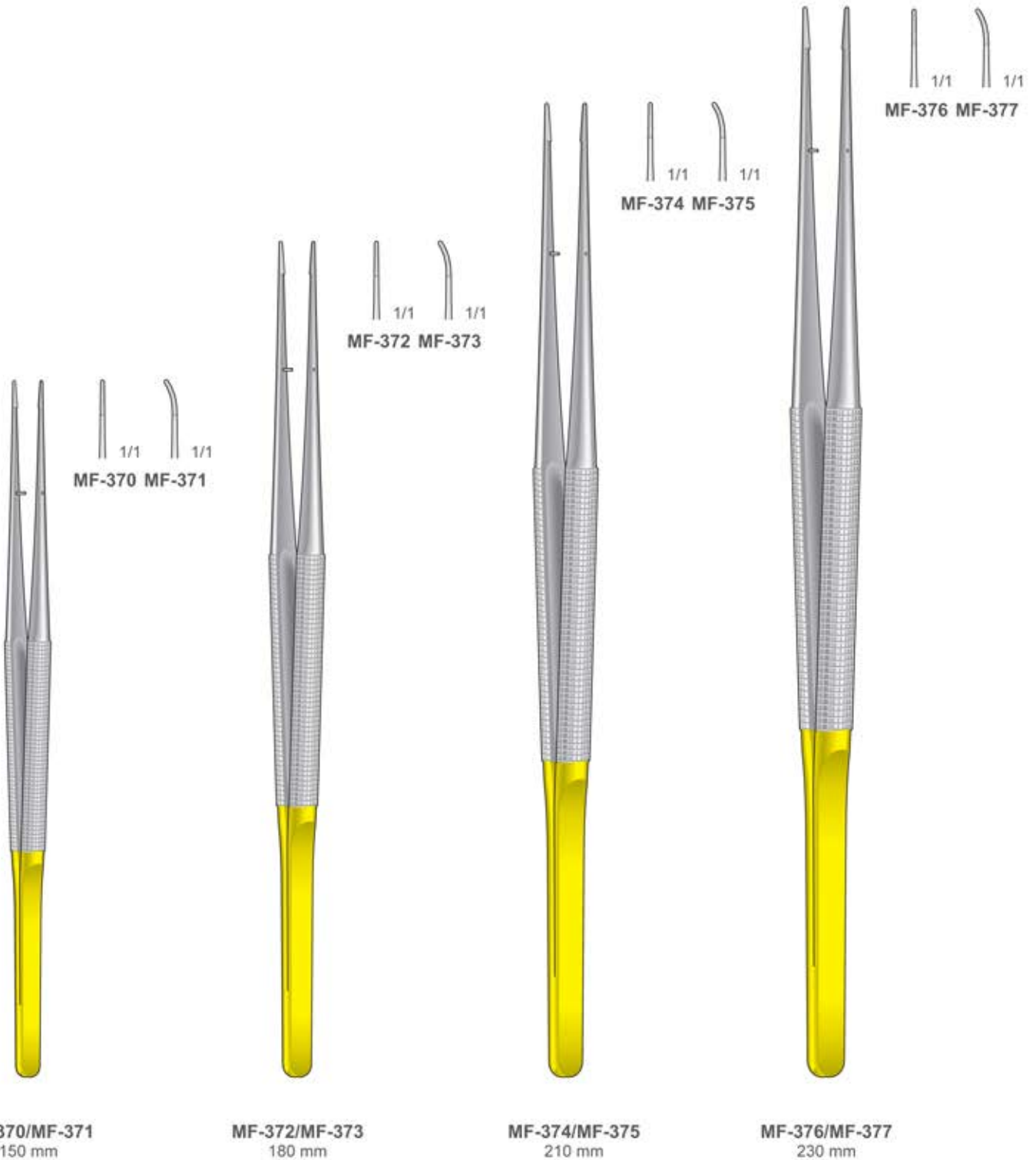



Mikro Pinzetten
 Micro Forceps
 Micro Pinzette
 Micro Pinzas
 Micro Pincers

Mikro Pinzette - Rundgriff Ø 8 mm
 Mit Führungsstift diamantiert
 Fadenplatte 6x0,7 mm



1x2 Zähne
 1x2 Teeths
 1x2 Denti
 1x2 Dientes
 1x2 Dents

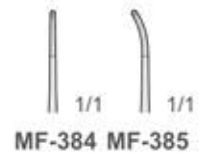

1x2 Zähne
 1x2 Teeths
 1x2 Denti
 1x2 Dientes
 1x2 Dents



1x2 Zähne
 1x2 Teeths
 1x2 Denti
 1x2 Dientes
 1x2 Dents

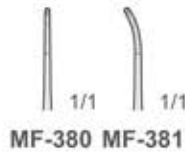

1x2 Zähne
 1x2 Teeths
 1x2 Denti
 1x2 Dientes
 1x2 Dents

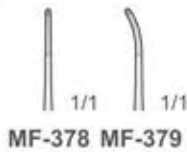

MF-378/MF-379
 150 mm

MF-380/MF-381
 180 mm

MF-382/MF-383
 210 mm

MF-384/MF-385
 230 mm



Titan-Pinzetten
Titanium Tissue Forceps
Pinzette in titanio
Pinzas de titanio
Pinces en titane



Titanium
Titan
Titane
Titanio
Titano



BD-285T
90 mm



BD-270T
130 mm

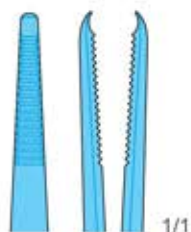

1/1



ADSON
BD-30T
120 mm

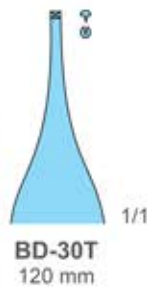

1/1



ADSON
BD-31T
120 mm

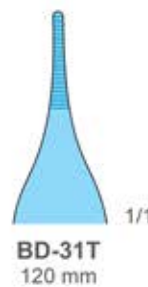

1/1



BD-09T
130 mm



1/1



GERALD
MF-101T/MF-102T
180 mm



1/1

MF-101T
180 mm



1/1

MF-102T
180 mm



DE BAKEY
BD-80T/BD-160T



1/1

BD-160T
160 mm



1/1

BD-80T
160 mm



COLLEGE
TT-01
150 mm



BD-75T
145 mm



1/1



Mikro Pinzetten
 Delicate Forceps
 Micro Pinzette
 Pinzas finas
 Micro Pincers

Rund-Griffe Ø 8 mm
 Round handle Ø 8 mm
 Manico rotondo Ø 8 mm
 Mango redondo Ø 8 mm
 Manche rond Ø 8 mm



Ø 1 mm



MF-124 - 150 mm
MF-125 - 180 mm
MF-126 - 210 mm

Ø 2 mm



MF-127 - 150 mm
MF-128 - 180 mm
MF-129 - 210 mm

Titan
 Titanium
 Titanio
 Titane



Ø 1 mm



MF-142T - 150 mm
MF-143T - 180 mm
MF-144T - 210 mm

Ø 2 mm



MF-145T - 150 mm
MF-146T - 180 mm
MF-147T - 210 mm



MF-124/MF-129

MF-142T/MF-147T



Zahnpinzetten
Cotton and Dressing Pliers
Pinzette per medicazione
Pinzas para vendajes
Précèlles pour cotton

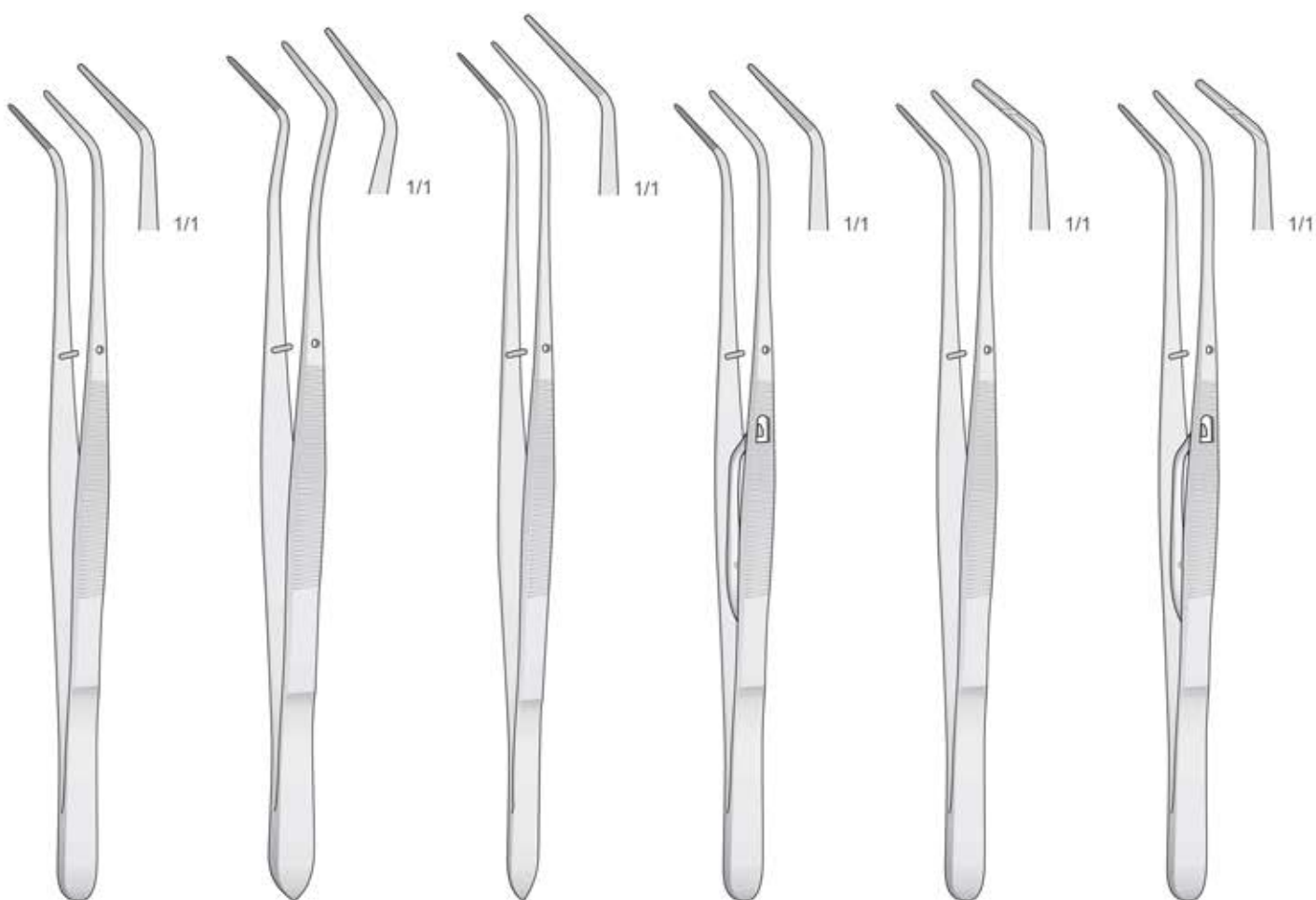

COLLEGE
150 mm

MERIAM
160 mm

FLAGG
160 mm

COLLEGE-S
150 mm

DA-04
150 mm

DA-05
150 mm



Zahnpinzetten
 Cotton and Dressing Pliers
 Pinzette per medicazione
 Pinzas para vendajes
 Précelles pour cotton

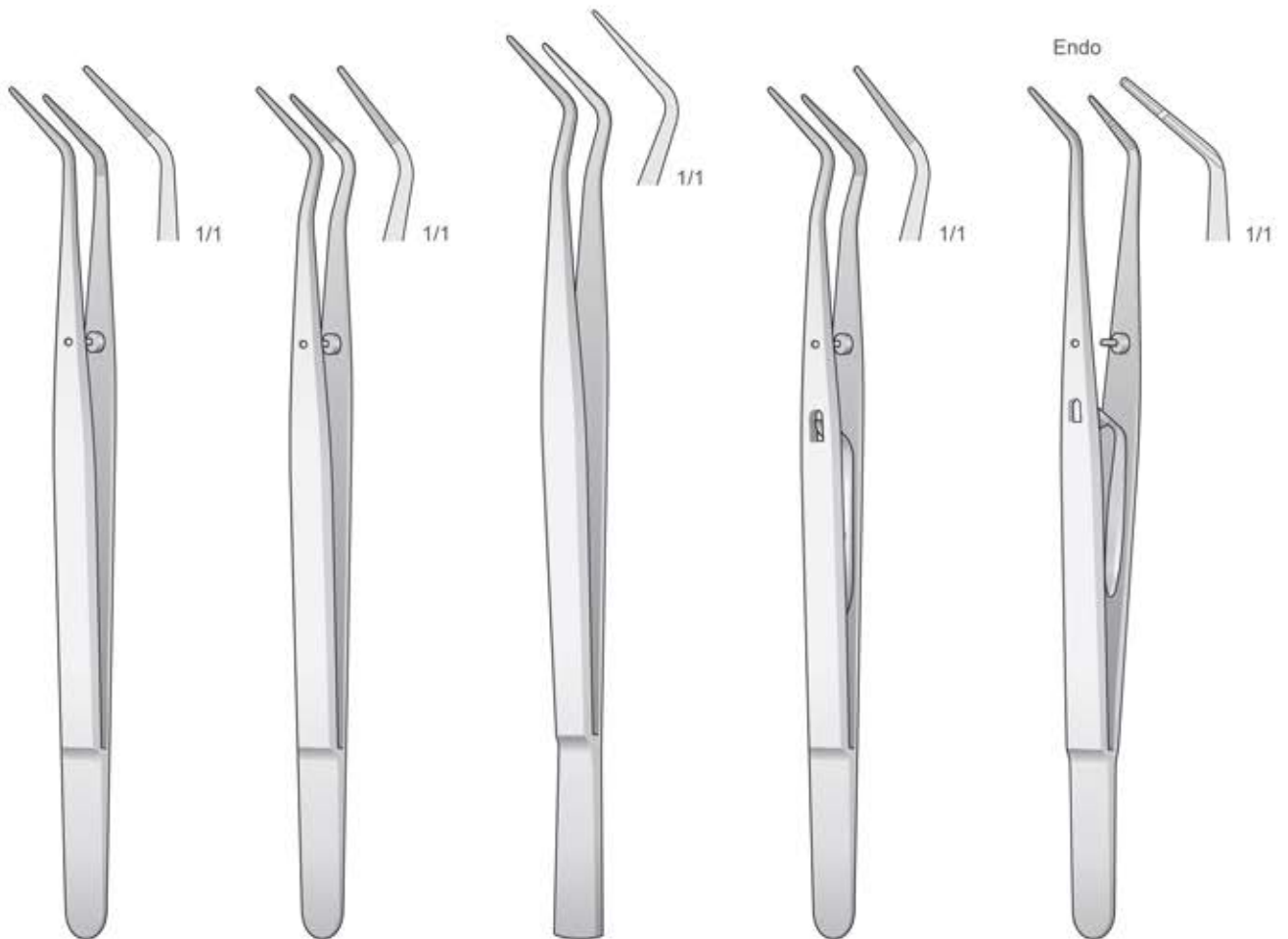

COLLEGE
BD-01 Fig.17
 150 mm

MERIAM
BD-02 Fig.18
 150 mm

CAULK
BD-11
 160 mm

LOCKING
BD-03 Fig.18L
 150 mm

DA-09
 150 mm



Chirurgische und Anatomische Pinzetten
 Tissue and Dressing Forceps
 Pinzette anatomiche e chirurgiche
 Pinzas de diseccion y quirùrgicas
 Pincas anatomiques chirurgicales

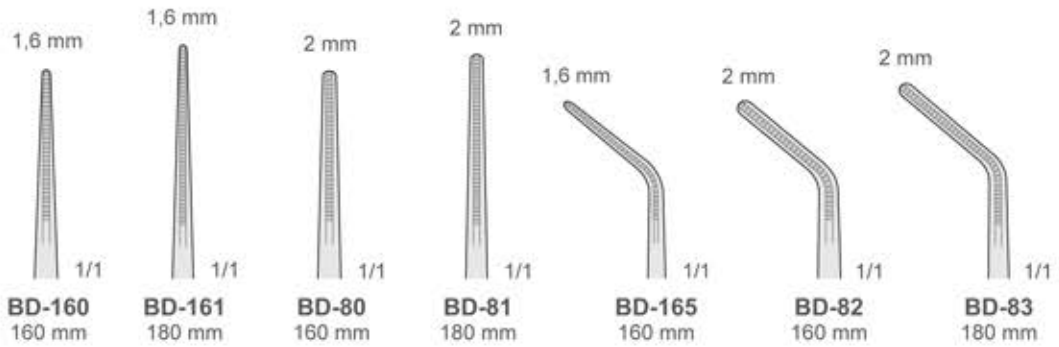

Atraumatische pinzetten
 Non-traumatic forceps
 Pinzette atraumatiche
 Pinzas atraumaticas
 Pincas atraumaticas

DE BAKEY
 BD-80/BD-165

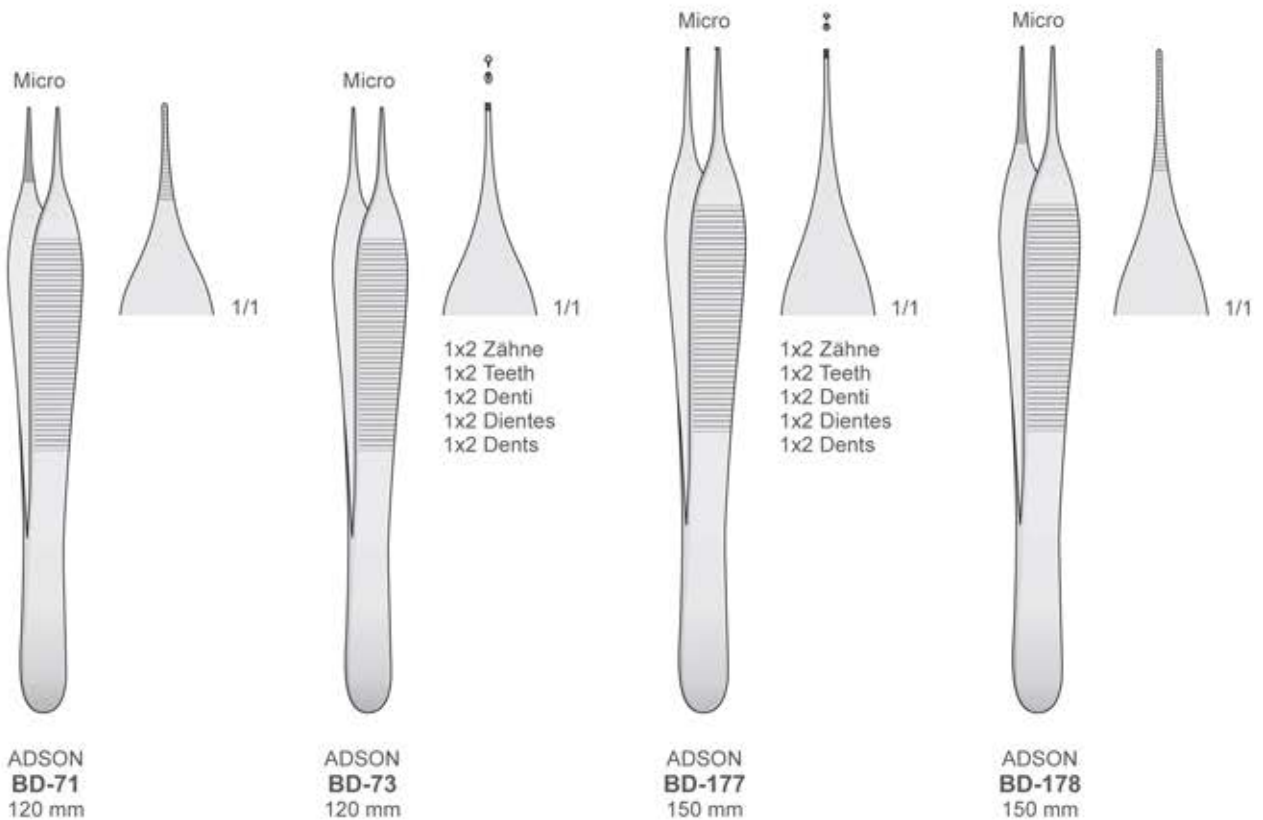



Chirurgische Pinzetten
 Tissue Forceps
 Pinzette chirurgiche
 Pinzas quirúrgicas
 Pincas quirúrgicas

Taschenmarkierungspinzetten
 Pocket markers

Pinzette segnatasche
 Pinzas para marcar el sulco periodontal
 Pincas à marquer la poche

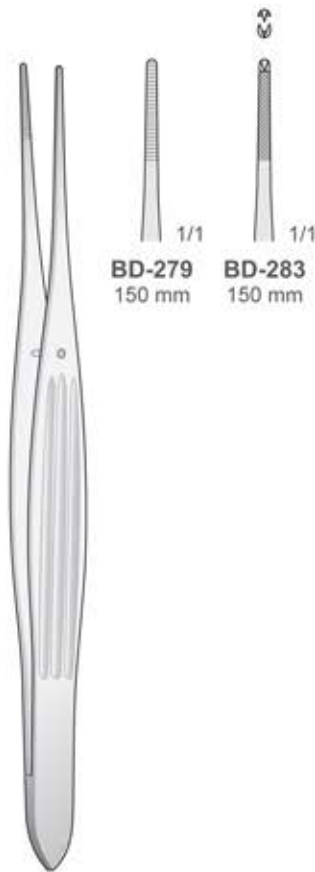

BD-279
150 mm

BD-283
150 mm

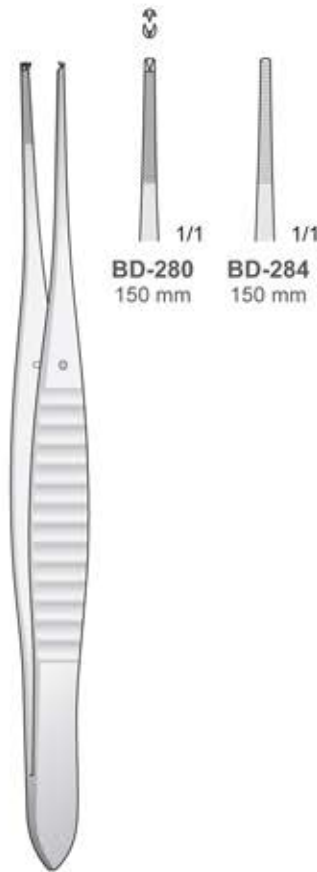

BD-280
150 mm

BD-284
150 mm



CRANE-CAPLAN
DB-01
150 mm



CRANE-CAPLAN
DB-02
150 mm



Chirurgische Pinzetten
Tissue Forceps
Pinzette chirurgiche
Pinzas quirùrgicas
Pinces chirurgicales

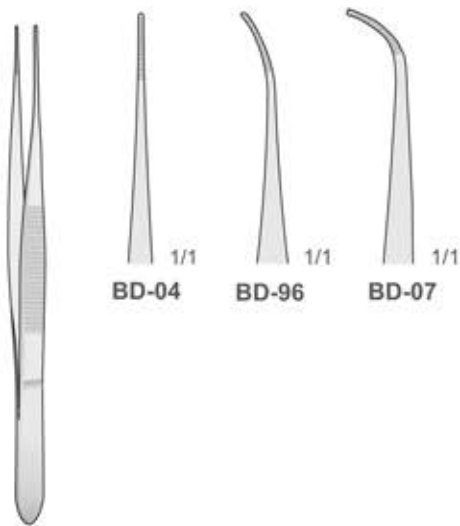

BD-04 1/1
BD-96 1/1
BD-07 1/1

GRAEFE
BD-04/BD-96
100 mm

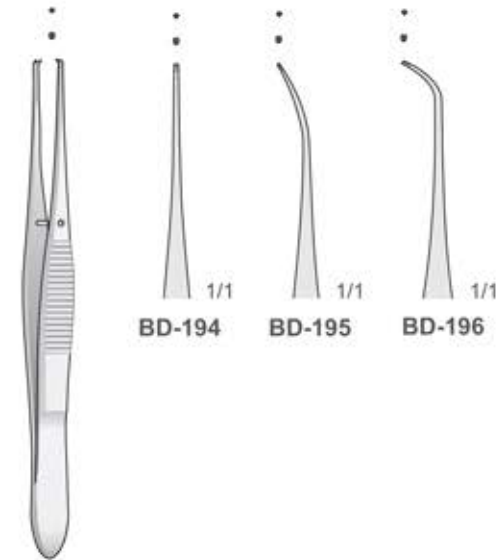

BD-194 1/1
BD-195 1/1
BD-196 1/1

GRAEFE
BD-194/BD-196
100 mm

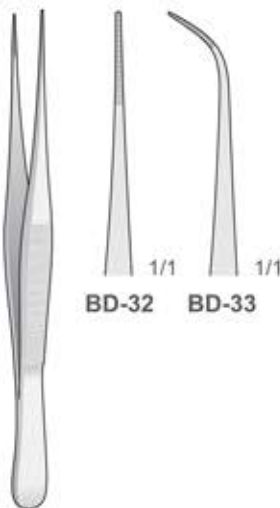

BD-32 1/1
BD-33 1/1

BD-32/BD-33
100 mm

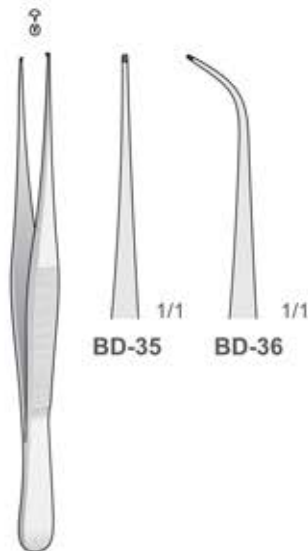

BD-35 1/1
BD-36 1/1

BD-35/BD-36
100 mm

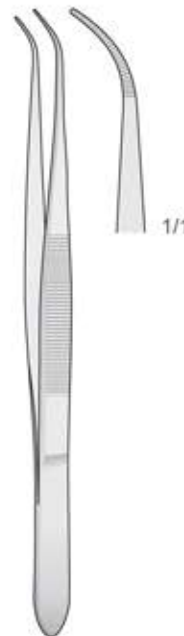

PERRY
BD-05
125 mm

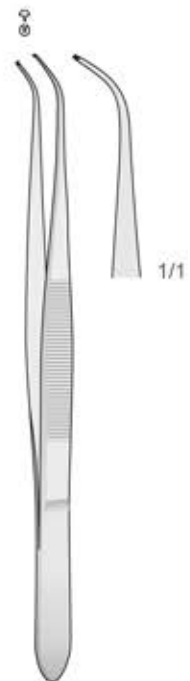

BD-06
125 mm



Anatomische Pinzetten
 Dressing Forceps
 Pinzette anatomiche
 Pinzas de diseccion
 Pincas anatomiques

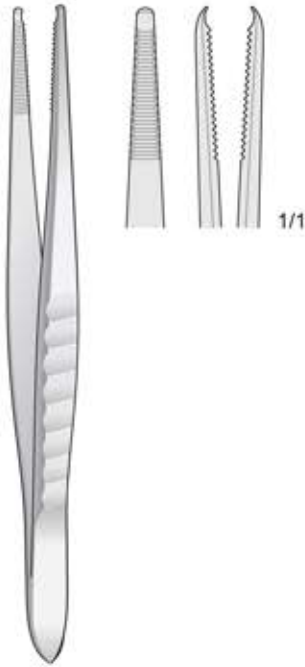

BD-270
130 mm



BD-145
130 mm

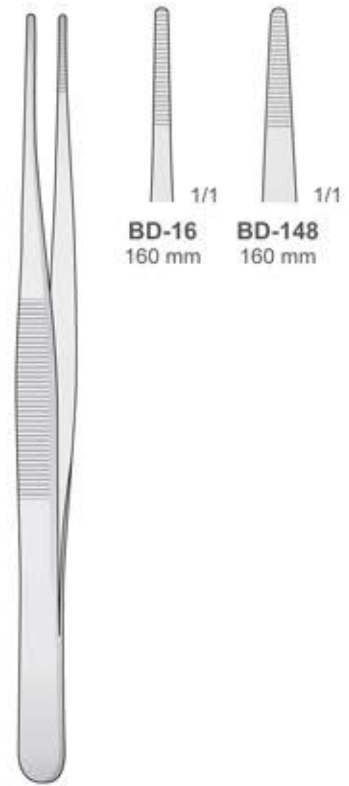

BD-16/BD-148
160 mm

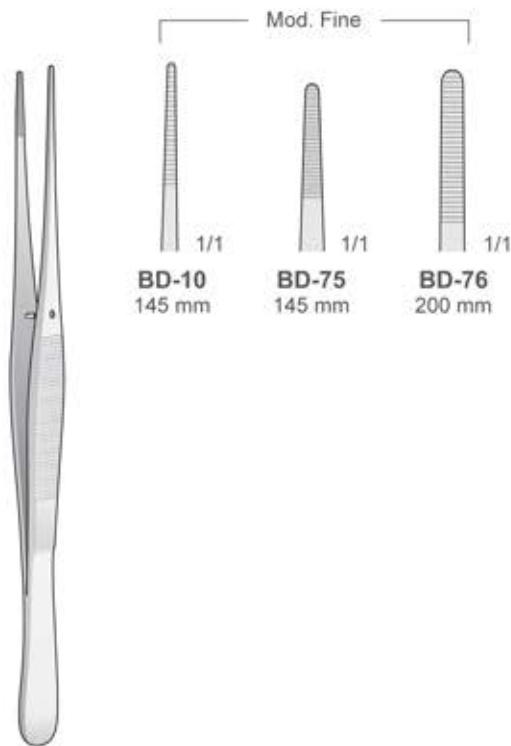

BD-10/BD-76

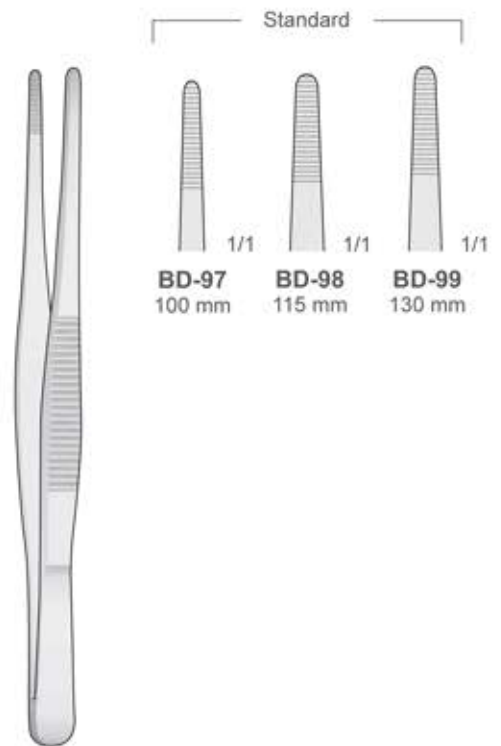

BD-97/BD-99



Chirurgische Pinzetten
Tissue Forceps
Pinzette chirurgiche
Pinzas quirùrgicas
Pincas quirurgicales

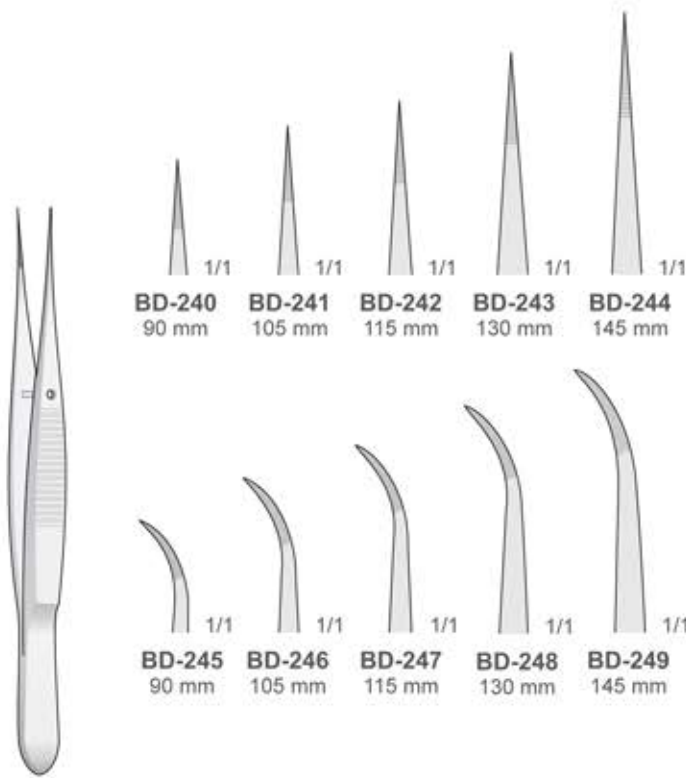

BD-240/BD-249

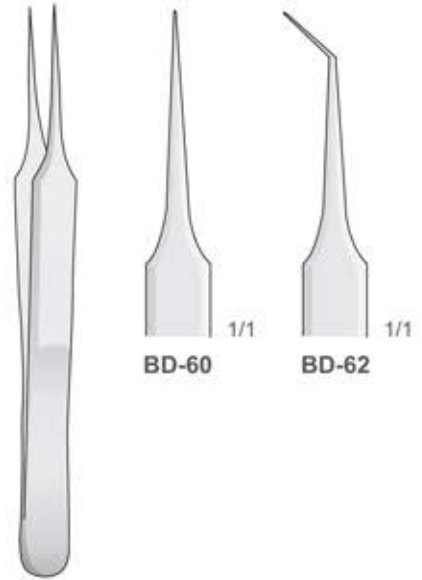

BD-60/BD-62
110 mm

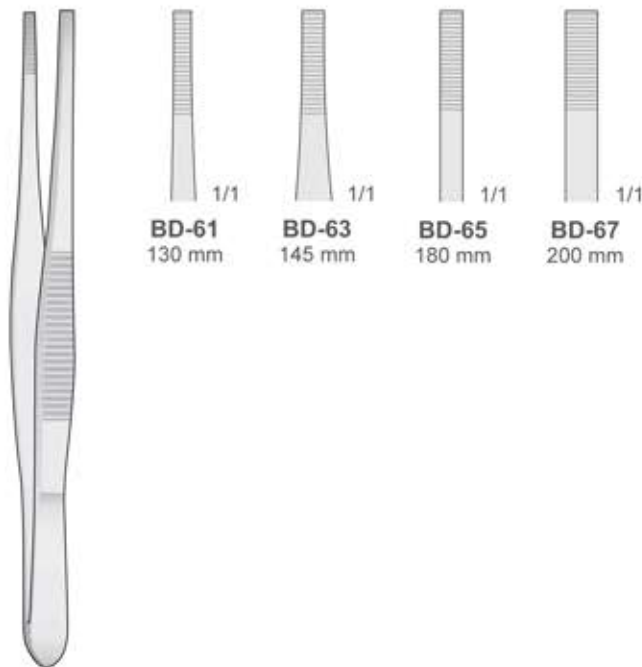

STILLE
BD-61/BD-67

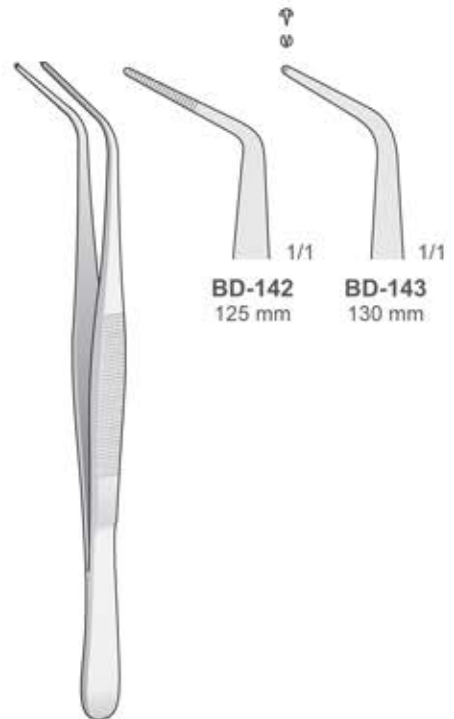

BD-142/BD-143



Chirurgische Pinzetten
 Tissue Forceps
 Pinzette chirurgische
 Pinzas quirúrgicas
 Pincas quirúrgicas

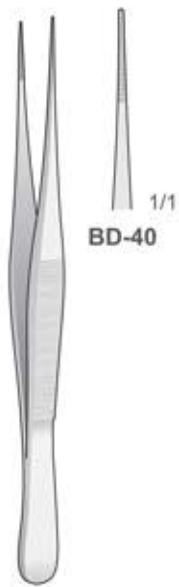

BD-40
110 mm

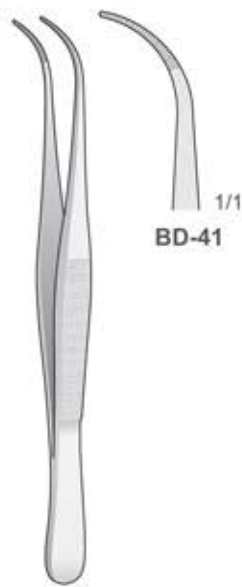

BD-41
110 mm

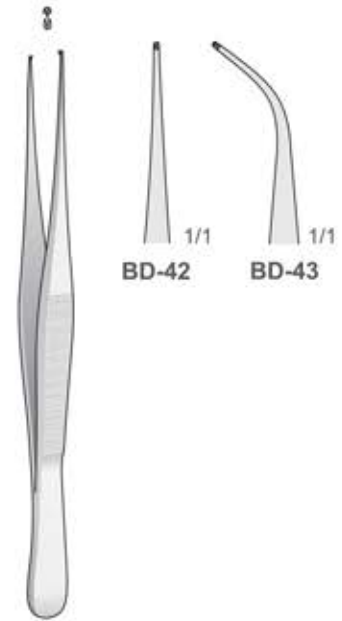

BD-42/BD-43
110 mm

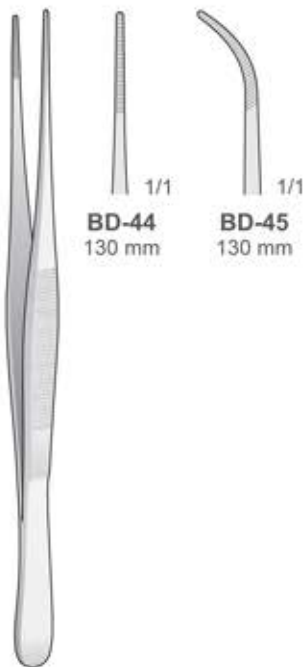

SEMKEN
BD-44/BD-45
130 mm

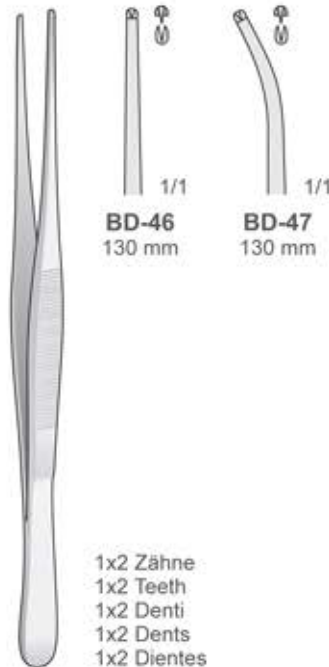

SEMKEN
BD-46/BD-47
130 mm

1x2 Zähne
 1x2 Teeth
 1x2 Denti
 1x2 Dents
 1x2 Dientes

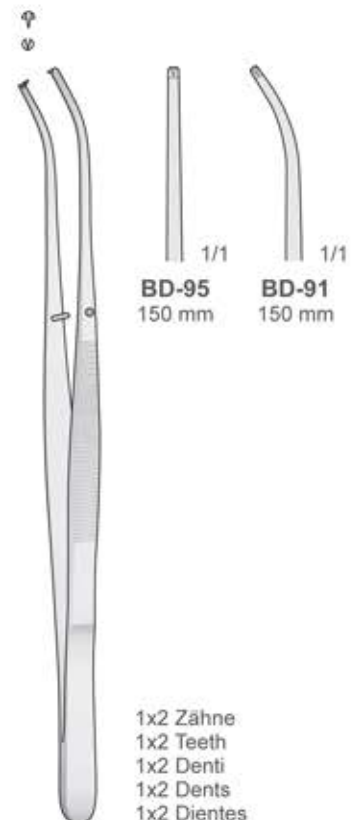

SEMKEN
BD-91/BD-95
150 mm

1x2 Zähne
 1x2 Teeth
 1x2 Denti
 1x2 Dents
 1x2 Dientes



Chirurgische Pinzetten
Tissue Forceps
Pinzette chirurgiche
Pinzas chirùrgicas
Pincas chirurgicales

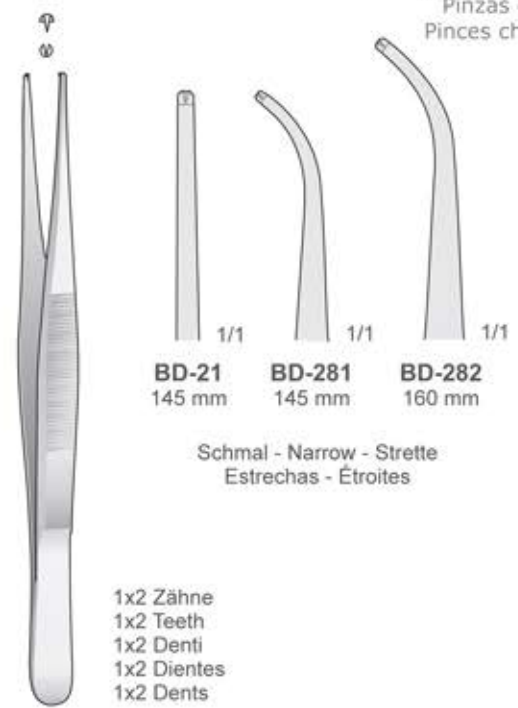
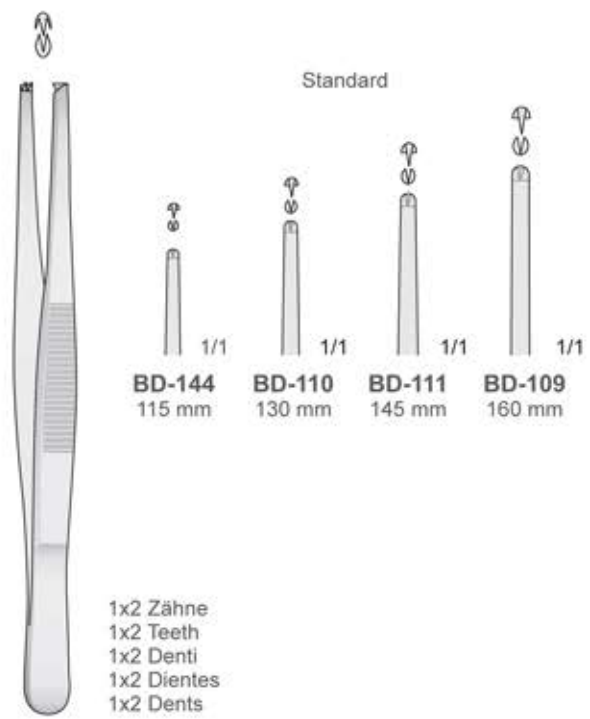

BD-109/BD-144

BD-21/BD-282

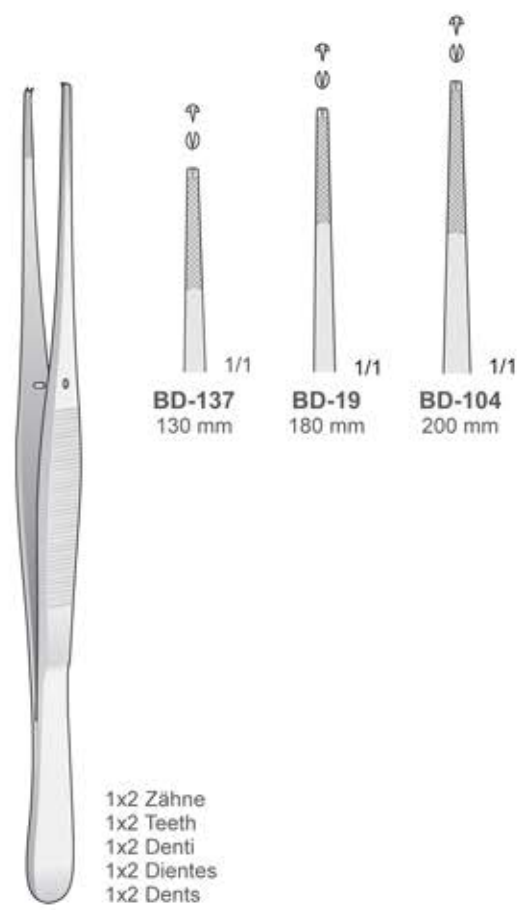
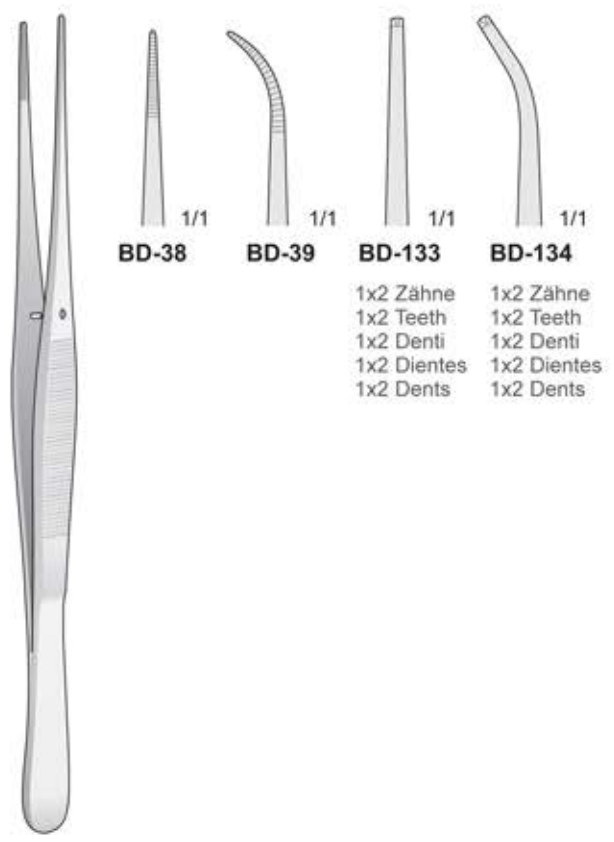

BD-38/BD-134
200 mm

BD-19/BD-137



Chirurgische Pinzetten
 Tissue Forceps
 Pinzette chirurgiche
 Pinzas quirúrgicas
 Pincas quirurgicales



**GERALD
 MF-101**
 180 mm



**GERALD
 MF-102**
 180 mm

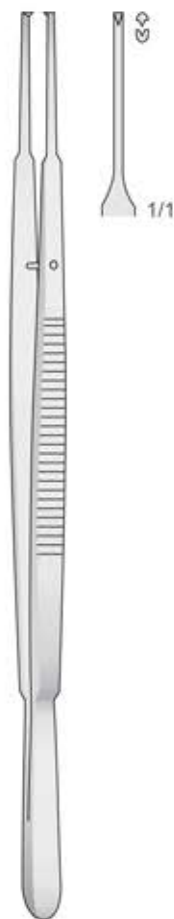

**GERALD
 MF-103**
 180 mm



**GERALD
 MF-104**
 180 mm

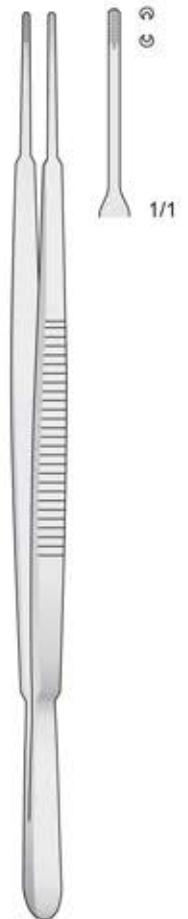

**GERALD-BROWN
 MF-105**
 180 mm

Chirurgische Pinzetten
Tissue Forceps
Pinzette chirurgiche
Pinzas quirùrgicas
Pincas quirurgicales

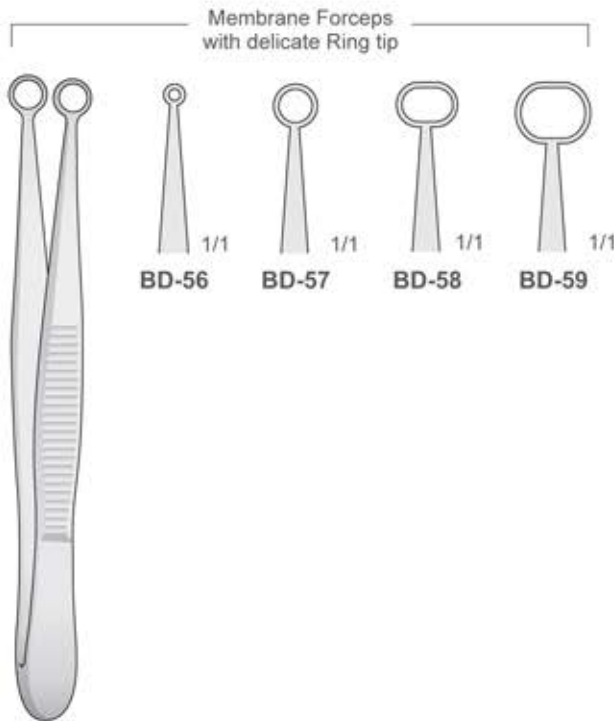

BD-56/BD-59
100 mm



DESMARRES
BD-130/BD-131
90 mm

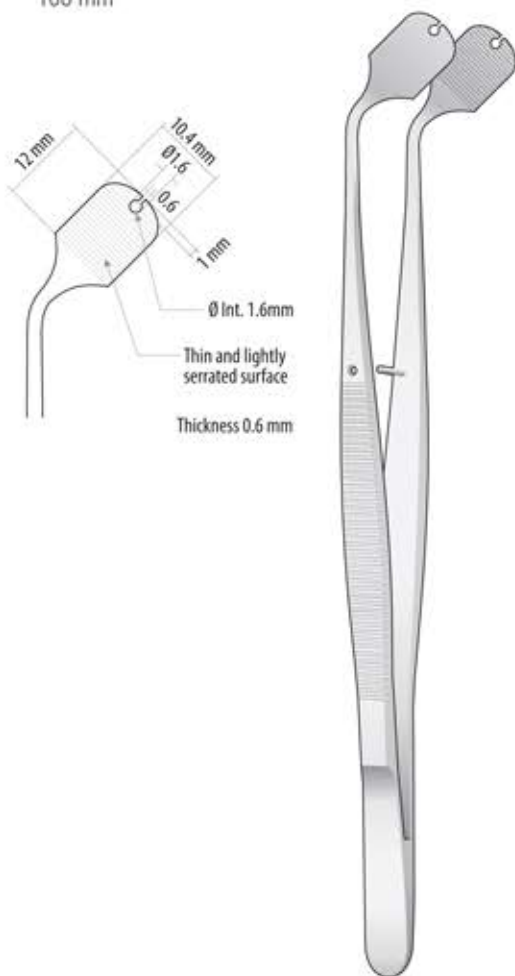
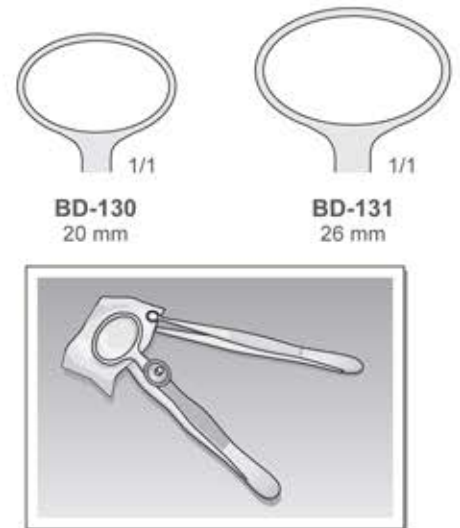

TASO-9
150 mm

Pinzetten zum Halten Membranen
Membrane Holding forceps
Pinza per fissaggio membrane
Pinza para sostener membranas
Pince pour le maintien membranes



KÜHNE
ES-44
105 mm

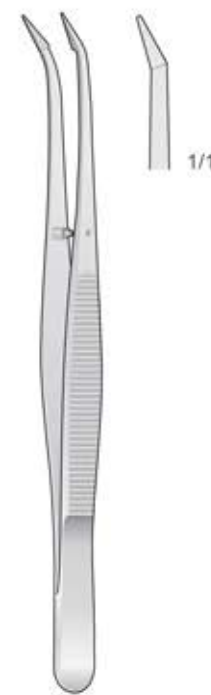

BARRAQUER
ES-65
105 mm



Chirurgische Pinzetten
 Tissue Forceps
 Pinzette chirurgische
 Pinzas quirúrgicas
 Pincas quirúrgicas

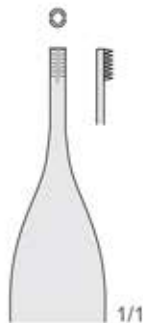

BD-92
120 mm

6x6 Zähne
 6x6 Teeth
 6x6 Denti
 6x6 Dientes
 6x6 Dents



BD-141
120 mm

9x9 Zähne
 9x9 Teeth
 9x9 Denti
 9x9 Dientes
 9x9 Dents

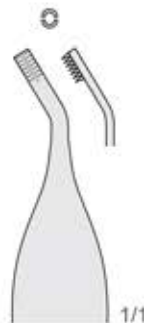

BD-93
120 mm

6x6 Zähne
 6x6 Teeth
 6x6 Denti
 6x6 Dientes
 6x6 Dents



BD-90
120 mm

**ADSON
BD-90**
120 mm

**ADSON-BROWN
BD-92/BD-141**
120 mm



8x8 Zähne
 8x8 Teeth
 8x8 Denti
 8x8 Dientes
 8x8 Dents

**BROWN
BD-94**
150 mm

Standard



**ADSON
BD-380**
150 mm

Standard

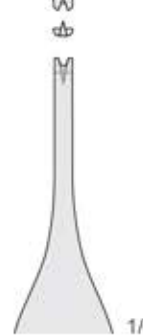

1x2 Zähne
 1x2 Teeth
 1x2 Denti
 1x2 Dientes
 1x2 Dents

**ADSON
BD-381**
150 mm



9x9 Zähne
 9x9 Teeth
 9x9 Denti
 9x9 Dientes
 9x9 Dents

**ADSON-BROWN
BD-382**
150 mm

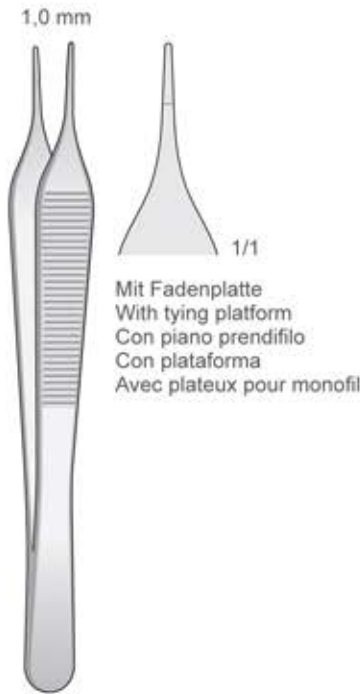

ADSON
BD-370
120 mm

Mit Fadenplatte
With tying platform
Con piano prendifilo
Con plataforma
Avec plateaux pour monofil

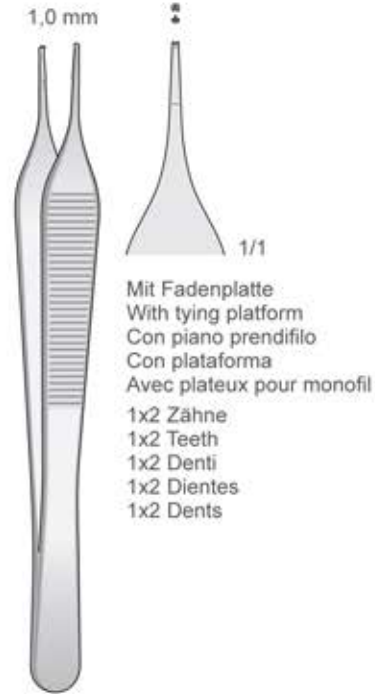

ADSON
BD-371
120 mm

Mit Fadenplatte
With tying platform
Con piano prendifilo
Con plataforma
Avec plateaux pour monofil
1x2 Zähne
1x2 Teeth
1x2 Denti
1x2 Dientes
1x2 Dents

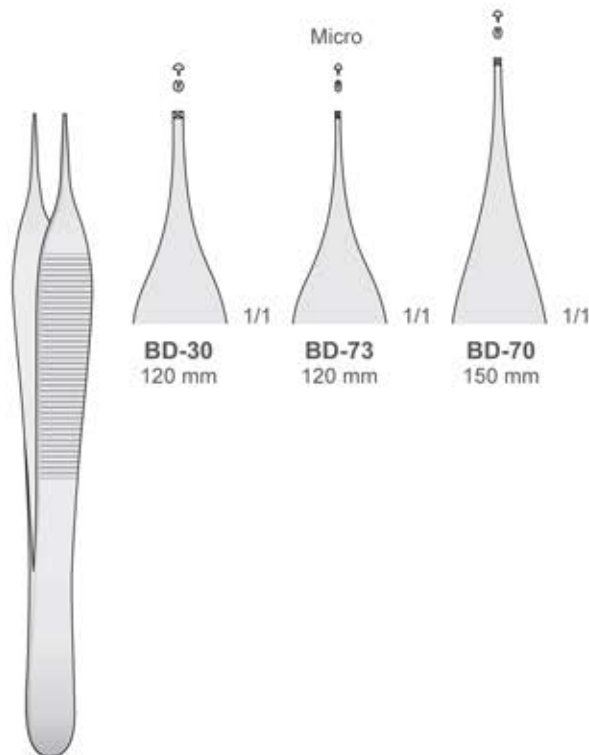

ADSON
BD-30/BD-73

BD-30
120 mm

BD-73
120 mm

BD-70
150 mm

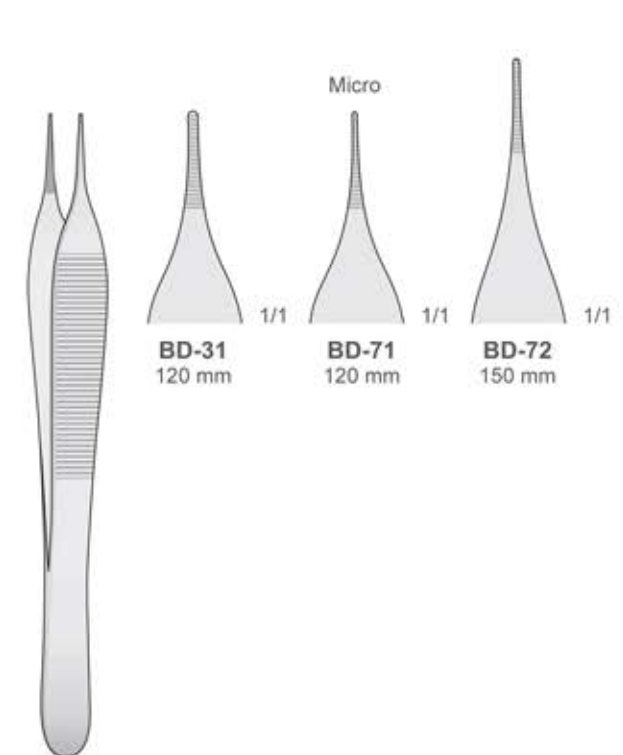

ADSON
BD-31/BD-72

BD-31
120 mm

BD-71
120 mm

BD-72
150 mm



Chirurgische Pinzetten - Anatomische Pinzetten
 Tissue Forceps - Dressing forceps
 Pinzette chirurgiche - Pinzette anatomiche
 Pinzas quirùrgicas - Pinzas de diseccion
 Pincas chirurgicales - Pincas anatomiques



Extra fein
 Extra fine
 Extra fine
 Extra finas
 Extra fins

Gebogen
 Curved
 Curva
 Curvas
 Courbé

**MICRO-ADSON
 BD-372**
 120 mm



Extra fein
 Extra fine
 Extra fine
 Extra finas
 Extra fins

Gebogen
 Curved
 Curva
 Curvas
 Courbé

1x2 Zähne
 1x2 Teeth
 1x2 Denti
 1x2 Dientes
 1x2 Dents

**MICRO-ADSON
 BD-373**
 120 mm



2x3 Zähne
 2x3 Teeth
 2x3 Denti
 2x3 Dientes
 2x3 Dents

**ADSON
 BD-377**
 120 mm



**BEASLEY-BABCOCK
 BD-51**
 120 mm



**GRAEFE
 BD-135**
 110 mm

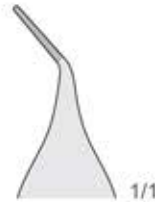

Gerieft
 Serrated
 Zigrinata
 Estriada
 Striée

Abgewinkelt
 Angled
 Angolata
 Angulada
 Coudée en haut

**ADSON
 BD-378**
 120 mm



1x2 Zähne
 1x2 Teeth
 1x2 Denti
 1x2 Dientes
 1x2 Dents

Abgewinkelt
 Angled
 Angolata
 Angulada
 Coudée en haut

**ADSON
 BD-379**
 120 mm



Chirurgische Pinzetten - Anatomische Pinzetten
 Tissue Forceps - Dressing forceps
 Pinzette chirurgische - Pinzette anatomiche
 Pinzas quirúrgicas - Pinzas de diseccion
 Pincés chirurgicales - Pincés anatomiques

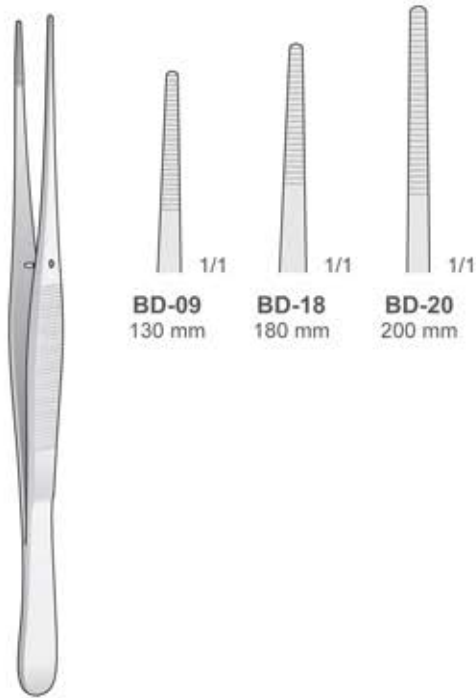

BD-09 130 mm
BD-18 180 mm
BD-20 200 mm

BD-09/BD-20

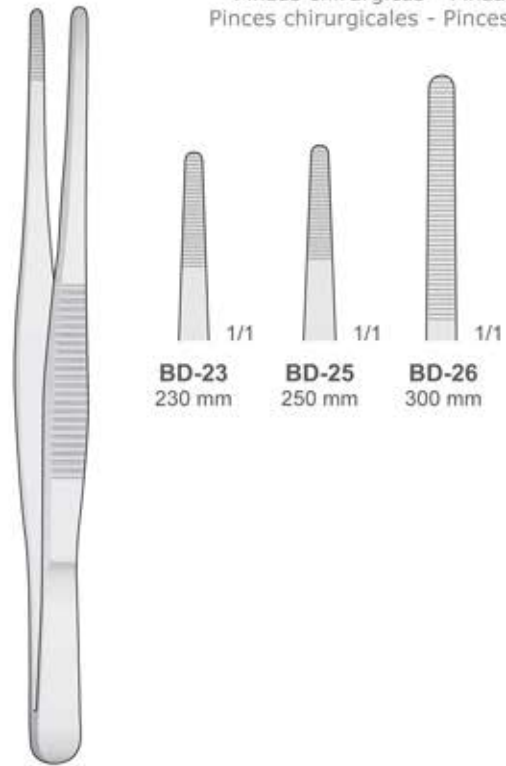

BD-23 230 mm
BD-25 250 mm
BD-26 300 mm

BD-23/BD-26



1x2 Zähne
 1x2 Teeth
 1x2 Denti
 1x2 Dientes
 1x2 Dents

BD-271/BD-276

Schmal - Narrow
 Strette - Estrechas
 Étroites

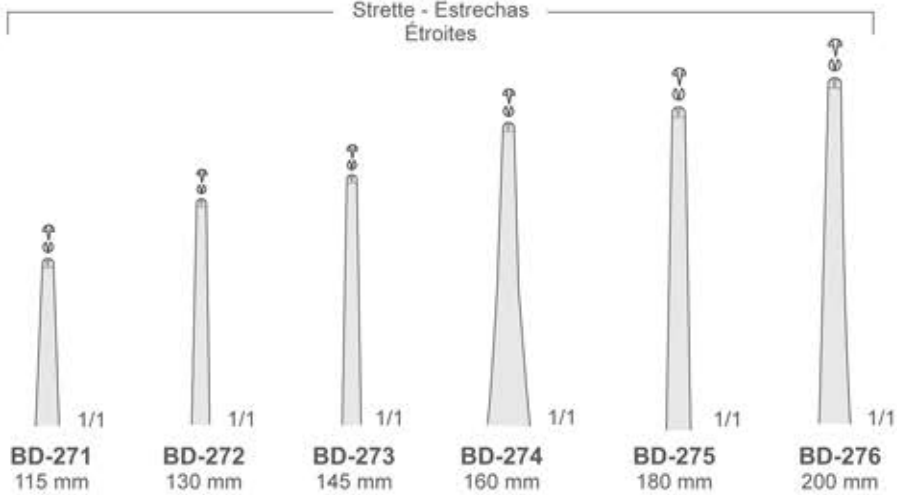

BD-271 115 mm
BD-272 130 mm
BD-273 145 mm
BD-274 160 mm
BD-275 180 mm
BD-276 200 mm



Chirurgische Pinzetten
 Tissue Forceps
 Pinzette chirurgiche
 Pinzas quirúrgicas
 Pincas quirurgicales

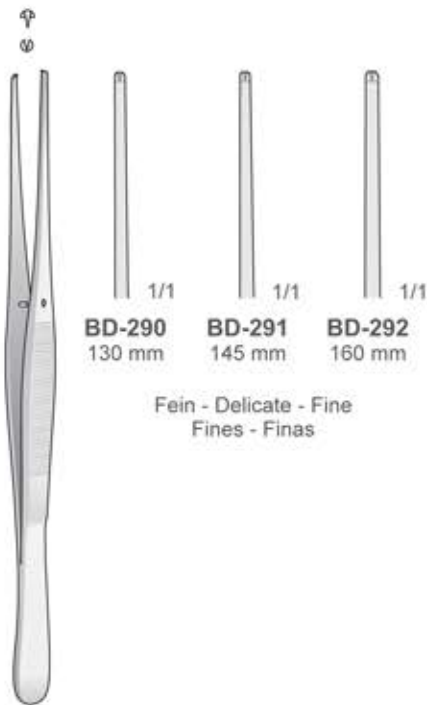

Fein - Delicate - Fine
 Fines - Finas

BD-290/BD-292

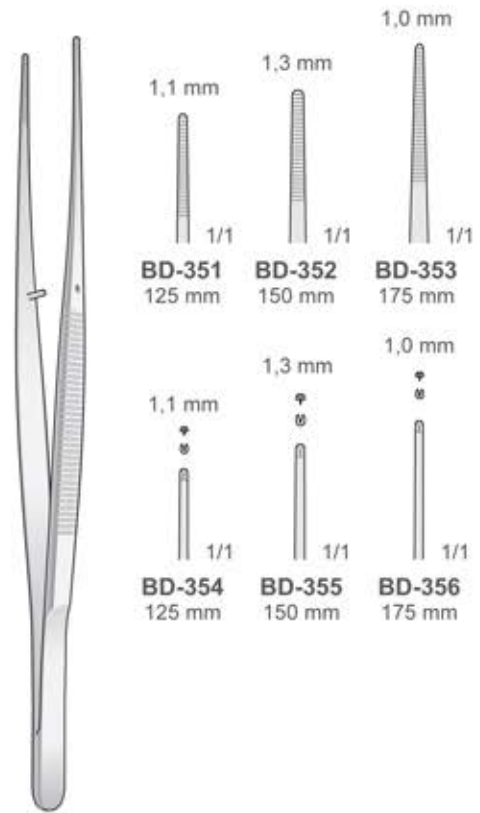

BD-351/BD-356

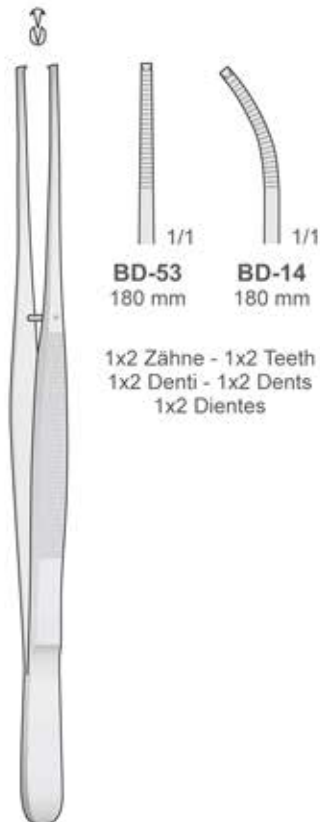

1x2 Zähne - 1x2 Teeth
 1x2 Denti - 1x2 Dents
 1x2 Dientes

POTTS-SMITH
BD-14/BD-53
 180 mm

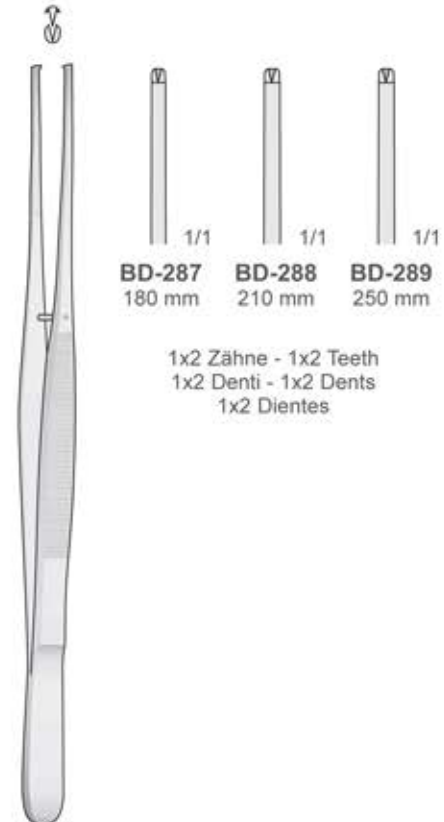

1x2 Zähne - 1x2 Teeth
 1x2 Denti - 1x2 Dents
 1x2 Dientes

POTTS-SMITH
BD-287/BD-289



Chirurgische Pinzetten, Atraumatische Pinzetten
 Tissue Forceps, Non-traumatic Forceps
 Pinzette chirurgiche, Pinzette atraumatiche
 Pinzas quirurgicas, Pinzas atraumaticas
 Pincas chirurgicales, Pincas atraumaticas

TC



GERALD
MF-106/MF-107
 175 mm

TC
TUNGSTEN
CARBIDE

Tungsten-Carbide Inserts
 Mit Hartmetalleinsätzen
 Plaquettes en carbure de tungstène
 Plaquetas de carburo de tungsteno
 Inserti in carburo di tungsteno

TC



WANGENSTEEN
BD-232
 150 mm

TC

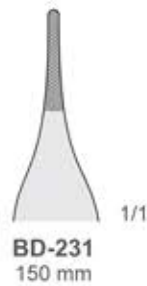
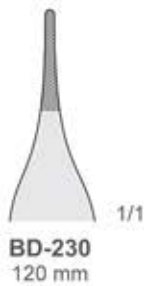

ADSON
BD-230/BD-231

TC

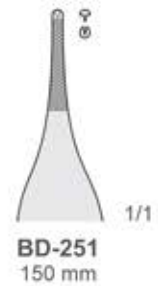
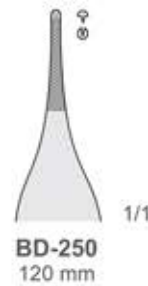

1x2 Zähne
 1x2 Teeth
 1x2 Denti
 1x2 Dientes
 1x2 Griffes

1x2 Zähne
 1x2 Teeth
 1x2 Denti
 1x2 Dientes
 1x2 Griffes

ADSON
BD-250/BD-251



Chirurgische Pinzetten, Atraumatische Pinzetten
 Tissue Forceps, Non-traumatic Forceps
 Pinzette chirurgiche, Pinzette atraumatiche
 Pinzas quirúrgicas, Pinzas atraumáticas
 Pincès chirurgicaes, Pincès atraumatiques



BD-210/BD-213

Standard

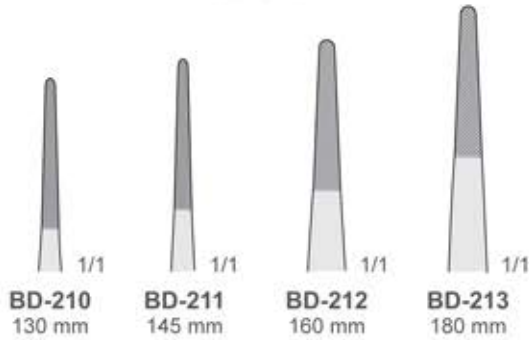

TC

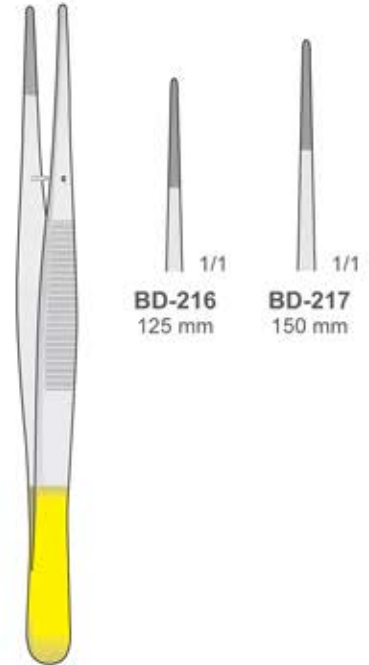

SEMKEN
BD-216/BD-217

Tungsten-Carbide Inserts
 Mit Hartmetalleinsätzen
 Plaquettes en carbure de tungstène
 Plaquetas de carburo de tungsteno
 Inserti in carburo di tungsteno

TC



BD-221/BD-224

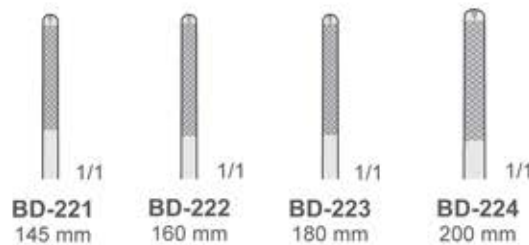

TC

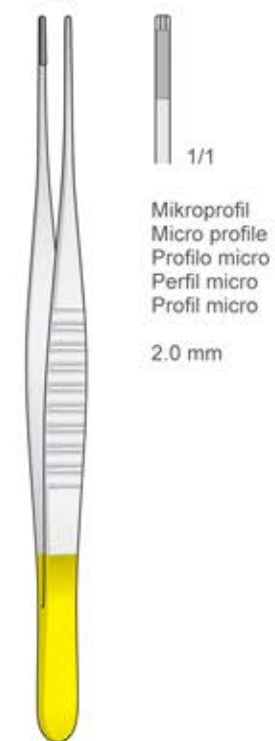

DE BAKEY
BD-267
 160 mm

Pinzetten
Forceps
Pinzette
Pinzas
Pincas

Naht- und Membranpinzette - Suture and membrane Forceps
Pinzette per suture e membrane - Pinzas para suturas y membranas
Pincettes à suture et à membrane



Ø Int 1.6 mm
1/1
BD-158
Ø Int 2.2 mm
1/1
BD-159

BD-158/BD-159
160 mm



CORN DA-07
150 mm

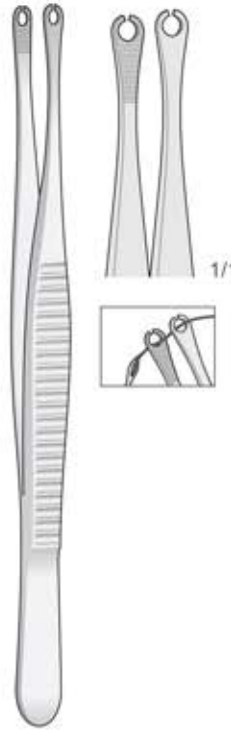

DA-06
150 mm

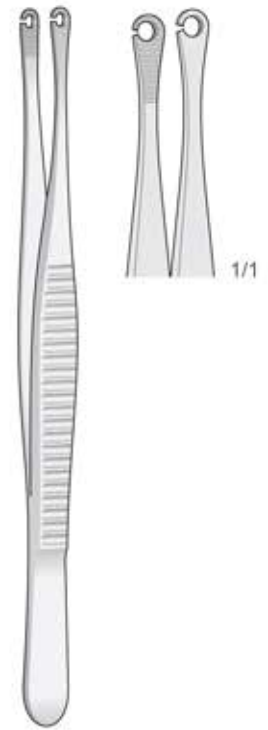

DA-08
150 mm

Artikulationspapier-Pinzetten - Articulating Paper Forceps
Pinza per carta articolazione - Pinzas para papel de articular
Pince pour papier à articuler



RUSSIAN BD-27/BD-175

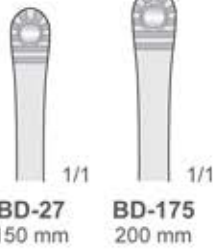

BD-27 150 mm
BD-175 200 mm



MILLER DR-78
145 mm

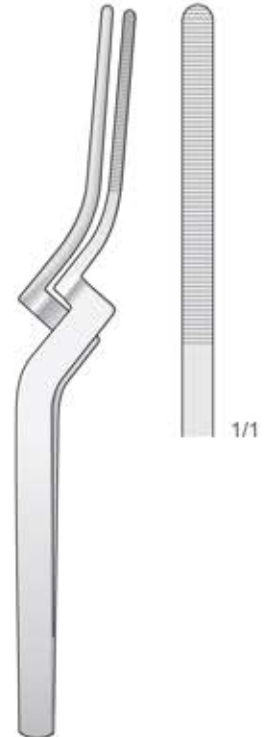

MILLER DR-80
160 mm

F |

Needle Holders

Nadelhalter

Porte-aiguilles

Porta-agujas

Port'aghi



Nadelhalter
 Needle Holders
 Port'aghi
 Portaagujas
 Porte aiguilles

Mit Scheren
 With Scissor
 Con forbice
 Con tijeras
 Avec ciseaux

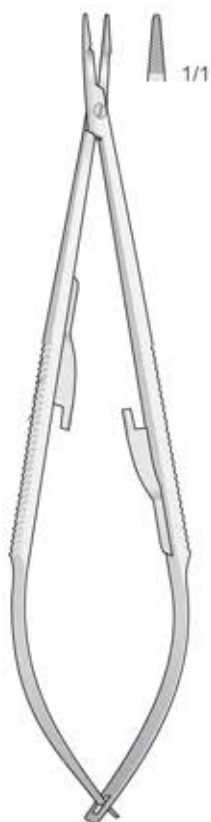

FD-26
 140 mm

Glattes Maul
 Smooth Jaw
 Morso liscio
 Mandibula lisa
 Mors lisse



FD-14/FD-16
 140 mm

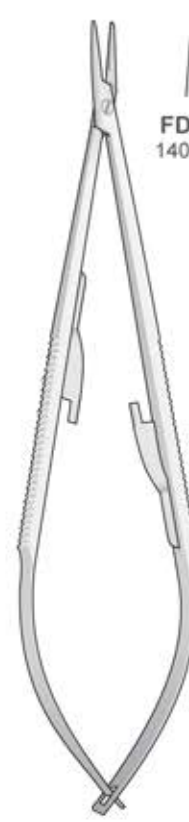

CASTROVIEJO
FD-17/FD-19
 140 mm

Mit Locking-System
With Locking System (stop)
Con sistema di bloccaggio
Con sistema de bloqueo
Avec système de verrouillage

Glattes Maul
Smooth Jaw
Morso liscio
Mandibula lisa
Mors lisse

Feingerieftes Maul
Fine serrated jaws
Morso zigrinato fine
Mandibula estriada fina
Mors strié fin



BARRAQUER
FD-216
150 mm



BARRAQUER
FD-217
150 mm



BARRAQUER
FD-236/FD-237
150 mm



FD-237
150 mm

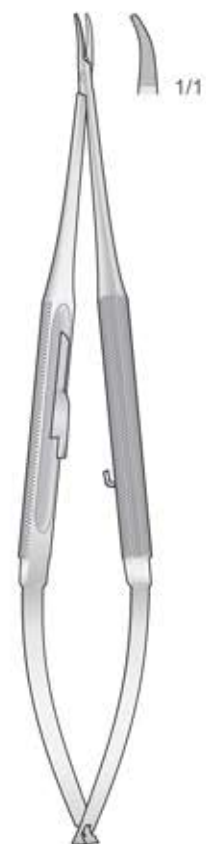

BARRAQUER
FD-24
150 mm

Nadelhalter
 Needle Holders
 Port'aghi
 Portaagujas
 Porte aiguilles



Tungsten-Carbide Inserts
 Mit Hartmetalleinsätzen
 Plaquettes en carbure de tungstène
 Plaquetas de carburo de tungsteno
 Inserti in carburo di tungsteno

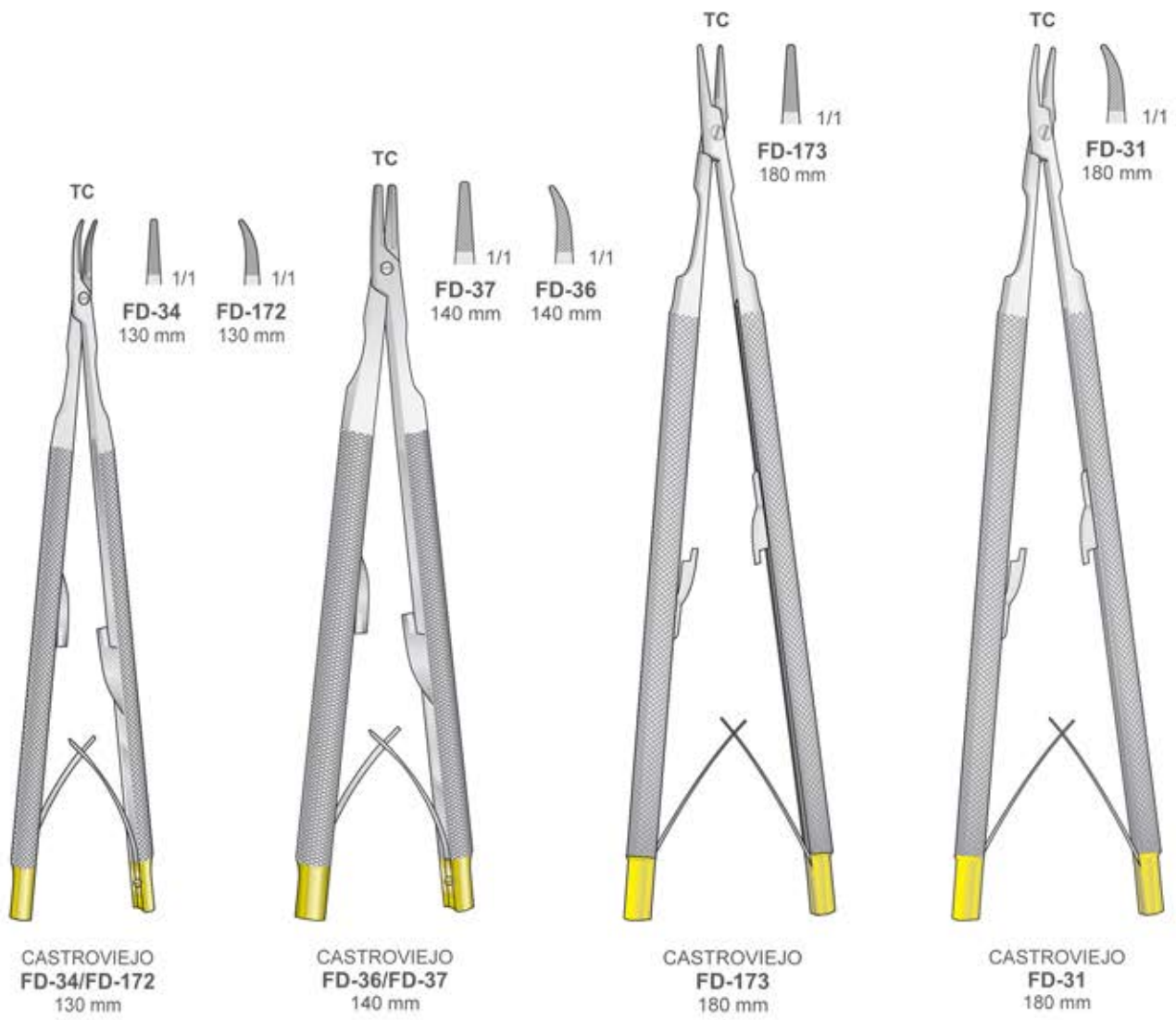



Tungsten-Carbide Inserts
Mit Hartmetalleinsätzen
Plaquettes en carbure de tungstène
Plaquetas de carburo de tungsteno
Inseriti in carburo di tungsteno

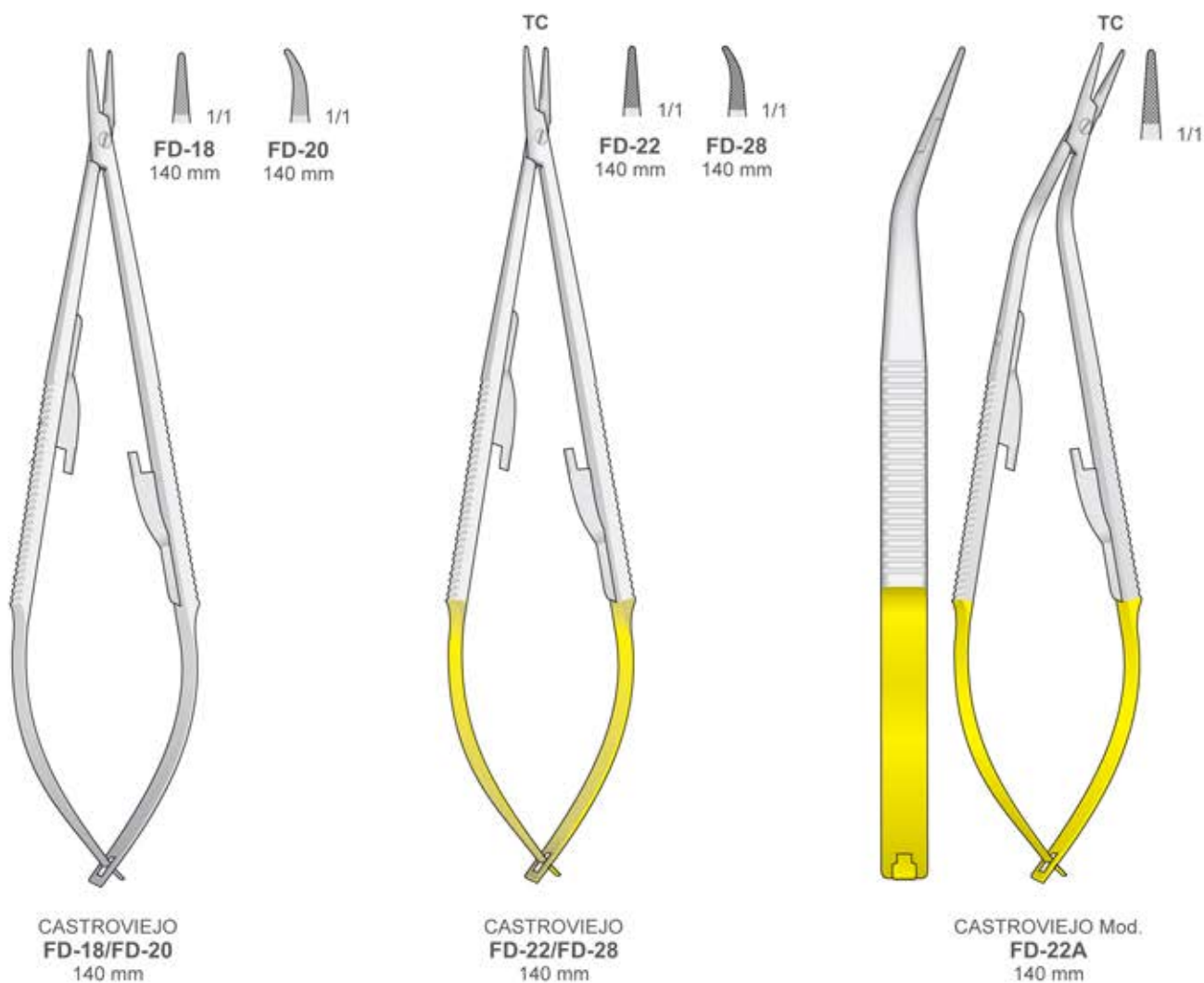



Nadelhalter
 Needle Holders
 Port'aghi
 Portaagujas
 Porte aiguilles



Tungsten-Carbide Inserts
 Mit Hartmetalleinsätzen
 Plaquettes en carbure de tungstène
 Plaquetas de carburo de tungsteno
 Inserti in carburo di tungsteno



JACOBSON
FD-170/FD-171
 150 mm



JACOBSON
FD-30/FD-32
 180 mm

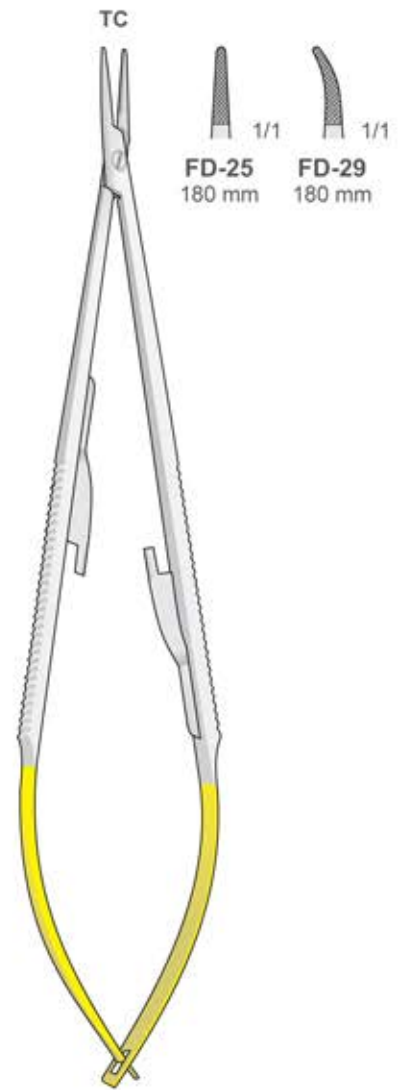

CASTROVIEJO
FD-25/FD-29
 180 mm

TC
TUNGSTEN
CARBIDE

Tungsten-Carbide Inserts
Mit Hartmetalleinsätzen
Plaquettes en carbure de tungstène
Plaquetas de carburo de tungsteno
Inserti in carburo di tungsteno

Glattes Maul
Smooth jaws
Con morso liscio
Mandibula lisa
A' mors lisse

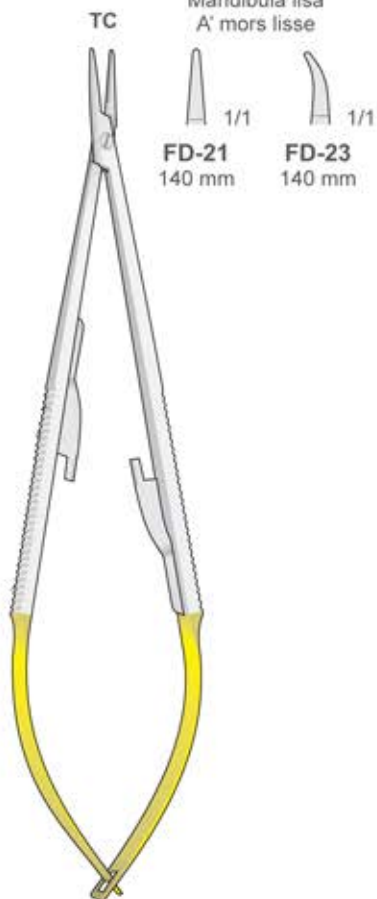

CASTROVIEJO
FD-21/FD-23
140 mm



Diamond Tip
Diamantiert
Punta diamantata
Punta de diamante
Pointe de diamant



FD-599/FD-600
150 mm



FD-601/FD-602
180 mm

Mikro Nadelhalter - Mikro Scheren
 Micro Needle Holders - Micro Scissors
 Micro Port'aghi - Micro Forbici
 Micro Portaagujas - Micro Tijeras
 Micro Porte aiguilles - Micro Ciseaux



Rund-Griffe Ø 8 mm
 Round handle Ø 8 mm
 Manico rotondo Ø 8 mm
 Mango redondo Ø 8 mm
 Manche rond Ø 8 mm

Mikro Nadelhalter
 Micro Needle Holders
 Micro port'aghi
 Micro portaagujas
 Micro porte aiguilles

Mikro Scheren
 Micro Scissors
 Micro forbici
 Micro tijeras
 Micro ciseaux

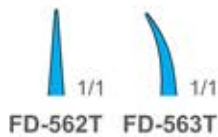

FD-562T/FD-563T
 180 mm

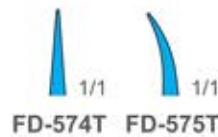
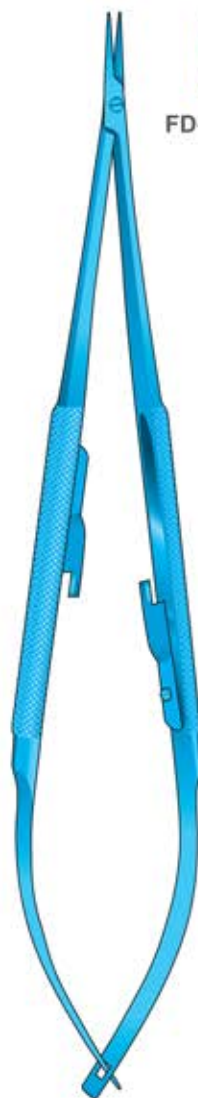

Mit Sperre
 With Lock
 Con arresto
 Con cierre
 Avec Arrêt

FD-574T/FD-575T
 180 mm

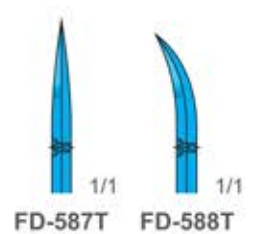

FD-587T/FD-588T
 180 mm



Tungsten-Carbide Inserts
Mit Hartmetalleinsätzen
Plaquettes en carbure de tungstène
Plaquetas de carburo de tungsteno
Inserti in carburo di tungsteno

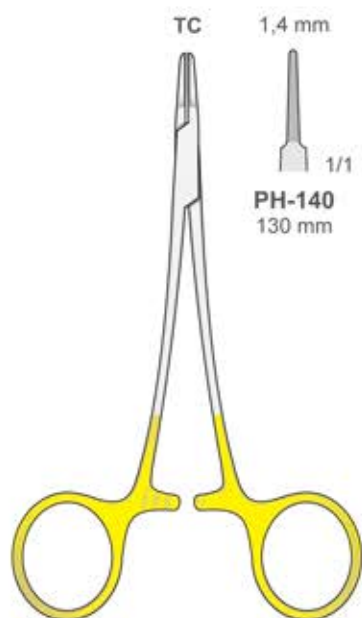

MICRO-RYDER
PH-140/PH-142

TC 1,4 mm 1,4 mm 1,4 mm
1/1 1/1 1/1
PH-140 130 mm PH-141 150 mm PH-142 180 mm

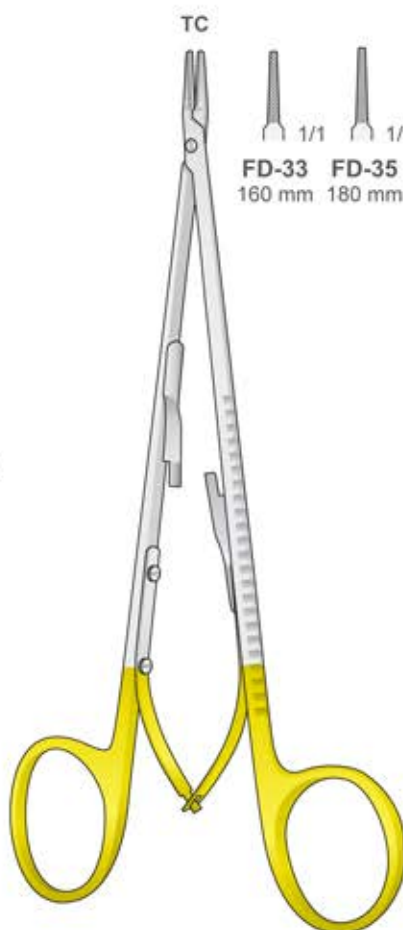

DIETRICH
FD-33/FD-35

TC
1/1 1/1
FD-33 160 mm FD-35 180 mm



STEVENS
FD-38
160 mm

Nadelhalter
 Needle Holders
 Port'aghi
 Portaagujas
 Porte aiguilles

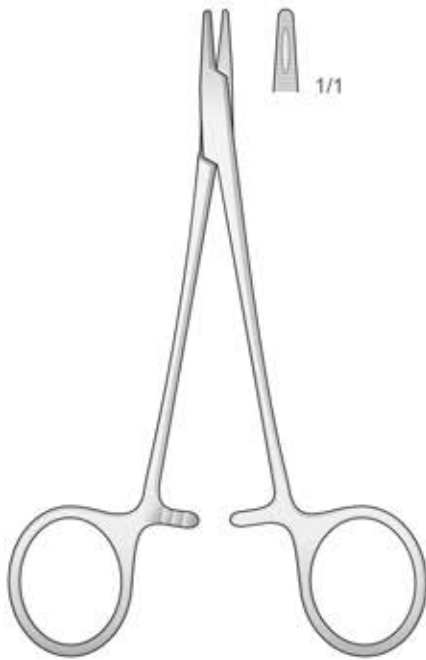

DERF
PH-39
 125 mm

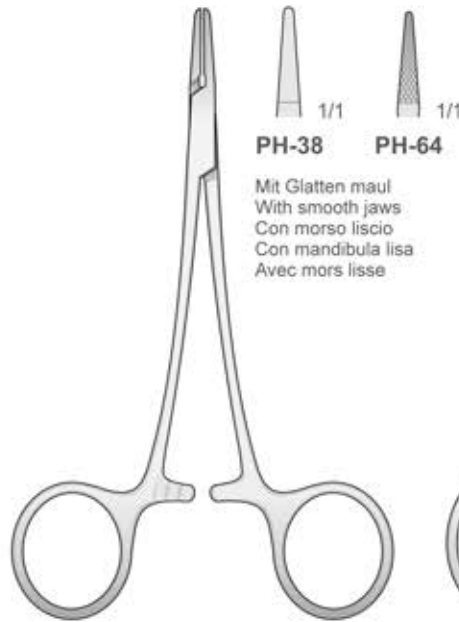

PH-38 **PH-64**
 Mit Glatten mau
 With smooth jaws
 Con morso liscio
 Con mandibula lisa
 Avec mors lisse

PH-38/PH-64
 120 mm

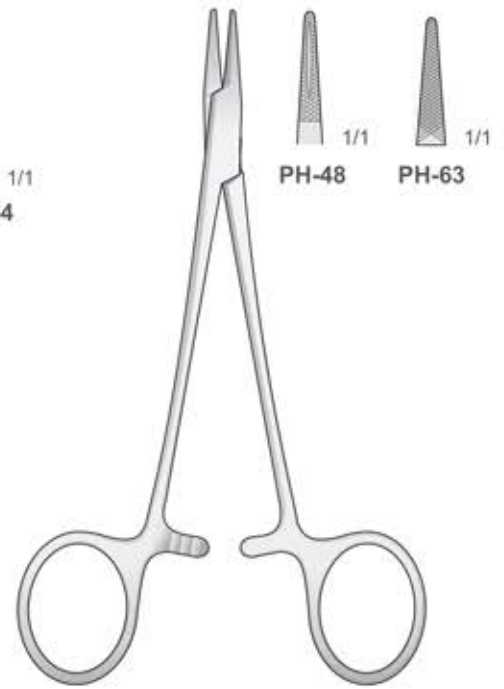

HALSEY
PH-48/PH-63
 130 mm

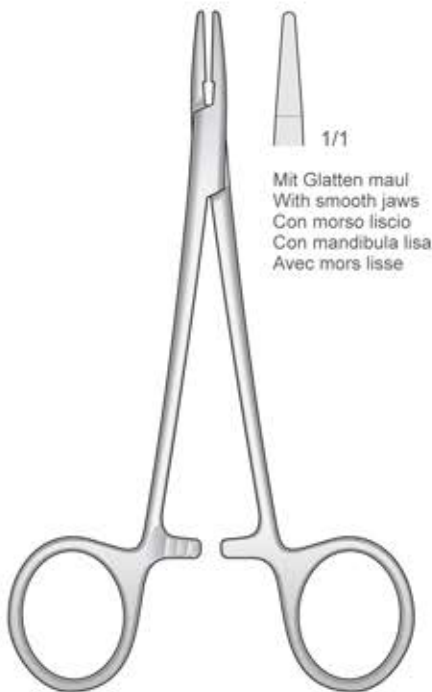

HALSEY
PH-37
 130 mm

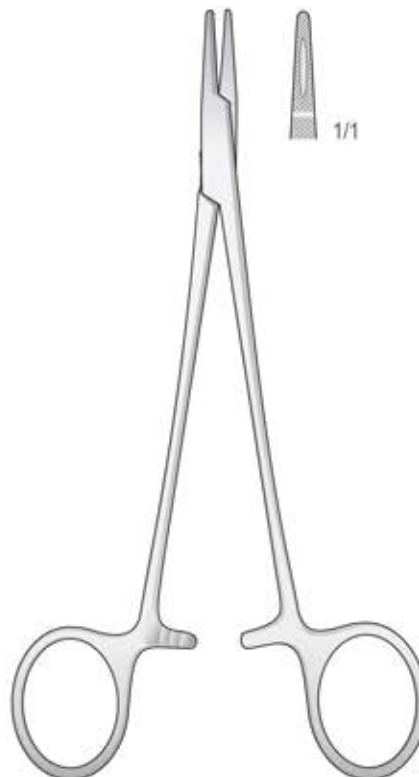

CRILE-WOOD
PH-61
 150 mm

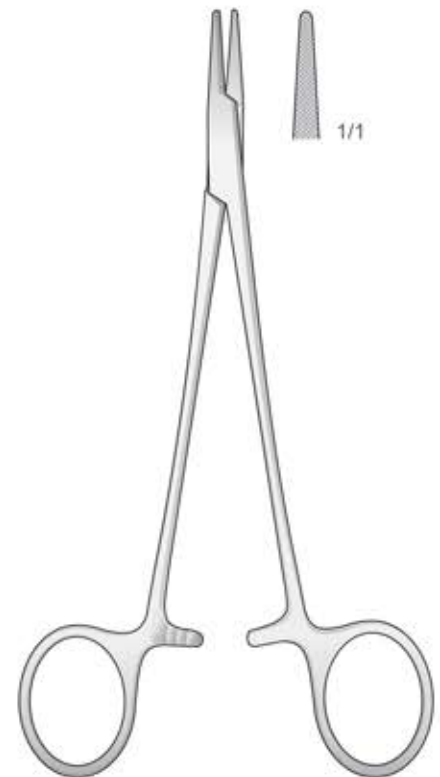

CRILE-MURRAY
PH-62
 150 mm

Nadelhalter mit Schere - Needle holders with scissors
Port'aghi con forbici - Portaagujas con tijeras
Porte aiguilles avec ciseaux



MINI-OLSEN-HEGAR
BM-61
120 mm



OLSEN-HEGAR
BM-62
140 mm

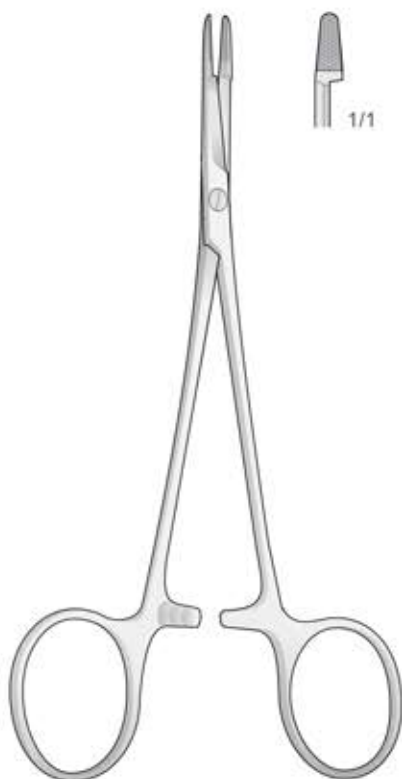

OLSEN-HEGAR
BM-63
170 mm

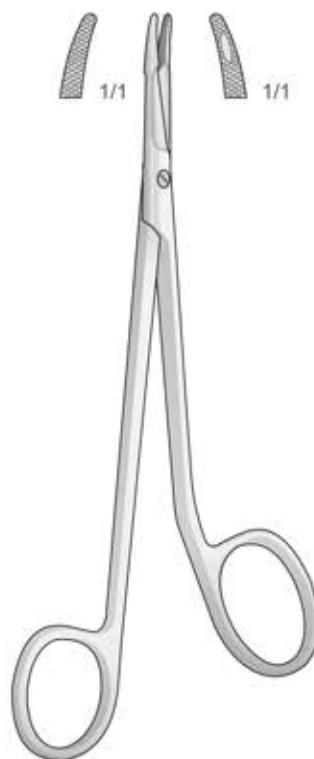

MINI-GILLIES
PO-59
145 mm

Nadelhalter
 Needle Holders
 Port'aghi
 Portaagujas
 Porte aiguilles

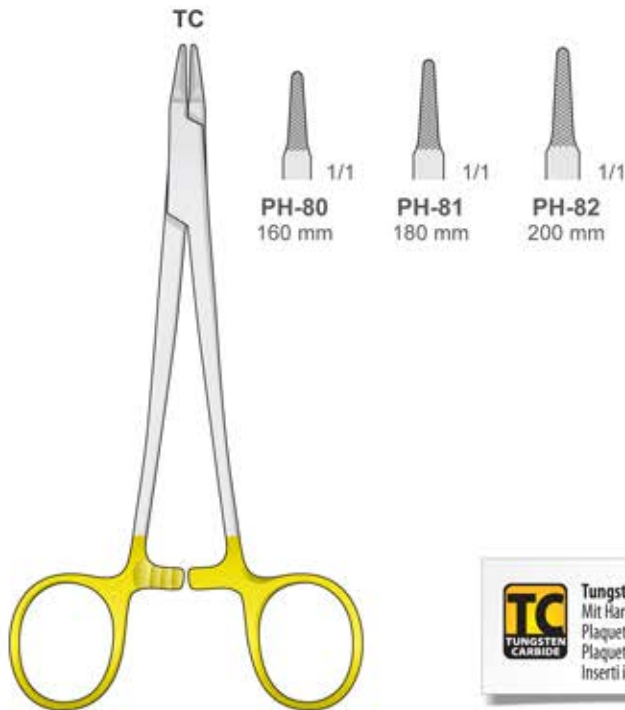

TC
TUNGSTEN
CARBIDE

Tungsten-Carbide Inserts
 Mit Hartmetalleinsätzen
 Plaquettes en carbure de tungstène
 Plaquetas de carburo de tungsteno
 Inserti in carburo di tungsteno

RYDER
PH-80/PH-82

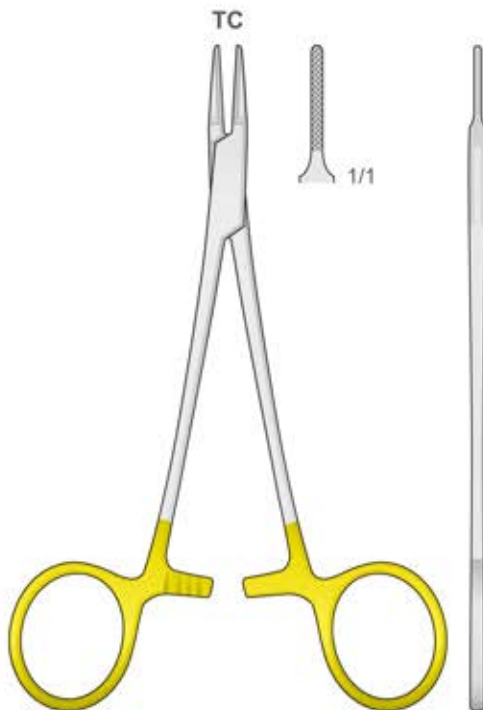

RYDER
PH-83
 140 mm

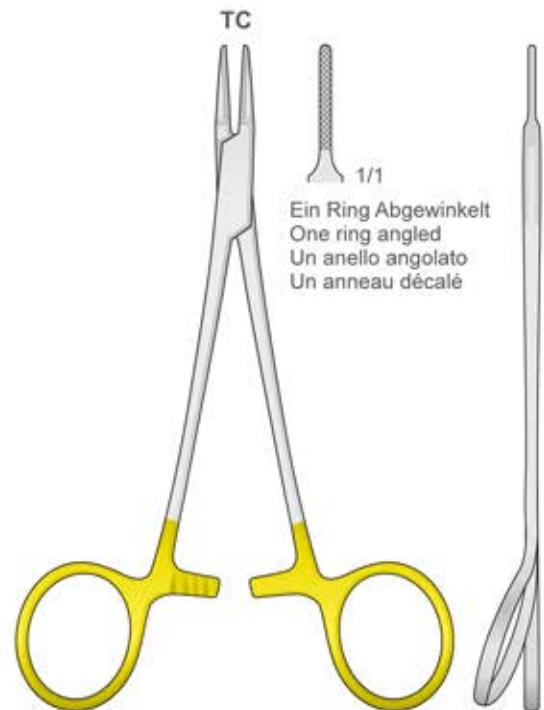

PH-84
 140 mm



Tungsten-Carbide Inserts
Mit Hartmetalleinsätzen
Plaquettes en carbure de tungstène
Plaquetas de carburo de tungsteno
Inserti in carburo di tungsteno

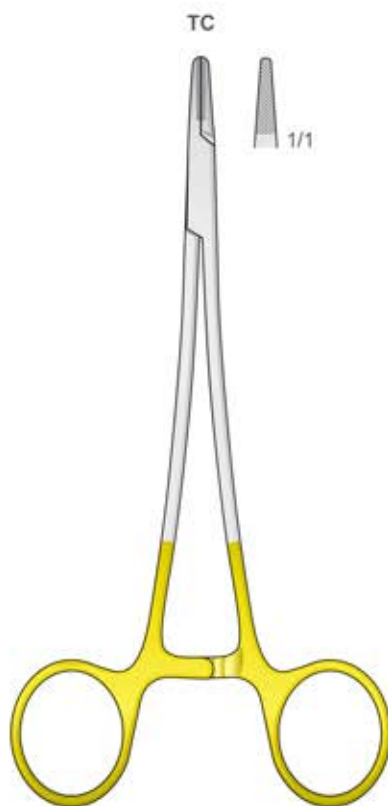

PH-79
145 mm

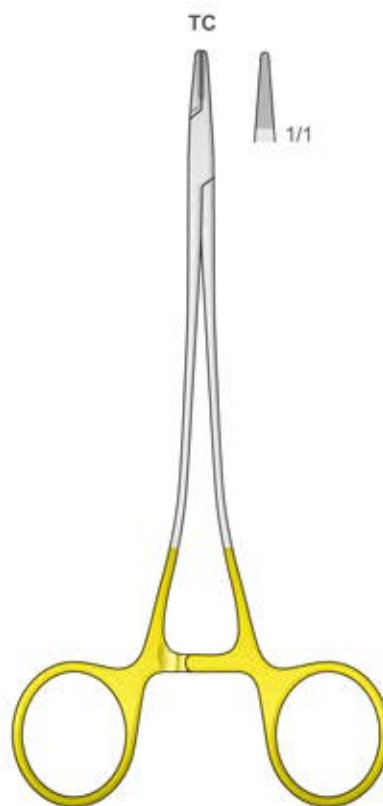

FINE SWEDISH PATTERN
PH-85
150 mm

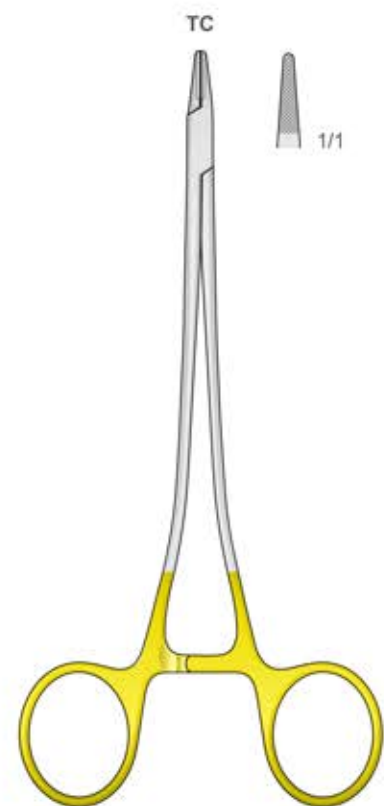

SWEDISH MOD.
PH-106
150 mm

Nadelhalter
 Needle Holders
 Port'aghi
 Portaagujas
 Porte aiguilles

TC
TUNGSTEN
CARBIDE

Tungsten-Carbide Inserts
 Mit Hartmetalleinsätzen
 Plaquettes en carbure de tungstène
 Plaquetas de carburo de tungsteno
 Inserti in carburo di tungsteno

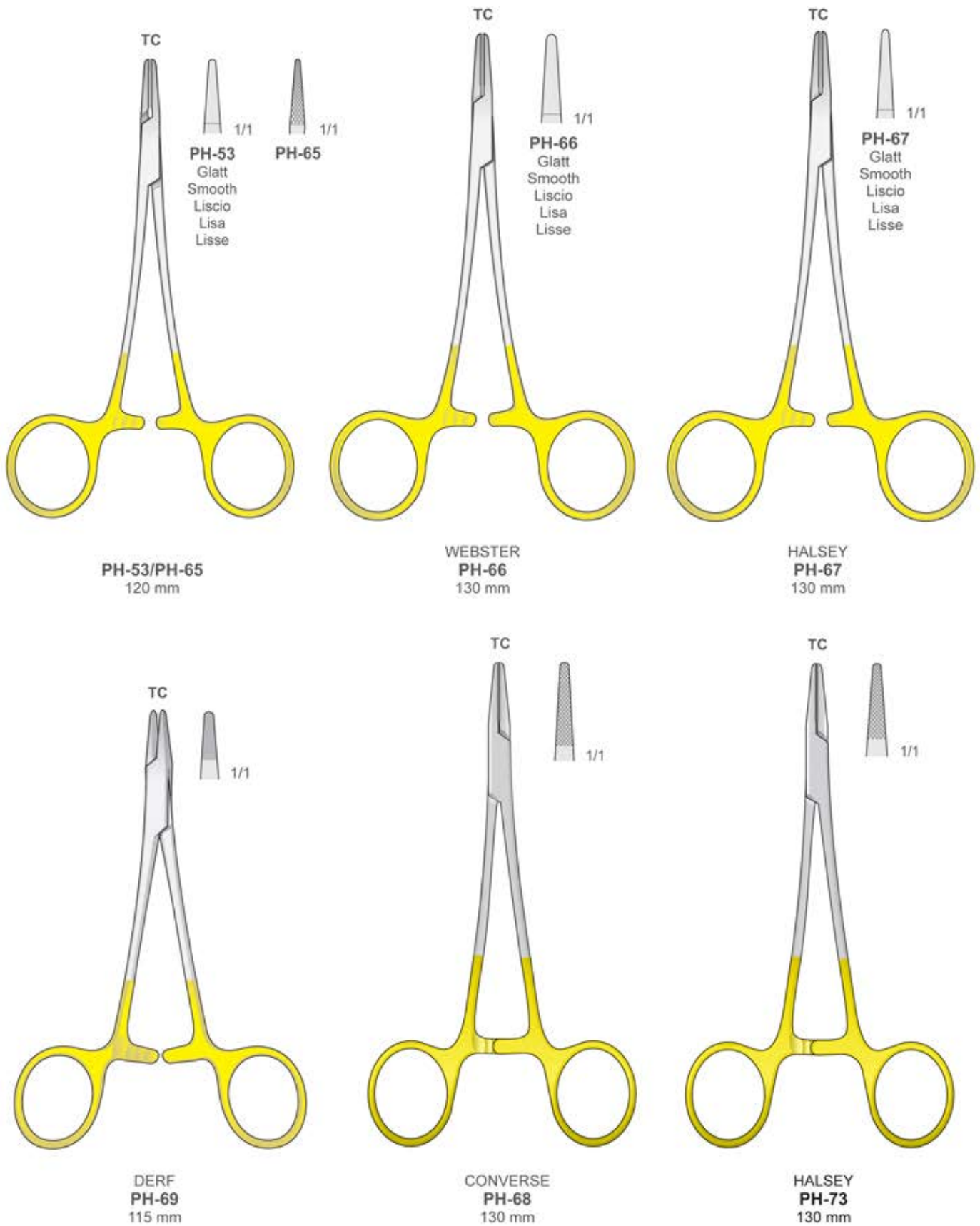



Tungsten-Carbide Inserts
 Mit Hartmetalleinsätzen
 Plaquettes en carbure de tungstène
 Plaquetas de carburo de tungsteno
 Inserti in carburo di tungsteno

Nadelhalter
 Needle Holders
 Port'aghi
 Portaagujas
 Porte aiguilles

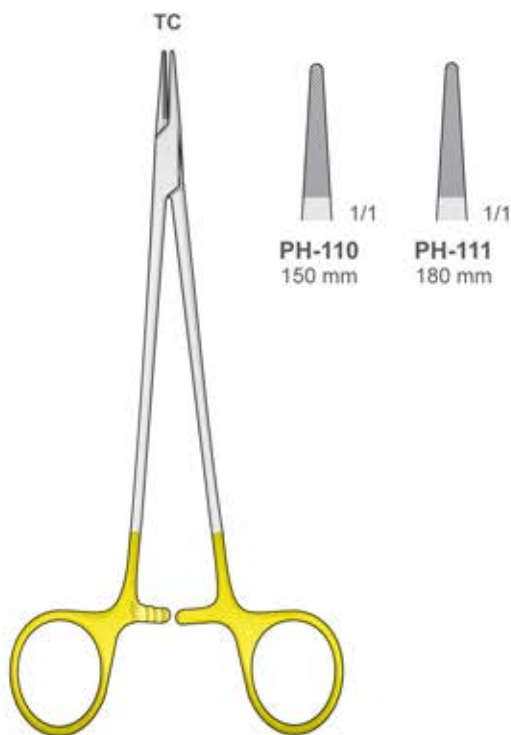

DE BAKEY
 PH-110/PH-111

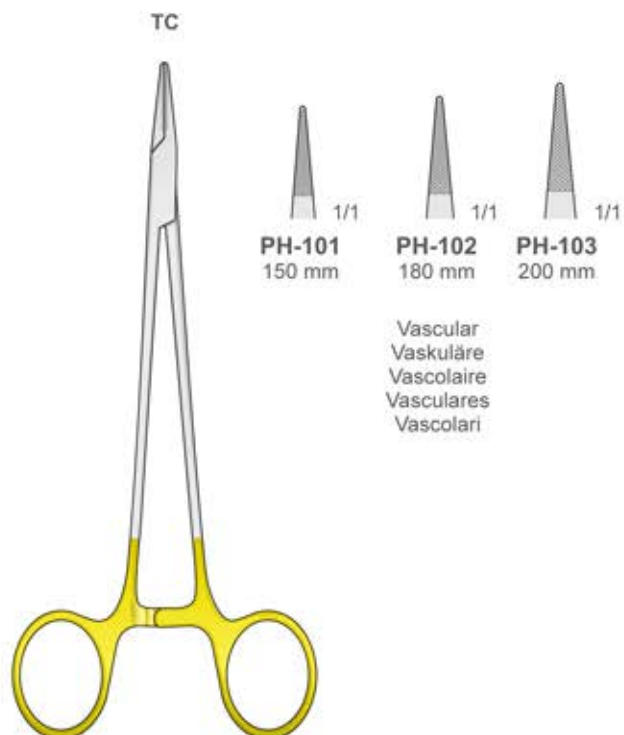

MICRO-VASCULAR
 PH-101/PH-102/PH-103

Vascular
 Vaskuläre
 Vasculaire
 Vasculares
 Vascolari

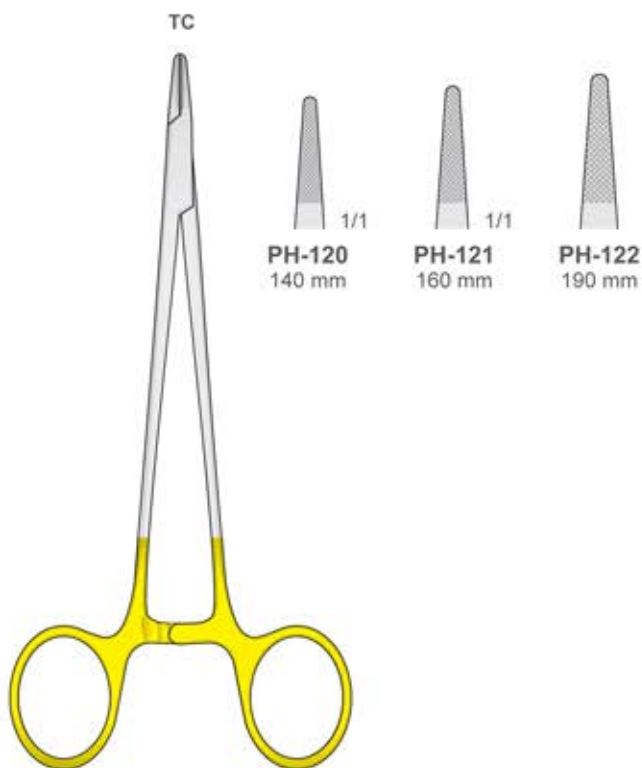

MAYO-HEGAR
 PH-120/PH-121/PH-122

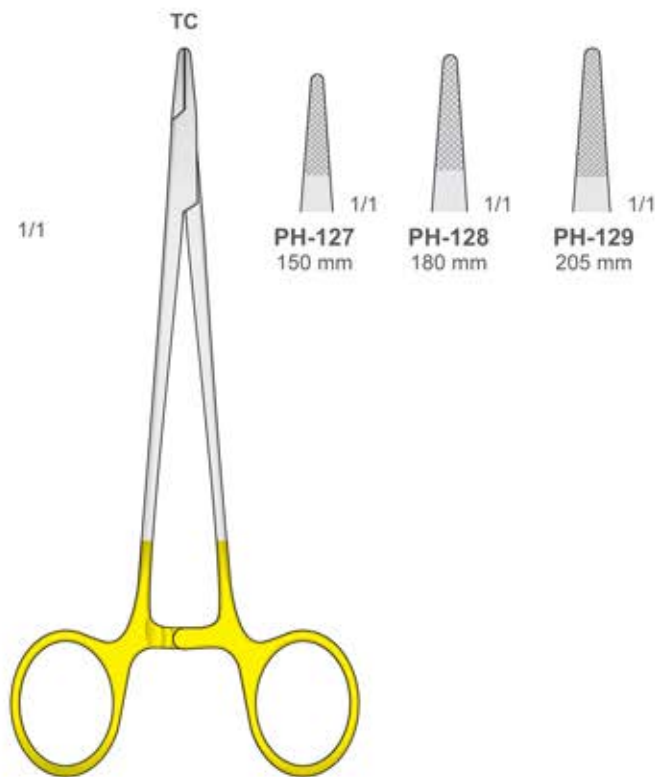

MAYO-HEGAR-FINO
 PH-127/PH-128/PH-129

Nadelhalter
 Needle Holders
 Port'aghi
 Portaagujas
 Porte aiguilles



Tungsten-Carbide Inserts
 Mit Hartmetalleinsätzen
 Plaquettes en carbure de tungstène
 Plaquetas de carburo de tungsteno
 Inserti in carburo di tungsteno

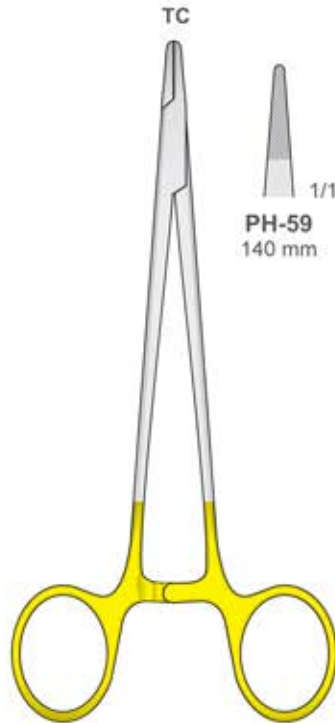

HEGAR
 PH-59/PH-76

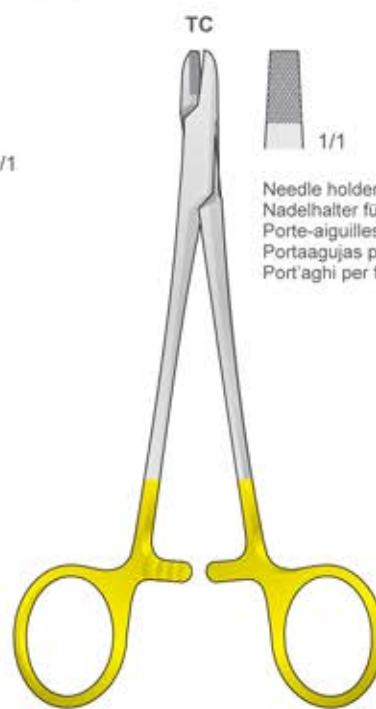
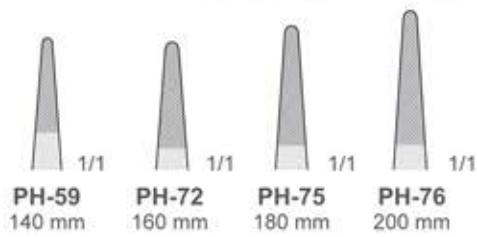

PH-58
 150 mm



Needle holders for wire
 Nadelhalter für drähte
 Porte-aiguilles pour fil métallique
 Portaagujas para hilo metálico
 Port'aghi per fili metallici

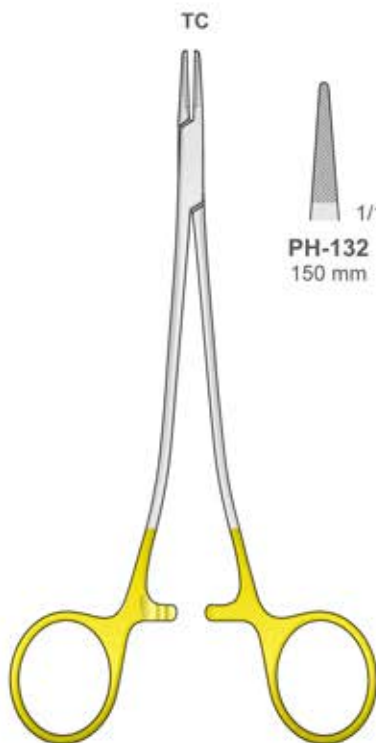

SAROT
 PH-132/PH-134

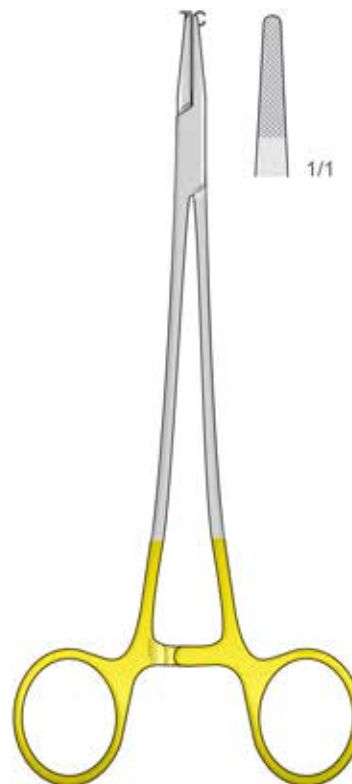
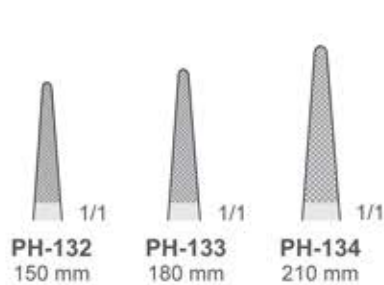

CRILE-WOOD
 PH-77
 180 mm

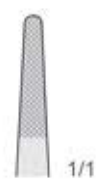



Tungsten-Carbide Inserts
 Mit Hartmetalleinsätzen
 Plaquettes en carbure de tungstène
 Plaquetas de carburo de tungsteno
 Inserti in carburo di tungsteno

Nadelhalter
 Needle Holders
 Port'aghi
 Portaagujas
 Porte aiguilles

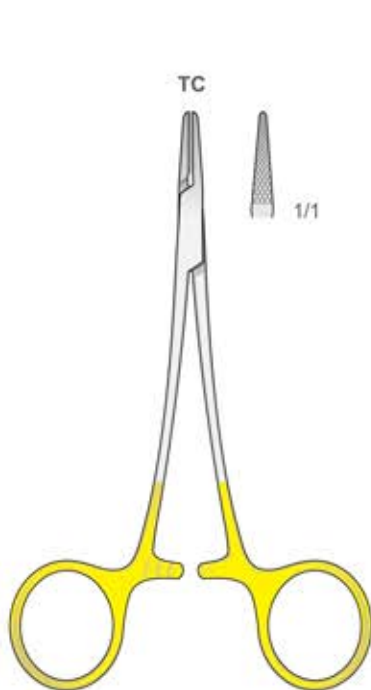

PH-99
120 mm

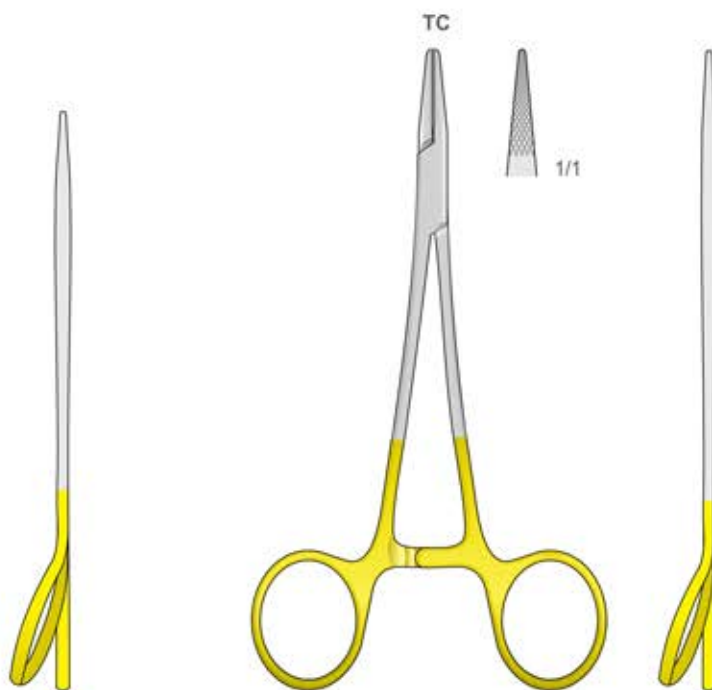

CRILE-WOOD PH-100
150 mm

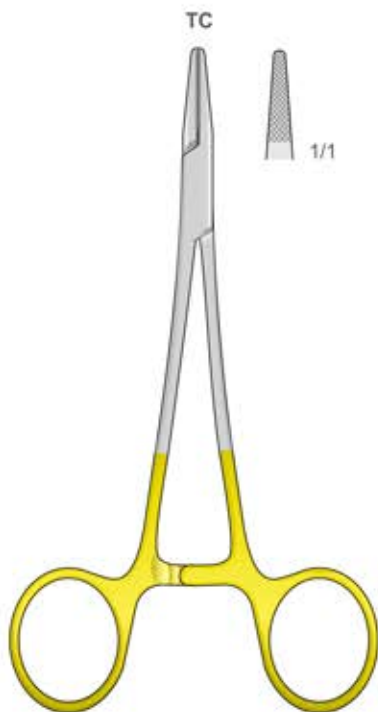

BABY-CRILE-WOOD PH-54
150 mm

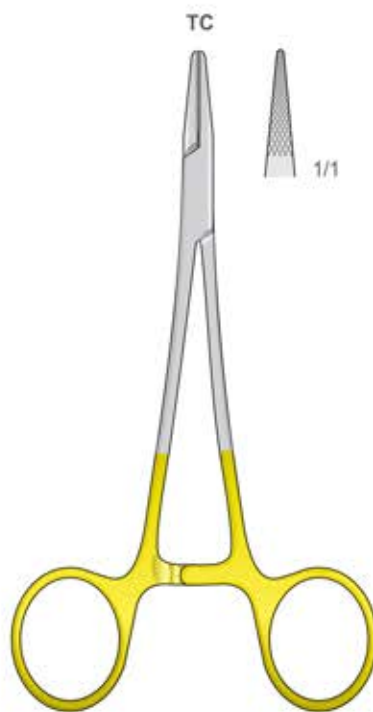

CRILE-WOOD PH-71
150 mm



CRILE-WOOD PH-90
150 mm

Nadelhalter
 Needle Holders
 Port'aghi
 Portaagujas
 Porte aiguilles



Tungsten-Carbide Inserts
 Mit Hartmetalleinsätzen
 Plaquettes en carbure de tungstène
 Plaquetas de carburo de tungsteno
 Inserti in carburo di tungsteno

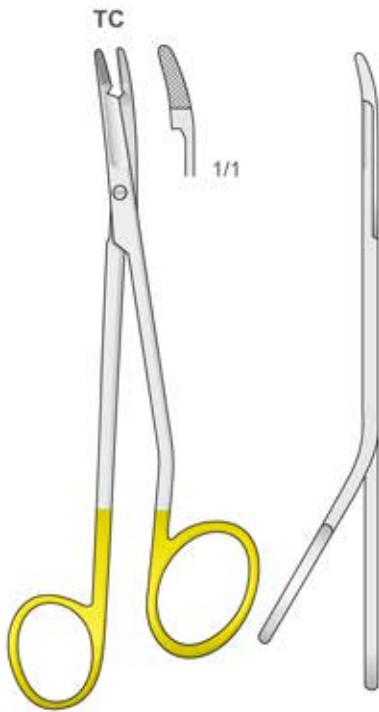

MINI-GILLIES
PO-99
 145 mm

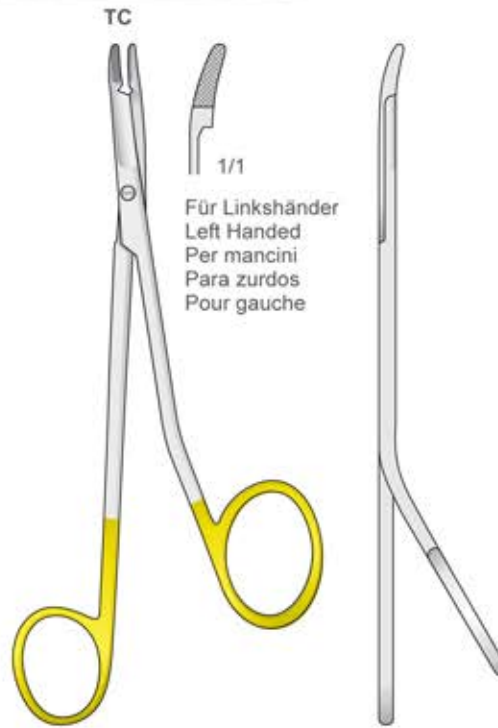

MINI-GILLIES
PO-99L
 145 mm

Für Linkshänder
 Left Handed
 Per mancini
 Para zurdos
 Pour gauche

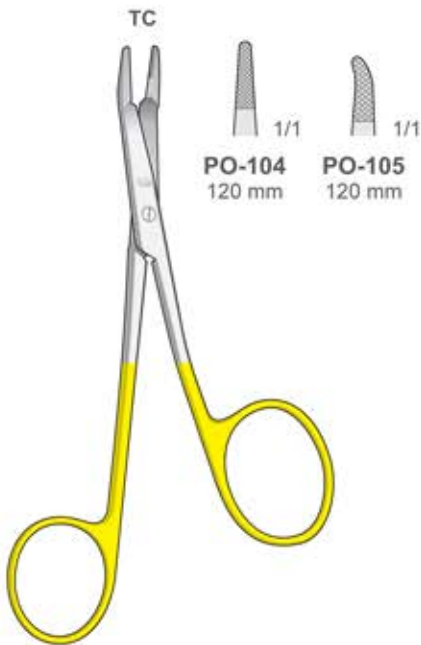

FOSTER-GILLIES
PO-104/PO-105
 120 mm

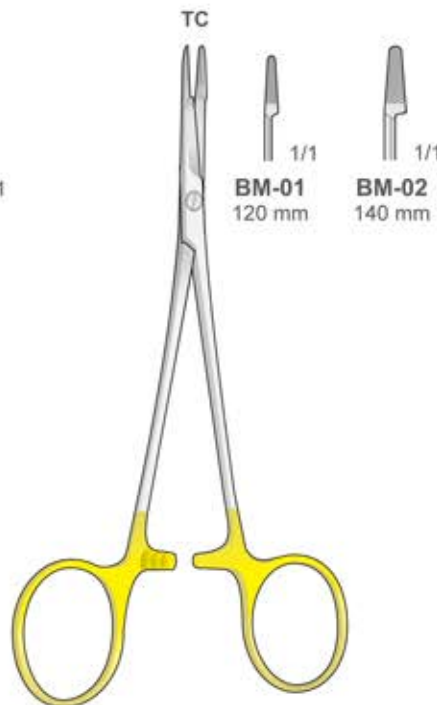

OLSEN-HEGAR
BM-01/BM-02

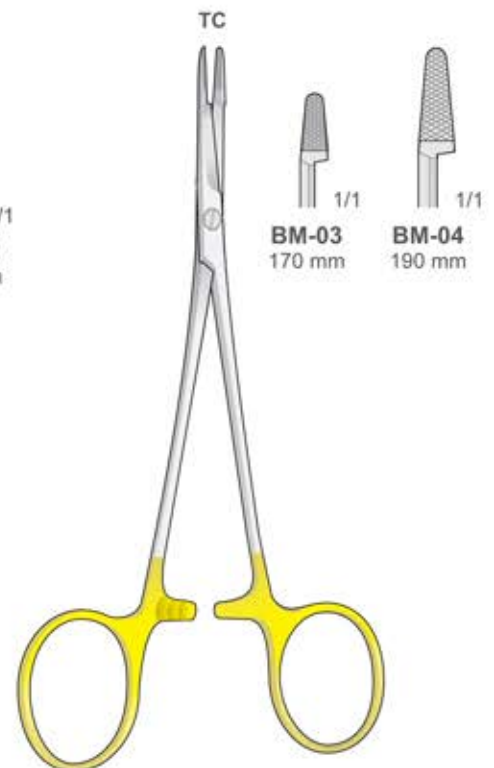

OLSEN-HEGAR
BM-03/BM-04

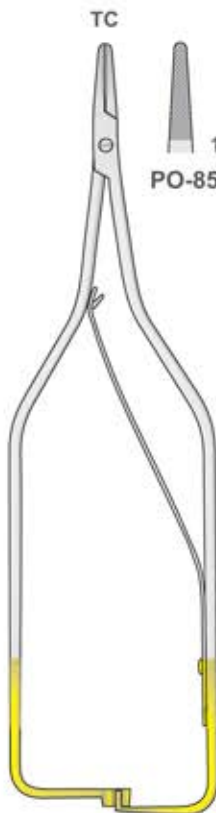

ARRUGA
PO-85/PO-87
160 mm

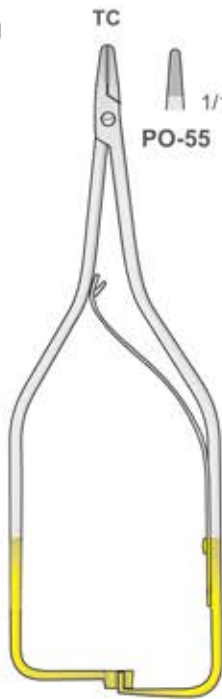
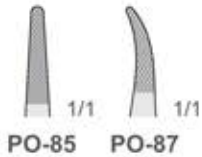

BOYNTON
PO-55/PO-56
120 mm

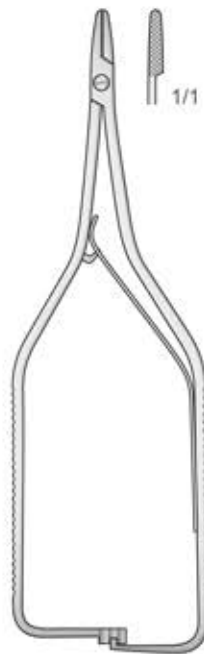
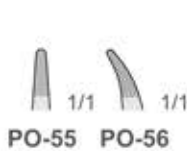

BOYNTON
PO-88
120 mm

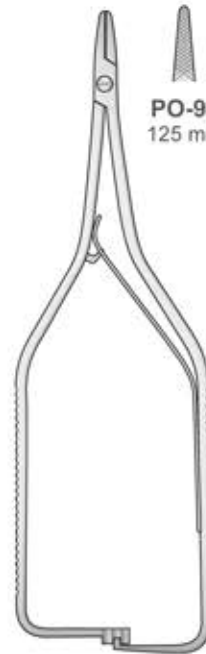

BOYNTON
PO-94
125 mm



MATHIEU
PO-50/PO-52

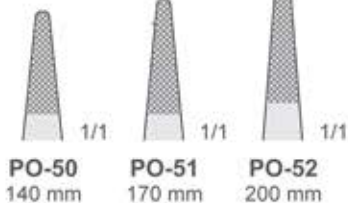

MATHIEU
PO-82/PO-84

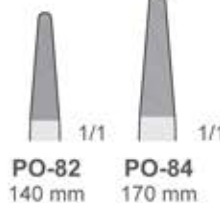

LICHTENBERG
PO-86
175 mm



Nadelhalter
 Needle Holders
 Port'aghi
 Portaagujas
 Porte aiguilles



CRILE
PO-37
 150 mm



TÖNNIS
PO-38
 190 mm

Schlankesmodell - Delicate pattern - Modello fine
 Modelo delegado - Modèle fin

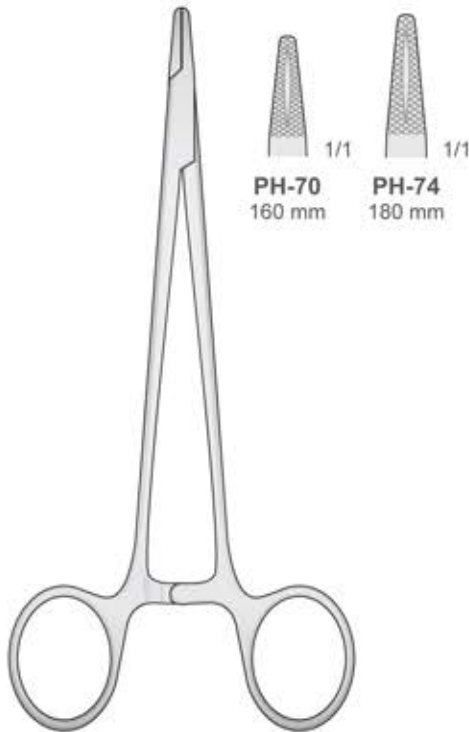

HEGAR
PH-70/PH-74

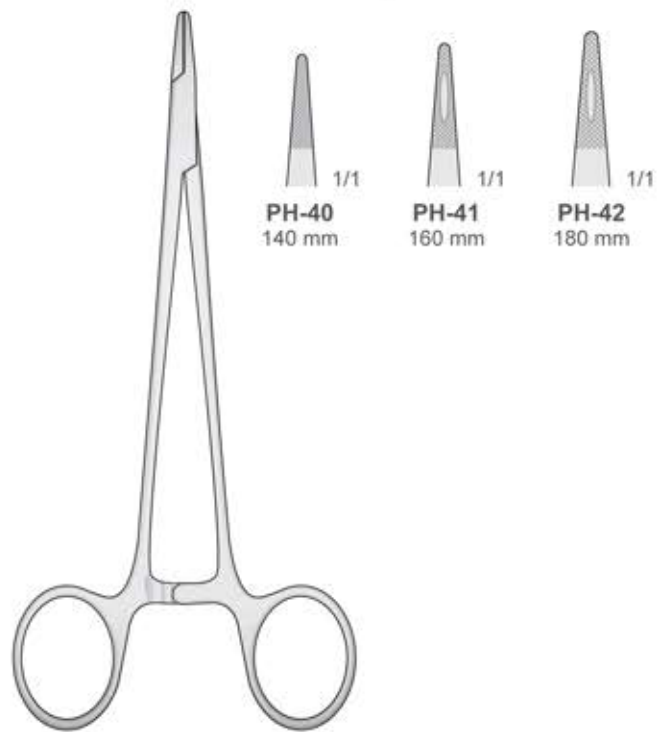

MAYO-HEGAR
PH-40/PH-42

Nadelhalter
Needle Holders
Port'aghi
Portaagujas
Porte aiguilles

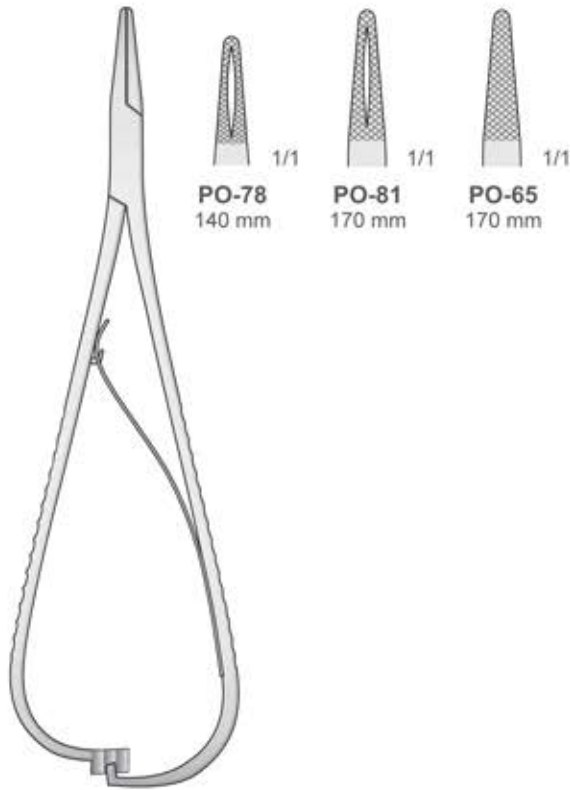

MATHIEU
PO-65/PO-81

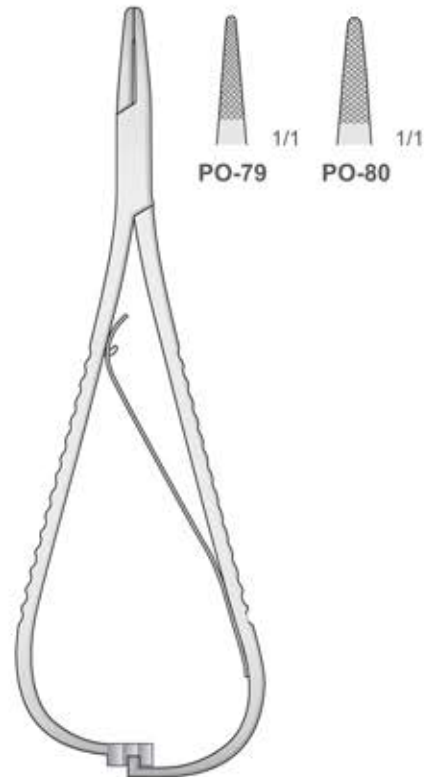

MATHIEU
PO-79/PO-80
140 mm

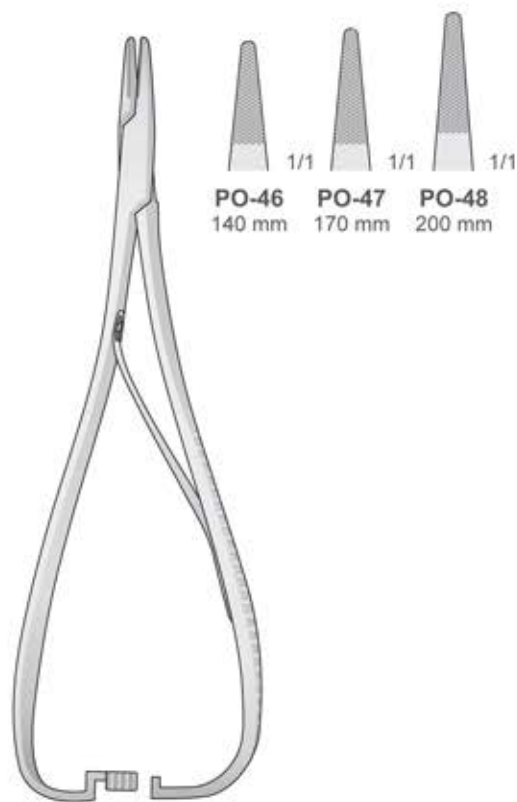

MATHIEU
PO-46/PO-48



PO-40
140 mm

Nadelhalter
 Needle Holders
 Port'aghi
 Portaagujas
 Porte aiguilles



MATHIEU
PO-45
 125 mm

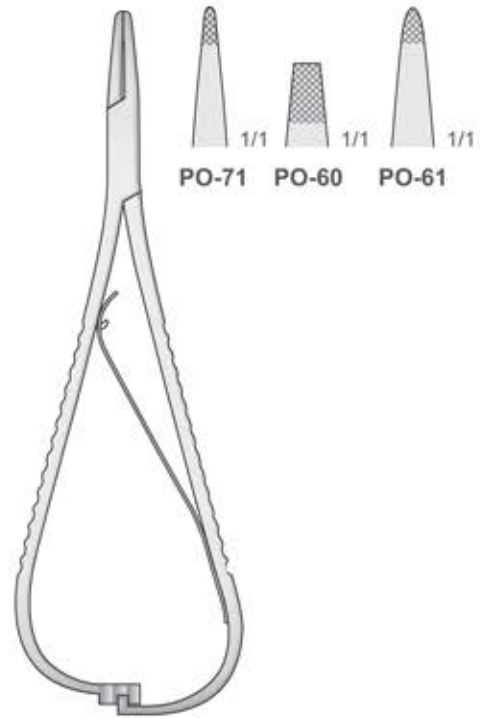

MATHIEU
PO-60/PO-71
 140 mm



SMAHA
PO-68
 140 mm



SMAHA
PO-69
 140 mm

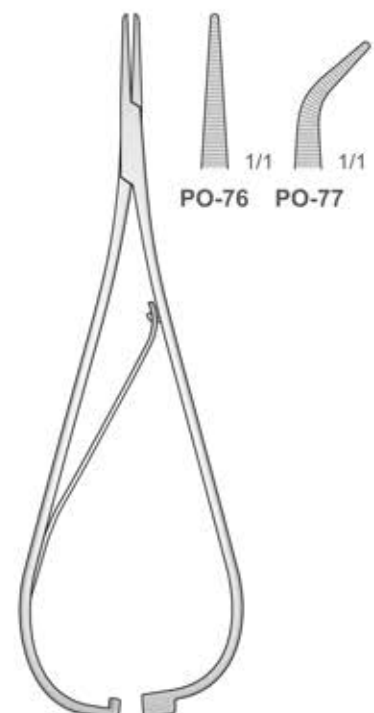

SMAHA
PO-76/PO-77
 140 mm

Receive a Free Multimedia Catalogue DVD.

Includes over 10,000 instruments
made in Germany
for all medical specialty fields.

Erhalten Sie ein kostenloses Exemplar des Multimedia-Katalogs auf DVD.

Umfasst mehr als 10.000 Instrumente,
hergestellt in Deutschland
für alle medizinischen Fachrichtungen.

Recevez gratuitement le DVD multimédia avec tous nos catalogues.

Comprend plus de 10.000 instruments
fabriqués en Allemagne
pour toutes les spécialités médicales.

Reciba gratis el DVD multimedia con todos nuestros catálogos.

Incluye más de 10.000 instrumentos
hechos en Alemania
para todas las especialidades médicas.

Ricevi gratuitamente il DVD multimediale con tutti i nostri cataloghi.

Comprende più di 10.000 strumenti
fatti in Germania
per tutte le specializzazioni mediche.



G

Hemostatic Forceps

Arterienklemmen
Pincés hémostatiques
Pinzas hemostáticas
Pinzette emostatiche

Towel Clamps

Tuchklemmen
Pincés fixe-compresses
Pinzas de campo
Fissateli

Sponge and Dressing Forceps

Schwamm und Tamponzangen
Pincés pour éponges et à pansement
Pinzas para esponja y tampones
Pinze per tamponi e spunge

Tissue Grasping Forceps

Gewebefasszangen
Pincés pour tissus
Pinzas para tejidos
Pinze per tessuti





Tuchklemmen
 Towel Clamps
 Fissateli
 Pinzas de campo
 Pincas fixe-compresses



SCHAEDEL
BF-38
 85 mm



JONES
BF-48
 90 mm



FAURE
BF-40
 85 mm

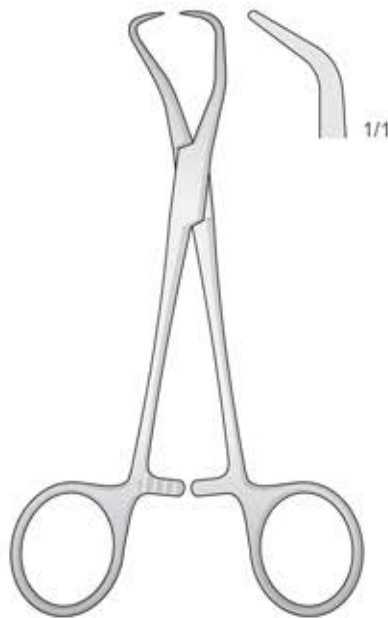

BACKHAUS
BF-42/BF-46



BF-42
 90 mm



BF-41
 100 mm



BF-44
 110 mm



BF-46
 130 mm



BF-43
 135 mm



BF-45
 140 mm

Für Papiertücher
For paper cloths
Per teli di carta
Para paños
Pour papier

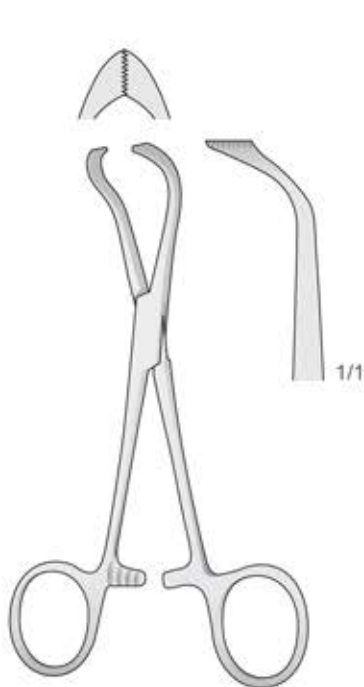

LORNA
BF-50
100 mm

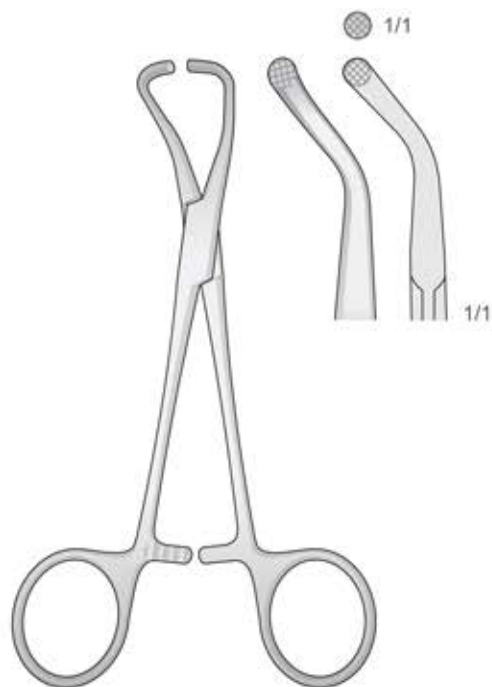

BF-52
130 mm

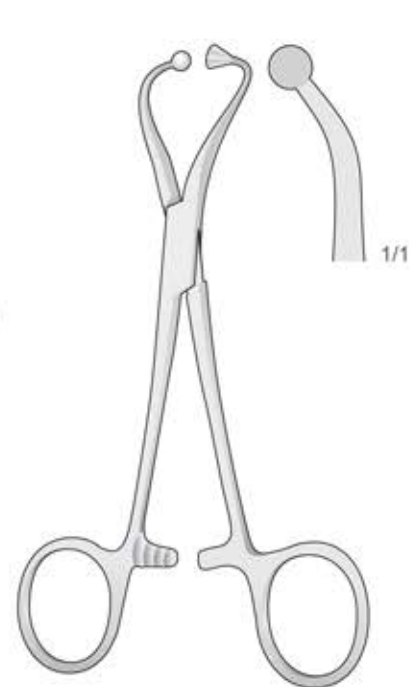

BF-75
140 mm



Schwamm und Tamponzangen
 Sponge and Dressing Forceps
 Pinze per tamponi e spunge
 Pinzas para esponja y tampones
 Pincés pour éponges et à pansement

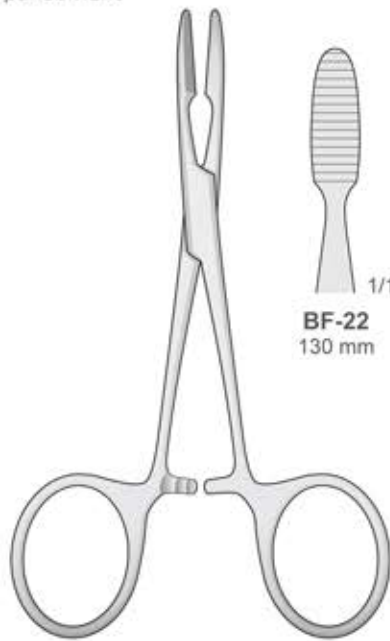

BF-22
130 mm

BF-24
140 mm

PEAN-MURPHY
BF-22/BF-24

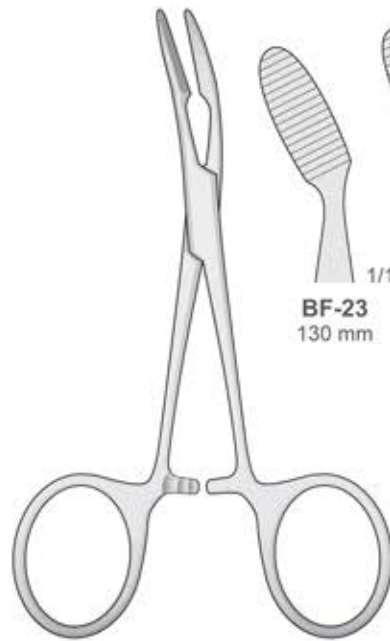

BF-23
130 mm

BF-25
140 mm

PEAN-MURPHY
BF-23/BF-25

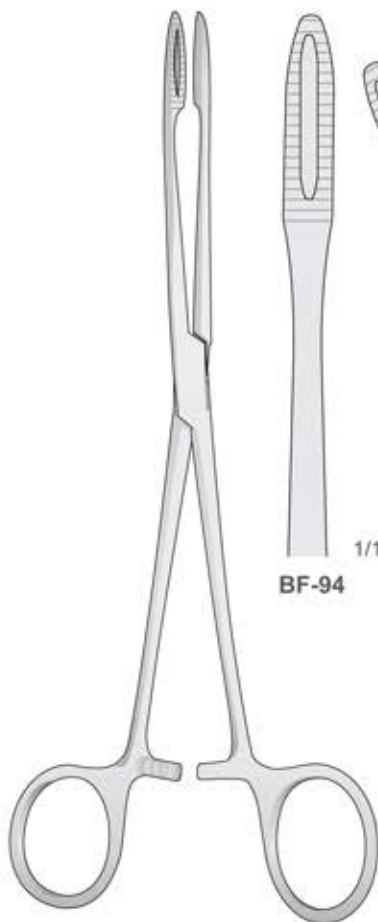

BF-94

BF-95

GROSS
BF-94/BF-95
200 mm

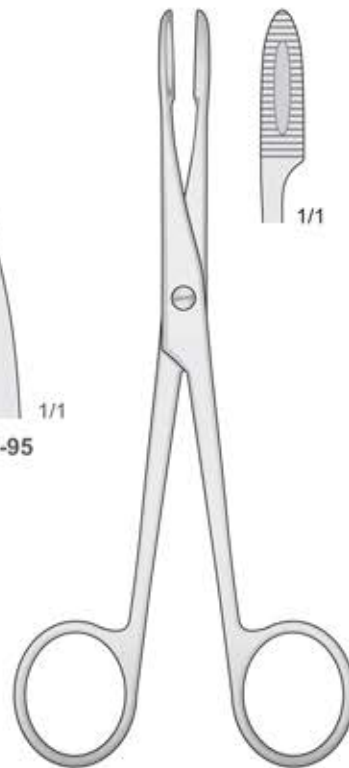

1/1

GROSS
BF-10 130 mm
BF-12 160 mm

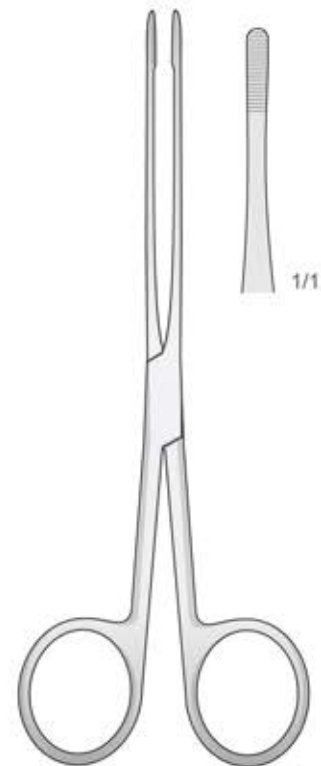

1/1

LISTER
BF-20
150 mm

Sinus klemmen
 Sinus forceps
 Pinze Sinus
 Pinzas para seno
 Pincés à Sinus

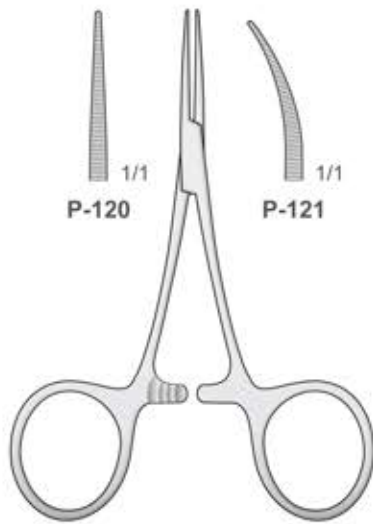

HARTMANN/BABY-MOSQUITO
P-120/P-121
95 mm

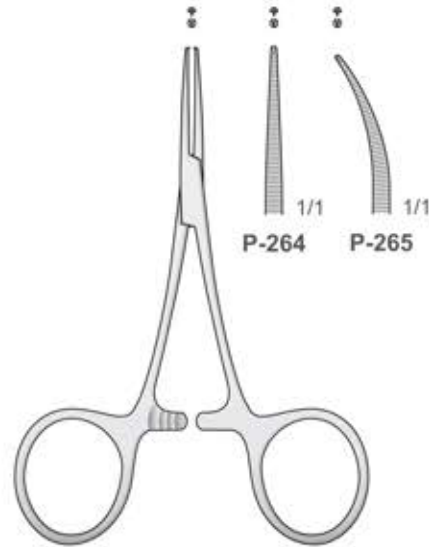

HARTMANN/BABY-MOSQUITO
P-264/P-265
95 mm

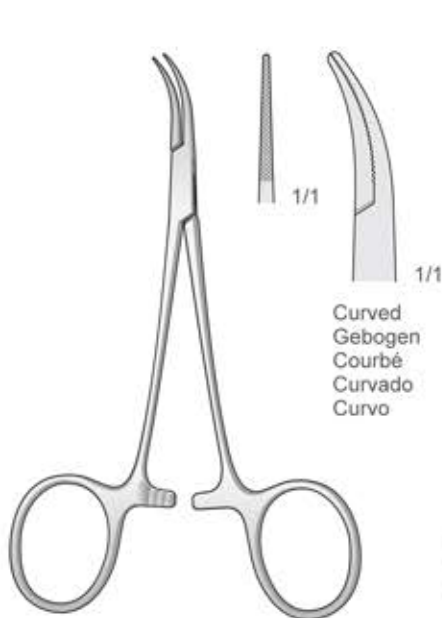

DANDY-MOSQUITO
P-332
120 mm

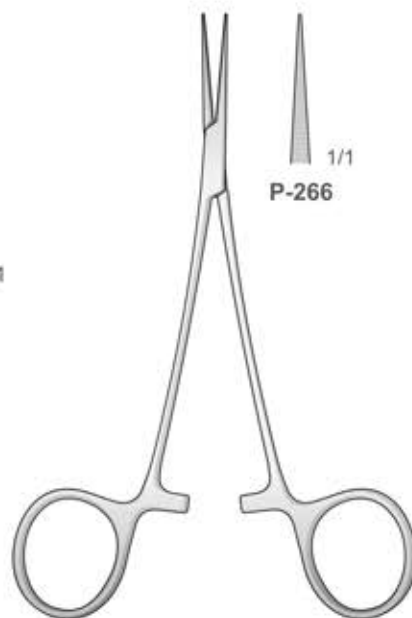

JACOBSON-MICRO
P-266
130 mm

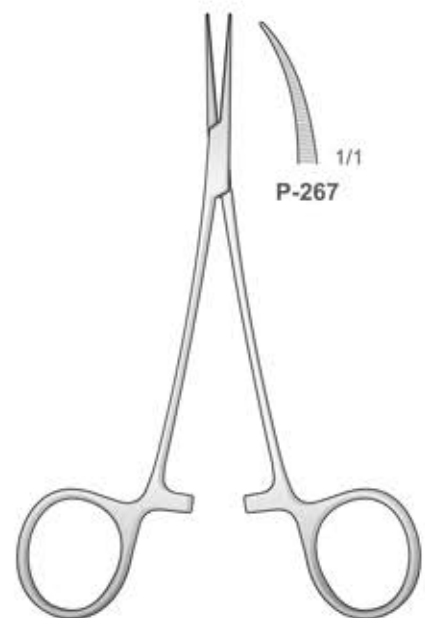

JACOBSON-MICRO
P-267
130 mm

Curved
Gebogen
Courbé
Curvado
Curvo



Arterienklemmen
 Hemostatic Forceps
 Pinze emostatiche
 Pinzas hemostáticas
 Pincas hémostatiques

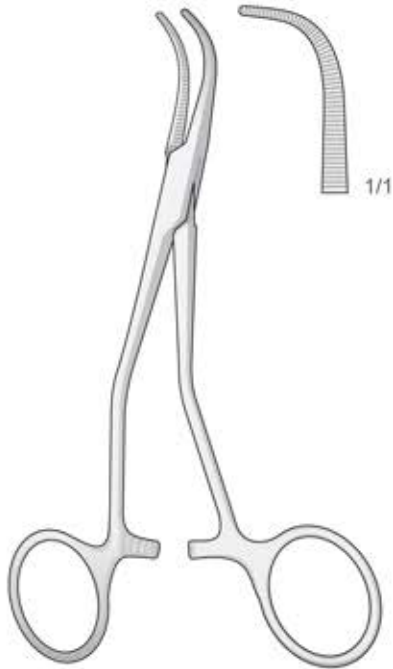

P-15
 130 mm



**PEET
 DR-40**
 120 mm

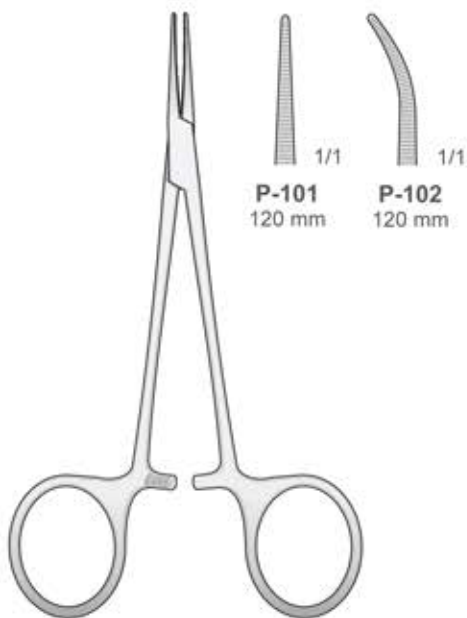

**MICRO-HALSTED
 P-101/P-102**

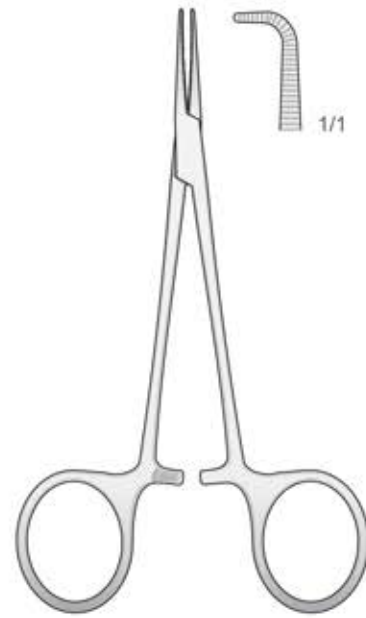

**MICRO-HALSTED
 P-135**
 115 mm

Arterienklemmen
 Hemostatic Forceps
 Pinze emostatiche
 Pinzas hemostáticas
 Pinces hémostatiques

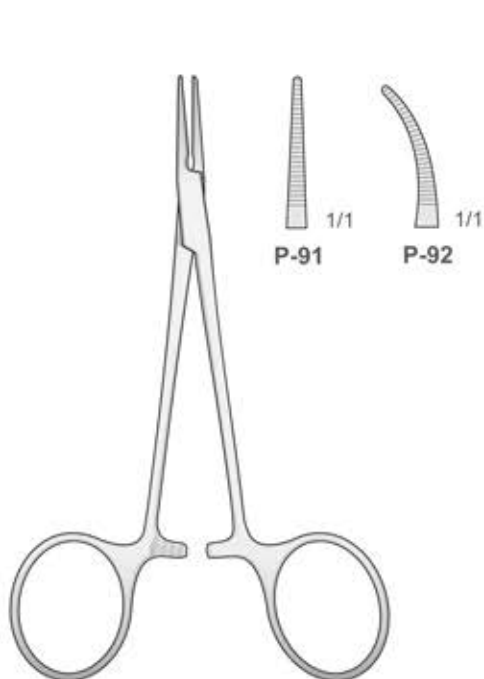

HALSTED
P-91/P-92
 125 mm

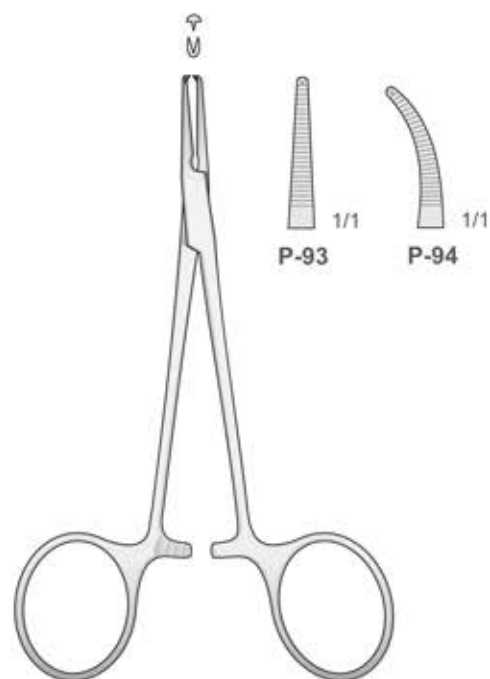

HALSTED
P-93/P-94
 125 mm

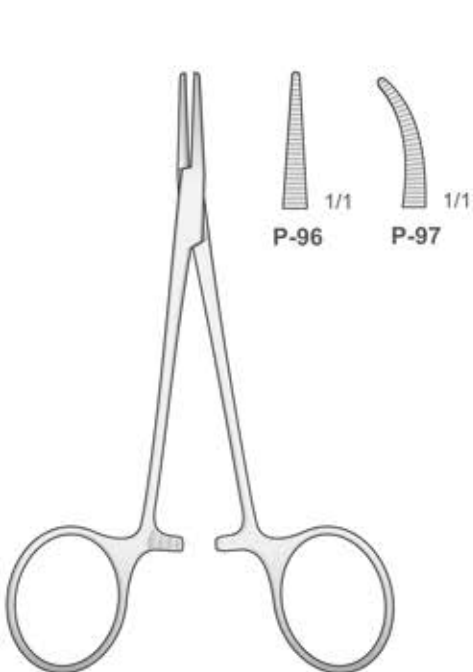

HALSTED-MOSQUITO
P-96/P-97
 120 mm

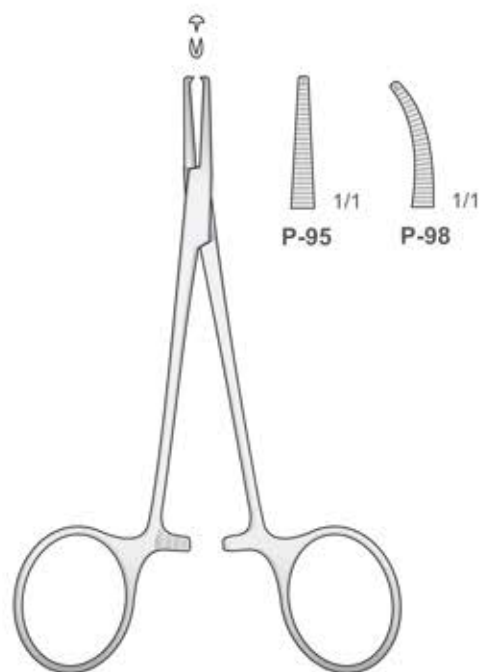

HALSTED-MOSQUITO
P-95/P-98
 120 mm



Arterienklemmen
 Hemostatic Forceps
 Pinze emostatiche
 Pinzas hemostáticas
 Pincas hémostatiques

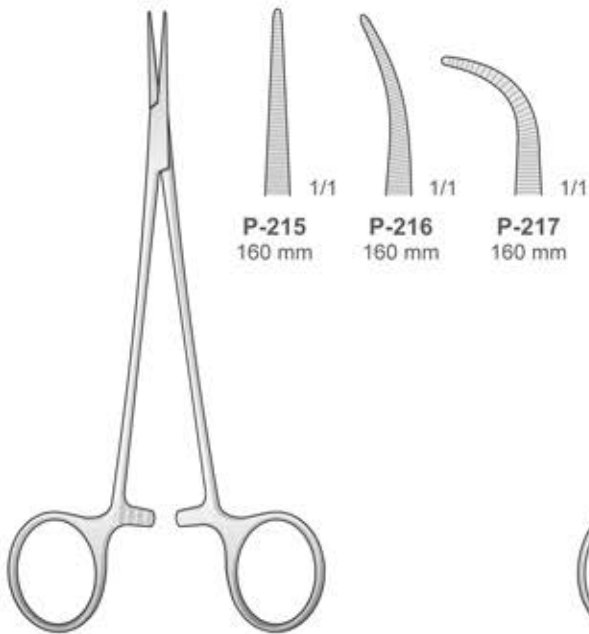

P-215/P-217
 160 mm

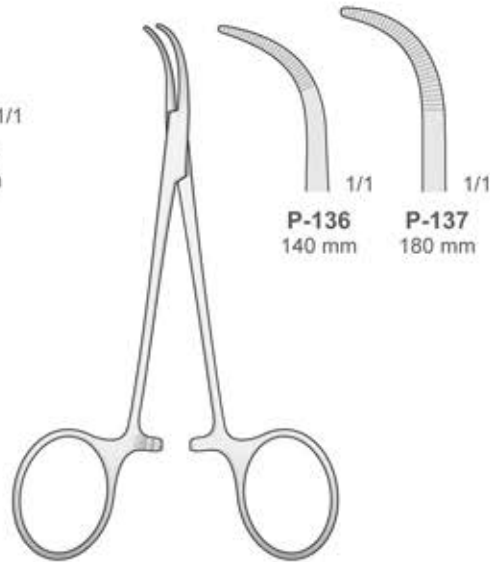

BABY-MIXTER
P-136/P-137

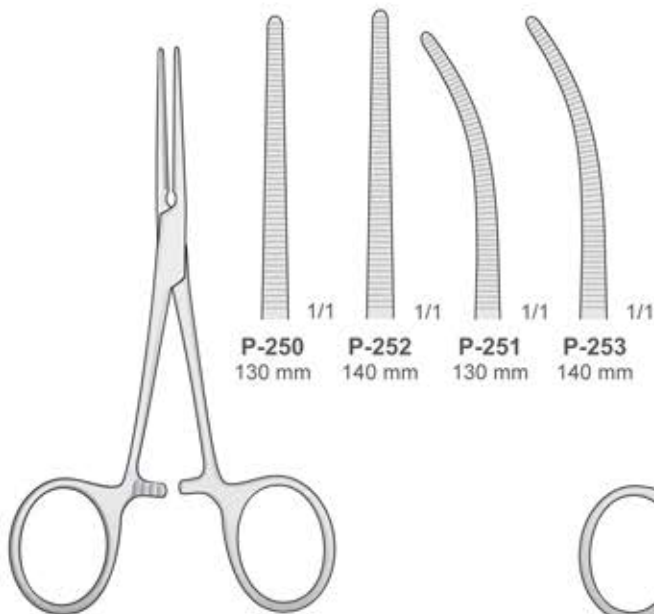

PEAN
P-250/P-253

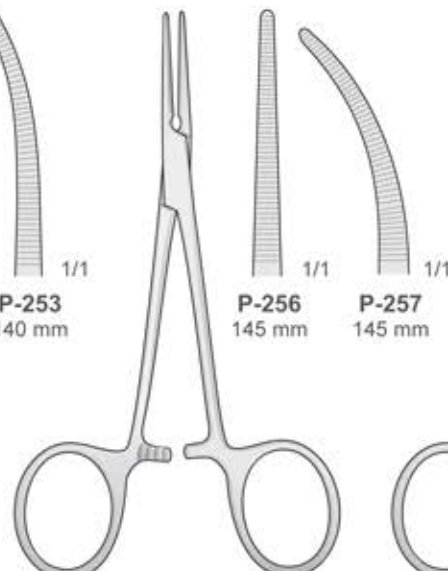

PEAN
P-256/P-257

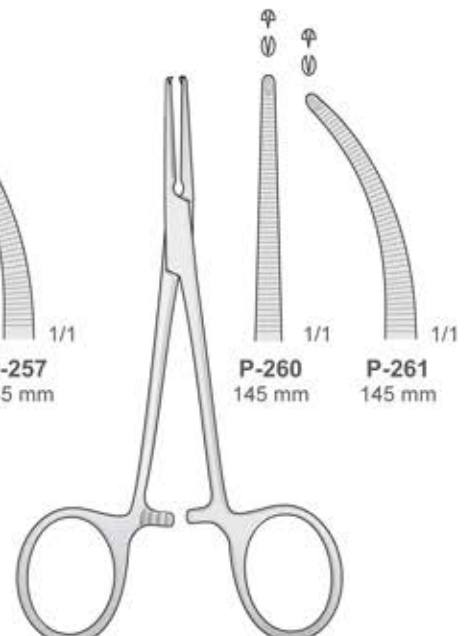

KOCHER
P-260/P-261

Arterienklemmen
 Hemostatic Forceps
 Pinze emostatiche
 Pinzas hemostáticas
 Pincas hémostatiques

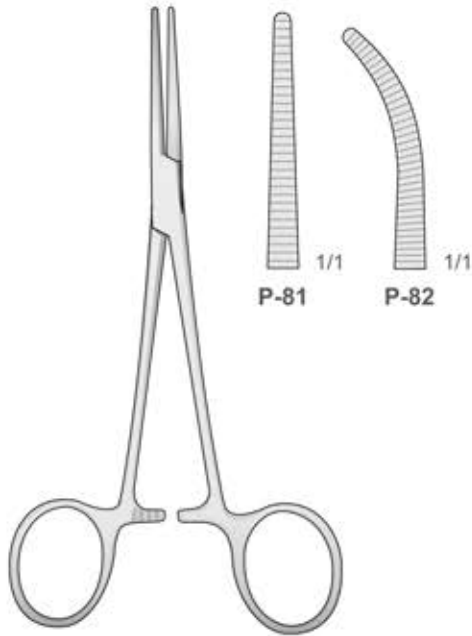

CRILE
 P-81/P-82
 140 mm

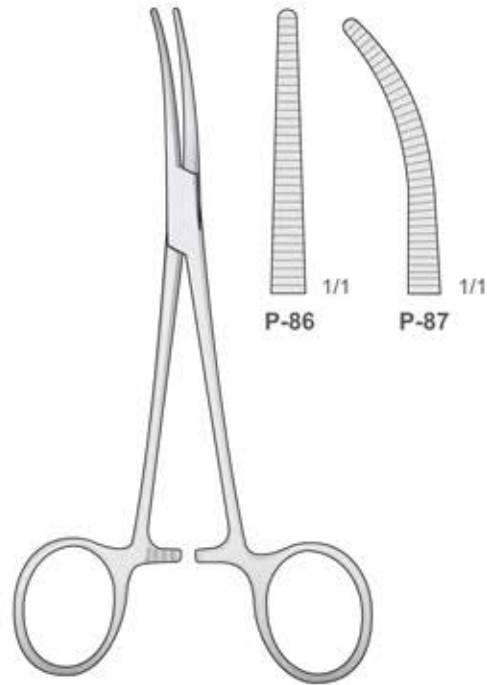

CRILE
 P-86/P-87
 160 mm

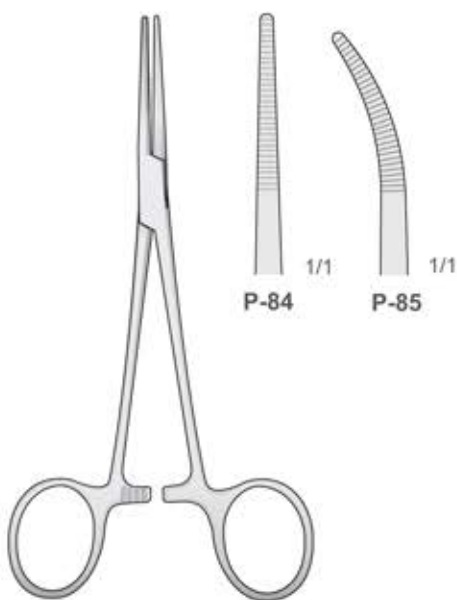

KELLY
 P-84/P-85
 140 mm

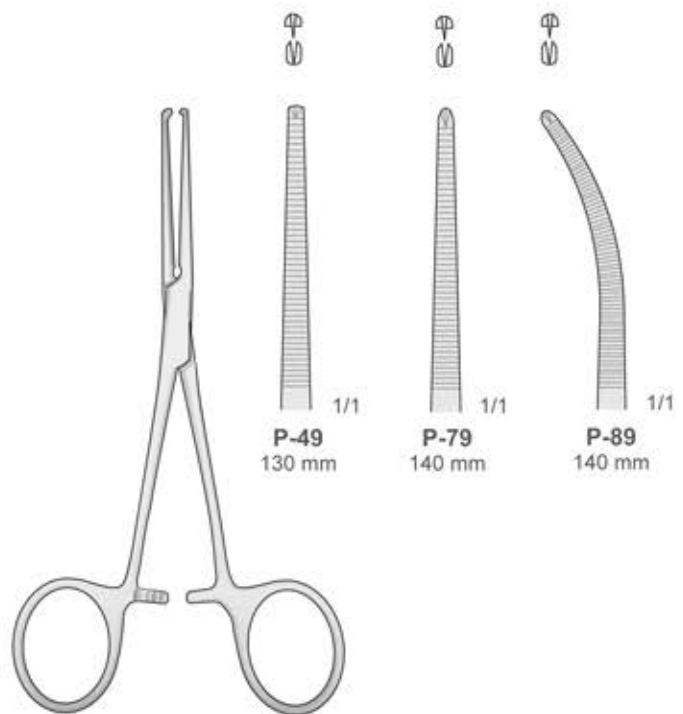

KOCHER
 P-49/P-89



Arterienklemmen
 Hemostatic Forceps
 Pinze emostatiche
 Pinzas hemostáticas
 Pincas hémostatiques

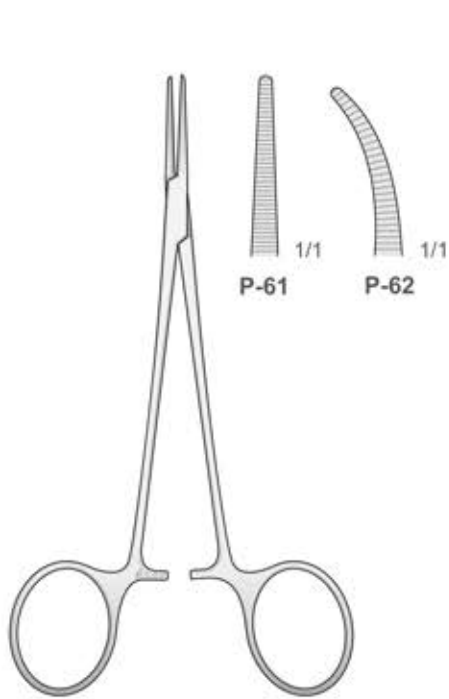

LERICHE
 P-61/P-62
 150 mm

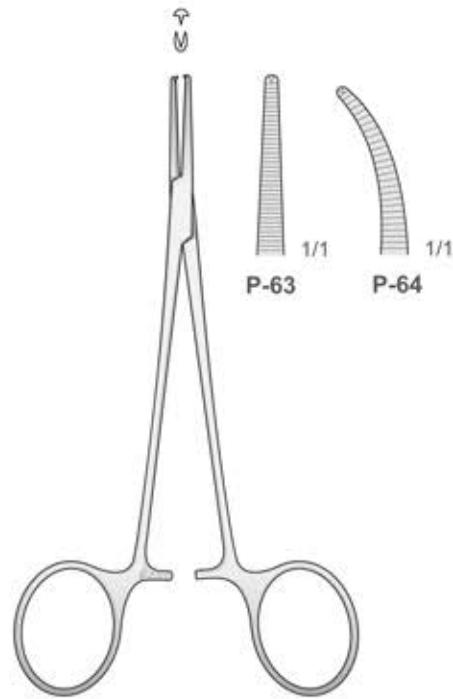

LERICHE
 P-63/P-64
 150 mm

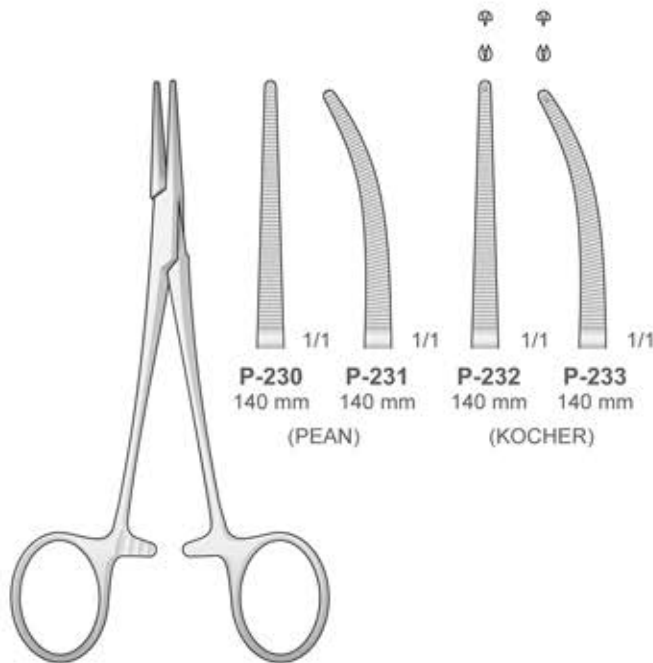

BABY-CRILE
 P-230/P-233
 140 mm

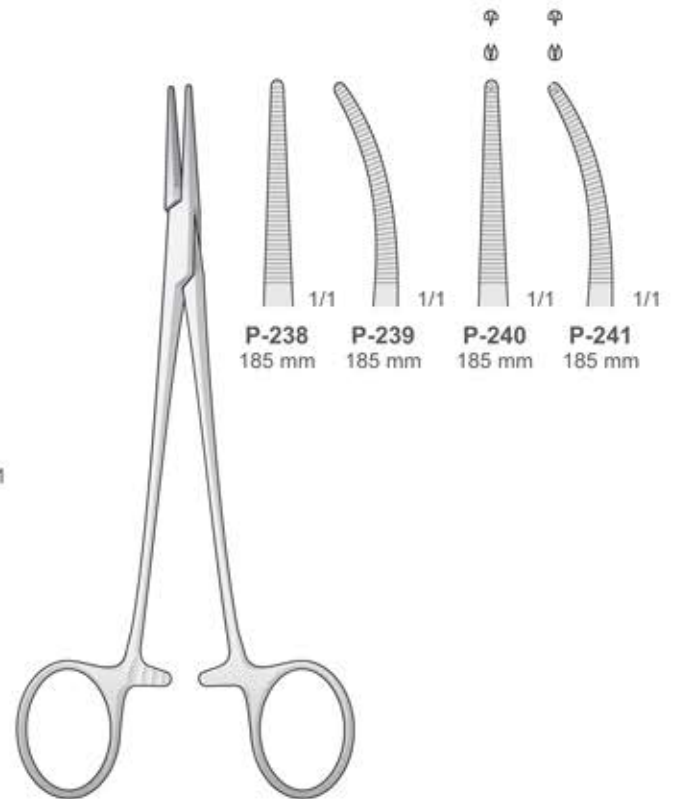

HALSTED
 P-238/P-241
 185 mm

Gewebefasszangen
Tissue Grasping Forceps
Pinze per tessuti
Pinzas para tejidos
Pincas pour tissus

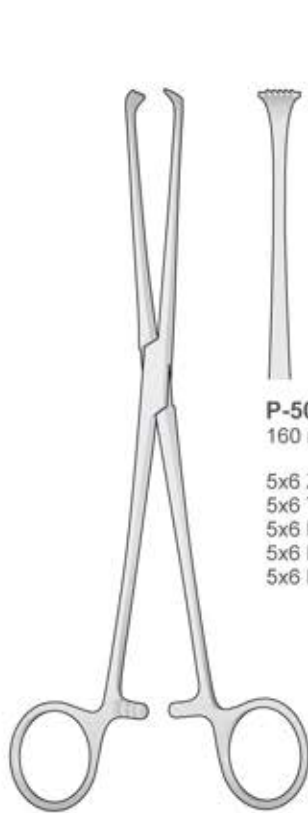

ALLIS
P-50/P-52

ATRAUMA

P-50
160 mm
5x6 Zähne
5x6 Teeth
5x6 Denti
5x6 Dientes
5x6 Dents

P-52
160 mm
5x6 Zähne
5x6 Teeth
5x6 Denti
5x6 Dientes
5x6 Dents

P-115
200 mm
5x6 Zähne
5x6 Teeth
5x6 Denti
5x6 Dientes
5x6 Dents

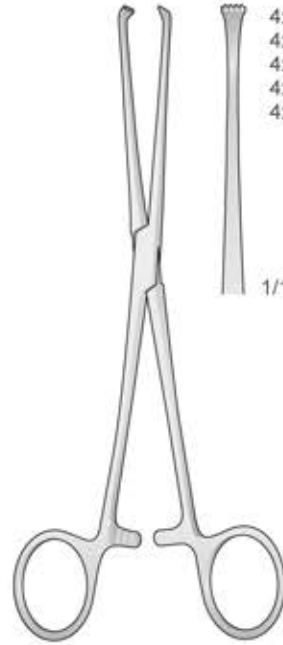

BABY-ALLIS
P-100
130 mm

4x5 Zähne
4x5 Teeth
4x5 Denti
4x5 Dientes
4x5 Dents

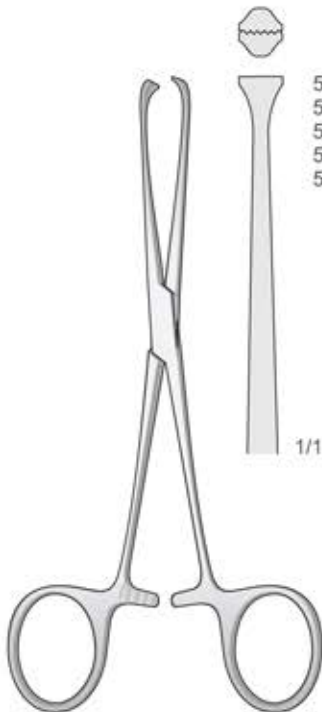

BOYS-ALLIS
P-129
150 mm

5x6 Zähne
5x6 Teeth
5x6 Denti
5x6 Dientes
5x6 Dents

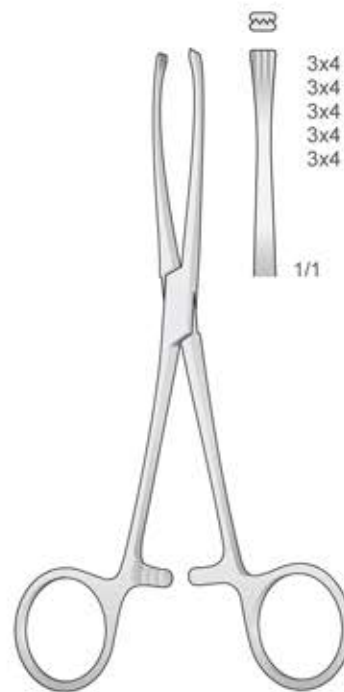

JUDD-ALLIS
P-324
155 mm

3x4 Zähne
3x4 Teeth
3x4 Denti
3x4 Dientes
3x4 Dents

H

Retractors

Retraktoren
Écarteurs
Separadores
Divaricatori

Mouth Gags | Mouth Prop

Mundsperrer
Ouvre-bouche
Abrebocas
Apribocca

Tongue Depressor

Zungendrucker
Abaisse-langue
Bajalengua
Abbassalingua



BROMED
INSTRUMENTS



Wundhaken
 Retractors
 Divaricatori
 Separadores
 Écarteurs

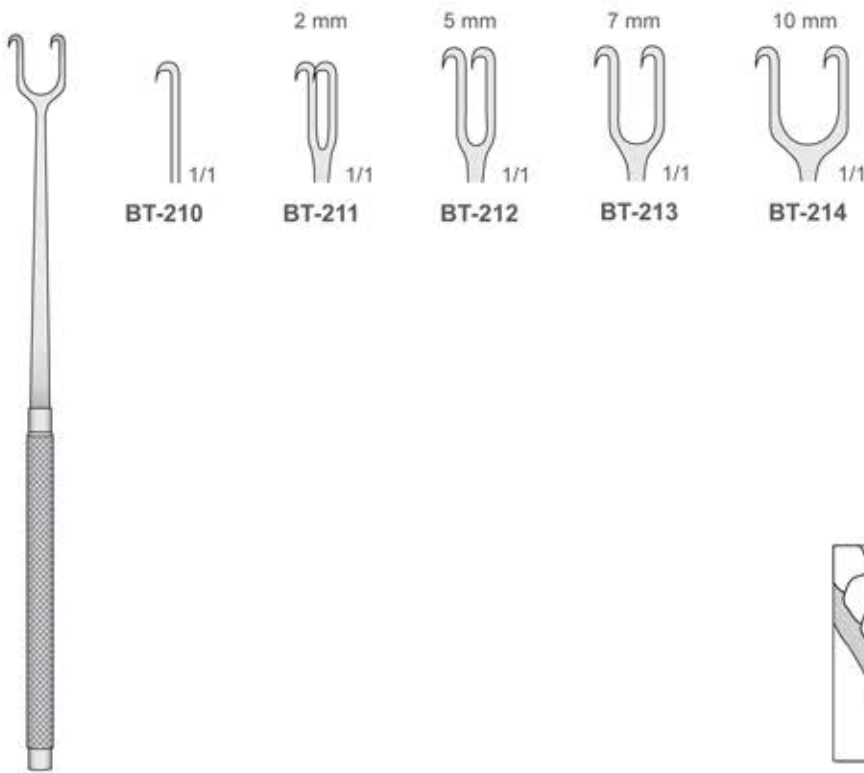

JOSEPH
BT-210/BT-214
 160 mm

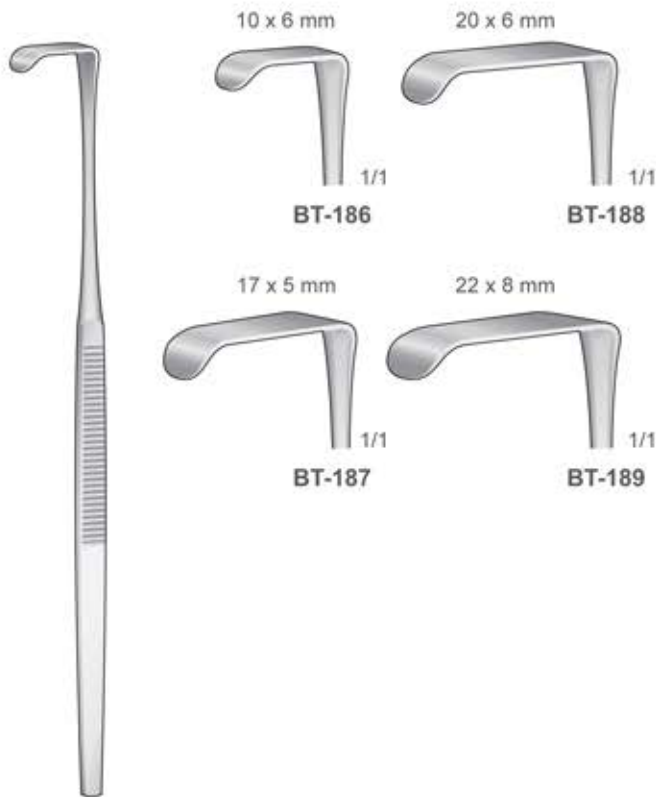

MINI-LANGENBECK
BT-186/BT-189
 160 mm

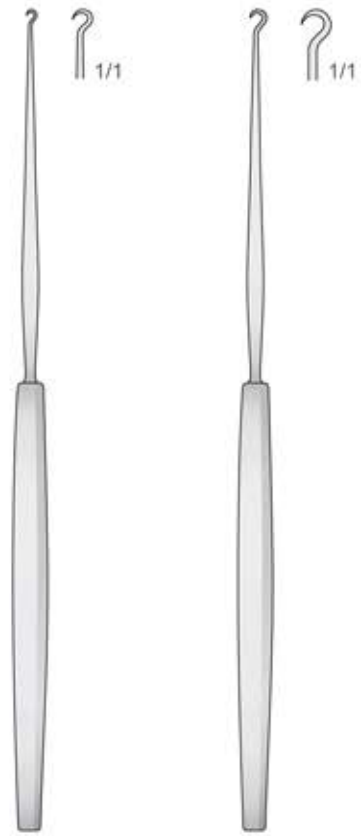

GILLIES
BT-15
 180 mm

GILLIES
BT-16
 180 mm



Wundhaken
Retractors
Divaricatori
Separadores
Écarteurs

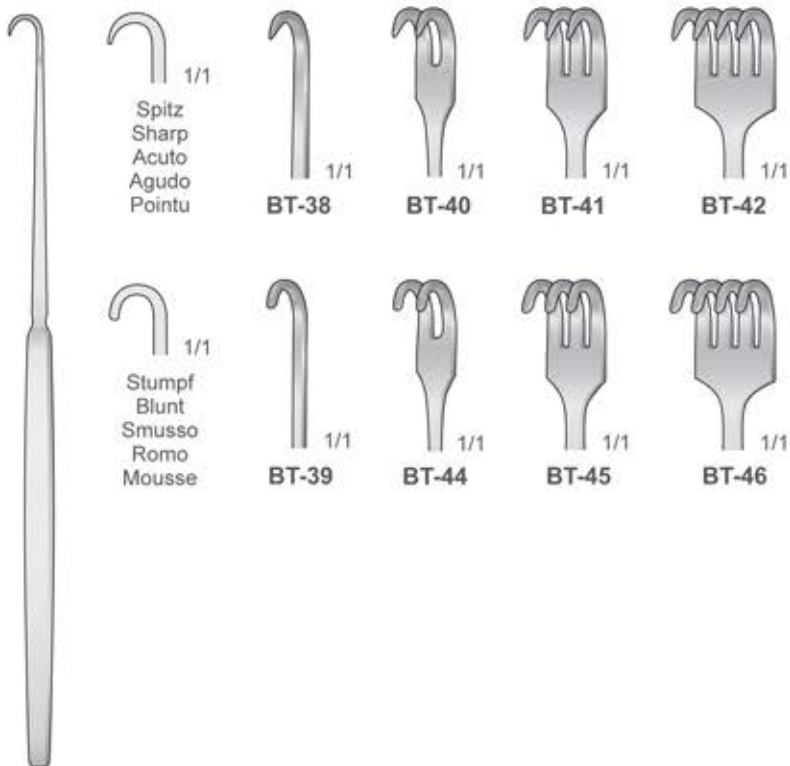

Spitz
Sharp
Acuto
Agudo
Pointu

Stumpf
Blunt
Smusso
Romo
Mousse

BT-38

BT-40

BT-41

BT-42

BT-39

BT-44

BT-45

BT-46

BT-38/BT-46

160 mm

Feine wundhaken flexibel-spitz
Delicate retractors flexible-sharp
Divaricatori delicati flessibili-acuti
Separadores finos flexibles-agudos
Écarteurs fins pointu flexible

Feine wundhaken flexibel-stumpf
Delicate retractors flexible-blunt
Divaricatori delicati flessibili-smussi
Separadores finos flexibles-romos
Écarteurs fins mousse flexible



BT-50
150 mm

BT-51
150 mm

BT-52
150 mm

BT-54
150 mm

BT-55
150 mm

BT-56
150 mm



Wundhaken
 Retractors
 Divaricatori
 Separadores
 Écarteurs

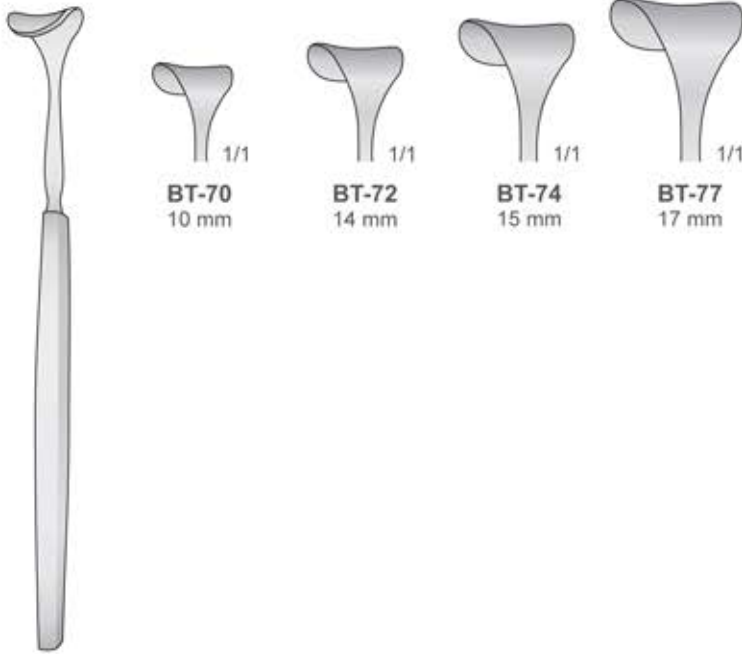

BT-70
10 mm

BT-72
14 mm

BT-74
15 mm

BT-77
17 mm

DESMARRES
BT-70/BT-77
140 mm

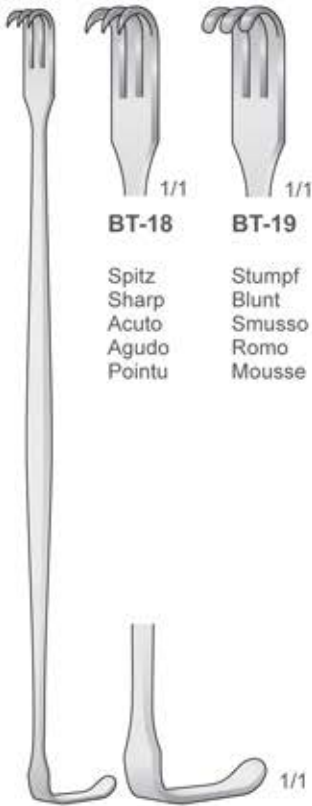

BT-18

Spitz
 Sharp
 Acuto
 Agudo
 Pointu

BT-19

Stumpf
 Blunt
 Smusso
 Romo
 Mousse

SEAN-MILLER
BT-18/BT-19
160 mm



BT-117
19 x 12 mm

BT-118
21 x 14 mm

KOCHER
BT-117/BT-118
205 mm

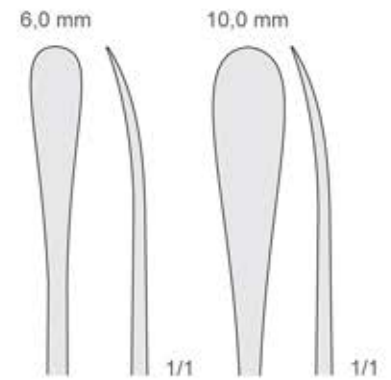

6,0 mm

10,0 mm

HURD
BT-1/BT-2
220 mm

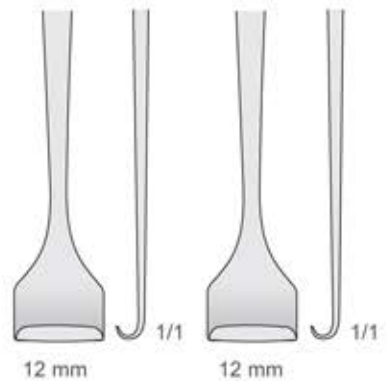

12 mm

12 mm



Wundhaken
Retractors
Divaricatori
Separadores
Écarteurs



BT-48
10 x 6 mm

BT-49
20 x 6 mm

SENN GREEN
BT-48/BT-49
160 mm

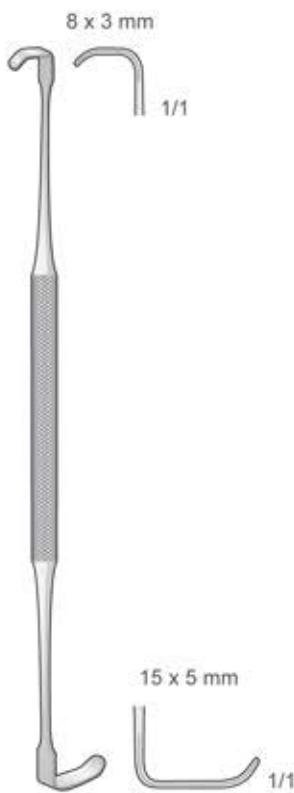

RAGNELL
BT-27
140 mm

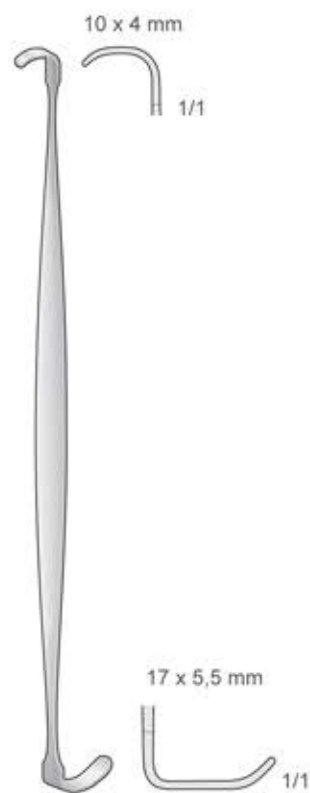

RAGNELL-DAVIS
BT-26
140 mm



Spitz
Sharp
Acuto
Agudo
Pointu

KOCHER
BT-139
205 mm



Stumpf
Blunt
Smusso
Romo
Mousse

KOCHER
BT-140
220 mm



LAHEY
BT-109
195 mm

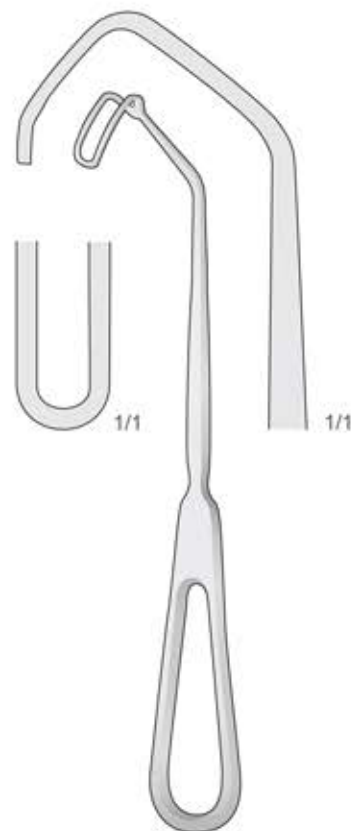

CUSHING
BT-29
200 mm



Wundhaken
 Retractors
 Divaricatori
 Separadores
 Écarteurs

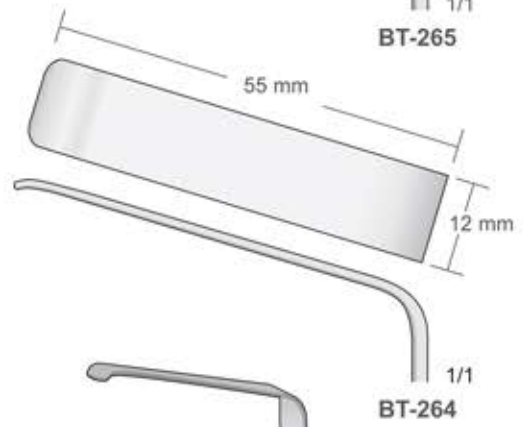
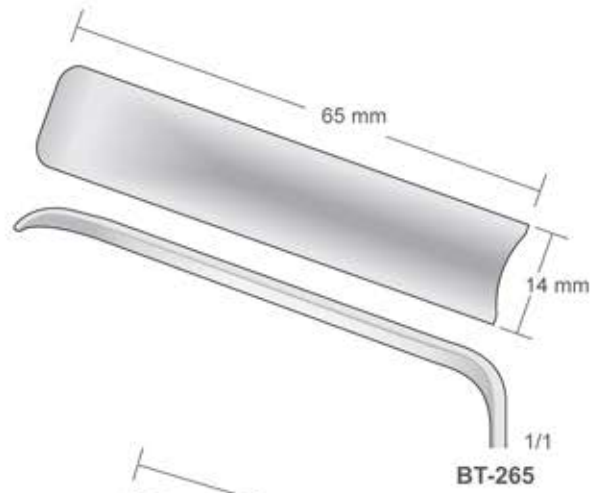

DOCKHORN
BT-134/BT-135
 210 mm



BT-264/BT-265
 235 mm

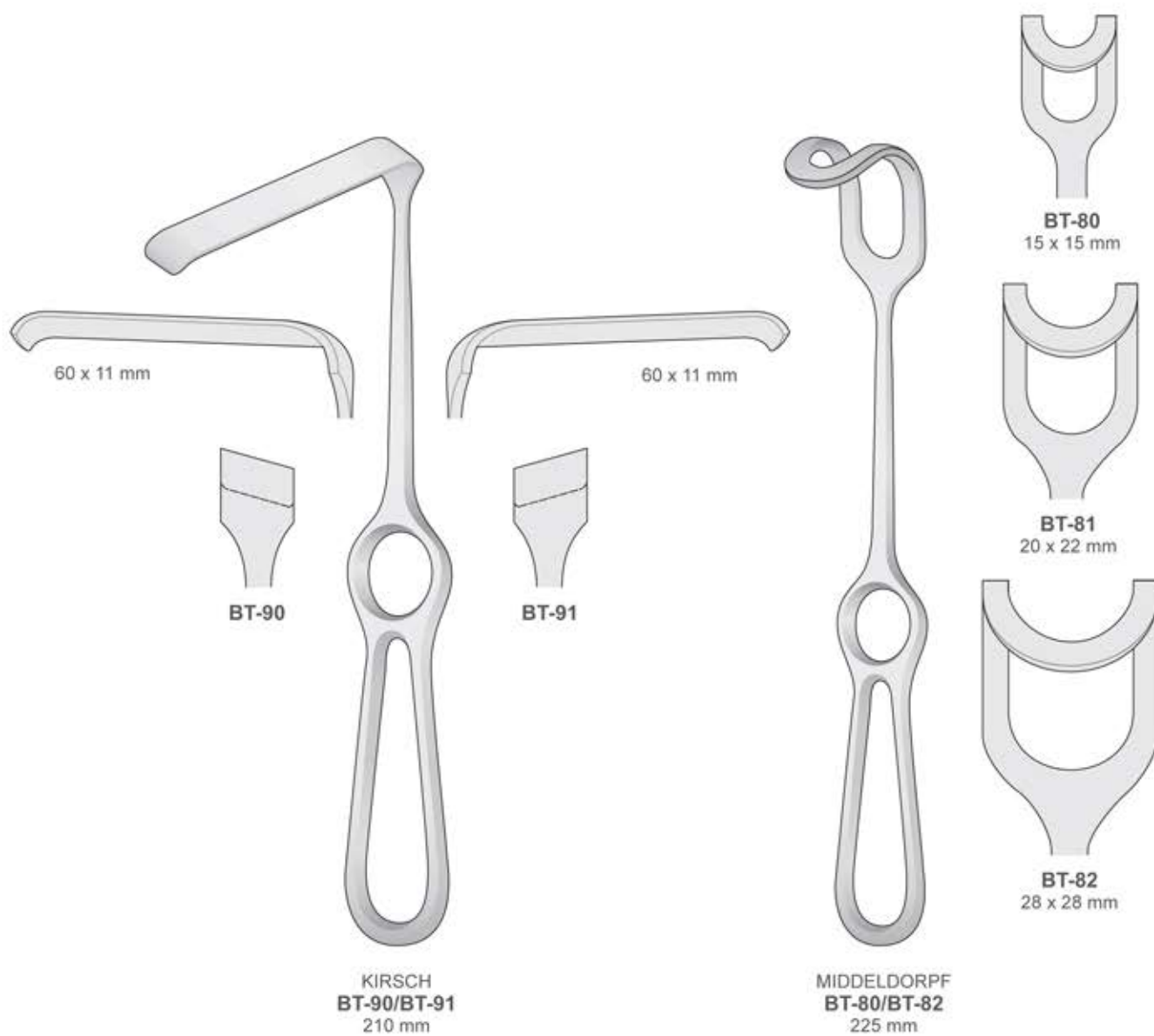



Wundhaken
 Retractors
 Divaricatori
 Separadores
 Écarteurs



OBWEGESER
BT-152/BT-157
 220 mm



OBWEGESER
BT-92/BT-100
 220 mm



BT-152
 25 x 7 mm

1/1



BT-153
 31 x 10 mm

1/1

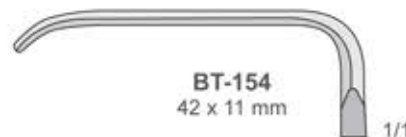

BT-154
 42 x 11 mm

1/1



BT-155
 55 x 12 mm

1/1



BT-156
 70 x 14 mm

1/1



BT-157
 80 x 16 mm

1/1



BT-92
 25 x 7 mm

1/1



BT-93
 31 x 10 mm

1/1



BT-94
 42 x 11 mm

1/1



BT-95
 55 x 12 mm

1/1



BT-96
 70 x 14 mm

1/1



BT-100
 80 x 16 mm

1/1



Wundhaken
Retractors
Divaricatori
Separadores
Écarteurs



BOWLED-HENRY
DO-175
170 mm

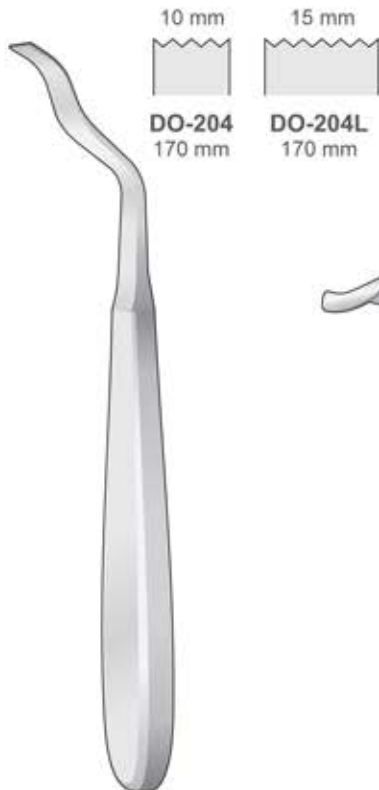

DO-204/DO-204L
170 mm



AUSTIN
DO-212
140 mm



LANGENBECK
BT-33/BT-43
210 mm

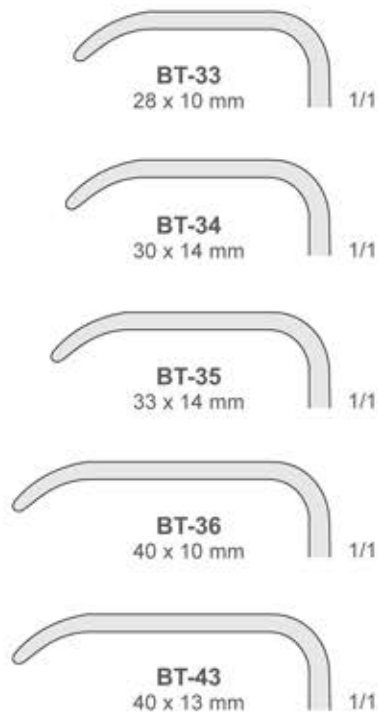

KOCHER-LANGENBECK
BT-60/BT-260
215 mm

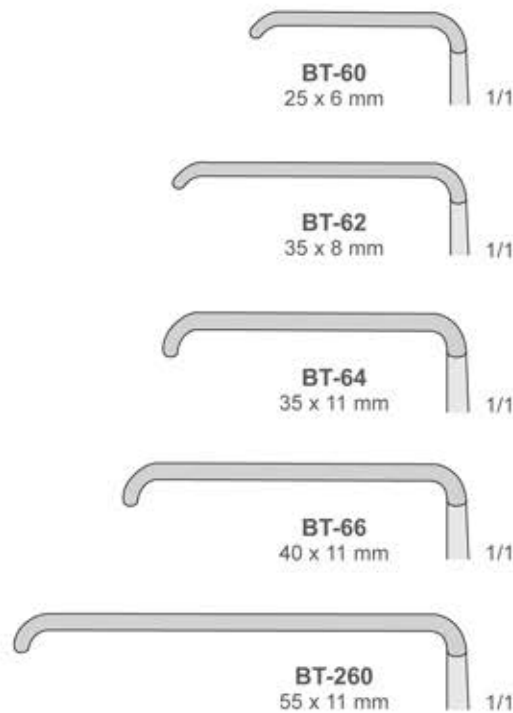



Wundhaken
 Retractors
 Divaricatori
 Separadores
 Écarteurs

Rostfrei - Stainless Steel
 Acciaio - Acero - Acer

Biegsam - Malleable
 Malleabili - Maleables
 Souples

OM-85
 Komplettsset mit 3 Spatel
 Set complete with 3 spatulas
 Set completo con 3 spatole
 Set completos con 3 espátulas
 Set complete avec 3 spatules
OM-80 + OM-81 + OM-82

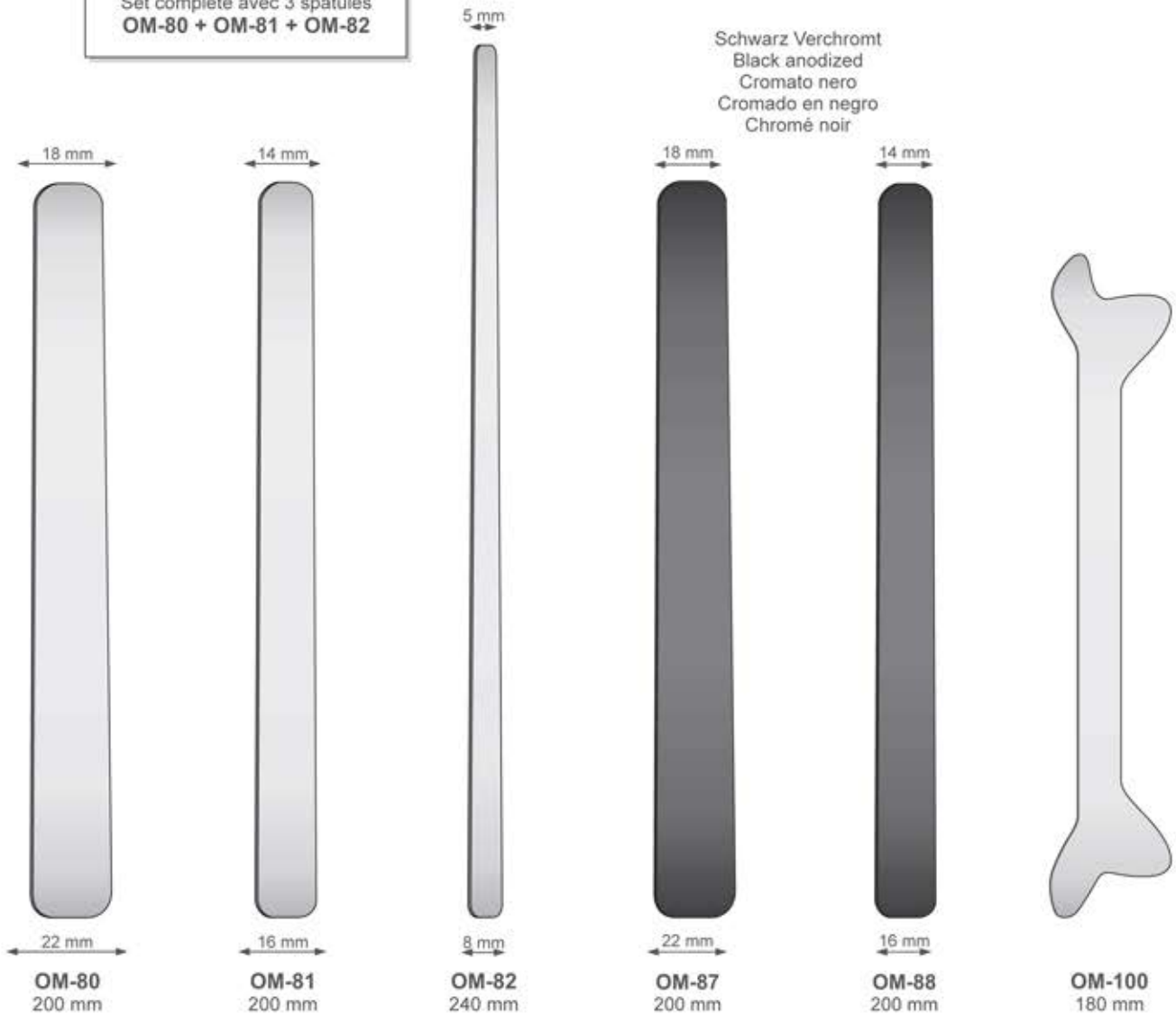



Zungendrucker
Tongue Depressors
Abbassalingua
Bajalengua
Abaisse langue

Kinnhalter
Chin Holder
Divaricatore per mento
Separador para mentón
Écarteur pour menton

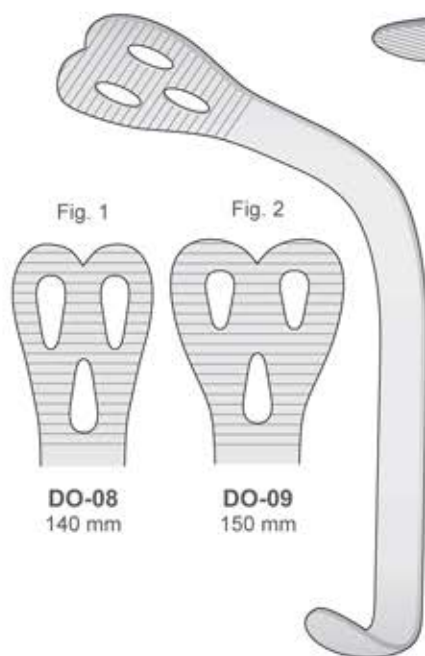
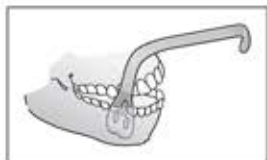

Fig. 1

Fig. 2

DO-08
140 mm

DO-09
150 mm

WIEDER
DO-08/DO-09

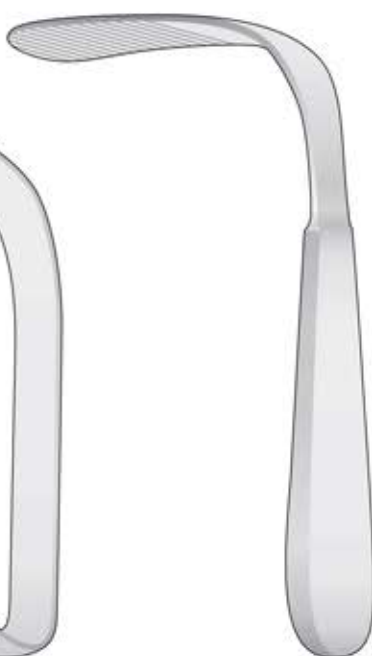

TOBOLD
OM-08
145 mm



HARTMANN
OM-06
150 mm



OBWEGESER
DO-40
155 mm



Wundhaken
 Retractors
 Divaricatori
 Separadores
 Écarteurs

Ramushaken für Spina Nasalis
 Ramus Retractor for nasal spine
 Divaricatori per spina nasalis
 Separadores para spina nasalis
 Écarteurs pour spina nasalis



OBWEGESER
BT-67
 220 mm

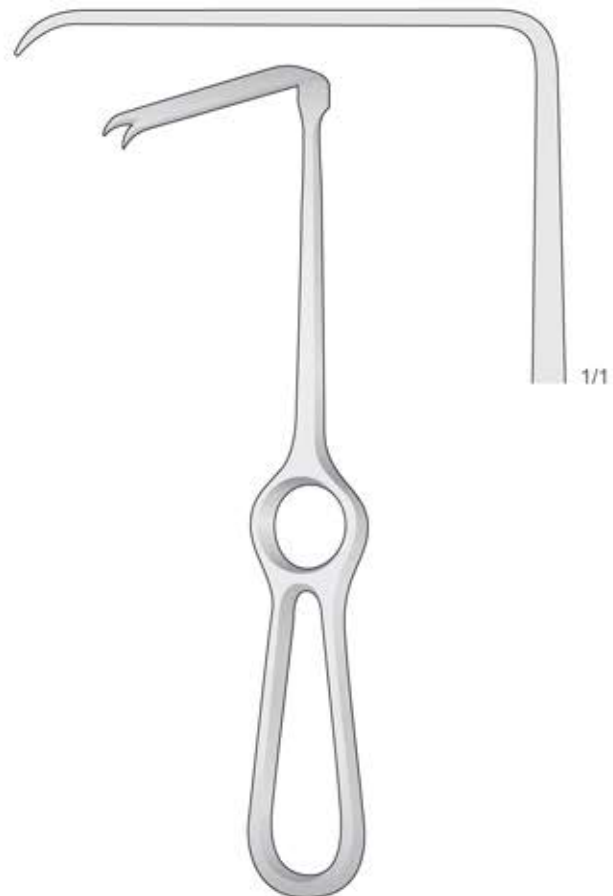

OBWEGESER
BT-68
 220 mm



Mundsperrer
Mouth gags
Apribocca
Abreboocas
Écarteur buccal



Paar Einsätze aus Silikon für:
Pair of silicone inserts for:
Coppia di inserti in silicone per:
Pareja de inserto de silicone para:
Paire de inserts en silicon pour:

OM-40 - OM-41

Ø 8 mm



OM-40R
30 mm

Ø 11 mm



OM-41R
30 mm



HEISTER
OM-62
135 mm

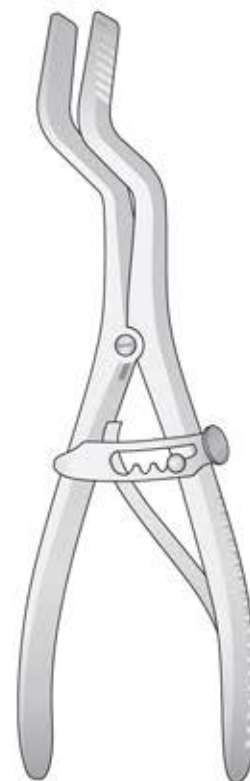

ROSER KÖNIG
OM-60
185 mm

Für Erwachsene - For adults
Per adulti - Para adultos
Pour adultes

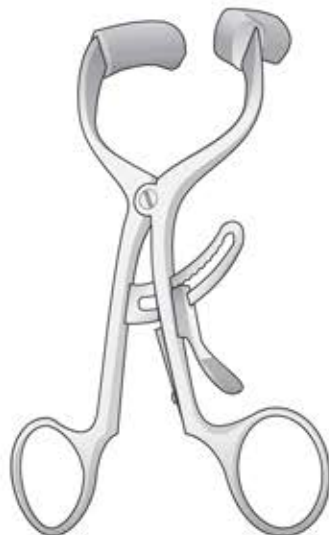

MOLT
DOYEN-JANSEN
OM-41
140 mm

Für Erwachsene - For adults
Per adulti - Para adultos
Pour adultes

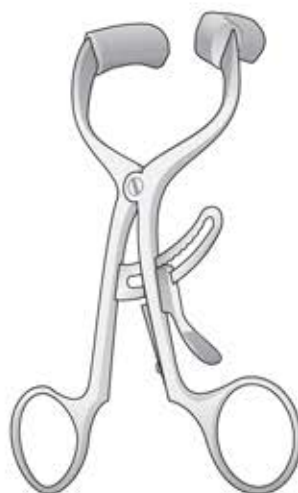

MOLT
DOYEN-COLLIN
OM-40
120 mm

Für Kinder
For children
Per bambini
Para niños
Pour enfants

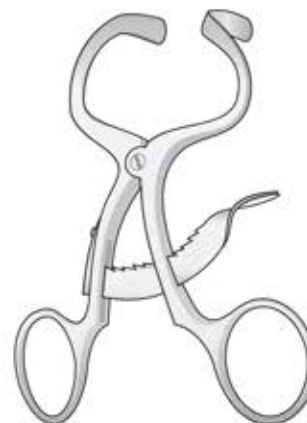

MOLT
OM-42
100 mm



BT-283
Set completo
Set complete
Komplettset
Set complet
Set completo
BT-284 + BT-285 + BT-286

29 mm
26 mm
22 mm

28 mm
38 mm
44 mm



**ROUX
BT-283**
165 mm



**ROUX
BT-284**
20x22 mm
25x28 mm



**ROUX
BT-285**
23x26 mm
29x38 mm



**ROUX
BT-286**
29x29 mm
34x44 mm

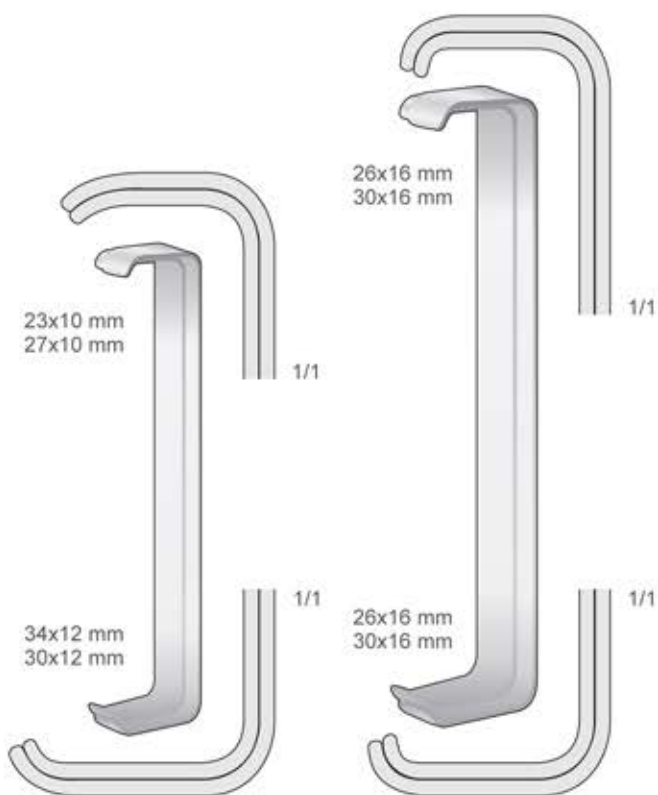

23x10 mm
27x10 mm

26x16 mm
30x16 mm

34x12 mm
30x12 mm

26x16 mm
30x16 mm

**FARABEUF
BT-20**
120 mm

**FARABEUF
BT-25**
150 mm

20x22 mm



**ROUX-MAGNUS
BT-287**
150 mm

23x26 mm



**ROUX-MAGNUS
BT-288**
160 mm

29x29 mm



**ROUX-MAGNUS
BT-289**
170 mm



Wangenhalter
 Cheek Retractors
 Divaricatori per guance
 Separador para mejillas
 Écarteurs des joues

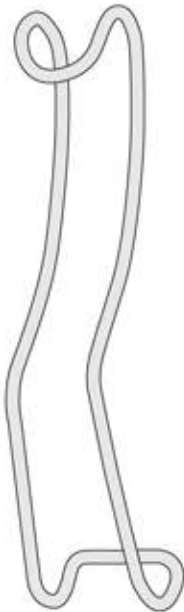

STERNBERG
OM-50
 160 mm

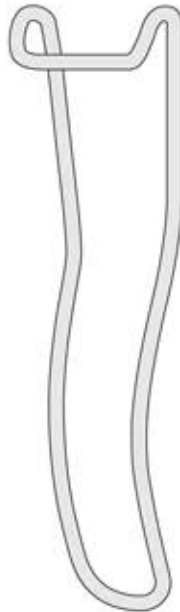

STERNBERG
OM-52
 160 mm

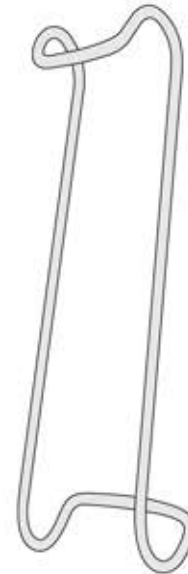

COLUMBIA
OM-67
 140 mm

Schwarz Verchromt
 Black anodized
 Cromato nero
 Cromado en negro
 Chromé noir

**NEW
 BLACK**



BISHOP
OM-61
 130 mm



MINNESOTA
OM-55
 140 mm



CAWOOD-MINNESOTA
OM-66
 160 mm



MINNESOTA
OM-55B
 140 mm



CAWOOD-MINNESOTA
OM-66B
 160 mm



Ramus Retraktoren Recht
Ramus Retractor Right
Retrattore Ramus destro
Separadores Ramus derecho
Écarteur Ramus droites

Ramus Retraktoren Link
Ramus Retractor Left
Retrattore Ramus sinistro
Separadores Ramus izquierdo
Écarteur Ramus gauches

8 mm



OBWEGESER
DO-41
165 mm

10 mm

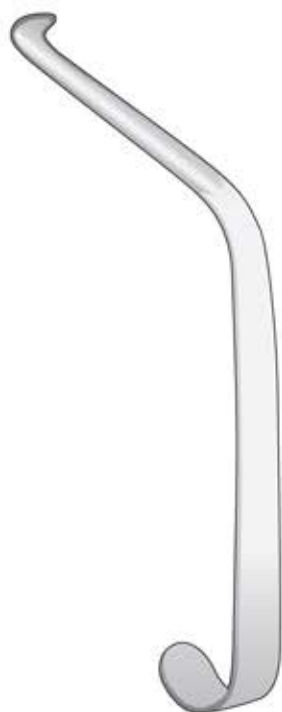

OBWEGESER
DO-142
165 mm



MISCH
BT-158
210 mm



MISCH
BT-159
210 mm

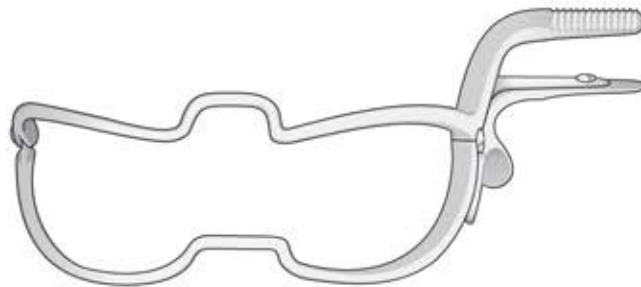

Mundsperrer
 Mouth Gags
 Apribocca
 Abrebocas
 Écarteur buccal

WHITEHEAD-JENNINGS

- OM-136** 90 mm
- OM-137** 110 mm
- OM-138** 130 mm
- OM-139** 150 mm

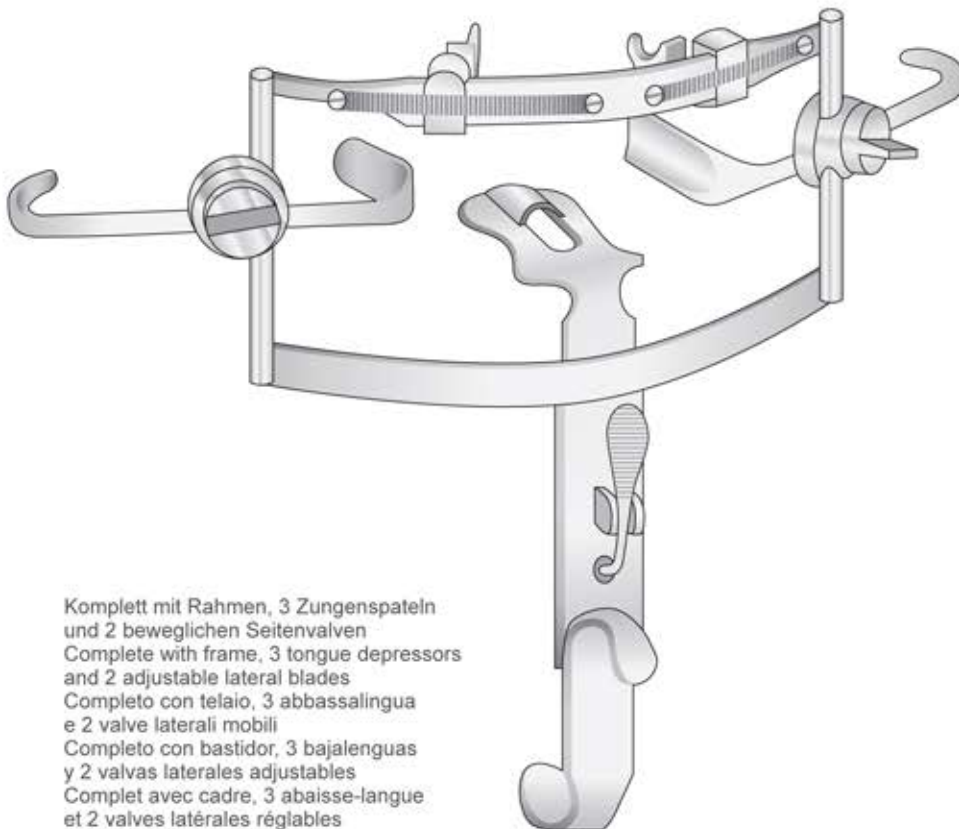

Komplett mit Rahmen, 3 Zungenspateln
 und 2 beweglichen Seitenvalven
 Complete with frame, 3 tongue depressors
 and 2 adjustable lateral blades
 Completo con telaio, 3 abbassalingua
 e 2 valve laterali mobili
 Completo con bastidor, 3 bajalenguas
 y 2 valvas laterales ajustables
 Complet avec cadre, 3 abaisse-langue
 et 2 valves latérales réglables

DINGMANN
OM-110
 Set completo

DINGMANN

Zungenspatel
 Tongue depressor
 Abbassalingua
 Bajalengua
 Abaisse langue

Fig. 1



OM-112
 65 x 25 mm

Fig. 2

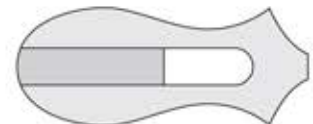

OM-113
 70 x 29 mm

Fig. 3

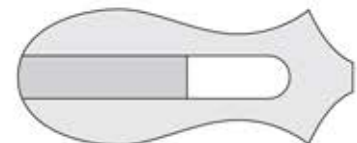

OM-114
 80 x 32 mm

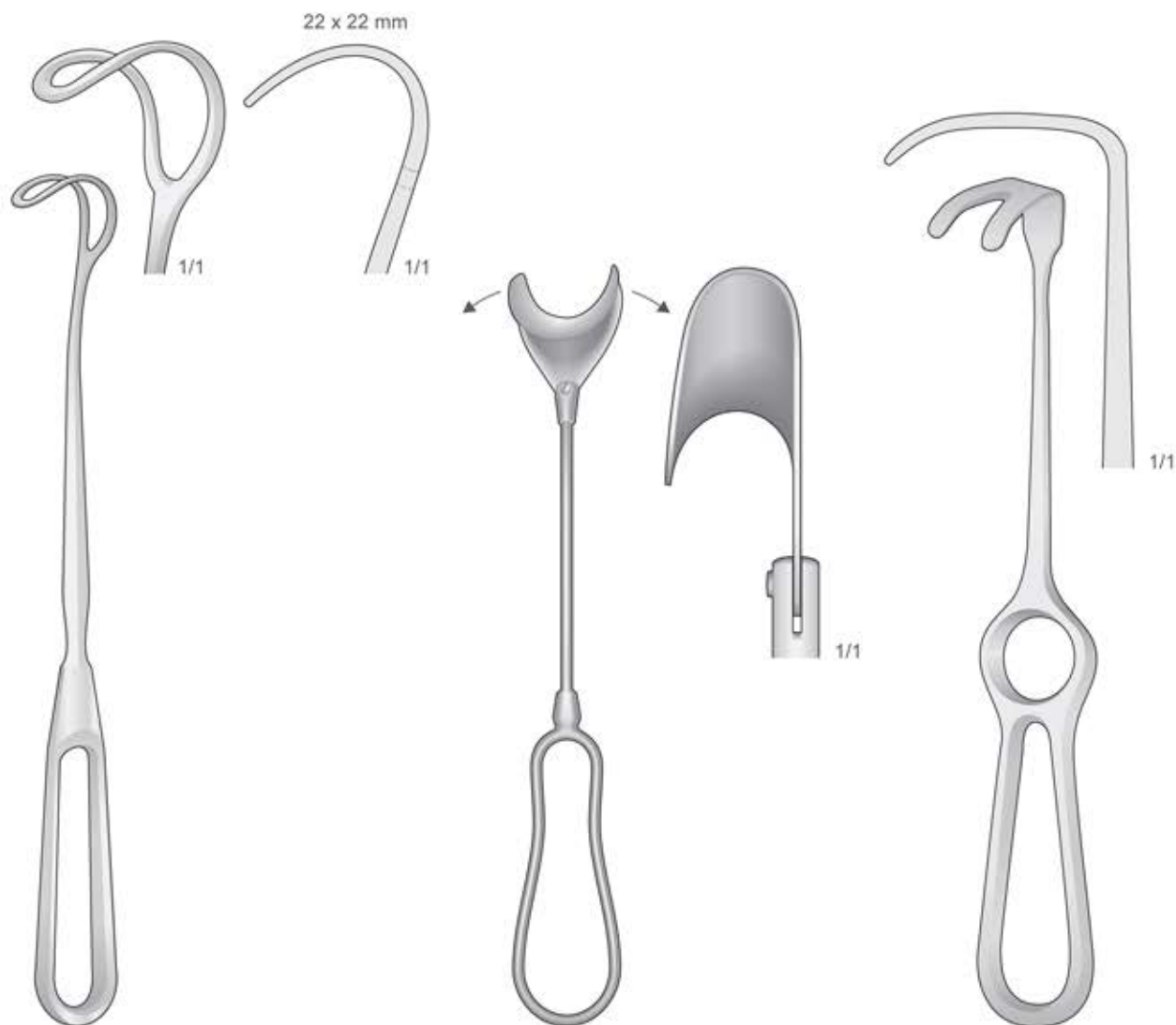

GREENE
BT-131
225 mm

BT-132
200 mm

WASSMUND
BT-69
220 mm



Zungenspatel - Zungenzangen
 Tongue Depressors - Tongue Holding Forceps
 Abbassalingua - Pinze tiralingua
 Bajalenguas - Pinzas tira-lengua
 Abaisse langues - Pincés tire-langue



OM-07
145 mm



KROENIG
OM-16
150 mm



BUCHWALD
OM-18
180 mm

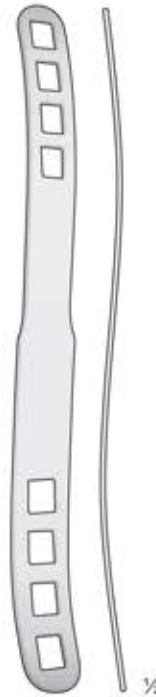

BRUENINGS
OM-04
190 mm

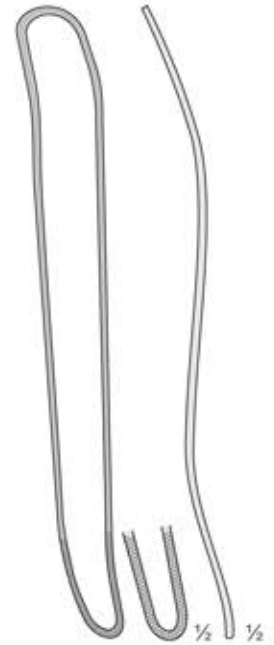

FRENZEL
OM-19
165 mm

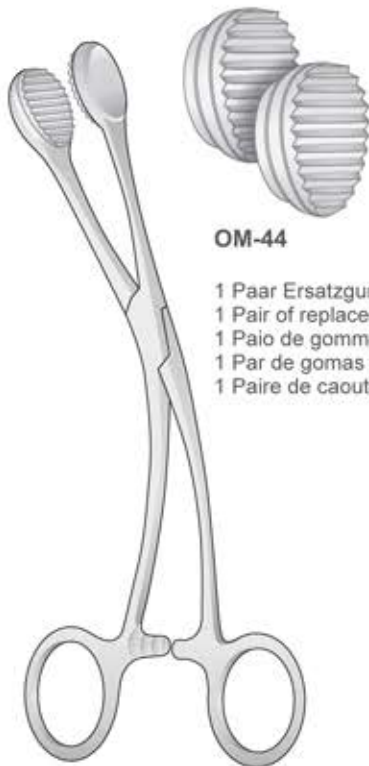

YOUNG
OM-45
160 mm

OM-44

- 1 Paar Ersatzgummi
- 1 Pair of replacement rubber pads
- 1 Paio de gommini di ricambio
- 1 Par de gomas de recambio
- 1 Paire de caoutchouc de rechange

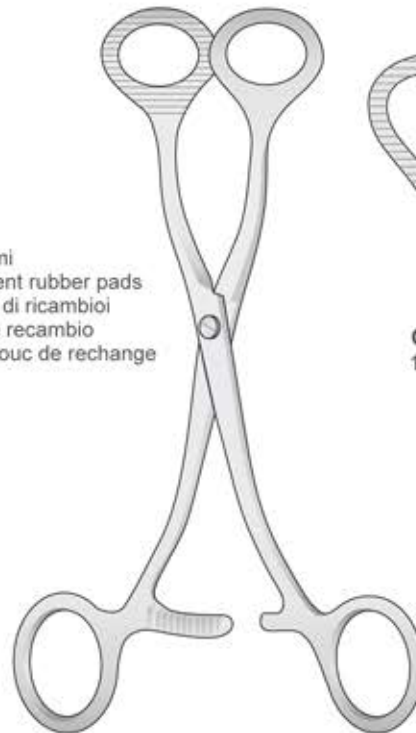

COLLIN
OM-10/OM-30



OM-30
165 mm



OM-10
170 mm



Kette und Mundstutzen
Chain and Mouth Props
Catene e Apribocca
Cadena y Abre bocas
Chaîne et Ouvre Bouche



KE-20
200 mm



KE-40
400 mm

Dampfsterilisation bis 134°C
Autoclavable to 134°C
Autoclavabile a 134°C
Autoclave hasta 134°C
Autoclavable jusqu'à 134°C

Packung mit 2 Stück
Package with 2 units
Confezione da 2 pezzi
Caja con 2 unidades
Boîte avec 2 pièces

Schwarzer Gummi
Black Rubber
Gomma nera
Caucho negro
Caoutchouc noir



OM-70
SMALL
Klein, für Kinder
Small, for children
Piccolo, per bambini
Pequeño, para niños
Petit, pour enfants



OM-71
MEDIUM
Normal, für Erwachsene
Regular, for adults
Normale, per adulti
Regular, para adultos
Regulier, pour adultes



OM-72
LARGE
Groß, für Erwachsene
Large, for adults
Grande, per adulti
Grande, para adultos
Grand, pour adultes



Implantology
Implantologie
Implantologie
Implantologia
Implantologia





Osteotome
Osteotomes
Osteotomi
Osteótomos
Ostéotomes

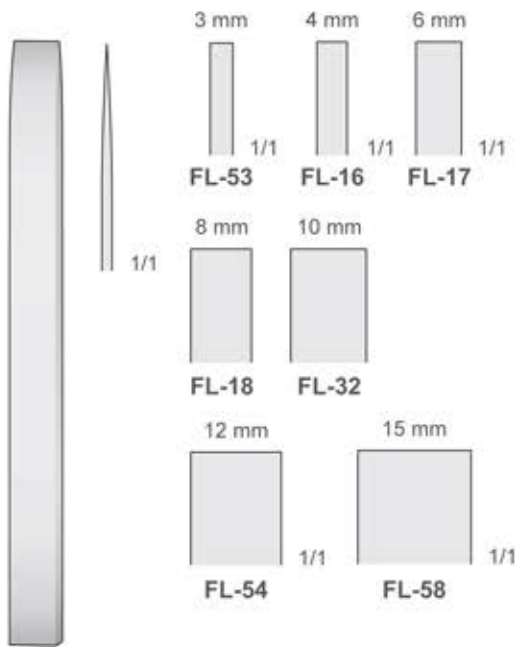

MINI-LAMBOTTE
FL-16/FL-58
125 mm



MINI-LAMBOTTE
FL-263/FL-269
170 mm

Taglio singolo

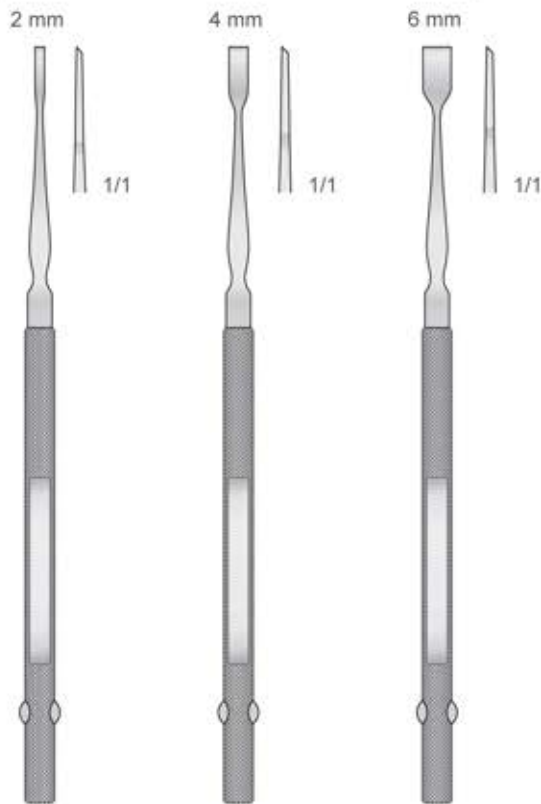

FREER
TG-10
160 mm

FREER
TG-11
160 mm

FREER
TG-12
160 mm

Taglio doppio

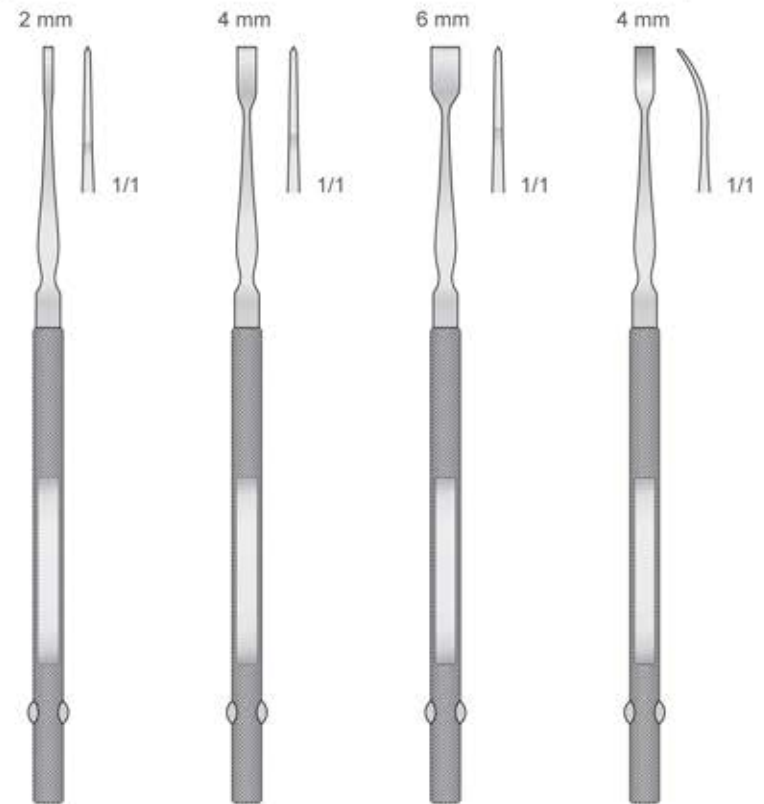

FREER
TG-20
160 mm

FREER
TG-21
160 mm

FREER
TG-22
160 mm

FREER
TG-23
160 mm



Osteotome - Meißel
Osteotomes - Gouges
Osteotomi - Sgorbie
Osteótomos - Gubias
Ostéotomes - Gouges

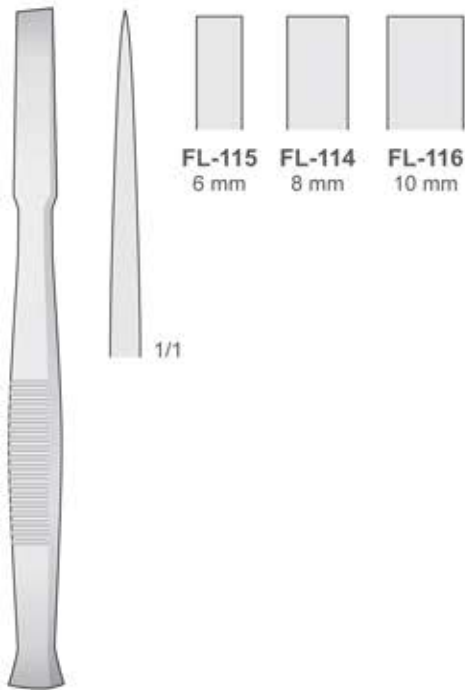

FL-115 6 mm
FL-114 8 mm
FL-116 10 mm

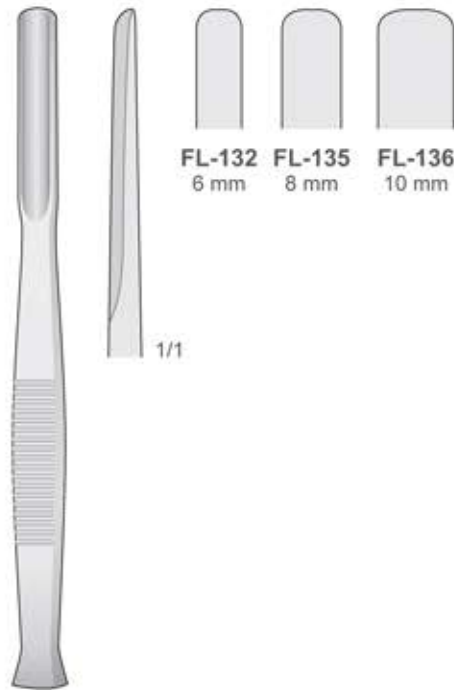

FL-132 6 mm
FL-135 8 mm
FL-136 10 mm

FL-114/FL-116
140 mm

FL-132/FL-136
140 mm

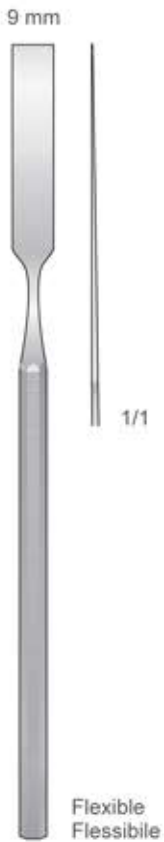

9 mm

Flexible
Flexibile

TG-15
170 mm



3 mm

TG-30
155 mm



6 mm

TG-31
155 mm



9 mm

TG-32
155 mm

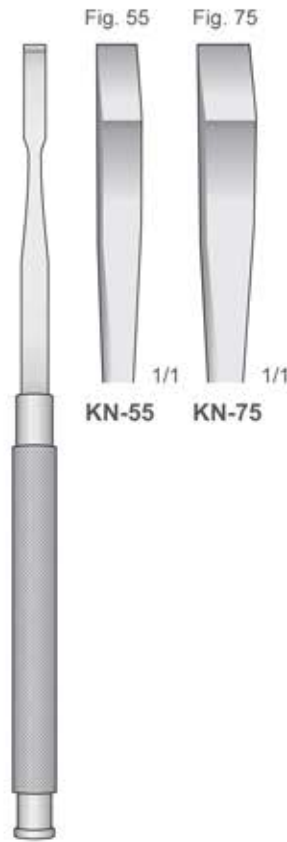

Fig. 55

Fig. 75

KN-55

KN-75

KRAMER-NEVINS
KN-55/KN-75
175 mm

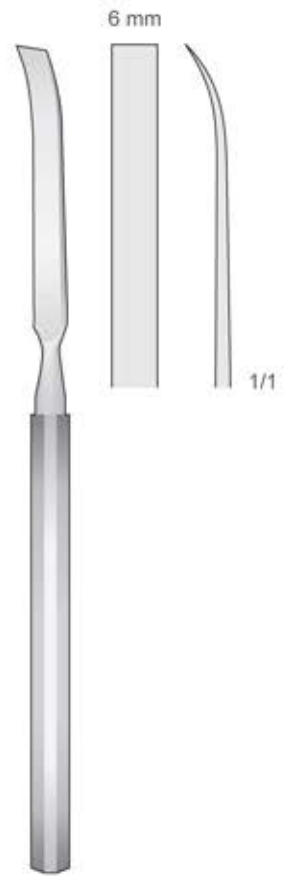

6 mm

DO-196
180 mm



Osteotome - Hohlmeissel
 Osteotomes - Gouges
 Osteotomi - Scalpelli
 Osteótomos - Cinceles
 Ostéotomes - Scalpel

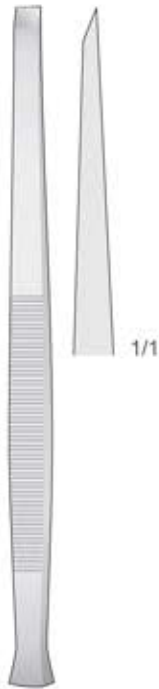

FL-13
3 mm

FL-14
4 mm

FL-15
5 mm

PARTSCH
FL-13/FL-15
140 mm

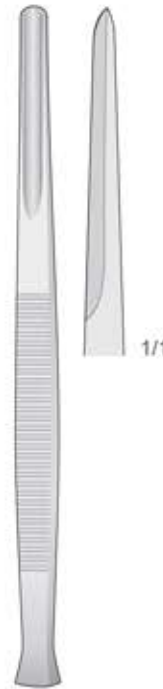

FL-03
3 mm

FL-04
4 mm

FL-05
5 mm

PARTSCH
FL-03/FL-05
140 mm

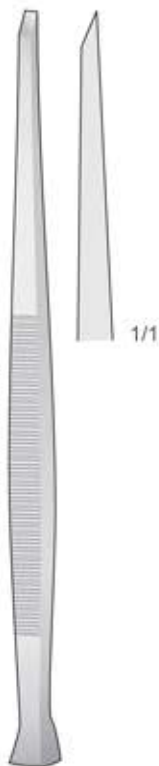

FL-177
3 mm

FL-183
6 mm

FL-179
4 mm

FL-184
7 mm

FL-181
5 mm

PARTSCH
FL-177/FL-184
170 mm

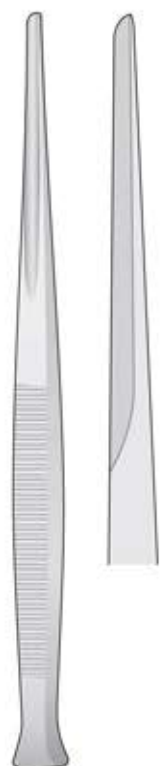

FL-185
3 mm

FL-188
6 mm

FL-186
4 mm

FL-189
7 mm

FL-187
5 mm

PARTSCH
FL-185/FL-189
170 mm



Osteotome - Meissel
 Osteotomes - Chisels
 Osteotomi - Scalpelli
 Osteótomos - Cinceles
 OSTEÓTOMES - Burins

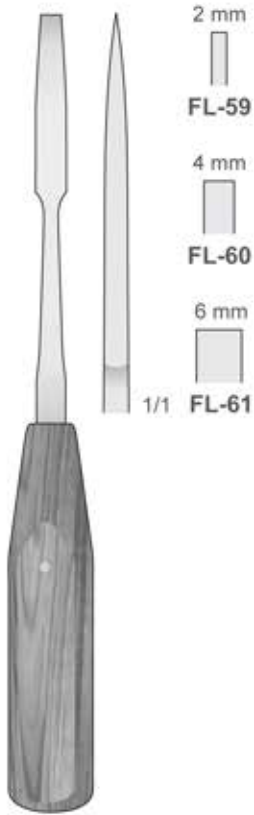

MINI-LEXER
FL-59/FL-61
 200 mm

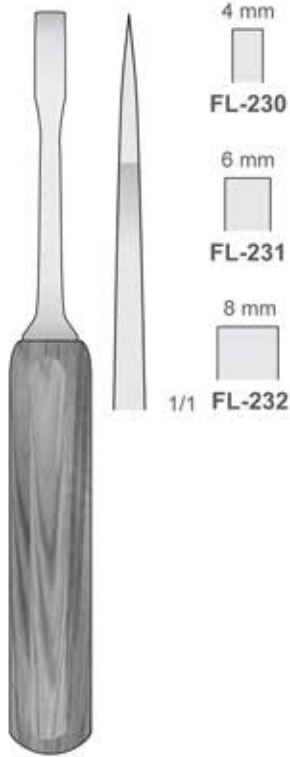

MINI-LEXER
FL-230/FL-232
 180 mm

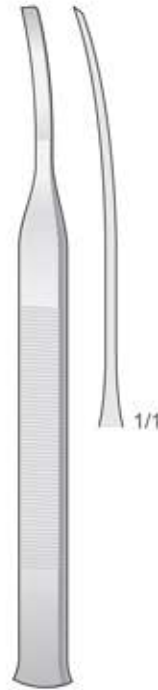

TESSIER
FL-411 5 mm
FL-412 7 mm
 160 mm

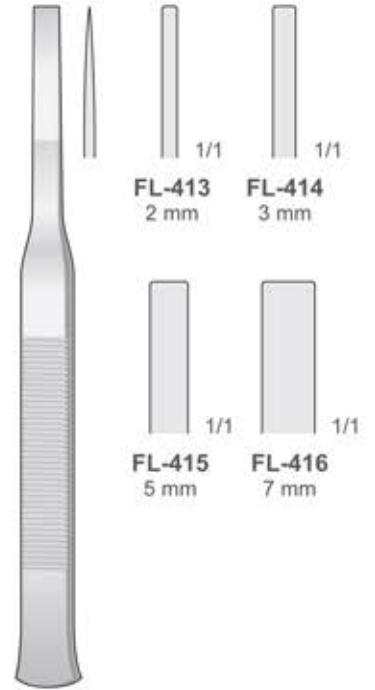

TESSIER
FL-413/FL-416
 160 mm

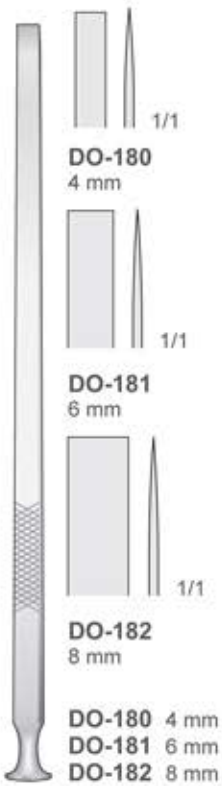

EPKER
DO-180/DO-182
 180 mm

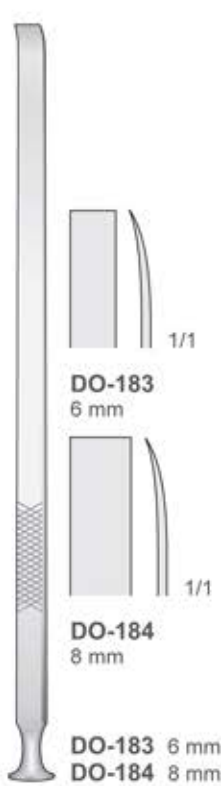

EPKER
DO-183/DO-184
 180 mm

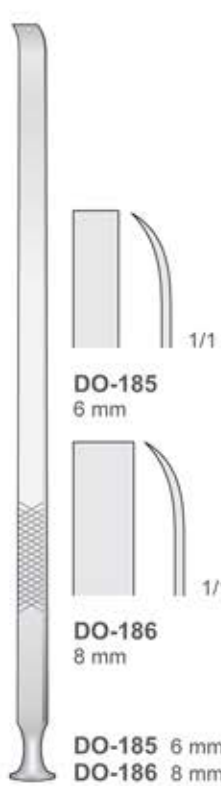

EPKER
DO-185/DO-186
 180 mm

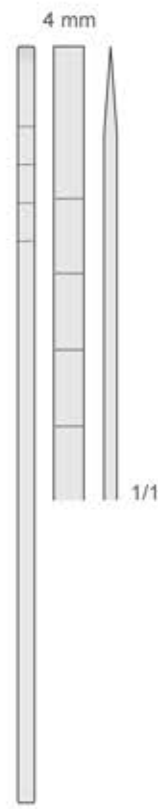

COTTLE
DO-140
 180 mm

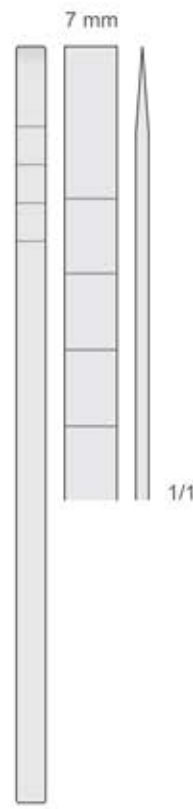

COTTLE
DO-141
 180 mm

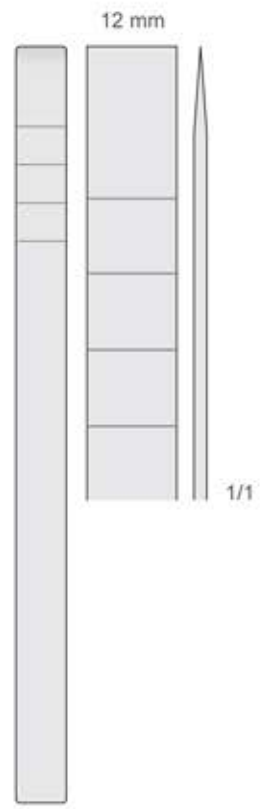

COTTLE
DO-143
 180 mm

Chirurgische Hämmer
 Surgical mallets
 Martelli chirurgici
 Martillos quirúrgicos
 Maillets chirurgicaux

Ø 20 mm - 140 g



FL-01
165 mm

Ø 25 mm - 300 g



**LUCAE
FL-10M**
190 mm

Ø 27 mm - 135 g



**HAJEK
FL-128**
200 mm

Ø 30 mm - 240 g



**COTTLE
FL-104**
185 mm

1 Seite flach - 1 Seite convex
 1 Side flat - 1 Side convex
 1 Lato piatto - 1 Lato convesso
 1 Parte plana - 1 Parte convexe
 1 Face plate - 1 Face convexe

Ø 20 mm - 160 g

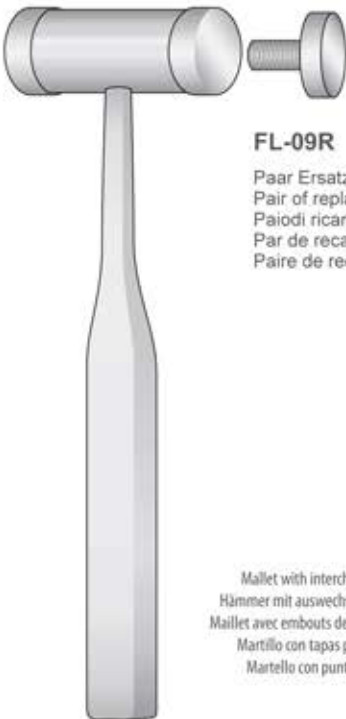

FL-09R

Paar Ersatzbacken
 Pair of replacement
 Paiodi ricambio
 Par de recambio
 Paire de rechange

Mallet with interchangeable plastic disks
 Hämmer mit auswechselbaren Kunststoffbacken
 Maillet avec embouts de plastique interchangeables
 Martillo con tapas plásticas reemplazables
 Martello con punte di ricambi in teflon

**MEAD
FL-09**
190 mm

Ø 25 mm - 200 g

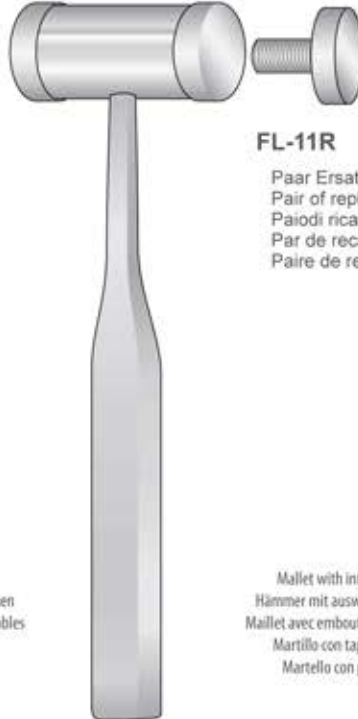

FL-11R

Paar Ersatzbacken
 Pair of replacement
 Paiodi ricambio
 Par de recambio
 Paire de rechange

Mallet with interchangeable plastic disks
 Hämmer mit auswechselbaren Kunststoffbacken
 Maillet avec embouts de plastique interchangeables
 Martillo con tapas plásticas reemplazables
 Martello con punte di ricambi in teflon

**MEAD
FL-11**
200 mm

Ø 26 mm - 320 g



FL-12R

Paar Ersatzbacken
 Pair of replacement
 Paiodi ricambio
 Par de recambio
 Paire de rechange

**MEAD
FL-12**
190 mm



Sinus Lift Retraktoren - Sinus Lift Retractors
 Divaricatori per Sinus Lift - Separadores para Sinus Lift
 Écarteurs pour Sinus Lift

Raspatorien
 Periosteals
 Scollaperiosteal
 Periostótomos
 Rugines

17 mm



**SAUTTER
 NK-249**
 145 mm

11 mm

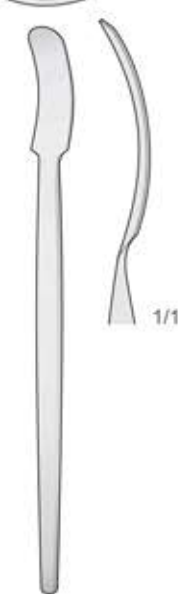

NK-105
 125 mm

9 mm

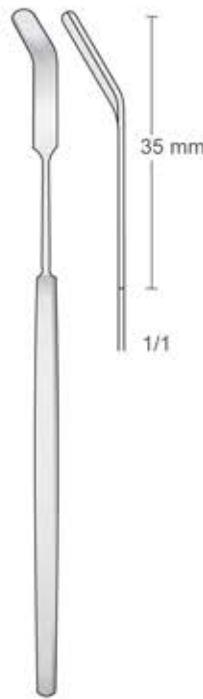

**MODELL GIESSEN
 NK-251**
 160 mm

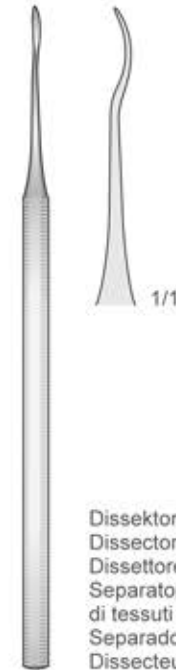

ES-13
 135 mm

Dissektor
 Dissector
 Dissettore
 Separatore
 di tessuti
 Separadores
 Dissecteur

4.5 mm



FREER
 180 mm

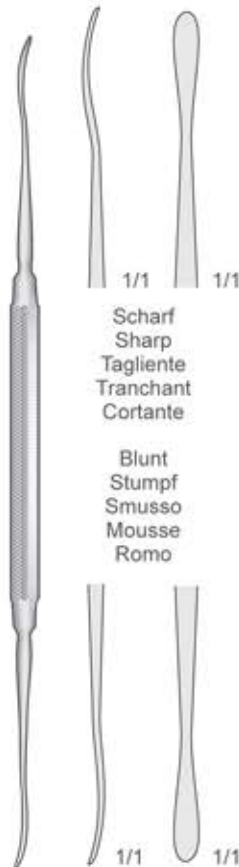

**FREER
 FR-16**
 185 mm

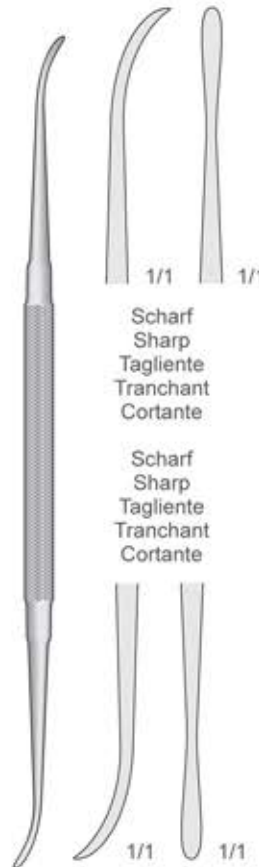

**FREER-YASARGIL
 FR-17**
 185 mm

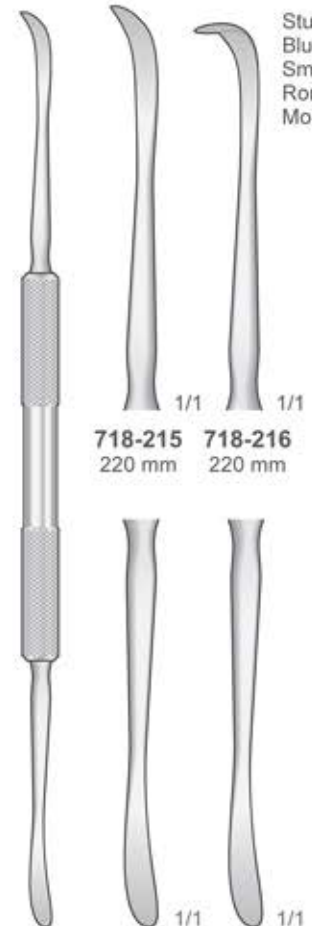

**OBWEGESER-FREER
 718-215/718-216**
 220 mm

Stumpf
 Blunt
 Smussi
 Romo
 Mousse



Trepanbohrer
 Trephines
 Trepine
 Trépanos
 Trépan

Combination Trocar-Trephine Instruments

Bestehend aus einem Trokar, einer gezahnten Trephine und einem Kolben zur Entnahme von Knochentransplantaten aus Tibia und Beckenkamm mittels eines geschlossenen Verfahrens

Consisting of trocar, a toothed trephine and a plunger for taking tibial and iliac bone grafts through a closed technique

Composto di un trequarti, una camicia dentata ed un pistone per il prelievo degli innesti ossei dalla tibia e dalla cresta iliaca tramite una tecnica chirurgica intracutanea

Compuesto por un trócar, un trépano dentado y un émbolo para obtener injertos óseos tibiales e iliacos mediante una técnica cerrada

Composé d'un trocart, d'une tréphine dentée et d'un piston pour le prélèvement de greffes osseuses de la tibia ou de la crête iliaque par une technique fermée

FK-100

Komplettset mit 4 Teilen
 Set complete with 4 pieces
 Set completo di 4 pezzi
 Set completo con 4 piezas
 Set complet avec 4 pièces



FK-101
145 mm



FK-102
163 mm

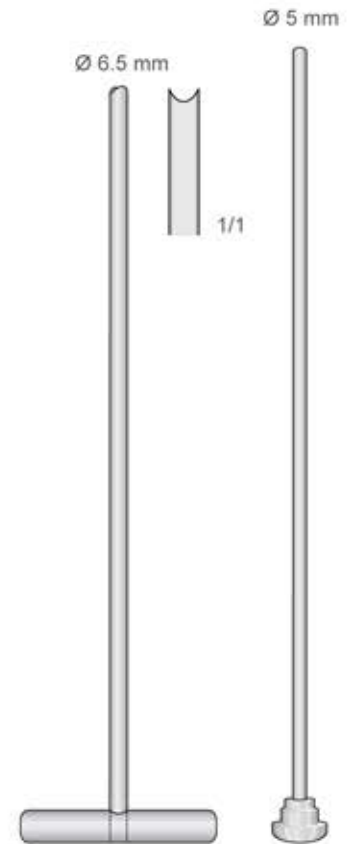

FK-103
208 mm

FK-104
220 mm

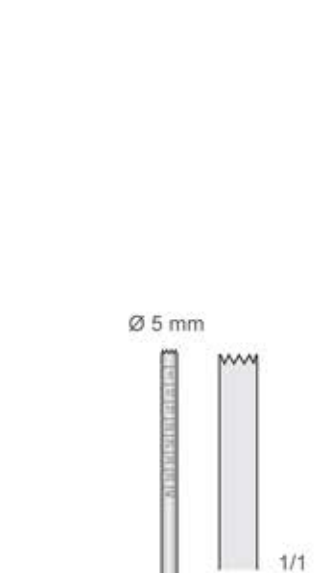

FK-106
145 mm



FK-107
163 mm

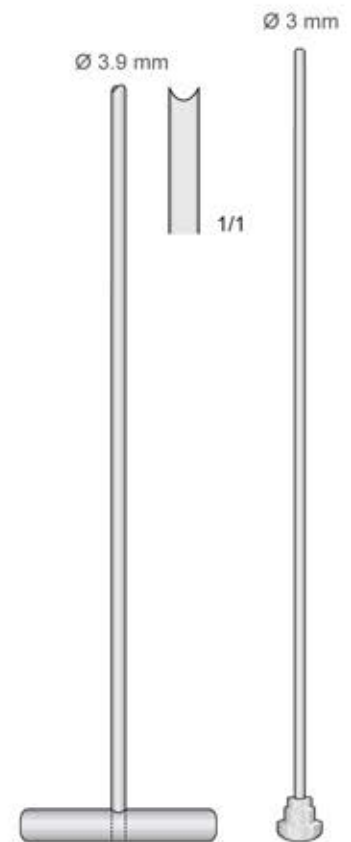

FK-108
208 mm

FK-109
220 mm

FK-105

Komplettset mit 4 Teilen
 Set complete with 4 pieces
 Set completo di 4 pezzi
 Set completo con 4 piezas
 Set complet avec 4 pièces



Implantologie Instrumente
Implantology Instruments
Strumenti per implantologia
Instrumentos para Implantología
Instruments pour Implantologie



MIR-30
130 mm



MIR-31
130 mm



MIR-32
130 mm



MIR-33
130 mm

BONE EXPANDERS

Distraktoren für Knochenleiste
Distracteurs de crête osseuse
Expansores de cresta ósea
Distrattori per cresta ossea

TUNNELING INSTRUMENTS

Tunnelierinstrumente | Instruments pour tunnellation | Instrumentos para tunelización | Strumenti per tunneling



UST-1/2ML



UST-1/2MS



UST-KPA



USS-YG7/8



UST-MP



UST-MPA

Osteotome
 Osteotomes
 Osteotomi
 Osteótomos
 Ostéotomes

FL-400
IMPLANT SINUS LIFT OSTEOTOMES SET
 FL-391 + FL-392 + FL-393 + FL-394 + FL-395 + FL-396 + FL-397 + FL-398 + FL-399
 (1 + 2 + 3 + 4 + 5 + 6 + 7 + 8 + 9)
 + BS-60 (Stainless Steel Container)



FL-400M
COMPLETE IMPLANT SINUS LIFT OSTEOTOMES SET
 FL-389 + FL-390 + FL-391 + FL-392 + FL-393 + FL-394 + FL-395 + FL-396 + FL-397 + FL-398 + FL-399
 (00 + 0 + 1 + 2 + 3 + 4 + 5 + 6 + 7 + 8 + 9)
 + BS-60 (Stainless Steel Container)

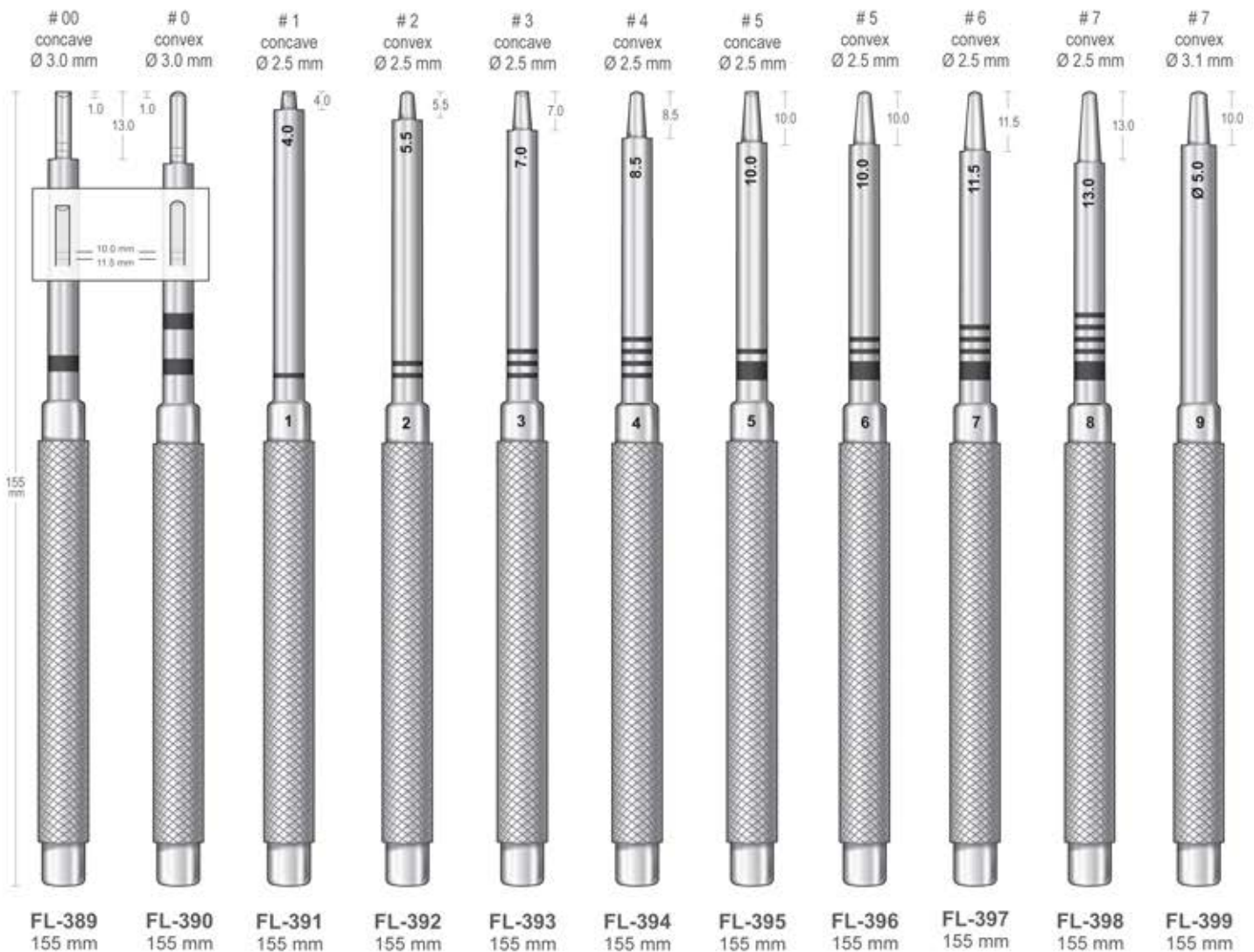



Osteotome
Osteotomes
Osteotomi
Osteótomos
Ostéotomes

# 1	Diam.
0	Ø 1.60
7.5	Ø 1.80
10	Ø 2.00
13.5	Ø 2.40
15.5	Ø 3.60

# 2	Diam.
0	Ø 1.90
7.5	Ø 2.20
10	Ø 2.35
13.5	Ø 3.30
15.5	Ø 3.40
23.5	Ø 4.50

# 3	Diam.
0	Ø 2.80
7.5	Ø 3.20
10.5	Ø 3.35
13.5	Ø 3.60
21	Ø 4.40

# 4	Diam.
0	Ø 3.10
7.5	Ø 3.70
10.5	Ø 3.90
15.5	Ø 4.30

# 5	Diam.
0	Ø 3.90
10	Ø 5.00
13	Ø 5.20
20.5	Ø 6.30

# 6	Diam.
0	Ø 5.50
10	Ø 6.20
13	Ø 6.30

1
Ø 1.6 mm



FL-120
155 mm

2
Ø 1.9 mm



FL-121
155 mm

3
Ø 2.8 mm



FL-122
155 mm

4
Ø 3.10 mm



FL-123
155 mm

5
Ø 3.90 mm



FL-124
155 mm

6
Ø 5.50 mm



FL-125
155 mm



Osteotome
 Osteotomes
 Osteotomi
 Osteótomos
 Ostéotomes

# 1	Diam.	# 2	Diam.	# 3	Diam.	# 4	Diam.	# 5	Diam.
0	Ø 1.50	0	Ø 2.10	0	Ø 2.60	0	Ø 3.00	0	Ø 3.50
5	Ø 1.90	5	Ø 2.60	5	Ø 3.00	5	Ø 3.50	5	Ø 3.90
8	Ø 2.20	8	Ø 2.80	8	Ø 3.30	8	Ø 3.80	8	Ø 4.20
10	Ø 2.40	10	Ø 3.00	10	Ø 3.50	10	Ø 4.00	10	Ø 4.40
12	Ø 2.60	12	Ø 3.20	12	Ø 3.70	12	Ø 4.20	12	Ø 4.60
14	Ø 2.80	14	Ø 3.40	14	Ø 3.90	14	Ø 4.40	14	Ø 4.80

Straight
 Gerade
 Droit
 Recto
 Diritto

Bone Pusher

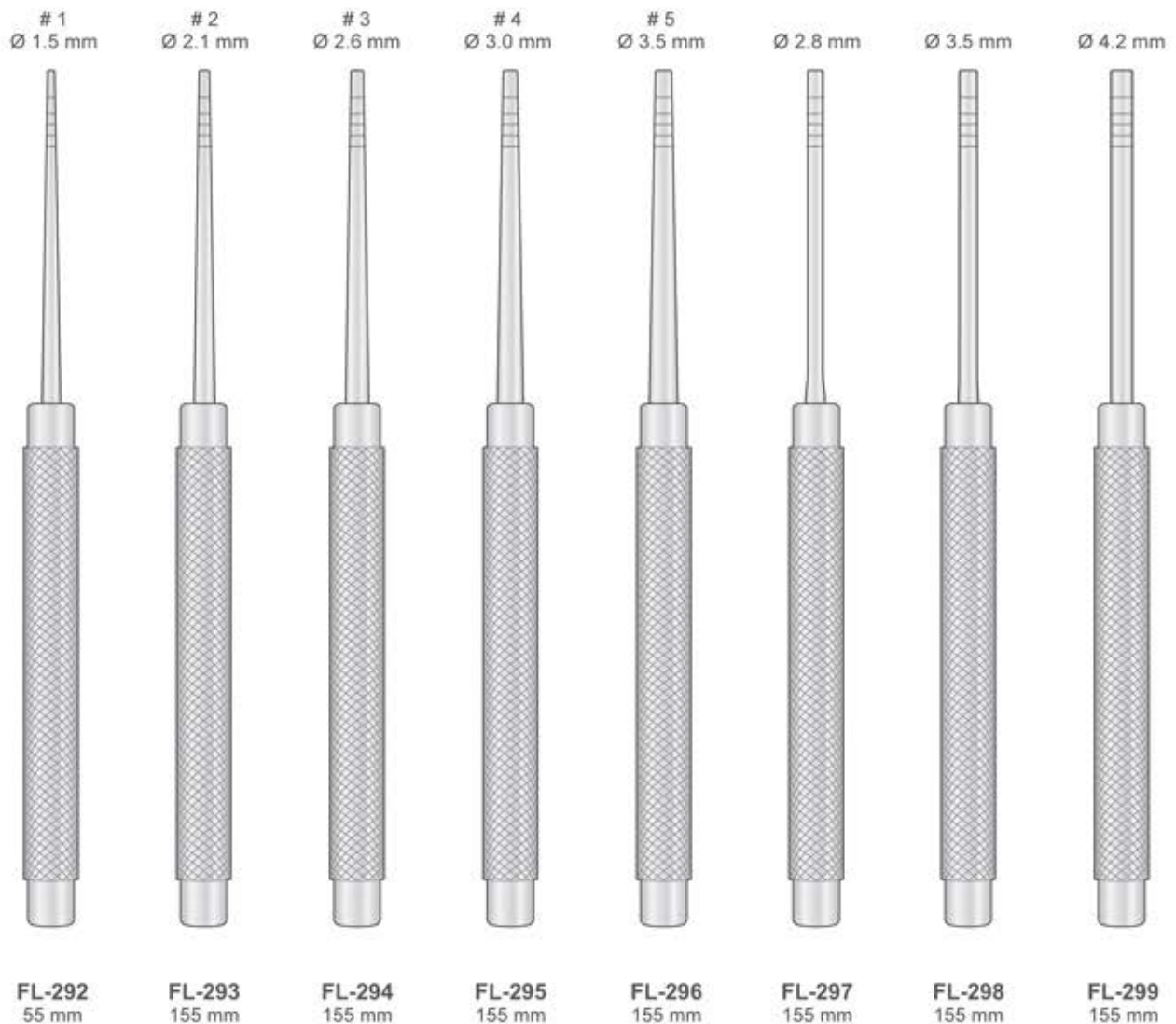



Osteotome
Osteotomes
Osteotomi
Osteótomos
Ostéotomes

Meißeln Graduiert
Graduated Chisels
Scalpelli graduati
Cinceles graduados
Burins gradués

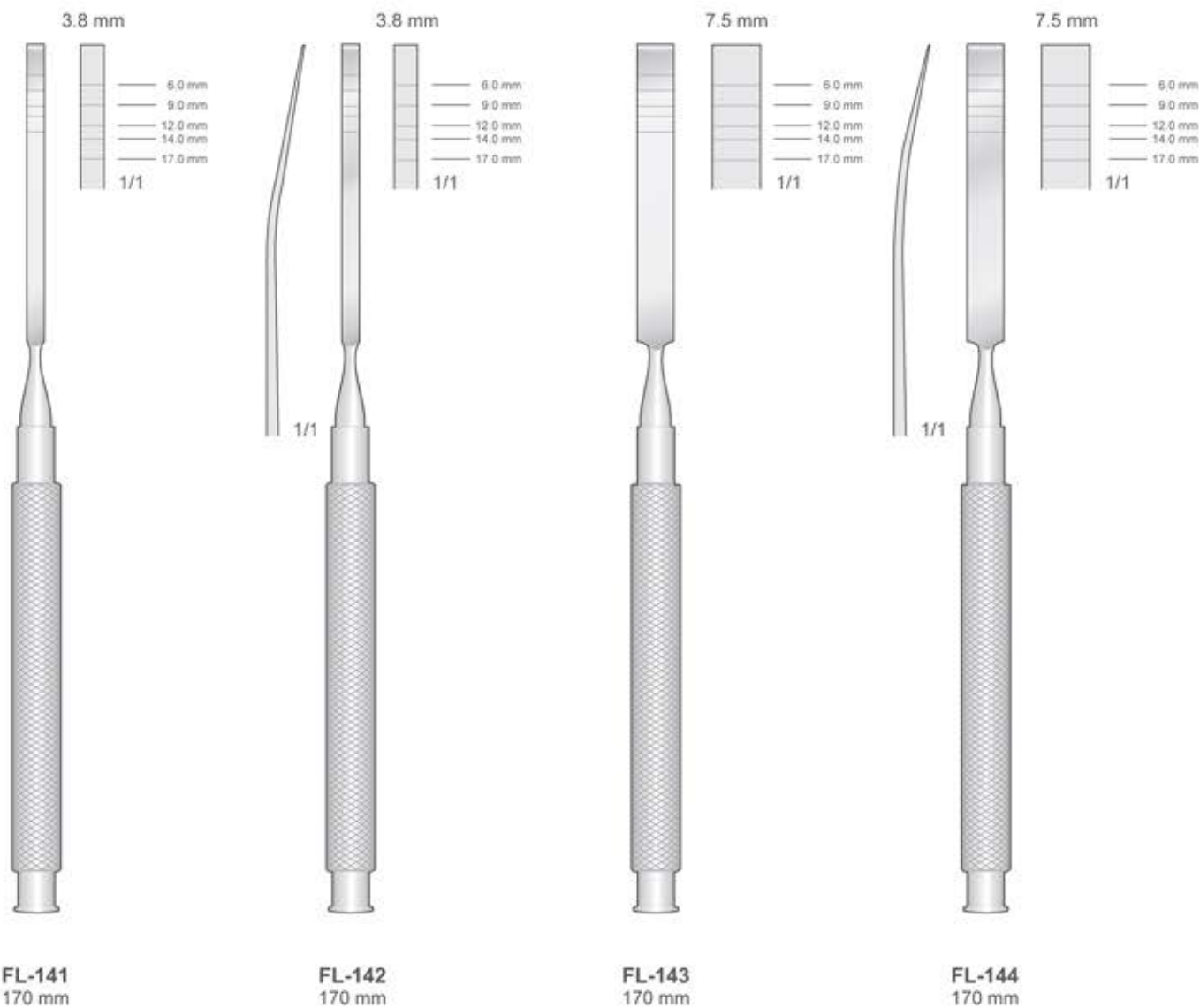



Osteotome
Osteotomes
Osteotomi
Osteótomos
Ostéotomes

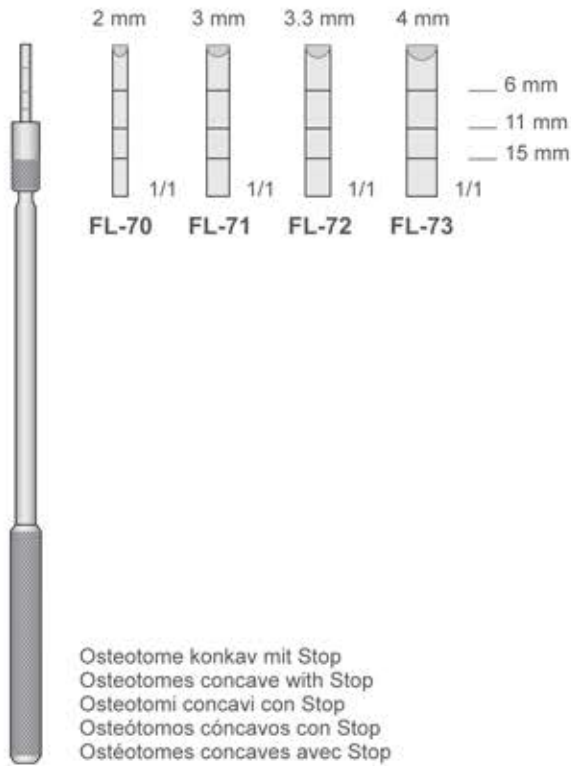

Osteotome konkav mit Stop
Osteotomes concave with Stop
Osteotomi concavi con Stop
Osteótomos cóncavos con Stop
Ostéotomes concaves avec Stop

FL-70/FL-73
165 mm

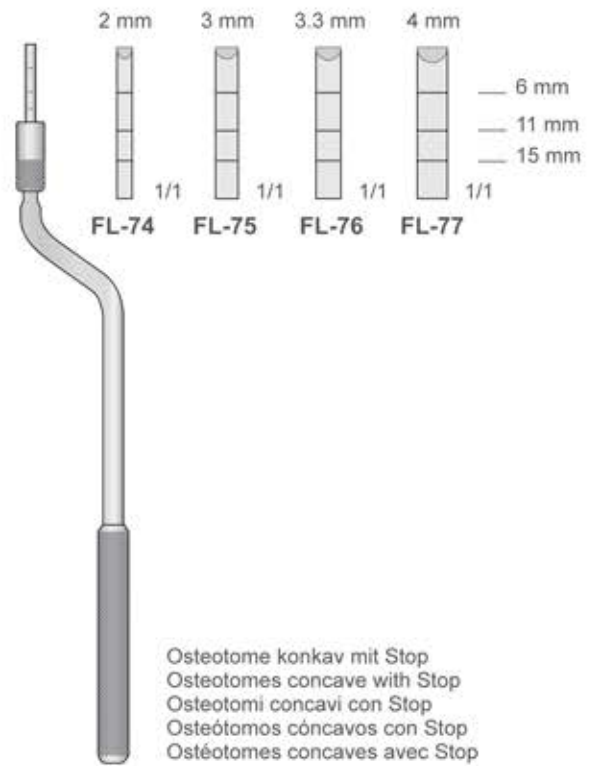

Osteotome konkav mit Stop
Osteotomes concave with Stop
Osteotomi concavi con Stop
Osteótomos cóncavos con Stop
Ostéotomes concaves avec Stop

FL-74/FL-77
165 mm

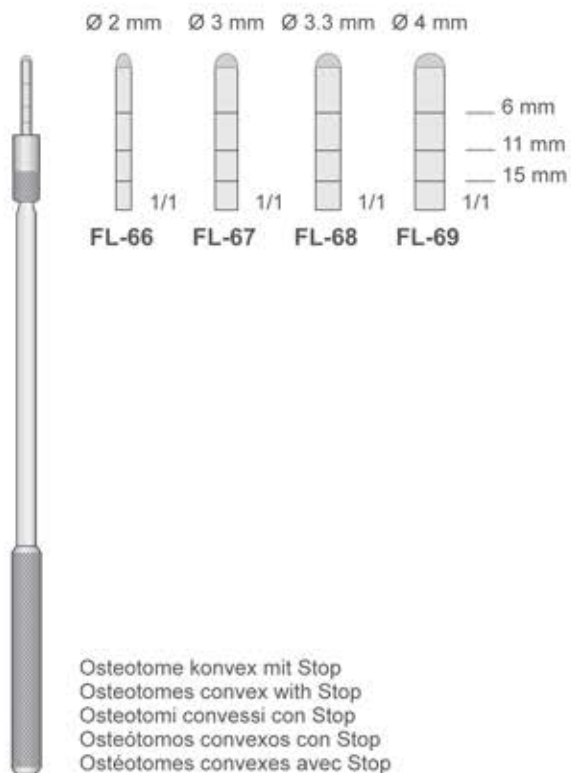

Osteotome konvex mit Stop
Osteotomes convex with Stop
Osteotomi convessi con Stop
Osteótomos convexos con Stop
Ostéotomes convexes avec Stop

FL-66/FL-69
165 mm

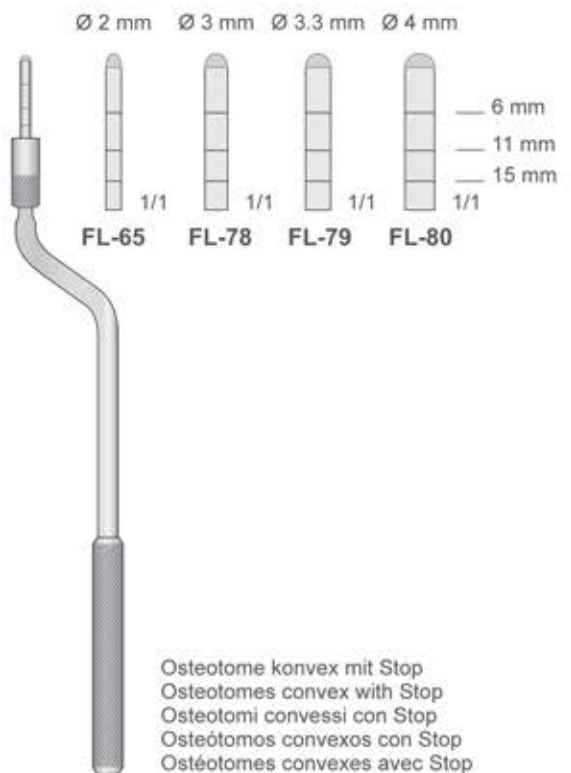

Osteotome konvex mit Stop
Osteotomes convex with Stop
Osteotomi convessi con Stop
Osteótomos convexos con Stop
Ostéotomes convexes avec Stop

FL-65/FL-80
160 mm



Osteotome
Osteotomes
Osteotomi
Osteótomos
Ostéotomes



Dilatator
Dilator
Dilatatori
Dilatador
Dilatateur

A-Form



Spreader
Spreader
Expansori
Expansor
Expandeur

D-Form
Convex Tip

Ø 2 mm



FL-25
145 mm

Ø 3 mm



FL-26
145 mm

Ø 3.3 mm



FL-27
145 mm

Ø 4 mm



FL-28
145 mm

Ø 3 mm



FL-37
145 mm

Ø 4 mm



FL-38
145 mm

Ø 5 mm



FL-39
145 mm



Trepanbohrer
Trepines
Trepine
Trépanos
Trépan

For Tissue
Für Gewebe
Pour tissu
Para tejido
Per tessuto

Nicht Gezahnt
Non Serrated
No dentellato
No dentado
Non dentelé

For Bone
Für Knochen
Pour os
Para hueso
Per osso

Gezahnt
Serrated
Dentellato
Dentado
Dentelé



Ø mm	GA-63	GA-64	GA-65	GA-66
Int.	2.5	4.0	4.5	5.5
Ext.	3.0	4.5	5.0	6.0



Ø mm	GA-33	GA-34	GA-35	GA-36	GA-37
Int.	2.5	4.0	4.5	5.5	6.5
Ext.	3.0	4.5	5.0	6.0	7.0

Hautstanzen
Tissue Punches
Mucotomi Punches
Bisturi circular para tejido
Bistouri circulaire pour tissue

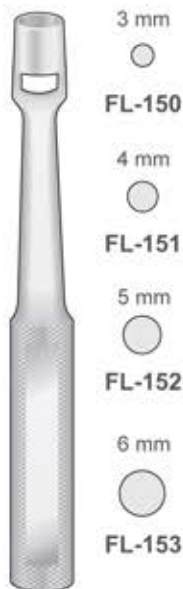

KEYES
FL-150/FL-153
100 mm

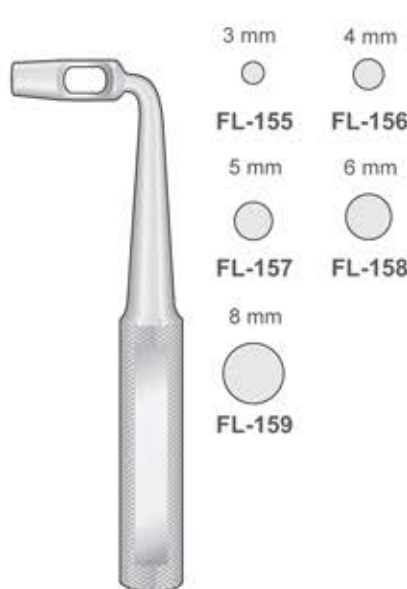

KEYES
FL-155/FL-159
90 mm

Implant Graduierung
Implant depth gauge with ball end
Sonda per controllare la profondità del sito
Sonda para controlar la profundidad



GA-60
100 mm



Knochenschale
Bone Well
Bacinella per osso
Cubeta para hueso
Cuvette à os



Rostfrei
Stainless Steel
Acciaio inossidabile
Acero inoxidable
Acier Inoxydable

SS-65
35 mm

Absaugkanülen für Knochen, mit Filter
Suction tube for bone, with filter
Cannule d'aspiration avec trattenuta osso, con filtro
Cánulas aspiradoras para hueso, con filtro
Canule d'aspiration pour os avec filtre



Ersatzfilter
Filter of replacement
Filtro di ricambio
Filtro de recambio
Filtre de rechange

Ø 10 mm int.
Autoclavable
Stainless Steel

GF-134
20 mm

GF-133
180 mm

Membranplatzierungsinstrumente
Membrane Placement Instruments
Strumenti per posizionare membrana
Instrumentos para colocar membranas
Instruments pour application de membrane



2/1

1/1

MPI-1
185 mm

Aufbring Instrument für Knochenmaterial
Applicator for bone material
Aplicatore per materiale osseo
Cucharillas para material oseoso
Applicateur pour matière osseuse



1/1

1/1

LUNIATSCHEK
PF-6
170 mm



1/1

1/1

IM-15
180 mm

Knochenmühlen - und spritzen
 Bone Mills and Syringes
 Macina e siringhe per osso
 Molinos y jeringas para hueso
 Moulin et seringues à os

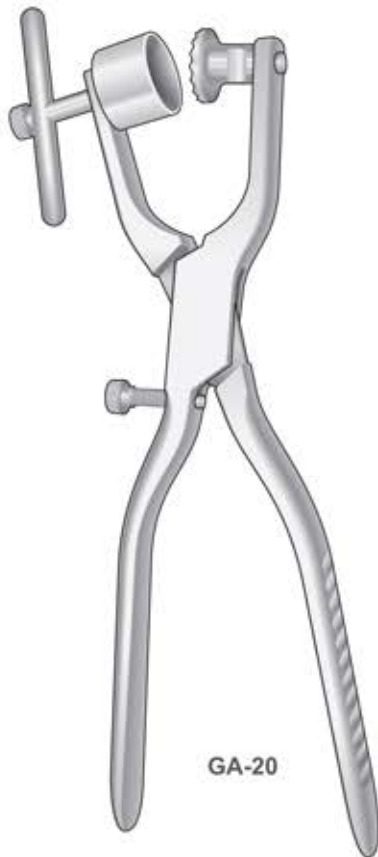

GA-18
Lower
Titanium



GA-17
Upper
Titanium



GA-19
Handle
with screw



Ø int. 2.5 mm
Ø ext. 3.5 mm



Ø int. 3.5 mm
Ø ext. 4.5 mm



Ø int. 4.4 mm
Ø ext. 5.5 mm



Ø int. 6 mm
Ø ext. 7 mm

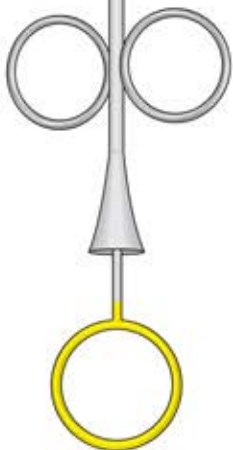

SS-60M
160 mm

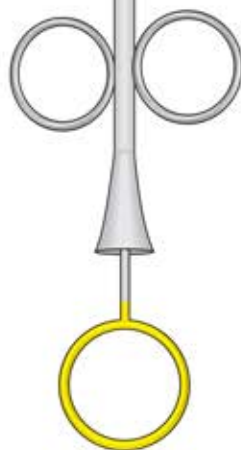

SS-61M
160 mm

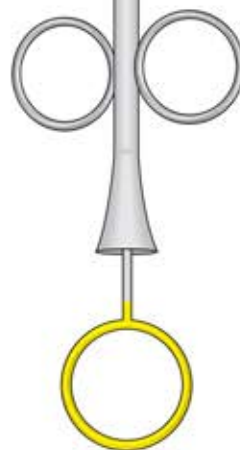

SS-62M
160 mm

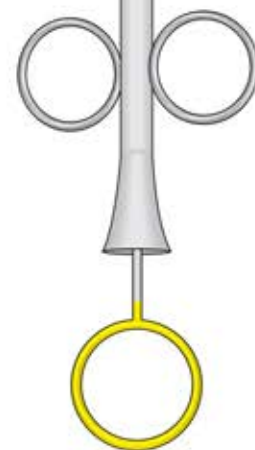

SS-64M
160 mm



Knochenstopfer
Bone Tampers - Bone Grafting Packers
Compattatore per osso
Compactador para hueso
Compacteur à os



	Non Serrated Tips		Serrated Tips	
USB-P1	○ Ø 1.8	○ Ø 2.8	● Ø 1.8	● Ø 2.8
USB-P2	○ Ø 3.2	○ Ø 3.8	● Ø 3.2	● Ø 3.8
USB-P3	○ Ø 4.2	○ Ø 4.8	● Ø 4.2	● Ø 4.8
USB-P4	○ Ø 5.0	○ Ø 5.5	● Ø 5.0	● Ø 5.5

Ø 3 mm



FL-20
155 mm

Ø 5 mm



FL-21
155 mm

Ø 4 mm



FL-31
155 mm

Ø 3 mm



FL-33
155 mm

Ø 5 mm



FL-35
155 mm

3 mm



OP-7
170 mm

6 mm



OP-8
170 mm

4 mm



8 mm



Misura interna
 ○ SS-20 Ø 3 mm
 ○ SS-21 Ø 4 mm
 ○ SS-22 Ø 5 mm

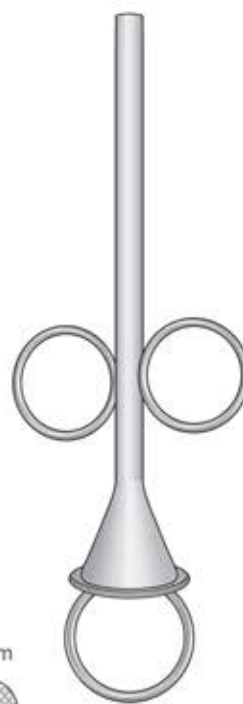

**FOITZIK
SS-20/SS-22**
140 mm



Knochenschaber. Rostfrei Stahl
 Bone-Grafter. Stainless Steel
 Grattini per osso. Inox
 Raspador de hueso. Acero inoxidable
 Racleur d'os. Acier inoxydable

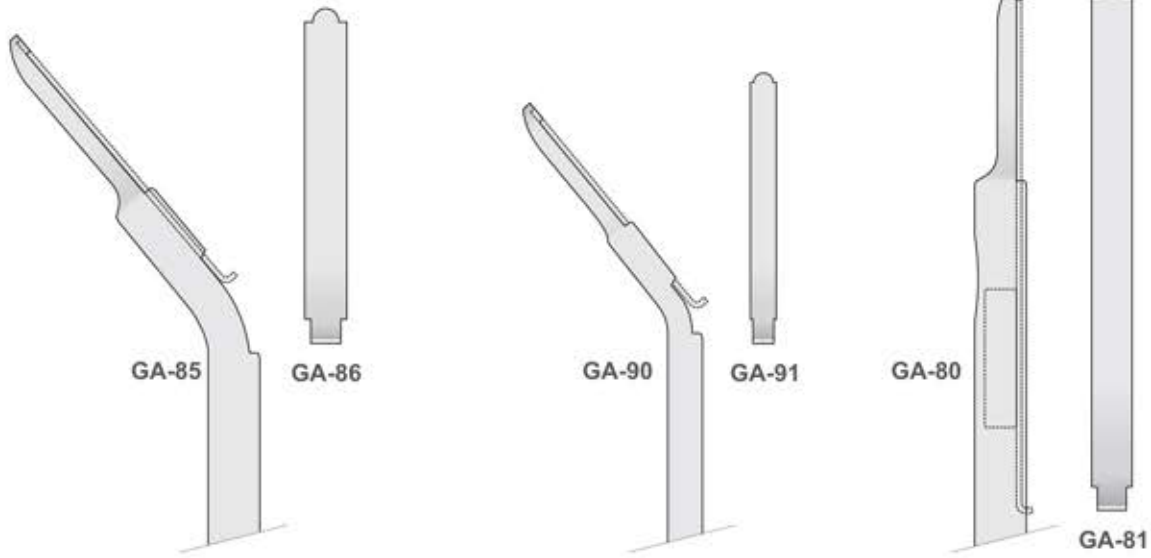

Knochenschaber mit Reibeklinge
 Bone-Grafter with blade
 Grattino con lama
 Raspador de hueso con hoja
 Racleur d'os avec lame

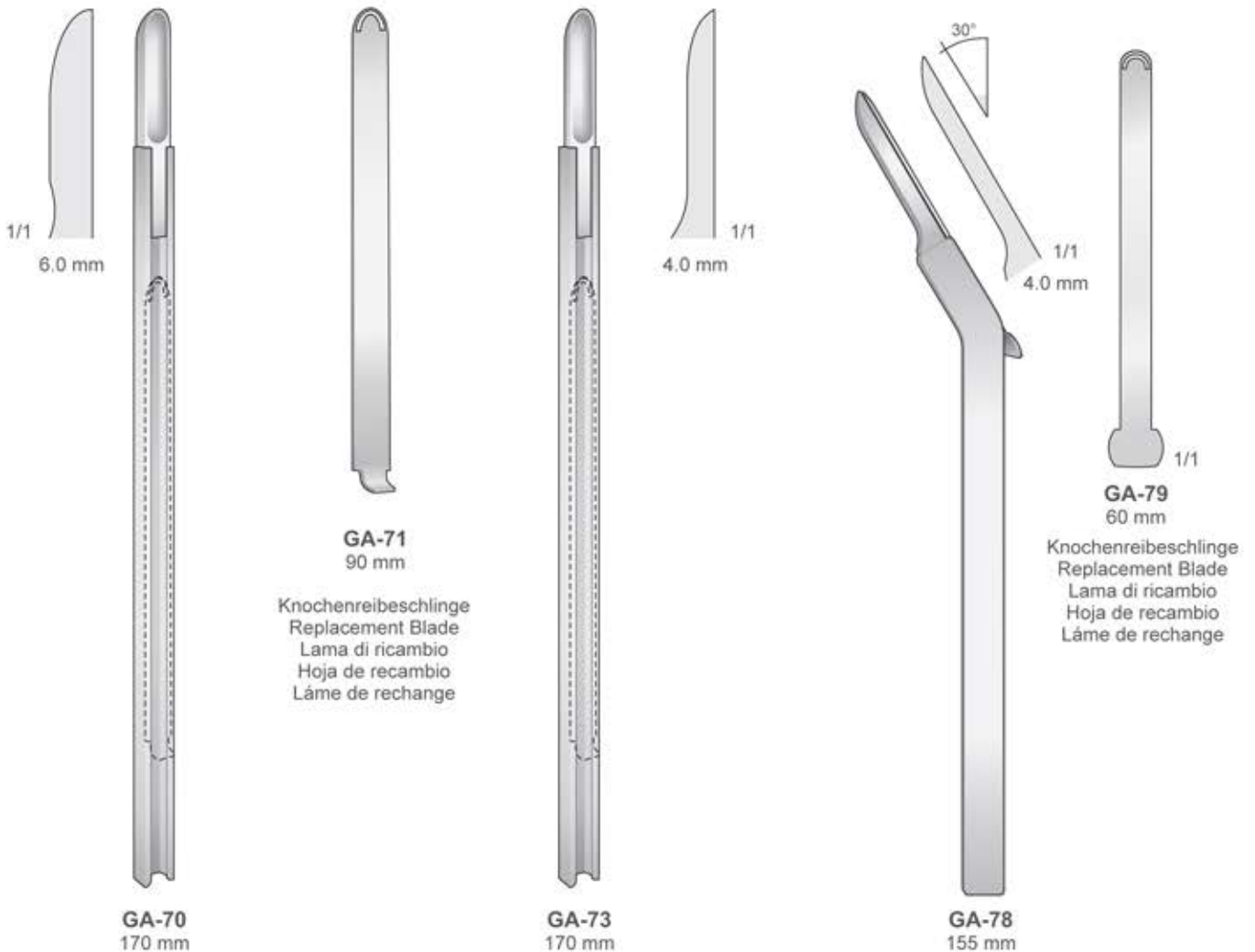

Meßbereich: 0 - 20 mm
Measuring range: 0 - 20 mm
Campo di misura: 0 - 20 mm
Alcance de medición: 0 - 20 mm
Etendue de mesure: 0 - 20 mm

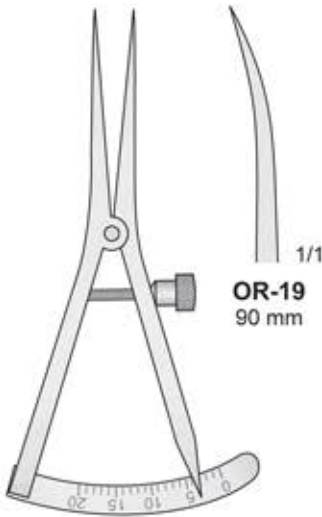

OR-19
CASTROVIEJO
90 mm



LS-08
100 mm



LS-09
200 mm

Meßbereich: 0 - 80 mm
Measuring range: 0 - 80 mm
Campo di misura: 0 - 80 mm
Alcance de medición: 0 - 80 mm
Etendue de mesure: 0 - 80 mm



OR-40
125 mm



OR-45
95 mm

0 - 40 mm
Meßbereich / Measuring range / Campo di misura
Alcance de medición / Etendue de mesure

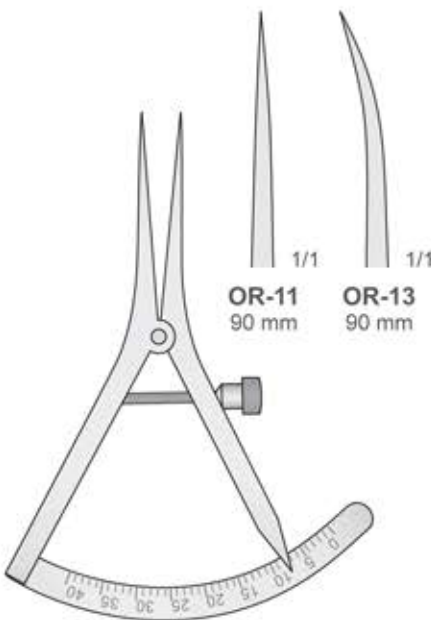

CASTROVIEJO
OR-11/OR-13
90 mm

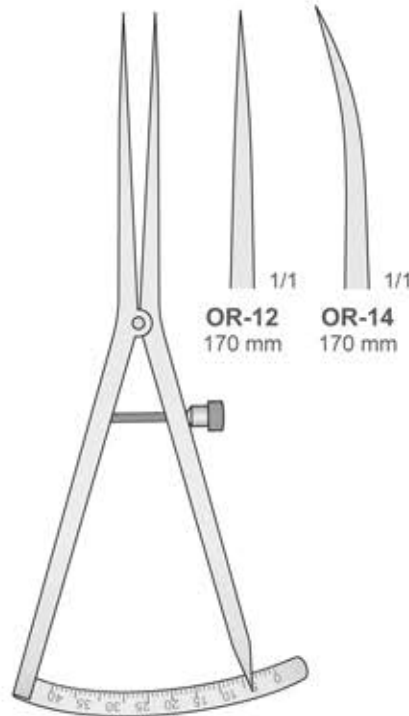

CASTROVIEJO
OR-12/OR-14
170 mm

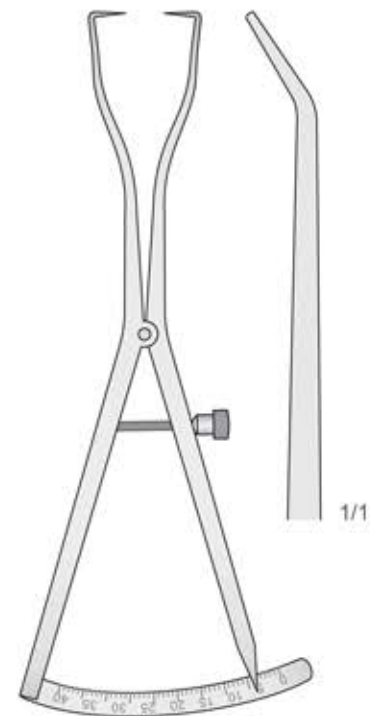

CASTROVIEJO
OR-18
170 mm

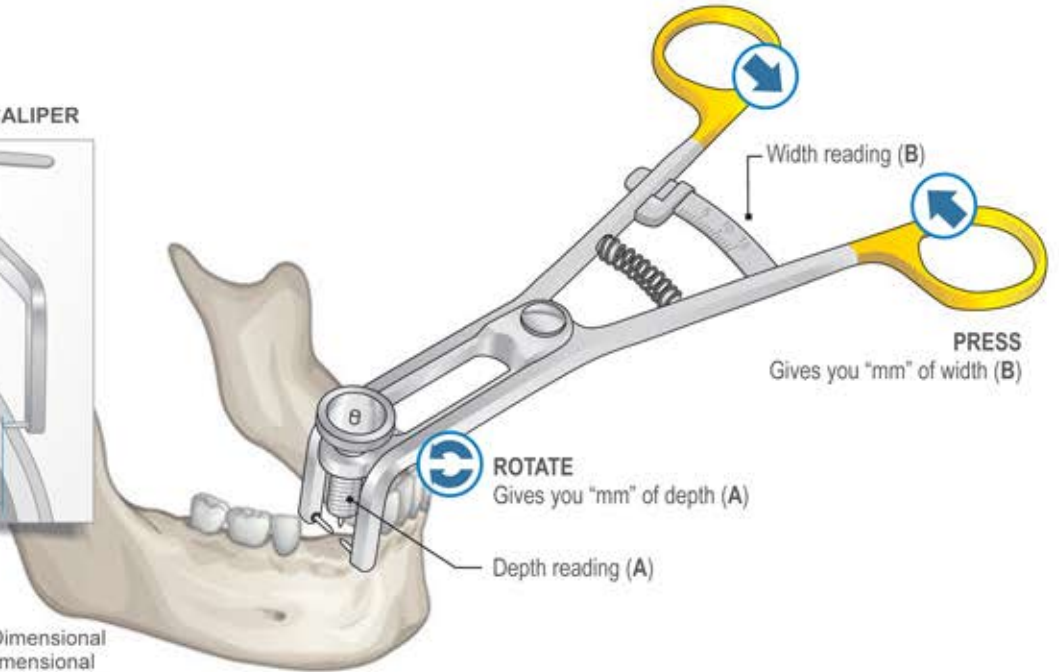
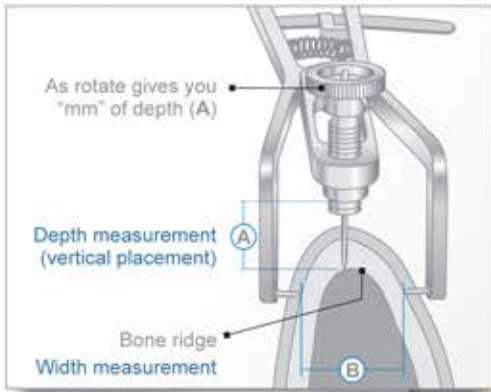

Osteometer
 Osteometer
 Osteometro
 Osteometro
 Osteometer

TRIDIMENSIONAL IMPLANTOLOGY CALIPER

DB-300

Schieblehre für Implantologie
 Implantology Calliper
 Calibro per Implantologie
 Calibre para Implantología
 Calibre pour Implantologie

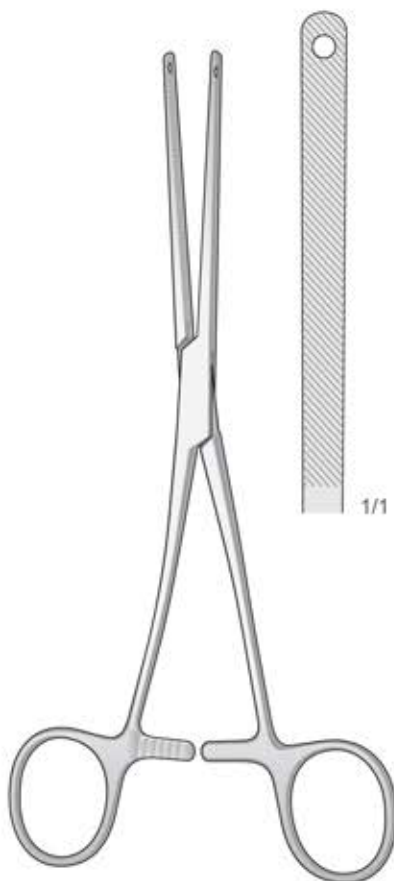
Trei-Dimensional
 Tridimensional
 Tridimensionale
 Tridimensional
 Tridimensionnel

BONE BLOCK CLAMP
 Bone Holding Clamps
 Knochenhalteklammern
 Daviers à os
 Pinzas de sujeción para hueso
 Pinze per fissare l'osso

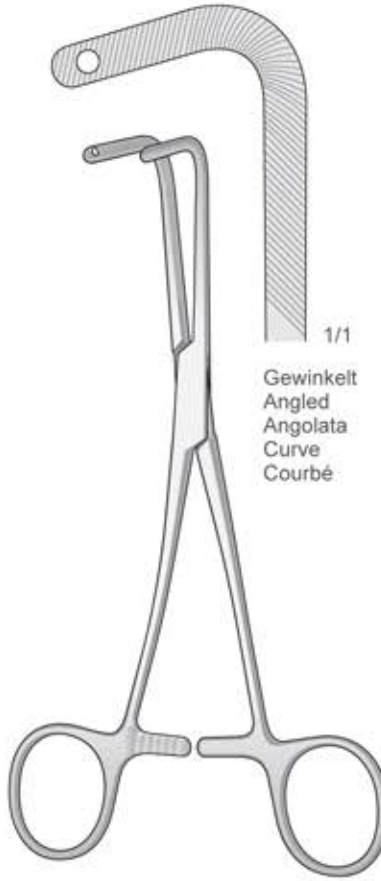
P-340
 220 mm



P-341
 200 mm

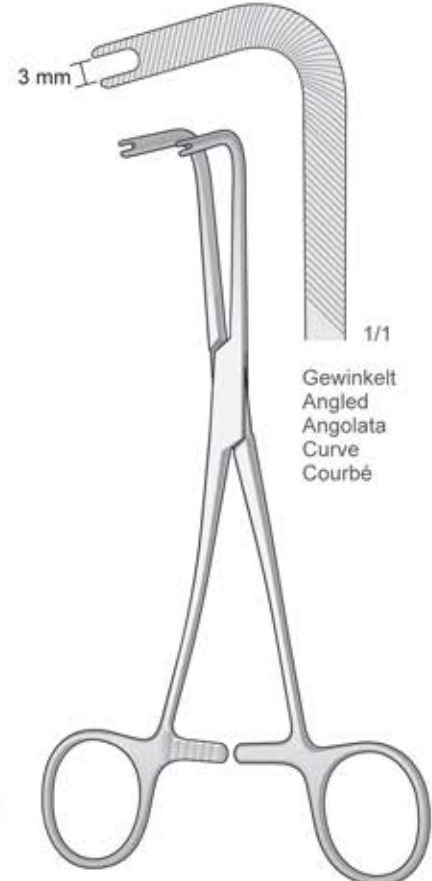

P-342
 200 mm



Retraktoren - Knochenhaltezange
 Retractors - Bone Holding Forceps
 Divaricatori - Pinza per fissare l'osso
 Separadores - Pinzas para sujeción para hueso
 Écarteurs - Daviers à os

Tibia Wundspreizer
 Tibial and Iliac Retractor
 Divaricatore per tibia e cresta iliaca
 Separadores tibiales e iliacos
 Ecarteur pour tibia e crête iliaque

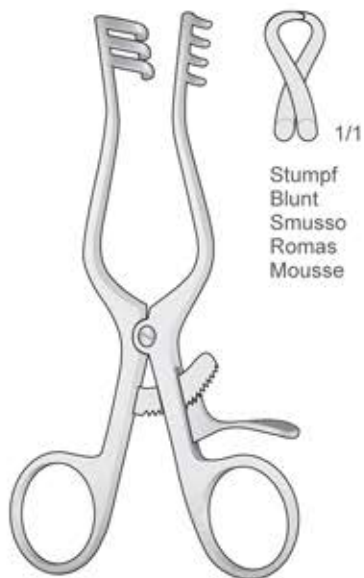

WEITLANER
BV-23
 165 mm



1/1
 Stumpf
 Blunt
 Smusso
 Romas
 Mousse



RADOLF
FO-159
 135 mm

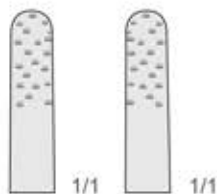

1/1
 Knochenhaltezange
 Bone Holding Forceps
 Pinza per fissare l'osso
 Pinzas de sujeción para hueso
 Davier à os

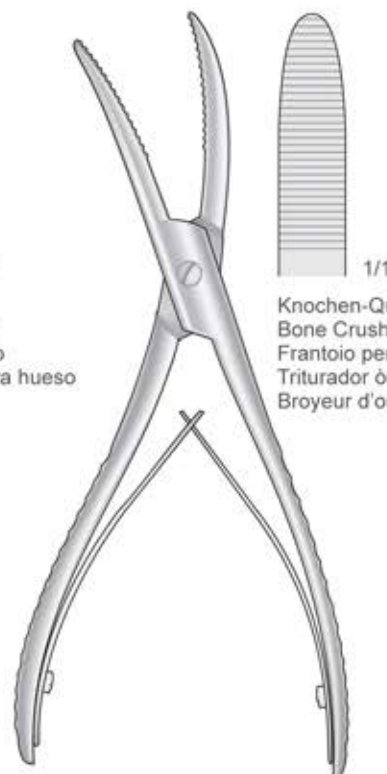

WOLFF
LX-113
 180 mm



1/1
 Knochen-Quetsche
 Bone Crusher
 Frantoio per osso
 Triturador óseo
 Broyeur d'os

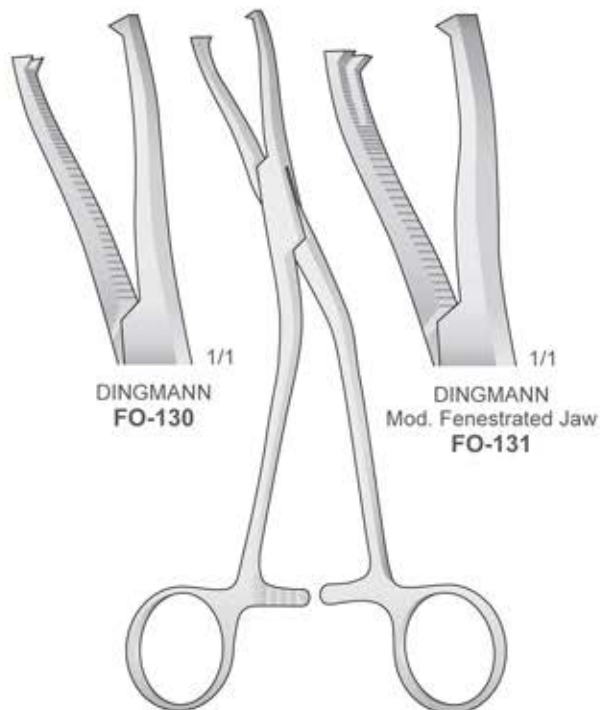

1/1
DINGMANN
FO-130

1/1
DINGMANN
 Mod. Fenestrated Jaw
FO-131

DINGMANN
FO-130/FO-131
 190 mm

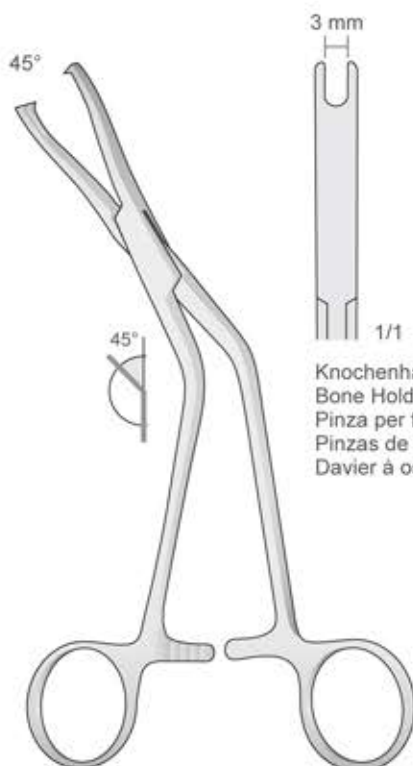

DINGMANN - Mod. Fenestrated Jaw
FO-131S
 190 mm

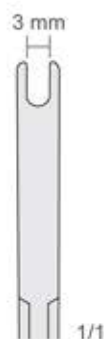

3 mm
 1/1
 Knochenhaltezange
 Bone Holding Forceps
 Pinza per fissare l'osso
 Pinzas de sujeción para hueso
 Davier à os

J

Periosteals (Raspatories)

Raspatorien
Rugines périostiques
Periostótomos (Legras)
Scollaperiosteí (Periostotomi)

Curettes

Küretten
Curettes
Curetas
Curettes

Bone files

Knochenfeilen
Limes à os
Limas para hueso
Lime per osso

Tissue Nippers

Gewebezängchen
Pincés coupante pour tissu
Pinzas para cortar tejidos
Tronchesi per gengive e tessuti

Bone Rongeurs

Hohlmeißelzangen
Pincés gouges
Pinzas gubias
Pinze ossivore

Bone Cutting Forceps

Knochensplitterzangen
Pincés coupantes à os
Pinzas cortantes para huesos
Pinze ossivore





Raspatorien
 Periosteals (Raspatories)
 Scollaperiosteai (Periostotomi)
 Periostótomos (Legras)
 Rugines périostiques

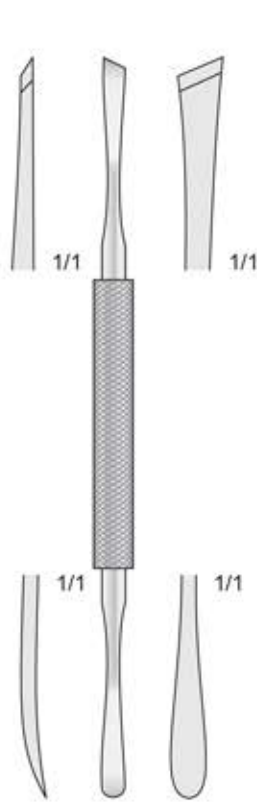

MEAD
165 mm



WEST
185 mm

**PERIOSTEAL
ELEVATORS**

Scharf - Sharp - Taglienti - Cortante - Tranchant

**PERIOSTEAL
RASPATORIES**

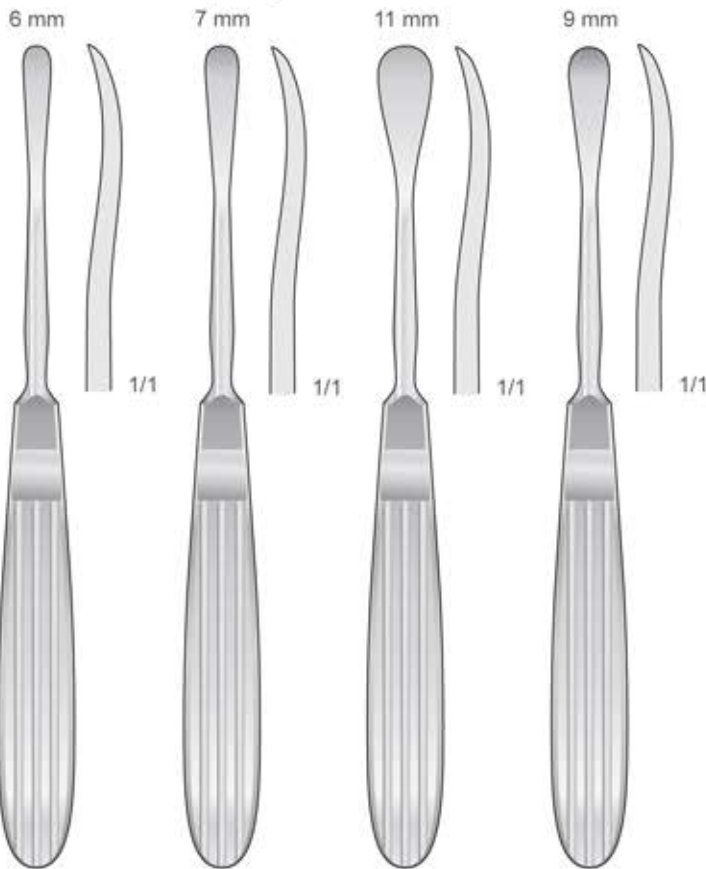

**OBWEGESER
DO-59**
175 mm

**OBWEGESER
DO-63**
175 mm

**OBWEGESER
DO-65**
175 mm

**OBWEGESER
DO-67**
175 mm

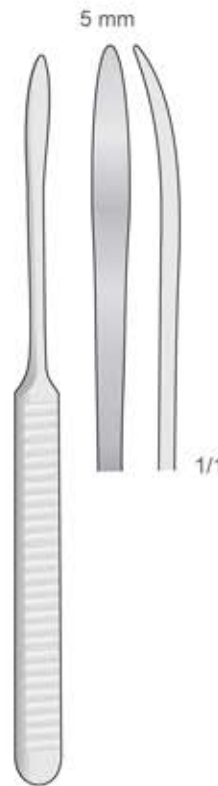

**WILLIGER
WG-10**
165 mm

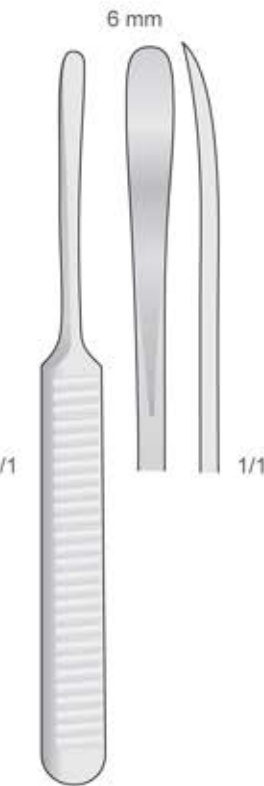

**WILLIGER
WG-12**
160 mm

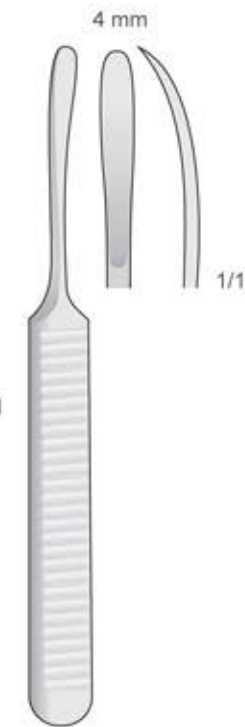

**WILLIGER
WG-14**
140 mm

Raspatorien - Elevatorien
 Raspatories - Elevators
 Periostotomi - Elevatori
 Legras - Elevadores
 Rugines - Elevateurs

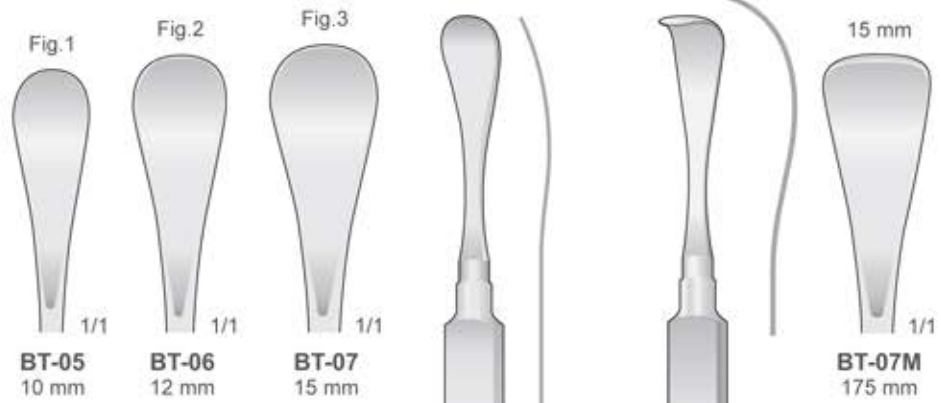

Halbscharf
 Semi-Scharp
 Semitagliente
 Semicortante
 Semitranchant

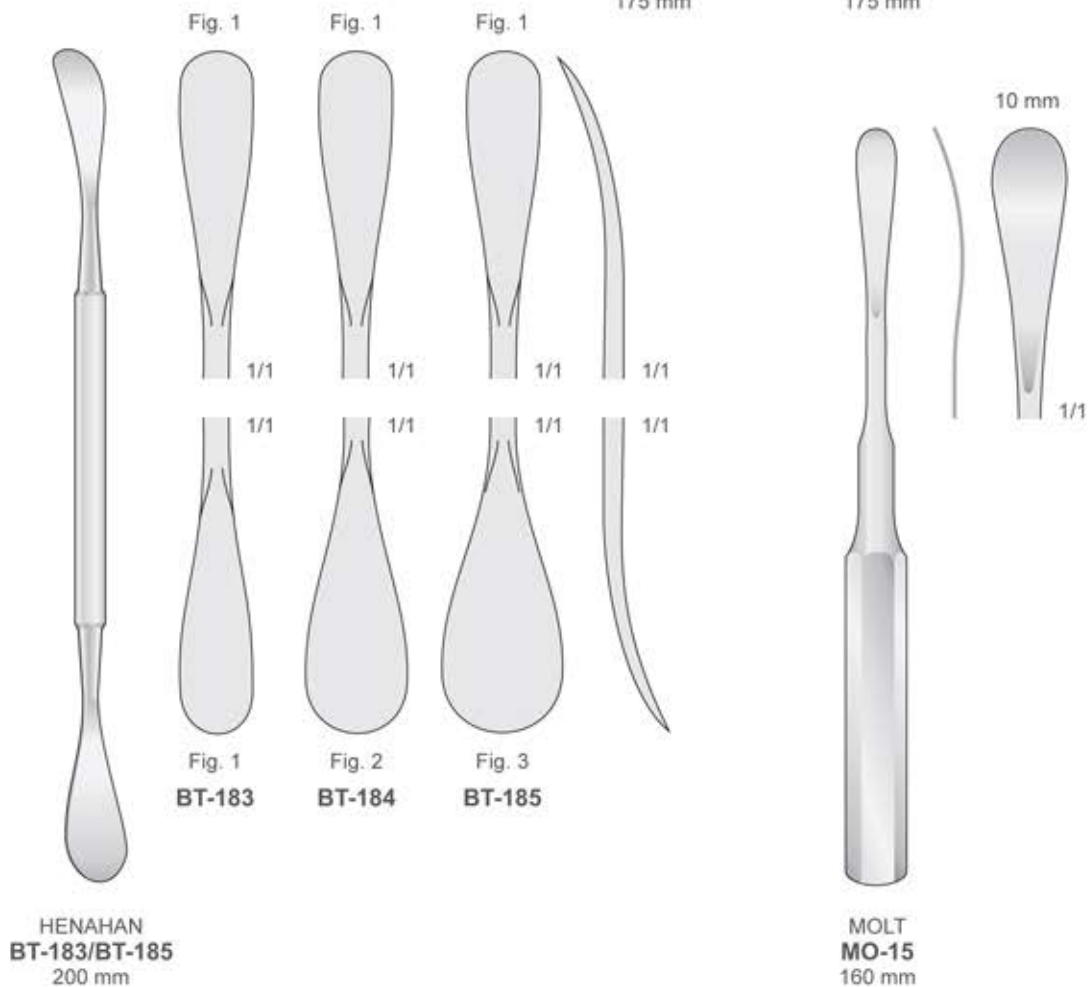

Raspatorien - Elevatorien
 Raspatories - Elevators
 Periostotomi - Elevatori
 Legras - Elevadores
 Rugines - Elevateurs

Fig. 12S

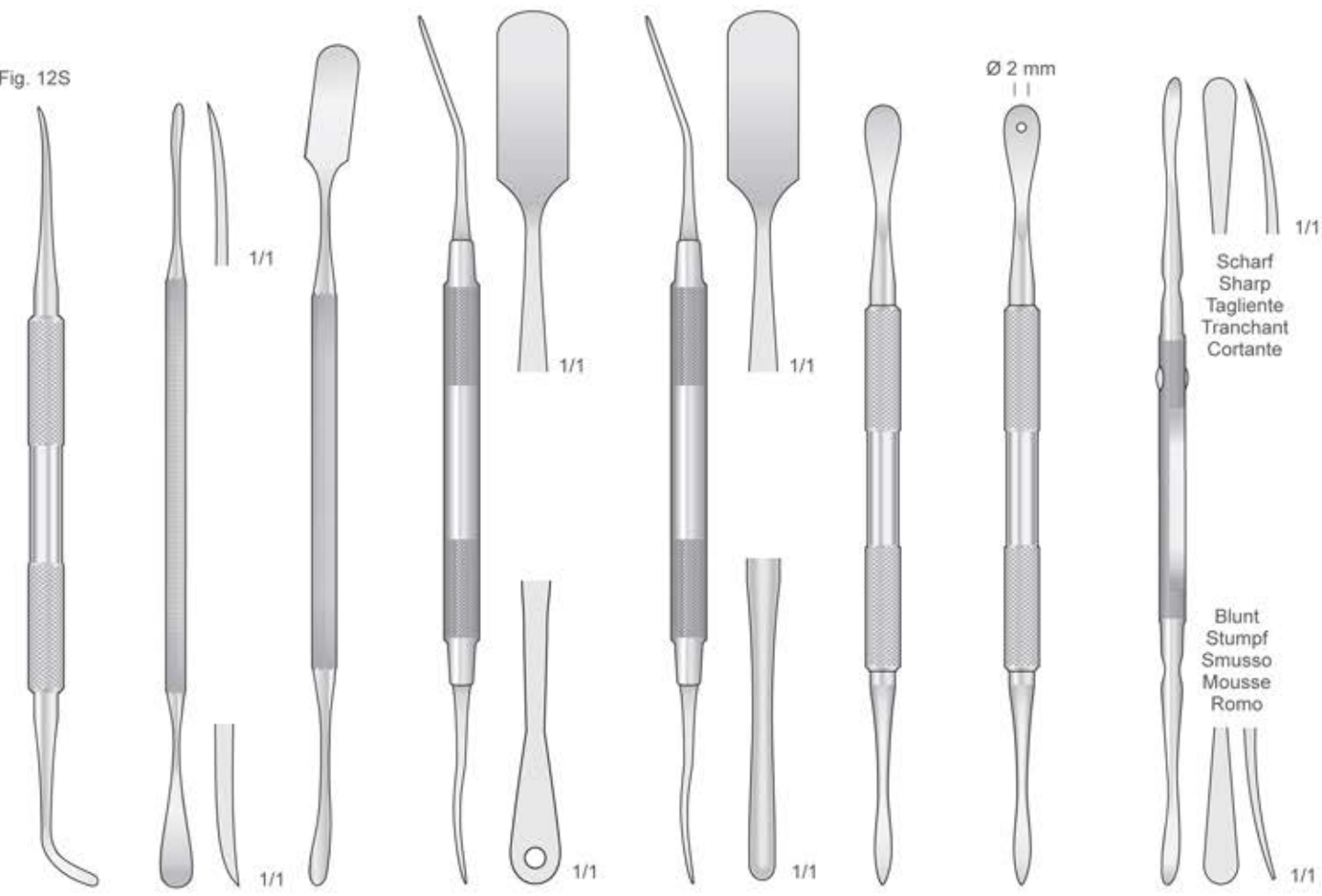

BENNETT
KO-58
 175 mm

MOLT-9
 175 mm

PR-3
 190 mm

PRICHARD
PR-3A
 180 mm

PRICHARD
718-PR3
 175 mm

MOLT
718-M9
 170 mm

MOLT
MO-9A
 170 mm

FREER
 180 mm

Raspatorien - Elevatorien
 Raspatories - Elevators
 Periotomi - Elevatori
 Legras - Elevadores
 Rugines - Elevateurs

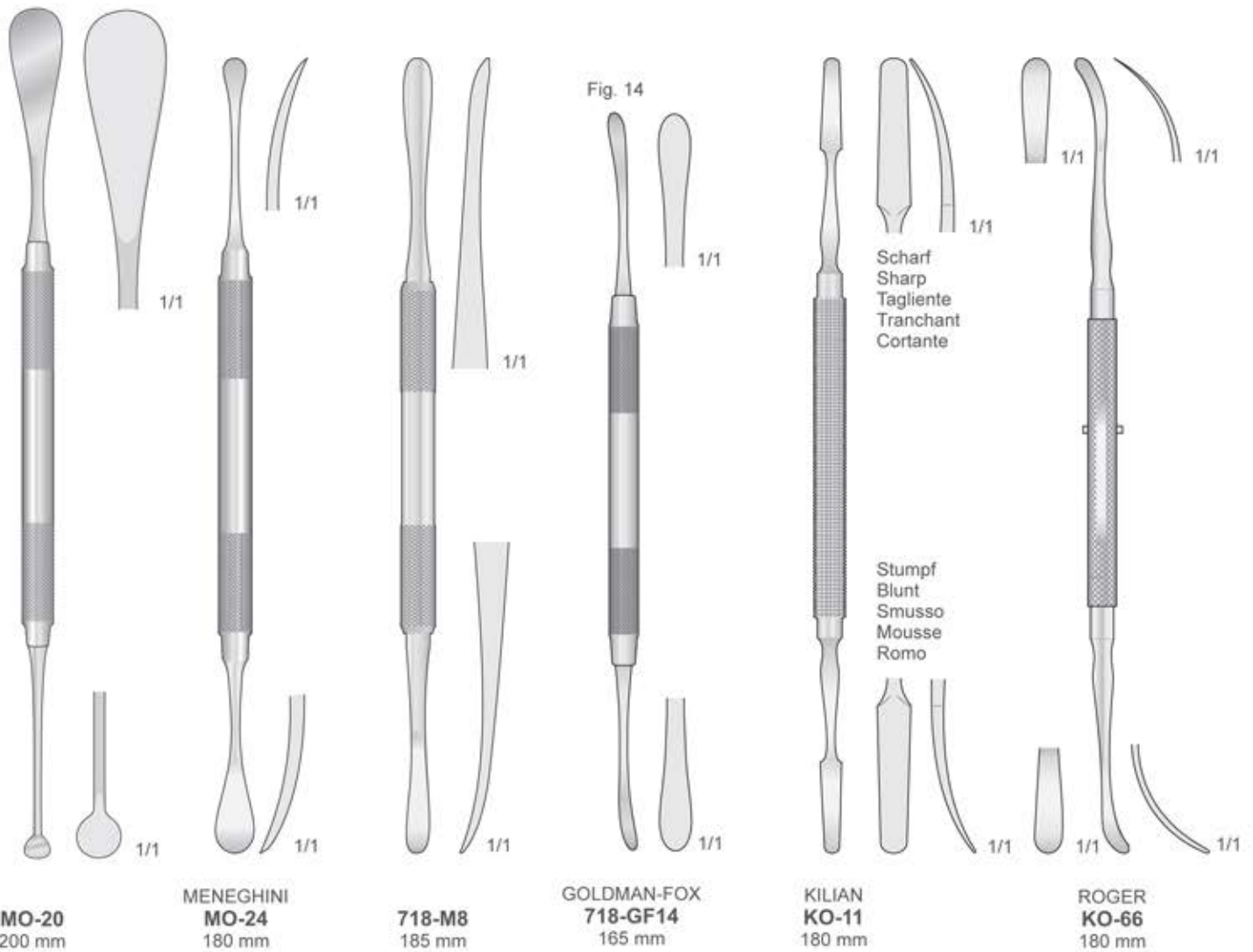

Raspatorien - Elevatorien
 Raspatories - Elevators
 Periostotomi - Elevatori
 Legras - Elevadores
 Rugines - Elevateurs

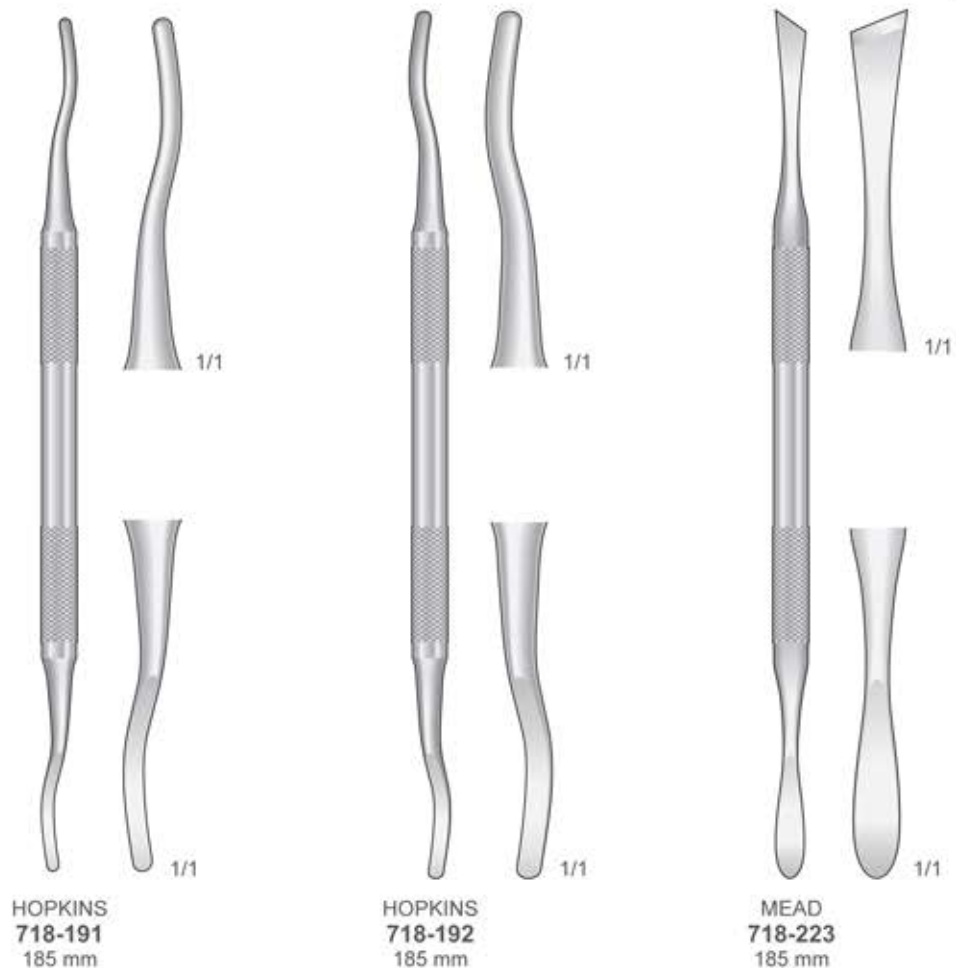

Instrumente für Sinuslift / Sinus Lift Instruments / Strumenti per rialzo del seno
 Instrumentos para elevación de seno maxilar / Instruments d'élevation sinusienne

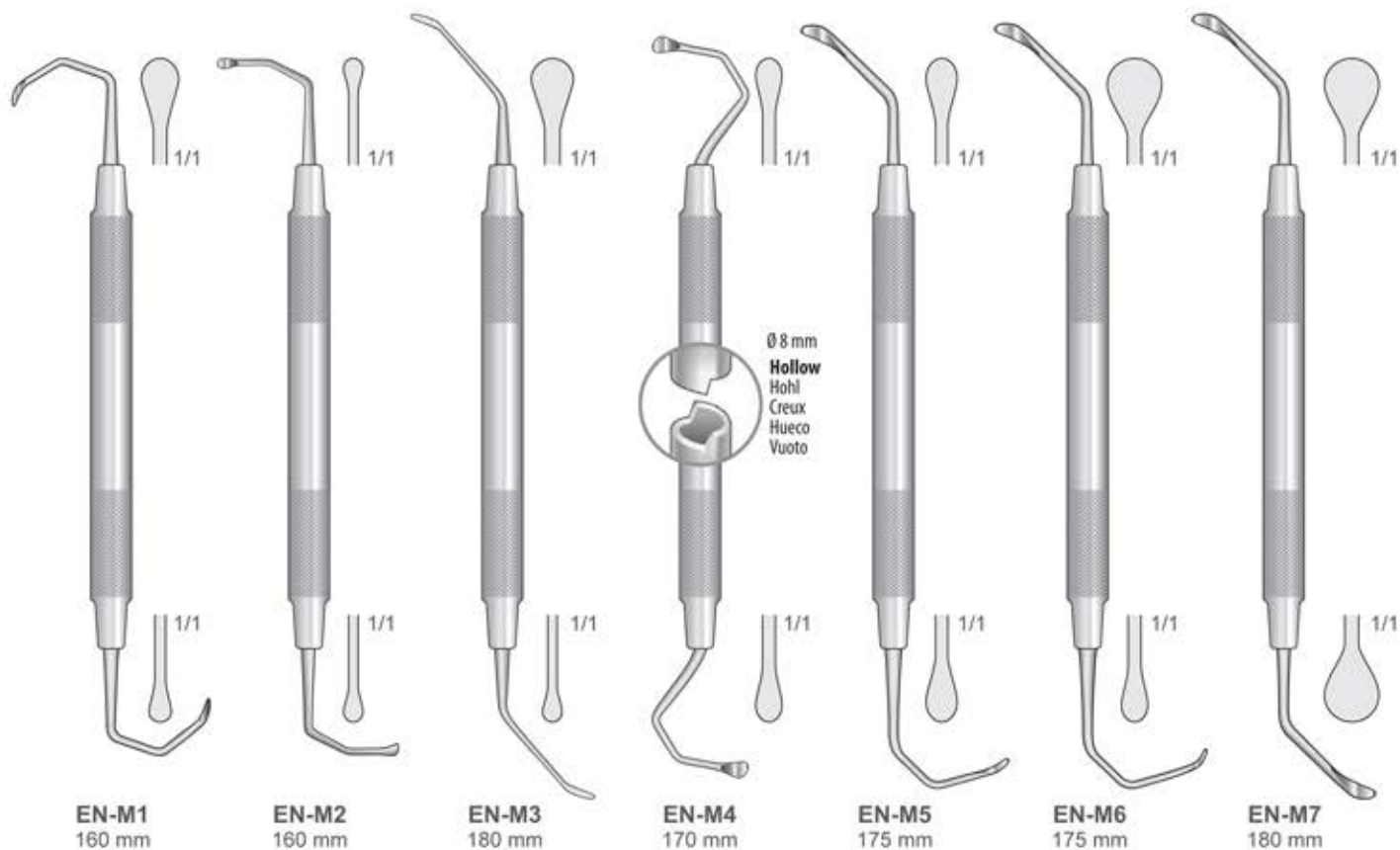

Raspatorien - Elevatorien
 Raspatories - Elevators
 Periostotomi - Elevatori
 Legras - Elevadores
 Rugines - Elevateurs

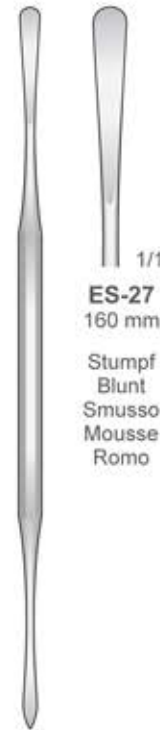
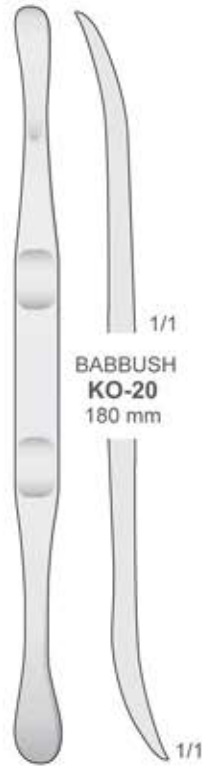

Instrumente für Sinuslift
 Sinus Lift Instruments

Strumenti per rialzo del seno
 Instrumentos para elevación de seno maxilar
 Instruments d'élevation sinusienne

Fig. 24G



**MOLT
 MO-8**
 180 mm

MIR-08
 175 mm

**WOODSON
 712-241**
 170 mm

718-24G
 175 mm

718-EN1
 175 mm

718-EN2
 165 mm

718-EN3
 170 mm



Raspatorien - Elevatorien
 Raspatories - Elevators
 Periostotomi - Elevatori
 Legras - Elevadores
 Rugines - Elevateurs

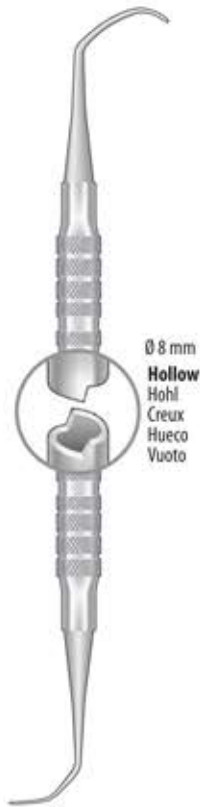

Ø 8 mm
Hollow
 Hohl
 Creux
 Hueco
 Vuoto

TASO-1



TASO-2



TASO-3



TASO-4



TASO-5



TASO-6



TASO-7



Ø 8 mm
Hollow
 Hohl
 Creux
 Hueco
 Vuoto

TASO-8

Raspatorien
 Raspatories
 Periostotomi
 Legras
 Rugines

 Curettes
 Küretten
 Curettes
 Curetas
 Curettes

 Instrumente für Sinuslift
 Sinus Lift Instruments
 Strumenti per rialzo del seno
 Instrumentos para elevación de seno maxilar
 Instruments d'élévation sinusienne

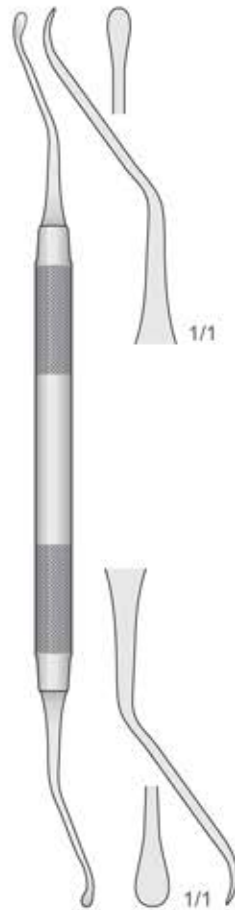
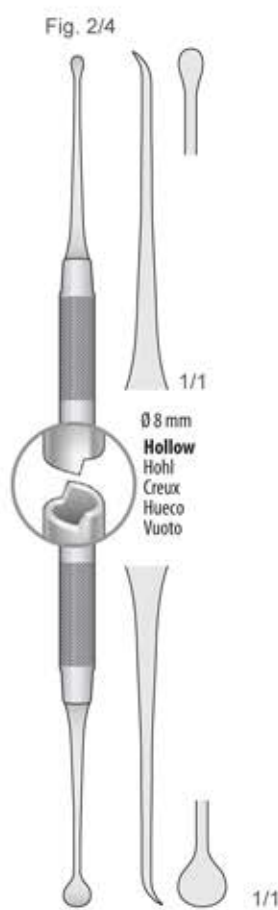
**MILLER-COLBURN
 CU-MC1**
 185 mm

**MOLT
 MO-12**
 190 mm

**MOLT
 MO-10**
 180 mm

SL-1
 200 mm

SL-2
 195 mm

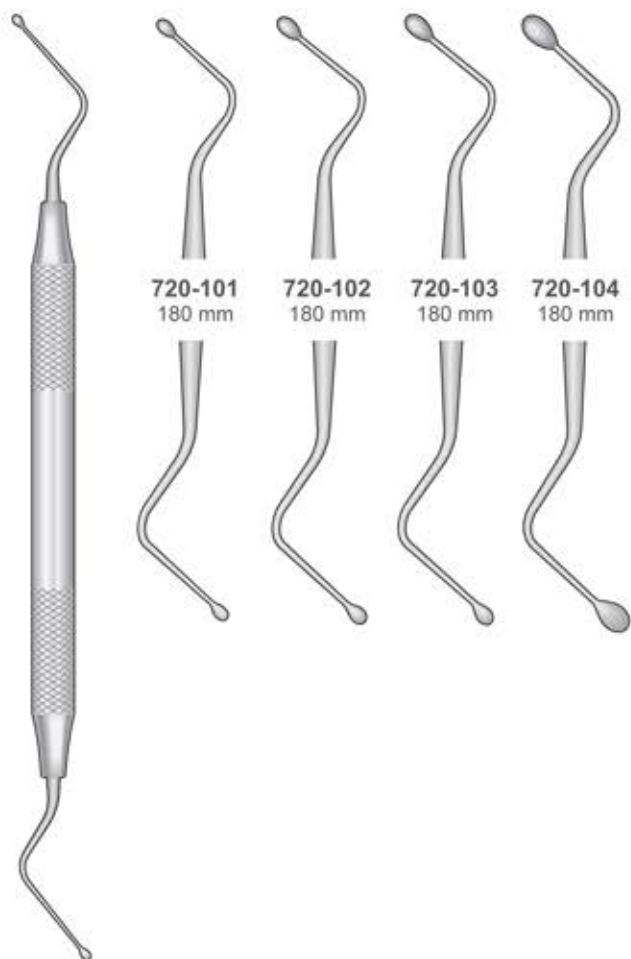

Runder Hohlgriff 8 mm
Hollow Round Handle 8 mm
Manico tondo vuoto 8 mm
Mango hueco 8 mm
Manche rond vide 8 mm



720-101
180 mm

720-102
180 mm

720-103
180 mm

720-104
180 mm

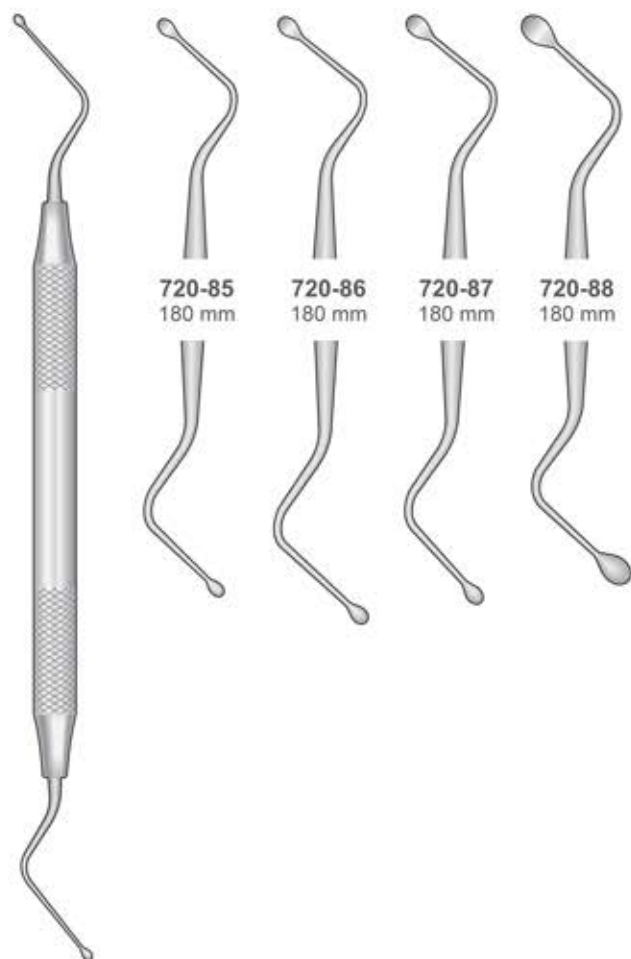

720-85
180 mm

720-86
180 mm

720-87
180 mm

720-88
180 mm

HEMINGWAY
720-101/720-104
180 mm

LUCAS
720-85/720-88
180 mm

Küretten
 Curettes
 Curettes
 Curetas
 Curettes



**HEMINGWAY
 C-1**
 170 mm



**HEMINGWAY
 C-2**
 170 mm



**HEMINGWAY
 C-3**
 170 mm



**HEMINGWAY
 C-4**
 170 mm



SL-21
 165 mm

Wundhachen Mandibular
 Mandibular Nerve Diplace
 Per spostamento
 nervo mandibolare
 Para nero mandibular



Küretten
Curettes
Curettes
Curetas
Curettes

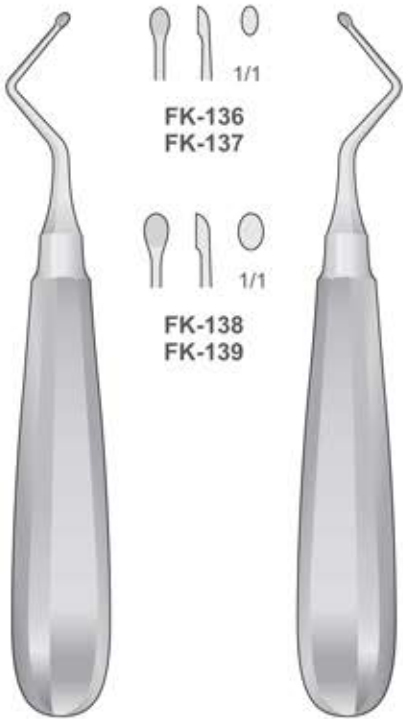

KERPEL
FK-136
FK-138
145 mm

KERPEL
FK-137
FK-139
145 mm



DL-50
155 mm



DL-51
150 mm



DL-52
150 mm



FK-83
160 mm



JANSEN
FK-84
160 mm



UFFENDORDE
FK-188
170 mm



UFFENDORDE
FK-189
170 mm



Fig. 00
3,4 mm
1/1
FK-197

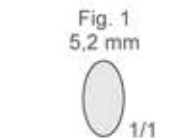
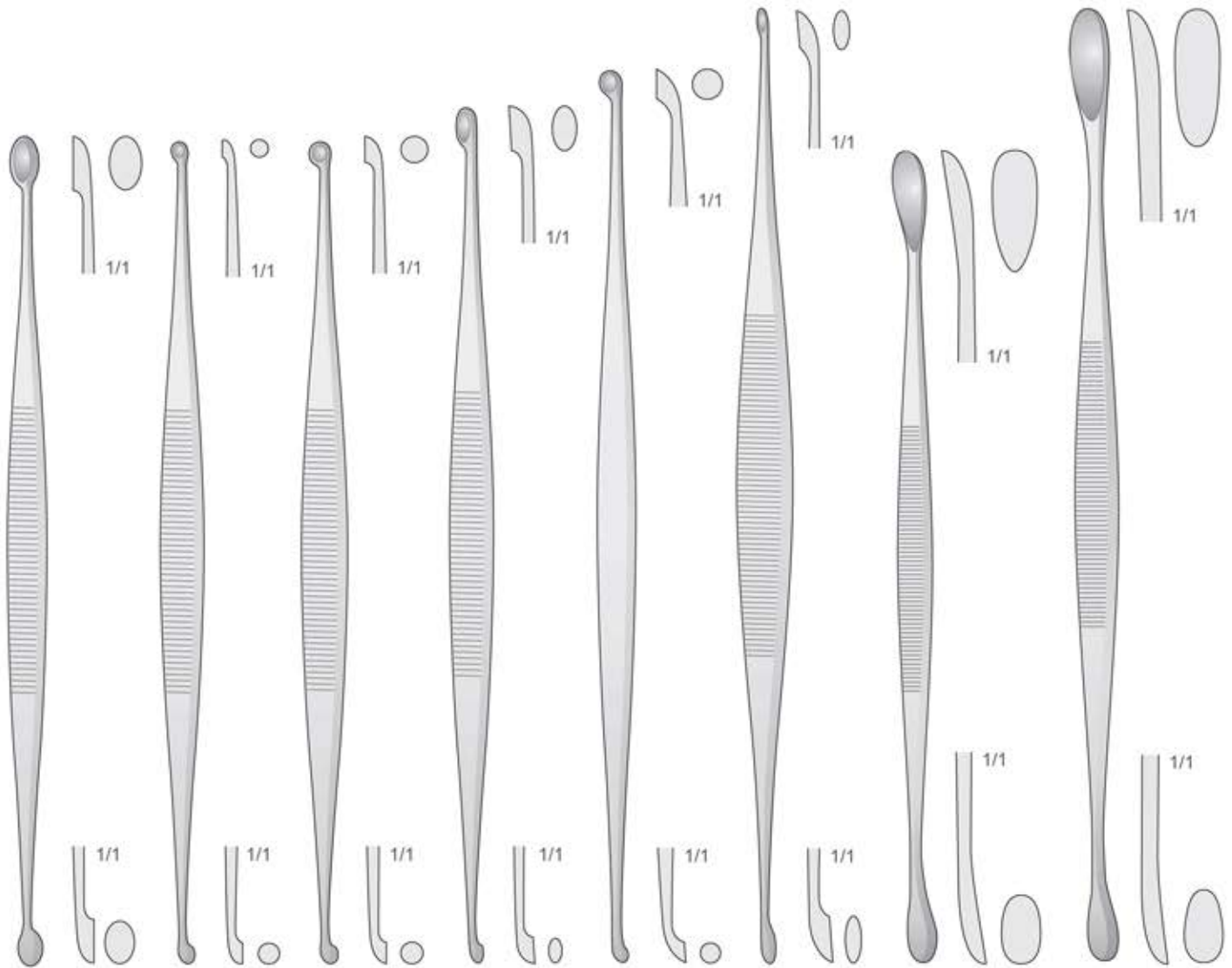

Fig. 1
5,2 mm
1/1
FK-198



WILLIGER
FK-197/FK-198
170 mm

Küretten
 Curettes
 Curettes
 Curetas
 Curettes



**JACOBSON
 FK-75**
 140 mm

**MARTINI
 FK-70**
 140 mm

**MARTINI
 FK-76**
 140 mm

**WILLIGER
 FK-71**
 145 mm









**JANSEN
 FK-77**
 160 mm

**BARTH
 FK-78**
 180 mm

**VOLKMANN
 FK-72**
 145 mm

**VOLKMANN
 FK-73**
 170 mm









- | | | | |
|---|--|---|---|
| Fig.0000
2,8 mm
 1/1
FK-60 | Fig.000
3,6 mm
 1/1
FK-61 | Fig.00
4,4 mm
 1/1
FK-62 | Fig.0
5,2 mm
 1/1
FK-63 |
| Fig.1
6,8 mm
 1/1
FK-64 | Fig.2
8,5 mm
 1/1
FK-65 | Fig.3
10 mm
 1/1
FK-66 | Fig.4
11,5 mm
 1/1
FK-67 |

VOLKMANN
FK-60/FK-67
170 mm









COLLEGE CURETTE
MIR-10
160 mm



- | | | |
|---|---|--|
| 3 mm
 1/1
FK-110 | 4 mm
 1/1
FK-111 | 5 mm
 1/1
FK-112 |
| 6 mm
 1/1
FK-113 | 8 mm
 1/1
FK-114 | |
| 10 mm
 1/1
FK-115 | 12 mm
 1/1
FK-116 | |

BRUNS
FK-110/FK-116
165 mm



- | | | |
|--|--|--|
| 2,5 mm
 1/1
FK-120 | 3,4 mm
 1/1
FK-121 | 4,2 mm
 1/1
FK-122 |
| 5,2 mm
 1/1
FK-123 | 6,3 mm
 1/1
FK-124 | |
| 7,4 mm
 1/1
FK-125 | 8 mm
 1/1
FK-126 | |

SCHEDE
FK-120/FK-126
170 mm

Chirurgische Küretten
 Surgical Curettes
 Curette chirurgiche
 Curetas quirúrgicas
 Curettes chirurgicales



MOLT
MO-4L
 195 mm



MOLT
MO-10
 180 mm



MOLT
MO-4RT
 145 mm



MOLT
MO-4LT
 145 mm

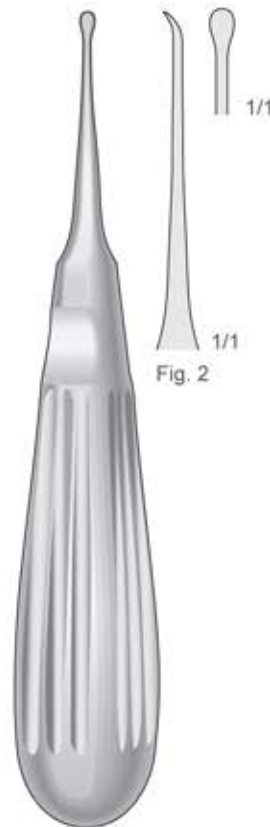

MOLT
MO-2
 145 mm

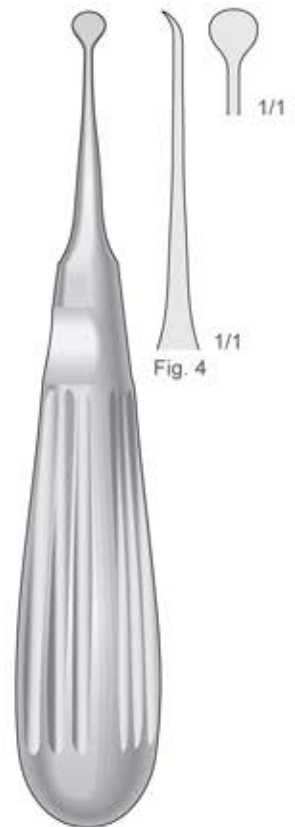

MOLT
MO-4
 145 mm

Fig. 67



HOWARD
 DO-1
 180 mm

Fig. 45

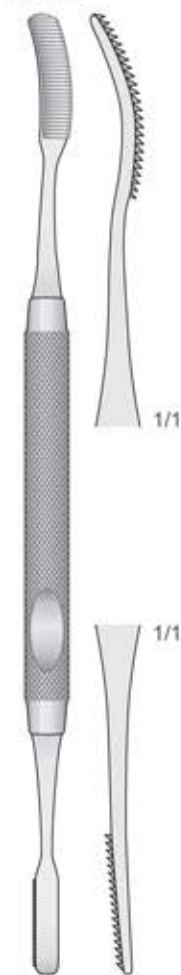

MILLER
 DO-2
 185 mm

Fig. 52

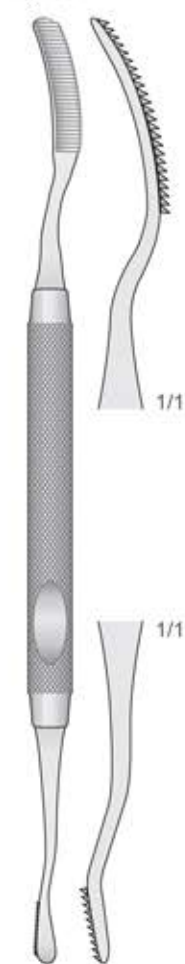

MILLER
 DO-3
 180 mm

Fig. 12

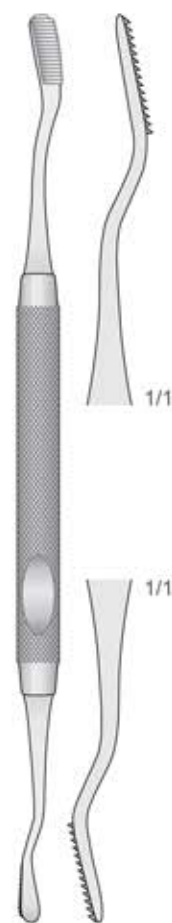

HOWARD
 DO-4
 170 mm

Fig. 12A



MILLER
 DO-4C
 170 mm

Fig. 64



MILLER
 DO-5
 175 mm

Knochenfeilen
 Bone Files
 Lime per osso
 Limas para hueso
 Limes à os

Runder Hohlgriff 8 mm
 Hollow Round Handle 8 mm
 Manico tondo vuoto 8 mm
 Mango hueco 8 mm
 Manche rond vide 8 mm



Parodontal Feilen
 Periodontal Files
 Lime parodontali
 Limas periodontales
 Limes parodontales

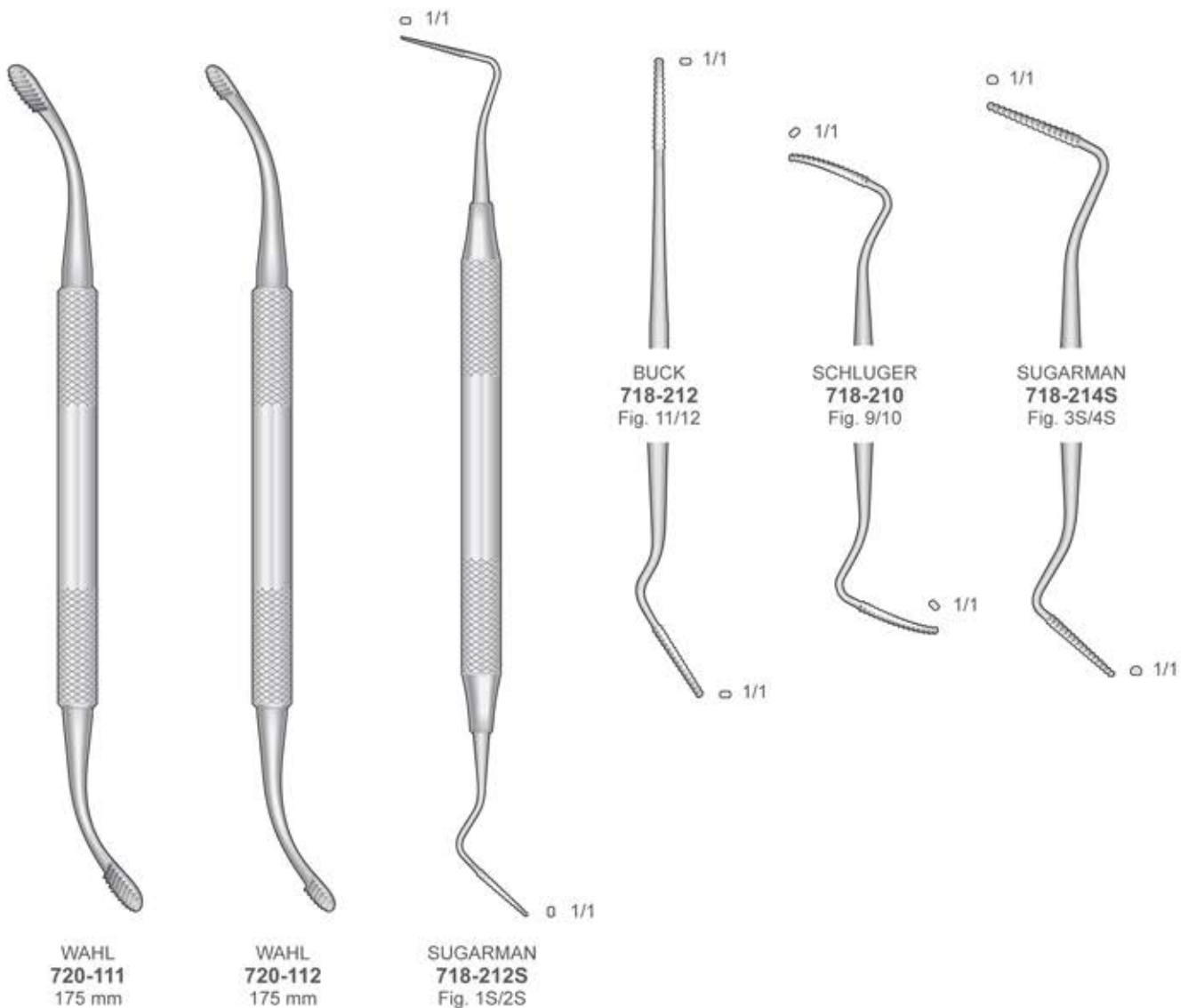

Gewebezängchen
Tissue Nippers
Tronchesi per gengive e tessuti
Pinzas para cortar tejidos
Pincas coupante pour tissue

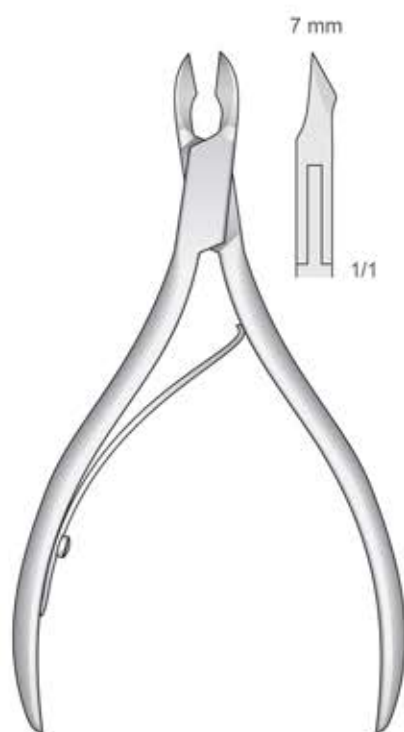

CHOEN
LX-60
105 mm

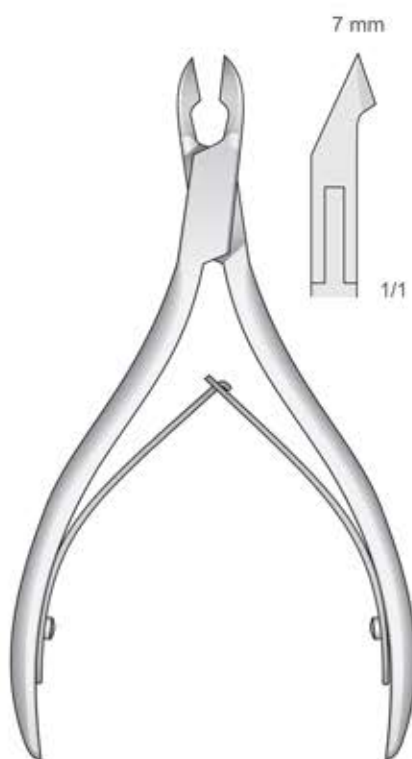

ILIC
LX-50
115 mm

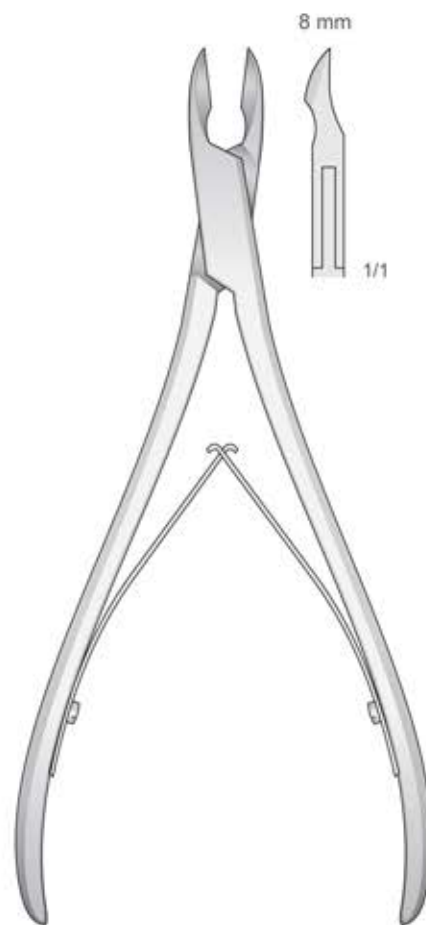

LX-52
140 mm

Hohlmeißelzangen
 Bone rongeurs
 Pinze ossivore
 Pinzas gubias
 Pincès gouges

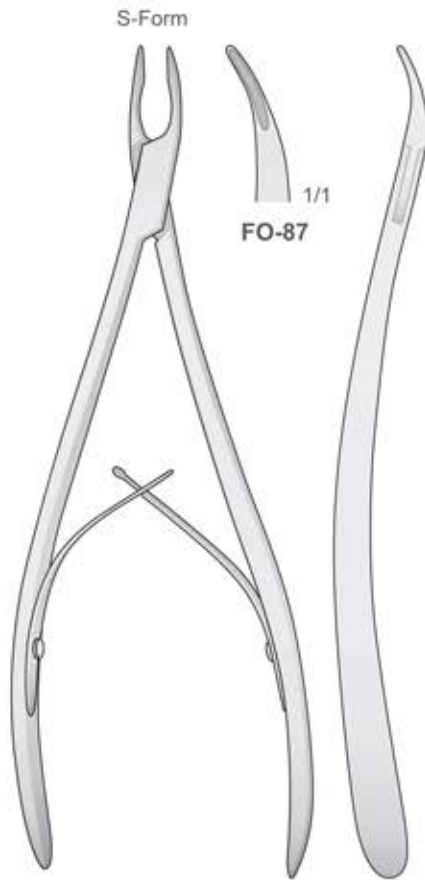

STELLBRINK
FO-87
 190 mm



STELLBRINK
FO-88/FO-89
 170 mm

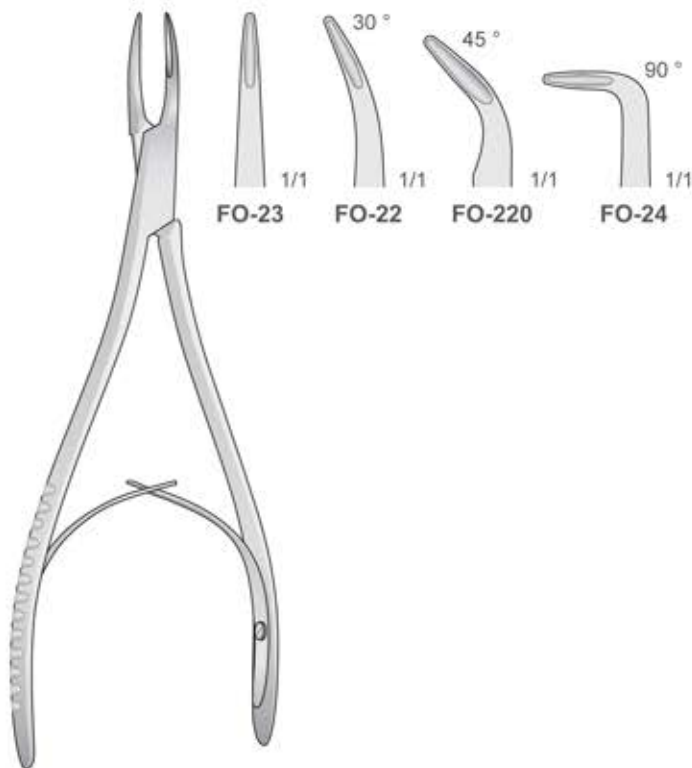

MINI-FRIEDMANN
FO-22/FO-220
 150 mm

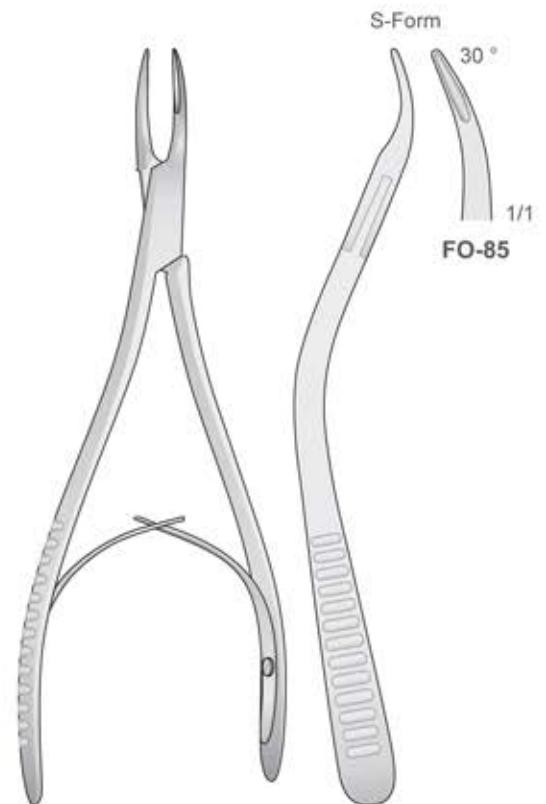

MINI-FRIEDMANN
FO-85
 145 mm

Hohlmeißelzangen
 Bone rongeurs
 Pinze ossivore
 Pinzas gubias
 Pincas gouges

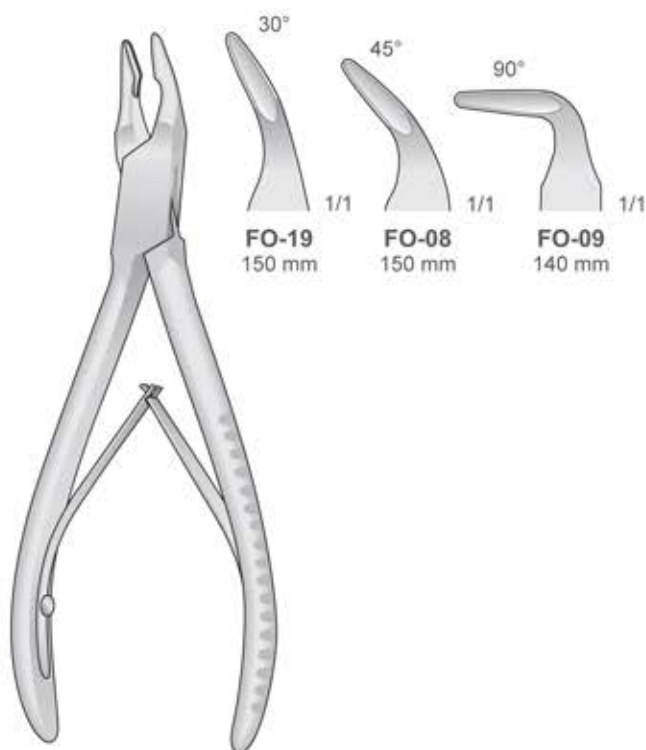

BLUMENTHAL
FO-08/FO-19

FO-19
 150 mm

FO-08
 150 mm

FO-09
 140 mm

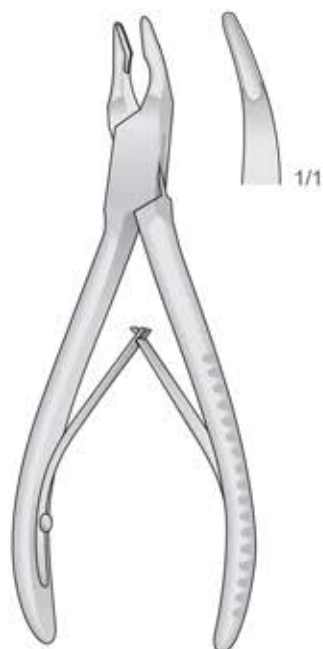

MINI FRIEDMAN
FO-15
 120 mm

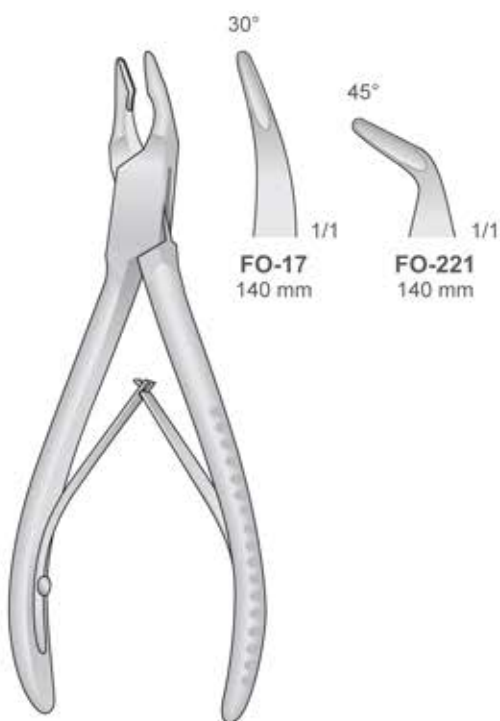

FRIEDMANN
FO-17/FO-221
 140 mm

FO-17
 140 mm

FO-221
 140 mm

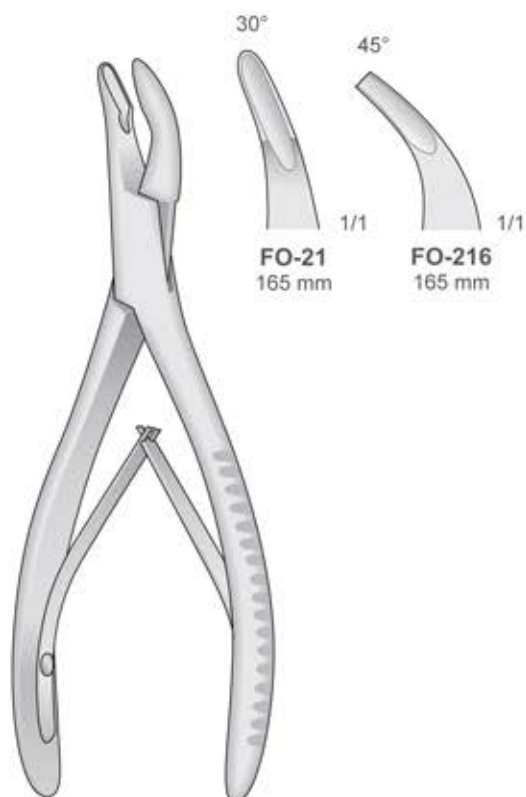

MEAD
FO-21/FO-216
 165 mm

FO-21
 165 mm

FO-216
 165 mm

Hohlmeißelzangen
 Bone rongeurs
 Pinze ossivore
 Pinzas gubias
 Pincès gouges



LEMPERT
FO-25/FO-43
 190 mm

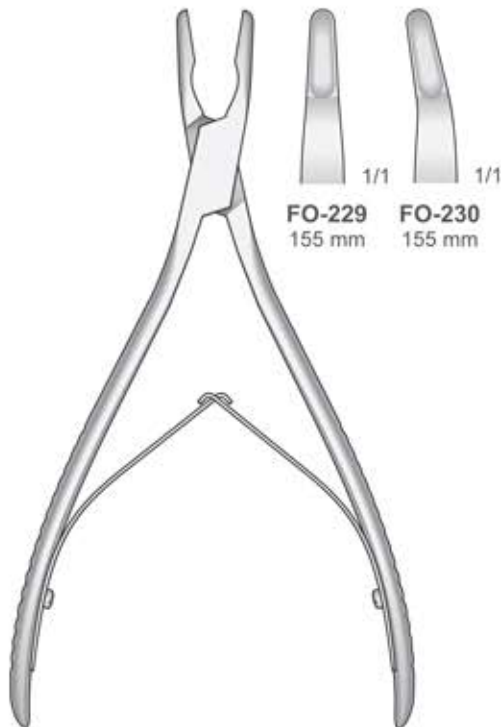

LEMPERT
FO-229/FO-230
 155 mm

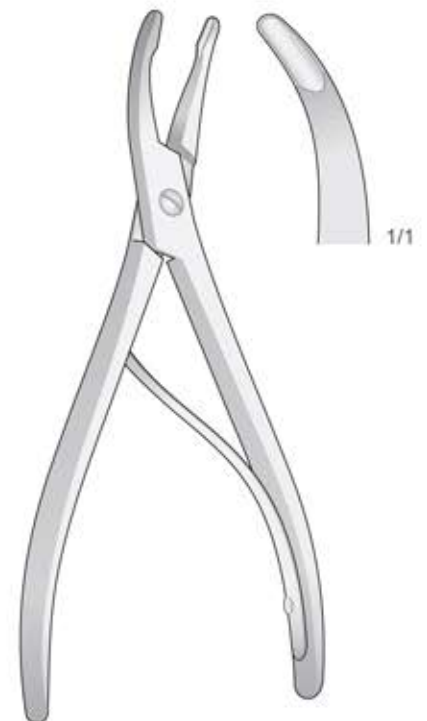

LUER
FO-18
 155 mm

Hohlmeißelzangen
 Bone rongeurs
 Pinze ossivore
 Pinzas gubias
 Pincès gouges

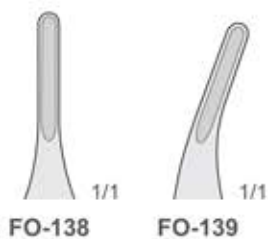
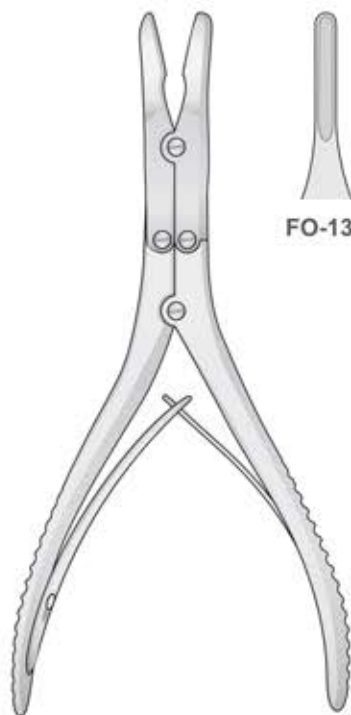

RUSKIN
 FO-138/FO-139
 150 mm

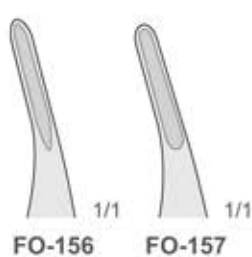
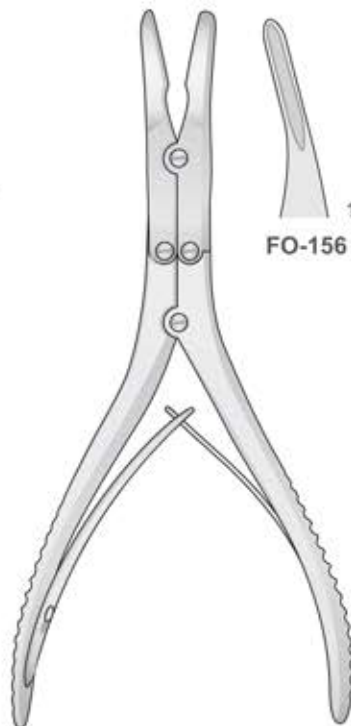

KLEINERT-KUTZ
 FO-156/FO-157
 155 mm

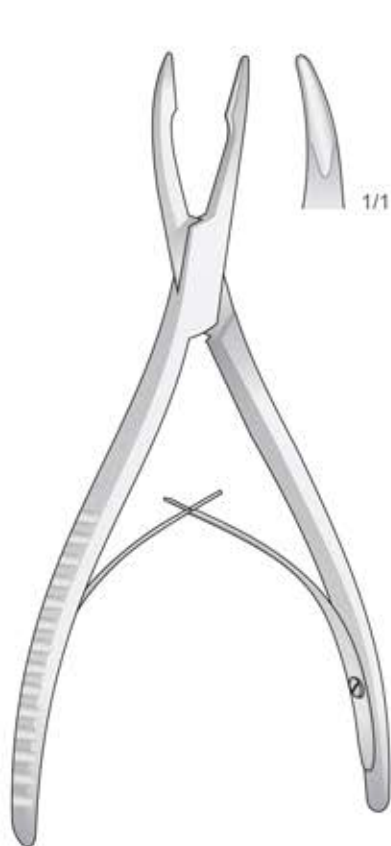

FRIEDMANN
 FO-16
 160 mm



BEYER
 FO-20
 180 mm



ZAUFAL-JANSEN
 FO-34
 180 mm

Hohlmeißelzangen
 Bone rongeurs
 Pinze ossivore
 Pinzas gubias
 Pincès gouges



CLEVELAND
FO-231 140 mm
FO-232 170 mm



CLEVELAND
FO-233 150 mm
FO-234 170 mm

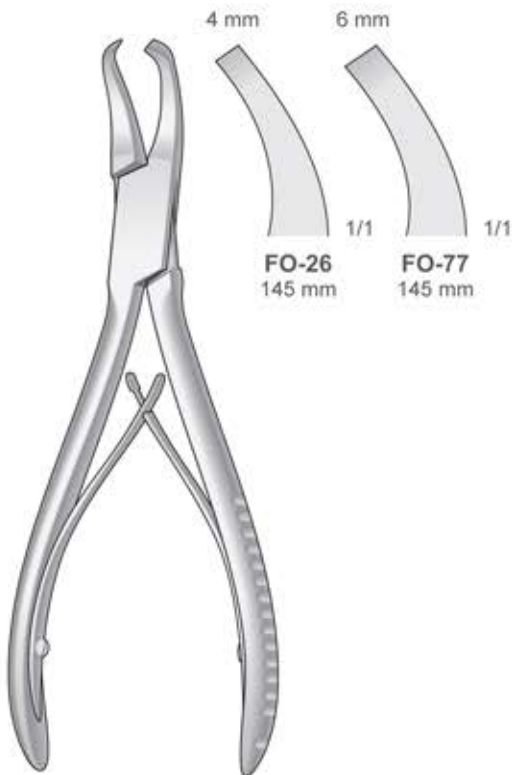

GARDNER
FO-26/FO-77
 145 mm

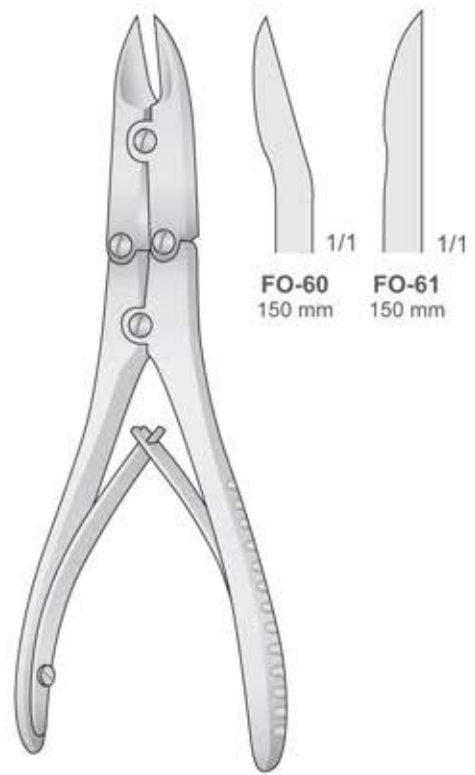

BÖHLER
FO-60/FO-61
 150 mm

Punches - Stanzen

Bone cutting forceps
for opening the Sinus
Strumento tagliente per
aumentare il volume del seno

Knochensplitterzangen
Bone cutting forceps
Pinze ossivore
Pinzas cortantes para huesos
Pincas coupantes à os

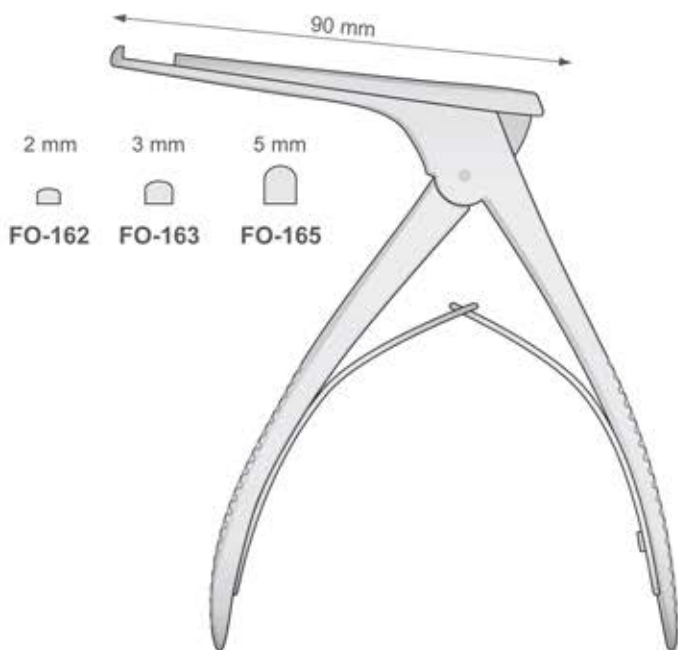

KERRISON
FO-162 2 mm
FO-163 3 mm
FO-165 5 mm

Bone cutting forceps
for opening the Sinus
Strumento tagliente per
aumentare il volume del seno

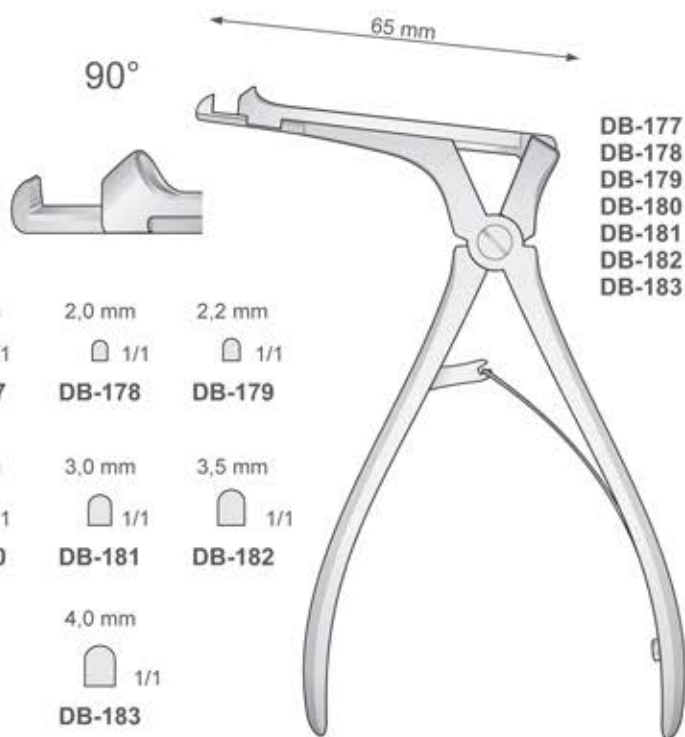

CITELLI
DB-177/DB-183

Fig.
R-18

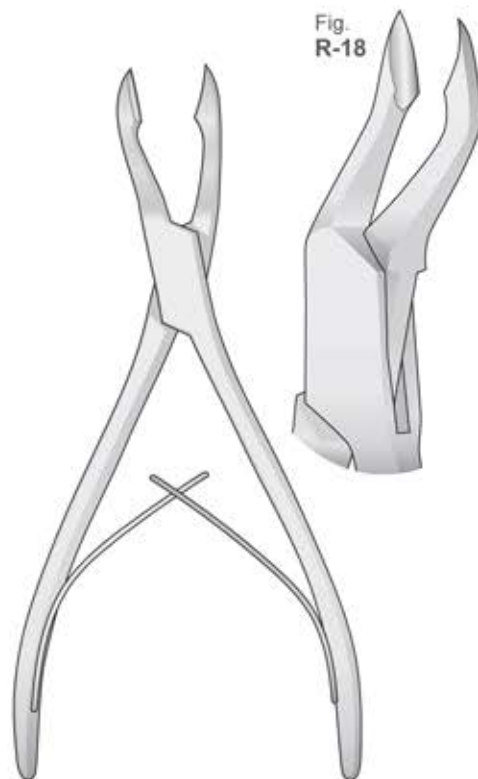

FO-33
 175 mm

K

Periodontology

Parodontologie
Parodontie
Periodoncia
Parodontologia

Diagnosis

Diagnose
Diagnostic
Diagnóstico
Diagnosi

Dental Restoration

Restaurative Zahnheilkunde
Odontologie conservatrice
Odontologia conservadora
Odontoiatria conservativa



BROMED
INSTRUMENTS

Zahnsonden
Explorers - Sickle Probes
Esploratori - Sonde falce
Sondas exploradoras
Sondes exploratrices



SO-1
Fig. 23



SO-2
Fig. 11



SO-3
Fig. 6



SO-4
Fig. 9



SO-5
Fig. 2



SO-6
Fig. 10

Zahnsonden
Explorers - Sickle Probes
Esploratori - Sonde falce
Sondas exploradoras
Sondes exploratrices



SO-7
Fig. 12



SO-8
Fig. 6A



SO-9
Fig. 8A



SO-10
Fig. 17A



SO-11
Fig. 3A



SO-12
Fig. 3

Parodontometer
 Periodontal Probes
 Sonde parodontali
 Sondas parodontales
 Sondes parodontales

Do not sterilizing with ultra sound - Not Metal brushes
 Non sterilizzare in ultrasuoni - No spazzola metallica



CP-11
SM-11
 160 mm



CP-12
SM-12
 160 mm

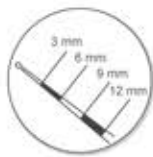

CP-12S
SM-13
 160 mm

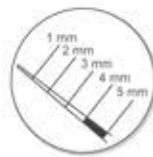

CP-15UNC
SM-15
 160 mm



WHO
SM-21
 160 mm



CP-10
SM-19
 160 mm

Double-ended Explorer
 Doppelendiger Zahnsonden
 Sonde esploratrice double
 Sonda exploradora doble
 Sonda falce doppia



11/12 ODU
SO-20
 165 mm



UT3/4 CATTONI
SM-20
 165 mm

3 - 6 - 9 - 12



12 - 9 - 6 - 3

2QN NABERS
SM-22
 175 mm

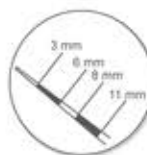

23 CP-11
EX-11



23 CP-12
EX-12

Parodontometer
 Periodontal Probes
 Sonde parodontali
 Sondas parodontales
 Sondes parodontales

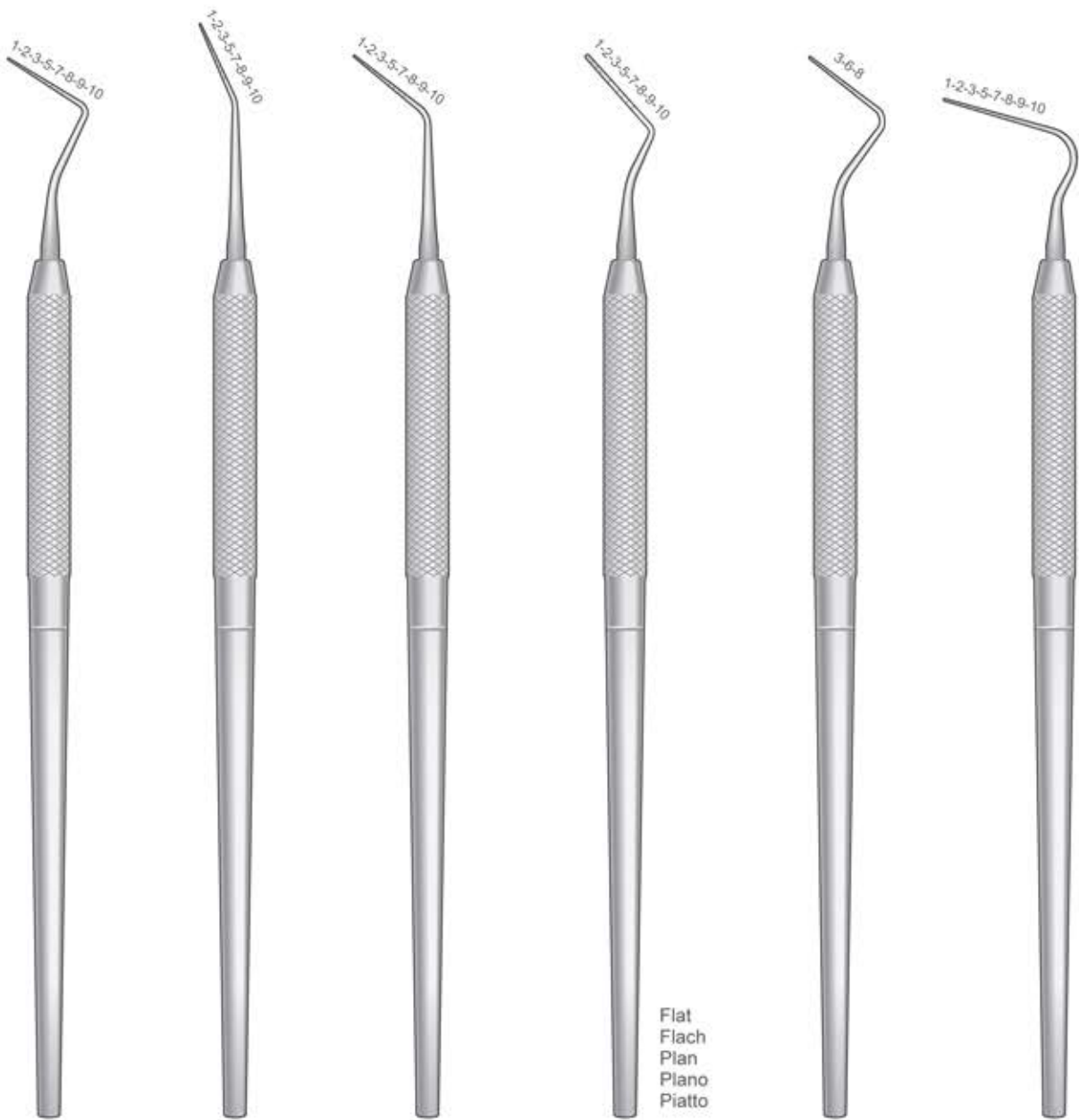

WILLIAMS
 SM-1

MERRITT A
 SM-2

MERRITT B
 SM-3

GOLDMAN-FOX
 SM-4

Flat
 Flach
 Plan
 Plano
 Piatto

UNIVERSITY
 OF MICHIGAN
 SM-5

26 G
 SM-6



LUKS
 PL-1
 Fig.1

LUKS
 PL-2
 Fig.2

LUKS
 PL-3
 Fig.3

LUKS
 PL-4
 Fig.4

PZ-1
 Fig.1

PZ-2
 Fig.2

PZ-3
 Fig.3

PZ-4
 Fig.4

Spreaders

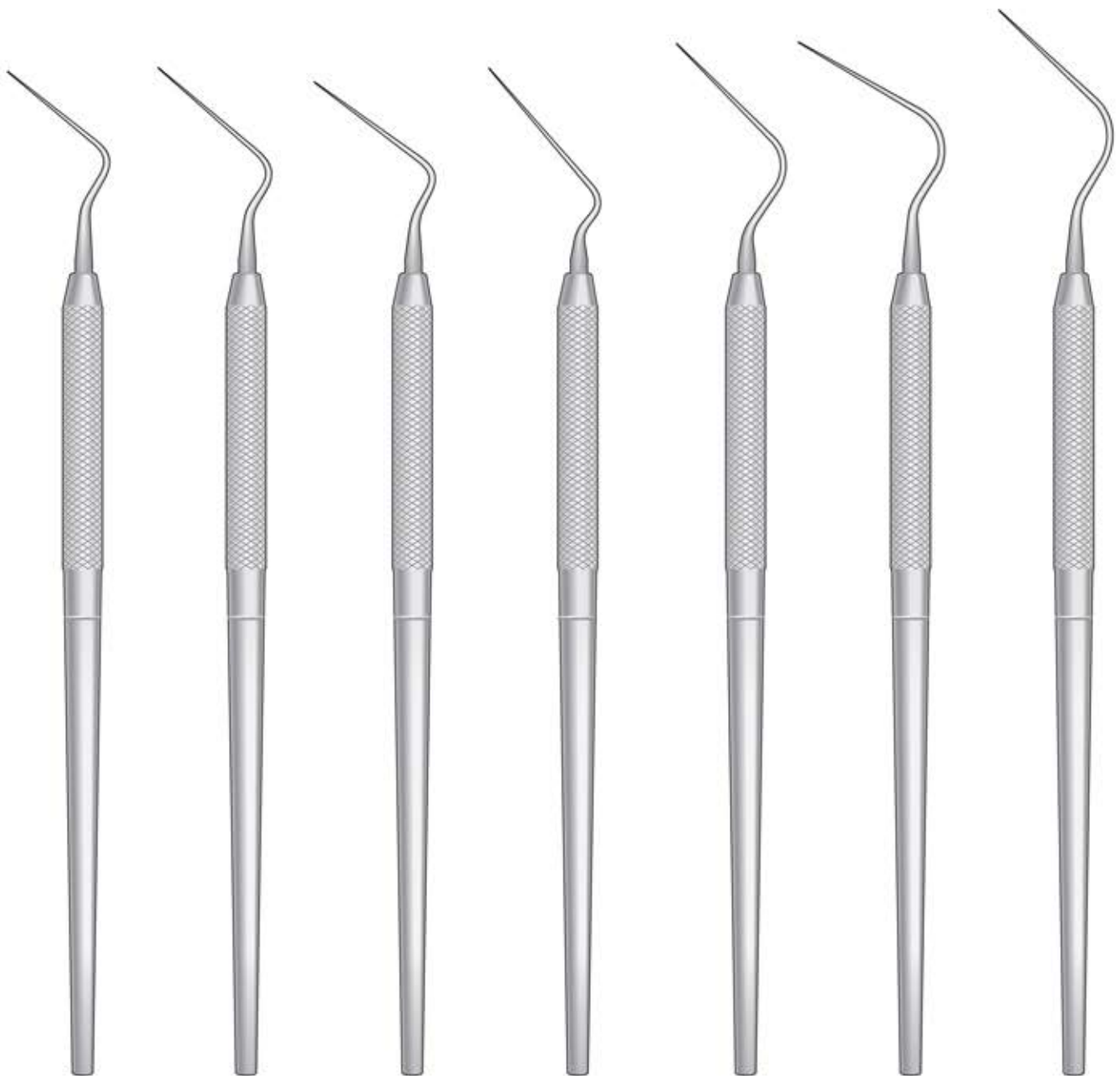
**SP-1**
Fig.1S**SP-2**
Fig.2S**SP-3**
Fig.D11**SP-4**
Fig.MA57**SP-5**
Fig.0**SP-6**
Fig.00**SP-7**
Fig.3

Tamponstopfer
 Gauze Packers
 Porta tamponi
 Portatampones
 Porte tampons

 LUNIATSCHEK
PF-6
 170 mm

 UNIVERSAL
PF-40
 140 mm

 UNIVERSAL
PF-41
 180 mm

Mundspiegel und Griffe
Mirrors and handles
Specchietti e manici
Espejos y mangos
Miroirs et manches

Rhodiumspiegel
Rhodium Mirror
Specchietto rodato
Espejo de rodio
Miroir au rhodium

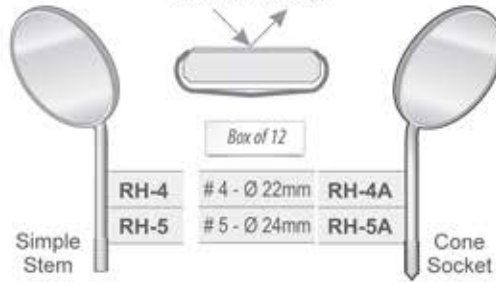
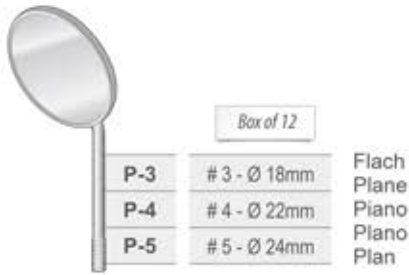

Massiv - Solid
Pieno - Sólido - Solide

Hohl - Hollow
Vuoto - Hueco - Creux



Spiegeldurchmesser - Diameter of mirrors
Diametro dello specchio - Diamètre des miroirs
Diámetro de los espejos

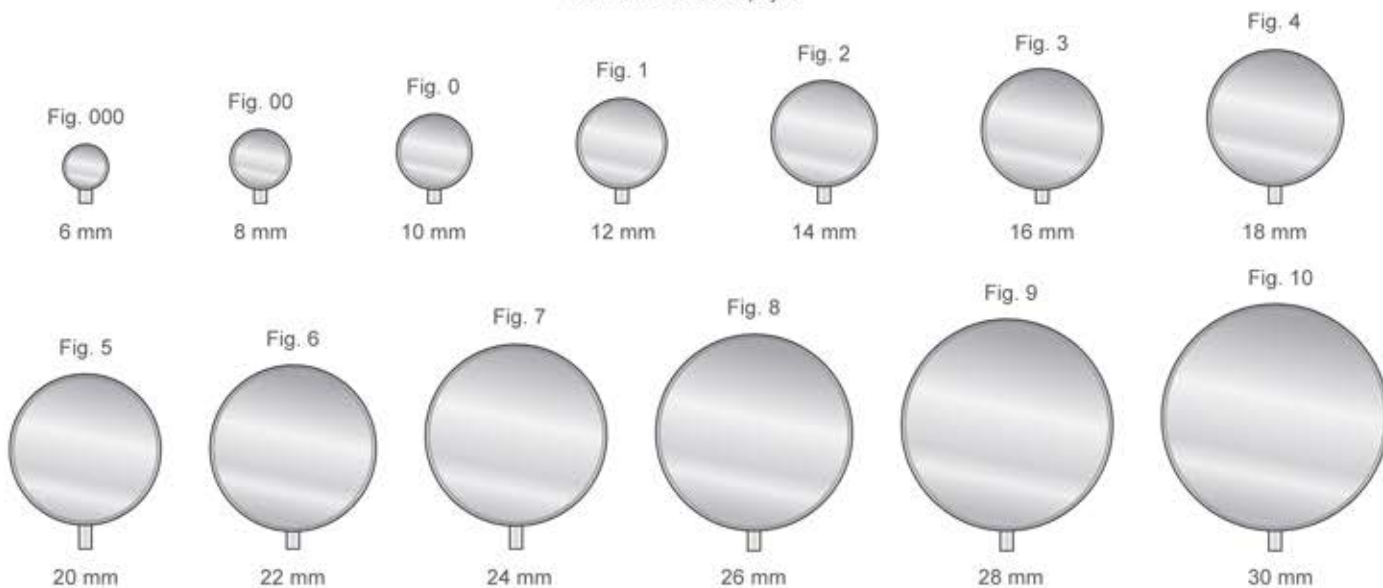

Kehlkopfspiegel mit Sechskantgriff
Laryngeal mirrors with hexagonal handle
Specchietto laringeo con manico esagonale
Espejo laringeo con mango hexagonal
Miroirs laryngiens avec manche hexagonal

- G-8 Fig. 00
- G-10 Fig. 0
- G-12 Fig. 1
- G-14 Fig. 2
- G-16 Fig. 3
- G-18 Fig. 4
- G-20 Fig. 5
- G-22 Fig. 6
- G-24 Fig. 7
- G-26 Fig. 8
- G-28 Fig. 9
- G-30 Fig. 10

G-8/G-30
180 mm



Spiegelgriff
Mirrors handle
Manico per specchietti
Mango para espejos
Manche à miroir

Verchromt
Chromium
Cromato
Cromado
Chromé

MA-6
120 mm



Kehlkopfspiegel
Laryngeal mirrors
Specchietto laringeo
Espejos laringeos
Miroirs laryngiens

- P-000 Fig. 000
- P-00 Fig. 00
- P-0 Fig. 0
- P-01 Fig. 1
- P-02 Fig. 2
- P-03 Fig. 3
- P-04 Fig. 4
- P-05 Fig. 5
- P-06 Fig. 6

P-000/P-06
120 mm

Dental-Spritzen
 Dental Syringes
 Siringhe dentali
 Jeringas dentales
 Seringues dentaires



SD-8
 Aspirating
 for Imperial Tip
 (North America)
 140mm



SD-8NA
 Self Aspirating
 for Imperial Tip
 (North America)
 140mm

SD-8M
 Self Aspirating
 for Metric Tip
 (Europe)
 140mm

Spritzen zur lokalen Interligamentär-Anästhesie
 Syringes for Intraligamental anaesthesia
 Siringa per anestesia intraligamentare
 Jeringa intraligamentaria para anestesia
 Seringues pour anesthésies intraligamentaires

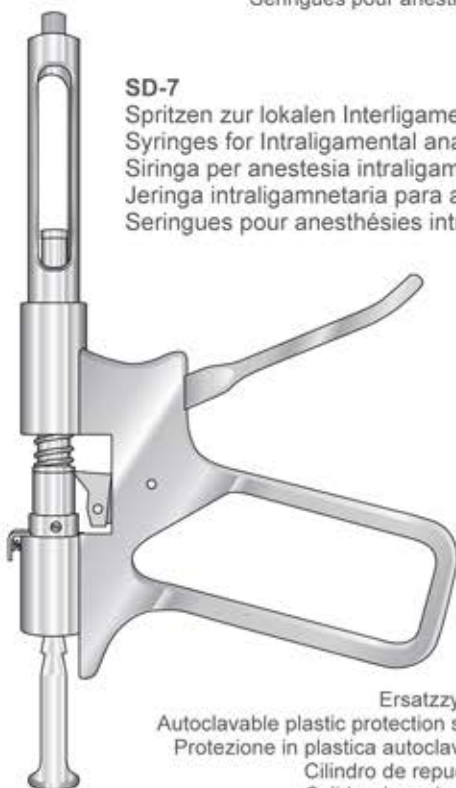

SD-7
 Spritzen zur lokalen Interligamentär-Anästhesie
 Syringes for Intraligamental anaesthesia
 Siringa per anestesia intraligamentare
 Jeringa intraligamentaria para anestesia
 Seringues pour anesthésies intraligamentaires

SD-7R
 Ersatzzylinder für SD-7
 Autoclavable plastic protection sleeve for SD-7
 Protezione in plastica autoclavabile per SD-7
 Cilindro de repuesto para SD-7
 Cylindre de rechange pour SD-7



SD-20

1.8 ml

110 mm

10 mm

Zylinder-Ampullen Spritzen
Cartridge Syringes
Siringhe per tubofiale
Jeringas de ampollas
Seringues d'ampoules

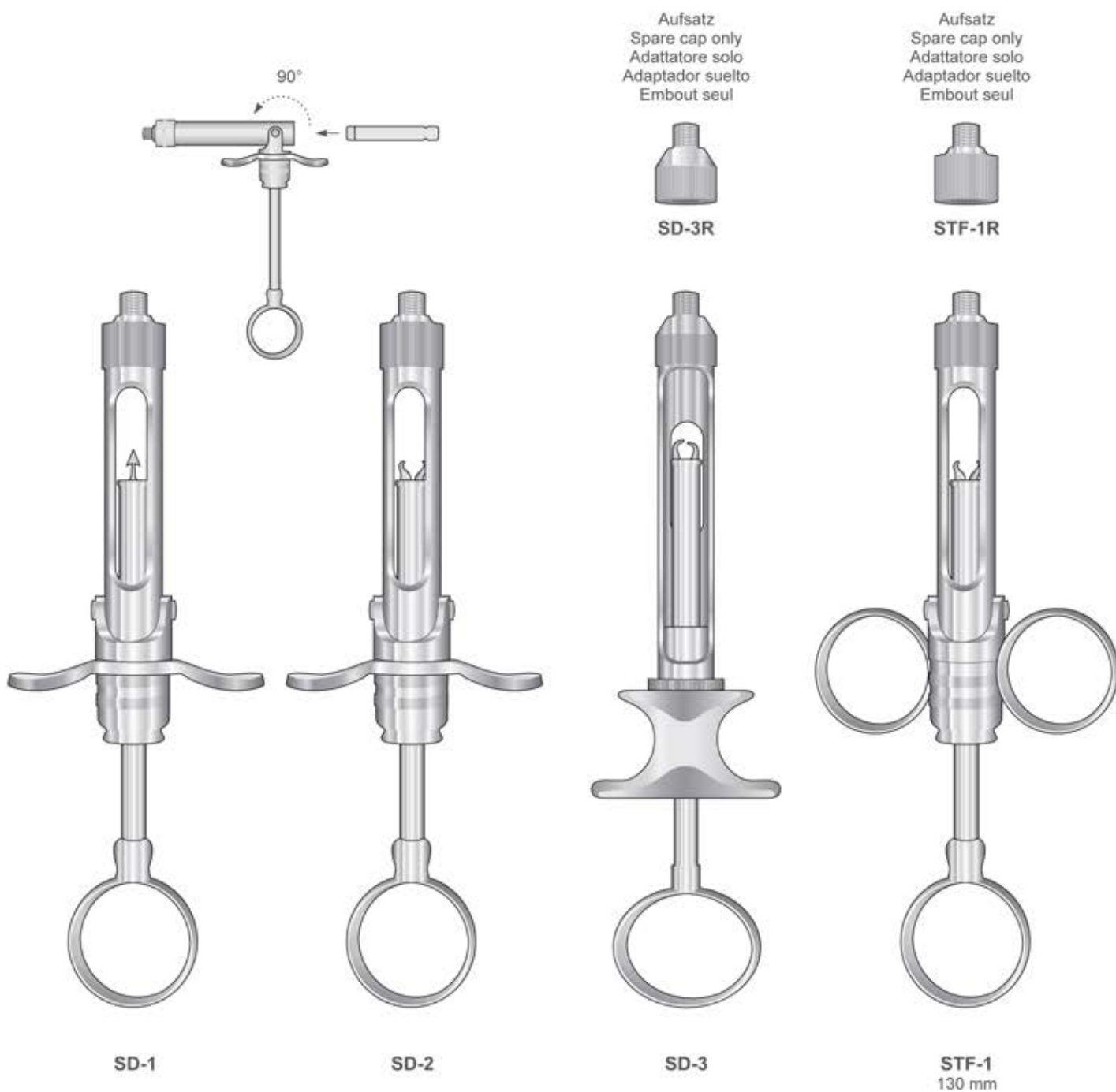

Küretten
 Curettes
 Curette
 Curetas
 Curettes



GRACEY
 CU-1/2



GRACEY
 CU-3/4



GRACEY
 CU-5/6



GRACEY
 CU-7/8



GRACEY
 CU-9/10



GRACEY
 CU-11/12



GRACEY
 CU-13/14



LANGER Fig. 1/2
 COL-1/2



LANGER Fig. 3/4
 COL-3/4



COLUMBIA
 COL-2RL



COLUMBIA
 COL-4RL



COLUMBIA
 COL-13/14

Elite Extra Thin

American made, German approved
Elite Curettes



Hollow
Hohl
Creux
Hueco
Vuoto



Ø 9 mm



USG-1/2ET
Gracey
Curette 1/2ET



USG-3/4ET
Gracey
Curette 3/4ET



USG-5/6ET
Gracey
Curette 5/6ET



USG-7/8ET
Gracey
Curette 7/8ET



USG-9/10ET
Gracey
Curette 9/10ET



USG-11/12ET
Gracey
Curette 11/12ET



USG-13/14ET
Gracey
Curette 13/14ET



USG-15/16ET
Gracey
Curette 15/16ET

Elite Scalers and Curettes Extra Thin

Balanced and ergonomic for great tactile working ability.

Extra light hollow handle for optimum comfort (feather weight / round Ø 9 mm).

Maintains long sharp edges.

Elite
 Scaler und Küretten
 Scalers and Curettes
 Scaler e Curette
 Raspadores y Curetas
 Détartreurs et Curettes



Hollow
 Hohl
 Creux
 Hueco
 Vuoto



Ø 9 mm

Elite

American made, German approved
 Elite Scalers and Curettes



USG-1/2
 Gracey
 Curette 1/2



USG-3/4
 Gracey
 Curette 3/4



USG-5/6
 Gracey
 Curette 5/6



USG-7/8
 Gracey
 Curette 7/8



USG-9/10
 Gracey
 Curette 9/10



USG-11/12
 Gracey
 Curette 11/12



USG-13/14
 Gracey
 Curette 13/14



USG-1/2S
 Gracey
 Curette 1/2S



USG-3/4S
 Gracey
 Curette 3/4S



USG-5/6S
 Gracey
 Curette 5/6S



USG-7/8S
 Gracey
 Curette 7/8S



USG-9/10S
 Gracey
 Curette 9/10S



USG-11/12S
 Gracey
 Curette 11/12S



USG-13/14S
 Gracey
 Curette 13/14S

Elite Scalers and Curettes

Balanced and ergonomic for great tactile working ability.
 Extra light hollow handle for optimum comfort (feather weight / round Ø 9 mm).
 Maintains long sharp edges.



Elite

American made, German approved
Elite Scalers and Curettes



Hollow
Hohl
Creux
Hueco
Vuoto

Ø9 mm



Elite
Scaler und Küretten
Scalers and Curettes
Scaler e Curette
Raspadores y Curetas
Détartreurs et Curettes



USG-1/2L
Gracey
Curette 1/2L



USG-3/4L
Gracey
Curette 3/4L



USG-5/6L
Gracey
Curette 5/6L



USG-7/8L
Gracey
Curette 7/8L



USG-9/10L
Gracey
Curette 9/10L



USG-11/12L
Gracey
Curette 11/12L



USG-13/14L
Gracey
Curette 13/14L



USG-15/16
Gracey
Curette 15/16



USG-17/18S
Gracey
Curette 17/18S



USS-KRA1
Kramer
Curette 1



USS-KRA3
Kramer
Curette 3



USG-KN1/26
Kramer-Nevins
Chisels 1/2



USS-MC11/12
McCall
Scaler 11/12



USS-MC13/14
McCall
Curette 13/14



USS-MC13/14S
McCall
Curette 13S/14S



USS-MC17/18S
McCall
Curette 17S/18S



USC-2RL
Columbia
Curette 2RL



USC-4RL
Columbia
Curette 4RL



USC-13/14
Columbia
Curette 13/14



USS-5/6LAN
Langer
Curette 5/6

Elite
 Scaler und Küretten
 Scalers and Curettes
 Scaler e Curette
 Raspadores y Curetas
 Détartreurs et Curettes



Hollow
 Hohl
 Creux
 Hueco
 Vuoto



Ø 9 mm

Elite

American made, German approved
 Elite Scalers and Curettes

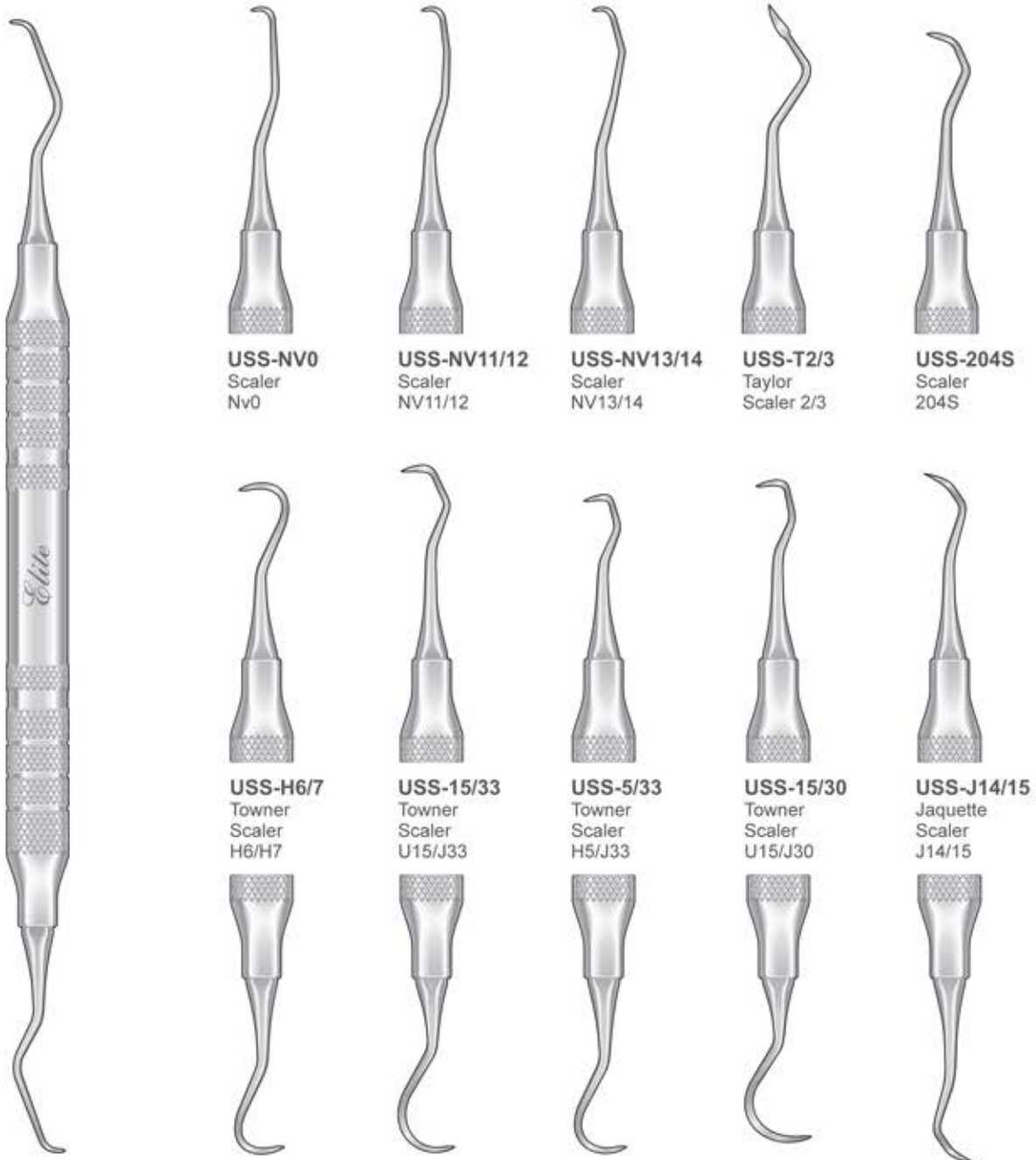

USS-NV0
 Scaler
 NV0

USS-NV11/12
 Scaler
 NV11/12

USS-NV13/14
 Scaler
 NV13/14

USS-T2/3
 Taylor
 Scaler 2/3

USS-204S
 Scaler
 204S

USS-H6/7
 Towner
 Scaler
 H6/H7

USS-15/33
 Towner
 Scaler
 U15/J33

USS-5/33
 Towner
 Scaler
 H5/J33

USS-15/30
 Towner
 Scaler
 U15/J30

USS-J14/15
 Jaquette
 Scaler
 J14/15

Elite Scalers and Curettes

Balanced and ergonomic for great tactile working ability.
 Extra light hollow handle for optimum comfort (feather weight / round Ø 9 mm).
 Maintains long sharp edges.

Elite Titanium
Scaler und Küretten
Scalers and Curettes
Scaler e Curette
Raspadores y Curetas
Détartreurs et Curettes

Elite TITANIUM

American made, German approved
Elite Scalers and Curettes



Hollow
Hohl
Creux
Hueco
Vuoto



Ø 9 mm

Designed for removing calculus on implants surfaces.
Gold coloured handle with a titanium coating for easy identification purposes
so they won't be mixed up with standard stainless instruments.



T-USG-1/2
Gracey
Curette 1/2



T-USG-5/6
Gracey
Curette 5/6



T-USG-7/8
Gracey
Curette 7/8



T-USG-11/12
Gracey
Curette 11/12



T-USG-13/14
Gracey
Curette 13/14



T-USS-YG7/8
Younger-Good
Curette YG 7/8



T-USS-B5/6
Barnhart
Curette 5/6

Titanium Elite Scalers and Curettes

Balanced and ergonomic for great tactile working ability.
Extra light hollow handle for optimum comfort (feather weight / round Ø 9 mm).
Maintains long sharp edges.

⚠ Use a dedicated sharpening stone for Titanium Scalers & Curettes. / Do not sterilize with non titanium instruments.

Küretten - Feilen
 Curettes - Files
 Curette - Lime
 Curetasc - Lima
 Curettes - Limes

Universal Küretten
 Universal Curettes
 Curette universali
 Curetas universales
 Curettes universelles

Parodontalfeilen
 Periodontal Files
 Lime parodontali
 Limas parodontales
 Limes parodontales

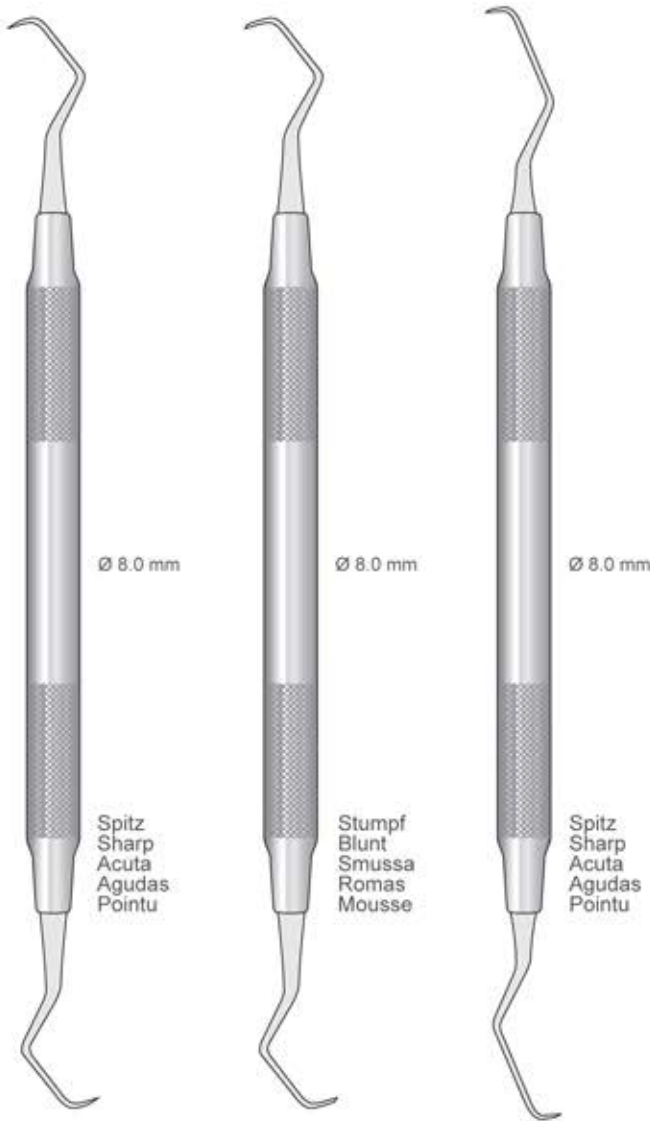

718-M23
165 mm

718-M23A
165 mm

718-M23B
170 mm

HIRSCHFELD
HF-3/7
170 mm

HIRSCHFELD
HF-5/11
170 mm

HIRSCHFELD
HF-9/10
175 mm

Scaler
 Scalers
 Ablatori di tartaro
 Limpiadores
 Dé tartreurs

Scalers

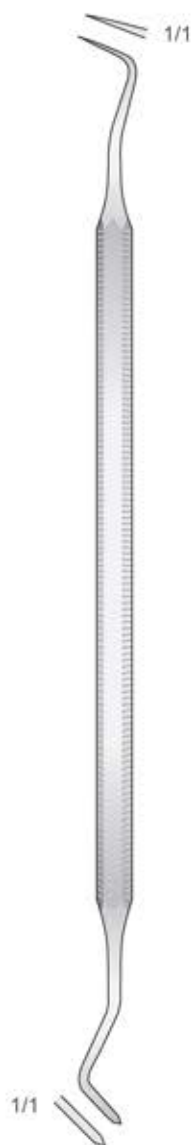

LANGE
 PF-9
 160 mm



MITCHEL
 AT-12
 170 mm



AT-1



AT-2R



AT-2L



AT-6

Amalgampistole für retrograde
 Amalgam gun for retrograde
 Siringhe portamalgame retrogradi
 Portaamalgame para retrógradas
 Porte-amalgame pour rétrogrades

Nach oben Gebogen - Curved up
 Curva in avanti - Curvas hacia arriba
 Courbes vers le haut
 Ø 0,9 mm

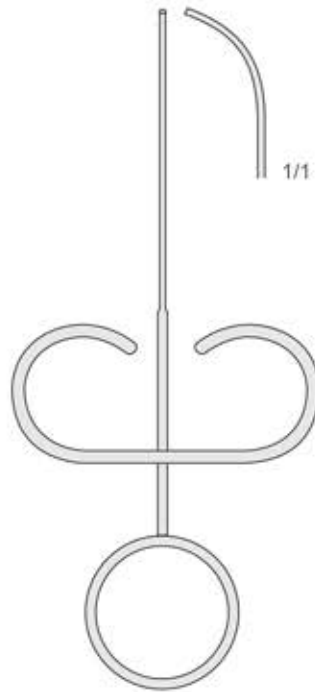

SS-51
 130 mm

Seitwärts Gebogen - Curved to side
 Curva sul lato - Curvas laterales
 Courbes latérales
 Ø 0,9 mm

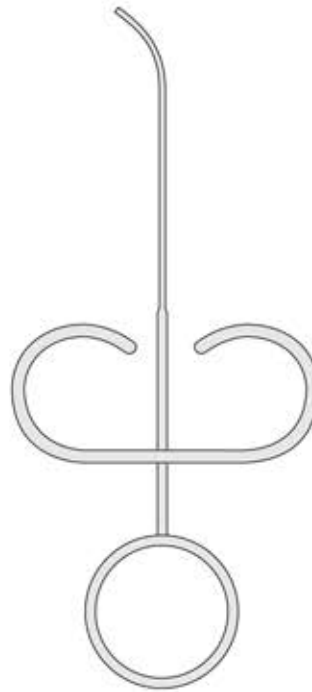

SS-55
 130 mm

Gerade - Straight
 Diritta - Rectas
 Droites
 Ø 1,2 mm

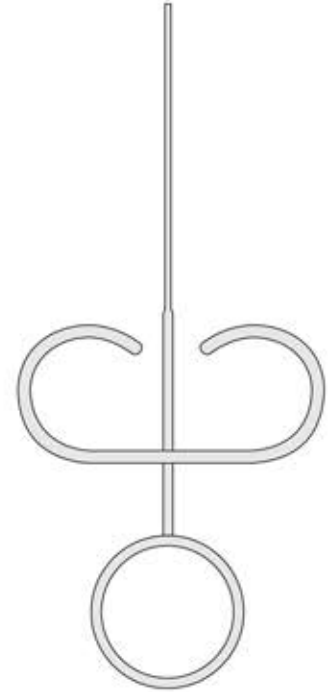

SS-54
 130 mm

Seitwärts Gebogen - Curved to side
 Curva sul lato - Curvas laterales
 Courbes latérales
 Ø 1,2 mm

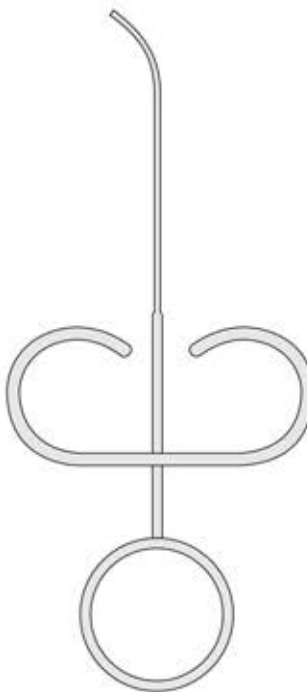

SS-56
 130 mm

Nach oben Gebogen - Curved up
 Curva in avanti - Curva hacia arriba
 Courbes vers le haut
 Ø 1,2 mm

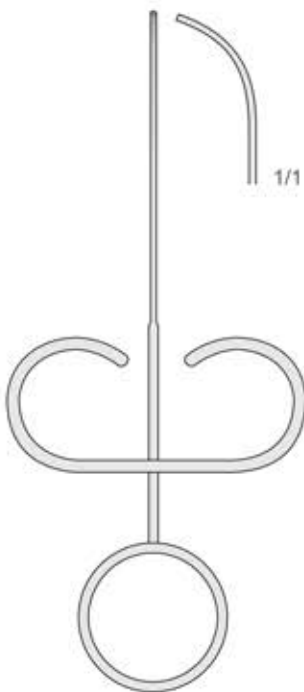

SS-58
 130 mm

Seitwärts Gebogen - Curved to side
 Curva sul lato - Curvas laterales
 Courbes latérales
 Ø 1,8 mm

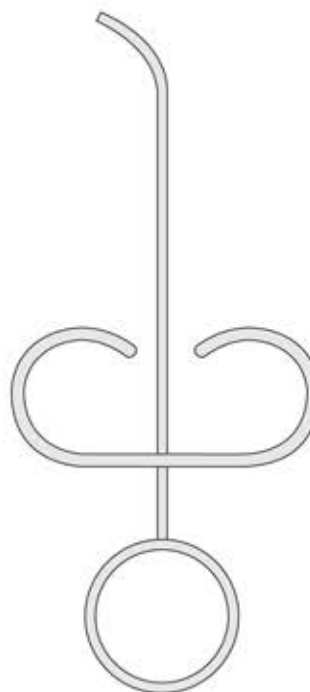

SS-50
 130 mm

Nach oben Gebogen - Curved up
 Curva in avanti - Curvas hacia arriba
 Courbes vers le haut
 Ø 1,8 mm

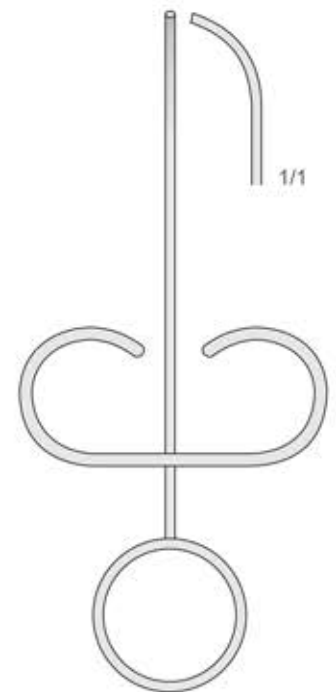

SS-52
 130 mm

Amalgamträger
Amalgam Carriers
Porta amalgama
Porta-amalgamas
Porte-amalgames

Amalgambecher
Amalgam Well
Mortajo per amalgama
Vaso para amalgama
Gobelet pour amalgame



SS-65
Ø 35 mm
h. 35 mm



SS-15

Aus Metall
Metal tip
In metallo
De metal
En métal



SS-16



SS-41
170 mm

Autoclavable
Aus Kunststoff
Plastic tip
In plastica
De plástico
En plastique



SS-42
160 mm

Kompositinstrumente
 Composite Instruments
 Strumenti per composito
 Instrumentos para composites
 Instruments pour composites



Titanium-coated
 Titan-beschichtet
 Recouvrement en Titane
 Recubrimiento de Titanio
 Ricoperto in Titanio

Fig. FE1

Fig. FE2

Fig. FE3

Fig. FE4

Fig. FE5

Fig. FE6

Fig. GO1

Fig. GO2

Fig. GO3

Fig. GO4

 FELT
 OT-1

 FELT
 OT-2

 FELT
 OT-3

 FELT
 OT-4

 FELT
 OT-5

 FELT
 OT-6

 GOLDSTEIN
 OT-7

 GOLDSTEIN
 OT-8

 GOLDSTEIN
 OT-9

 GOLDSTEIN
 OT-10



Titanium-coated
Titan-beschichtet
Recouvrement en Titane
Recubrimiento de Titanio
Ricoperto in Titanio

Fig. CP1
1,5 mm



OT-11

Fig. CP2
2,0 mm



OT-12

Fig. CP3
2,0 mm



OT-13

Fig. CP4
2,5 mm



OT-14

Fig. CP5



OT-15

Fig. CP6



OT-16

Kompositinstrumente
 Composite Instruments
 Strumenti per composito
 Instrumentos para composites
 Instruments pour composites



FELT FE-1 FELT FE-2 FELT FE-3 FELT FE-4 FELT FE-5 FELT FE-6 FELT FE-4/5 GOLDSTEIN GO-1 GOLDSTEIN GO-2 GOLDSTEIN GO-3 GOLDSTEIN GO-4

Zementspatel
Cement Spatulas
Spatole per cemento
Espátulas para cemento
Spatules à ciment



SR
140 mm



S-00
180 mm



S-0
185 mm



S-1
180 mm



S-2
180 mm



S-3
180 mm



S-4
200 mm



Füllungsinstrumente
 Filling Instruments
 Strumenti per otturazione
 Instrumentos para obturación
 Instruments pour obturation

Heidemann-Spateln
 Heidemann Spatulas
 Spatole Heidemann
 Espátulas Heidemann
 Spatules Heidemann

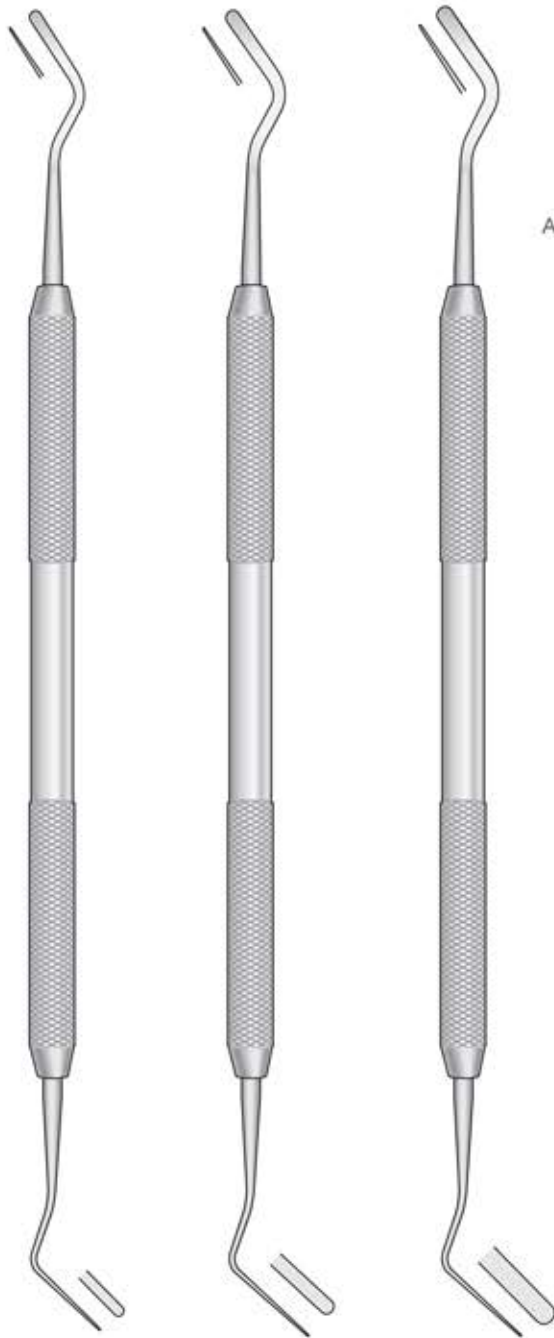

H-1
Fig. 1

H-2
Fig. 2

H-3
Fig. 3

Dycal Applikator
 Placement Instrument
 Applicatore per sottofondo
 Aplicadores de fondo
 de cavidades
 Applicateur de fond
 de cavité



A-1
125 mm

Amalgam Instrumente
 Amalgam Carvers
 Strumenti per modellare l'amalgama
 Instrumentos para modelar las obturaciones
 Instruments à modeler l'amalgame

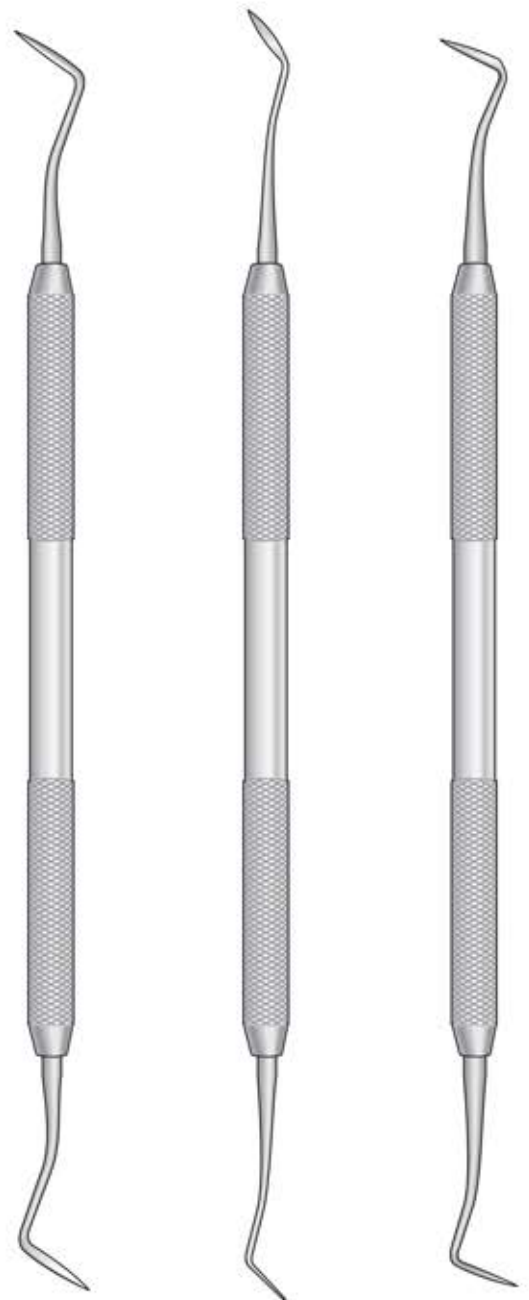

R-1
HOLLENBACH
1 - 165 mm

R-2
HOLLENBACH
1/2 - 165 mm

R-3
HOLLENBACH
3 - 165 mm

Instrument für Drahrückzug
 Instrument for retractor wire
 Strumento per filo retrattore
 Instrumento para hilo separador
 Instruments pour fil séparateur

Cleoids - Discoids

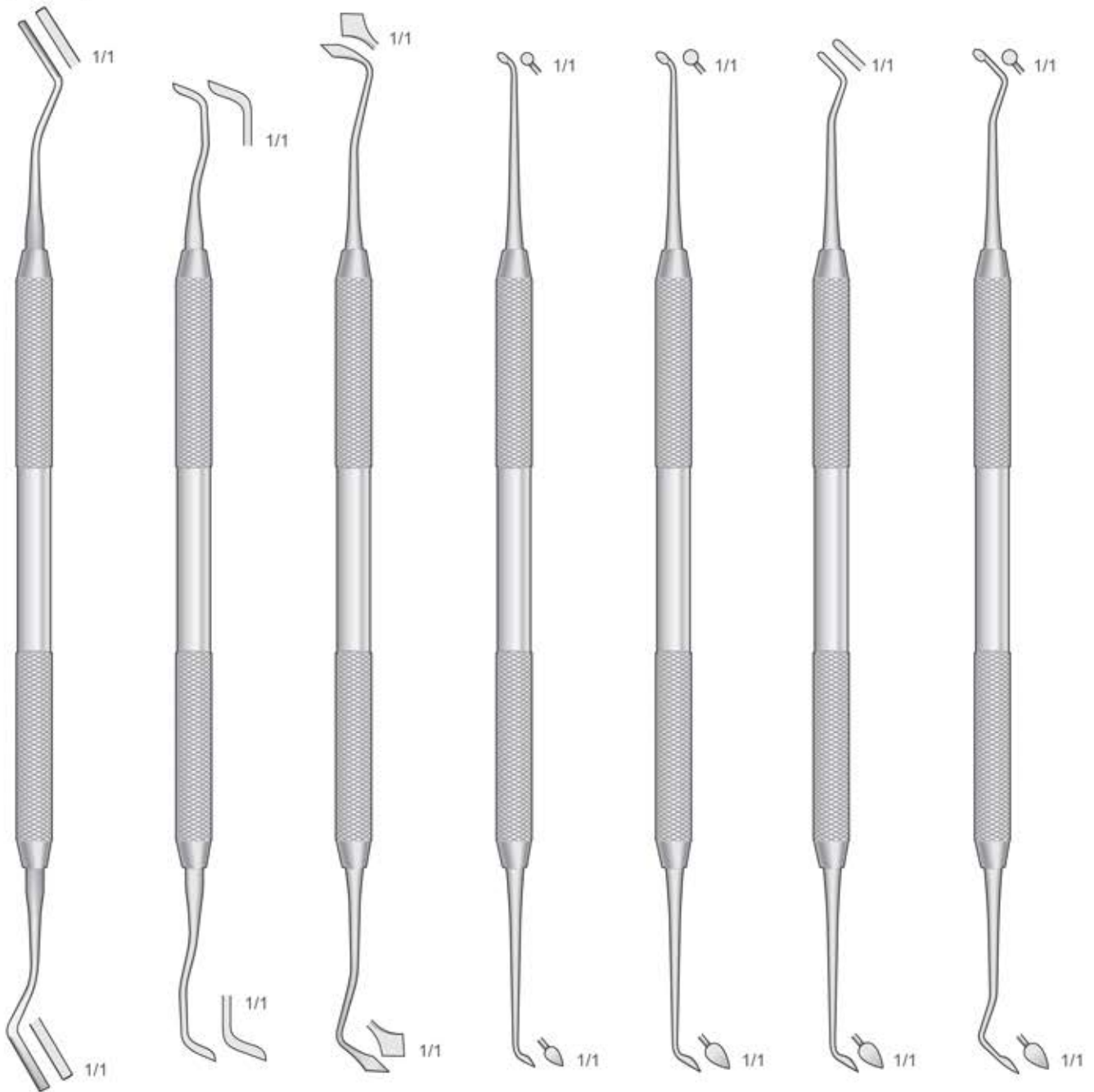

CV-11

USC-2
USC

F-2/3
FRAHM

CD-1
Fig. 1 /2

CD-2
Fig. 4/5

CD-3
Fig. W.A.C.D.

CD-4
Fig. 3/6

Füllungsinstrumente
Filling Instruments
Strumenti per otturazione
Instrumentos para obturación
Instruments pour obturation

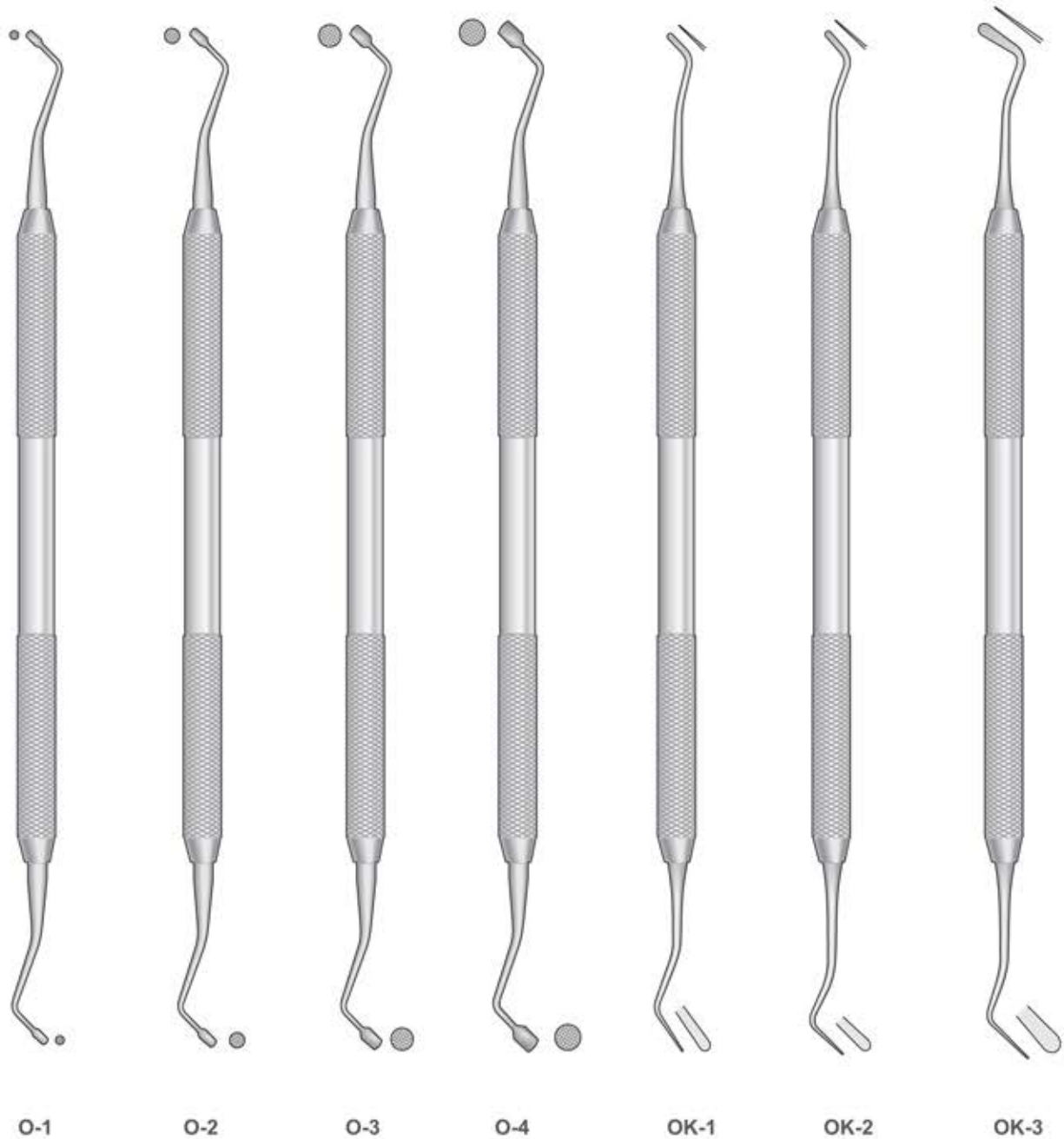

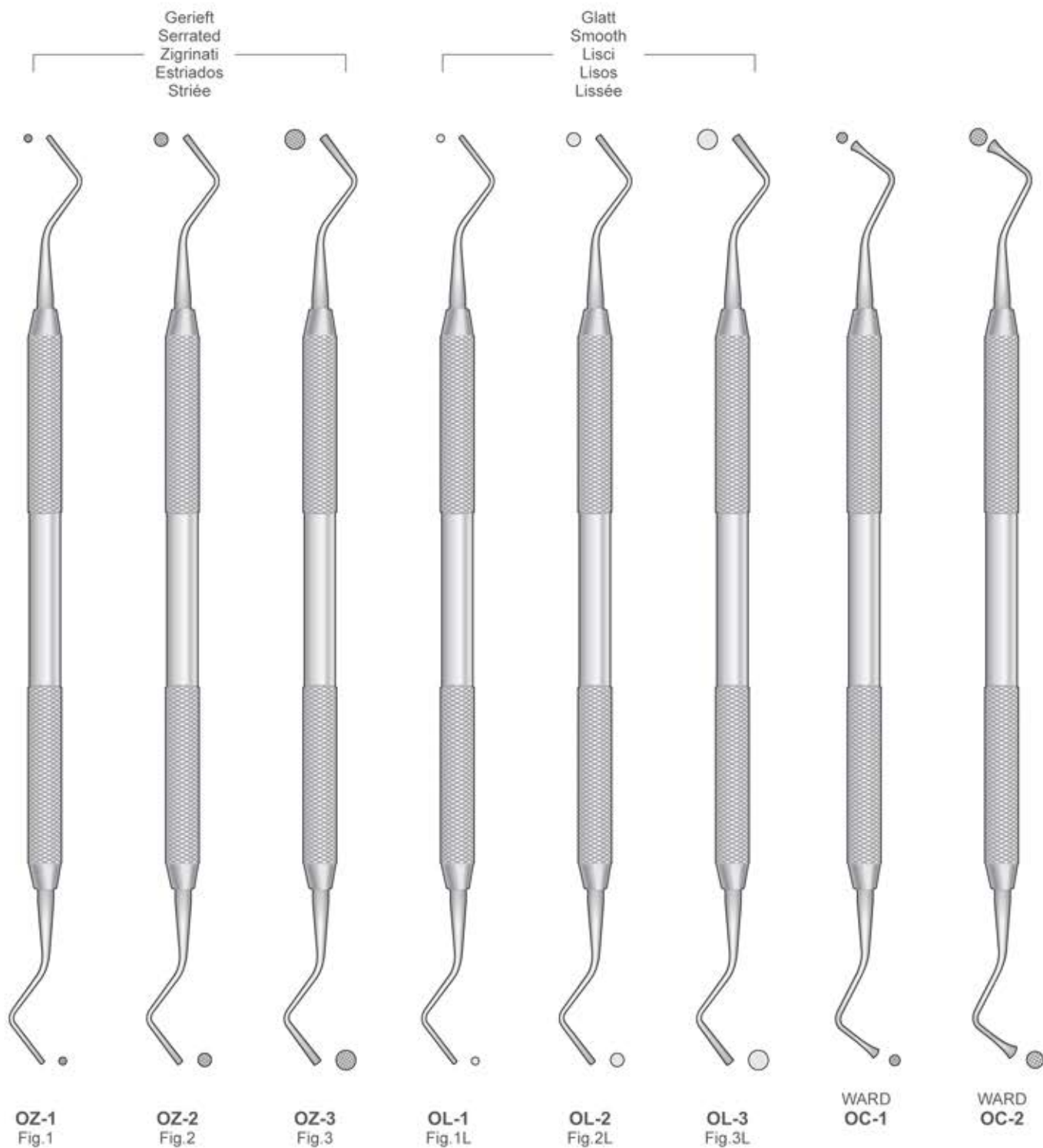

Füllungsinstrumente
 Filling Instruments
 Strumenti per otturazione
 Instrumentos para obturación
 Instruments pour obturation

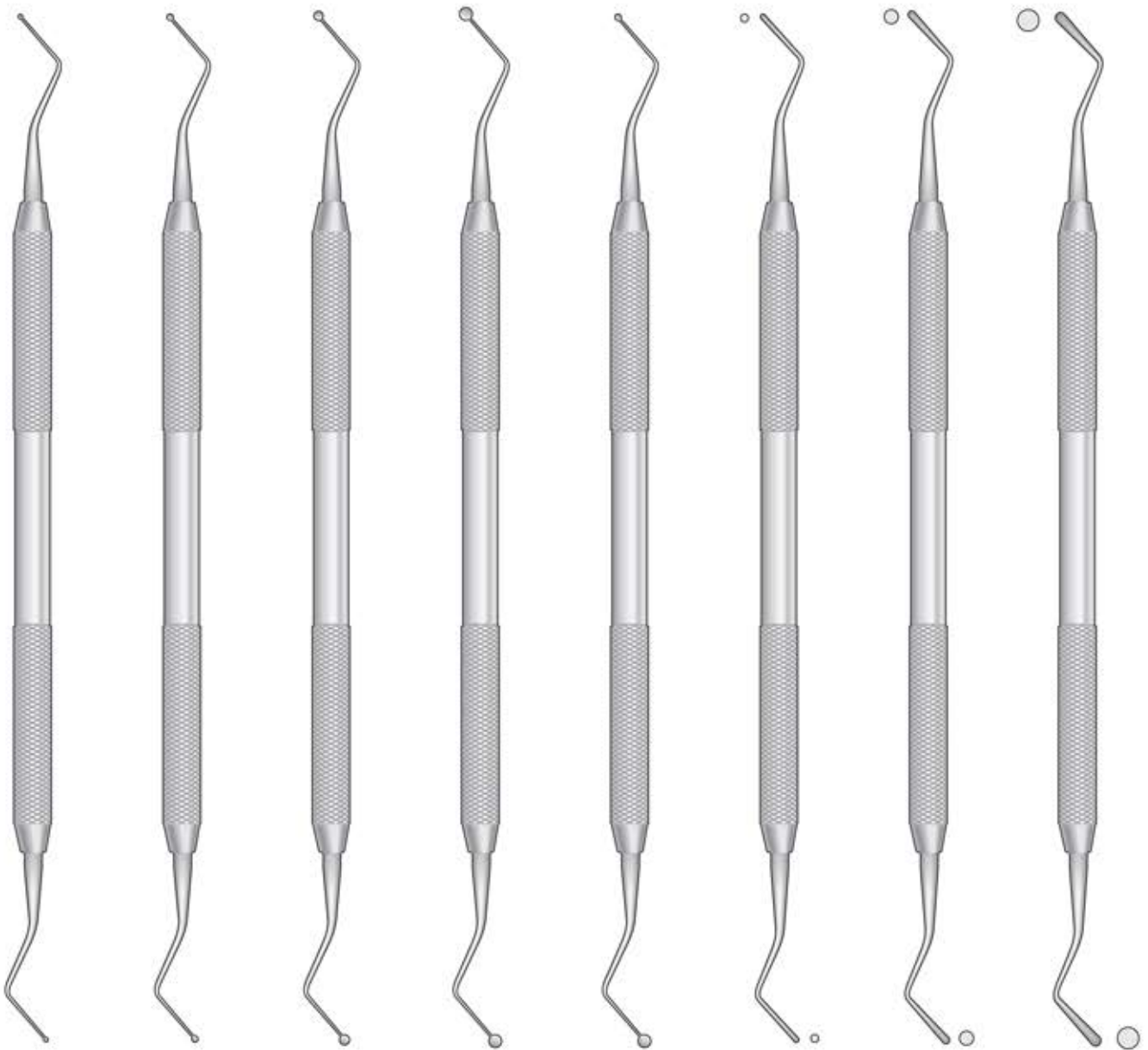

OP-1
Fig.1

OP-2
Fig.2

OP-3
Fig.3

OP-4
Fig.4

OP-5
Fig.5

OA-1
Fig.1

OA-2
Fig.2

OA-3
Fig.3



OX-1



OX-2



OX-3



WESTCOTT
OS-1



WESTCOTT
OS-2



OM-2



ON-1

Restaurative Zahnheilkunde
 Dental Restoration
 Odontoiatria conservativa
 Odontologia conservadora
 Odontologie conservatrice

Füllungsinstrumente
 Filling Instruments
 Strumenti per otturazione
 Instrumentos para obturación
 Instruments pour obturation



WHITE
B-3
 n°28



WHITE
B-4
 n°29

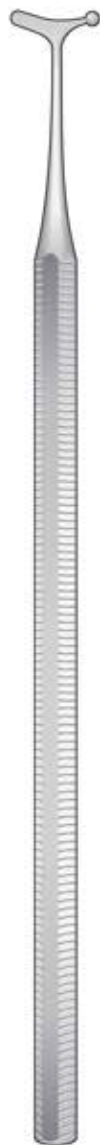

WHITE
B-32
 n°32



WHITE
B-33
 n°33



WHITE
B-34
 n°34



WHITE
B-28/29
 Doppio

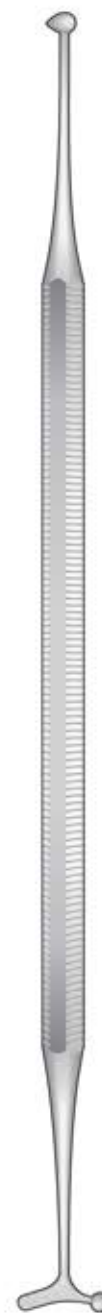

WHITE
B-31/32
 Doppio

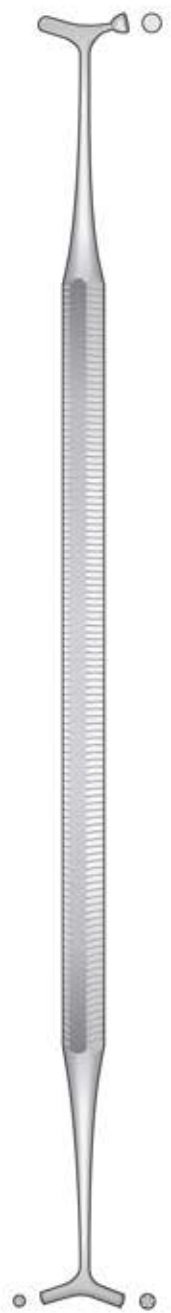

BENNET
B-35
 170 mm

MARKLEY PLUGGERS
Amalgam Instrumente
Amalgam Instruments
Strumenti per amalgama
Instrumentos para amalgama
Instruments à amalgame



PM-1
Fig. 1M



PM-2
Fig. 2M



PM-3
Fig. 3M



PM-4
Fig. 4M



PM-5
Fig. 5M



PM-6
Fig. 6M

Schmelzinstrumente
Enamel Instruments
Strumenti da smalto
Instrumentos para esmalte
Instruments à émail



**BLACK
TS-1**
Fig.26



**BLACK
TS-2**
Fig.27



**BLACK
TS-3**
Fig.28

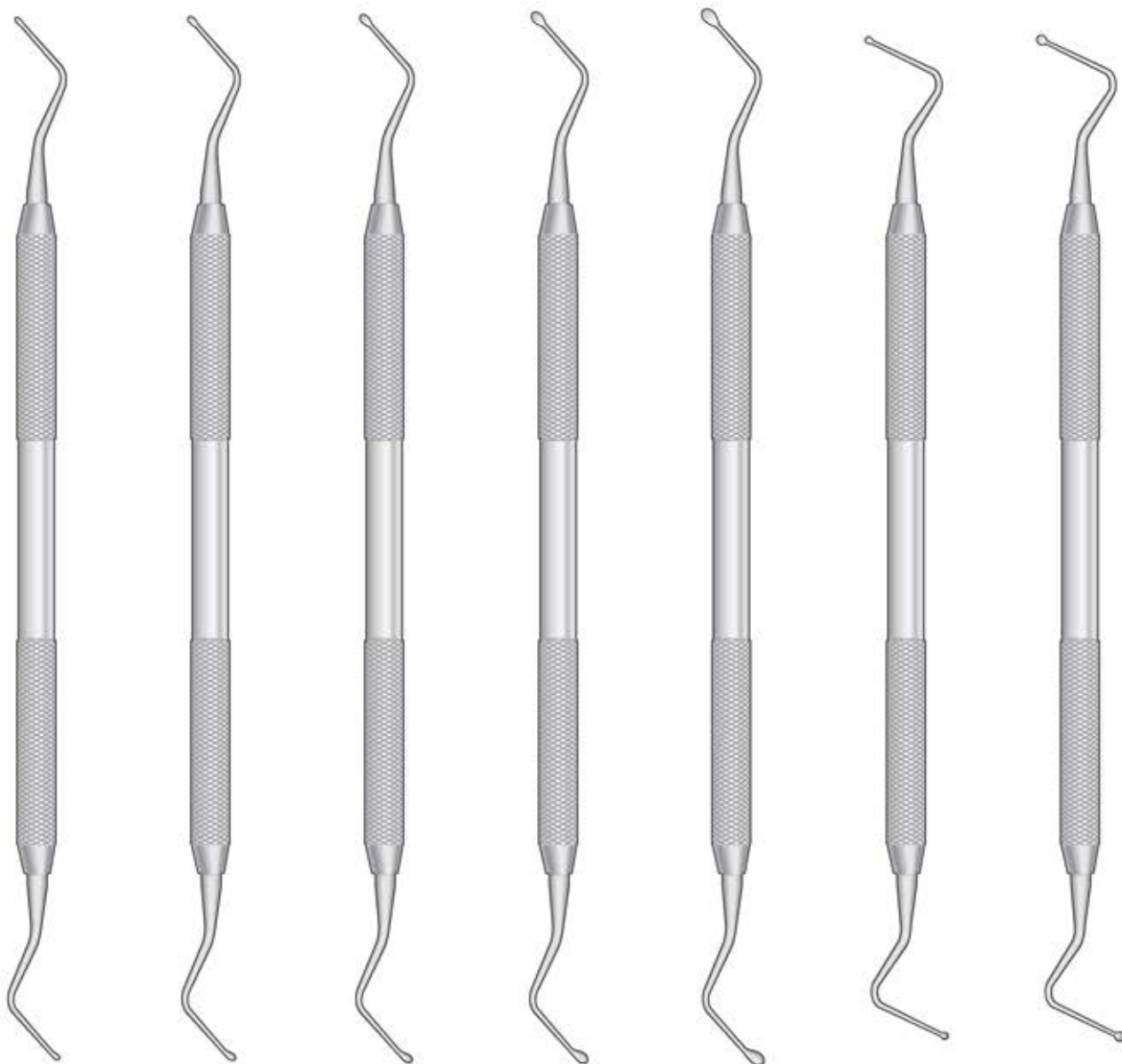

**BLACK
TS-4**
Fig.29

**E-0**
Fig.0**E-1**
Fig.1**E-2**
Fig.2**E-3**
Fig.3**E-4**
Fig.4**EC-1**
Fig.1**EC-2**
Fig.2

Meißel für Parodontologie
 Periodontal Chisels
 Scalpelli parodontali
 Cinceles periodontales
 Burins parodontaux



FEDI
OF-1
 175 mm



FEDI
OF-2
 175 mm



FEDI
OF-3
 170 mm



OCHSENBEIN
OSB-4A
 170 mm



OSB-4
 170 mm

Meißel für Parodontologie
 Periodontal Chisels
 Scalpelli parodontali
 Cinceles periodontales
 Burins parodontaux

Bevel IN
 Fig.1



OCHSENBEIN-1
OSB-1
 165 mm

Bevel OUT
 Fig.2



OCHSENBEIN-2
OSB-2
 165 mm



TG CHISELS
718-113



OCHSENBEIN-3
718-103



OCHSENBEIN-4
718-104



RHODES BACK ACTION
718-107



Parodontalmesser
 Gengivectomy Knives
 Bisturi per gengivectomia
 Bisturíes para la gengivectomía
 Bistouris pour la gengivectomie



**KIRKLAND
 KKD-1**
 Fig.15K



**KIRKLAND
 KKD-2**
 Fig.16K



**KIRKLAND
 KKD-4**
 Fig.15K - Fig.16K



**ORBAN
 OBN-1**
 Fig.1



**ORBAN
 OBN-2**
 Fig.2



**ORBAN
 OBN-4**
 Fig.1 - Fig.2

Doppelendiger Zahnsonden
 Double-ended Explorer
 Sonda falce doppia
 Sonda exploradora doble
 Sonde exploratrice double

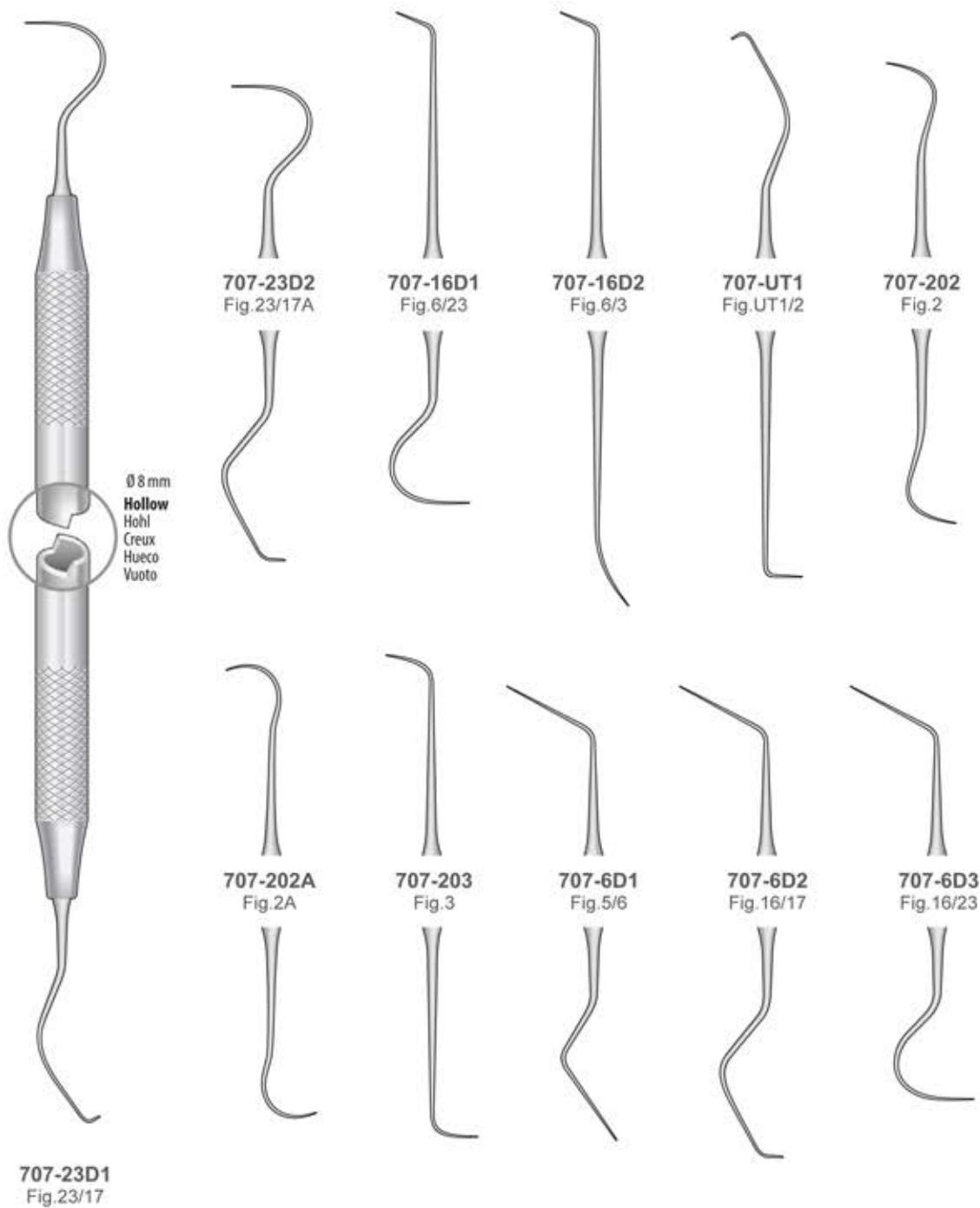

Doppelendiger Parodontometer
 Double-ended Periodontal Probes
 Sondes parodontales doubles
 Sonde parodontali doppie
 Sondas parodontales doubles

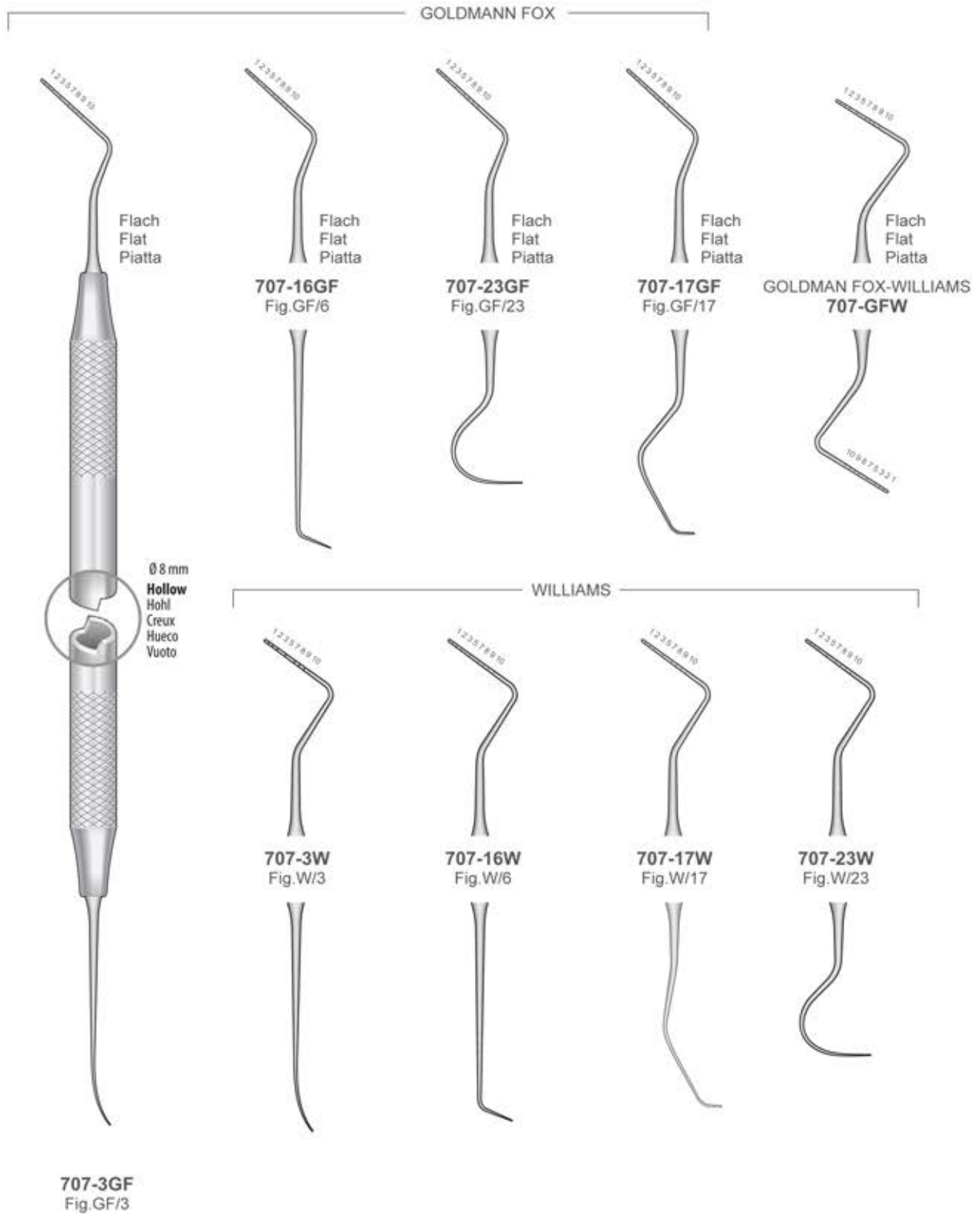

Doppelendiger Parodontometer
 Double-ended Periodontal Probes
 Sondes parodontales doubles
 Sonde parodontali doppie
 Sondas parodontales doubles

UNIVERSITY OF MICHIGAN

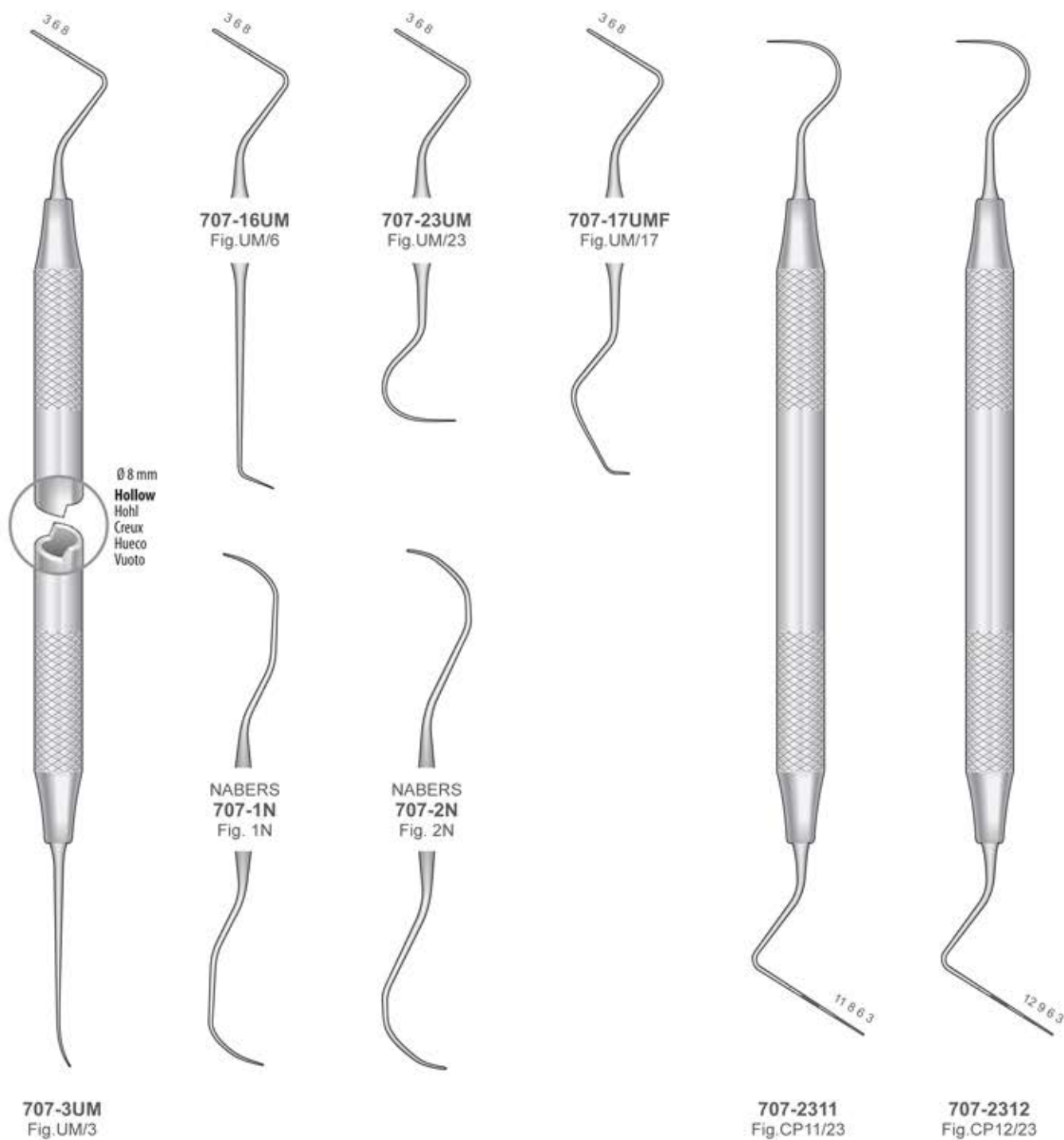

Spateln - Füllungsinstrumente
 Spatulas - Filling Instruments
 Spatole - Strumenti per otturazione
 Espátulas - Instrumentos para obturación
 Spatules - Instruments pour obturation

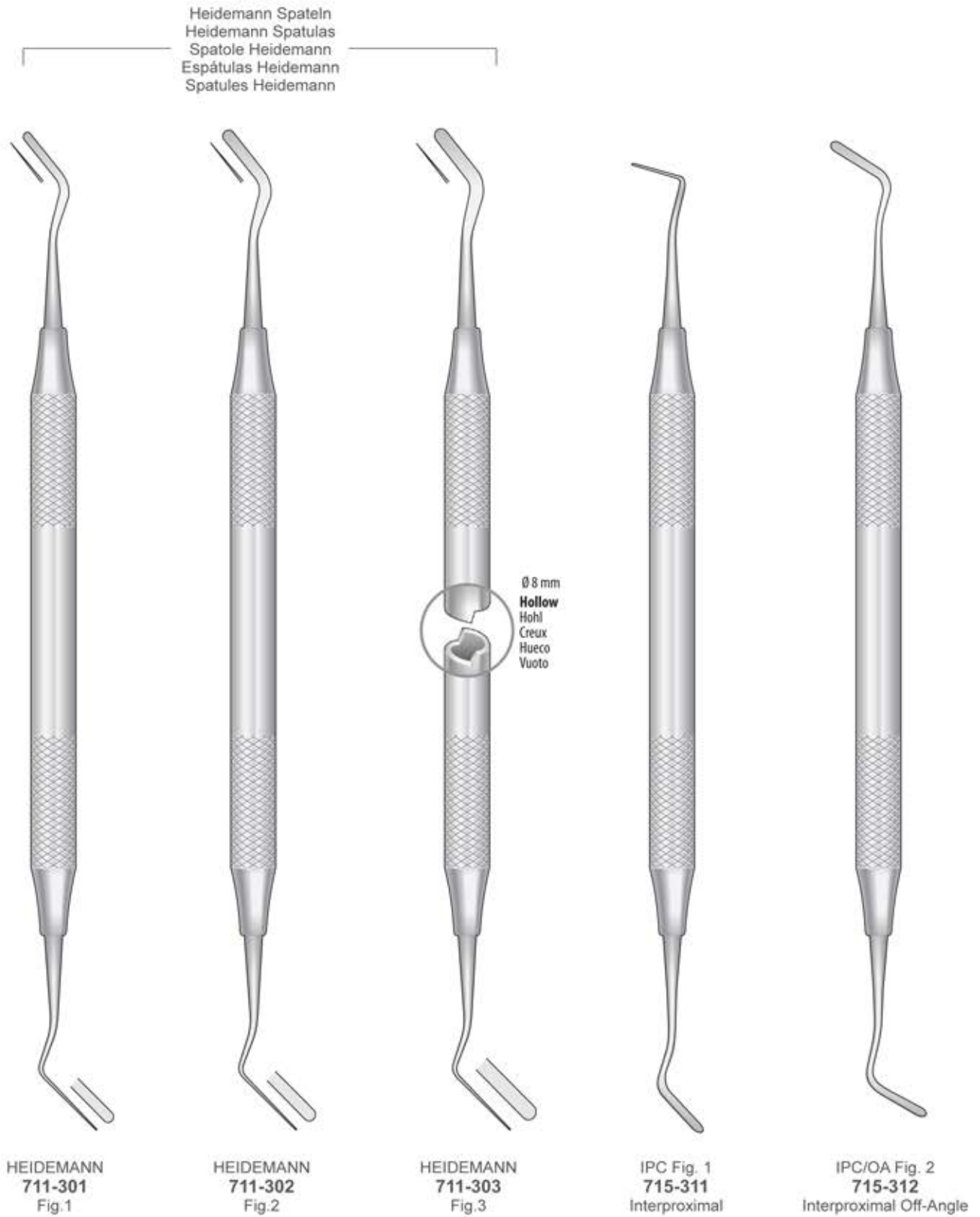



Füllungsinstrumente
Filling Instruments
Strumenti per otturazione
Instrumentos para obturación
Instruments pour obturation

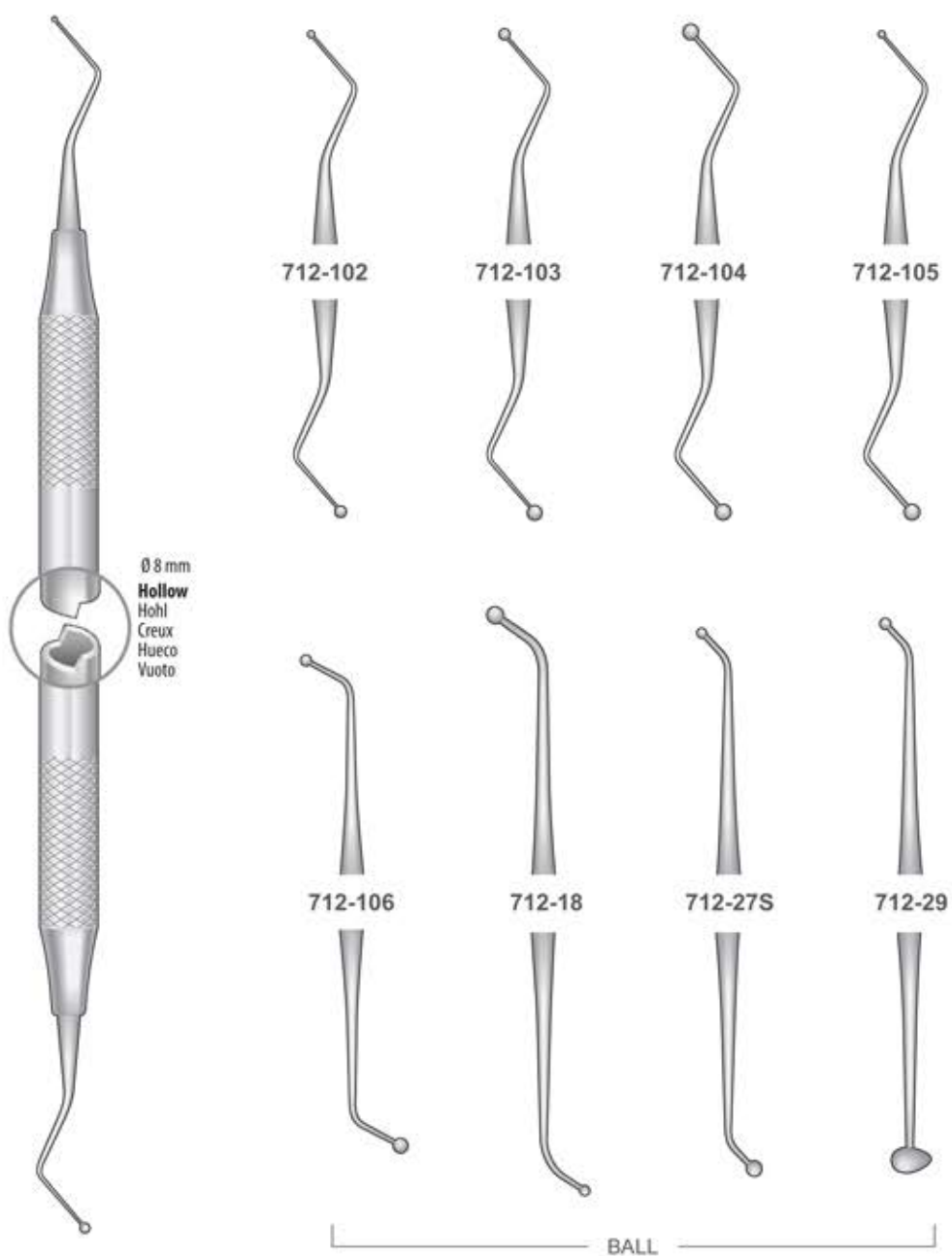

712-101

Füllungsinstrumente
 Filling Instruments
 Strumenti per otturazione
 Instrumentos para obturación
 Instruments pour obturation

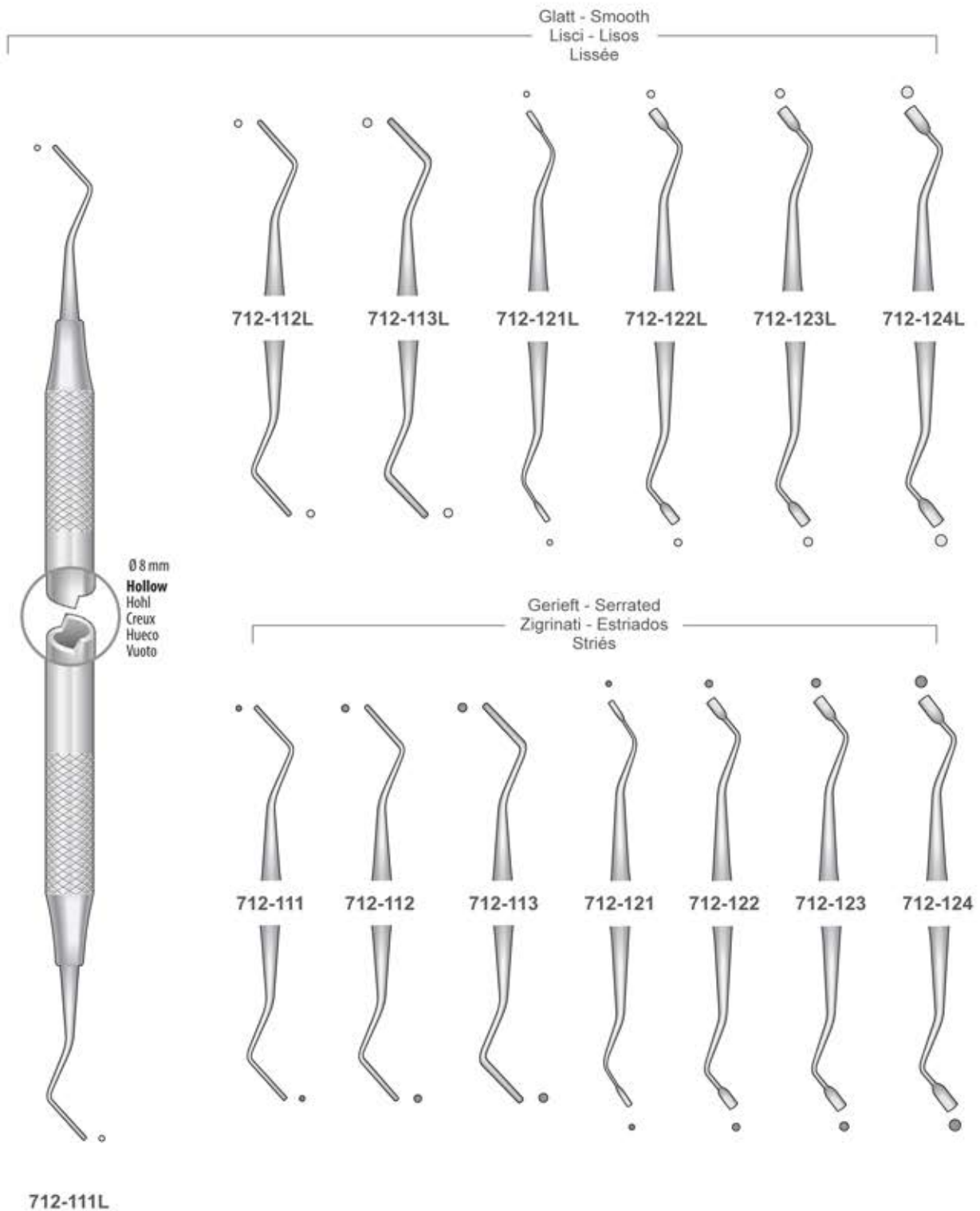

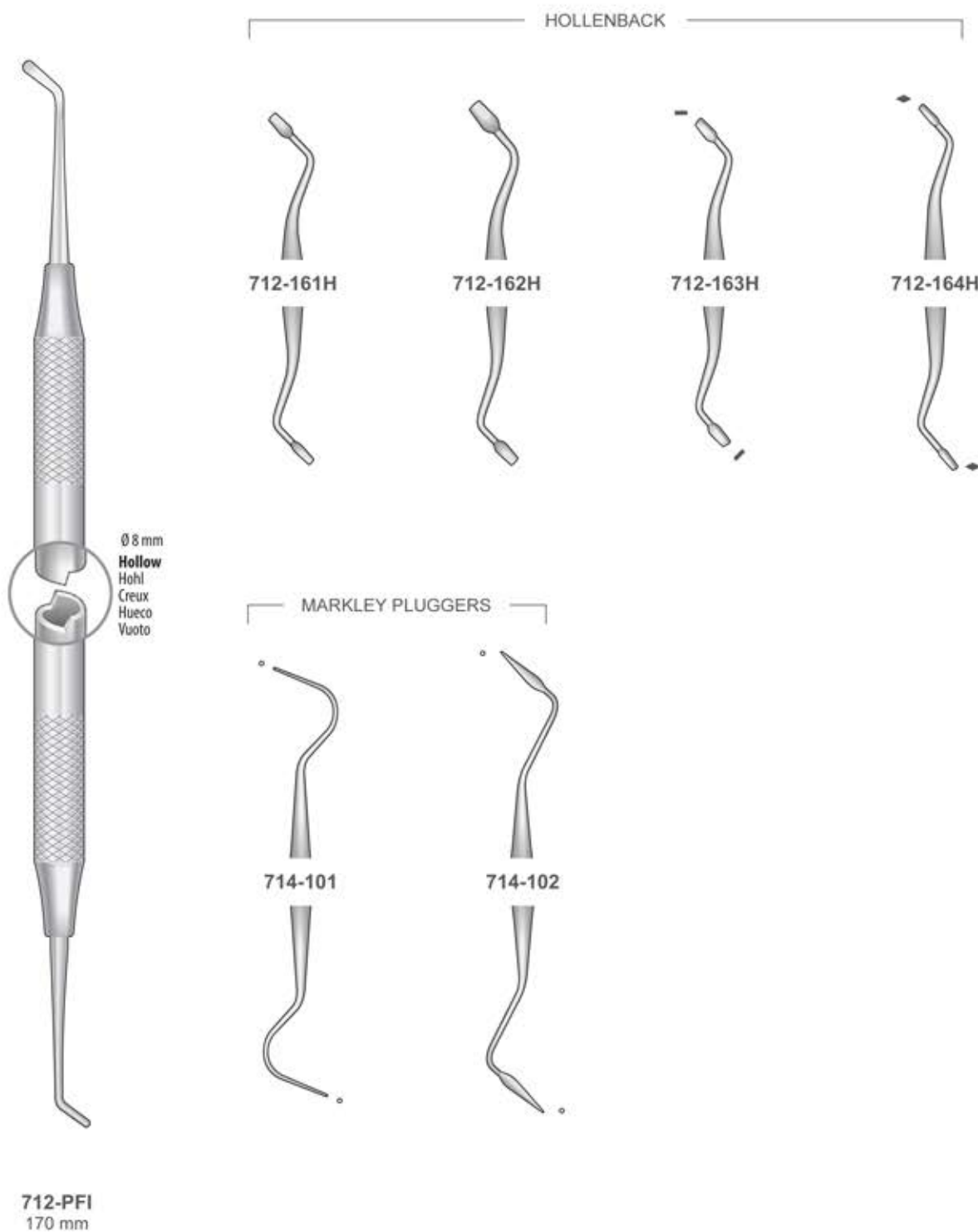

Füllungsinstrumente
 Filling Instruments
 Strumenti per otturazione
 Instrumentos para obturación
 Instruments pour obturation

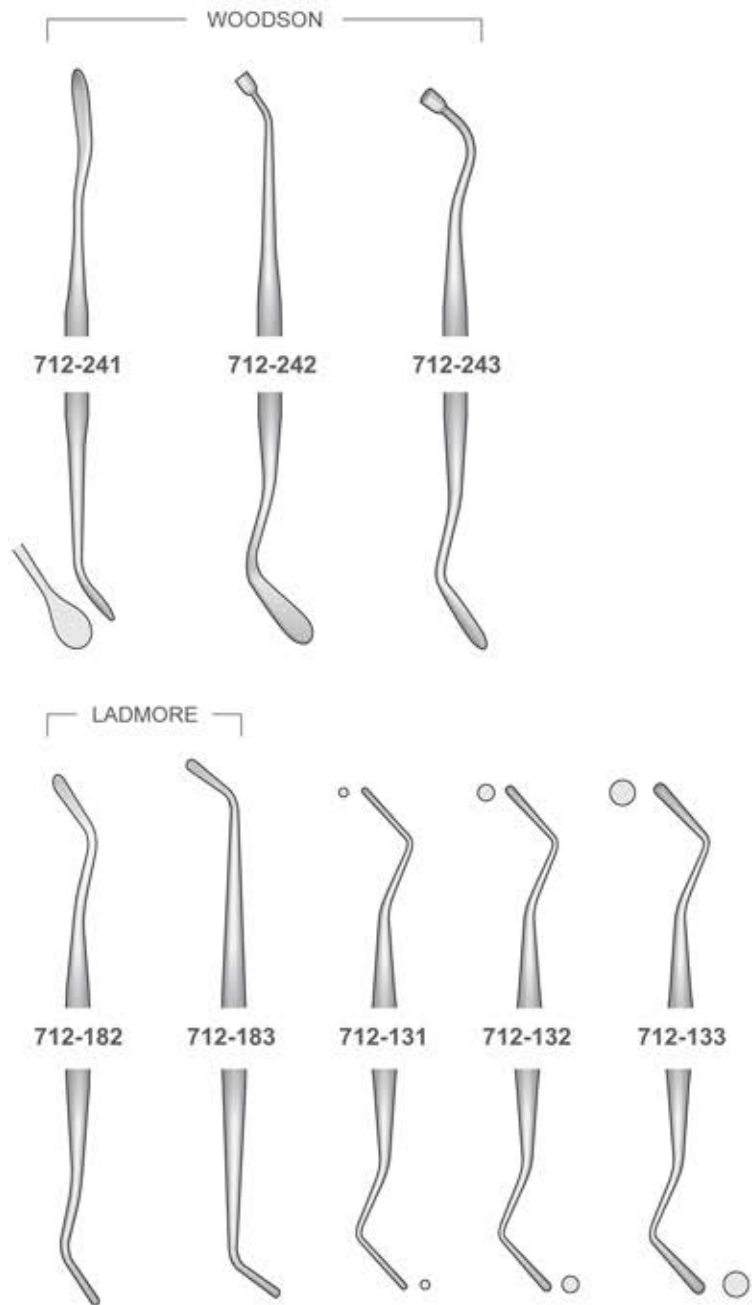
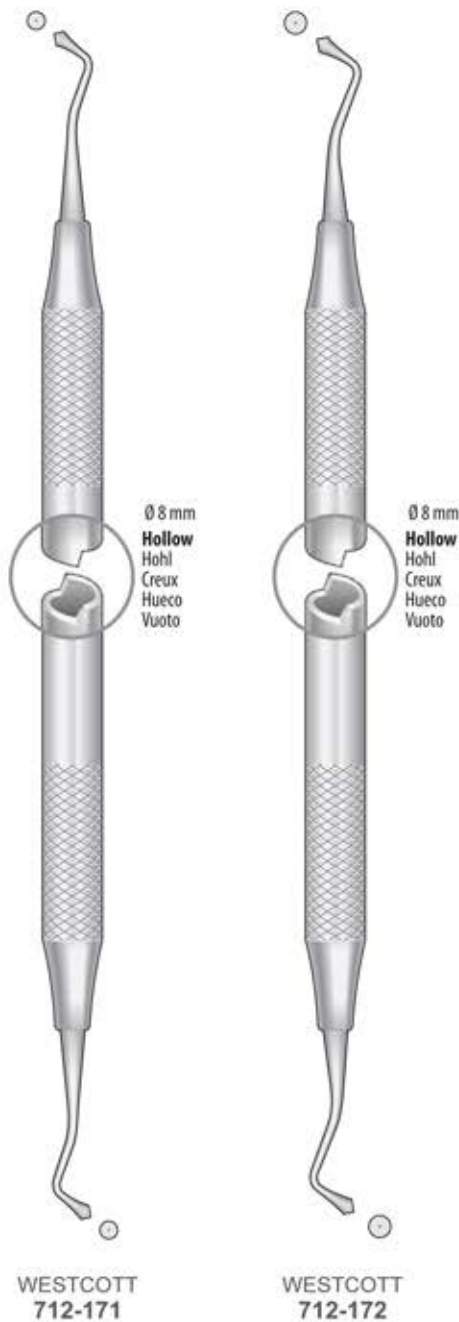

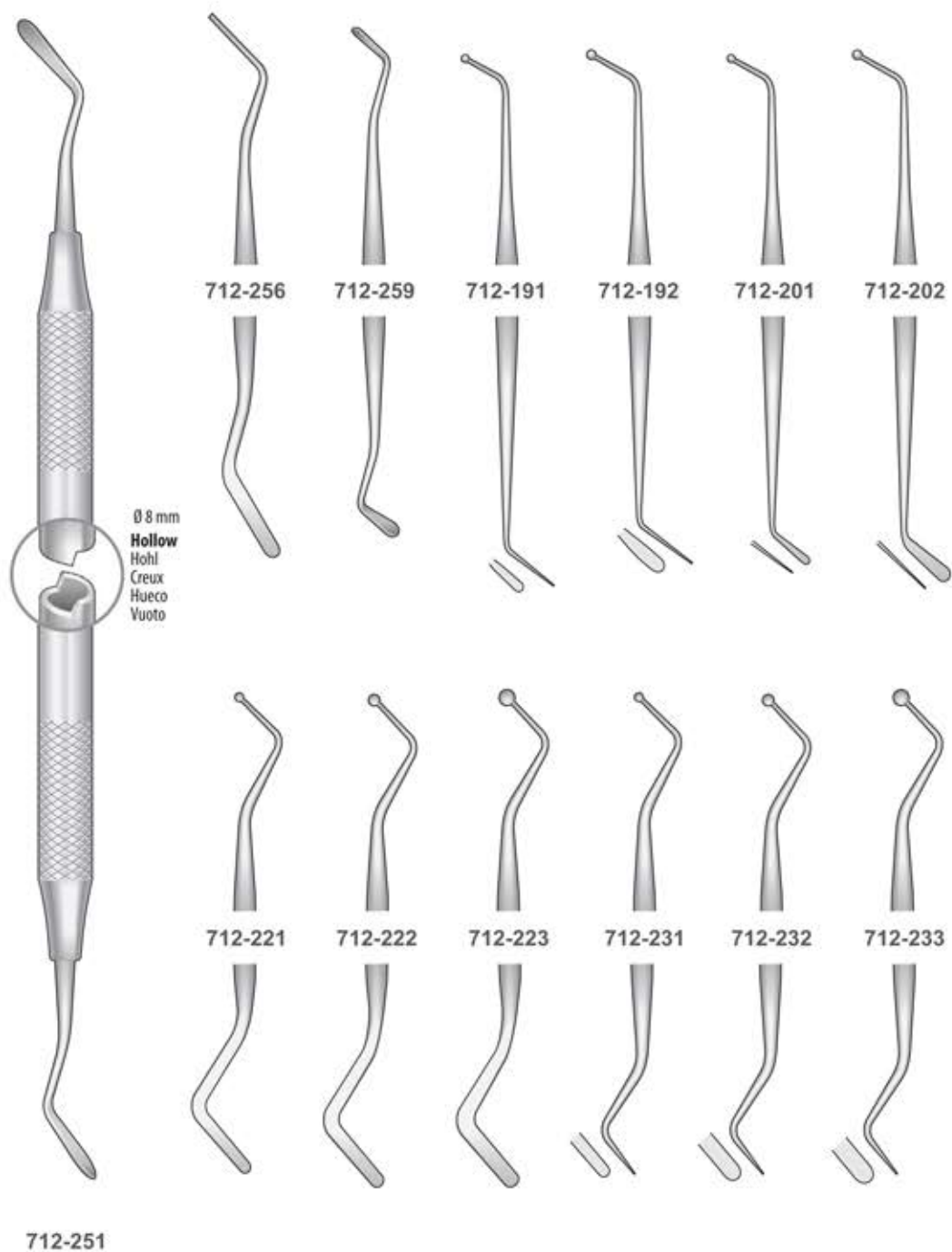

Amalgam Instrumente
 Amalgam carvers
 Strumenti per modellare otturazioni
 Instrumentos para modelar las obturaciones
 Instruments à modeler les obturations

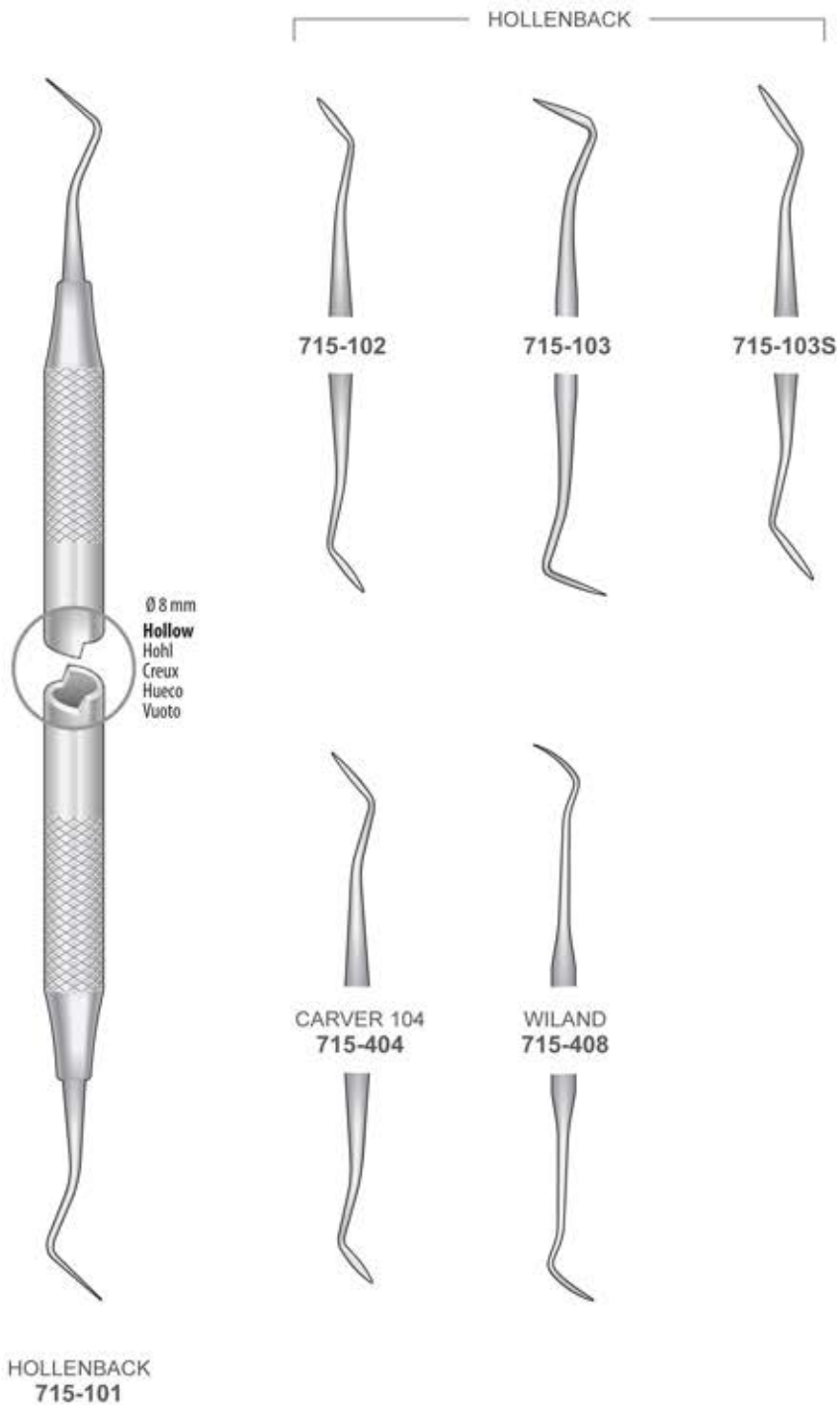

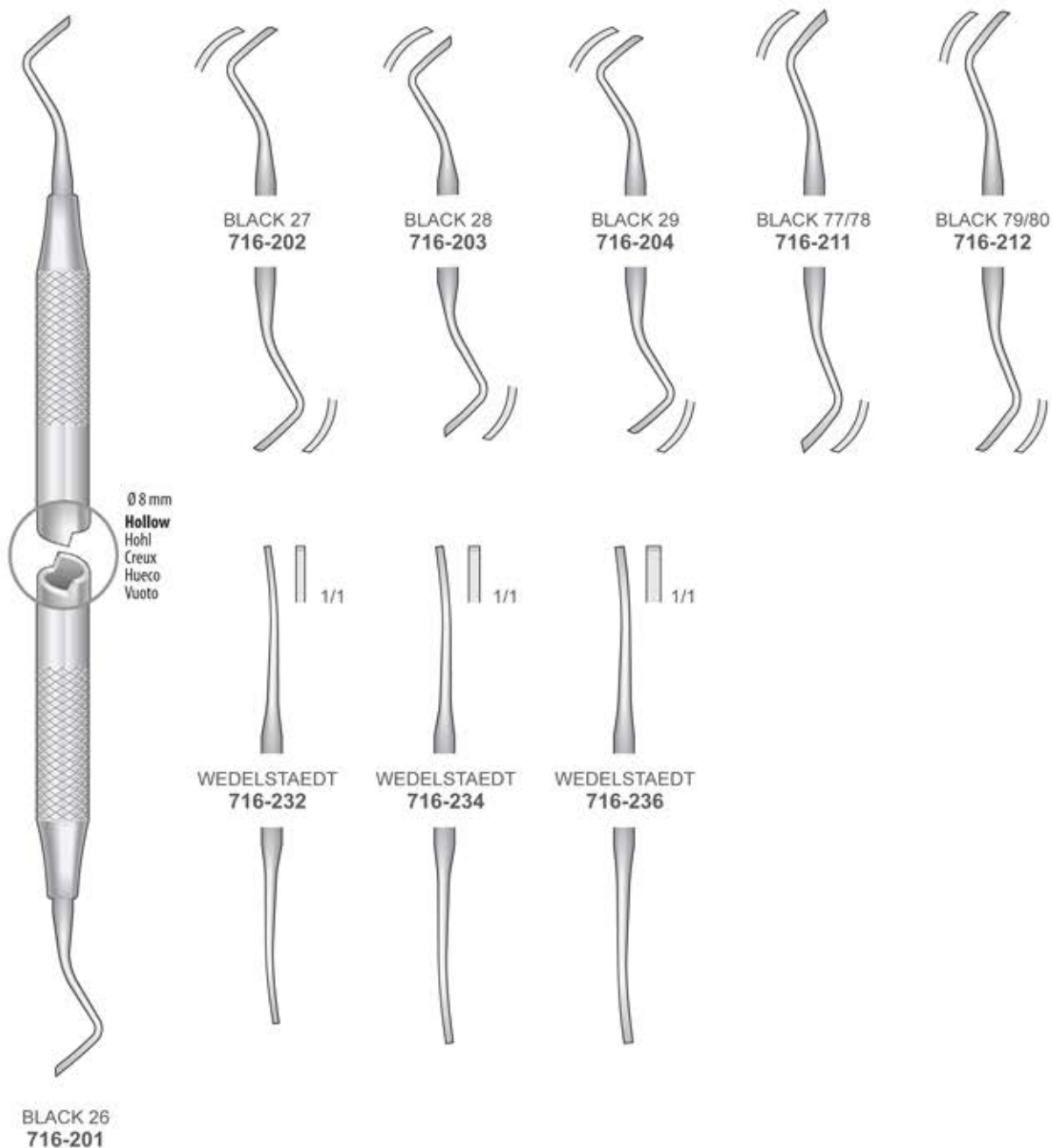

Amalgam Instrumente
 Amalgam carvers
 Strumenti per modellare otturazioni
 Instrumentos para modelar las obturaciones
 Instruments à modeler les obturations

Instrument für Drahrückzug
 Instrument for Retractor wire
 Strumento per filo retrattore
 Instrumento para hilo retractor
 Instruments pour fil racteur



714-CV11

Cleoids - Discoids

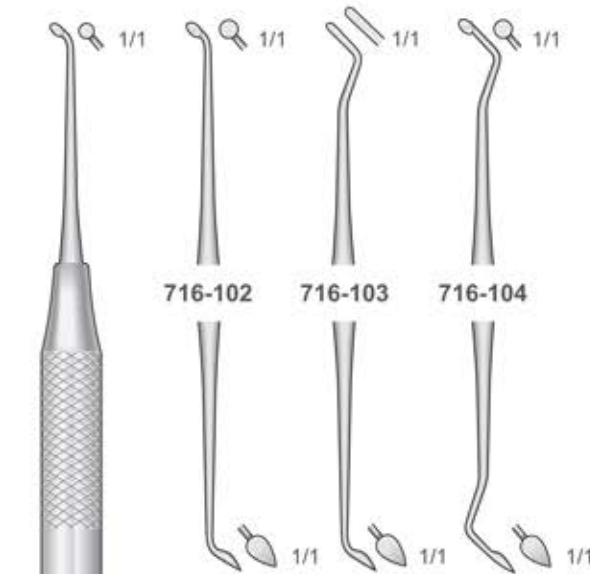

Ø 8 mm
 Hollow
 Hohl
 Creux
 Hueco
 Vuoto



716-101

Dykal Applikator
 Placement Instruments
 Applicatori per sottofondo
 Aplicadores de fondo de cavidades
 Appicateurs de fond de cavité

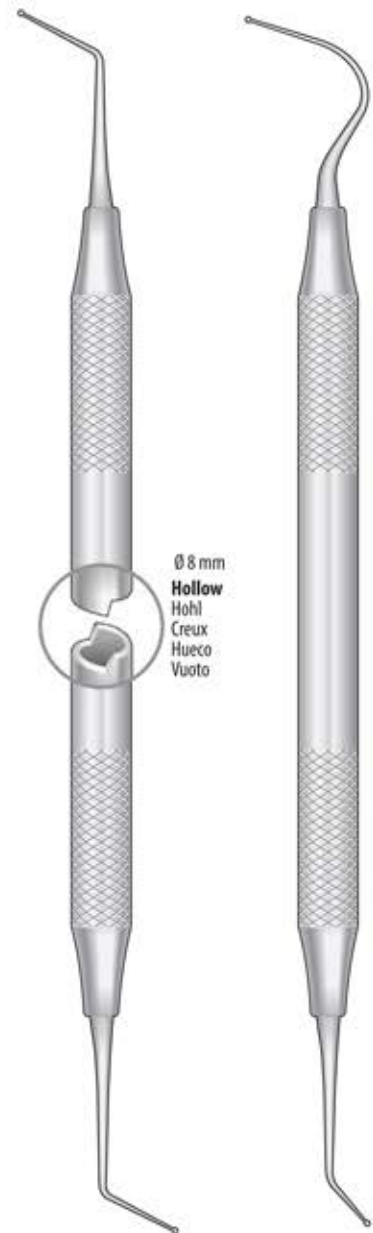

Ø 8 mm
 Hollow
 Hohl
 Creux
 Hueco
 Vuoto

713-101

713-102

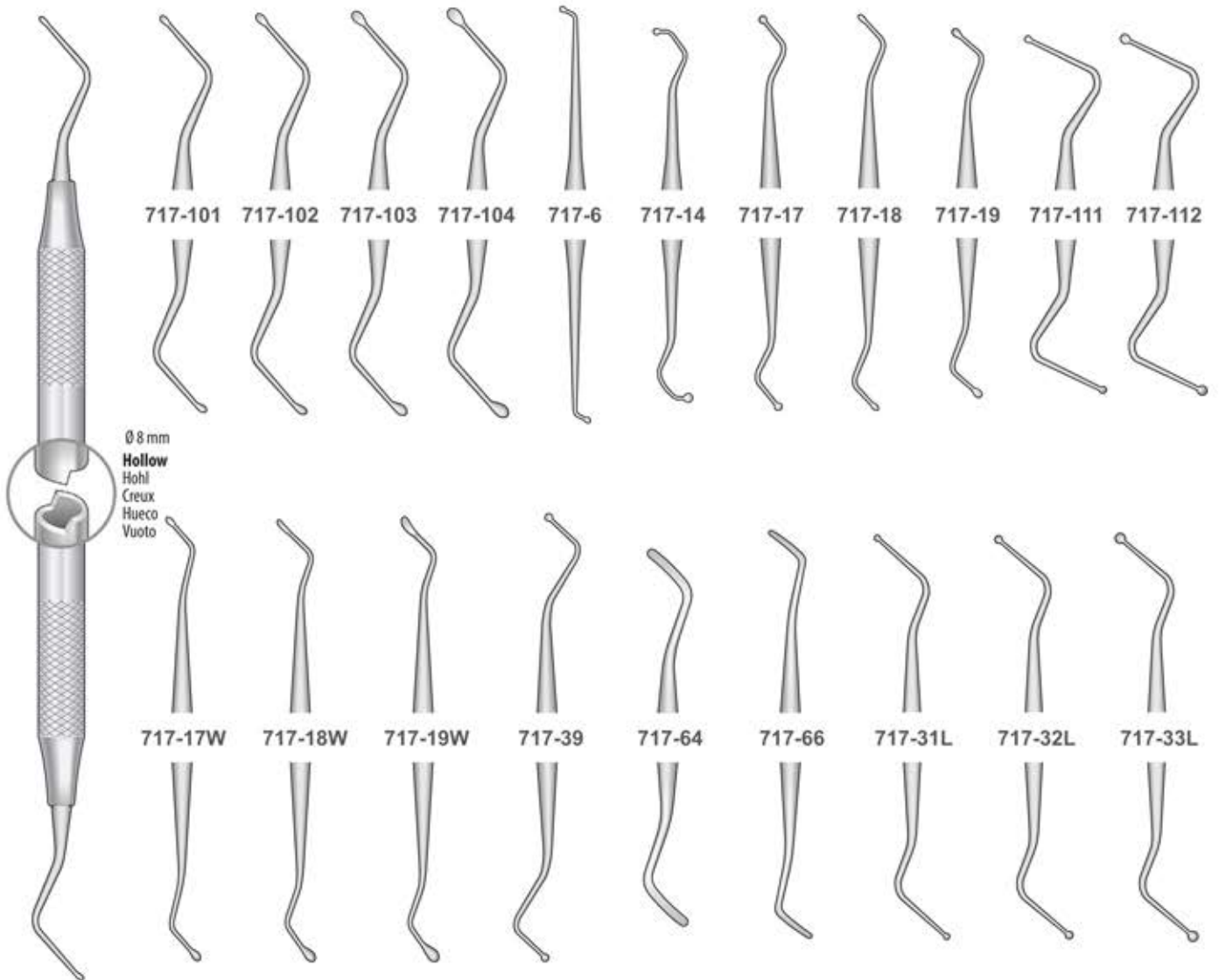

717-100

Parodontalmesser
 Gingivectomy knives
 Bisturi per gengivectomia
 Bisturíes para la gingivectomía
 Bistouris pour la gingivectomie

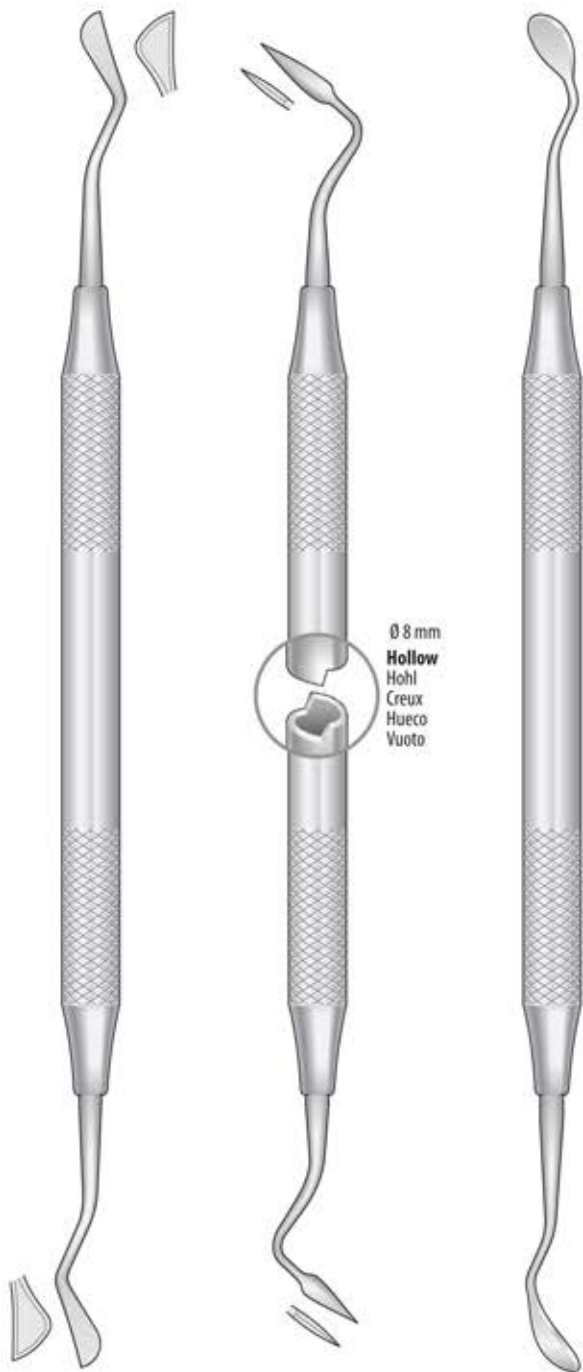

KIRKLAND
 718-123
 Fig. 15K/16K

ORBAN
 718-133
 Fig. 1 / 2

GOLDMAN-FOX
 718-147
 Fig. 7

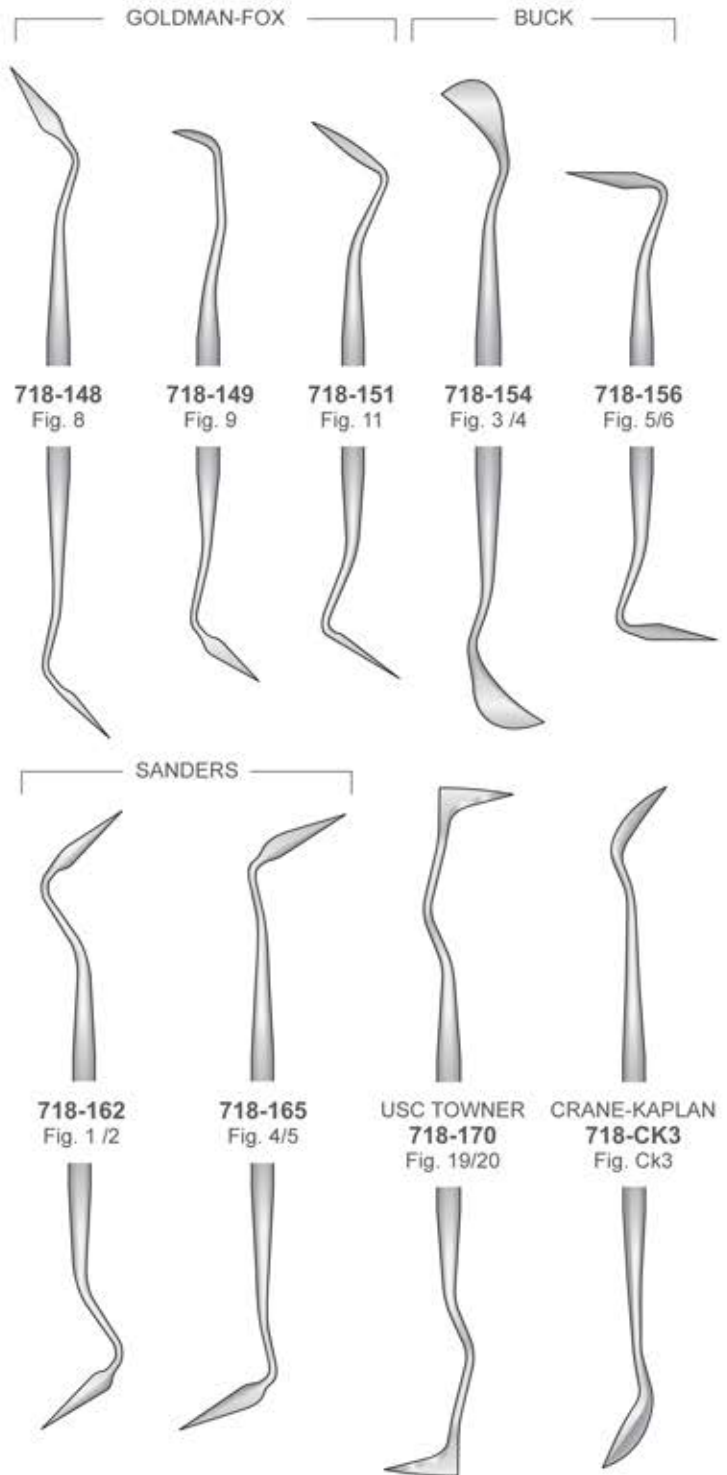

718-148
 Fig. 8

718-149
 Fig. 9

718-151
 Fig. 11

718-154
 Fig. 3 / 4

718-156
 Fig. 5/6

718-162
 Fig. 1 / 2

718-165
 Fig. 4/5

USC TOWNER
 718-170
 Fig. 19/20

CRANE-KAPLAN
 718-CK3
 Fig. Ck3

GRACEY

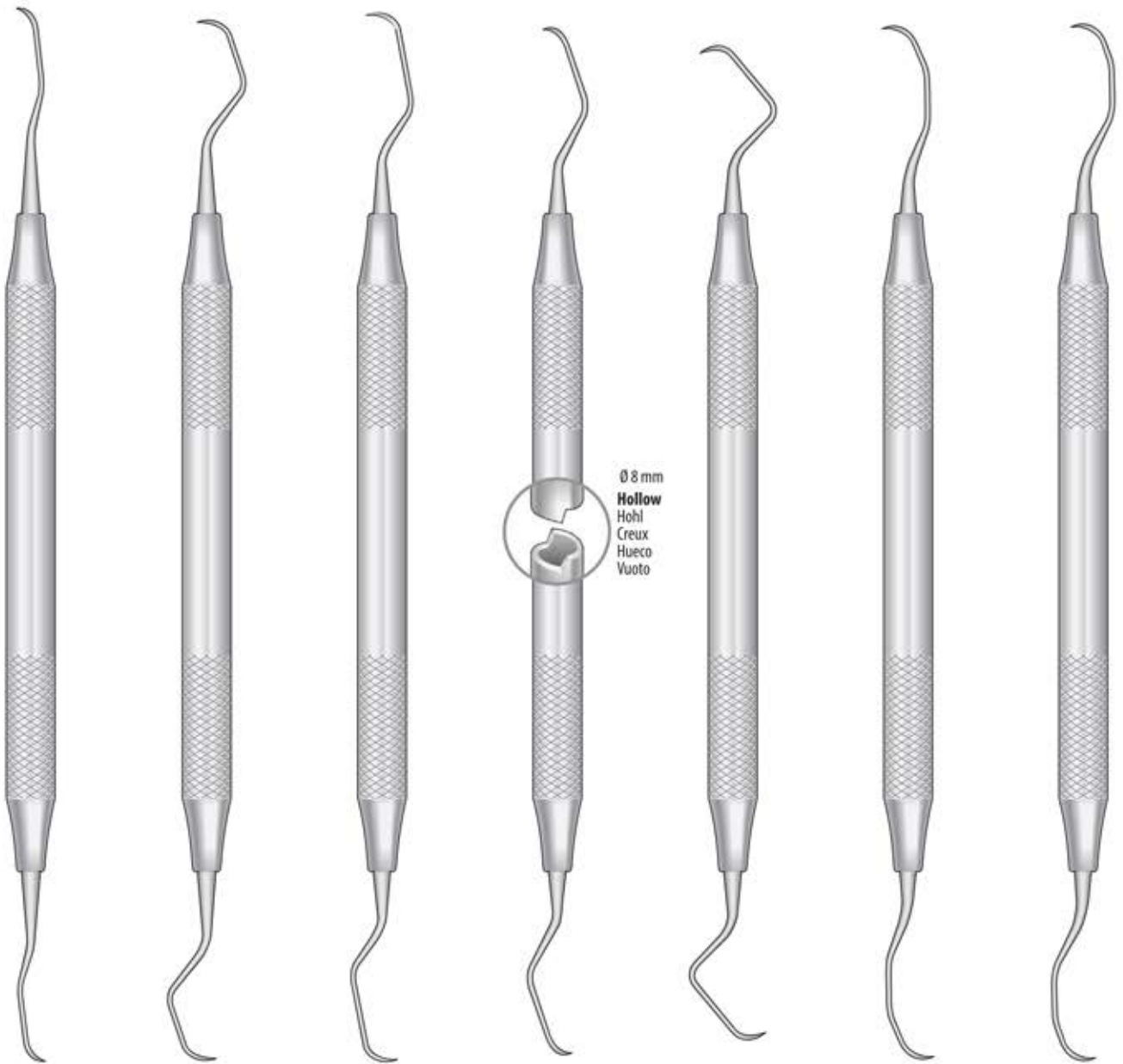

GRACEY
718-1/2

GRACEY
718-3/4

GRACEY
718-5/6

GRACEY
718-7/8

GRACEY
718-9/10

GRACEY
718-11/12

GRACEY
718-13/14

Küretten
 Curettes
 Curette
 Curetas
 Curettes

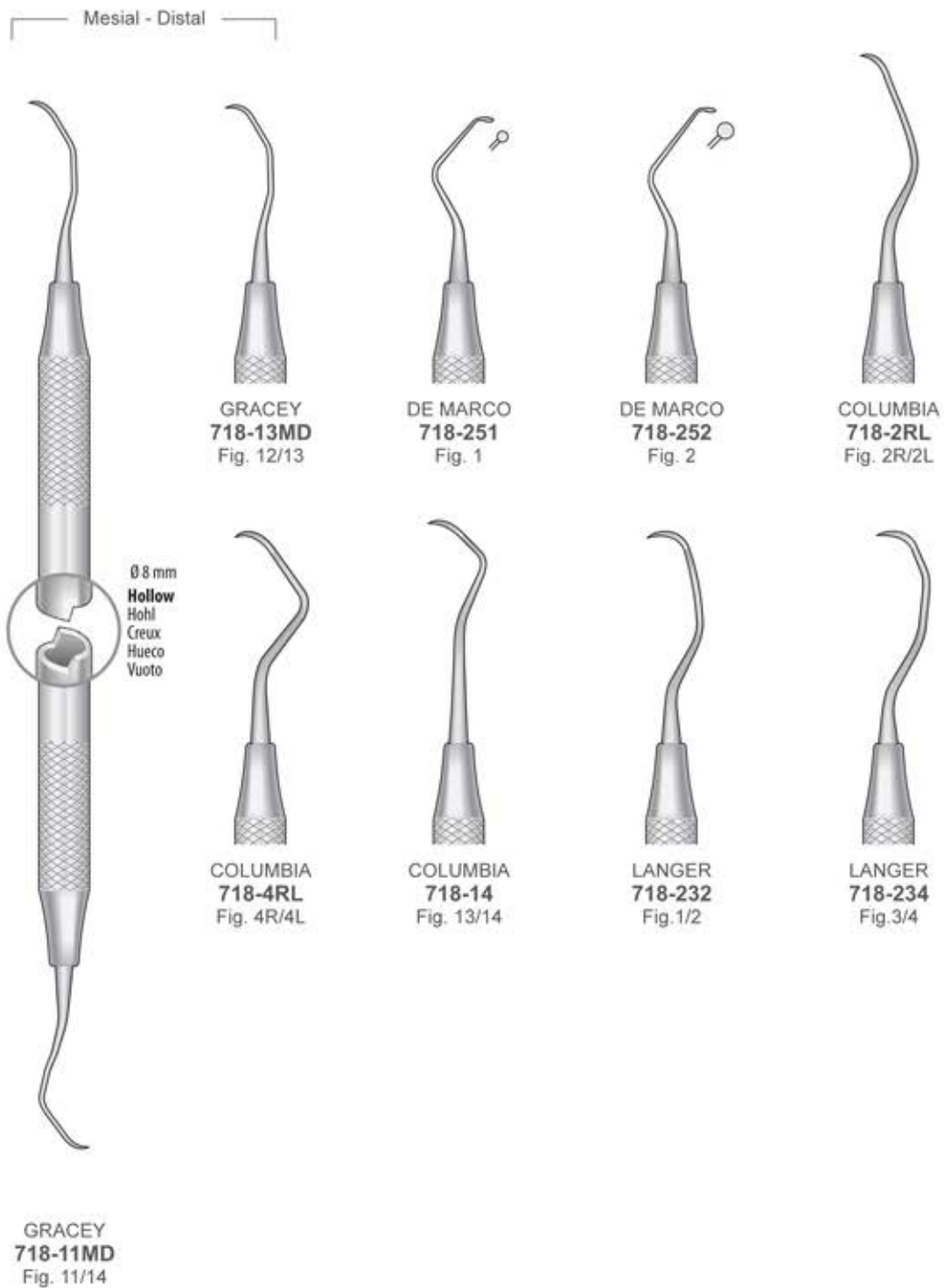

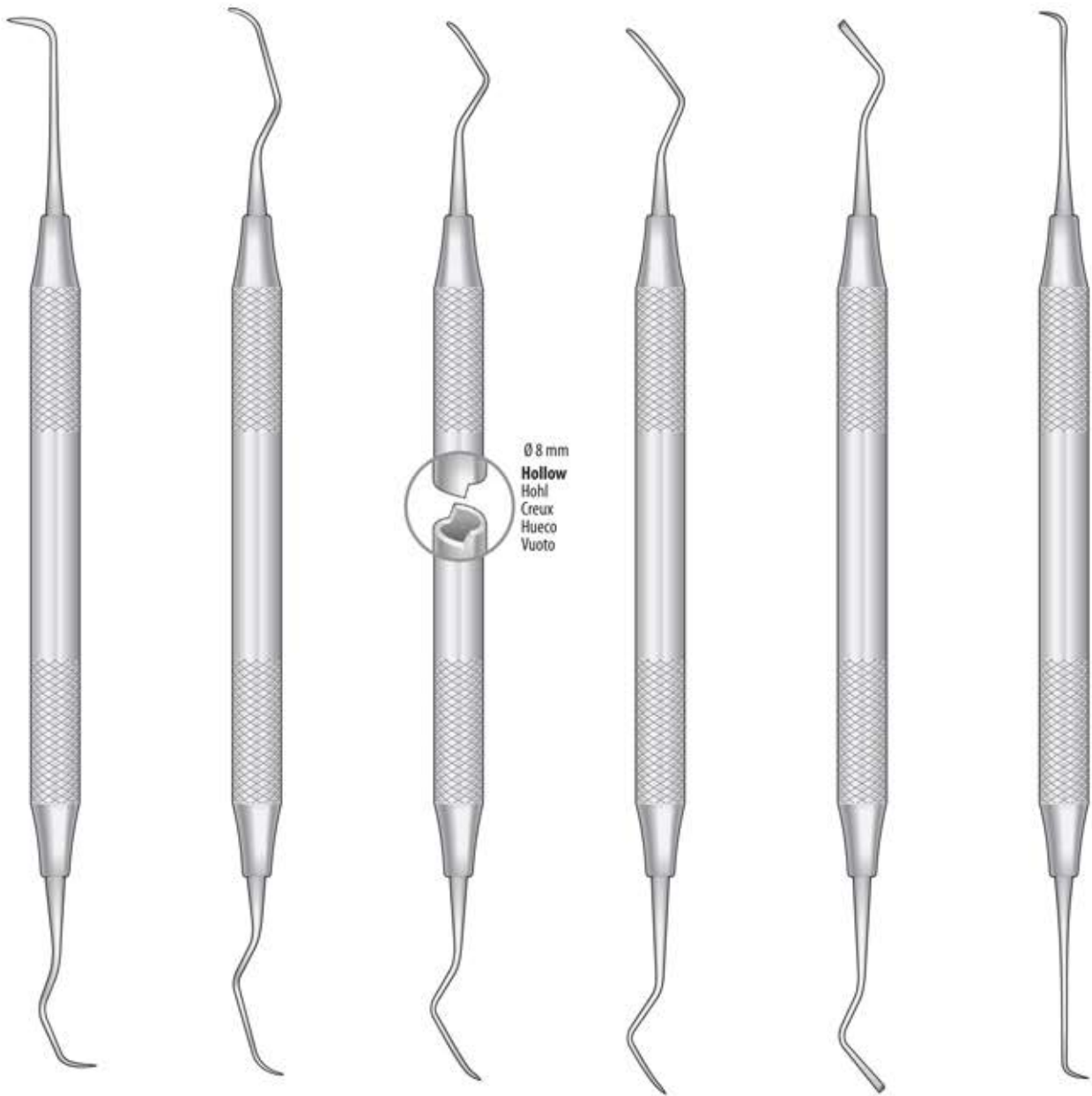

GOLDMAN-FOX
718-271
Fig. 1

GOLDMAN-FOX
718-272
Fig. 2

GOLDMAN-FOX
718-273
Fig. 3

GOLDMAN-FOX
718-274
Fig. 4

GOLDMAN-FOX
718-275
Fig. 5

GOLDMAN-FOX
718-277
Fig. 21

Scaler und Küretten
 Scalers and Curettes
 Scaler e Curette
 Raspadores y Curetas
 Détartreurs et Curettes

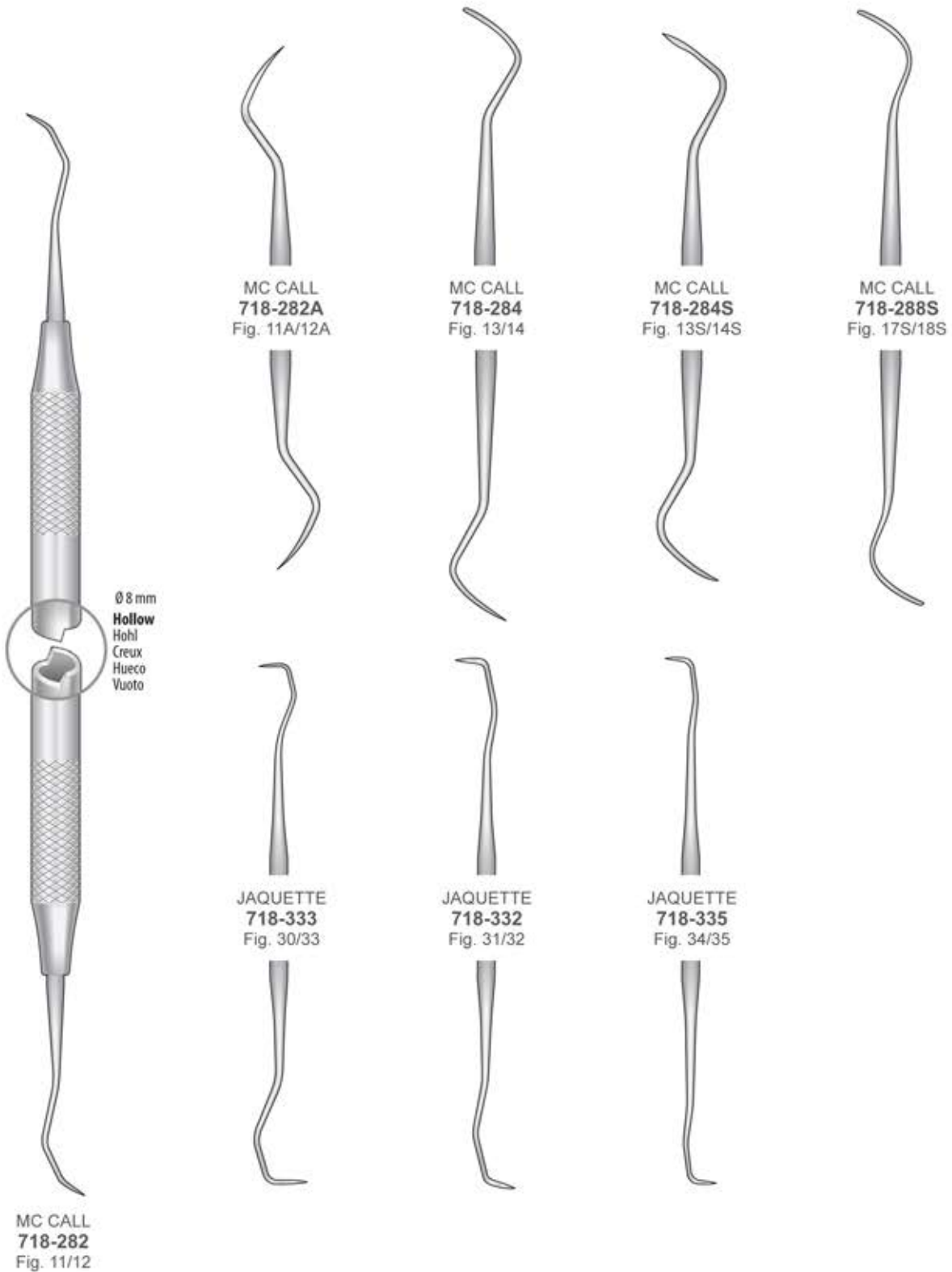

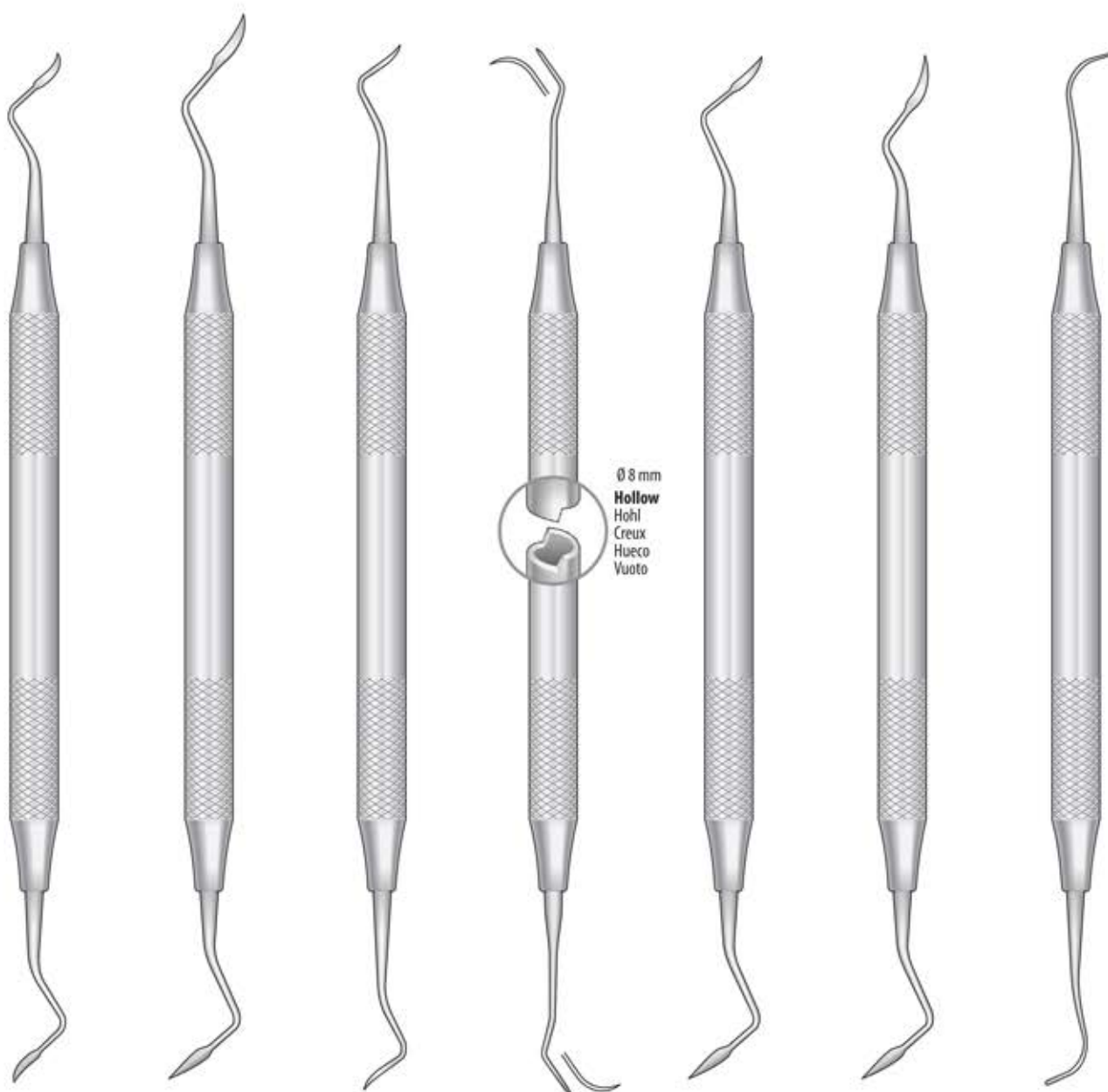

Ø 8 mm
Hollow
 Hohl
 Creux
 Hueco
 Vuoto

TAYLOR
 718-TO3
 Fig. 2/3

718-204
 Fig. 204

718-204S
 Fig. 204S

718-204SD
 Fig. 204SD

718-CIO3
 Fig. 2/3

CRANE-CAPLAN
 718-CK6
 Fig. 6

YOUNGER-GOOD
 718-YGO8
 Fig. 7/8

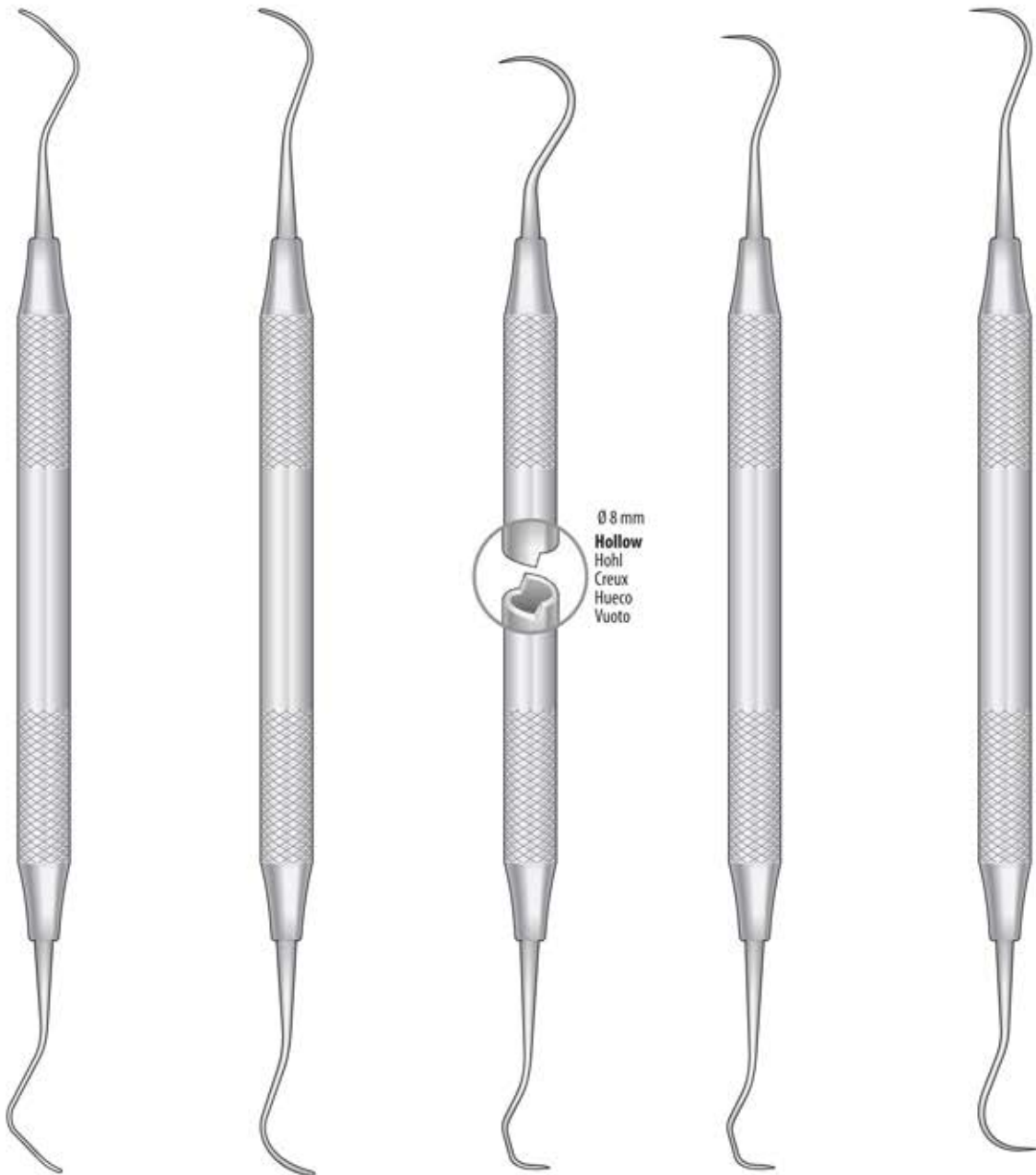

Ø 8 mm
Hollow
 Hohl
 Creux
 Hueco
 Vuoto

RULE 23/24
718-RO4
 Fig. 3 /4

I. UNIVERSITY
718-268
 Fig. 17/18

TOWNER-JAQUETTE
719-111
 Fig. U15/33

TOWNER-JAQUETTE
719-125
 Fig. H5/33

TOWNER-JAQUETTE
719-126
 Fig. H6/H7

Kofferdam Instrumente
 Rubber-Dam Instruments
 Strumenti per diga
 Instrumentos para dique de goma
 Instruments pour digue de caoutchouc

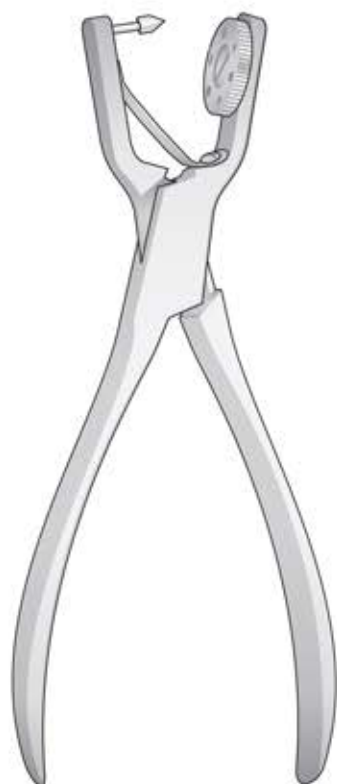

AINSWORTH
DF-02
 160 mm



DF-02M
 Feder mit Schraube
 Spring with screw
 Molla con vite
 Muelle con tornillo
 Ressort avec vis



DF-02R
 Lochscheibe
 Punch Disk
 Disco divisore
 Disco agujereado
 Disque perforé



DF-02P
 Stift, mit Schraube
 Pin, with screw
 Perno con vite
 Punzón con perno
 Broche

Lochzangen
 Punch Forceps
 Pinze foradiga
 Perforadores
 Pincas à perforer

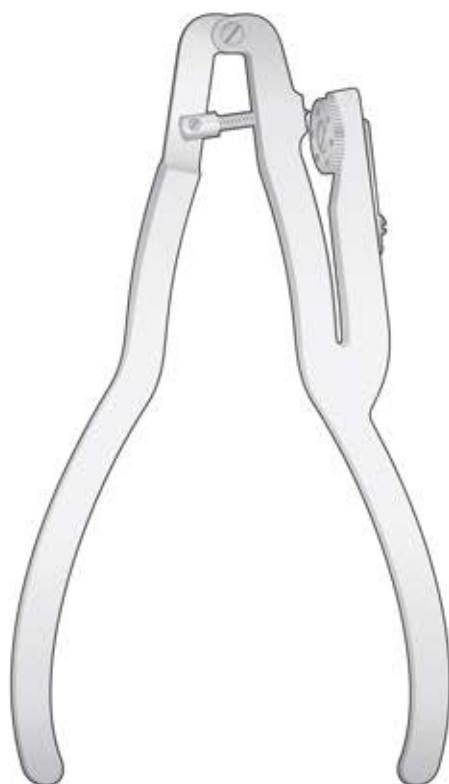

IVORY
DF-00
 160 mm



DF-00M
 Spiralfeder
 Spiral Spring
 Molla a spirale
 Muelle espiral
 Ressort en spirale



DF-00L + DF-00V
 Feder mit Schraube
 Spring with screw
 Molla con vite
 Muelle con tornillo
 Ressort avec vis



DF-00R
 Lochscheibe
 Punch Disk
 Disco divisore
 Disco agujereado
 Disque perforé



DF-00P + DF-00N
 Stift, mit Schraube
 Pin, with screw
 Perno con vite
 Punzón con perno
 Broche avec vis

Lochzangen
 Punch Forceps
 Pinze foradiga
 Perforadores
 Pincas à perforer

Kofferdam-Klammerzangen
Rubber-Dam Clamp Forceps
Pinze per uncini
Pinzas para grapas dique de goma
Pincès porte-crampons

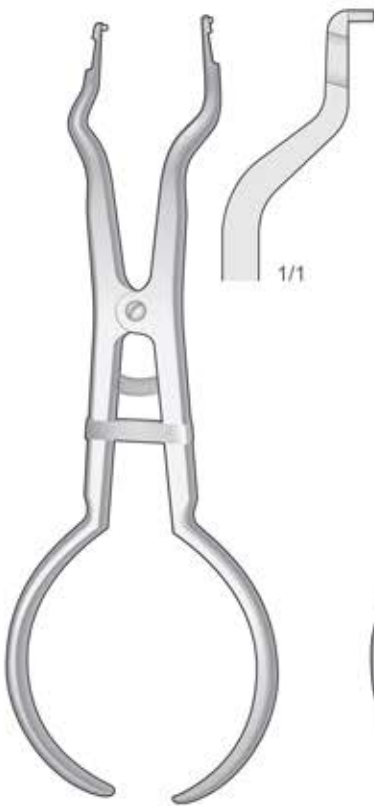

BREWER
DF-10
170 mm

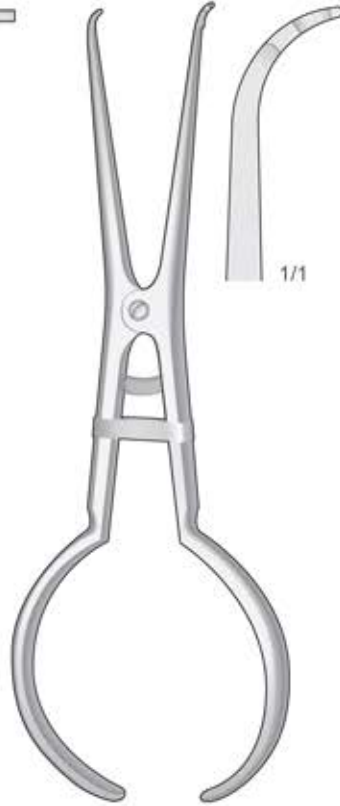

PALMER
DF-15
170 mm

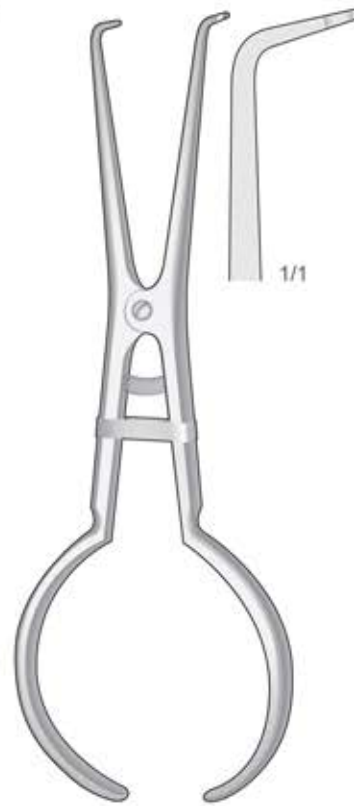

STOKE
DF-16
170 mm

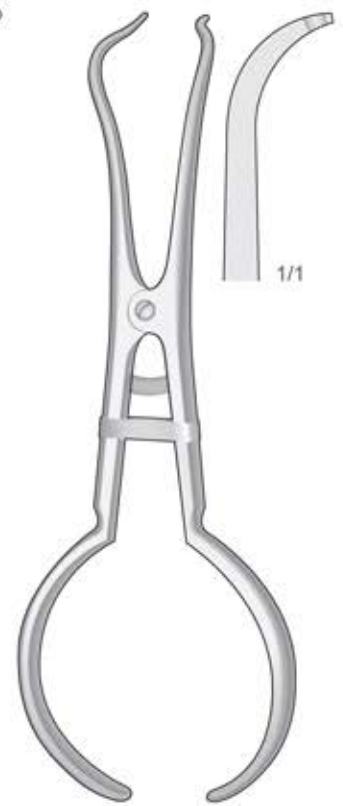

DF-18
170 mm

Matrizenspanner und Matrizenbänder
 Matrix Retainers and Matrix Bands
 Portamatrici e matrici
 Portamatrices y bandas matrices
 Porte-matrices et bagues matrices

Molaren, 12 Stück
 Molars, 12 pieces
 Molari, 12 pezzi
 Molares, 12 piezas
 Molaïres, 12 Pièces

Premolaren, 12 Stück
 Premolars, 12 pieces
 Premolari, 12 pezzi
 Premolares, 12 piezas
 Prémolaires, 12 Pièces



DF-40/1
Fig.1



DF-41/4
Fig.4



DF-40/2
Fig.2



DF-41/5
Fig.5



DF-40/3
Fig.3



DF-41/6
Fig.6

Kofferdam-Klammerzangen
 Rubber-Dam Clamp Forceps
 Pinze per uncini
 Pinzas para grapas dique de goma
 Pincès porte-crampons

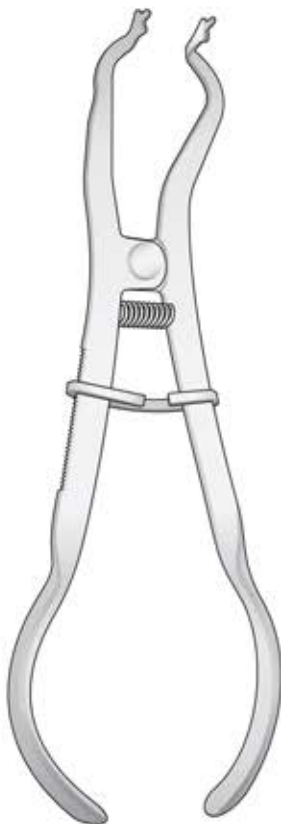

IVORY
DF-12
170 mm



IVORY
DF-43
Fig. 14

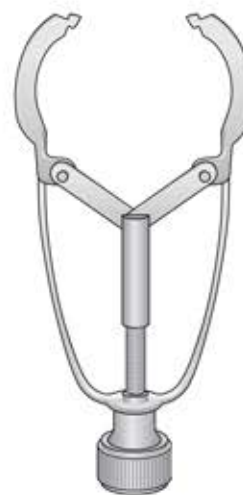

IVORY
DF-40
Fig. 1



IVORY
DF-41
Fig. 12

Kofferdam Instrumente
 Rubber-Dam Instruments
 Strumenti per diga
 Instrumentos para dique de goma
 Instruments pour digue de caoutchouc

Kofferdam-Klammern
 Rubber-Dam Clamps
 Uncini per diga
 Clamps para diques
 Crampons pour digue



IVORY
DF-126
 # 26



IVORY
DF-127
 # 27



IVORY
DF-128
 # 28



IVORY
DF-129
 # 29



IVORY
DF-130
 # 30



IVORY
DF-131
 # 31



IVORY
DF-151
 # 51



IVORY
DF-160
 # 60

Kofferdam-Rahmen
 Rubber-Dam Frames
 Telaio per diga
 Cuadro para diques
 Cadre à digue



DF-30
 80x75 mm
 Kinder
 Children
 Bambini
 Niños
 Enfants

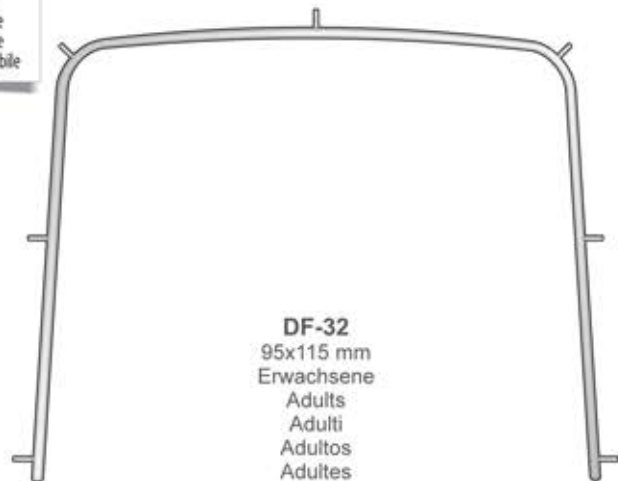

DF-32
 95x115 mm
 Erwachsene
 Adults
 Adulti
 Adultos
 Adultes

Matrizenspanner und Matrizenbänder
 Matrix Retainers and Matrix Bands
 Portamatrici e matrici
 Portamatrices y bandas matrices
 Porte-matrices et bagues matrices

Molaren, 12 Stück
 Molars, 12 pieces
 Molari, 12 pezzi
 Molares, 12 piezas
 Molaïres, 12 Pièces



DF-03/7
#7



DF-03/8
#8



DF-03/9
#9



DF-03/10
#10

Premolaren, 12 Stück
 Premolars, 12 pieces
 Premolari, 12 pezzi
 Premolares, 12 piezas
 Prémolaires, 12 Pièces



DF-03/11
#11



DF-03/12
#12



DF-03/13
#13

TOFFLEMIRE
 Universal



DF-03/1
#1



DF-03/2
#2



DF-03/3
#3

DF-01/5 5 mm x 1 mt
 DF-01/6 6 mm x 1 mt
 DF-01/7 7 mm x 1 mt



DF-05/5 5 mm x 5 mt
 DF-05/6 6 mm x 5 mt
 DF-05/7 7 mm x 5 mt



IVORY
 DF-06/DF-09
 #8

DF-06 5 mm
 DF-08 6 mm
 DF-09 7 mm

Paar - Pair
 Coppia - Par
 Paire



#1
 Rechts
 Right
 Destra
 Derecha
 Droite



#2
 Links
 Left
 Sinistra
 Izquierda
 Gauche

NYSTRÖM
 DF-04
 #1 + #2



TOFFLEMIRE
 DF-07
 Universal

L

Suction Tubes
Saugkanülen
Canules d'aspiration
Cánulas de aspiración
Cannule per aspirazione



Saugkanülen
 Suction Tubes
 Cannule per aspirazione
 Cánulas de aspiración
 Canules d'aspiration

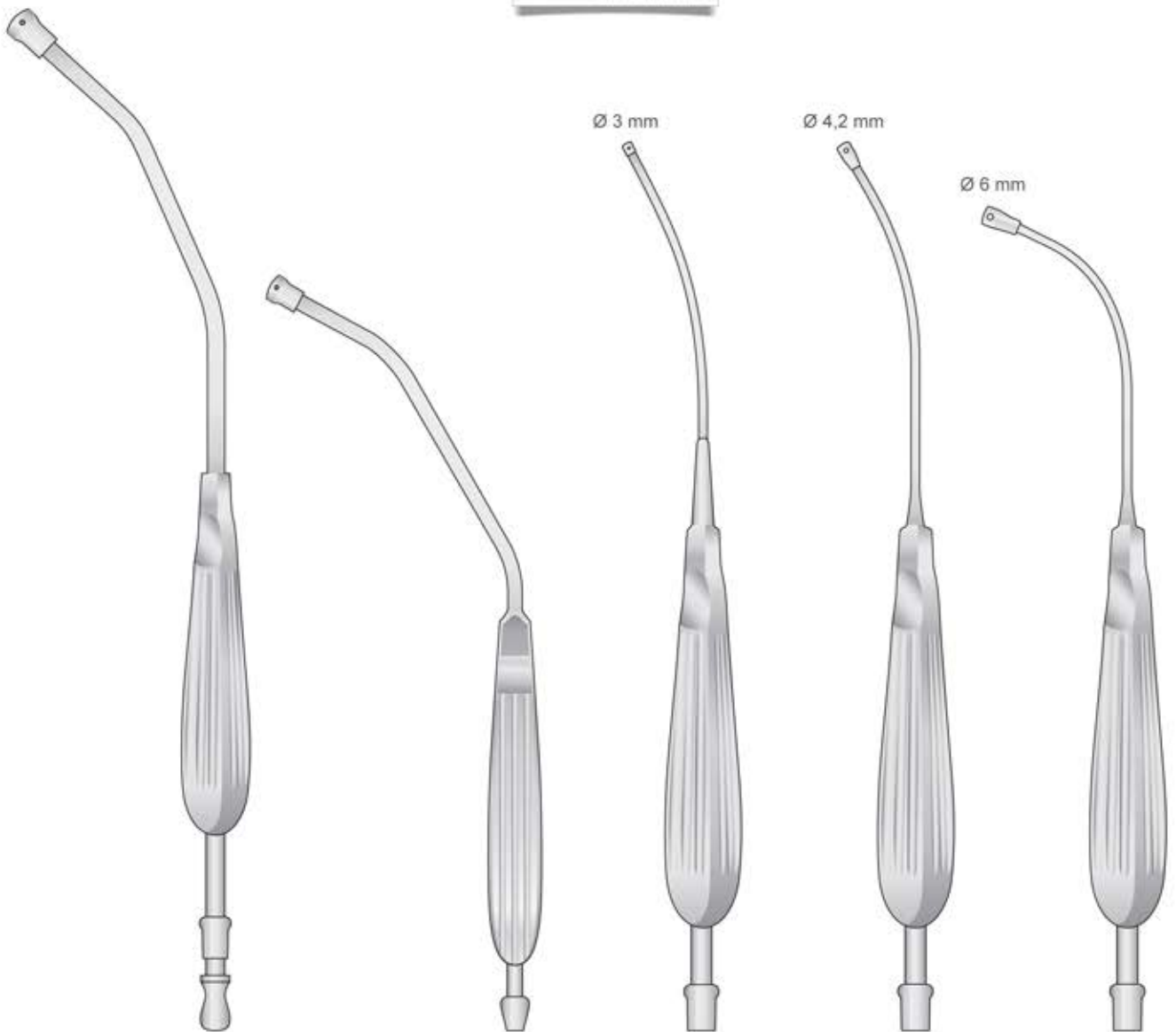

YANKAUER
GF-12
 310 mm

BABY-YANKAUER
GF-10
 200 mm

ANDREWS-PYNCHON
GF-06
 250 mm

ANDREWS-PYNCHON
GF-07
 250 mm

ANDREWS-PYNCHON
GF-54
 230 mm

Saugkanülen
Suction Tubes
Cannule per aspirazione
Cánulas de aspiración
Canules d'aspiration

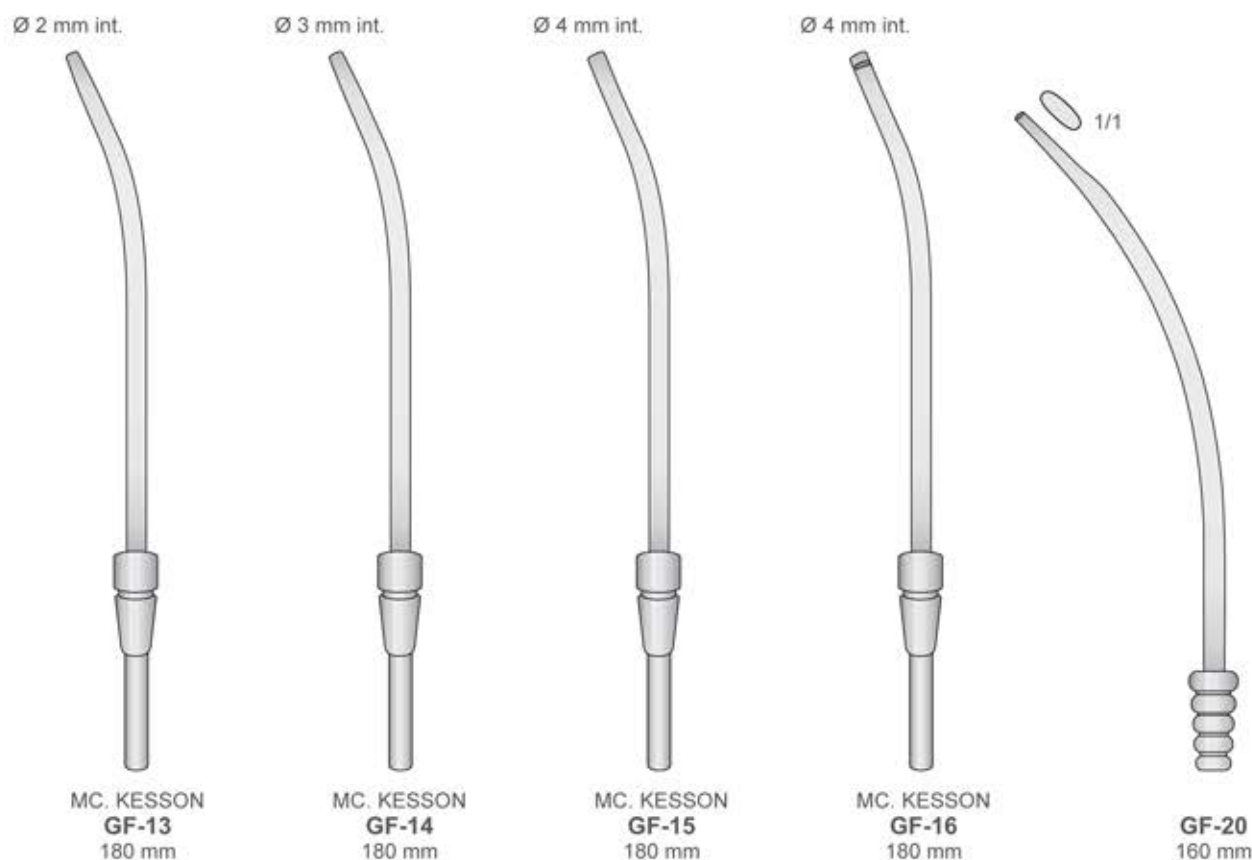
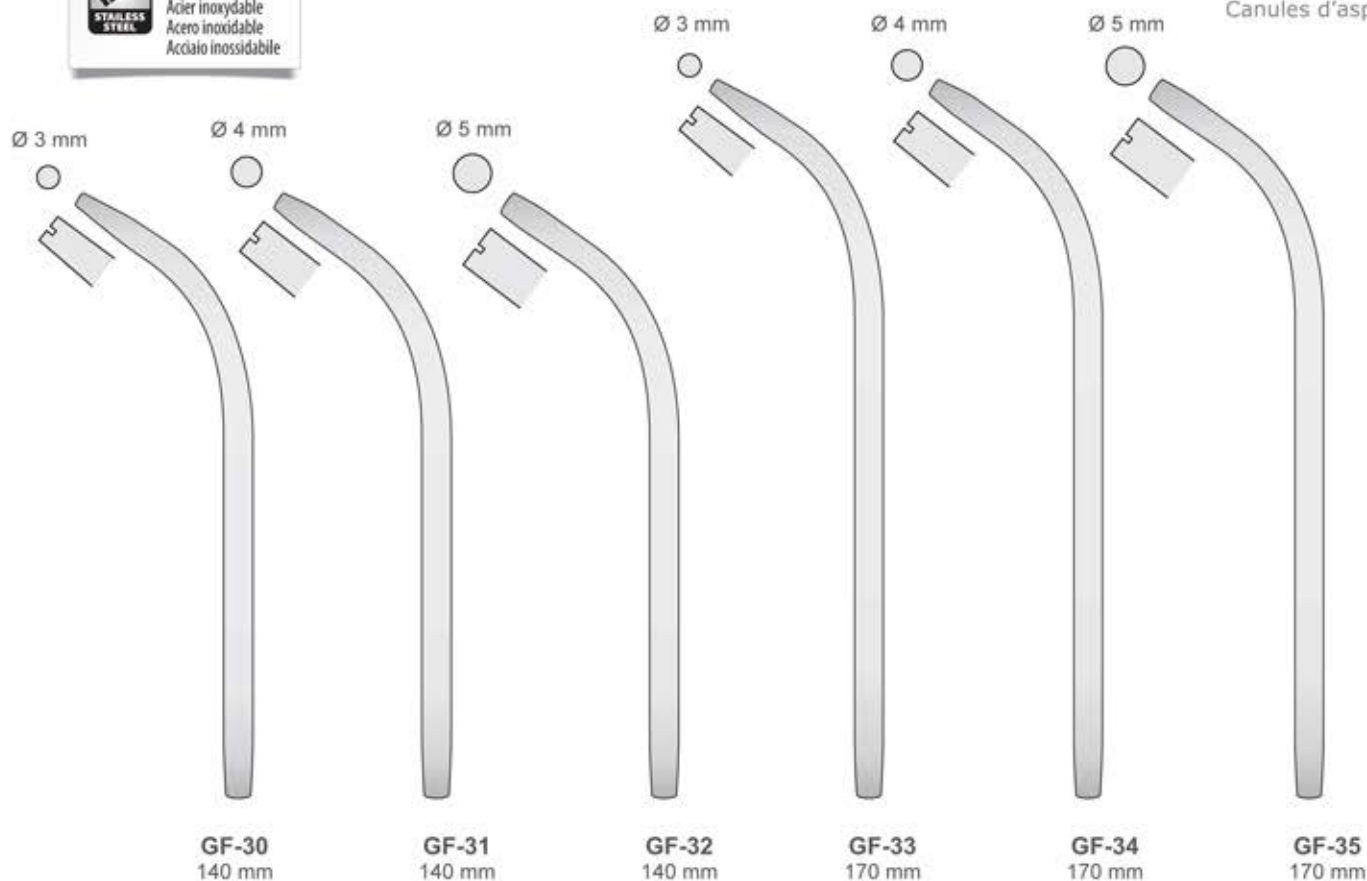

Saugkanülen
Suction Tubes
Cannule per aspirazione
Cánulas de aspiración
Canules d'aspiration



TS-40
Connection piece for suction
75 mm - 100% Stainless Steel



COUPLAND
GF-01
150 mm

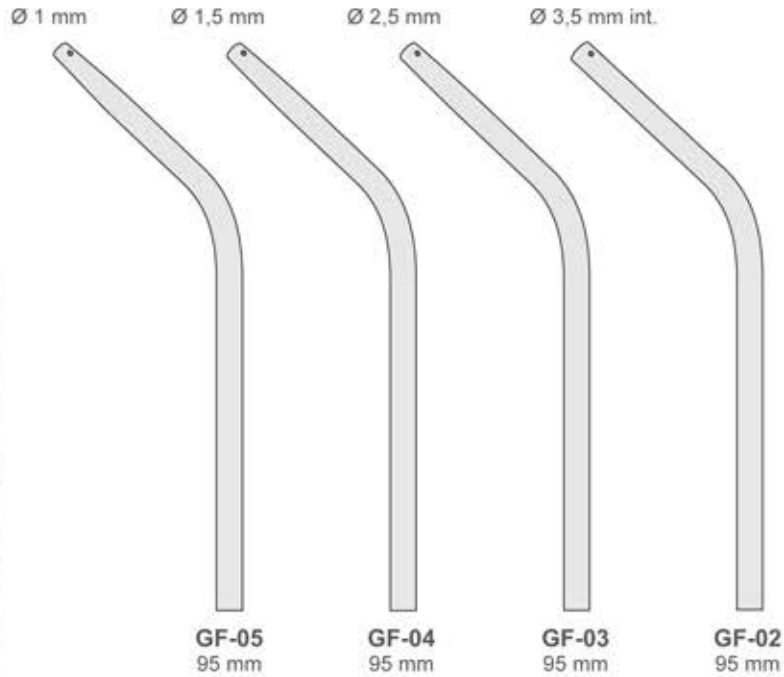

COMPLETE SET
GF-11
(GF-01 + GF-02 + GF-03 + GF-04 + GF-05)
Griff + 4 Kanülen
Handle + 4 tubes
Manico + 4 cannule
Mango + 4 cánulas
Manche + 4 canules



Autoclavable Tubing
Schlauch - Silikon
Flexible Tube - Silicone
Raccordo in silicone per cannule
Tubo flexible de silicona
Tuyau - Silicone

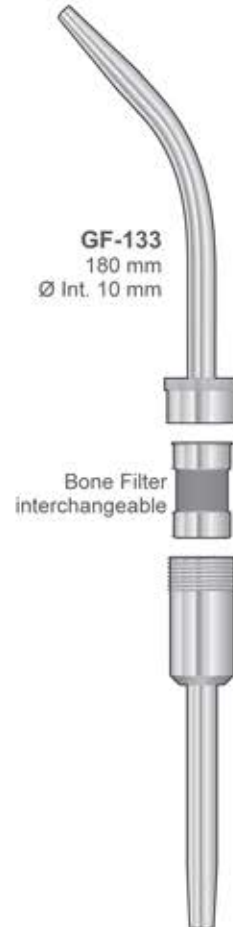

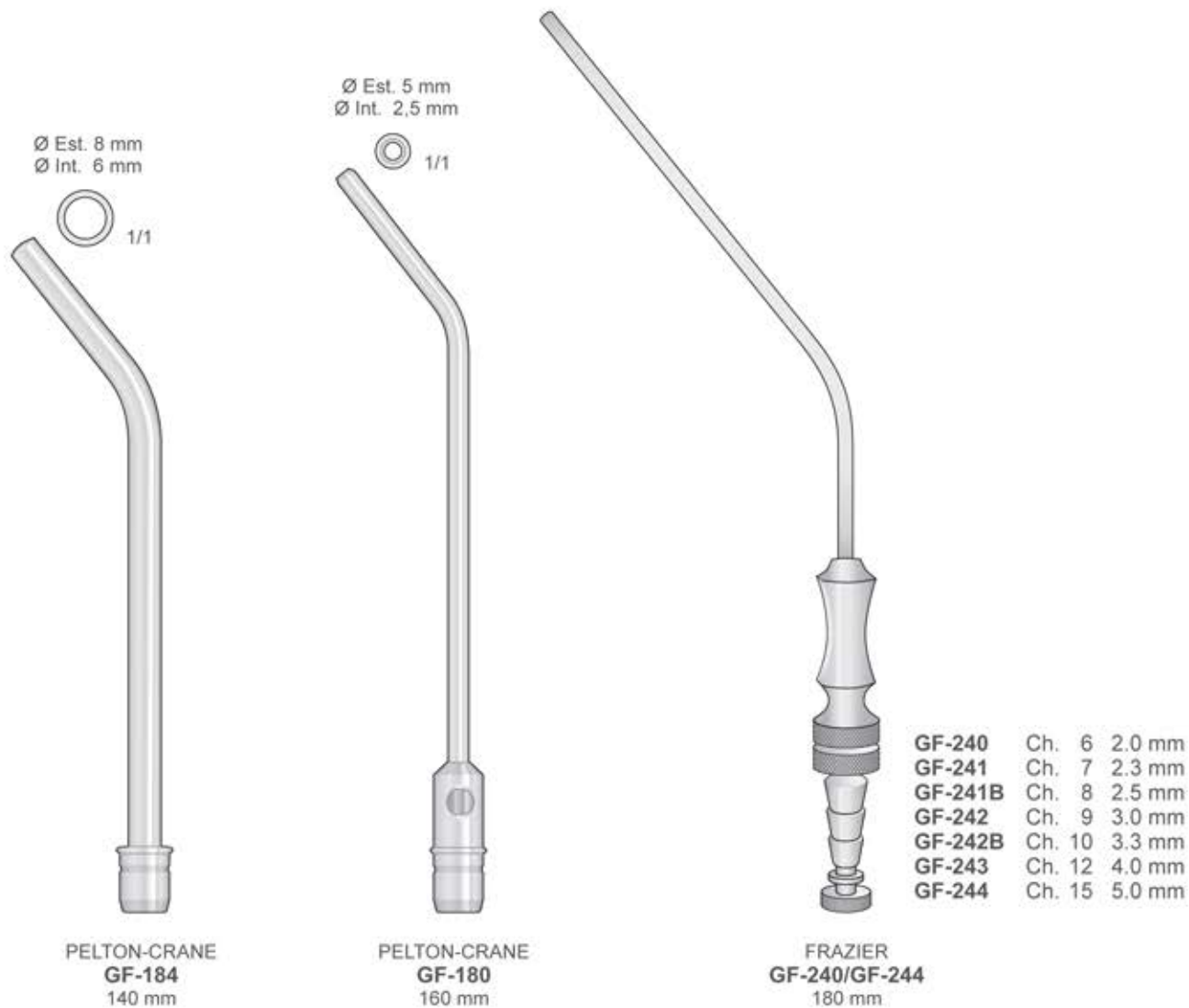

Saugkanülen
 Suction Tubes
 Cannule per aspirazione
 Cánulas de aspiración
 Canules d'aspiration



Flexible
 Flexibel
 Flexible
 Flexible
 Flessibile

Ø 3 mm

WERTHEIMER
GF-69
 160 mm



FRAZIER
GF-70
 160 mm

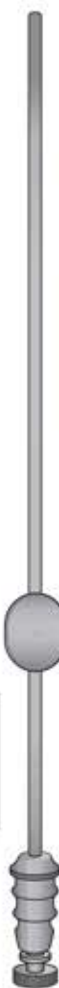

Flexible
 Flexibel
 Flexible
 Flexible
 Flessibile

Ø 3 mm

FRAZIER
GF-61
 200 mm



WERTHEIMER
GF-60
 200 mm



GF-41 ch. 12 Ø 4 mm
GF-42 ch. 15 Ø 5 mm
 210 mm

Kanülenreinigungs-Bürsten
 Cleaning brush for Tubes
 Scovolini per pulizia cannule
 Cepillo para limpiar cánulas
 Brosse de nettoyage pour canules



Bürsten
 Brush
 Spazzola
 Cepillo
 Brosse

Autoklav
 Autoclavable
 Autoclavabile
 Autoclave
 Autoclave

GF-200
 4 x 11 cm



GF-40
 235 mm



GF-182
 215 mm



GF-183
 300 mm



GF-185
 300 mm



GF-188
 220 mm

M

Orthodontics
Kieferorthopädie
Orthodontie
Ortodoncia
Ortodonzia



Drahtbiegezangen
 Wire Bending Pliers
 Pinze per piegare fili
 Alicates para doblar alambres
 Pincès à pliers les fils

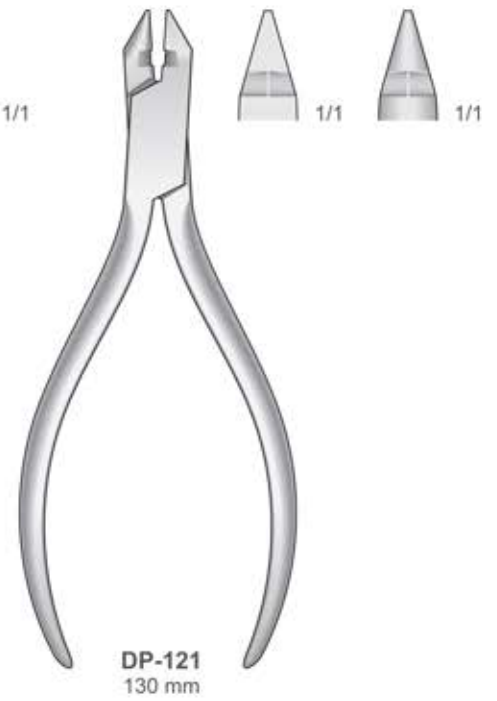

Tungsten-Carbide Inserts
 Mit Hartmetalleinsätzen
 Plaquettes en carbure de tungstène
 Plaquetas de carburo de tungsteno
 Inserti in carburo di tungsteno

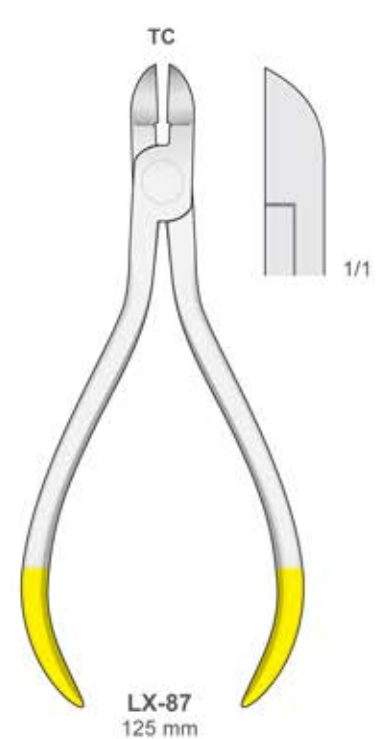
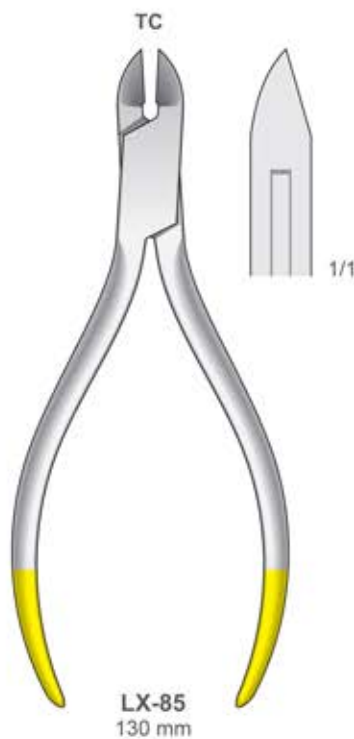
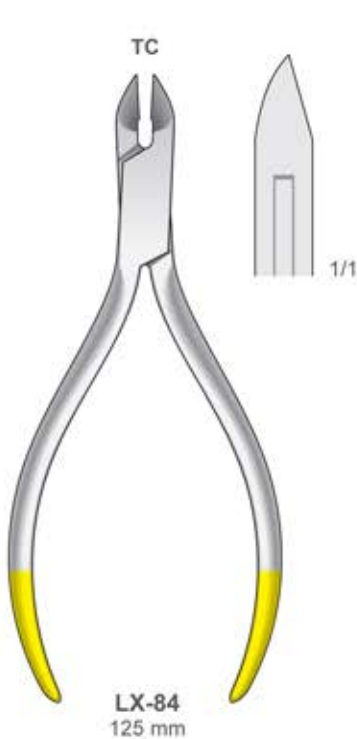



Drahtbiegezaugen
Wire Bending Pliers
Pinze per piegare fili
Alicates para doblar alambres
Pincès à pliers les fils

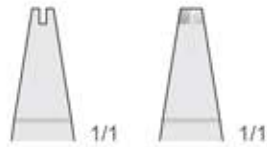

Drahtbiegezaugen
Wire Bending Pliers
Pinze per piegare fili
Alicates para doblar alambres
Pincès à pliers les fils



TC
TUNGSTEN CARBIDE
Tungsten-Carbide Inserts
Mit Hartmetalleinsätzen
Plaquettes en carbure de tungstène
Plaquetas de carburo de tungsteno
Inserti in carburo di tungsteno



Drahtschneidezangen
 Wire cutting pliers
 Tronchesi per fili metallici
 Alicates para cortar alambre
 Pincès à couper les fils

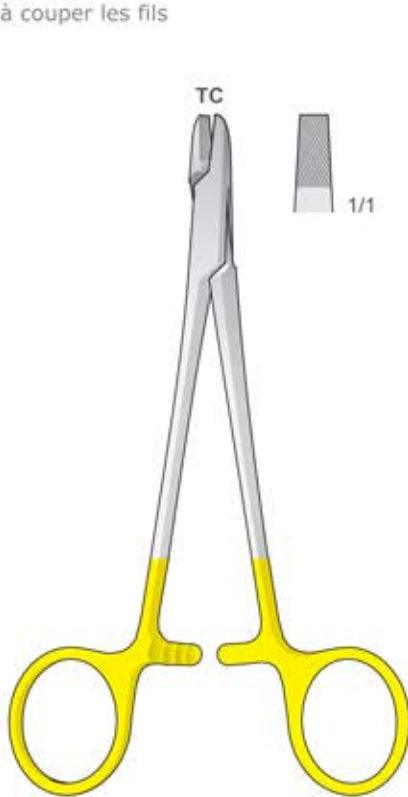

PH-58
150 mm



**SMITH
FG-161**
160 mm



**SMITH
FG-160**
160 mm

TC
TUNGSTEN CARBIDE
Tungsten-Carbide Inserts
 Mit Hartmetalleinsätzen
 Plaquettes en carbure de tungstène
 Plaquetas de carburo de tungsteno
 Inserti in carburo di tungsteno

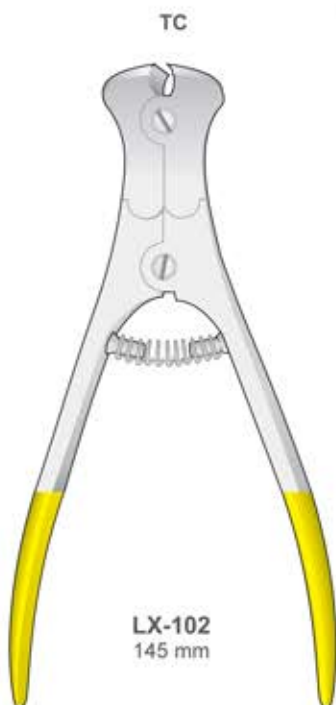

LX-102
145 mm

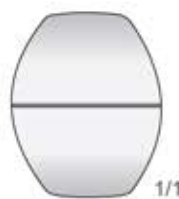

○ Max Ø 2.0 mm (.078")

Für weichen Draht
 For soft Wire
 Per filo leggero
 Para alambre blando
 Pour fil léger

○ Max Ø 1.5 mm (.059")

Für harten Draht
 For hard Wire
 Per filo duro
 Para alambre duro
 Pour fil dur

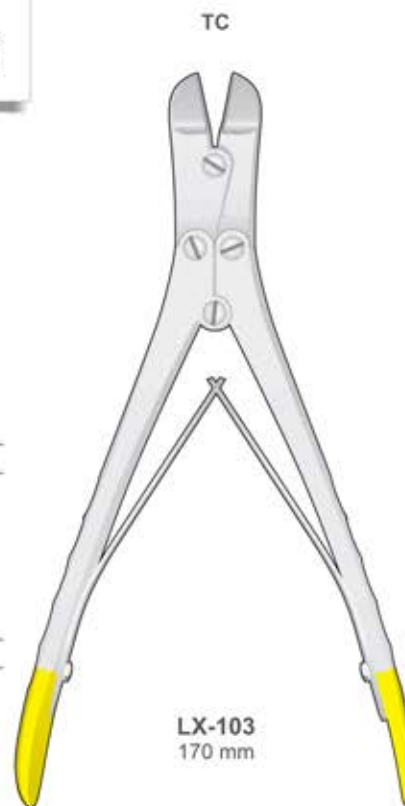

LX-103
170 mm

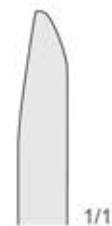

○ Max Ø 2.0 mm (.078")

Für weichen Draht
 For soft Wire
 Per filo leggero
 Para alambre blando
 Pour fil léger

○ Max Ø 1.5 mm (.059")

Für harten Draht
 For hard Wire
 Per filo duro
 Para alambre duro
 Pour fil dur

Scheren für dünne Stahl-und Edelmetallbleche - Scissors for thin steel and precious metal sheets
Forbici per lamine sottili di acciaio e metalli preziosi - Tijeras para láminas delgadas de acero y metales preciosos
Ciseaux pour couper les feuilles de métaux

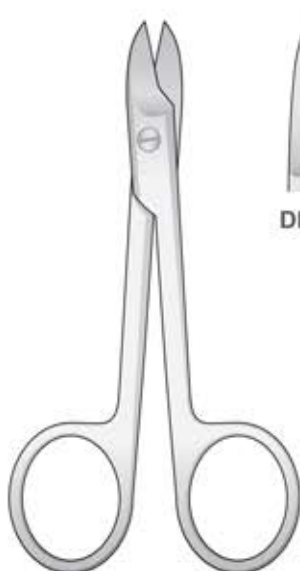

BEEBE
DP-91/DP-92
110 mm

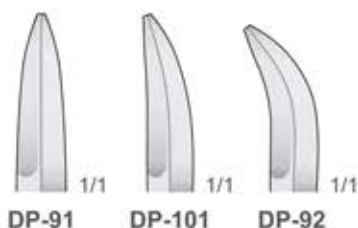

Spitz
Sharp
Acute
Aguda
Pointu

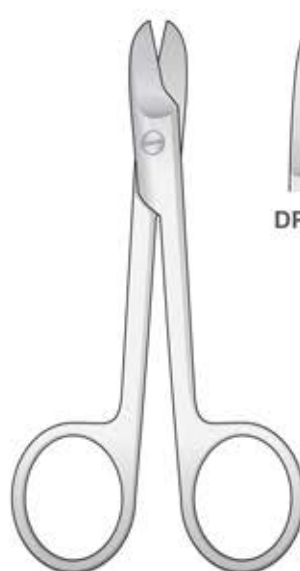

BEEBE
DP-102/DP-103
110 mm

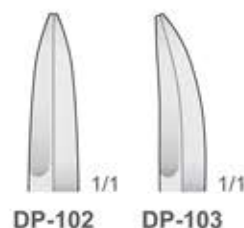

Stumpf
Blunt
Smusse
Roma
Mousse

Scheren für dünne Stahl-und Edelmetallbleche - Scissors for thin steel and precious metal sheets
Forbici per lamine sottili di acciaio e metalli preziosi - Tijeras para láminas delgadas de acero y metales preciosos
Ciseaux pour couper les feuilles de métaux

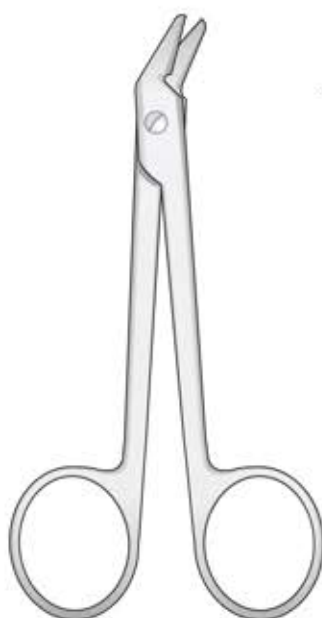

DP-90
120 mm

Draht-und Blechscherer gezahnt
Wire cutting scissor serrated
Forbice universale dentellata
Tijeras para cortar hilo
de acero dentadas
Coupe-fils dentelé



DP-120
120 mm

TC
TUNGSTEN CARBIDE
Tungsten-Carbide Inserts
Mit Hartmetalleinsätzen
Plaquettes en carbure de tungstène
Plaquetas de carburo de tungsteno
Inserti in carburo di tungsteno

○ Max Ø 1.2 mm (.048")
Für weichen Draht
For soft wire
Per filo leggero
Para alambre blando
Pour fil léger

Separierzangen
 Separating Pliers
 Pinze tendielastici
 Pinza estira-elásticos
 Pince à separer

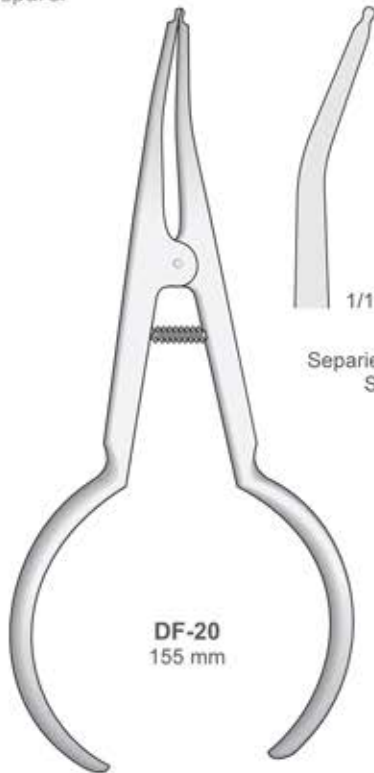

DF-20
155 mm



1/1



1/1

Separierzange, zum Einbringen von Gummi-Separierligaturen
 Separating forceps for inserting elastic separators
 Pinze per legature per separatori elastici
 Pinza para ligaduras estira-elásticos
 Pince à separer les ligatures

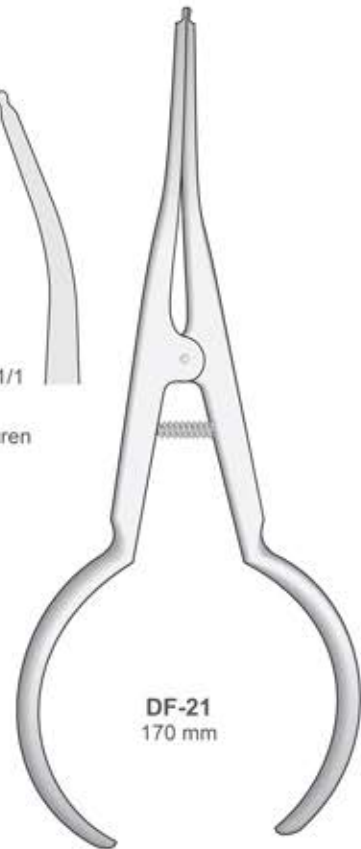

DF-21
170 mm

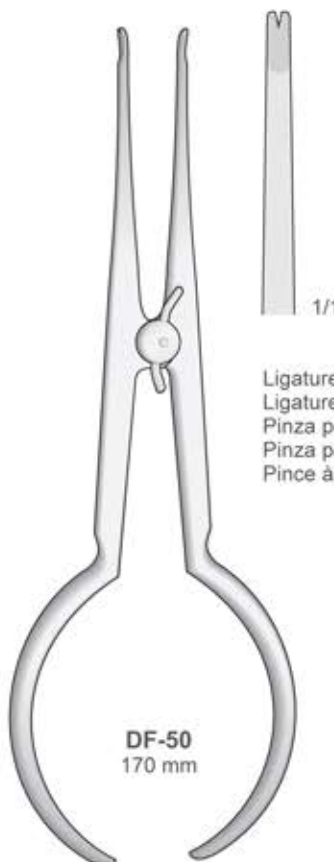

DF-50
170 mm



1/1

Ligaturenspannzange
 Ligature Tying Plier
 Pinza per legature
 Pinza para ligaduras
 Pince à serrer les ligatures



Bracketset Pinzette
 Bonding Bracket Forceps
 Pinzette per brackets
 Pinza fina para ligar brackets
 Fine pince à lier des boîtiers

DP-150
160 mm

5.0
4.0
0

Utility Instrumente
 Utility Instruments
 Strumenti di utilità
 Instrumentos para utilidad
 Instruments pour utility



DP-100
170 mm

Bracketpositioner
 Bracket Positioning Gauge
 Posizionatore per attacchi
 Posicionador de Brackets
 Positionateur des Brackets



Aluminium
 Aluminium
 Aluminium
 Aluminio
 Alluminio



Gezahnt
 Serrated
 Dentellato
 Dentado
 Dentelé

MERSHON DP-50
140 mm

Verbandschieber
 Band Pusher
 Spingibande
 Empujador de bandas
 Enforce-bague

Ligaturen Instrumente
 Ligating Instruments
 Strumenti per legature
 Instrumentos para ligaduras
 Instruments pour ligatures

DP-100
170 mm



SHURE DP-124
175 mm



DP-54
175 mm



DP-125
155 mm



PF-1
170 mm



PF-2
170 mm



PF-3
160 mm

Ligature Instruments
 Ligating Instruments
 Strumenti per legature
 Instrumentos para ligaduras
 Instruments pour ligatures

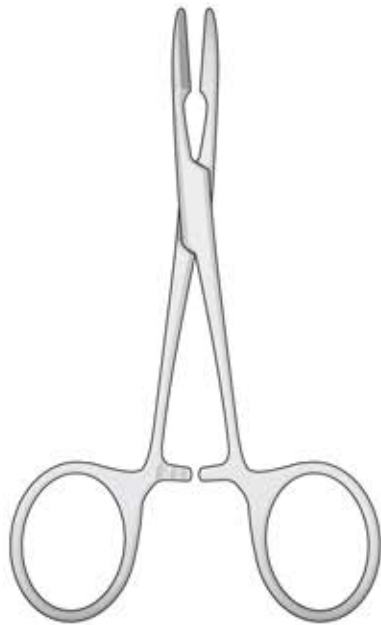

PEAN-MURPHY
BF-22
 130 mm

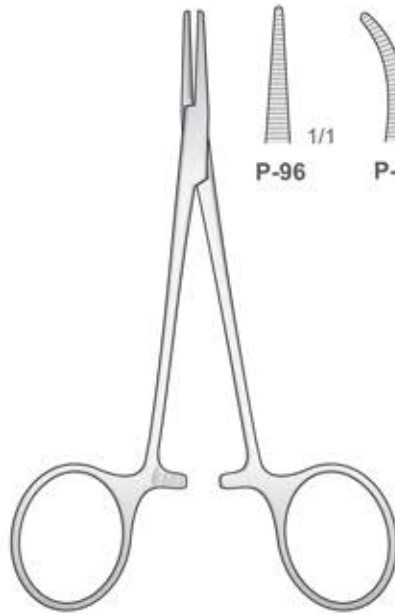

HALSTED-MOSQUITO
P-96/P-97
 120 mm

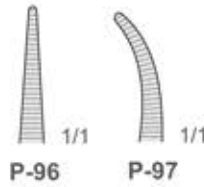

COLLEGE
 150 mm



MILLER
DR-78
 145 mm

Bracketset Pinzette - Forceps for positioning brackets
 Pinzette per riposizionare gli attacchi diretti
 (posizionamento dei bracket)
 Pinza para colocar brackets - Précelle pour positionner les brackets

Bracket Gauge
 Stainless Steel



DP-132
 130 mm



DP-133
 130 mm



DP-52
 130 mm



DP-126
 110 mm



DP-127
 125 mm



DP-128
 145 mm

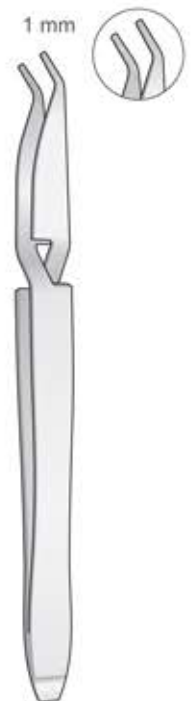

DP-129
 130 mm

Dental-Schieblehre für Praxis und Labor
Gauge Caliper for practice and laboratory
Calibri dentali per studio e laboratorio
Calibrador dental para práctica y el laboratorio
Gauge calibreur pour practice et laboratoire



0 - 10 mm
Messbereich
Measuring range
Campo di misura
Rango de medición
Champ de mesure

**IWANSON
DP-721**
100 mm

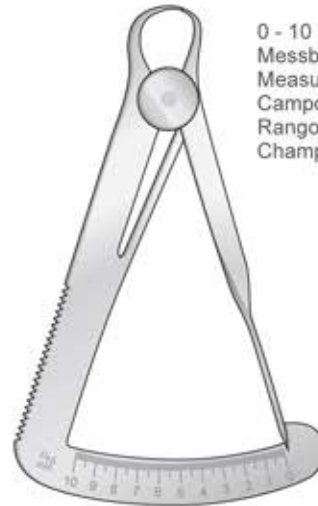

0 - 10 mm
Messbereich
Measuring range
Campo di misura
Rango de medición
Champ de mesure

**IWANSON
DP-720**
100 mm

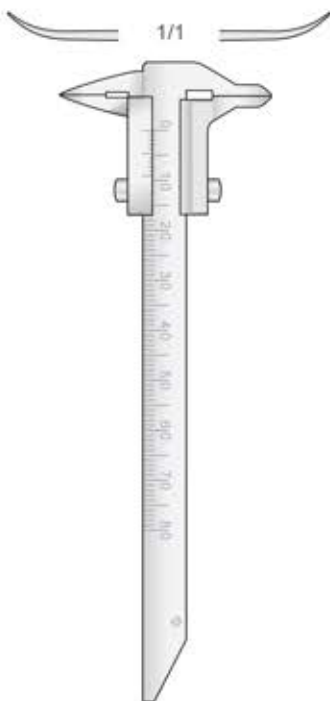

DP-723
80 mm

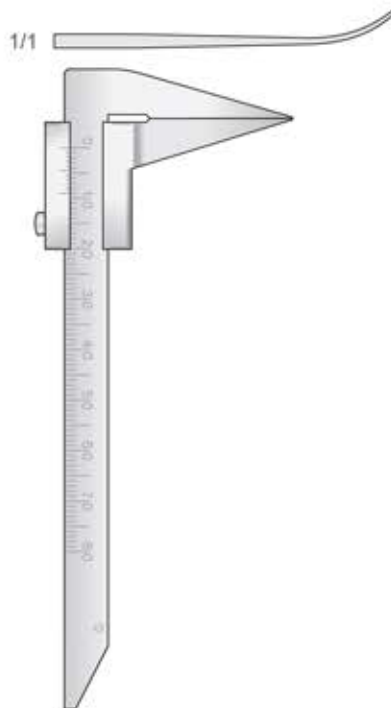

DP-724
80 mm



**ZIELINSKY
DP-725**
110 mm

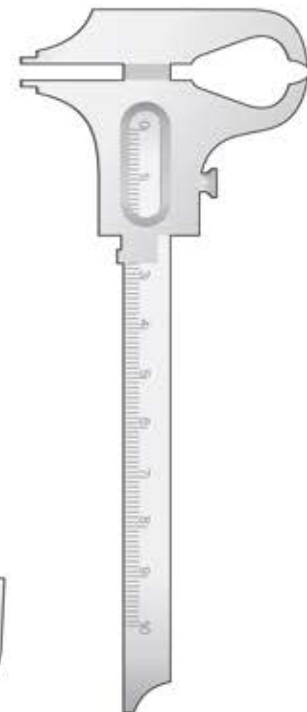

**BOLEY
DP-730**
140 mm

0 - 100 mm
Messbereich
Measuring range
Campo di misura
Rango de medición
Champ de mesure

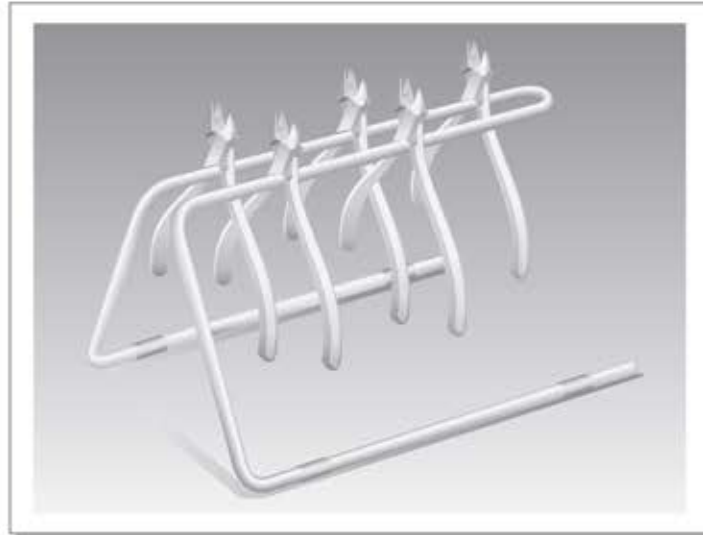

Zangenständer
 Plier Stand
 Supporto per pinze
 Soportes para alicates
 Supports de pinces

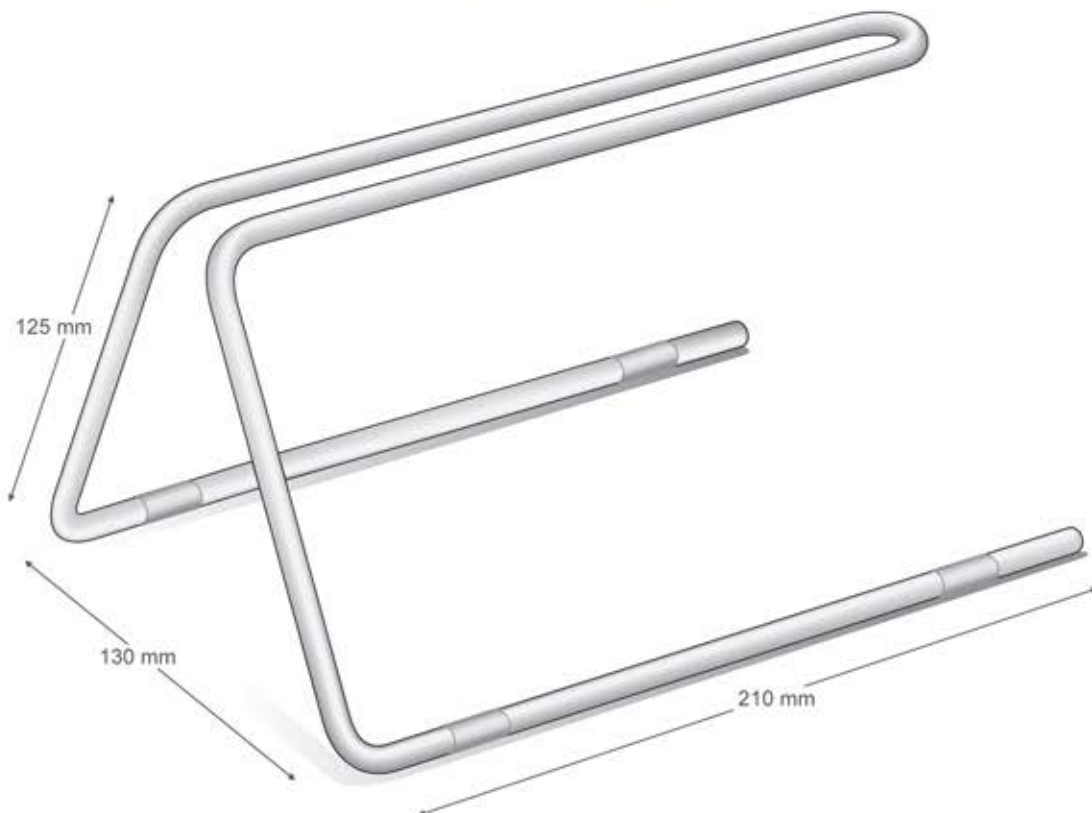

DP-140

N

Crown Instruments

Kronentferner
Enlève-couronne
Removedor de coronas
Leva corone

Laboratory

Laboratorium
Laboratoire
Laboratorio
Laboratorio





Kroneninstrumente
 Crown Instruments
 Pinze per corone
 Alicates para coronas
 Pincés pour couronnes



**KERLING
 DP-38A**
 145 mm

Kupferingabnehmezange
 Copper Ring Removing Pliers
 Pinza per togliere anelli di rame
 Pinza para sacar anillos de cobre
 Pince à enlever les bagues en cuivre



**FURRER
 DP-38**
 145 mm



DP-38R
 Schraube
 Replacement Screw
 Vite di ricambio
 Tornillos de recambio
 Vis de rechange

Teleskopkronenzangen - Pliers for telescope crowns
 Pinze per corone telescopiche - Alicates para coronas telescópicas
 Pincés pour couronnes telescopes



**BÖHM
 DP-28**
 150 mm



**BÖHM
 DP-29**
 150 mm



DP-24
 120 mm



DP-24C
 Schlüssel
 Key
 Chiavetta
 Llave
 Clé



DP-24R
 Diamantierte Einsätze, paar
 Diamond inserts, pairs
 Puntae diamantate, coppia
 Puntas diamantadas, par
 Pointes diamantées, pair

**MRT/C7
 BRIDGE-EXTRACTOR
 COMPLETE SET**
 MRT-7 + C-71 + C-72 + C-73 + C-74

Removing pliers
 for temporary
 bridges and crowns

TC
Tungsten-Carbide Inserts
 Mit Hartmetalleinsätzen
 Plaquettes en carbure de tungstène
 Plaquetas de carburo de tungsteno
 Inserti in carburo di tungsteno

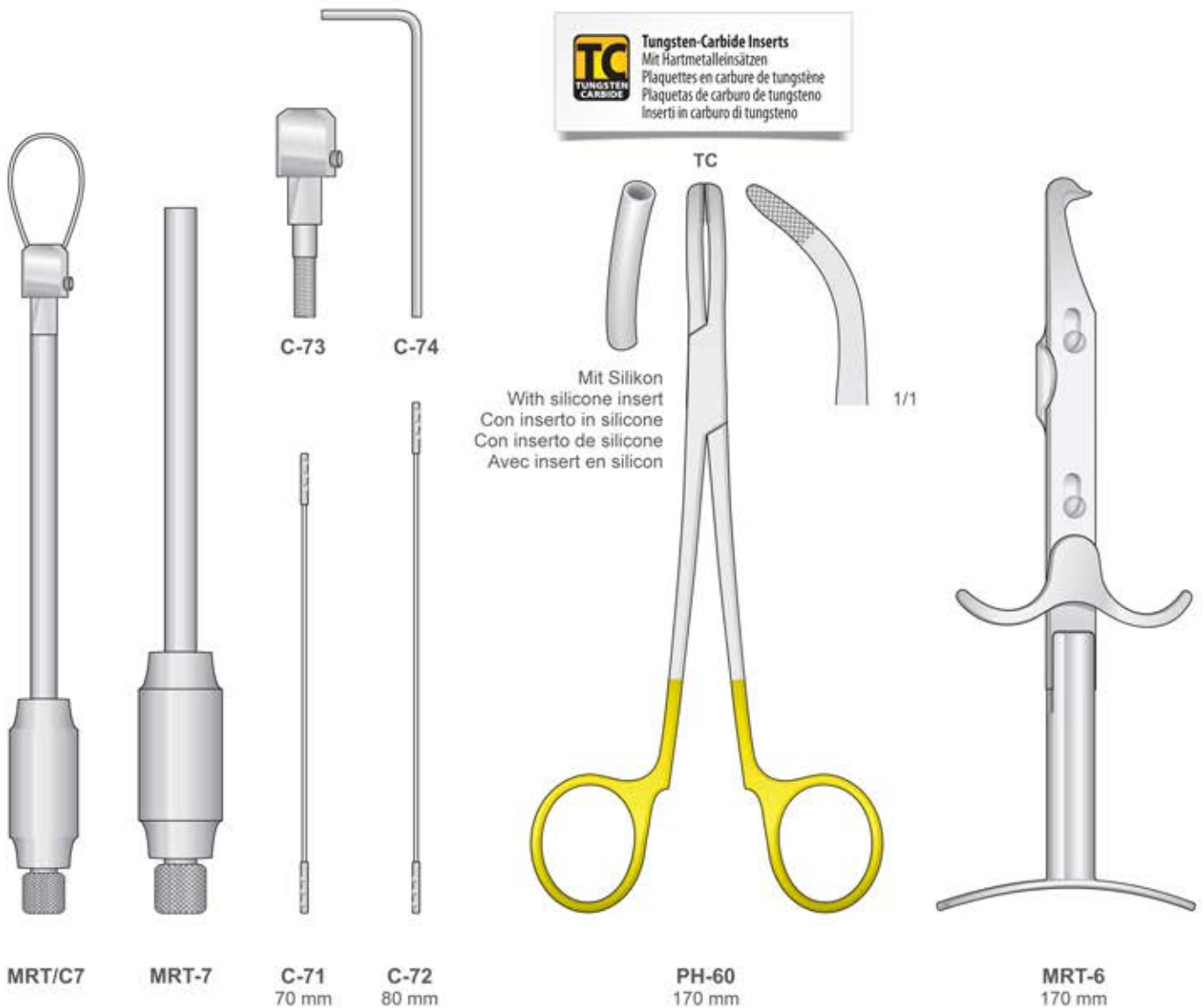

MRT/C7

MRT-7

C-71
70 mm

C-72
80 mm

PH-60
170 mm

MRT-6
170 mm



Kronenentferner
 Crown Removers
 Leva corone
 Removedor de coronas
 Enlève-couronne

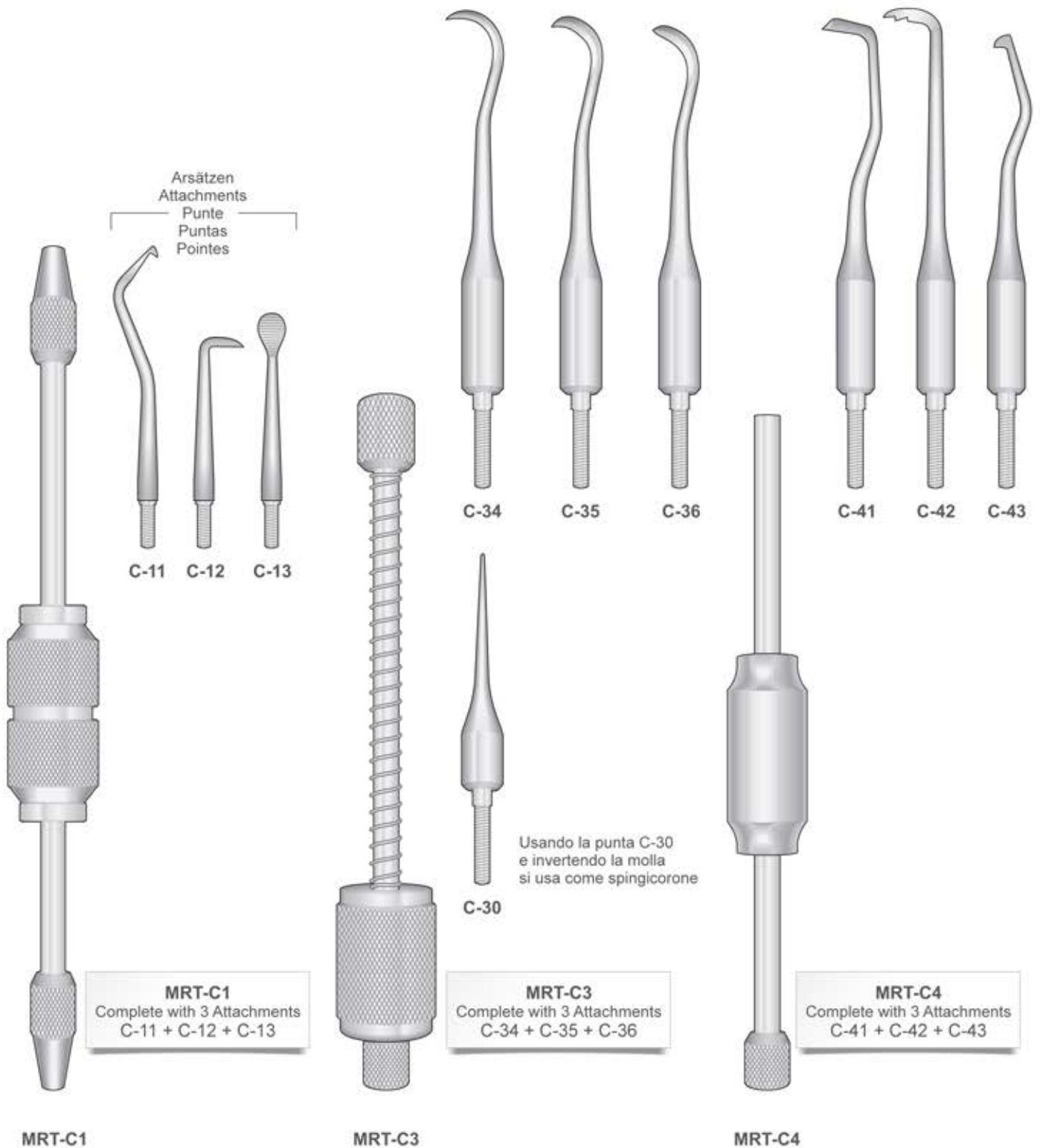

Kronentferner
 Crown Removers
 Leva corone
 Removedor de coronas
 Enlève-couronne



DL-C
140 mm



**UNIVERSAL
DL-60**
150 mm



DL-V
130 mm



DL-0
130 mm

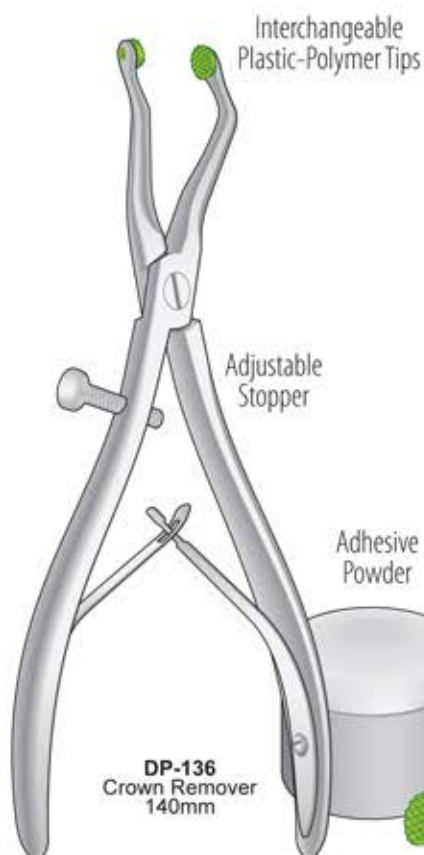

DP-136

Crown Remover Set

1 Crown Remover+ 10 Pairs of Plastic-Polymer Tips + 10g Adhesive Powder

Kronentferner Set

1 Kronenaufweitzange + 10 Paar Kunststoff-Polymer-Tipps + 10g Pulverkleber

Set Enlève-Couronne

1 Pince à détacher les couronnes + 10 Paires de pointes de polymère plastique + 10g Adhésif en poudre

Set Removedor de Coronas

1 Pinza para quitar coronas + 10 Pares de puntas de polímero plástico+ 10g Polvo adhesivo

Set Leva Corone

1 Pinza per corone + 10 Coppie di inserti in plastica + 10 g Polvere adesiva

DP-137

Replacement Kit: 10 Pairs of Plastic-Polymer Tips + 10g Adhesive Powder

Ersatz-Kit: 10 Paar Kunststoff-Polymer-Tipps + 10g Pulverkleber

Kit de rechange: 10 Paires de pointes de polymère plastique + 10g Adhésif en poudre

Kit de recambio: 10 Pares de puntas de polímero plástico+ 10g Polvo adhesivo

Kit di ricambio: 10 Coppie di inserti in plastica + 10 g Polvere adesiva

Wachsmesser
 Wax Knives
 Coltelli per cera
 Cuchillos para cera
 Couteaux à cire



FAHNENSTOCK
CP

FAHNENSTOCK
CG

LESSMANN
CPL

LESSMANN
CGL

CPS

CGS



Spatel
Spatulas
Spatole
Espátulas
Spatules

Spatulas for plaster and alginate
Spatole per alginato e gesso



Flexible
Flexibel
Flexible
Flexible
Flessibile

Rigid
Fest
Rigide
Rígido
Rigido



**GRITMAN
CM**
175 mm



SA-1
200 mm



SA-2
200 mm



SA-3
200 mm



S18-8
185 mm

Instrumente für Laboratorium
 Instruments for laboratory
 Strumenti da laboratorio
 Instrumentos para laboratorio
 Instruments pour laboratoire

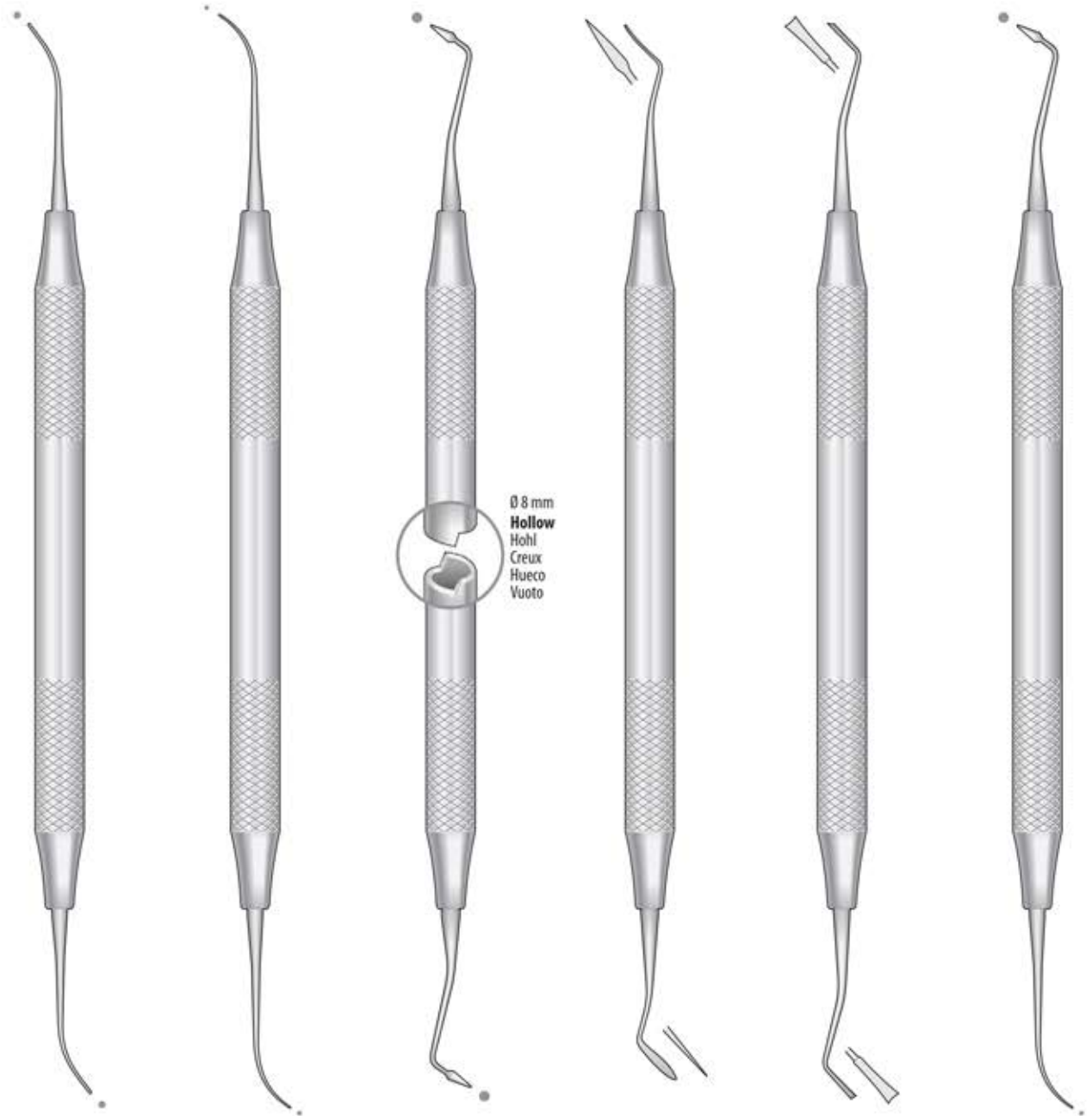

Ø 8 mm
Hollow
 Hohl
 Creux
 Hueco
 Vuoto

P.K. THOMAS
751-121
 165 mm

P.K. THOMAS
751-122
 165 mm

P.K. THOMAS
751-123
 165 mm

P.K. THOMAS
751-124
 165 mm

P.K. THOMAS
751-125
 165 mm

P.K. THOMAS
751-2/3
 165 mm



P.K. THOMAS
PT-1
165 mm



P.K. THOMAS
PT-2
165 mm



P.K. THOMAS
PT-3
165 mm



P.K. THOMAS
PT-4
165 mm

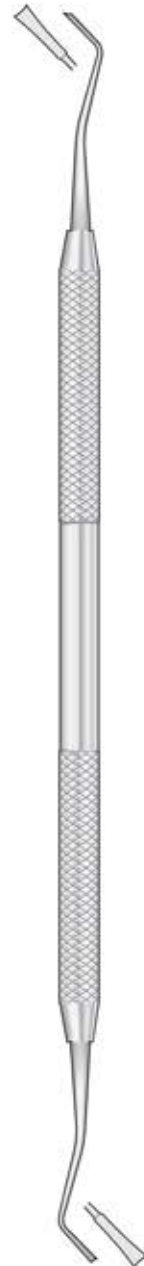

P.K. THOMAS
PT-5
165 mm

Instrumente für Laboratorium
 Instruments for laboratory
 Strumenti da laboratorio
 Instrumentos para laboratorio
 Instruments pour laboratoire

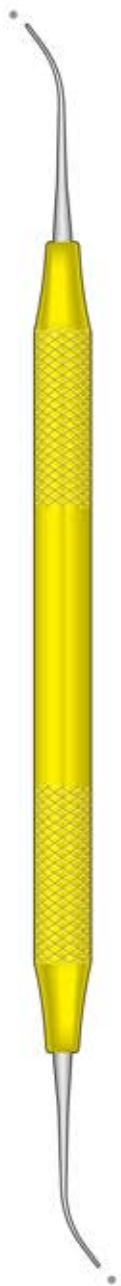

P.K. THOMAS
AL-PT1
 165 mm



P.K. THOMAS
AL-PT2
 165 mm

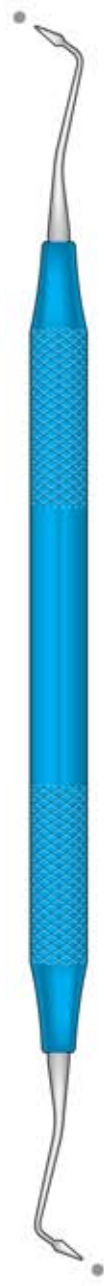

P.K. THOMAS
AL-PT3
 165 mm

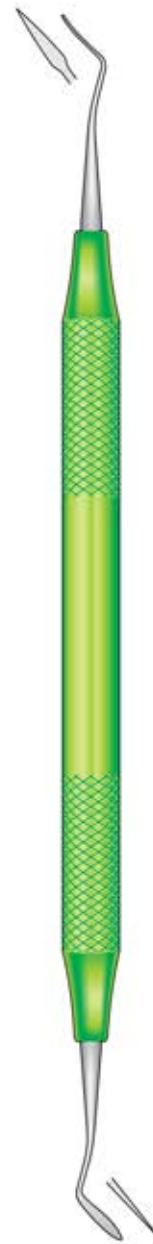

P.K. THOMAS
AL-PT4
 165 mm



P.K. THOMAS
AL-PT5
 165 mm

Ø 8 mm
Hollow
 Hohl
 Creux
 Hueco
 Vuoto

Modellierinstrumente für Keramik
 Ceramic Sculpturing Instruments
 Strumenti per ceramica
 Instrumentos para modelar la cerámica
 Instruments à modeler la céramique

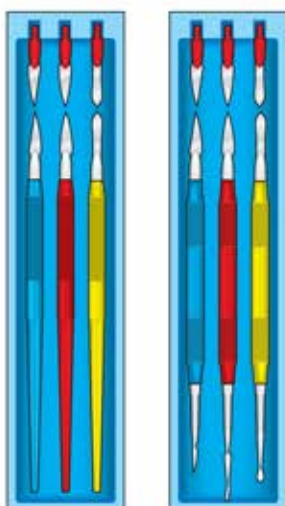

Biegsam - Flexible
 Flessibili - Flexibles
 Flexibles



CL-1B

CL-2B

CL-3B

Superbiegsam - Superflexible
 Superflessibili - Superflexibles
 Superflexibles



CL-1R

CL-2R

CL-3R



AL-SETC/1

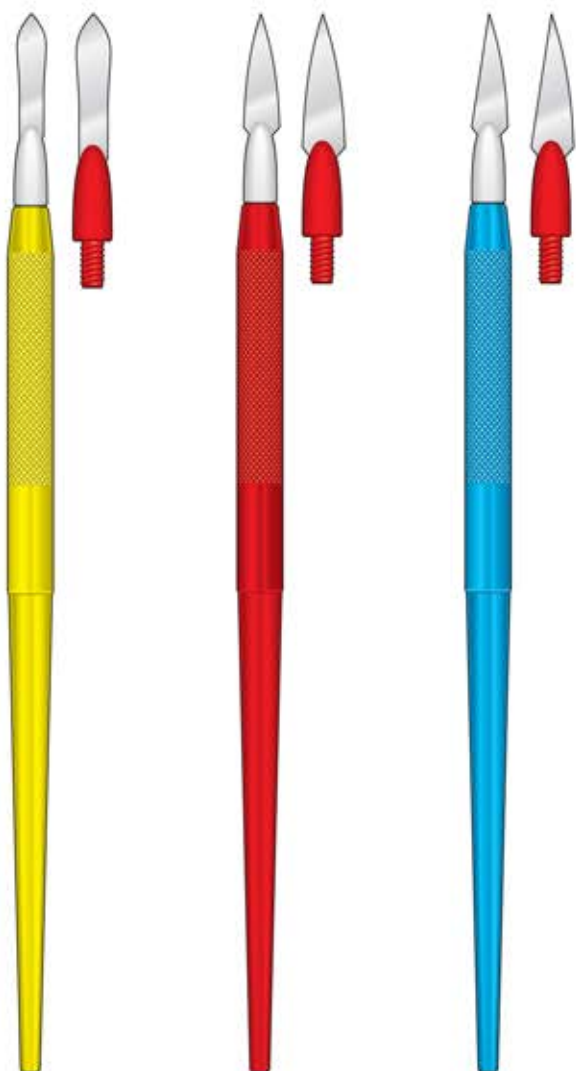

AL-SETC/2

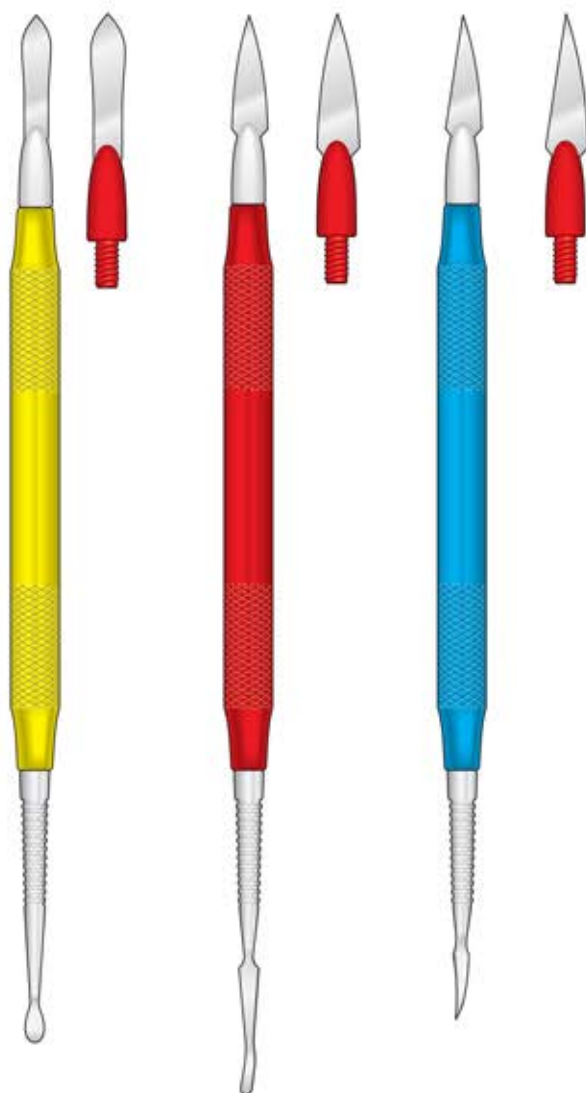

Instrumente für Laboratorium
 Instruments for laboratory
 Strumenti da laboratorio
 Instrumentos para laboratorio
 Instruments pour laboratoire

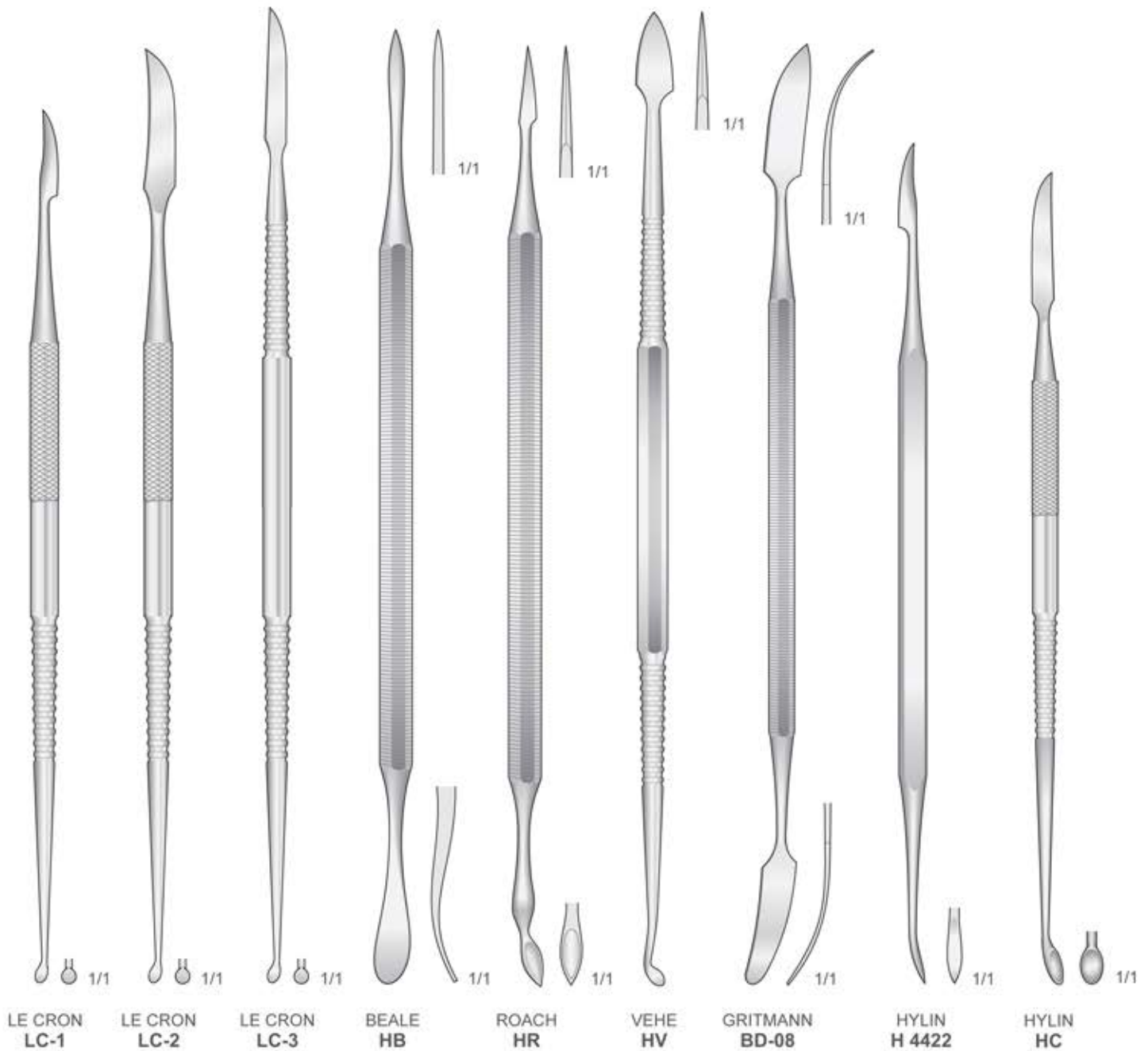

Instrumente für Laboratorium
 Instruments for laboratory
 Strumenti da laboratorio
 Instrumentos para laboratorio
 Instruments pour laboratoire

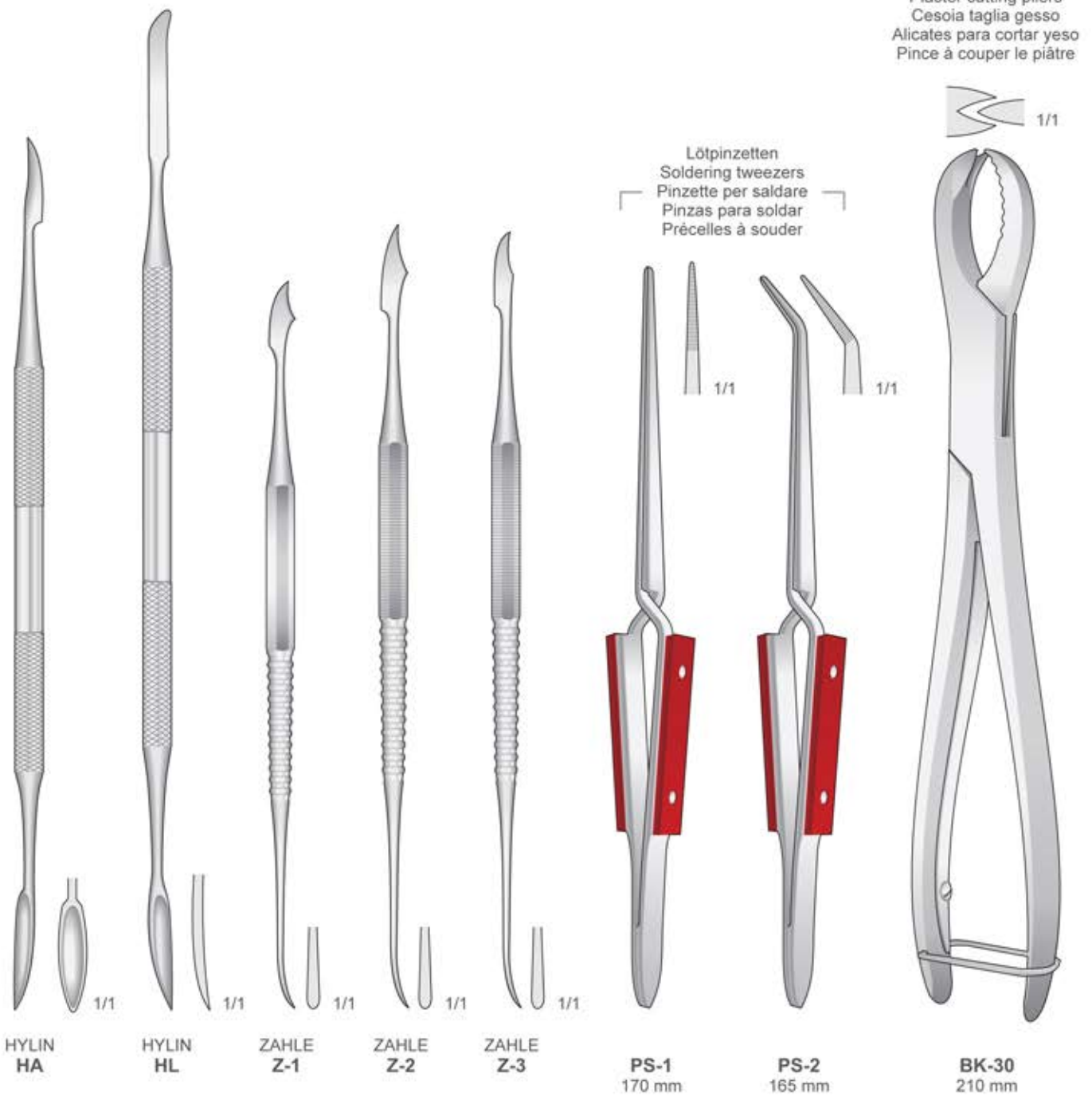

0

Instrument Maintenance
Instrumentenwartung
Entretien des instruments
Mantenimiento de instrumentos
Manutenzione degli strumenti

Sterilization
Sterilisierung
Stérilisation
Esterilización
Sterilizzazione





Gefäße aus Edelstahl
 Stainless Steel Receptacles
 Recipienti in acciaio inossidabile
 Recipientes de acero inoxidable
 Réceptibles en acier inoxydable

Nadeldose
 Needle case
 Scatola per aghi
 Caja para agujas
 Boîte à aiguilles



BS-1
 Ø 78 mm h 15 mm

Nierenschalen
 Kidney bowls
 Bacinelle reniformi
 Rifioneras
 Bassins réniformes



BR-20 200 mm
BR-25 250 mm
BR-28 280 mm

Verbandstofftrommeln
 Dressing sterilizing drums
 Cestelli cilindrici
 Caja para esterilización
 Boîte à stérilisation



CS-12 125x125 mm
CS-15 150x150 mm
CS-19 190x145 mm

Runder Sterilbehälter mit Ausguss
 Round sterile bowl
 Capsule inox con fondo piano e becco
 Cubetas de acero inoxidable
 Cuvettes de acier inoxydable



CS-01 Ø 40 mm 15 cc
CS-02 Ø 60 mm 75 cc
CS-03 Ø 80 mm 225 cc
CS-04 Ø 100 mm 325 cc
CS-05 Ø 120 mm 500 cc



BS-32
 180 x 85 x 20 mm

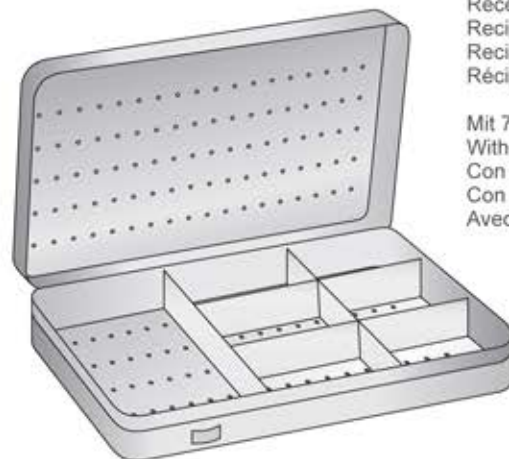

BS-27
 150 x 90 x 20 mm

Gefäße
 Receptacles
 Recipiente
 Recipientes
 Réceptibles

Mit 7 box
 With 7 box
 Con 7 box
 Con 7 box
 Avec 7 box

Steril Container
Sterilization Container
Contenitori per sterilizzazione
Contenedores para esterilización
Conteneurs pour stérilisation

Schalen
Trays
Vassoi
Bandejas
Bassins



VS-20 210 x 110 x 25 mm
VS-26 250 x 180 x 30 mm
VS-30 300 x 220 x 30 mm



BS-41
275 x 130 x 25 mm

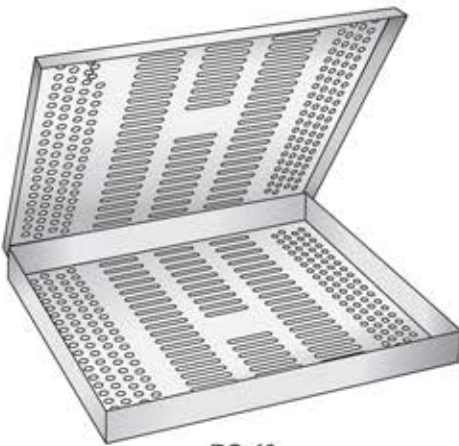

BS-43
285 x 190 x 25 mm

Mit Instrumentehalter und box
With Insert frames and box
Con griglia e scomparti
Con porta instrumentos y box
Avec Porte instruments et box



BS-40 275x130x25mm
BS-42 285x190x25mm

Silicon Mat
Silikon Noppenmatten
Tappeti di silicone
Tapiz de silicona
Tapis en silicone

Autoklav
Autoclavable
Autoclavabile
Autoclave
Autoclave

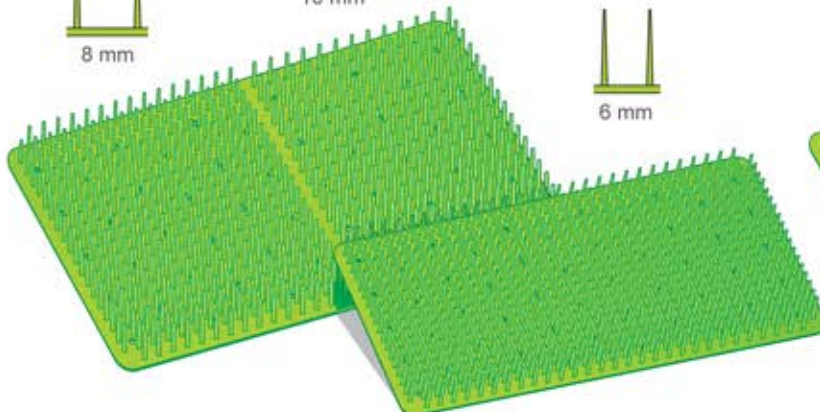
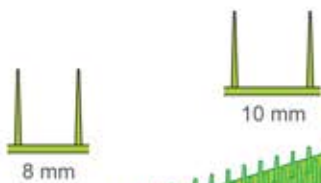

TS-104
270 x 180 mm

TS-103
260 x 120 mm

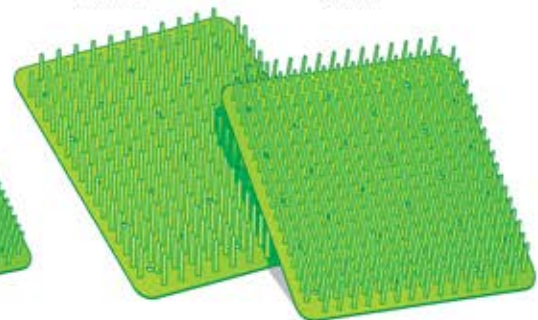

TS-102
135 x 180 mm

TS-101
135 x 180 mm



Steril Container
 Sterilization Container
 Contenitori per sterilizzazione
 Contenedores para esterilización
 Conteneurs pour stérilisation

Rostfreier Stahl Sterilcontainer mit Silikoneinrichtung
 Stainless Steel Sterilization Containers with silicone racks
 Contenitori per sterilizzazione in acciaio inossidabile con griglia in silicone
 Contenedores para esterilización en acero inoxidable con soportes en silicona
 Containers pour stérilisation en acier inoxydable avec des supports de silicone

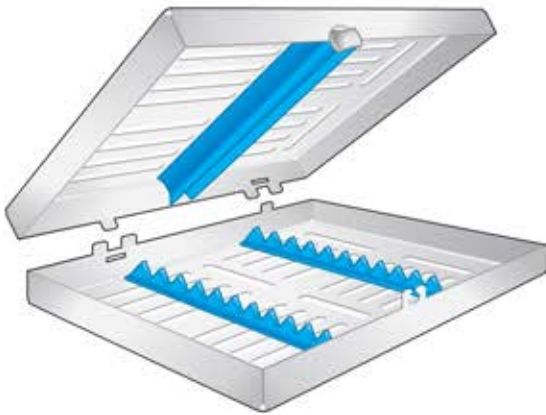

BS-60
 185 x 135 x 35 mm
 For 10 Instruments

BS-61
 290 x 185 x 35 mm
 For 20 Instruments

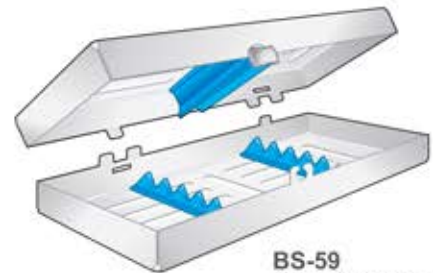

BS-59
 185 x 75 x 35 mm
 For 5 Instruments

CT-555
CT-560
CT-565



Sterilcontainer,
 mit Deckel- und Bodenperforation,
 passend in gängige Praxisautoklaven
Containers for sterilization,
 with perforation in lid and bottom,
 suitable for common practice autoclaves
Contenitori dentali,
 con coperchio e fondo perforato,
 adatti a tutte le autoclavi comuni
Contenedores dentales,
 con tapa y fondo perforados,
 aptos para autoclaves habituales
Containers stérile,
 avec perforation du couvercle et du fond,
 convenant aux autoclaves courants

CT-651
CT-652
CT-653



Alu
 Aluminium
 Alluminio
 Alumínio
 Aluminum

CT-555
 300 x 140 x 40 mm
CT-651
 310 x 190 x 40 mm

CT-560
 300 x 140 x 70 mm
CT-652
 310 x 190 x 65 mm

CT-565
 300 x 140 x 100 mm
CT-653
 310 x 190 x 130 mm

Silikoneinrichtung für Tray
 Silicone Racks for Tray
 Griglia in Silicone per Tray
 Equipo de silicona para Tray
 Aménagement en silicone pour Tray



TRANSLUCENT YELLOW
SIL-01
 130 mm



ORANGE
SIL-02
 130 mm



TRANSLUCENT GREEN
SIL-03
 130 mm



RUST RED
SIL-04
 130 mm



BLUE
SIL-05
 130 mm



Farbcodiert-Tray-Unterteile für 17 instrumente
Color-Coded bases for 17 instruments
Vassoio colorati per 17 strumenti
Bandejas en colores para 17 instrumentos
Plateaux colorés pour 17 instruments

Für 17 instrumente
For 17 instruments
Per 17 strumenti
Para 17 instrumentos
Pour 17 instruments

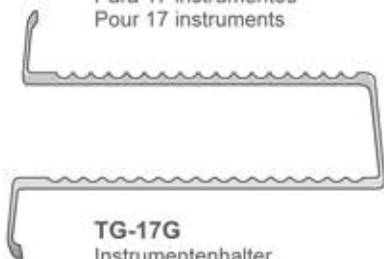

TG-17G
Instrumentenhalter
Insert frames
Griglia Portastrumenti
Porta instrumentos
Porte instruments



TG-17A
284x183x17 mm
Unterteile allein
Only base
Vassoio solo
Bandeja suelta
Plateau seul



TG-17R
284x183x17 mm
Unterteile allein
Only base
Vassoio solo
Bandeja suelta
Plateau seul



TG-17V
284x183x17 mm
Unterteile allein
Only base
Vassoio solo
Bandeja suelta
Plateau seul

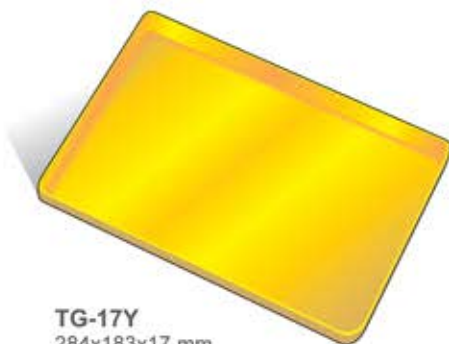

TG-17Y
284x183x17 mm
Unterteile allein
Only base
Vassoio solo
Bandeja suelta
Plateau seul



TG-17B
284x183x17 mm
Unterteile allein
Only base
Vassoio solo
Bandeja suelta
Plateau seul



TG-17C
288x187x29 mm
Tray-Deckel, grau
Lid - Grey only
Coperchio - Solo argento
Tapa en color gris
Couvercle - seulement en gris



Aluminium MIDI Tray
 Aluminium MIDI Trays
 Tray in alluminio, misura MIDI
 Bandejas de aluminio, tamaño MIDI
 Boîtes en aluminium, format MIDI



Farbcodiert-Tray-Unterteile für 8 instrumente
 Color-Coded bases for 8 instruments
 Vassoi colorati per 8 strumenti
 Bandejas en colores para 8 instrumentos
 Plateaux colorés pour 8 instruments

Für 8 instrumente
 For 8 instruments
 Per 8 strumenti
 Para 8 instrumentos
 Pour 8 instruments

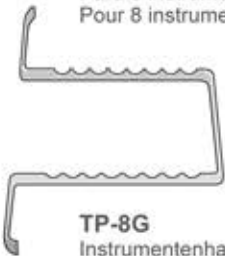

TP-8G
 Instrumentenhalter
 Insert frames
 Griglia Portastrumenti
 Porta instrumentos
 Porte instruments



TP-8A
 183x140x17 mm
 Unterteile allein
 Only base
 Vassoio solo
 Bandeja suelta
 Plateau seul



TP-8R
 183x140x17 mm
 Unterteile allein
 Only base
 Vassoio solo
 Bandeja suelta
 Plateau seul



TP-8V
 183x140x17 mm
 Unterteile allein
 Only base
 Vassoio solo
 Bandeja suelta
 Plateau seul

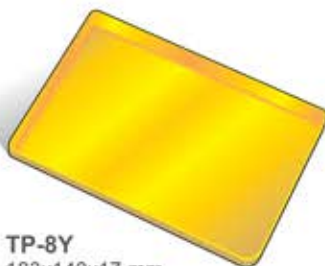

TP-8Y
 183x140x17 mm
 Unterteile allein
 Only base
 Vassoio solo
 Bandeja suelta
 Plateau seul

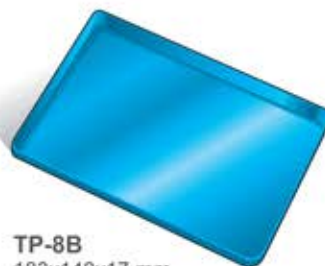

TP-8B
 183x140x17 mm
 Unterteile allein
 Only base
 Vassoio solo
 Bandeja suelta
 Plateau seul



TP-8C
 187x145x25 mm
 Tray-Deckel, grau
 Lid - Grey only
 Coperchio - Solo argento
 Tapa en color gris
 Couvercle - seulement en gris

Steril Container
 Sterilization Container
 Contenitori per sterilizzazione
 Contenedores para esterilización
 Conteneurs pour stérilisation

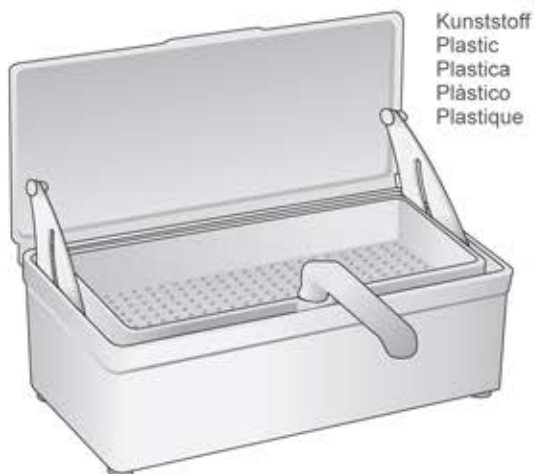

Kunststoff
 Plastic
 Plastica
 Plástico
 Plastique

BS-100
 255 x 105 x 85 mm



Siebkorb passend in Dental Container
 Basket for Dental Container
 Panniere grigliato con impugnature

CT-650
 265 x 120 x 45 mm

Rostfrei - Stainless steel - Inox - Inoxidable - Inoxydable

Norm-tray complet mit tray-unterteile, deckel und instrumentenhalter für 23 instrumente
 Instrument tray complete with base, lid and insert frame for 23 instruments
 Portastrumenti completo di vassoio, coperchio e griglia per 23 strumenti
 Bandeja completa de tapa y porta instrumentos para 23 instrumentos
 Boite complete avec plateau et couvercle pour 23 instruments



TRAY INOX
T-I
 284 x 183 x 17 mm



TRAY INOX
T-IF
 284 x 183 x 17 mm



Steril Container
 Sterilization Container
 Contenitori per sterilizzazione
 Contenedores para esterilización
 Conteneurs pour stérilisation

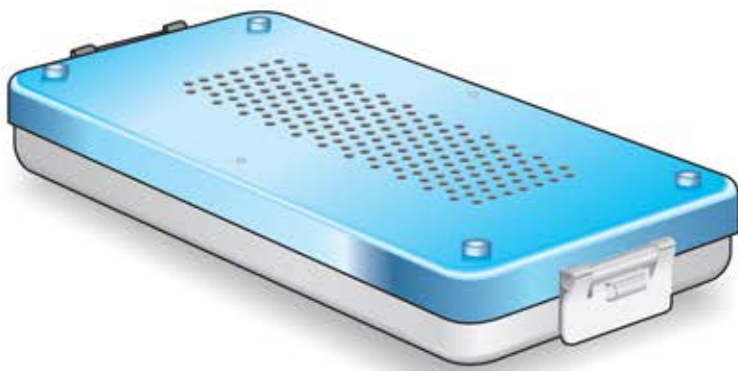

Small
 outside: 300 x 140 x 40 mm
 inside: 280 x 130 x 27 mm

- CT-555N
- CT-556N
- CT-557N
- CT-558N
- CT-559N



Medium
 outside: 300 x 140 x 70 mm
 inside: 280 x 130 x 55 mm

- CT-560N
- CT-561N
- CT-562N
- CT-563N
- CT-564N



Large
 outside: 300 x 140 x 100 mm
 inside: 280 x 130 x 84 mm

- CT-565N
- CT-566N
- CT-567N
- CT-568N
- CT-569N

Original Arkansas

Sharpening Stones
Schleifsteine
Pierres à aiguiser
Piedras de afilar
Pietre per affilare

DB-4
ARKANSAS # 4
100 mm

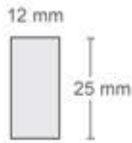

DB-299
ARKANSAS
conica # 299
90 mm



DB-96
ARKANSAS # 8
100 x 50 x 13 mm



Teflon Stick for sharpening test
Teflon-Stäbchen für das Schärfen-Test
Bâton de teflon pour probar afilado
Bâton en teflon pour tester l'aiguillage
Bastoncino di Teflon per provare affilatura



DB-15
100 mm



DB-6A
ARKANSAS # 6A
100 mm

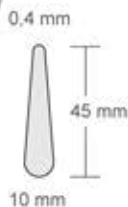

DB-11
155 mm



DB-12
175 mm

Brushes for instruments
Instrumente-Reinigungsbürsten
Brosses pour instruments
Cepillos para instrumentos
Spazzolino per strumenti



DB-3
INDIA # 6
100 mm

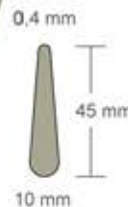

Lubricating and sharpening oil

SHARPENOIL

It is a non-coloured oil, which is an indispensable complement for lubricating and manual sharpening of surgical instruments. It should be applied to ensure perfect function and fluid movement of all surgical instruments (on all hinges or all other part which are subject to movement or friction).

Must always be used during all sharpening operations. It is used to activate the abrasive properties of all stones (Arkansas, India, etc.), and to reduce the possibility of overheating the instruments during sharpening.



DB-OL
SCHARPENÖL
30 cc

Special Rubber for Metal
Spezial-Gummi für Metall
Caoutchouc spécial pour métal
Goma especial para metal
Gomme speciali per metalli



DB-07 / DB-08
Fine / Coarse
50 x 40 x 20 mm

Bacteriostatic Anti-Corrosion Milk

CLEANLACT

Extends your surgical instrument's lifetime. A periodic use of Cleanlact prevents corrosion; it has a bacteriostatic and lubricating action on all instruments; it guarantees perfect maintenance by eliminating eventual stains, halos and browning due to sterilization, disinfection and washing with tap water. Must use periodically, diluted or concentrated (see special instructions on packaging).



CLEANLACT
DB-10M
250 cc
DB-50M
500 cc
DB-1L
1000 cc



Vorbereitung - Nagel scheren
 Preparation - Nail scissors
 Preparazione - Forbici per unghie
 Preparación - Tijeras para uñas
 Préparation - Ciseaux à ongles

Handwaschbürste
 Nail brushes
 Spazzola per unghie
 Cepillo para uñas
 Brosse à ongles



GF-200
 4 x 11 cm
 Autoclavable

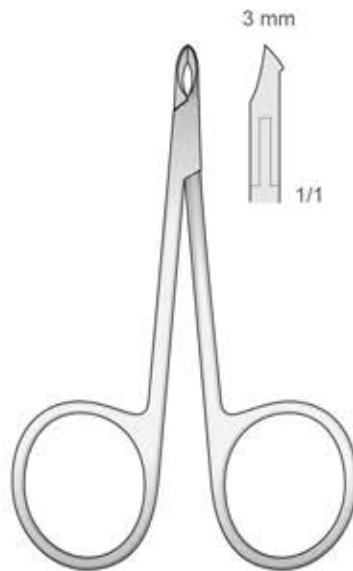

GS-40
 85 mm

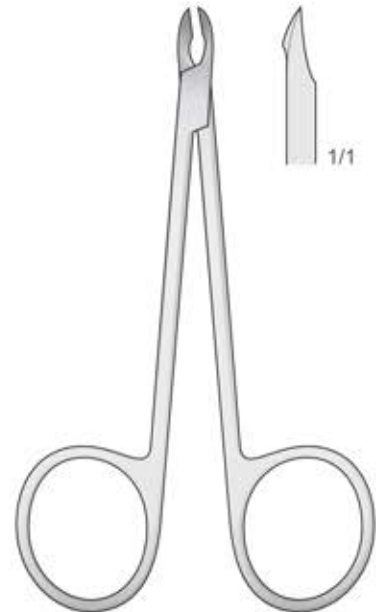

GS-52
 100 mm

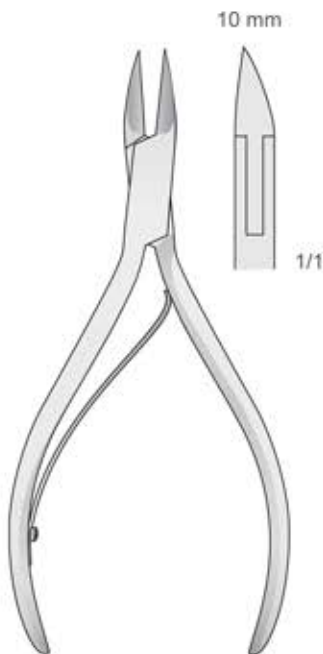

GS-42
 100 mm

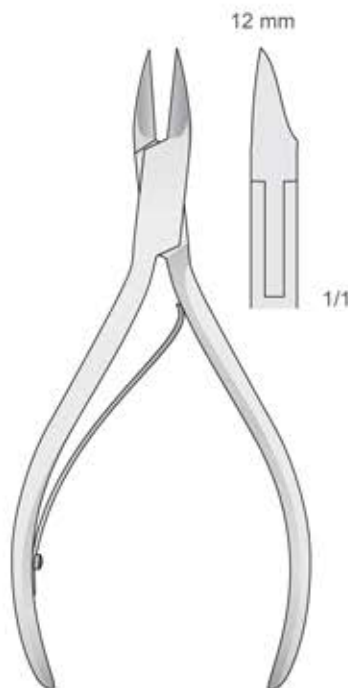

GS-44
 110 mm

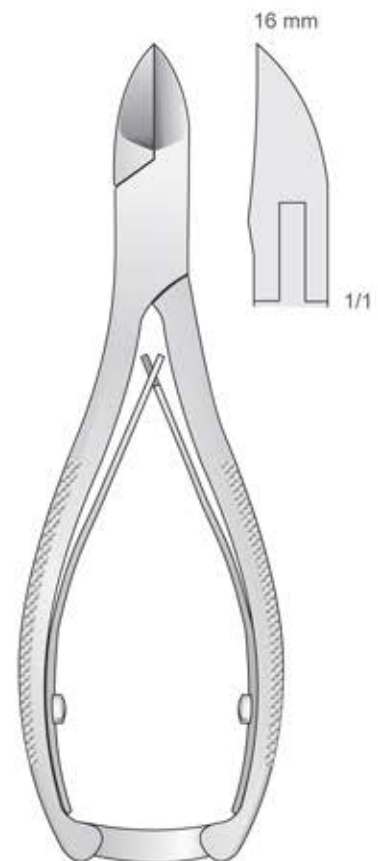

GS-48
 140 mm



Sterilisierzangen
Sterilizing Forceps
Pinze per sterilizzazione
Pinzas para esterilización
Pincas pour stérilisation



GS-02
145 mm



DAVIS
GS-03
160 mm



DAVIS
GS-04
200 mm

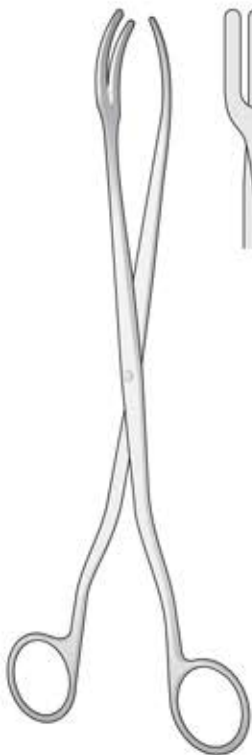

GS-10
200 mm

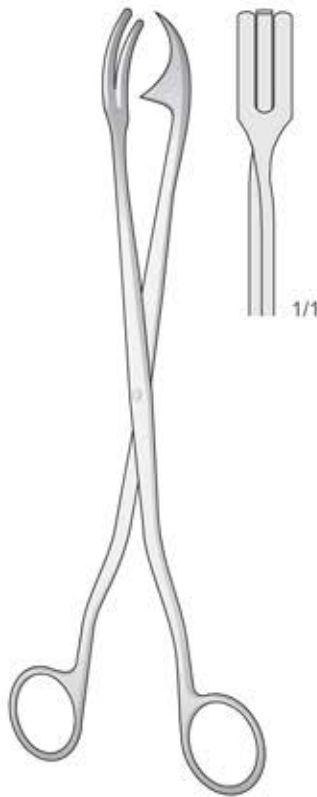

ROGGE
GS-06
230 mm

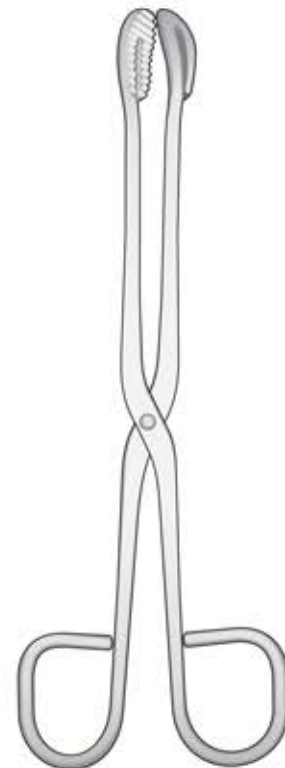

GS-13
200 mm

A-Z

Alphabetical Index
Alphabetischen Index
Index alphabétique
Índice alfabético
Índice alfabético





A

ADERER, Wire bending Pliers	324
ADSON, Suction tubes	319
- Delicate forceps	114
- Tissue forceps	122, 131, 132, 133, 136
- Titanium Tissue Forceps	118
ADSON-BROWN, Delicate forceps	114
- Tissue forceps	131
AINSWORTH, Rubber-Dam instrumente	308
ALLIS, Tissue Grasping forceps	174
ANDREWS-PYNCHON, Suction tubes	315
APEXO, Root elevators	50
ARKANSAS, Sharpening Stones	356
ARRUGA, Needle Holders	158
AUSTIN, Retractors	184

B

BABY-ALLIS, Tissue Grasping forceps	174
BABY-CRILE, Hemostatic Forceps	173
BABY-CRILEWOOD, Needle Holders	156
BABY-METZENBAUM, Scissors	98
BABY-MIXTER, Hemostatic Forceps	171
BABY-YANKAUER, Suction tubes	315
BACKHAUS, Towl Clamps	165
BALL, Filling Instruments	292
BARRAQUER, Tissue forceps	130
- Needle Holders	142
BARRY, Root elevators	65
BARTH, Curettes	235
BEALE, Instruments for laboratory	345
BEASLEY-BABCOCK, Tissue forceps	133
BEEBE, Scissors	326
- Wire and Plate cutting Scissors	109
BEIN, Root elevators	43
BENNETT, Raspatories	226
BERNARD, Root elevators	61
BEYER, Bone rongeurs	244
BISHOP, Cheek Retractor	191
BISHOP-HARMON, Delicate forceps	114
BLACK, Cavity preparation Instruments	283, 298
BLUMENTHAL, Bone rongeurs	242
BÖHLER, Bone rongeurs	245
BÖHM, Pliers for telescope crowns	335
BOLEY, Measuring Instruments	330
BOWLED-HENRY, Retractors	184
BOYNTON, Needle Holders	158
BOYS-ALLIS, Tissue Grasping Forceps	174
BREWER, Clamps forceps	309
BROWN, Delicate forceps	114
- Tissue forceps	131
BRUENINGS, Tongue depressors	195
BRUNS, Curettes	236
BUCHWALD, Tongue depressors	195
BUCK, Gingivectomy knives	301
- Bone files	239

C

CARVER, Amalgam carvers	297
CASTROVIEJO, Delicate forceps	114
- Needle Holders	141, 143, 144, 145, 146
- Measuring Instruments	218
CAWOOD-MINNESOTA, Cheek Retractors	191
CHADWICK, Scissors	97
CHOEN, Tissue Nippers	240
CHOMPRET, Syndesmotomes	70
CITELLI, Bone cutting forceps	246
CLEVELAND, Bone rongeurs	245
COHEN, Extracting forceps	31
COLLEGE, Titanium tissue forceps	118
- Cotton and Dressing pliers	120, 121
COLLIN, Tongue holding forceps	195
COLUMBIA, Curettes	262, 266
- Retractors	191
CONVERSE, Needle Holders	153
CORN, Forceps	138
COTTLE, Scissors	86
- Surgical Mallets	203
- Chisels	202

COTTLE-KNAPP, Scissors	86
COUPLAND, Suction tubes	317
- Root elevators	54
CRANE-CAPLAN, Curettes	306
- Tissue forceps	123
CRANE-KAPLAN, Gingivectomy knives	301
CRANEPICK, Root elevators	58
CRILE, Hemostatic Forceps	172
- Needle Holders	159
CRILE-MURRAY, Needle Holders	149
CRILE-WOOD, Needle Holders	149, 155, 156
CRYER, Root elevators	53
- Extracting Forceps	24, 28, 33, 34
CUSHING, Retractors	180

D

DANDY-MOSQUITO, Hemostatic forceps	168
DAVIS, Forceps for sterile instruments	358
DE BAKEY, Tissue forceps	122, 137
- Titanium Tissue forceps	118
- Needle holders	154
DE MARCO, Curettes	303
DEAN, Scissors	94
DERF, Needle Holders	149, 153
DESMARRES, Retractors	179
- Tissue Forceps	130
DIETRICH, Needle Holders	148
DINGMANN, Mouth gags	193
- Bone Holding Forceps	220
DOCKHORN, Retractors	180

E

ELLIS, Knives	79
EPKER, Osteotomes	202

F

FAHNENSTOCK, Wax knives	339
FAHRENKRUG, Root elevators	59
FARABEUF, Retractors	190
FAURE, Towel Clamps	165
FEDI, Periodontal chisels	285
FELSCH, Extracting forceps	16
FELT, Composite Instruments	271, 273
FOITZIK, Bone Syringes	216
FOSTER-GILLIES, Needle Holders	157
FRAZIER, Suction tubes	318, 319
FREER, Osteotomes	199
- Periosteals	204
FREER-YASARGIL, Periosteals	204
FRENZEL, Tongue depressors	195
FRIEDMANN, Bone rongeurs	242, 244
FURRER, Copper ring removing Pliers	335

G

GARDNER, Bone rongeurs	245
GERALD, Tissue forceps	129, 136
- Titanium Tissue Forceps	118
GERALD-BROWN, Tissue Forceps	129
GIESSEN, Periosteals	204
GILLIES, Retractors	177
- Tissue Forceps	123
GOLDMAN-FOX, Gingivectomy knives	301
- Curettes	304
- Elevators	229
- Scissors	91, 94, 105, 106
- Periodontal Probes	253
GOLDMAN-FOX-WILLIAMS, Periodontal Probes	289
GOLDSTEIN, Composite Instruments	271, 273
GRACEY, Curettes	261, 263, 264, 302, 303
GRAEFE, Knives	79
- Tissue Forceps	123, 133
GREENBERG-PAR, Scissors	101
GREENE, Retractors	194
GREGORY, Scissors	106
GRITMAN, Spatulas	340
- Instruments for Laboratory	345
GROSS, Dressing Forceps	167

**H**

HAJEK, Surgical Mallets	203
HALSEY, Needle Holders	149, 153
HALSTED, Hemostatic Forceps	170, 173
HALSTED-MOSQUITO, Hemostatic Forceps	170
- Ligating Instruments	329
HARRIS, Extracting Forceps	27, 30
HARTMANN, Retractors	186
HARTMANN-BABY-MOSQUITO, Hemostatic Forceps	168
HEGAR, Needle Holders	155, 159
HEIDBRINK, Root elevators	47
HEIDEMANN, Spatulas	291
HEISTER, Mouth Gags	188
HEMINGWAY, Curettes	232, 233
HENAHAN, Raspatories	225
HIRSCHFELD, Periodontal Files	267
HOLLENBACK, Filling Instruments	294, 297
HOPKINS, Raspatories	228
HOWARD, Bone Files	238
HULL, Extracting Forceps	28
HYLIN, Root elevators	56
- Instruments for laboratory	345, 346

I

ILIC, Tissue Nippers	240
INDIA, Sharpening Stones	356
IRIS, Scissors	86, 88, 101, 103, 104
IVORY, Rubber-Dam Instruments	308, 310, 311, 312
IWANSON, Measuring Instruments	330

J

JACOBSON, Curettes	235
- Needle Holders	145
JACOBSON-MICRO, Hemostatic Forceps	168
JAMESON, Scissors	87
JAMESON-WERBER, Scissors	87
JANSEN, Curettes	235
JAQUETTE, Curettes	265, 305
JONES, Towl Clamps	165
JOSEPH, Retractors	177
- Scissors	89, 106
JUDD-ALLIS, Tissue Grasping Forceps	174

K

KELLY, Scissors	92, 102, 103
- Hemostatic Forceps	172
KERLING, Copper ring removing Pliers	335
KERPEL, Curettes	234
KERRISON, Bone rongeurs	246
KEYES, Tissue Punches	213
KILIAN, Raspatories	227
KILNER, Scissors	87, 91, 93, 101
KIRKLAND, Gingivectomy knives	287, 301
KIRSCH, Retractors	182
KLEINER-KUTZ, Bone rongeurs	244
KOCHER, Retractors	179, 180
- Hemostatic Forceps	171, 172
KOCHER-LANGENBECK, Retractors	184
KÖNIG, Raspatories	224
KOPP, Root elevators	57
KRALLENHEBER, Root elevators	53
KRAMER, Curettes	264
KRAMER-NEVINS, Curettes	264
- Gouges	200
KROENIG, Tongue Holding Forceps	195

L

LA FORCE, Knives	79
LA GRANGE, Scissors	94, 105
LADMORE, Filling Instruments	295
LAHEY, Retractors	180
LANGE, Scalars	268
LANGENBECK, Retractors	184
LANGER, Curettes	266
LE CLUSE, Root elevators	65
LE CRON, Instruments for Laboratory	345

LEMPERT, Bone rongeurs	243
LERICHE, Hemostatic Forceps	173
LESSMANN, Wax knives	339
LEXER, Scissors	95
LEXER-BABY (KNAPP), Scissors	101
LICHTENBERG, Needle Holders	158
LINDO-LEVIEN, Root elevators	57
LISTER, Sinus Forceps	167
LITTAUER, Scissors	108
LOCKING, Cotton and Dressind Pliers	121
LOCKLIN, Scissors	90, 92
LORNA, Towl Clamps	166
LUCAE, Surgical Mallets	203
LUCAS, Curettes	232
LUER, Bone rongeurs	243
LUKS, Endodontic Instruments	254
LUNIATSCHEK, Cotton Applicators	256
- Membrane Placement Instruments	214

M

MARKLEY PLUGGERS, Filling Instruments	294
MARTINI, Curettes	235
MATHIEU, Needle Holders	158, 160, 161
MATY, Mouth Gags	189
MAYO, Scissors	96, 104
MAYO-HEGAR, Needle Holders	154, 159
MAYO-LEXER, Scissors	95
MAYO-STILLE, Scissors	95
McCALL, Curettes	266, 305
McINDOE, Tissue Forceps	123
McKESSON, Suction Tubes	316
MEAD, Surgical Mallets	203
- Raspatories	228
- Extracting Forceps	35
- Bone rongeurs	242
MENEGHINI, Raspatories	227
MERIAM, Cotton and Dressing Pliers	120, 121
MERRIT, Periodontal Probes	253
MERSHON, Band Pusher	328
METZENBAUM, Scissors	89, 97, 98, 99, 103, 104
METZENBAUM-FINO, Scissors	98, 99, 100
MICRO-ADSON, Tissue Forceps	133
MICRO-HALSTED, Hemostatic Forceps	169
MICRO-RYDER, Needle Holders	148
MICRO-VASCULAR, Needle Holders	154
MIDDELDORPF, Retractors	182
MILLER, Bone Files	238
- Forceps	138
- Ligating Instruments	329
MILLER-APEXO, Root elevators	55
MILLER-COLBURN, Raspatories	231
MINI-FRIEDMANN, Bone rongeurs	241, 242
MINI-GILLIES, Needle Holders	150, 157
MINI-LAMBOTTE, Osteotomes	199
MINI-LANGENBECK, Retractors	177
MINI-LEXER, Osteotomes	202
MINI-OLSEN-HEGAR, Needle Holders	150
MINNESOTA, Retractors	191
MISCH, Retractors	192
MITCHEL, Scalars	268
MOLT, Mouth Gags	188
- Curettes	237
- Raspatories	225, 226, 229, 231
MOLT-DOYEN-COLLIN, Mouth Gags	188
MOLT-DOYEN-JANSEN, Mouth Gags	188

N

NABERS, Periodontal Probes	290
NEUMANN, Scissors	94
NEVIUS, Extracting Forceps	25
NOYES, Micro Scissors	83
NYSTRÖM, Matrix Retainers	312

O

OBWEGESER, Retractors	183, 186, 187, 192
- Raspatories	223
OBWEGESER-FREER, Periosteal	204
OCHSENBEIN, Periodontal Chisels	285, 286



OLSEN-HEGAR , Needle Holders	150, 157	TOFFLEMIRE , Matrix Retainers	312
ORBAN , Gingivectomy Knives	287, 301	TOMES , Extracting Forceps	28
ORINGER , Mouth Gags	189	TÖNNIS , Needle Holders	159
P		TÖNNIS-ADSON , Scissors	98
P.K.THOMAS , Instruments for Laboratory	341, 342, 343	TOWNER , Gingivectomy Knives	301
PALMER , Rubber Dam Clamp Forceps	309	- Curettes	165
PAQUETTE , Palatal Gingival razor blade	78	TOWNER-JAQUETTE , Curettes	307
PARMLY , Extracting Forceps	26	U	
PARTSCH , Osteotomes	201	UFFENORDE , Curettes	234
- Chisel	201	UNIVERSAL , Crown Removers	338
PEAN , Hemostatic Forceps	171	- Cotton Applicators	256
PEAN-MURPHY , Dressing Forceps	167	UNIVERSITY OF MICHIGAN , Periodontal Probes	253, 290
- Ligating Instruments	329	V	
PECK-JOSEPH , Scissors	106	VEHE , Instruments for Laboratory	345
PEET , Nerve Instruments	39	VOLKMANN , Curettes	235, 236
- Hemostatic Forceps	169	W	
PELTON-CRANE , Suction Tubes	318	WAHL , Bone Files	239
PERRY , Tissue Forceps	124	WALTON , Scissors	85
PHYSICK , Extracting Forceps	31	WANGENSTEEN , Tissue Forceps	136
POTT , Root elevators	60	WARD , Filling Instruments	278
POTTS-SMITH , Tissue Forceps	135	WARWICK-JAMES , Root elevators	48
PRICHARD , Raspatories	226	WASSMUND , Retractors	194
Q		WEBSTER , Needle Holders	153
QUINBY , Scissors	97	WEDELSTAEDT , Cavity preparation Instruments	298
R		WEINGART , Wire bending Pliers	324
RAGNELL , Retractors	180	WEITLANER , Retractors	220
RAGNELL-DAVIS , Retractors	180	WERTHEIMER , Suction Tubes	319
REYNOLDS , Scissors	93	WESTCOTT , Micro Scissors	83
ROACH , Instruments for Laboratory	345	- Filling Instruments	280, 295
ROGER , Raspatories	227	WHITE , Filling Instruments	281
ROGGE , Forceps for sterile instruments	358	WHITEHEAD-JENNINGS , Mouth Gags	193
ROSER-KÖNIG , Mouth Gags	188	WIEDER , Retractors	186
ROSIN , Root elevators	48	WILAND , Amalgam Carvers	297
ROUTURIER , Extracting Forceps	11	WILLIAMS , Periodontal Probes	253
ROUX , Retractors	190	WILLIGER , Curettes	234, 235
ROUX-MAGNUS , Retractors	190	- Raspatories	223
RULE , Curettes	307	WINTER , Root elevators	63, 64
RUSKIN , Bone rongeurs	244	WITZEL , Extracting Forceps	38
RUSSIAN , Forceps	138	WOODSON , Filling Instruments	295
RYDER , Needle Holders	151	Y	
S		YANKAUER , Suction Tubes	315
SANDERS , Gingivectomy Knives	301	YOUNG , Tongue Holding Forceps	195
SAROT , Needle Holders	155	YOUNGER-GOOD , Curettes	306
SAUTTER , Periosteal	204	Z	
SCHAEDEL , Towel Clamps	165	ZAHLE , Instruments for Laboratory	346
SCHUDE , Curettes	236	ZAUFAL-JANSEN , Bone rongeurs	244
SCHLUGER , Bone Files	239	ZIEGLER , Knives	79
SEAN-MILLER , Retractors	179	ZIELINSKY , Measuring Instruments	330
SELDIN , Root elevators	58, 59		
- Raspatories	224		
SEMKEN , Tissue Forceps	127, 137		
SENN-GREEN , Retractors	180		
SHURE , Separating Pliers	327		
SMAHA , Needle Holders	161		
SMITH , Scissors	107		
- Wire cutting Pliers	325		
SPENCER , Scissors	108		
STELLBRINK , Bone rongeurs	241		
STERNBERG , Retractors	191		
STEVENS , Scissors	85, 93, 97		
- Needle Holders	148		
STIEGLITZ , Extracting Forceps	39		
STILLE , Tissue Forceps	126		
STITCH , Scissors	85		
STOKE , Rubber Dam Clamp forceps	309		
SUGARMAN , Bone Files	239		
SWEDISH , Needle Holders	152		
T			
TAYLOR , Curettes	265, 306		
TG CHISELS , Periodontal Chisels	286		
TOBOLD , Retractors	186		

A1-Z1

Alphanumeric Index
Alphanumerischen Index
Index alphanumérique
Índice alfanumérico
Índice alfanumerico

A1-Z1





1	3	712-111	293	717-39	300	718-M8	227	AT-1	268
2	3	712-111L	293	717-64	300	718-M9	226	AT-2L	268
4	8	712-112	293	717-66	300	718-PR3	226	AT-2R	268
7	3	712-112L	293	717-100	300	718-RO-4	307	AT-6	268
8	8	712-113	293	717-101	300	718-TO3	306	AT-12	268
13	6	712-113L	293	717-102	300	718-YGO8	306	B-3	281
17	3	712-121	293	717-103	300	719-111	307	B-4	281
18	3	712-121L	293	717-104	300	719-125	307	B-28/29	281
21	8	712-122	293	717-111	300	719-126	307	B-31/32	281
22 1/2L	11	712-122L	293	717-112	300	720-85	232	B-32	281
22 1/2R	11	712-123	293	718-1/2	302	720-86	232	B-33	281
22	6	712-123L	293	718-2R	303	720-87	232	B-34	281
29	4	712-124	293	718-3/4	302	720-88	232	B-35	281
30	4	712-124L	293	718-4R	303	720-101	232	BB-46	75
33	6	712-131	295	718-5/6	302	720-102	232	BB-48	75
33A	6	712-132	295	718-7/8	302	720-103	232	BD-01	121
46L	12	712-133	295	718-9/10	302	720-104	232	BD-02	121
48	12	712-161H	294	718-11MD	303	720-111	239	BD-03	121
49	12	712-162H	294	718-11/12	302	720-112	239	BD-04	124
51	5	712-163H	294	718-13MD	303	725-1/2	47	BD-05	124
51A	5	712-164H	294	718-13/14	302	725-3/4	47	BD-06	124
51L	5	712-171	295	718-14	303	725-3/4S	47	BD-07	124
55	10	712-172	295	718-24G	229	725-5/6	47	BD-08	345
56	10	712-182	295	718-103	286	751-2/3	341	BD-09	134
67A	5	712-183	295	718-104	286	751-121	341	BD-09T	118
68	10	712-191	296	718-107	286	751-122	341	BD-10	125
68A	10	712-192	296	718-113	286	751-123	341	BD-11	121
73	6	712-201	296	718-123	301	751-124	341	BD-14	135
74	7	712-202	296	718-133	301	751-125	341	BD-16	125
74N	7	712-221	296	718-147	301	A-1	275	BD-18	134
75	7	712-222	296	718-148	301	AL-MA5	257	BD-19	128
79	8	712-223	296	718-149	301	AL-PT1	343	BD-20	134
79A	8	712-231	296	718-151	301	AL-PT2	343	BD-21	128
86A	7	712-232	296	718-154	301	AL-PT3	343	BD-23	134
87	9	712-233	296	718-156	301	AL-PT4	343	BD-25	134
89	9	712-241	229, 295	718-162	301	AL-PT5	343	BD-26	134
90	9	712-242	295	718-165	301	AL-SETC/1	344	BD-27	138
400	38	712-243	295	718-170	301	AL-SETC/2	344	BD-30	132
401	38	712-251	296	718-191	228	AM-1	24	BD-30T	118
707-1N	290	712-256	296	718-192	228	AM-5	31	BD-31	132
707-2N	290	712-259	296	718-204	306	AM-15	30	BD-31T	118
707-3GF	289	712-PFI	294	718-204S	306	AM-16	30	BD-32	124
707-3UM	290	713-101	299	718-204SD	306	AM-17	29	BD-33	124
707-3W	289	713-102	299	718-210	239	AM-18L	27	BD-35	124
707-6D1	288	714-101	294	718-212	239	AM-18R	27	BD-36	124
707-6D2	288	714-102	294	718-212S	239	AM-23	29	BD-38	128
707-6D3	288	714-CV11	299	718-214S	239	AM-24	27	BD-39	128
707-16D1	288	715-101	297	718-215	204	AM-32	26	BD-40	127
707-16D2	288	715-102	297	718-216	204	AM-32A	26	BD-41	127
707-16GF	289	715-103	297	718-223	228	AM-53L	25	BD-42	127
707-16UM	290	715-103S	297	718-232	303	AM-53R	25	BD-43	127
707-16W	289	715-311	291	718-234	303	AM-62	24	BD-44	127
707-17GF	289	715-312	291	718-251	303	AM-65	26	BD-45	127
707-17UM	290	715-404	297	718-252	303	AM-69	28	BD-46	127
707-17W	289	715-408	297	718-268	307	AM-88L	25	BD-47	127
707-23D1	288	716-101	299	718-271	304	AM-88R	25	BD-51	133
707-23D2	288	716-102	299	718-272	304	AM-101	28	BD-53	135
707-23GF	289	716-103	299	718-273	304	AM-103	30	BD-56	130
707-23UM	290	716-104	299	718-274	304	AM-150	24	BD-57	130
707-23W	289	716-201	298	718-275	304	AM-150A	24	BD-58	130
707-202	288	716-202	298	718-277	304	AM-150AS	33	BD-59	130
707-202A	288	716-203	298	718-282	305	AM-150S	33	BD-60	126
707-203	288	716-204	298	718-282A	305	AM-150X	32	BD-61	126
707-2311	290	716-211	298	718-284	305	AM-151	28	BD-62	126
707-2312	290	716-212	298	718-284S	305	AM-151AS	33	BD-63	126
707-GFW	289	716-232	298	718-288S	305	AM-151S	33	BD-65	126
707-UT1	288	716-234	298	718-332	305	AM-151X	32	BD-67	126
711-301	291	716-236	298	718-333	305	AM-203	29	BD-70	132
711-302	291	717-6	300	718-335	305	AM-210	27	BD-71	122, 132
711-303	291	717-14	300	718-CIO3	306	AM-222	31	BD-72	132
712-18	292	717-17	300	718-CK3	301	AM-250	31	BD-73	122, 132
712-27S	292	717-17W	300	718-CK6	306	AMG-150	34	BD-75	125
712-29	292	717-18	300	718-EN1	229	AMG-150S	34	BD-75T	118
712-101	292	717-18W	300	718-EN2	229	AMG-151	34	BD-76	125
712-102	292	717-19	300	718-EN3	229	AMG-151S	34	BD-80	122
712-103	292	717-19W	300	718-GF14	227	APICAL-1	52	BD-80T	118
712-104	292	717-31L	300	718-M23	267	APICAL-2	52	BD-81	122
712-105	292	717-32L	300	718-M23A	267	APICAL-3	52	BD-82	122
712-106	292	717-33L	300	718-M23B	267	APICAL-4	52	BD-83	122

BD-90	131	BD-282	128	BS-41	350	BT-157	183	CP	339
BD-91	127	BD-283	123	BS-42	350	BT-158	192	CPL	339
BD-92	131	BD-284	123	BS-43	350	BT-159	192	CPS	339
BD-93	131	BD-285T	118	BS-59	351	BT-183	225	CS-01	349
BD-94	131	BD-287	135	BS-60	206, 207, 351	BT-184	225	CS-02	349
BD-95	127	BD-288	135	BS-61	351	BT-185	225	CS-03	349
BD-96	124	BD-289	135	BS-100	354	BT-186	177	CS-04	349
BD-97	125	BD-290	135	BT-1	179	BT-187	177	CS-05	349
BD-98	125	BD-291	135	BT-2	179	BT-188	177	CS-12	349
BD-99	125	BD-292	135	BT-05	225	BT-189	177	CS-15	349
BD-104	128	BD-348	114	BT-06	225	BT-210	177	CS-19	349
BD-109	128	BD-349	114	BT-07	225	BT-211	177	CT-555	351
BD-110	128	BD-351	135	BT-07M	225	BT-212	177	CT-555N	355
BD-111	128	BD-352	135	BT-15	177	BT-213	177	CT-556N	355
BD-130	130	BD-353	135	BT-16	177	BT-214	177	CT-557N	355
BD-131	130	BD-354	135	BT-18	179	BT-260	184	CT-558N	355
BD-133	128	BD-355	135	BT-19	179	BT-264	181	CT-559N	355
BD-134	128	BD-356	135	BT-20	190	BT-265	181	CT-560	351
BD-135	133	BD-360	113	BT-25	190	BT-283	190	CT-560N	355
BD-137	128	BD-361	113	BT-26	180	BT-284	190	CT-561N	355
BD-141	131	BD-362	113	BT-27	180	BT-285	190	CT-562N	355
BD-142	126	BD-363	113	BT-29	180	BT-286	190	CT-563N	355
BD-143	126	BD-364	113	BT-33	184	BT-287	190	CT-564N	355
BD-144	128	BD-365	113	BT-34	184	BT-288	190	CT-565	351
BD-145	125	BD-366	113	BT-35	184	BT-289	190	CT-565N	355
BD-148	125	BD-367	113	BT-36	184	BV-23	220	CT-566N	355
BD-158	138	BD-370	132	BT-38	178	C-1	233	CT-567N	355
BD-159	138	BD-371	132	BT-39	178	C-2	233	CT-568N	355
BD-160	122	BD-372	133	BT-40	178	C-3	233	CT-569N	355
BD-160T	118	BD-373	133	BT-41	178	C-4	233	CT-650	354
BD-161	122	BD-377	133	BT-42	178	C-11	337	CT-651	351
BD-165	122	BD-378	133	BT-43	184	C-12	337	CT-652	351
BD-175	138	BD-379	133	BT-44	178	C-13	337	CT-653	351
BD-177	122	BD-380	131	BT-45	178	C-30	337	CU-1/2	261
BD-178	122	BD-381	131	BT-46	178	C-34	337	CU-3/4	261
BD-194	124	BD-382	131	BT-48	180	C-35	337	CU-5/6	261
BD-195	124	BEIN-1T	51	BT-49	180	C-36	337	CU-7/8	261
BD-196	124	BEIN-1Z	57	BT-50	178	C-41	337	CU-9/10	261
BD-207	114	BEIN-2	51	BT-51	178	C-42	337	CU-11/12	261
BD-208	114	BEIN-2Z	57	BT-52	178	C-43	337	CU-13/14	261
BD-209	114	BEIN-3	51	BT-54	178	C-71	336	CU-MC1	231
BD-210	137	BEIN-4	51	BT-55	178	C-72	336	CV-11	276
BD-211	137	BEIN-4Z	57	BT-56	178	C-73	336	DA-01	40
BD-212	137	BF-10	167	BT-60	184	C-74	336	DA-01M	40
BD-213	137	BF-12	167	BT-62	184	CD-1	276	DA-02	40
BD-216	137	BF-20	167	BT-64	184	CD-2	276	DA-03	40
BD-217	137	BF-22	167, 329	BT-66	184	CD-3	276	DA-04	120
BD-221	137	BF-23	167	BT-67	187	CD-4	276	DA-05	120
BD-222	137	BF-24	167	BT-68	187	CG	339	DA-06	138
BD-223	137	BF-25	167	BT-69	194	CGL	339	DA-07	138
BD-224	137	BF-38	165	BT-70	179	CGS	339	DA-08	138
BD-230	136	BF-40	165	BT-72	179	CH-1	70	DA-09	121
BD-231	136	BF-41	165	BT-74	179	CH-2	70	DA-10	40
BD-232	136	BF-42	165	BT-77	179	CH-3	70	DB-01	123
BD-240	126	BF-43	165	BT-80	182	CH-4	70	DB-02	123
BD-241	126	BF-44	165	BT-81	182	CH-11	70	DB-07	356
BD-242	126	BF-45	165	BT-82	182	CH-12	70	DB-08	356
BD-243	126	BF-46	165	BT-90	182	CH-13	70	DB-08	356
BD-244	126	BF-48	165	BT-91	182	CH-14	70	DB-1L	356
BD-245	126	BF-50	166	BT-92	183	CL-1B	344	DB-3	356
BD-246	126	BF-52	166	BT-93	183	CL-1R	344	DB-4	356
BD-247	126	BF-75	166	BT-94	183	CL-2B	344	DB-6A	356
BD-248	126	BF-94	167	BT-95	183	CL-2R	344	DB-10	356
BD-249	126	BF-95	167	BT-96	183	CL-3B	344	DB-11	356
BD-250	136	BK-30	346	BT-100	183	CL-3R	344	DB-12	356
BD-251	136	BM-01	157	BT-109	180	CM	340	DB-15	356
BD-253	114	BM-02	157	BT-117	179	CO-1	54	DB-50M	356
BD-267	137	BM-03	157	BT-118	179	CO-2	54	DB-96	356
BD-270	125	BM-04	157	BT-131	194	CO-3	54	DB-177	246
BD-270T	118	BM-61	150	BT-132	194	CO-11	54	DB-178	246
BD-271	134	BM-62	150	BT-134	181	CO-12	54	DB-179	246
BD-272	134	BM-63	150	BT-135	181	CO-13	54	DB-180	246
BD-273	134	BR-20	349	BT-139	180	COL-1/2	261	DB-181	246
BD-274	134	BR-25	349	BT-140	180	COL-2RL	261	DB-182	246
BD-275	134	BR-28	349	BT-152	183	COL-3/4	261	DB-183	246
BD-276	134	BS-1	349	BT-153	183	COL-4RL	261	DB-299	356
BD-279	123	BS-27	349	BT-154	183	COL-13/14	261	DB-300	219
BD-280	123	BS-32	349	BT-155	183	COLLEGE	120, 329	DB-OL	356
BD-281	128	BS-40	350	BT-156	183	COLLEGE-S	120	DEAN	94



DEAN-TC	102	DL-28	53	DL-118	43	DP-725	330	FD-563T	147
DF-00	308	DL-30	57	DL-123	61	DP-730	330	FD-574T	147
DF-00L	308	DL-31	57	DL-124	61	DR-40	39, 169	FD-575T	147
DF-00M	308	DL-32	53	DL-C	338	DR-50	39	FD-587T	147
DF-00N	308	DL-33	53	DL-V	338	DR-60	39	FD-588T	147
DF-00P	308	DL-34	50	DO-1	238	DR-70	39	FD-599	146
DF-00R	308	DL-35	50	DO-2	238	DR-78	138, 329	FD-600	146
DF-00V	308	DL-36	50	DO-3	238	DR-80	138	FD-601	146
DF-01/5	312	DL-37	50	DO-4	238	E-0	284	FD-602	146
DF-01/6	312	DL-38	50	DO-4C	238	E-1	284	FE-1	273
DF-01/7	312	DL-42	43	DO-5	238	E-2	284	FE-2	273
DF-02	308	DL-43	43	DO-08	186	E-3	284	FE-3	273
DF-02M	308	DL-44	43	DO-09	186	E-4	284	FE-4	273
DF-02P	308	DL-45	43	DO-40	186	EC-1	284	FE-4/5	273
DF-02R	308	DL-46	43	DO-41	192	EC-2	284	FE-5	273
DF-03/1	312	DL-47	43	DO-59	223	EN-M1	228	FE-6	273
DF-03/2	312	DL-48	59	DO-63	223	EN-M2	228	FG-1	86
DF-03/3	312	DL-49	59	DO-65	223	EN-M3	228	FG-1SC	104
DF-03/7	312	DL-50	234	DO-67	223	EN-M4	228	FG-1SCZ	104
DF-03/8	312	DL-51	234	DO-140	202	EN-M5	228	FG-1TC	101
DF-03/9	312	DL-52	234	DO-141	202	EN-M6	228	FG-2	86
DF-03/10	312	DL-54	59	DO-142	192	EN-M7	228	FG-2SC	104
DF-03/11	312	DL-55	59	DO-143	202	ES-13	204	FG-2SCZ	104
DF-03/12	312	DL-58	48	DO-175	184	ES-27	229	FG-2TC	101
DF-03/13	312	DL-59	62	DO-180	202	ES-44	130	FG-3	87
DF-04	312	DL-60	338	DO-181	202	ES-65	130	FG-4	86
DF-05/5	312	DL-61	62	DO-182	202	EX-11	252	FG-5	86
DF-05/6	312	DL-62	62	DO-183	202	EX-12	252	FG-11L	86
DF-05/7	312	DL-63	62	DO-184	202	F-2/3	276	FG-12L	86
DF-06	312	DL-64	64	DO-185	202	FD-06	84	FG-13	88
DF-07	312	DL-65	64	DO-186	202	FD-08	84	FG-14	89
DF-08	312	DL-66	64	DO-196	200	FD-10	83	FG-15	88
DF-09	312	DL-67	64	DO-204	184	FD-12	83	FG-19C	93
DF-10	309	DL-68	62	DO-204L	184	FD-13	83	FG-19R	93
DF-12	310	DL-69	62	DO-212	184	FD-14	141	FG-20	94
DF-15	309	DL-73	61	DP-24	335	FD-15	83	FG-21	90
DF-16	309	DL-74	61	DP-24C	335	FD-16	141	FG-22	90
DF-18	309	DL-75	61	DP-24R	335	FD-17	141	FG-23	88
DF-20	327	DL-76	49	DP-28	335	FD-18	144	FG-24	88
DF-21	327	DL-77	49	DP-29	335	FD-19	141	FG-28	89
DF-30	311	DL-78	49	DP-38	335	FD-20	144	FG-36	90
DF-32	311	DL-79	49	DP-38A	335	FD-21	146	FG-37	90
DF-40	310	DL-81	44	DP-38R	335	FD-22	144	FG-38	95
DF-40/1	310	DL-82	44	DP-50	328	FD-22A	144	FG-39	95
DF-40/2	310	DL-83	44	DP-52	329	FD-23	146	FG-50	93
DF-40/3	310	DL-84	44	DP-54	328	FD-24	142	FG-51	93
DF-41	310	DL-85	44	DP-90	109, 326	FD-25	145	FG-52	93
DF-41/4	310	DL-86	44	DP-91	109, 326	FD-26	141	FG-53	93
DF-41/5	310	DL-87	44	DP-92	109, 326	FD-28	144	FG-54	93
DF-41/6	310	DL-88	62	DP-100	328	FD-29	145	FG-55	93
DF-43	310	DL-89	62	DP-101	109, 326	FD-30	145	FG-58	87
DF-50	327	DL-90	65	DP-102	109, 326	FD-31	143	FG-59	86
DF-126	311	DL-91	45	DP-103	109, 326	FD-32	145	FG-60	98
DF-127	311	DL-92	45	DP-104	109	FD-33	148	FG-61	98
DF-128	311	DL-93	45	DP-105	109	FD-34	143	FG-66	93
DF-129	311	DL-94	45	DP-114	324	FD-35	148	FG-67	93
DF-130	311	DL-95	45	DP-116	324	FD-36	143	FG-92	106
DF-131	311	DL-96	45	DP-118	323	FD-37	143	FG-98	106
DF-151	311	DL-97	45	DP-119	323	FD-38	148	FG-101	90
DF-160	311	DL-98	60	DP-120	107, 326	FD-41	83	FG-102	90
DK-26	38	DL-99	60	DP-121	323	FD-42	83	FG-103	88
DK-27	38	DL-100	63	DP-124	328	FD-64	83	FG-104	88
DL-0	338	DL-101	63	DP-125	328	FD-65	83	FG-105	88
DL-1	53	DL-102	46	DP-126	329	FD-137	83	FG-112	86
DL-2	53	DL-103	46	DP-127	329	FD-138	83	FG-113	86
DL-05	59	DL-104	46	DP-128	329	FD-145	84	FG-121	91
DL-06	59	DL-105	46	DP-129	329	FD-170	145	FG-123	87
DL-11	56	DL-106	43	DP-132	329	FD-171	145	FG-124	87
DL-13	56	DL-107	43	DP-133	329	FD-172	143	FG-147	89
DL-14	56	DL-108	65	DP-134	324	FD-173	143	FG-148	89
DL-17	56	DL-109	65	DP-135	324	FD-182	84	FG-153	106
DL-18	56	DL-110	65	DP-136	338	FD-183	84	FG-154	106
DL-19	56	DL-111	65	DP-137	338	FD-216	142	FG-156	87
DL-20	48	DL-112	46	DP-140	331	FD-217	142	FG-157	87
DL-21	48	DL-113	46	DP-150	327	FD-224	84	FG-158	87
DL-22	48	DL-114	46	DP-720	330	FD-225	84	FG-159	87
DL-24	60	DL-115	46	DP-721	330	FD-226	142	FG-160	107, 325
DL-25	60	DL-116	43	DP-723	330	FD-237	142	FG-161	325
DL-27	53	DL-117	43	DP-724	330	FD-562T	147	FG-167	101

FG-168	101	FL-13	201	FL-231	202	FM-100L	103	G-18	258
FG-190	91	FL-14	201	FL-232	202	FM-102	103	G-20	258
FG-191	91	FL-15	201	FL-263	199	FM-104	103	G-22	258
FG-207	85	FL-16	199	FL-264	199	FM-109	89	G-24	258
FG-208	85	FL-17	199	FL-265	199	FM-118	101	G-26	258
FG-209	85	FL-18	199	FL-266	199	FM-119	101	G-28	258
FG-210	85	FL-20	216	FL-267	199	FM-126	89	G-30	258
FG-211	85	FL-21	216	FL-268	199	FM-127	89	GA-17	215
FG-212	85	FL-25	212	FL-269	199	FM-146	107	GA-18	215
FG-216	85	FL-26	212	FL-292	209	FM-180	95	GA-19	215
FK-1	92	FL-27	212	FL-293	209	FM-181	95	GA-20	215
FK-1SC	102	FL-28	212	FL-294	209	FM-201	100	GA-33	213
FK-1TC	102	FL-31	216	FL-295	209	FM-202	100	GA-34	213
FK-2	92	FL-32	199	FL-296	209	FM-203	100	GA-35	213
FK-2SC	102	FL-33	216	FL-297	209	FM-204	100	GA-36	213
FK-2TC	102	FL-35	216	FL-298	209	FM-298	97	GA-37	213
FK-60	236	FL-37	212	FL-299	209	FM-299	97	GA-60	213
FK-61	236	FL-38	212	FL-389	207	FM-300	97	GA-63	213
FK-62	236	FL-39	212	FL-390	207	FM-301	97	GA-64	213
FK-63	236	FL-53	199	FL-391	207	FM-317	101	GA-65	213
FK-64	236	FL-54	199	FL-392	207	FM-318	97	GA-66	213
FK-65	236	FL-58	199	FL-393	207	FM-319	97	GA-70	216
FK-66	236	FL-59	202	FL-394	207	FM-339	106	GA-71	217
FK-67	236	FL-60	202	FL-395	207	FM-350	101	GA-73	217
FK-70	235	FL-61	202	FL-396	207	FO-08	242	GA-78	217
FK-71	235	FL-65	211	FL-397	207	FO-09	242	GA-79	217
FK-72	235	FL-66	211	FL-398	207	FO-15	242	GA-80	217
FK-73	235	FL-67	211	FL-399	207	FO-16	244	GA-81	217
FK-75	235	FL-68	211	FL-411	202	FO-17	242	GA-85	217
FK-76	235	FL-69	211	FL-412	202	FO-18	243	GA-86	217
FK-77	235	FL-70	211	FL-413	202	FO-19	242	GA-90	217
FK-78	235	FL-71	211	FL-414	202	FO-20	244	GA-91	217
FK-83	234	FL-72	211	FL-415	202	FO-21	242	GB-2	78
FK-84	234	FL-73	211	FL-416	202	FO-22	241	GB-4	76
FK-87	92	FL-74	211	FLAGG	120	FO-23	241	GF-01	317
FK-88	92	FL-75	211	FLOHR-1	52	FO-24	241	GF-02	317
FK-100	205	FL-76	211	FLOHR-2	52	FO-25	243	GF-03	317
FK-101	205	FL-77	211	FLOHR-3	52	FO-26	245	GF-04	317
FK-102	205	FL-78	211	FM-1	98	FO-33	246	GF-05	317
FK-103	205	FL-79	211	FM-1F	98	FO-34	244	GF-06	315
FK-104	205	FL-80	211	FM-1SC	104	FO-43	243	GF-07	315
FK-105	205	FL-104	203	FM-2	98	FO-60	245	GF-10	315
FK-106	205	FL-114	200	FM-2F	98	FO-61	245	GF-11	317
FK-107	205	FL-115	200	FM-2SC	104	FO-77	245	GF-12	315
FK-108	205	FL-116	200	FM-3	99	FO-85	241	GF-13	316
FK-109	205	FL-120	208	FM-3F	99	FO-87	241	GF-14	316
FK-110	236	FL-121	208	FM-3SC	104	FO-88	241	GF-15	316
FK-111	236	FL-122	208	FM-4	99	FO-89	241	GF-16	316
FK-112	236	FL-123	208	FM-4F	99	FO-130	220	GF-20	316
FK-113	236	FL-124	208	FM-4SC	104	FO-131	220	GF-30	316
FK-114	236	FL-125	208	FM-5	96	FO-131S	220	GF-31	316
FK-115	236	FL-128	203	FM-5SC	104	FO-138	244	GF-32	316
FK-116	236	FL-132	200	FM-6	96	FO-139	244	GF-33	316
FK-120	236	FL-135	200	FM-6SC	104	FO-156	244	GF-34	316
FK-121	236	FL-136	200	FM-7	96	FO-157	244	GF-35	316
FK-122	236	FL-141	210	FM-8	96	FO-159	220	GF-40	320
FK-123	236	FL-142	210	FM-9	96	FO-162	246	GF-41	319
FK-124	236	FL-143	210	FM-10	96	FO-163	246	GF-42	319
FK-125	236	FL-144	210	FM-12	89	FO-165	246	GF-54	315
FK-126	236	FL-150	213	FM-27	96	FO-216	242	GF-60	319
FK-136	234	FL-151	213	FM-28	96	FO-220	241	GF-61	319
FK-137	234	FL-152	213	FM-41	96	FO-221	242	GF-69	319
FK-138	234	FL-153	213	FM-42	96	FO-229	243	GF-70	319
FK-139	234	FL-155	213	FM-47	98	FO-230	243	GF-133	214, 317
FK-188	234	FL-156	213	FM-48	98	FO-231	245	GF-134	214
FK-189	234	FL-157	213	FM-49	96	FO-232	245	GF-180	318
FK-197	234	FL-158	213	FM-51	107	FO-233	245	GF-182	320
FK-198	234	FL-159	213	FM-59	107	FO-234	245	GF-183	320
FL-01	203	FL-177	201	FM-63	96	FR-16	204	GF-184	318
FL-03	201	FL-179	201	FM-66	99	FR-17	204	GF-185	320
FL-04	201	FL-181	201	FM-67	99	FREER	204, 226	GF-188	320
FL-05	201	FL-183	201	FM-68	99	G-3	257	GF-200	320, 357
FL-09	203	FL-184	201	FM-69	99	G-4	257	GF-240	318
FL-09R	203	FL-185	201	FM-79	95	G-5	257	GF-241	318
FL-10M	203	FL-186	201	FM-96	100	G-8	258	GF-242	318
FL-11	203	FL-187	201	FM-97	100	G-10	258	GF-242B	318
FL-11R	203	FL-188	201	FM-98	100	G-12	258	GF-243	318
FL-12	203	FL-189	201	FM-99	100	G-14	258	GF-244	318
FL-12R	203	FL-230	202	FM-100	103	G-16	258	GF-271	317



GF-901	317	KO-11	227	LB-369	75	MF-144T	119	NK-38	80
GFC	91	KO-20	229	LC-1	345	MF-145T	119	NK-39	79
GFC-S	91	KO-22	224	LC-2	345	MF-146T	119	NK-40	80
GFC-SC	105	KO-23	224	LC-3	345	MF-147T	119	NK-105	204
GFC-TC	106	KO-58	226	LG-1	94	MF-177	114	NK-249	204
GFR	91	KO-66	227	LG-15C	105	MF-249	114	NK-251	204
GFR-S	91	L-0	72	LG-2SC	105	MF-370	116	O-1	277
GFR-SC	105	L-1	72	LG-6	94	MF-371	116	O-2	277
GFR-TC	106	L-2	72	LK-1	90	MF-372	116	O-3	277
GFS	94	L-3	72	LK-2	92	MF-373	116	O-4	277
GFS-SC	105	L-4	72	LK-3	90	MF-374	116	OA-1	279
GM-01	215	L-5	72	LK-4	92	MF-375	116	OA-2	279
GM-02	215	L-6	72	LK-10	102	MF-376	116	OA-3	279
GO-1	273	L-7	72	LK-12	102	MF-377	116	OBN-1	287
GO-2	273	L-8	72	LS-08	218	MF-378	117	OBN-2	287
GO-3	273	L-9	72	LS-09	218	MF-379	117	OBN-4	287
GO-4	273	L-11	72	LX-50	240	MF-380	117	OC-1	278
GS-02	358	L-21	72	LX-52	240	MF-381	117	OC-2	278
GS-03	358	L-22	72	LX-60	240	MF-382	117	OF-1	285
GS-04	358	L-23	72	LX-84	323	MF-383	117	OF-2	285
GS-06	358	L-24	72	LX-85	323	MF-384	117	OF-3	285
GS-10	358	L-25	72	LX-87	323	MF-385	117	OK-1	277
GS-13	358	L-26	72	LX-101	324	MI-10	55	OK-2	277
GS-16	78	L-27	72	LX-102	325	MI-11	55	OK-3	277
GS-18	78	L-28	72	LX-103	325	MI-12	55	OL-1	278
GS-26	109	L-29	72	LX-113	220	MI-13	55	OL-2	278
GS-40	357	L-51	71	MA-1	257	MIR-08	229	OL-3	278
GS-42	357	L-52	71	MA-1A	257	MIR-09	71	OM-2	280
GS-44	357	L-53	71	MA-2	257	MIR-10	236	OM-04	195
GS-48	357	L-54	71	MA-2A	257	MIR-20	54	OM-06	186
GS-52	357	L-55	71	MA-3	257	MIR-21	54	OM-07	195
H4422	345	L-56	71	MA-6	258	MIR-22	54	OM-08	186
H-1	275	L-57	71	MA-7	257	MIR-23	54	OM-10	195
H-2	275	L-58	71	MA-8	71	MIR-24	54	OM-16	195
H-3	275	L-59	71	MA-9	71	MIR-25	54	OM-18	195
HA	346	L-60	71	MA-9R	71	MIR-26	54	OM-19	195
HB	229, 345	L-71	71	MA-B1	77	MIR-30	206	OM-30	195
HC	345	L-72	71	MA-B2	77	MIR-31	206	OM-40	188
HE-1	47	L-73	71	MA-B3	77	MIR-32	206	OM-40R	188
HE-2	47	LA-1	66	MA-B3M	77	MIR-33	206	OM-41	188
HE-3	47	LA-2	66	MA-B4	78	MO-2	237	OM-41R	188
HF-3/7	267	LA-3	66	MA-B7	77	MO-4	237	OM-42	188
HF-5/11	267	LA-4	66	MA-B7K	77	MO-4L	237	OM-44	195
HF-9/10	267	LA-5	66	MA-B8	77	MO-4LT	237	OM-45	195
HL	346	LA-6	66	MA-B9	77	MO-4RT	237	OM-50	191
HP-6	58	LA-7	67	MA-B16	76	MO-8	229	OM-52	191
HR	345	LA-8	67	MC-11	71	MO-9A	226	OM-55	191
HV	345	LA-9	67	MC-12	71	MO-10	231, 237	OM-55B	191
I-13	19	LA-10	67	MC-13	71	MO-12	231	OM-60	188
I-22 1/2L	22	LA-11	68	MC-70	71	MO-15	225	OM-61	191
I-22 1/2R	22	LA-12	68	MD-1	35	MO-20	227	OM-62	188
I-22	19	LA-13	68	MD-2	35	MO-24	227	OM-66	191
I-36	18	LA-16	68	MD-3	35	MOLT-9	226	OM-66B	191
I-36N	18	LA-17	68	MD-4	35	MPI-1	214	OM-67	191
I-46L	21	LA-20	69	MEAD	223	MRT/C7	336	OM-70	196
I-46LX	21	LA-21	69	MERIAM	120	MRT-6	336	OM-71	196
I-46N	20	LA-22	69	MF-101	129	MRT-7	336	OM-72	196
I-59	19	LA-23	69	MF-101T	118	MRT-C1	337	OM-74	189
I-73	19	LB-10	77	MF-102	129	MRT-C3	337	OM-75	189
I-74	18	LB-11	77	MF-102T	118	MRT-C4	337	OM-76	189
I-74N	18	LB-12	77	MF-103	129	NK-1	76	OM-77	189
I-79	20	LB-12D	77	MF-104	129	NK-2	76	OM-80	185
I-79N	20	LB-13	77	MF-105	129	NK-3	76	OM-81	185
I-86C	19	LB-15	77	MF-106	136	NK-06	79	OM-82	185
I-87	20	LB-15A	77	MF-107	136	NK-07	79	OM-85	185
I-133L	23	LB-15C	77	MF-110	115	NK-08	79	OM-87	185
I-133R	23	LB-18	78	MF-111	115	NK-09	79	OM-88	185
I-333S	23	LB-20	78	MF-112	115	NK-10	79	OM-90	189
IM-15	214	LB-21	78	MF-113	115	NK-11	79	OM-97	189
KE-20	196	LB-23	78	MF-114	115	NK-12	75	OM-100	185
KE-40	196	LB-40	75	MF-115	115	NK-14	79	OM-110	193
KKD-1	287	LB-361	75	MF-124	119	NK-16	79	OM-112	193
KKD-2	287	LB-362	75	MF-125	119	NK-17	79	OM-113	193
KKD-4	287	LB-363	75	MF-126	119	NK-18	79	OM-114	193
KN-55	200	LB-364	75	MF-127	119	NK-20	79	OM-136	193
KN-75	200	LB-365	75	MF-128	119	NK-30	80	OM-137	193
KO-1	224	LB-366	75	MF-129	119	NK-32	80	OM-138	193
KO-2	224	LB-367	75	MF-142T	119	NK-34	80	OM-139	193
KO-3	224	LB-368	75	MF-143T	119	NK-36	80	ON-1	280

OP-1	279	P-100	174	PH-72	155	PO-105	157	SL-21	233
OP-2	279	P-101	169	PH-73	153	PR-3	226	SM-1	253
OP-3	279	P-102	169	PH-74	159	PR-3A	226	SM-2	253
OP-4	279	P-115	174	PH-75	155	PS-1	346	SM-3	253
OP-5	279	P-120	168	PH-76	155	PS-2	346	SM-4	253
OP-7	216	P-121	168	PH-77	155	PT-1	342	SM-5	253
OP-8	216	P-129	174	PH-79	152	PT-2	342	SM-6	253
OR-11	218	P-135	169	PH-80	151	PT-3	342	SM-11	251
OR-12	218	P-136	171	PH-81	151	PT-4	342	SM-12	251
OR-13	218	P-137	171	PH-82	151	PT-5	342	SM-13	251
OR-14	218	P-215	171	PH-83	151	PZ-1	254	SM-15	251
OR-18	218	P-216	171	PH-84	151	PZ-2	254	SM-19	251
OR-19	218	P-217	171	PH-85	152	PZ-3	254	SM-20	252
OR-40	218	P-230	173	PH-90	156	PZ-4	254	SM-21	251
OR-45	218	P-231	173	PH-99	156	R-1	275	SM-22	252
OS-1	280	P-232	173	PH-100	156	R-2	275	SO-1	249
OS-2	280	P-233	173	PH-101	154	R-3	275	SO-2	249
OSB-1	286	P-238	173	PH-102	154	RH-4	257	SO-3	249
OSB-2	286	P-239	173	PH-103	154	RH-4A	257	SO-4	249
OSB-4	285	P-240	173	PH-106	152	RH-5	257	SO-5	249
OSB-4A	285	P-241	173	PH-110	154	RH-5A	257	SO-6	249
OT-1	271	P-250	171	PH-111	154	RH-14	257	SO-7	250
OT-2	271	P-251	171	PH-120	154	RO-1	39	SO-8	250
OT-3	271	P-252	171	PH-121	154	S18-8	340	SO-9	250
OT-4	271	P-253	171	PH-122	154	S-0	274	SO-10	250
OT-5	271	P-256	171	PH-127	154	S-00	274	SO-11	250
OT-6	271	P-257	171	PH-128	154	S-1	274	SO-12	250
OT-7	271	P-260	171	PH-129	154	S-2	274	SO-20	252
OT-8	271	P-261	171	PH-132	155	S-3	274	SP-1	255
OT-9	271	P-264	168	PH-133	155	S-3AN	13	SP-2	255
OT-10	271	P-265	168	PH-134	155	S-4	274	SP-3	255
OT-11	272	P-266	168	PH-140	148	S-7	13	SP-4	255
OT-12	272	P-267	168	PH-141	148	S-31	14	SP-5	255
OT-13	272	P-324	174	PH-142	148	S-34	13	SP-6	255
OT-14	272	P-332	168	PL-1	254	S-35	13	SP-7	255
OT-15	272	P-340	219	PL-2	254	S-49	17	SR	274
OT-16	272	P-341	219	PL-3	254	S-51B	16	SS-15	270
OX-1	280	P-342	219	PL-4	254	S-51LX	17	SS-16	270
OX-2	280	PEB-1	37	PM-1	282	S-66L	14	SS-20	216
OX-3	280	PEB-2	37	PM-2	282	S-66R	14	SS-21	216
OZ-1	278	PEB-3	37	PM-3	282	S-67L	15	SS-22	216
OZ-2	278	PEB-4	37	PM-4	282	S-67N	15	SS-41	270
OZ-3	278	PEB-5	37	PM-5	282	S-67R	15	SS-42	270
P-0	258	PEB-6	37	PM-6	282	S-80	16	SS-50	269
P-00	258	PEB-7	37	PO-37	159	S-97	16	SS-51	269
P-000	258	PEB-17S	36	PO-38	159	S-97B	16	SS-52	269
P-01	258	PEB-23S	36	PO-40	160	S-351S	17	SS-54	269
P-02	258	PEB-150S	36	PO-45	161	SA-1	340	SS-55	269
P-03	258	PEB-151S	36	PO-46	160	SA-2	340	SS-56	269
P-3	257	PF-1	328	PO-47	160	SA-3	340	SS-58	269
P-04	258	PF-2	328	PO-48	160	SC-1	108	SS-60M	215
P-4	257	PF-3	328	PO-50	158	SC-2	108	SS-61M	215
P-05	258	PF-6	214, 256	PO-51	158	SC-5	108	SS-62M	215
P-5	257	PF-9	268	PO-52	158	SC-9	108	SS-64M	215
P-06	258	PF-40	256	PO-55	158	SC-13	108	SS-65	214, 270
P-15	169	PF-41	256	PO-56	158	SC-14	108	STF-1	260
P-49	172	PH-37	149	PO-59	150	SC-15	108	STF-1R	260
P-50	174	PH-38	149	PO-60	161	SC-16	108	TASO-1	230
P-52	174	PH-39	149	PO-61	161	SD-1	260	TASO-2	230
P-61	173	PH-40	159	PO-65	160	SD-2	260	TASO-3	230
P-62	173	PH-41	159	PO-68	161	SD-3	260	TASO-4	230
P-63	173	PH-42	159	PO-69	161	SD-3R	260	TASO-5	230
P-64	173	PH-48	149	PO-71	161	SD-7	259	TASO-6	230
P-79	172	PH-53	153	PO-76	161	SD-7R	259	TASO-7	230
P-81	172	PH-54	156	PO-77	161	SD-8	259	TASO-8	230
P-82	172	PH-58	155, 325	PO-78	160	SD-8M	259	TASO-9	130
P-84	172	PH-59	155	PO-79	160	SD-8NA	259	TG-10	199
P-85	172	PH-60	336	PO-80	160	SD-20	259	TG-11	199
P-86	172	PH-61	149	PO-81	160	SD-M	72	TG-12	199
P-87	172	PH-62	149	PO-82	158	SE-2	58	TG-15	200
P-89	172	PH-63	149	PO-84	158	SE-4L	58	TG-17A	352
P-91	170	PH-64	149	PO-85	158	SE-4R	58	TG-17B	352
P-92	170	PH-65	153	PO-86	158	SIL-01	351	TG-17C	352
P-93	170	PH-66	153	PO-87	158	SIL-02	351	TG-17G	352
P-94	170	PH-67	153	PO-88	158	SIL-03	351	TG-17R	352
P-95	170	PH-68	153	PO-94	158	SIL-04	351	TG-17V	352
P-96	170, 329	PH-69	153	PO-99	157	SIL-05	351	TG-17Y	352
P-97	170, 329	PH-70	159	PO-99L	157	SL-1	231	TG-20	199
P-98	170	PH-71	156	PO-104	157	SL-2	231	TG-21	199



TG-22	199	USS-15/33	265
TG-23	199	USS-204S	265
TG-30	200	USS-H6/7	265
TG-31	200	USS-J14/15	265
TG-32	200	USS-KRA1	264
T-I	354	USS-KRA3	264
T-IF	354	USS-MC11/12	264
TP-8A	353	USS-MC13/14	264
TP-8B	353	USS-MC13/14S	264
TP-8C	353	USS-MC17/18S	264
TP-8G	353	USS-NV0	265
TP-8R	353	USS-NV11/12	265
TP-8V	353	USS-NV13/14	265
TP-8Y	353	USS-T2/3	265
TS-1	283	USS-YG7/8	206
TS-2	283	UST-1/2MS	206
TS-3	283	UST-1/2ML	206
TS-4	283	UST-KPA	206
TS-40	317	UST-MP	206
TS-50	317	UST-MPA	206
TS-101	350	VS-20	350
TS-102	350	VS-26	350
TS-103	350	VS-30	350
TS-104	350	WEST	223
TT-01	118	WG-10	223
T-USG-1/2	266	WG-12	223
T-USG-5/6	266	WG-14	223
T-USG-7/8	266	Z-1	346
T-USG-11/12	266	Z-2	346
T-USG-13/14	266	Z-3	346
T-USS-YG7/8	266		
T-USS-B5/6	266		
USB-P2	216		
USB-P3	216		
USB-P4	216		
USB-P1	216		
USB-P3Z	216		
USB-P1Z	216		
USB-P2Z	216		
USB-P4Z	216		
USC-2	276		
USC-2RL	264		
USC-4RL	264		
USC-13/14	264		
USG-1/2	263		
USG-1/2ET	262		
USG-1/2L	264		
USG-1/2S	263		
USG-3/4	263		
USG-3/4ET	262		
USG-3/4L	264		
USG-3/4S	263		
USG-5/6	263		
USG-5/6ET	262		
USG-5/6L	264		
USG-5/6S	263		
USG-7/8	263		
USG-7/8ET	262		
USG-7/8L	264		
USG-7/8S	263		
USG-9/10	263		
USG-9/10ET	262		
USG-9/10L	264		
USG-9/10S	263		
USG-11/12	263		
USG-11/12ET	262		
USG-11/12L	264		
USG-11/12S	263		
USG-13/14	263		
USG-13/14ET	262		
USG-13/14L	264		
USG-13/14S	263		
USG-15/16	264		
USG-15/16ET	262		
USG-17/18S	264		
USG-KN1/26	264		
USS-5/6LAN	264		
USS-5/33	265		
USS-15/30	265		

